



**YUASA  
BATTERY**



**BATTERY APPLICATIONS  
AND SPECIFICATIONS**  
Powersports Batteries

**2017**

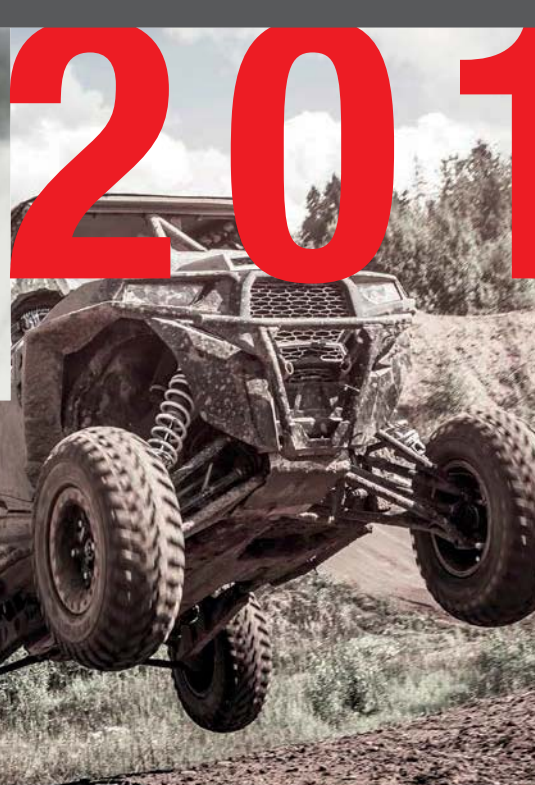

MANUFACTURED IN THE **USA** SINCE 1979

# ABOUT YUASA BATTERY



## ADVANCED ENGINEERING, PREMIUM QUALITY, UNMATCHED RELIABILITY

Yuasa Battery, Inc. has been manufacturing powersports batteries in the United States to uncompromisingly high standards since 1979. Yuasa Battery pioneered the AGM battery in 1985. We are the largest American manufacturer and distributor of batteries for motorcycles, snowmobiles, scooters, all terrain vehicles, side by sides and personal watercraft.

In addition to our vast replacement business, we are the leading original equipment supplier to most powersport vehicle manufacturers. By producing batteries that generate more power, last longer, and require minimum maintenance, Yuasa Battery, Inc. has achieved a leadership position in small engine starting batteries. Continuous research and development, along with unwavering standards of manufacturing quality, will help maintain our position as market leader around the world.

“Our products and services are reflections of who we are.

Each and every day, it starts with us...



Distribution Facility | Laureldale, PA, USA

## General

Battery Types .....	2-3
Cutaway Diagrams .....	4

## Battery Information

Features and Benefits.....	5
Terminal Types.....	6
Hardware .....	7

## Specifications

AGM Battery Specifications.....	8-9
Conventional Battery Specifications .....	10-13
Designation of Battery Type Numbers.....	13
Japanese Tractor Battery Specifications .....	14
Battery Upgrade Cross Reference .....	14

## Applications

Motorcycle.....	15-24
Utility Vehicle (UTV).....	25
Scooter .....	25-26
All Terrain Vehicle (ATV).....	27-29
Personal Watercraft (PWC).....	29
Snowmobile.....	30-31

## Chargers and Accessories

Consumer Products .....	32
Professional Shop Products .....	33
Merchandising Products .....	34

### DISCLAIMER

The replacement battery information published in this book has been obtained from the equipment manufacturers listed, except as otherwise noted. Users are cautioned that the information contained in this book was the most current information provided to us at the time of publication. The information is subject to change upon notice from equipment manufacturers or field experience. Users should always use the most current edition of the Yuasa Battery Applications and Specifications. Yuasa expressly denies any responsibility for the accuracy of the information provided to us. While we have made every effort to accurately catalog the replacement battery information contained in this book, Yuasa denies any liability for damages as a consequence of using the information in this book. Users should also attempt to obtain replacement battery information from the equipment manufacturer's user manual or service department for their specific application.

# BATTERY TYPES



## GYZ Series AGM

- AGM separators with superior grid designs for extreme vibration resistance
- More active material surface area for enhanced performance and power
- Supplied “Factory Activated” (nonspillable)
- Highest CCA motorcycle battery (500 CCA on GYZ32HL)
- Large heavy-duty flush terminals with multiple connections (GYZ32HL, GYZ20HL, GYZ20H)
- Built in brass nuts (GYZ32HL, GYZ20H, GYZ20HL)

## High Performance AGM

- All the features of a standard AGM battery plus increased power
- H Series: Increased power-up to 30% more cranking amps
- YTZ Series: Small size, lightweight, huge power



## AGM (Maintenance Free)

- Maintenance Free – no need to add water, but periodic charging required when not in use
- Absorbed Glass Mat (AGM) Separators – an advanced battery technology that eliminates the need to ever add water
- Advanced lead-calcium technology – holds its specific gravity more than 3 times longer than conventional lead antimony batteries

## Yumicron / Conventional

- Special thin separators – allow two extra plates per cell to be installed, for a 30% improvement in cranking performance
- Engineered to protect against corrosion, withstand vibration, and deliver high cranking power
- 6 volt and 12 volt varieties available

## GYZ CUTAWAY DIAGRAM

**EZ Grip Cover:**

simple installation  
(GYZ32HL)

**Large heavy-duty flush terminals:**

constructed to allow front and top connections and fit requirements on newer popular bikes

**Built-in brass nuts:**

up to 50% better conductivity than stainless steel  
(GYZ32HL, GYZ20H, GYZ20HL)

**Enhanced active material:**

compounded to withstand vibration, prolong battery life and dependability

**Absorbed Glass Mat (AGM) separators:**

absorb electrolyte, making the battery nonspillable

**Protective separator material:**

enhances vibration resistance

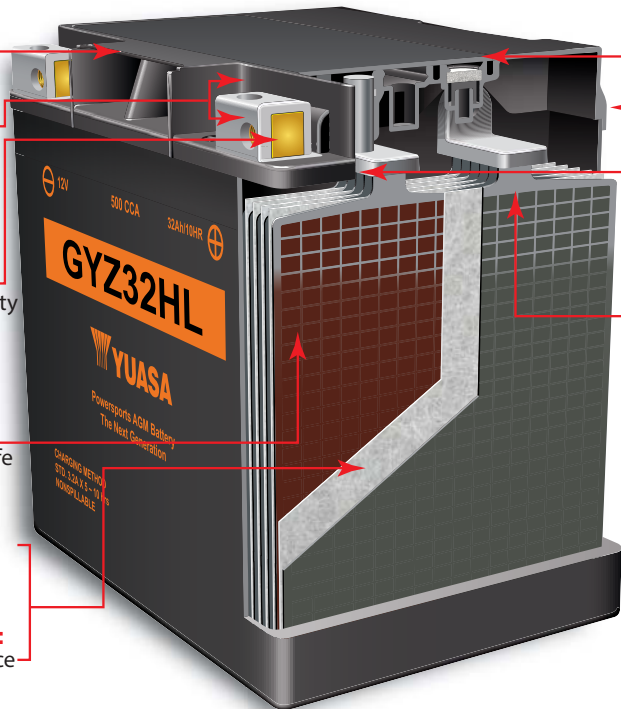

**Safety flame-arrester:**

leak proof valve relieves excess pressure

**Heat bonded cover:**

eliminates leaks and corrosion

**Thru-partition construction:**

provides shorter current path with less resistance than "over the partition" construction, resulting in more cranking power

**Taller plates:**

extra surface area for more power: up to 500 CCA and 32 Ah to power more accessories

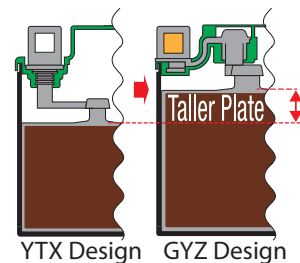

GYZ	Capacity (Ah)	CCA*	V-Twin	Metric	ATV	Upgrade for
All GYZ exceed OE CCA and Amp hour requirements						
GYZ16H	16	240	●	●	●	YTX14
GYZ16HL	16	240	●			YTX14L
GYZ20L	20	250		●	●	YTX20L
GYZ20H	20	320	●		●	YTX20H
GYZ20HL	20	320	●		●	YTX20HL
GYZ32HL	32	500	●		●	YIX30L

\*CCA measured by BCI/SAE standard at 0° F

## AGM CUTAWAY DIAGRAM

**Patented sealed post:**

Prevents acid seepage, reduces corrosion, extends battery life.

**Heat sealed case to cover:**

Bonded unit provides greater strength; protects against seepage and corrosion.

**Polypropylene cover and container:**

Ensures reserve electrolyte capacity for cooler operating temperatures; provides greater resistance to gas and oil; withstands higher impact in extreme weather conditions.

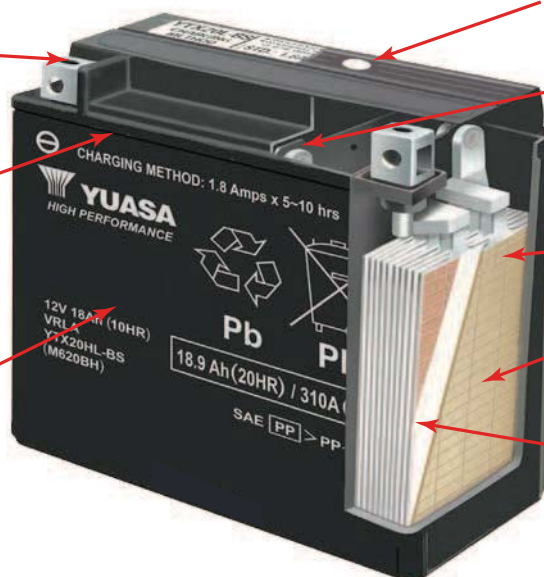

**Safety valve/flame arrester:**

Relieves excess pressure.

**Thru-partition construction:**

Provides shorter current path with less resistance than "over the partition" construction to get more cranking power when you need it.

**Special active material:**

Compounded to withstand vibration, prolong battery life and dependability.

**Special grid design:**

Withstands severe vibration, ensures maximum conductivity.









**Special separator:**

Makes the battery spill-proof. Valve regulated design eliminates water loss and the need to refill with acid.

Component	Features	Benefits
<b>Cast grid</b>	Special grid design	Severe vibration resistance and improved conductivity
<b>Active material</b>	Proprietary formulation	Reduced shedding, maximum utilization and long service life
<b>Pasted plates</b>	Specified thickness and weight	Ensures vibration resistance through precise compression and proper service life through specified active material balance
<b>Dried-charged plates</b>	Tank formed & dried plates	Properly dried plates in a sealed battery have a virtually limitless shelf-life
<b>Top lead connections</b>	Through-partition construction, large straps	Shorter current path for increased electrical conductivity and higher starting currents, heavier parts for maximum durability
<b>Case-cover seal</b>	Thermal bonded plastic	Air tight seal to prevent air ingress and acid seepage
<b>Terminal-cover seal</b>	Patented poly-seal terminal	Eliminates acid seepage, reduces corrosion and extends battery life
<b>Case and cover</b>	Polypropylene	Superior resistance to gasoline and oil, impact resistant in extreme weather conditions
<b>Additive</b>	Sulfate stop (some models)	Sulfate stop added to reduce the solubility of lead into the acid, which then reduces battery sulfation potential
<b>Yumicron</b>		
<b>Separator</b>	Leaf or envelope separator	Polyethylene with glass mat sheet bonded for compression to withstand severe vibration conditions
<b>GYZ/YTX/HIGH PERFORMANCE AGM</b>		
<b>Separator</b>	AGM (absorbed glass mat)	High puncture resistant separator for increased service in high vibration applications
<b>Top lead alloy</b>	Calcium alloy	Increased weld strength and severe vibration resistance
<b>Vent system</b>	Valve and flame arrestor	Valve relieves excess pressure to prevent bursting, flame arrestor prevents internal combustion

# TERMINAL TYPES

Terminal shapes vary from one battery to another. By identifying the correct replacement battery from the listing in this book, you are assured of the proper terminal configuration. For custom applications, refer to the following chart to identify terminal shape and corresponding batteries.

Terminal					Battery Type				
Type	Illustration	Front	Side	Top					
<b>1</b>					YB7C-A YB14L-A1	YTX16-BS-1			
<b>2</b>					YB9L-A2 12N5.5-4A YB16AL-A2				
<b>3</b>					12N24-3 Y60-N24-A	12N24-3A			
<b>4</b>					GYZ20L YB30L-B YTX15L-BS YTX20L-BS	Y50-N18L-A3 YIX30L-BS YTX16-BS YTX24HL-BS	YB12C-A YIX30L-BS-PW YTX20-BS YTX20HL-BS	YB16B-A YTX14AHL-B YTX20H-BS YIX20HL-BS	YB30CL-B YTX14AH-BS YTX20HL-BS-PW
<b>5</b>					GYZ16H GYZ16HL YB4L-B YTX14L-BS	YTX7L-BS KMX14-BS YT12A-BS YTX20CH-BS	YTX9-BS YB16C-B YTX12-BS YTX4L-BS	YTZ5S YTZ7S YB16CL-B YTX14-BS	YTX5L-BS YB4L-A YTX14H-BS YTX7A-BS
<b>6</b>					YB3L-A YB7L-B YB12A-A YB16-B 12N5-3B 12N7-4A 12N9-4B-1 6N6-3B B54-6	YB3L-B YB9A-A YB12AL-A YB-16-B-CX 12N5-4B 12N7-4B 12N10-3A 6N6-3B-1 B38-6A	YB5L-B YB9-B YB12AL-A2* YB16L-B 12N5.5-3B 12N7D-3B 6N11A-1B	YB7-A YB9L-B YB12A-B YB16HL-A-CX 12N5.5A-3B 12N12A-4A-1 6N11-2D	YB7B-B YB10L-B YB14A-A1 SYB16L-B 12N7-3B 12N9-3B 6N12A-2D B39-6
<b>7</b>					HYB16A-AB Y50-N18A-A	YB16B-A1** Y50-N18L-A	YB18-A Y50-N18L-A-CX	YB18L-A SY50-N18L-AT	
<b>8</b>					YB10A-A2 YB14-A2 YB14-B2 12N14-3A	YB10L-A2 YB14A-A2 YB14L-B2	YB10L-B2 YB14L-A2	YB12B-B2 SYB14L-A2 12N11-3A-1	
<b>9</b>					YHD-12H				
<b>10</b>					51814	51913	53030	YT19BL-BS	
<b>11</b>					YT9B-BS YT7B-BS	YTZ10S	YTZ12S YT12B-BS	YTZ14S	YT14B-BS
					Note: Terminal is Brass Plated Steel				
<b>12</b>					YTR4A-BS				
<b>13</b>					YT4B-BS				
<b>14</b>					GYZ20H GYZ20HL	GYZ32HL			
					Note: Encapsulated Brass Nut				

\* Includes terminal adapter for converting to top mount

\*\* Includes terminal adapter for converting to side mount



Part No.	Includes**	Fits			
<b>478030*</b>	12mm lg. stainless steel hex bolt 20mm lg. stainless steel hex bolt 6mm stainless steel nut, washer and round brass spacer	YTX15L-BS YB30L-B	YTX20-BS YB30CL-B	YTX20L-BS	
<b>479100</b>	12mm lg. stainless steel hex bolt 6mm stainless steel rectangular nut	Y50-N18L-A3 YTX14H-BS	YTX9-BS YTX14AH-BS	YTX12-BS YTX14AHL-BS	YTX14-BS GYZ16H
<b>479101/479862</b>	12mm lg. stainless steel hex bolt 6mm stainless steel rectangular nut	YTX15L-BS YTX24HL-BS YB30L-B	YTX20(H)-BS YIX20HL-BS YB30CL-B	YTX20(H)L-BS-PW YIX30L-BS-PW GYZ20L	
<b>479102</b>	14mm lg. stainless steel hex bolt 6mm stainless steel square nut	YB16CL-B	YB16C-B		
<b>479104*</b>	12mm lg. stainless steel hex bolt 20mm lg. stainless steel hex bolt 6mm stainless steel nut, washer and round brass spacer	YTX14L-BS for Harley Davidson Sportster YTX14 <sup>FA</sup> for Harley Davidson V-ROD 02-07 YTX14H <sup>FA</sup> for Harley Davidson V-ROD 02-07			
<b>479643*</b>	12mm lg. stainless steel hex bolt 20mm lg. stainless steel hex bolt 6mm stainless steel nut, washer and square brass spacer	YTX20H-BS YIX30L-BS	YTX20HL-BS	YTX24HL-BS	
<b>479876</b>	12mm lg. stainless steel hex bolt 16mm lg. stainless steel hex bolt 6mm stainless steel rectangular nut 6mm star washer and square brass spacer	GYZ16HL			
<b>479699</b>	12mm lg. stainless steel hex bolt 6mm star washer	GYZ20H	GYZ20HL	GYZ32HL	
<b>5BNBSSF6M</b>	11mm lg. stainless steel hex bolt 6mm stainless steel hex nut	12N7-3B 12N12A-4A-1 YB7B-B YB9L-B YB10L-B YB12A-B	YB14A-A1 YB14L-B2 12N7-4A 12N14-3A YB9-B YB10A-A2	YB10L-B2 YB12AL-A YB14A-A2 YB14L-A2 12N7-4B 12N9-4B-1 YB7-A	YB9A-A YB10L-A2 YB12A-A YB14-A2 YB14-B2 YB16AL-A2
<b>5BNBSS14M</b>	14mm lg. stainless steel hex bolt 6mm stainless steel hex nut	YB14L-A1 YB18L-A	HYB16A-AB YHD-12H	YB16L-B Y50-N18L-A	YB18-A SY50-N18L-A
<b>5BNBSS22M</b>	22mm lg. stainless steel hex bolt 6mm stainless steel hex nut and round brass spacer	YB16-B	YB16-B-CX	YB16HL-A-CX	YB16L-B

\* Use of thread locking agent recommended

\*\* All hardware listed above is M6 thread

FA Must use factory activated battery

# BATTERY SPECIFICATIONS

AGM, High Performance

## FACTORY ACTIVATED (Non-Spillable)

**12 VOLT**

Battery Type	Capacity Ah (10H-R)	Dimensions – Inches (± 1/16 in)			Dimensions – Millimeters (± 2 mm)			Assembly Figure (As Per Cover Polarity)	Approx Weight with Acid (lbs.)	Terminal Type (Refer to page 6)	Acid Volume (Liter)	Regular Charge Current (Amp)	C.C.A. @ 0 °F (-18 °C)
		L	W	H	L	W	H						
GYZ16H	16	6	3 7/16	5 3/4	150	87	145	⊕         ⊖	12.4	5	N/A	1.6	240
GYZ16HL	16	6	3 7/16	5 3/4	150	87	145	⊖         ⊕	12.4	5	N/A	1.6	240
GYZ20L	20	6 7/8	3 7/16	6 1/8	175	87	155	⊖         ⊕	15.2	4	N/A	2.0	250
GYZ20H	20	6 7/8	3 7/16	6 1/8	175	87	155	⊕         ⊖	15.7	14	N/A	2.0	320
GYZ20HL	20	6 7/8	3 7/16	6 1/8	175	87	155	⊖         ⊕	15.7	14	N/A	2.0	320
GYZ32HL	32	6 9/16	5	6 7/8	166	126	175	⊖         ⊕	24.7	14	N/A	3.2	500
YTX14AH*	12	5 5/16	3 1/2	6 9/16	134	89	166	⊕         ⊖	11.1	4	N/A	1.2	210
YTX14AHL	12	5 5/16	3 1/2	6 9/16	134	89	166	⊖         ⊕	11.1	4	N/A	1.2	210
YTX14H	12	6	3 7/16	5 3/4	150	87	145	⊕         ⊖	10.6	5	N/A	1.2	240
YTX20CH	18	6	3 7/16	6 3/8	150	87	161	⊕         ⊖	13.4	5	N/A	1.8	270
YTX20H	18	6 7/8	3 7/16	6 1/8	175	87	155	⊕         ⊖	15.1	4	N/A	1.8	310
YTX20HL	18	6 7/8	3 7/16	6 1/8	175	87	155	⊖         ⊕	15.1	4	N/A	1.8	310
YIX20HL	18	6 7/8	3 7/16	6 1/8	175	87	155	⊖         ⊕	15.1	4	N/A	1.8	320
YTX20HL-PW**	18	6 7/8	3 7/16	6 7/8 <sup>§</sup>	175	87	175 <sup>§</sup>	⊖         ⊕	15.1	4	N/A	1.8	310
YTX24HL	21	8 1/8	3 7/16	6 3/8	205	87	162	⊖         ⊕	17.5	4	N/A	2.1	350
YTZ7S	6	4 7/16	2 3/4	4 1/8	113	70	105	⊖         ⊕	4.6	5	N/A	0.6	130
YTZ8V	7	4 7/16	2 3/4	5 1/8	113	70	130	⊖         ⊕	6.0	5	N/A	0.7	120
YTZ10S	8.6	6	3 7/16	3 11/16	150	87	93	⊕         ⊖	7.0	11	N/A	0.9	190
YTZ12S	11	6	3 7/16	4 3/8	150	87	110	⊕         ⊖	8.1	11	N/A	1.1	210
YTZ14S	11.2	6	3 7/16	4 3/8	150	87	110	⊕         ⊖	8.6	11	N/A	1.1	230

## FRESH PACK (Battery Supplied Dry with an Acid Bottle)

**12 VOLT**

Battery Type	Capacity Ah (10H-R)	Dimensions – Inches (± 1/16 in)			Dimensions – Millimeters (± 2 mm)			Assembly Figure (As Per Cover Polarity)	Approx Weight with Acid (lbs.)	Terminal Type (Refer to page 6)	Acid Volume (Liter)	Regular Charge Current (Amp)	C.C.A. @ 0 °F (-18 °C)
		L	W	H	L	W	H						
YTZ5S+	3.5	4 7/16	2 3/4	3 3/8	113	70	86	⊖         ⊕	3.5	5	0.20	0.4	65
YTX14AH-BS*	12	5 5/16	3 1/2	6 9/16	134	89	166	⊕         ⊖	11.1	4	0.66	1.2	210
YTX14AHL-BS	12	5 5/16	3 1/2	6 9/16	134	89	166	⊖         ⊕	11.1	4	0.66	1.2	210
YTX14H-BS	12	6	3 7/16	5 3/4	150	87	145	⊕         ⊖	10.6	5	0.69	1.2	240
YTX20CH-BS	18	6	3 7/16	6 3/8	150	87	161	⊕         ⊖	13.4	5	0.82	1.8	270
YTX20H-BS	18	6 7/8	3 7/16	6 1/8	175	87	155	⊕         ⊖	15.1	4	0.93	1.8	310
YTX20HL-BS	18	6 7/8	3 7/16	6 1/8	175	87	155	⊖         ⊕	15.1	4	0.93	1.8	310
YTX20HL-BS-PW**	18	6 7/8	3 7/16	6 7/8 <sup>§</sup>	175	87	175 <sup>§</sup>	⊖         ⊕	15.1	4	0.93	1.8	310
YIX20HL-BS	18	6 7/8	3 7/16	6 7/8 <sup>§</sup>	175	87	175 <sup>§</sup>	⊖         ⊕	15.1	4	0.93	1.8	320
YTX24HL-BS	21	8 1/8	3 7/16	6 3/8	205	87	162	⊖         ⊕	17.5	4	1.08	2.1	350

\* Includes 10mm height spacer for use in replacing YB14A-A1 and YB14A-A2  
 \*\* Includes 20mm height spacer (®) for use in replacing YB16CL-B  
 † Original battery was factory activated

## FACTORY ACTIVATED (Non-Spillable)

## 12 VOLT

Battery Type	Capacity Ah (10H-R)	Dimensions – Inches (± 1/16 in)			Dimensions – Millimeters (± 2 mm)			Assembly Figure (As Per Cover Polarity)	Approx Weight with Acid (lbs.)	Terminal Type (Refer to page 6)	Acid Volume (Liter)	Regular Charge Current (Amp)	C.C.A. @ 0 °F (-18 °C)
		L	W	H	L	W	H						
YTX9	8	6	3 7/16	4 3/16	150	87	105		6.6	5	N/A	0.9	135
YTX12	10	6	3 7/16	5 1/8	150	87	130		9.2	5	N/A	1.2	180
YT12B	10	6	3 7/16	5 1/8	150	69	130		9.2	5	N/A	1.2	210
YTX14	12	6	3 7/16	5 3/4	150	87	145		10.1	5	N/A	1.4	200
YTX14L	12	6	3 7/16	5 3/4	150	87	145		10.1	5	N/A	1.4	200
YTX15L	13	6 7/8	3 7/16	5 1/8	175	87	130		11.0	4	N/A	1.3	230
YTX20	18	6 7/8	3 7/16	6 1/8	175	87	155		13.9	4	N/A	1.8	270
YTX20L	18	6 7/8	3 7/16	6 1/8	175	87	155		13.9	4	N/A	1.8	270
YIX30L	30	6 9/16	5	6 7/8	166	126	175		22.0	4	N/A	3	400
YIX30L-PW**	30	6 9/16	5	7 9/16 <sup>s</sup>	166	126	192 <sup>s</sup>		22.0	4	N/A	3.0	410

## FRESH PACK (Battery Supplied Dry with an Acid Bottle)

## 12 VOLT

Battery Type	Capacity Ah (10H-R)	Dimensions – Inches (± 1/16 in)			Dimensions – Millimeters (± 2 mm)			Assembly Figure (As Per Cover Polarity)	Approx Weight with Acid (lbs.)	Terminal Type (Refer to page 6)	Acid Volume (Liter)	Regular Charge Current (Amp)	C.C.A. @ 0 °F (-18 °C)
		L	W	H	L	W	H						
YTR4A-BS	2.3	4 1/2	1 15/16	3 3/8	114	49	86		2.4	12	0.14	0.3	45
YT4B-BS	2.3	4 1/2	1 9/16	3 7/16	114	39	86.5		2.4	13	0.12	0.3	40
YTX4L-BS	3	4 1/2	2 13/16	3 3/8	114	71	86		3.4	5	0.18	0.4	50
YTX5L-BS	4	4 1/2	2 13/16	4 3/16	114	71	106		4.2	5	0.24	0.5	80
YT7B-BS	6.5	6	2 9/16	3 11/16	150	65	93		5.9	11	0.33	0.7	120
YTX7A-BS	6	6	3 7/16	3 3/4	150	87	94		6.3	5	0.33	0.7	105
YTX7L-BS	6	4 1/2	2 13/16	5 3/16	114	71	131		6.1	5	0.33	0.6	100
YT9B-BS	8	6	2 3/4	4 1/8	150	70	105		8.7	11	0.40	0.8	115
YTX9-BS	8	6	3 7/16	4 3/16	150	87	105		6.6	5	0.40	0.9	135
YT12A-BS	10	6	3 7/16	4 3/16	150	87	105		7.7	5	0.47	1.0	175
YT12B-BS	10	6	2 3/4	5 1/8	150	69	130		9.0	11	0.52	1.0	210
YTX12-BS	10	6	3 7/16	5 1/8	150	87	130		9.2	5	0.60	1.2	180
KMX14-BS*	12	6	3 7/16	5 3/4	150	87	145		10.1	5	0.69	1.4	200
YT14B-BS	12	6 1/8	2 3/4	5 3/4	150	70	145		11.8	11	0.60	1.2	210
YTX14-BS	12	6	3 7/16	5 3/4	150	87	145		10.1	5	0.69	1.4	200
YTX14L-BS	12	6	3 7/16	5 3/4	150	87	145		10.1	5	0.69	1.4	200
YTX15L-BS	13	6 7/8	3 7/16	5 1/8	175	87	130		11.0	4	0.69	1.3	230
YTX16-BS	14	6	3 7/16	6 3/8	150	87	161		12.6	4	0.78	1.4	230
YTX16-BS-1	14	6	3 7/16	6 3/8	150	87	161		12.6	1	0.78	1.4	230
YT19BL-BS	17.7	7 1/4	3 3/16	6 11/16	184	81	170		12.5	10	0.95	1.8	170
YTX20-BS	18	6 7/8	3 7/16	6 1/8	175	87	155		13.9	4	0.93	1.8	270
YTX20L-BS	18	6 7/8	3 7/16	6 1/8	175	87	155		13.9	4	0.93	1.8	270
YIX30L-BS	30	6 9/16	5	6 7/8	166	126	175		22.0	4	1.40	3.0	400
YIX30L-BS-PW**	30	6 9/16	5	7 9/16 <sup>s</sup>	166	126	192 <sup>s</sup>		22.0	4	1.40	3.0	410

\* Available at Kawasaki dealers only

\*\* Includes 17mm height spacer (s) for replacing YB30CL-B

# BATTERY SPECIFICATIONS

## HIGH PERFORMANCE, CONVENTIONAL (Yumicron)

## 12 VOLT

Battery Type	Capacity Ah (10H-R)	Dimensions – Inches (± 1/16 in)			Dimensions – Millimeters (± 2 mm)			Assembly Figure (As Per Cover Polarity)	Approx Weight w/out Acid (lbs.)	Terminal Type (Refer to page 6)	Acid Volume (oz.)	Regular Charge Current (Amp)
		L	W	H	L	W	H					
YB2.5L-C	2.5	3 3/16	2 3/4	4 1/8	80	70	105		1.7	-	8.1	0.3
YB2.5L-C-1	2.5	3 3/16	2 3/4	4 1/8	80	70	105		1.7	-	8.1	0.3
YB3L-A	3	3 7/8	2 1/4	4 3/8	98	56	110		2.5	6	8.1	0.3
YB3L-B	3	3 7/8	2 1/4	4 3/8	98	56	110		2.5	6	8.1	0.3
YB4L-A	4	4 3/4	2 3/4	3 5/8	120	70	92		2.8	5	10.1	0.4
YB4L-B	4	4 3/4	2 3/4	3 5/8	120	70	92		2.8	5	10.1	0.4
YB5L-B	5	4 3/4	2 3/8	5 1/8	120	60	130		3.5	6	12.2	0.5
YB6L-B	6	5 1/2	2 7/8	3 17/18	138	72.5	100		3.5	6	12.2	0.5
YB7-A	8	5 5/16	3	5 1/4	135	75	133		5.1	6	20.3	0.8
YB7B-B	7	6	2 3/8	5 1/8	150	60	130		4.0	6	16.9	0.7
YB7C-A	8	5 1/8	3 9/16	4 1/2	130	90	114		5.1	1	20.3	0.8
YB7L-B	8	5 5/16	3	5 1/4	135	75	133		5.1	6	20.3	0.8
YB9A-A	9	5 5/16	3	6 1/8	135	75	155		5.3	6	20.3	0.9
YB9L-A2	9	5 5/16	3	5 1/2	135	75	139		5.3	2	20.3	0.9
YB9-B	9	5 5/16	3	5 1/2	135	75	139		5.3	6	20.3	0.9
YB9L-B	9	5 5/16	3	5 1/2	135	75	139		5.3	6	20.3	0.9
YB10A-A2	11	5 5/16	3 9/16	6 1/8	135	90	155		7.0	8	27.0	1.1
YB10L-A2	11	5 5/16	3 9/16	5 3/4	135	90	145		7.0	8	27.0	1.1
YB10L-B	11	5 5/16	3 9/16	5 3/4	135	90	145		7.0	6	27.0	1.1
YB10L-B2	11	5 5/16	3 9/16	5 3/4	135	90	145		7.0	8	27.0	1.1
YB12A-A	12	5 5/16	3 3/16	6 5/16	134	80	160		6.8	6	27.0	1.2
YB12A-A <sup>▲</sup>	12	5 5/16	3 3/16	6 5/16	134	80	160		6.8	6	27.0	1.2
YB12A-A <sup>**</sup>	12	5 5/16	3 3/16	6 5/16	134	80	160		6.8	6	27.0	1.2
YB12AL-A <sup>Ⓓ</sup>	12	5 5/16	3 3/16	6 5/16	134	80	160		6.8	6	25.4	1.2
YB12AL-A	12	5 5/16	3 3/16	6 5/16	134	80	160		6.8	6	25.4	1.2
YB12AL-A2 <sup>*</sup>	12	5 5/16	3 3/16	6 5/16	134	80	160		6.8	8	25.4	1.2
YB12A-B	12	5 5/16	3 3/16	6 5/16	134	80	160		6.8	6	25.4	1.2
YB12B-B2	12	6 5/16	3 9/16	5 1/8	160	90	130		7.1	8	27.0	1.2
YB12C-A	12	5 5/16	3 9/16	6 7/8	134	80	175		7.1	4	27.0	1.2
YB14-A2	14	5 5/16	3 1/2	6 9/16	134	89	166		7.6	8	30.4	1.4
YB14A-A1	14	5 5/16	3 1/2	6 15/16	134	89	176		7.9	6	30.4	1.4
YB14A-A2	14	5 5/16	3 1/2	6 15/16	134	89	176		7.9	8	30.4	1.4
YB14L-A1	14	5 5/16	3 1/2	6 9/16	134	89	166		7.6	1	30.4	1.4

\* Includes terminal adaptor for converting to top mount.  
 \*\* When ordering this battery, specify terminal adaptor.  
 ▲ When ordering this battery, specify sensor.

Ⓓ Discontinued, use YB12AL-A2.

## HIGH PERFORMANCE, CONVENTIONAL (Yumicron)

## 12 VOLT

Battery Type	Capacity Ah (10H-R)	Dimensions – Inches (± 1/16 in)			Dimensions – Millimeters (± 2 mm)			Assembly Figure (As Per Cover Polarity)	Approx Weight w/out Acid (lbs.)	Terminal Type (Refer to page 6)	Acid Volume (oz.)	Regular Charge Current (Amp)
		L	W	H	L	W	H					
YB14L-A2	14	5 5/16	3 1/2	6 9/16	134	89	166		7.6	8	30.4	1.4
YB14L-A2 <sup>D4</sup>	14	5 5/16	3 1/2	6 9/16	134	89	166		7.6	8	30.4	1.4
YB14L-B2	14	5 5/16	3 1/2	6 9/16	134	89	166		7.6	8	30.4	1.4
YB14-B2	14	5 5/16	3 1/2	6 9/16	134	89	166		7.6	8	30.4	1.4
SYB14L-A2 *	14	5 5/16	3 1/2	6 9/16	134	89	166		7.6	8	30.4	1.4
SYB14L-B2 <sup>D1</sup> *	14	5 5/16	3 1/2	6 9/16	134	89	166		7.6	8	30.4	1.4
YB16AL-A2	16	8 1/8	2 13/16	6 7/16	207	71.5	164		8.6	2	37.2	1.6
HYB16A-AB	16	6	3 5/8	7 1/16	151	91	180		8.5	7	30.4	1.6
YB16-B	19	6 7/8	4	6 1/8	175	100	155		10.5	6	40.6	1.9
YB16-B-CX	19	6 7/8	4	6 1/8	175	100	155		10.5	6	40.6	1.9
YB16HL-A-CX	19	6 7/8	4	6 1/8	175	100	155		10.5	6	40.6	1.9
YB16L-B	19	6 7/8	4	6 1/8	175	100	155		10.5	6	40.6	1.9
YB16B-A	16	6 5/16	3 9/16	6 3/8	160	90	161		8.4	4	33.8	1.6
YB16B-A1*	16	6 5/16	3 9/16	6 3/8	160	90	161		8.4	7	33.8	1.6
YB16C-B	19	6 7/8	4	6 7/8	175	100	175		10.1	5	40.6	1.9
YB16CL-B	19	6 7/8	4	6 7/8	175	100	175		10.1	5	40.6	1.9
SYB16L-B <sup>D2</sup> *	19	6 15/16	4	6 1/8	175	100	155		9.3	6	43.9	1.9
YB18-A	18	7 1/8	3 9/16	6 3/8	180	90	162		9.4	7	40.6	1.8
YB18L-A	18	7 1/8	3 9/16	6 3/8	180	90	162		9.4	7	40.6	1.8
Y50-N18A-A	20	8 1/8	3 9/16	6 15/16	205	90	176		11.2	7	50.7	2.0
Y50-N18L-A	20	8 1/8	3 9/16	6 3/8	205	90	162		11.2	7	44.0	2.0
Y50-N18L-A-CX	20	8 1/8	3 9/16	6 3/8	205	90	162		11.2	7	44.0	2.0
Y50-N18L-A3	20	8 1/8	3 9/16	6 3/8	205	90	162		11.2	4	44.0	2.0
SY50-N18L-AT *	20	8 1/8	3 9/16	6 3/8	205	90	162		11.2	7	44.0	2.0
Y60-N24-A <sup>D4</sup>	28	7 1/4	4 7/8	6 7/8	184	124	175		14.4	3	57.5	2.8
Y60-N24AL-B <sup>D3</sup>	28	7 1/4	4 7/8	6 7/8	184	124	175		14.4	3	57.5	2.8
YB30L-B	30	6 5/8	5 3/16	6 15/16	168	132	176		14.1	4	57.5	3.0
YB30CL-B	30	6 5/8	5 3/16	7 9/16	168	132	192.2		14.5	4	57.5	3.0
51814	19 <sup>***</sup>	7 7/16	3 1/4	6 7/8	186	82	171		9.4	10	33.8	1.9
51913	19 <sup>***</sup>	7 7/16	3 1/4	6 7/8	186	82	171		9.4	10	33.8	1.9
53030	30 <sup>***</sup>	7 7/16	5 1/8	6 7/8	186	130	171		16.1	10	54.1	3.0

<sup>D1</sup> Discontinued, use YB14L-B2.  
<sup>D2</sup> Discontinued, use YB16L-B.  
<sup>D3</sup> Discontinued, use 53030.  
<sup>D4</sup> Discontinued.

◆ This battery includes a sensor.  
\* Includes terminal adaptor for converting to side mount.  
\*\*\* DIN Standard @ 20 hr. rate.

# BATTERY SPECIFICATIONS

## CONVENTIONAL

## 6 VOLT

Battery Type	Capacity Ah (10H-R)	Dimensions – Inches (± 1/16 in)			Dimensions – Millimeters (± 2 mm)			Assembly Figure (As Per Cover Polarity)	Approx Weight w/out Acid (lbs.)	Terminal Type (Refer to page 6)	Acid Volume (oz.)	Regular Charge Current (Amp)
		L	W	H	L	W	H					
6N2-2A	2	2 3/4	1 7/8	3 3/4	70	47	96		1.0	-	3.4	0.2
6N2-2A-1 <sup>D4</sup>	2	2 3/4	1 7/8	3 3/4	70	47	96		1.0	-	3.4	0.2
6N2-2A-3	2	2 3/4	1 7/8	3 3/4	70	47	96		1.0	-	3.4	0.2
6N2-2A-4	2	2 3/4	1 7/8	3 3/4	70	47	96		1.0	-	3.4	0.2
6N2-2A-8	2	2 3/4	1 7/8	3 3/4	70	47	96		1.0	-	3.4	0.2
6N2A-2C	2	2 3/4	1 7/8	4 3/16	70	47	106		1.0	-	3.4	0.2
6N2A-2C-1 <sup>**</sup>	2	2 3/4	1 7/8	4 3/16	70	47	106		1.0	-	3.4	0.2
6N2A-2C-3	2	2 3/4	1 7/8	4 3/16	70	47	106		1.0	-	3.4	0.2
6N4-2A	4	2 13/16	2 13/16	3 3/4	71	71	96		1.3	-	6.8	0.4
6N4-2A-4	4	2 13/16	2 13/16	3 3/4	71	71	96		1.3	-	6.8	0.4
6N4-2A-5	4	2 13/16	2 13/16	3 3/4	71	71	96		1.3	-	6.8	0.4
6N4-2A-6	4	2 13/16	2 13/16	3 3/4	71	71	96		1.3	-	6.8	0.4
6N4-2A-8	4	2 13/16	2 13/16	3 3/4	71	71	96		1.3	-	6.8	0.4
6N4A-4D	4	2 3/8	2 1/4	5 1/8	61	57	131		1.7	-	6.8	0.4
6N4B-2A	4	4	1 7/8	3 3/4	102	48	96		1.7	-	6.8	0.4
6N4B-2A-3	4	4	1 7/8	3 3/4	102	48	96		1.7	-	6.8	0.4
6N4B-2A-5	4	4	1 7/8	3 3/4	102	48	96		1.7	-	6.8	0.4
6N4C-1B	4	2 13/16	2 13/16	4 1/8	71	71	105		1.4	-	6.8	0.4
6N5.5-1D	5.5	3 9/16	2 3/4	3 15/16	90	70	100		1.8	-	10.1	0.6
6N6-3B	6	3 7/8	2 1/4	4 3/8	99	57	111		2.0	6	10.1	0.6
6N6-3B-1	6	3 7/8	2 1/4	4 3/8	99	57	111		2.0	6	10.1	0.6
6N6-1D-2	6	3 7/8	2 1/4	4 3/8	99	57	111		2.0	-	10.1	0.6
6N11-2D	11	5 7/8	2 3/4	3 15/16	150	70	100		3.5	6	13.5	1.1
6N11A-1B	11	4 13/16	2 7/16	5 1/8	122	62	131		3.5	6	13.5	1.1
B54-6	12	6 1/8	2 1/4	4 9/16	156	57	116		3.8	6	16.9	1.2
6N12A-2D	12	6 1/8	2 1/4	4 9/16	156	57	116		3.8	6	15.2	1.2
B38-6A	13	4 11/16	3 1/4	6 15/16	119	83	161		4.7	6	21.0	1.3
6YB8L-B	8	4 3/4	2 3/4	3 3/4	120	70	95		3.0	6	10.5	0.8
6YB11-2D	11	5 7/8	2 3/4	3 15/16	150	70	100		4.4	6	13.5	1.1

<sup>\*\*</sup> 6N2A-2C-1 replaces B60-6  
<sup>D4</sup> Discontinued

CONVENTIONAL								12 VOLT				
Battery Type	Capacity Ah (10H-R)	Dimensions – Inches (± 1/16 in)			Dimensions – Millimeters (± 2 mm)			Assembly Figure (As Per Cover Polarity)	Approx Weight w/out Acid (lbs.)	Terminal Type (Refer to page 6)	Acid Volume (oz.)	Regular Charge Current (Amp)
		L	W	H	L	W	H					
12N5-3B	5	4 3/4	2 3/8	5 1/8	120	60	130		3.1	6	13.5	0.5
12N5-4B	5	4 3/4	2 3/8	5 1/8	120	60	130		3.1	6	13.5	0.5
12N5.5-3B	5.5	5 5/16	2 3/8	5 1/8	135	60	130		4.3	6	13.5	0.6
12N5.5-4A	5.5	5 5/16	2 3/8	5 1/8	135	60	130		4.3	2	13.5	0.6
12N5.5A-3B	5.5	4 1/16	3 9/16	4 1/2	103	90	114		4.3	6	16.9	0.6
12N7-3B	7	5 5/16	3	5 1/4	135	75	133		4.9	6	16.9	0.7
12N7-4A	7	5 5/16	3	5 1/4	135	75	133		4.9	6	16.9	0.7
12N7-4B	7	5 5/16	3	5 1/4	135	75	133		4.9	6	16.9	0.7
12N7D-3B	7	5 5/16	3	5 15/16	135	75	150		4.9	6	20.3	0.7
12N9-3A	9	5 5/16	3	5 1/2	135	75	139		5.4	9	20.3	0.9
12N9-3A-1 <sup>D5</sup>	9	5 5/16	3	5 1/2	135	75	139		5.4	6	20.3	0.9
12N9-3B	9	5 5/16	3	5 1/2	135	75	139		5.4	6	20.3	0.9
12N9-4B-1	9	5 5/16	3	5 1/2	135	75	139		5.4	6	20.3	0.9
12N10-3A-2 <sup>D6</sup>	10	5 5/16	3 9/16	5 3/4	135	90	145		5.8	8	27.0	1.0
12N12A-4A-1	12	5 5/16	3 3/16	6 5/16	134	80	160		6.8	6	23.7	1.2
12N14-3A	14	5 5/16	3 1/2	6 9/16	134	89	166		7.5	8	27.0	1.4
12N24-3A	24	7 1/4	4 7/8	6 7/8	184	124	175		12.1	3	40.6	2.4
12N24-3	24	7 1/4	4 7/8	6 7/8	184	124	175		12.1	3	40.6	2.4
YHD-12H	29	8 1/8	5 1/4	6 1/2	206	133	165		13.3	9	67.6	2.8

<sup>D5</sup> Discontinued, use YB9L-A2.  
<sup>D6</sup> Discontinued, use YB10L-A2.

## DESIGNATION OF BATTERY TYPE NUMBERS

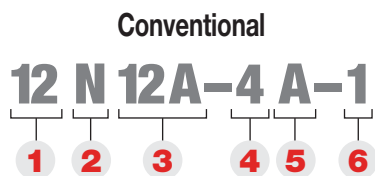

- 1 Nominal voltage
- 2 Conventional battery
- 3 Size of battery case
- 4 Polarity location
- 5 Exhaust location
- 6 Designates unique terminal

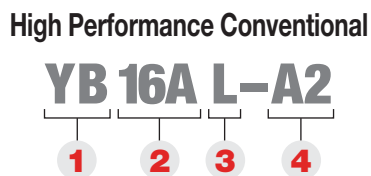

- 1 High Performance Conventional battery
- 2 Size of battery case
- 3 Polarity location
- 4 Terminal and Exhaust location

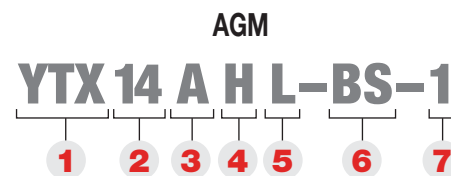

- 1 High Performance AGM (YTX, YIX, YTZ, YT, GYZ)
- 2 Performance classification
- 3 Designates unique battery case size
- 4 Higher CCA
- 5 Polarity location
- 6 Bottle supplied electrolyte
- 7 Designates unique terminal

# JAPANESE TRACTOR BATTERY SPECIFICATIONS

JIS Type	Reference Number	Plate / Cell	Capacity Ah ▲ (5 hr)	Capacity Ah ▲ (20 hr)	Cranking Performance ▲ (Amps 0 °F)	Reserve Capacity Minutes (80 °F)	Overall Dimensions (inches)			Shipping Weight Dry (lbs.)	Volume Of Acid (oz.)	Charging Current (Amp)	See Key	
							L	W	H				Terminal	Layout
*36B20L(S)	40B19L(S) NS40ZL(S)	9	28	35	275	52	7 3/4	5 1/16	8 15/16	17.9	84.6	3.5	A	2
46B24R	NS60	13	36	45	330	75	9 3/8	5 1/16	8 15/16	20.1	109.0	4.5	B	1
*46B24L(S)	NX60L(S)	13	36	45	330	75	9 3/8	5 1/16	8 15/16	20.1	109.5	4.5	A	2
36B20L	40B19L/NS40ZL	9	28	35	275	52	7 3/4	5 1/16	8 15/16	17.9	91.7	3.5	B	2
*55B24L(S)	NX100S6L(S)	13	36	45	410	70	9 3/8	5 1/16	8 15/16	21.3	109.3	4.5	A	2
95E41R	N100	17	80	100	475	200	16 3/8	6 15/16	9 3/8	38.1	233.1	10	A	1
115F51	N120	21	96	120	420	240	19 7/8	7 3/16	10 1/8	48.7	317.4	12.0	A	3
115F51L	N120L	21	96	120	420	240	19 7/8	7 3/16	10 1/8	48.7	317.4	12.0	A	4
145F51	NS150	25	120	150	760	296	19 7/8	7 3/16	10 1/8	56.2	370.3	14.0	A	3
145G51L	N150L	23	120	150	685	240	20 3/16	8 3/4	10 1/8	63.8	337.8	15	A	4

\* (S) Signifies Standard Terminal

▲ Figures based on JIS/SAE specifications and reference only.

## TERMINALS (measurements in inches)

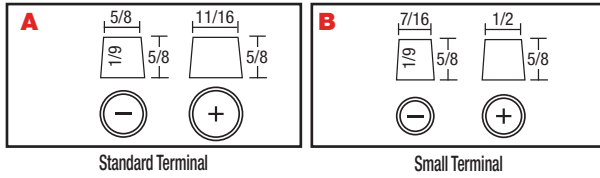

## BATTERY LAYOUTS

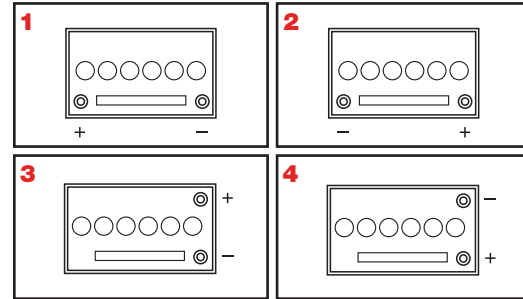

# BATTERY UPGRADE CROSS REFERENCE

GYZ Series	AGM Factory Activated	AGM High Performance	AGM	Yumicron	Conventional
-	-	-	-	6YB11-2D	6N11-2D
-	YTZ5S	YTX4L-BS	YT4L-BS (Discontinued)	YB4L-A, YB4L-B	-
-	YTZ7S	YTX5L-BS	YT5L-BS (Discontinued)	-	-
-	-	-	-	YB5L-B	12N5-3B
-	-	-	-	YB7L-B	12N7-3B
-	-	-	-	YB7-A	12N7-4A
-	-	-	-	YB9-B	12N9-4B-1
-	-	-	-	YB9L-B	12N9-3B
-	-	-	-	YB10L-A2	12N10-3A-2
-	-	-	-	YB12A-A	12N12A-4A-1
GYZ16H	YTX14H	YTX14H-BS	YTX14-BS	-	-
-	YTX14AH	YTX14AH-BS	-	YB14-A2, YB14-B2	-
-	YTX14AH <sup>3,4</sup>	YTX14AH-BS <sup>3,4</sup>	-	YB14A-A1, YB14A-A2	-
-	YTX14AHL	YTX14AHL-BS	-	YB14L-A2	12N14-3A
-	YTX14AHL	YTX14AHL-BS	-	YB14L-B2	-
GYZ16HL	YTX14L	YTX14L-BS	-	-	-
-	-	-	YT19BL-BS	51913, 51814	-
-	YTX20CH	YTX20CH-BS	YTX16-BS	-	-
GYZ20H <sup>7</sup>	YTX20H <sup>7</sup> , YTX20 <sup>2</sup>	YTX20H-BS <sup>2</sup>	YTX20-BS <sup>2</sup>	YB16-B, YB16-B-CX	-
GYZ20H	YTX20H, YTX20 <sup>2</sup>	YTX20H-BS <sup>2</sup>	YTX20-BS <sup>2</sup>	YB18-A	-
-	YTX20HL-PW <sup>6</sup>	YTX20HL-BS-PW <sup>6</sup>	-	YB16CL-B	-
GYZ20HL <sup>7</sup> , GYZ20L	YTX20HL, YTX20L	YTX20HL-BS	YTX20L-BS	YB16HL-A-CX	-
GYZ20HL, GYZ20L	YTX20HL, YTX20L <sup>2</sup>	YTX20HL-BS <sup>2</sup>	YTX20L-BS <sup>2</sup>	YB16L-B	-
GYZ20HL, GYZ20L	YTX20HL, YTX20L <sup>2</sup>	YTX20HL-BS <sup>2</sup>	YTX20L-BS <sup>2</sup>	YB18L-A	-
GYZ20HL <sup>8</sup> , GYZ20L	YTX20HL, YTX20L	YTX20HL-BS <sup>2</sup>	YTX20L-BS	-	-
-	YTX24HL <sup>3</sup>	YTX24HL-BS <sup>3</sup>	-	Y50-N18L-A, Y50-N18L-A-CX	-
-	YTX24HL	YTX24HL-BS	-	Y50-N18-A3	-
-	YTX24HL <sup>1,3</sup>	YTX24HL-BS <sup>1,3</sup>	-	SY50-N18-AT	-
-	YIX20HL <sup>9</sup>	YIX20HL-BS <sup>9</sup> > YTX20HL-BS	-	-	-
GYZ32HL	YIX30L <sup>9</sup>	YIX30L-BS <sup>9</sup>	-	YB30L-B	-
-	YIX30L-PW <sup>5,9</sup>	YIX30L-BS-PW <sup>5,9</sup>	-	YB30CLB	-
-	YIX30L <sup>9</sup>	YIX30L-BS <sup>9</sup>	-	53030	Y60-N24L-B (Discontinued)

1 Eliminates need for sensor (needs to be disabled).

2 The YTX20 series batteries may be used as an optional upgrade, but some modification to the hold down may be necessary. See battery label for retrofit cautions.

3 Top and front terminal mounts only.

4 Includes 10mm height spacer.

5 Includes 17mm height spacer.

6 Includes 20mm height spacer for use in replacing YB16CL-B.

7 For Harley-Davidson Models only.

8 GYZ20HL has flush terminals, different than OEM battery on Honda GL1800.

9 Preferred cold climate performance.



CC	Model	Year	High Performance AGM	AGM	Yumicron	Conventional	CC	Model	Year	High Performance AGM	AGM	Yumicron	Conventional	
<b>APRILIA</b>							<b>BMW</b>							
1200	Dorsoduro, Caponord	'11-'16	GYZ16H	YTX14-BS	--	--	1600	K1600GT, GTL	'11-'16	--	YT19BL-BS	51913	--	
1100	Tuono V4 1100, RR	'14-'16	--	YT12A-BS	--	--	1300	K1300GT	'09-'11	--	YT19BL-BS	51913	--	
1000	RSV4 R, Factory	'09-'15	YTZ10S	--	--	--	K1300R, S	'09-'16	GYZ16H	YTX14-BS	--	--	--	
	ETV Caponord	'02-'03	GYZ16H	YTX14-BS	--	--	1200	K1200R, S	'05-'09	GYZ16H	YTX14-BS	--	--	
	RST Futura	'01-'04	--	YTX12-BS	--	--		R1200S, R	'05-'16	GYZ16H	YTX14-BS	--	--	
	RSV 1000, Mille SP	'99	--	YTX12-BS	--	--		R1200GS	'05-'13	GYZ16H	YTX14-BS	--	--	
	RSV 1000 R, Factory	'04-'11	--	YTX12-BS	--	--		R1200GS Adventure	'09-'16	YTZ14S	YTX14-BS	--	--	
	RSV 1000, Mille R	'01-'05	--	YTX12-BS	--	--		R1200RS	'14-'15	GYZ16H	--	--	--	
	RSV 1000, Mille	'01-'09	--	YTX12-BS	--	--		K1200LT, GT	'05-'09	--	YT19BL-BS	51913	--	
	RSV 1000, Mille	'00	--	YTX12-BS	--	--		R1200RT	'05-'13	--	YT19BL-BS	51913	--	
	Tuono 1000 R, Factory	'03-'11	--	YTX12-BS	--	--		K1200LT, GT, RS, S	'99-'05	--	YT19BL-BS	51913	--	
	Tuono V4R	'11-'13	YTZ10S	--	--	--		K1200RS	'97-'05	--	YT19BL-BS	51913	--	
	SL Falco	'01-'03	GYZ16H	YTX14-BS	--	--		R1200C	'98-'05	--	YT19BL-BS	51913	--	
850	Mana 850, GT	'09-'13	GYZ16H	YTX14-BS	--	--		HP2 Sport / Megamoto	'11	GYZ16H	YTX14-BS	--	--	
750	Shiver	'09-'16	GYZ16H	YTX14-BS	--	--	1170	R nine T	'14-'16	GYZ16H	YTX14-BS	--	--	
	Dorsoduro	'09-'16	GYZ16H	YTX14-BS	--	--		R nine T Scrambler	--	GYZ16H	--	--	--	
650	Pegaso	'00	--	--	YB12AL-A	--	1150	R1150GS, R	'00-'05	--	YT19BL-BS	51913	--	
	Pegaso Strada, Factory, Trail	'09-'12	--	YTX12-BS	--	--		R1150R, RS, RT	'01-'06	--	YT19BL-BS	51913	--	
560	RXV550	'10	--	YTX7A-BS	--	--	1100	K1100LT/RS	'90-'95	--	YT19BL-BS	51913	--	
	SVX550	'10	--	YTX7A-BS	--	--		R1100GS	'94-'00	--	YT19BL-BS	51913	--	
500	Scarabeo	'04-'05	YTX14AHL-BS	--	--	--		R1100R	'94-'00	--	YT19BL-BS	51913	--	
	Atlantic	'03-'05	YTX14AHL-BS	--	--	--		R1100RS, RT	'93-'00	--	YT19BL-BS	51913	--	
450	RXV450	'10	--	YTX7A-BS	--	--		R1100S, ABS	'98-'05	--	YT19BL-BS	51913	--	
	SVX450	'10	--	YTX7A-BS	--	--	1000	All "K" Models	'83-'93	YIX30L-BS*	--	53030	--	
250	RS250	'00-'04	--	--	YB4L-B	--		R1007	'76-'84	YIX30L-BS*	--	53030	--	
200	Atlantic	'04-'05	--	--	YB12AL-A	--		R100GS, PD, R, RS, RT	'87-'95	YIX30L-BS*	--	53030	--	
150	Scarabeo	'00-'04	--	--	YB12AL-A	--		R100CS	'76-'84	YIX30L-BS*	--	53030	--	
	Mojito	'04-'05	--	YTX7L-BS	--	--		HP4 (w/ alarm system)	'13-'14	YTZ10S	--	--	--	
125	RS125	'11	--	--	YB9-B	--		HP4 (w/o alarm system)	'13-'14	YTZ7S	--	--	--	
	RS4 125	'11-'13	--	YTX7L-BS	--	--		S1000R	'14-'16	YTZ10S	--	--	--	
50	RS50	'00-'05	--	--	YB4L-B	--		S1000RR	'09-'13	YTZ10S	--	--	--	
	RS4 50	'11-'13	YTZ7S*	YTX5L-BS	--	--		S1000RR DWA	'09-'11	YTZ12S	--	--	--	
	SR50	'00-'01	--	--	YB4L-B	--		S1000RR	'14-'16	YTZ7S	--	--	--	
	SR50 Ditech	'01-'05	YTZ7S*	YTX5L-BS	--	--		S1000RR DWA	'14-'16	YTZ10S	--	--	--	
	Scarabeo 50	'00-'03	--	--	YB4L-B	--		S1000XR	'16	--	YTX9-BS	--	--	
	Mojito	'04-'05	--	--	YB4L-B	--		S1000XR DWA	'16	YTZ10S	--	--	--	
	Rally	'04-'05	--	--	YB4L-B	--	900	R90/6, R90S	'69-'76	YIX30L-BS*	--	53030	--	
<b>ATK</b>							850	R850R	'95-'97	--	YT19BL-BS	51913	--	
	All Electric Start Models	'91-'95	--	YTX9-BS	--	--	800	F800ST, GS, GT, R, ADV	'08-'16	GYZ16H	YTX14-BS	--	--	
	All Electric Start Models	'96-'01	--	YTX7L-BS	--	--		F800GT (auxiliary battery)	'13-'16	YTZ14S	YTX14-BS	--	--	
<b>BENELLI</b>								R80, R80RT	'84-'95	YIX30L-BS*	--	53030	--	
900	900 (6 Cilindri)	--	--	YIX30L-BS*	53030	--		R80GS, R80ST	'80-'96	--	YT19BL-BS	51814	--	
650	650 Tornado U.T.	--	--	--	YB12A-A*	12N12A4A-1		R807, R80RT	'78-'84	YIX30L-BS*	--	53030	--	
250	250 (4 Cilindri)	--	--	--	YB12A-A	--	750	K75, RT	'85-'95	YIX30L-BS*	--	53030	--	
	250-2C	--	--	--	--	6N11A-1B		K75	'85-'86	--	YT19BL-BS	51814	--	
125	125 Cross	--	--	--	--	6N11A-1B		K75C	'85-'86	--	YT19BL-BS	51814	--	
	125 Custom Guzzi	--	--	--	--	12N5.5-4A		K75C	'87-'93	--	--	52515*	--	
	125 Guzzi	--	--	--	--	12N5.5-4A		K75C	'85-'95	--	YT19BL-BS	51814	--	
	125 Jarmo (c/av.)	--	--	--	YB9-B*	12N9-4B-1		K75RT	'92-'96	--	YT19BL-BS	51913	--	
	125 Scooter Benelli	--	--	--	YB9L-B*	12N9-3B		K75S	'85-'86	--	YT19BL-BS	51814	--	
	125-2 CSE	--	--	--	--	6N11A-1B		K75S	'87-'92	--	--	52515*	--	
	125CS	--	--	--	YB9-B*	12N9-4B-1		R75/5	'70-'73	--	YT19BL-BS	51814	--	
	125T Sport	--	--	--	--	6N11A-1B		R75/7	'76-'84	YIX30L-BS*	--	53030	--	
50	Devil 50 (c/av.)	--	--	--	YB4L-B	--	700	R75/6	'69-'76	YIX30L-BS*	--	53030	--	
	KBX 50 Race	--	--	--	YB4L-B	--		R69 - R69S	'55-'69	--	--	--	B38-6A	
	Scooty LX/DLX	--	--	--	YB4L-B	--		F700GS	'11-'16	GYZ16H	--	YTX14-BS	--	
<b>BIG DOG</b>								F700GS (auxiliary battery)	'11-'16	--	YTZ14S	--	--	
	All Models	All Years	YTX20HL	--	--	--	650	F650, G650GS	'93-'16	--	--	YB12AL-A	--	
<b>BIMOTA</b>								F650GS	'08-'12	YTX14H-BS*	YTX14-BS	--	--	--
	All Models	All Years	YTX20HL	--	--	--		R65	'84-'95	YIX30L-BS*	--	53030	--	
1100	SB6, SB7	'95-'97	--	YTX7L-BS(x2)	--	--		R65LS	'78-'84	--	YT19BL-BS	51814	--	
	SB6R	'97-'99	--	YTX12-BS	--	--	600	R60, R60/2 Twin Cylinders	'55-'69	--	--	--	B38-6A	
1000	YB8/YB10	'92-'95	YTX14AHL-BS*	--	YB14L-A2	--		R60/5	'70-'73	--	YT19BL-BS	51814	--	
	YB11	'96-'99	--	YTX12-BS	--	--		R60/6, R60/7	'69-'84	YIX30L-BS*	--	53030	--	
996	SB8R, SB8RS	'98-'00	--	YTX12-BS	--	--	500	R50/5	'55-'69	--	--	--	B38-6A	
900	DB2	'93-'95	YTX14AH-BS*	--	YB14-A2	--		R50/S Twin Cylinders	'55-'69	--	--	--	B38-6A	
	DB2 Final Edition	'97	YTX14AH-BS*	--	YB14-A2	--	450	G450	'09-'11	YTZ7/S	--	--	--	
	DB3 Mantra	'97-'99	--	YTX7L-BS(x2)	--	--	310	G 310 R	--	TBD	--	--	--	
	DB4	'98-'00	--	Not available	--	--	260	R26, R27 Single Cylinder	'55-'69	--	--	--	6N11A-1B B39-6A	
	Tesi	'91-'95	YTX14AH-BS*	--	YB14-A2	--		R 26	--	--	--	--	--	

\* See Battery Cross Reference Chart on page 14  
 FA Must use factory activated battery

\* 52515 not available in USA

CC	Model	Year	High Performance AGM	AGM	Yumicron	Conventional	CC	Model	Year	High Performance AGM	AGM	Yumicron	Conventional		
<b>BRP (CAN-AM)</b>															
1330	Spyder (RT, F3)	'14-'17	YTX24HL	-	-	-	1098		'07	GYZ16H	YTX14-BS	-	-		
998	Spyder (RS)	'08-'16	YTX24HL	-	-	-	Various All other models	'01-'10	-	-	YT12B-BS	-	-		
<b>BSA</b>							1000	Desmosedici RR	'08-'09	-	-	YT12B-BS	-	-	
250, 350, 400, 441, 500 (12V)			-	-	YB7-A*	12N7-4A	GT1000, Touring, Sport 1100S	'09	-	-	YT12B-BS	-	-		
600, 650, 750 (12V)			-	-	YB7-A*	12N7-4A	Monster S2R	'05-'07	-	-	YT12B-BS	-	-		
250, 350, 650 (6V)			-	-	-	-	998, 998, 999	'02-'07	-	-	YT12B-BS	-	-		
500 Gold Star			-	-	-	B38-6A	996, 996, S, SPS	'99-'00	-	-	-	YB16AL-A2	-		
Rocket 750, Thunderbolt			-	-	YB9L-B*	12N9-3B	994	Suport Touring 2 (ST2)	'97-'00	-	-	YB16AL-A2	-		
Spiritfire HK35, Starfire B25			-	-	YB9L-B*	12N9-3B	959	959 Panigale	'16	-	-	YT7B-BS	-		
<b>BUELL</b>							939	Hypermotard	'16	-	-	YT12B-BS	-	-	
1200	X1 Lightning	'99-'02	YTX20HL*FA	YTX20L*FA	-	-	Hyperstrada	'16	-	-	YT12B-BS	-	-		
S1 Lightning		'96-'99	YTX14H-BS***	YTX14-BS***	-	-	916	916 Biposto, Senna, Strada	'94-'98	-	-	YB16AL-A2	-		
S3, S3T Thunderbolt		'97-'02	YTX20HL-BS*	YTX20L-BS	-	-	I.E., SP, SP S	'94-'98	-	-	YB16AL-A2	-	-		
M2 Cyclone		'97-'02	YTX20HL-BS*	YTX20L-BS	-	-	ST4	'99-'00	-	-	YB16AL-A2	-	-		
S2, S2T Thunderbolt		'94-'96	YTX20H-BS*	YTX20-BS*	YB16-B-CX	-	907	I.E. Paso	'90-'94	YTX20H-BS*	YTX20-BS*	YB16-B	-		
RR1200		'88-'90	YTX20H-BS*	YTX20-BS*	YB16-B-CX	-	906	Paso	'90-'92	YTX20H-BS*	YTX20-BS*	YB16-B	-		
RS1200		'89-'93	YTX20H-BS*	YTX20-BS*	YB16-B-CX	-	900	Monster	'94-'00	-	-	YB16AL-A2	-		
RSS1200		'91-'93	YTX20H-BS*	YTX20-BS*	YB16-B-CX	-	SS Kick-Starter	'81	-	-	YB12A-A	-	-		
XB12R Firebolt		'04-'10	YTX14H*FA	YTX14*FA	-	-	SS Replica	'81	-	-	YB12A-A	-	-		
XB12Ss, Scq, Lightning		'04-'10	YTX14H*FA	YTX14*FA	-	-	SS Supersport, Replica	'82-	YTX14AHL-BS*	-	YB14L-A2	-	-		
XB12X, XT Ulysses		'06-'10	YTX14H*FA	YTX14*FA	-	-	SS	'89-'00	-	Not available	-	-	-		
1125	1125R, 1125CR	'08-'10	-	YTX14L*FA	-	-	SL	'92-'96	-	-	YB16AL-A2	-	-		
Buell Racing 1125RR		'09	YTZ7S	-	-	-	Supersport FE	'97-'98	-	-	YB16AL-A2	-	-		
1000	RR1000	'87	YTX20H-BS*	YTX20-BS*	YB16-B-CX	-	888	SP, SP II, SP IV, SP V	'90-'95	-	-	YB16AL-A2	-		
984	XB9R Firebolt, XB9SX Lightning	'02-'10	YTX14H*FA	YTX14*FA	-	-	860	GT, GTS	-	-	YIX30L-BS*	53030	-		
500	Blast	'00-'09	YTX14H-BS*	YTX14-BS	-	-	Kick-Start	-	-	-	YB12A-A	-	-		
<b>CAGIVA</b>							851	851 Superbike	'90-'91	-	-	YB16AL-A2	-	-	
900	Elefant E900		-	-	YB16B-A1	-	S Superbike	'91-'92	-	-	YB16AL-A2	-	-		
750	Elefant	'94-'97	YTX20H-BS*	YTX20-BS*	YB16-B	-	848	848, Corse SE	'08-'13	-	-	YT12B-BS	-	-	
Elefant Bifaro		'89	YTX14AHL-BS*	-	YB14L-A2	-	Street Fighter	'13	-	-	YT12B-BS	-	-		
500	T4 E Elefant	'88-	YTX14AHL-BS*	-	YB14L-A2	-	821	Monster	'14-'16	-	-	YT12B-BS	-	-	
350	Elefant 2 Cyl.	'86-	YTX14AHL-BS*	-	YB14L-A2	-	803	Scrambler	'15-'16	-	-	YT12B-BS	-	-	
T4 E Elefant, W12		'87-	YTX14AHL-BS*	-	YB14L-A2	-	796	Hypermotard	'10-'13	-	-	YT12B-BS	-	-	
T4R		'87-	-	-	YB3L-A	-	Monster 796	'10-'13	-	-	YT12B-BS	-	-		
125	Crouser	'87-'88	-	-	YB9-B	-	750	F1, Montjuich, Paso	'87-'90	YTX14AHL-BS*	-	YB14L-A2	-	-	
Freccia C9, /C10R, /C12R		'87-'90	-	-	YB9-B	-	GT, Luguna Seca		YX30L-BS*	-	53030	-	-		
Mito		'90-'97	-	-	YB9-B	-	Indiana		YTX14AHL-BS*	-	YB14L-A2	-	-		
N 90		'97	-	-	YB9-B	-	Monster	'97-'00	-	Not available	-	-	-		
Roadster		'94-'97	-	-	YB9-B	-	Sport	'89-'90	-	-	YB16AL-A2	-	-		
Supercity		'91-'97	-	-	YB9-B	-	SS Supersport Kick-Str.		-	-	YB12A-A	-	-		
50	City, Lucky, Explorer	'94-'97	-	YTX4L-BS	-	-	SS	'90-'00	-	-	YB16AL-A2	-	-		
K3, W4		'98	-	-	YB4L-B	-	748	748 Strada Biposto, SP, SPS	'97-'00	-	-	YB16AL-A2	-	-	
<b>CANNONDALE</b>							696	Monster 696	'08-'13	-	-	YT12B-BS	-	-	
440	C440, E440, S440, X440, X440S	'02-'03	YTZ7S	-	-	-	650	Alazurra, Indiana, Pantah		YTX14AHL-BS*	-	YB14L-A2	-	-	
EX400, MX400, XC400		'00-'01	YTZ7S*	YTX5L-BS	-	-	600	Pantah		YTX14AHL-BS*	-	YB14L-A2	-	-	
<b>CCM</b>								TL		YTX14AHL-BS*	-	YB14L-A2	-	-	
600	All Electric Start Models	'96-'01	-	YTX9-BS	-	-	500	GTL, GTV		YTX24HL-BS*	-	Y50-N18L-A	-	-	
<b>DERBI</b>								Pantah		YTX14AHL-BS	-	-	-	-	-
All Models			-	-	YB4L-B	-	Sport		YTX24HL-BS*	-	Y50-N18L-A	-	-		
<b>DUCATI</b>							399	Scrambler Sixty2	'16	-	-	YT12B-BS	-	-	
1299	Superbike 1299 Panigale, S	'15-'16	-	YT7B-BS	-	-	<b>EXCELSIOR-HENDERSON</b>								
1262	Diavel, S	'16	-	YT12B-BS	-	-	1386 (85)	Super X	'99-'00	YTX20HL-BS*	YTX20L-BS	-	-		
1200	Multistrada	'10-'16	-	YT12B-BS	-	-	<b>GAS GAS</b>								
Monster 1200		'14-'16	-	YT12B-BS	-	-	450	FSR450	'08	YTZ7S	-	-	-		
1199	1199, Panigale, (S)	'11-'14	-	YT7B-BS	-	-	370	Pampera	'97	-	YTX4L-BS	-	-		
1198	1198, MY08, SP, R	'09-'11	-	YT12B-BS	-	-	320	Pampera	'98-'01	-	YTX4L-BS	-	-		
Diavel		'11-'16	-	YT12B-BS	-	-	250	Pampera	'96-'01	-	YTX4L-BS	-	-		
1198 Panigale R		'16	-	Not available	-	-	<b>GILERA</b>								
1100	Monster 1100	'09-'13	-	YT12B-BS	-	-	600	Nordwest	'93	YTX14AHL-BS*	-	-	-		
Multistrada		'07-'09	-	YT12B-BS	-	-	RC 600C	'93	YTX14AHL-BS*	-	-	-	-		
Hypermotard		'07-'13	-	YT12B-BS	-	-	Top Rally, XRT		YTX14AHL-BS*	-	-	-	-		
Street Fighter, S		'09-'12	-	YT12B-BS	-	-	500	Dakota Kick-Start		-	-	-	12N5.5-3B		
1098	1098	'07-'09	-	YT12B-BS	-	-	Dakota E-Starter		-	-	-	YB10L-A2	-		
							350	Dakota Kick-Start		-	-	-	12N5.5-3B		
								Dakota E-Starter		-	-	-	YB10L-A2	-	
								ER Kick-Start		-	-	-	12N5.5-3B		
								ER E-Starter		-	-	-	YB10L-A2	-	
								XRT		YTX14AHL-BS*	-	-	-	-	
							250	Arizona Rally		-	-	-	YB10L-B	-	
								V NGR Kick-Start		-	-	-	12N5.5-3B	-	

\*\* Must use adapter kit available from Buell  
\* See Battery Cross Reference Chart on page 14

FA Must use factory activated battery









CC	Model	Year	High Performance AGM	AGM	Yumicron	Conventional	CC	Model	Year	High Performance AGM	AGM	Yumicron	Conventional
<b>KTM</b>							V11 Bassa	'99-'00	YIX30L-BS*	-	53030	-	
							V11 EV	'98-'99	YIX30L-BS*	-	53030	-	
							V11 Le Mans, Sport	'99-'05	-	YTX15L <sup>FA</sup>	-	-	
1290	Super Duke, R	'14-'16	YTX14H-BS*	YTX14-BS	-	-	1064	California Classic, Vintage	'12	YTX20HL-BS*	YTX20L-BS	-	-
							1000	California III	'89-'93	YIX30L-BS*	-	53030	-
1190	RC8	'09-'16	YTZ14S	-	-	-	Convert		YIX30L-BS*	-	53030	-	
							Daytona		YIX30L-BS*	-	53030	-	
							Le Mans		YIX30L-BS*	-	53030	-	
990	Super Duke	'03-'13	YTZ14S	-	-	-	Mille		YIX30L-BS*	-	53030	-	
							1000NT		YIX30L-BS*	-	53030	-	
							Quota		YIX30L-BS*	-	53030	-	
							V10 Centauro Sport, GT	'99-On	-	YTX15L <sup>FA</sup>	-	-	
							936	Bellagio	'10	YTX20HL-BS	YTX20L-BS	-	-
							850	Le Man		YIX30L-BS*	-	53030	-
							T3, T4, T5		YIX30L-BS*	-	53030	-	
							750	Breva 750	'04-'10	YTX14AHL-BS	-	-	
							V7 Classic	'09-'11	YTX14AHL-BS	-	-		
							Nevada		YTX20HL-BS*	YTX20L-BS*	YB18L-A	-	
							Nevada 750 Classic	'10	YTX14AHL-BS	-	-		
							NTX		YTX20HL-BS*	YTX20L-BS*	YB18L-A	-	
							Strada		YTX20HL-BS*	YTX20L-BS*	YB18L-A	-	
							V7		YIX30L-BS*	-	53030	-	
							V7, Racer, Scrambler	'12-'16	GVZ16H	YTX14-BS	-	-	
							V75		YTX20HL-BS*	YTX20L-BS*	YB18L-A	-	
							650	NTX		YTX20HL-BS*	YTX20L-BS*	YB18L-A	-
							V65		YIX30L-BS*	-	53030	-	
							V65 Florida		YTX20HL-BS*	YTX20L-BS*	YB18L-A	-	
							500	Falcone		-	-	B38-6A	
							Falcone u.t.		YTX20HL-BS*	YTX20L-BS*	YB18L-A	-	
							V50		-	YIX30L-BS*	53030	-	
<b>MuZ</b>							660	Skorpion '95-'01	'95-'01	-	-	YB9L-A2	-
							125	All Models All Years	ALL	-	-	YB9L-A2	-
<b>MV AGUSTA</b>							1000	F4	'05-'16	YTZ10S	-	-	-
								Brutale 1078RR, 1090	'09-'16	YTZ10S	-	-	-
							910	Brutale	'06-'09	YTZ10S	-	-	-
							800	Brutale	'16	YTZ10S	-	-	-
							750	F4, Brutale	'00-'08	YTZ10S	-	-	-
							675	F3, Brutale	'16	YTZ10S	-	-	-
<b>NORTON</b>							850	Commando, Commando (75)		YTX14AHL-BS*	-	YB14L-A2	-
							750	Ranger Commando		-	-	-	12N9-4B-1
							350	Navigator		-	-	-	6N11A-1B
<b>PIAGGIO</b>							APE CAR, MP, MPR, P602		YIX30L-BS*	-	53030	-	
							Ape 50 FL	'93	-	-	YB9-B	-	
							Boxer, Bravo, Ciao		-	-	-	B39-6	
							Cosa 2		-	-	YB7-A	-	
							Cosa CLX 125 (c/aw.)		-	-	YB7-A	-	
							Cosa CLX 150 (c/aw.)		-	-	YB7-A	-	
							Cosa CLX 200 (c/aw.)		-	-	YB7-A	-	
							Free		-	-	YB4L-B	-	
							Hexagon 125/150		-	-	YB9-B	-	
							NRG 50		-	-	YB4L-B	-	
							P125ETES, P125TS		-	-	YB7-A*	12N7-4A	
							P200E (c/aw.)		-	-	YB9-B	-	
							PK50, PK50-C.A., PK50N, PK50XL		-	-	YB7-A*	12N7-4A	
							PK80S-C.A.		-	-	YB7-A*	12N7-4A	
							PK125FL, PK125SS, PK125XL		-	-	YB7-A*	12N7-4A	
							PX125		-	-	YB9-B	-	
							PX125+80E		-	-	-	12N5.5-3B	
							PX125+80E-AREC		-	-	-	12N5.5-3B	
							PX125-80E-ARC		-	-	YB9-B	-	
							PX125T5		-	-	YB9-B	-	
							PX150E		-	-	YB9-B	-	
							PX150E-ARC		-	-	YB9-B	-	
							PX200-ARC		-	-	YB9-B	-	
							PX200E-ARC		-	-	-	12N5.5-3B	
							PX200GS		-	-	YB9-B	-	
<b>KYMCO</b>							250	Venox250	'09-'10	-	YTX9-BS	-	-
<b>MOTO GUZZI</b>							1400	AUDACE	'16	YTX20CH-BS	-	-	-
							1380	California	'13	YTX20H-BS*	YTX20-BS	-	-
								Eldorado	'16	YTX20CH-BS	-	-	-
							1200	Norge	'09-'16	YTX20CH-BS	-	-	-
								Sport, ABS	'09-'10	YTX20CH-BS	-	-	-
								Breva 1200	'09-'10	YTX20CH-BS	-	-	-
								Stelvio	'09-'16	YTX20CH-BS	-	-	-
								1200 Sport	'09-'13	YTX20CH-BS	-	-	-
								GRISO V8	'13-'16	YTX20CH-BS	-	-	-
							1100	1100 California	'03-'05	-	YTX15L-BS	-	-
								California, Special, Jackal, Breva, Griso	'05-'13	YTX20CH-BS	-	-	-
								Stone, EV	'94-'05	YIX30L-BS*	-	53030	-
								Quota 1100 ES	'99-'02	-	YTX15L <sup>FA</sup>	-	-
								Sport 1100i	'97-'99	-	YTX15L-BS	-	-

<sup>FA</sup> Must use factory activated battery

<sup>\*\*</sup> When ordering this battery, specify terminal adaptor  
<sup>\*</sup> See Battery Cross Reference Chart on page 14

# MOTORCYCLE APPLICATIONS

CC	Model	Year	High Performance AGM	AGM	Yumicron	Conventional	CC	Model	Year	High Performance AGM	AGM	Yumicron	Conventional
<b>PIAGGIO</b>													
	Quartz, Sactto, Sfera 50, Sfera 80, Skipper 125/150		-	-	YB4L-B	-		VS700GL Intruder	'85-'87	-	-	YB16B-A1	-
	Vespa 50 Elestart		-	-	-	6N11A-1B (x2pcs.)		650 DL650 V-Strom ABS, Adventure	'04-'17	-	YTX12-BS	-	-
	Vespa 125 Sprint		-	-	-	B39-6		DR650S ER, ES	'94-'95	-	YTX12-BS	-	-
	Vespa 150 GL		-	-	-	B39-6		DR650S N, P	'92-'93	-	YTX4L-BS	-	-
	Vespa PK 50 FL/FL2 (c/av.)		-	-	YB7-A	-		DR650S	'90-'91	-	-	YB5L-B*	12N5-3B
	Zip - Zip (Fast Rider)		-	-	YB4L-B	-		DR650SE	'98-'14	-	YTX9-BS	-	-
								DR650SE (CN)	'96-'97	-	YTX9-BS	-	-
								DR650SE	'96-'97	-	-	YB10L-B2	-
								GR650 Tempter, X	'83	YTX14AHL-BS*	-	YB14L-A2	-
								GS650E	'81-'82	-	-	YB10L-A2	-
								GS650 (All)	'81-'83	YTX14AHL-BS*	-	YB14L-A2	-
								GSX650F	'08-'11	-	YTX9-BS	-	-
								LS650 Savage, S40	'86-'14	YTX14AHL-BS*	-	YB14L-B2	-
								SV650	'99-'02	-	YT12A-BS	-	-
								SV650A, SA	'03-'10	-	YT12A-BS	-	-
								SV650, S	'03-'13	-	YTX12-BS	-	-
								SV650	'17-	TBD	-	-	-
								SVF650 Gladius	'09-'14	-	YT12A-BS	-	-
								XN85 Turbo	'83	YTX14AHL-BS*	-	YB14L-A2	-
								600 GSF600S Bandit	'96-'03	-	YTX9-BS	-	-
								GSX-R600	'97-'16	-	YTX9-BS	-	-
								GSX-R600W	'92-'93	-	YTX9-BS	-	-
								GSX600F Katana	'98-'06	-	YTX9-BS	-	-
								GSX600F Katana	'88-'97	-	-	YB10L-B2	-
								SP600	'85	-	-	YB5L-B*	12N5-3B
								RF600R, S	'94-'96	-	YTX9-BS	-	-
								550 GS550E, L, M, TX	'77-'82	-	-	YB10L-A2	-
								GS550E, ES, L	'83-'86	-	-	YB10L-B	-
								GT550 Indy	'72-'77	-	-	-	-
								500 GS500, F	'01-'11	-	-	YB10L-B2	-
								GS500E	'89-'00	-	-	YB10L-B2	-
								GT500 Titan	'76-'77	-	-	YB7-A*	12N7-4A
								SP500	'81-'83	-	-	-	6N4B-2A
								T500 Titan	'68-'75	-	-	YB7-A*	12N7-4A
								450 GS450	'83-'88	-	-	YB12B-B2	-
								GS450	'80-'82	-	-	YB10L-A2	-
								425 GS425, GS425E, L	'79	-	-	YB10L-A2	-
								400 DR-Z400, E, S, SM	'00-'17	-	YT7B-BS	-	-
								GN400T, X	'80-'82	-	-	-	6N4B-2A
								GS400	'77-'78	-	-	YB10L-A2	-
								GS400X	'77-'78	-	-	YB7-A*	12N7-4A
								GSF400 Bandit	'91-'93	-	YTX9-BS	-	-
								SP400	'80	-	-	-	6N4B-2A
								TS400 Apache	'76-'77	-	-	-	6N4B-2A
								TS400 Apache	'72-'75	-	-	YB5L-B*	12N5-3B
								380 GT380 Sebring	'72-'77	-	-	YB7-A*	12N7-4A
								370 SP370	'78-'79	-	-	-	6N4B-2A
								350 DR350S	'90-'96	-	YTX4L-BS	-	-
								DR350SE	'94-'99	-	YTX7L-BS	-	-
								T350 Series	'79	-	-	YB5L-B*	12N5-3B
								305 Scrambler TC305	'69	-	-	YB5L-B*	12N5-3B
								T305	'69	-	-	YB5L-B*	12N5-3B
								300 GS300L	'82-'85	-	-	YB12B-B2	-
								250 DR250S	'90-'92	-	YTX4L-BS	-	-
								DR250S EP, ER, ES	'93-'95	-	YTX7L-BS	-	-
								DR-Z250	'01-'07	YTZ7S	-	-	-
								GN250	'82-'88	-	-	YB10L-A2	-
								GS250T	'80-'81	-	-	YB10L-A2	-
								GT250 Hustler	'73-'77	-	-	YB5L-B*	12N5-3B
								GW250	'13-'17	-	YTX9-BS	-	-
								GZ250	'99-'12	-	YTX7L-BS	-	-
								Model T20	'69	-	-	YB5L-B*	12N5-3B
								SP250	'82-'85	-	-	-	6N4B-2A
								Scrambler TC250	'69	-	-	YB5L-B*	12N5-3B
								T250, T250-II, T250J, T250R	'72	-	-	YB5L-B*	12N5-3B
								TS250 Savage	'73-'81	-	-	-	6N4B-2A
								TS250 Savage	'69-'72	-	-	-	6N2-2A-4
								TU250X	'09-'17	-	YTX7L-BS	-	-
								200 DR200SE	'96-'13	-	YTX7L-BS	-	-
								DR200S	'15-'17	-	YTX7L-BS	-	-
								SP200	'86-'88	-	-	YB4L-B	-
								T200, TC200	-	-	-	YB5L-B*	12N5-3B
								VanVan200	'17-	TBD	-	-	-
								185 GT185 Adventurer	'73-'77	-	-	-	-
								TC185 Ranger	'74-'77	-	-	-	-
								TS185 Sierra	'77-'81	-	-	-	6N4B-2A

\* See Battery Cross Reference Chart on page 14



CC	Model	Year	High Performance AGM	AGM	Yumicron	Conventional	CC	Model	Year	High Performance AGM	AGM	Yumicron	Conventional
<b>SUZUKI</b>							750	Bonneville, Tiger				YB9-B	12N9-4B-1
	TS185 Sierra	'71-'76	-	-	-	6N4-2A		T150 Trident				YB7L-B	12N7-3B
125	DR125, SE, SES	'94-'96	-	YTX7L-BS	-	-		All Other Models	'93-'97	YTX14AHL-BS	-	-	-
	GN125, E	'91-'96	-	-	YB7-A	-	675	Daytona 675, R	'06-'10	-	Y77B-BS	-	-
	GN125, E	'82-'83	-	-	YB7-A	-		Daytona 675, R	'11-'12	-	YTX9-BS	-	-
	RV125 SE, R	'94	-	YTX7L-BS	-	-		Daytona 675, R	'13-'16	-	YTX9-BS	-	-
	RV125 Tracker	'73-'77	-	-	-	-		Street Triple, R	'09-'13	-	YTX9-BS	-	-
	SP125	'86-'88	-	-	-	6N4-2A	650	T120 Bonneville		-	-	YB7L-B	12N7-3B
	SP125	'82-'83	-	-	-	6N4-2A	600	600 (12V)		-	-	Not available	-
	TC125 Prospector	'73-'77	-	-	-	6N4B-2A		6T, T20B		-	-	-	6N11A-1B
	TS125 Duster	'71-'81	-	-	-	6N4B-2A		Daytona 600/650, Speed Four	'03-'05	-	YTX9-BS	-	-
120	B120P		-	-	-	6N4-2A		TT600	'00-'03	-	YTX12-BS	-	-
	TC120, TC120-II, TC120R	'71	-	-	-	6N4B-2A	500	500 (12V)		-	-	Not available	-
105	B105P		-	-	-	6N4-2A		5TA, TR5A/R		-	-	-	6N11A-1B
100	A100 Go-fer	'76-'77	-	-	-	6N4-2A	350	350 (6V)		-	-	-	6N11A-1B
	A100 Go-fer	'69	-	-	-	6N4-2A		350 (12V)		-	-	Not available	-
	B100P		-	-	-	6N4-2A		350 3TA, Twenty One		-	-	-	B38-6A
	SP100	'83	-	-	-	6N4B-2A	250	Tigriss (6V)		-	-	-	6N11A-1B
	Scrambler AC100	'69	-	-	-	6N4-2A		Tigriss (12V)		-	-	-	6N11A-1B (x2pcs.)
	Sport AS100	'69	-	-	-	6N4-2A	200	Tiger		-	-	-	6N11A-1B
	TC100 Blazer	'73-'77	-	-	-	6N4-2A	183	Tigriss		-	-	-	6N11A-1B
	TS100 Honcho	'78-'81	-	-	-	6N4B-2A	<b>CC (cc) VICTORY</b>						
	TS100 Honcho	'73-'77	-	-	-	6N4-2A	1731 (106)	All Models	'08-'17	YTX20HL	-	-	-
90	RV90 Rover	'73-'77	-	-	-	6N4B-2A	1634 (100)	Vegas, Kingpin, Hammer (-08)	'06-'10	YTX20HL	-	-	-
	RV90 Rover	'72	-	-	-	6N2-2A-4	1507 (92)	Vegas, Kingpin, Hammer	'03-'05	YTX20HL-BS*	YTX20L-BS	-	-
	TC90		-	-	-	6N4-2A	1507 (92)	V92TC Touring Cruiser	'02-'06	YTX20HL-BS*	YTX20L-BS	-	-
	TC90J, TC90R		-	-	-	6N4-2A	1507 (92)	V92SC Sport Cruiser	'00-'01	YTX20HL-BS*	YTX20L-BS	-	-
	Model K10, Model K10P	'68	-	-	-	6N4-2A	1507 (92)	V92C, DC Classic, Deluxe Cruiser	'98-'04	YTX20HL-BS*	YTX20L-BS	-	-
80	Sport 80 (Models K11 & K11P)	'68	-	-	-	6N4-2A	1200 (73)	OCTANE	'16-'17	YTX20HL-BS*	YTX20L-BS	-	-
	Trail 80 (Models K15 & K15P)	'68	-	-	-	6N4-2A	<b>YAMAHA</b>						
75	TS75 Colt	'75-'77	-	-	-	6N4-2A	1854	Roadliner, Stratoliner	'06-'14	-	Y114B-BS	-	-
70	DR-Z70	'08-'09, '15-'17	-	Y4B-BS	-	-		Raider, Raider S	'08-'17	-	Y114B-BS	-	-
55	Model 31	'68	-	-	-	6N2-2A-4	1700	VMAX	'09-'17	YTZ14S	-	-	-
50	AC50, AS50	'71	-	-	-	6N4-2A		XV17AT Road Star, Silverado	'04-'07	YTX20HL-BS*	YTX20L-BS	-	-
	QR50	'79-'80	-	-	-	6N4B-2A		XV17P Road Star Warrior	'02-'13	-	Y114B-BS	-	-
	Sport 50 (Model M12)	'68	-	-	-	6N4-2A		XV17AT Road Star, Silverado	'08-'14	-	Y114B-BS	-	-
	TS50	'74	-	-	-	6N4-2A	1600	XV1600 Road Star	'99-'03	YTX20HL-BS*	YTX20L-BS	-	-
							1300	FJ1300, A, ES	'03-'17	-	Y114B-BS	-	-
								XVZ13 Royal Star/Venture (All)	'96-'13	YTX20HL-BS*	YTX20L-BS	-	-
								XVZ13 Venture/Royale	'86-'93	YTX24HL-BS*	-	SY50-N18L-AT	-
								XVS13AY V-Star 1300, Stryker	'09-'16	YTX20HL-BS*	YTX20L-BS	-	-
								V-Star 1300 Tourer	'16-'17	YTX20HL-BS*	YTX20L-BS	-	-
							1200	FJ1200 (All)	'91-'93	GVZ16H	YTX14-BS	-	-
								FJ1200	'86-'90	YTX14AHL-BS*	-	YB14L-A2	-
								VMX12 V-Max	'85-'07	-	-	YB16AL-A2	-
								XT1200Z Super Tenere	'12-'17	YTZ12S	-	-	-
								XVZ12 Venture/Royale	'83-'85	YTX24HL-BS*	-	SY50-N18L-AT	-
							1100	FJ1100	'84-'85	YTX14AHL-BS*	-	YB14L-A2	-
								XJ1100 Maxim	'82	YTX24HL-BS*	-	SY50-N18L-AT	-
								XS1100 (All)	'78-'81	YTX24HL-BS*	-	Y50-N18L-A-CX*	Y50-N18L-A
								XV1100 Virago (All)	'86-'99	YTX24HL-BS*	-	Y50-N18L-A-CX*	Y50-N18L-A
								XVS1100 V-Star (All)	'99-'10	-	Y114B-BS	-	-
							1000	FZR1000	'91-'95	GVZ16H	YTX14-BS	-	-
								FZR1000	'87-'90	YTX14AHL-BS	-	YB14L-A2	-
								FZS1000 FZ1	'06-'15	YTZ14S	-	-	-
								FZS1000 FZ1	'01-'05	-	Y114B-BS	-	-
								GTS1000	'93-'94	GVZ16H	YTX14-BS	-	-
								XV1000 Virago	'84-'85	YTX24HL-BS*	-	Y50-N18L-A-CX*	Y50-N18L-A
								YZF-R1	'99-'03	-	Y112B-BS	-	-
								YZF-R1, M	'04-'15	YTZ10S	-	-	-
								YZF-R1, M, S	'16-'17	YTZ7S	-	-	-
								YZF1000R	'97-'98	GVZ16H	YTX14-BS	-	-
								FZ-10	'17-	TBD	-	-	-
800	Bonneville	'01-'05	-	YTX12-BS	-	-	950	XVS95CCTY V Star 950, Tourer	'09-'17	YTZ14S	-	-	-
	Speedmaster	'03-'05	-	YTX12-BS	-	-		XVS95CC Copycat	'09-'16	YTZ14S	-	-	-
	Tiger 800	'11-'16	-	YTX16-BS	-	-		Bolt, Bolt R-SPEC	'14-'17	YTZ14S	-	-	-

FA Must use factory activated battery

\* See Battery Cross Reference Chart on page 14



# UTV (SIDE-BY-SIDES) APPLICATIONS

CC	Model	Year	High Performance AGM	AGM	Yumicron	Conventional	CC	Model	Year	High Performance AGM	AGM	Yumicron	Conventional
<b>ARCTIC CAT</b>							<b>KYMCO</b>						
1000	Prowler 1000	'16-'17	–	Y1X30L-BS*	–	–		Mule 4010 Trans4x4, Diesel, Mule 4000	'09-'16	Not available	–	–	–
	Wildcat 1000, X, 4, LTD	'16-'17	–	Y1X30L-BS	–	–	540	KAF540, Mule 2010, 2020, 2030		Y1X20HL-BS-PW*	–	YB16CL-B	–
700	Prowler 700	'09	Y1X24HL-BS	–	–	–	450	KAF450, Mule 1000		Y1X20HL-BS-PW*	–	YB16CL-B	–
	Prowler 700	'10-'17	–	Y1X30L-BS*	YB30L-B	–	400	KAF400, Mule 600, 610	'05-'16	Y1X14AH-BS*	–	YB14A-A2	–
	HDX	'11-'17	–	Y1X30L-BS*	–	–	300	KAF300, Mule 500, 520, 550		Y1X14AH-BS*	–	YB14A-A2	–
	Wildcat Sport, Trail	'16-'17	–	Y1X30L-BS*	–	–	<b>POLARIS</b>						
650	Prowler 650	'06-'09	Y1X24HL-BS*	–	Y50-N18L-A-CX	–	1000	RZR XP 1000, TURBO 4	'14-'17	Not available	–	–	–
550	Prowler 550	'09	Y1X24HL-BS*	–	–	–		Ranger General	'16-'17	Not available	–	–	–
	Prowler 550	'10-'15	–	Y1X30L-BS*	YB30L-B	–		Ranger Diesel	'15-'17	Not available	–	–	–
500	Prowler 500	'17-	–	Y1X20L-BS	–	–	900	RZR	'11-'17	–	Y1X30L-BS	–	–
	HDX500 XT	'17-	–	Y1X30L-BS	–	–		Ranger Diesel	'11-'14	Not available	–	–	–
<b>BRP (Can-Am)</b>							<b>POLARIS</b>						
1000	Commander	'11-'17	Y1X20HL-FA*	Y1X20L-FA	–	–		Ranger XP	'13-'17	Not available	–	–	–
	Defender	'16-'17	Y1X20HL-FA*	Y1X20L-FA	–	–		Ranger Crew	'14-'17	Not available	–	–	–
	Defender XT	'16-'17	GYZ32HL	Y1X30L-BS	–	–	800	RZR	'08-'14	Y1X20HL-BS	–	–	–
	Maverick	'13-'17	Y1X20HL-FA*	Y1X20L-FA	–	–		RZR 4, RZR S 800	'10-'14	–	Y1X30L-BS	–	–
800	Commander	'11-'17	Y1X20HL-FA*	Y1X20L-FA	–	–		Ranger	'10-'14	–	Y1X30L-BS*	YB30L-B	–
	Defender	'16-'17	Y1X20HL-FA*	Y1X20L-FA	–	–		Ranger, 6x6	'14-'16	Not available	–	–	–
	Defender XT	'16-'17	GYZ32HL	Y1X30L-BS	–	–	700	Ranger 6x6, 4x4	'06-'10	–	Y1X30L-BS	–	–
<b>HONDA</b>							<b>SUZUKI</b>						
1000	Pioneer 1000	'16	GYZ16H	–	–	–	570	RZR 570	'12-'17	Y1X14AH-BS*	–	YB14-B2	–
700	MUV700 Big Red	'08-'13	Y1X14H-BS*	Y1X14-BS	–	–		RZR 570 EPS	'13-'17	GYZ32HL	Y1X30L-BS*	YB30L-B	–
	Pioneer 700	'15-'16	Y1X14H-BS*	Y1X14-BS	–	–		Ranger 4x4	'14-'16	Y1X14AH-BS*	–	YB14-B2	–
500	Pioneer 500	'15-'16	GYZ16H	–	–	–	500	Ranger 6x6, 4x4	'98-'04	–	Y1X30L-BS*	YB30L-B	–
<b>KAWASAKI</b>							<b>SUZUKI</b>						
950	KAF950, Mule 2510, 3010 Diesel	'10	Not available	–	–	–		Ranger 4x4	'04-'10	–	Y1X30L-BS*	YB30L-B	–
	Mule 4010 Diesel	'11-'13	Not available	–	–	–		Ranger 4x4	'11-'13	Y1X14AH-BS*	–	YB14-B2	–
820	Mule Pro FXT	'15-'16	Not available	–	–	–	425	Ranger 2x4	'02-'03	–	Y1X30L-BS*	YB30L-B	–
750	Teryx All Models (US)	'08-'16	Not available	–	–	–	400	Ranger 400	'11-'14	Y1X14AH-BS*	–	YB14-B2	–
	Teryx All Models (CN)	'08-'16	–	KMX14-BS*	–	–	170	RZR	'16-'17	–	Y1X12-BS	–	–
620	KAF620, Mule 3010 4x4 Advantage Classic	'03-'07	Y1X20HL-BS*	Y1X20L-BS	–	–	<b>YAMAHA</b>						
	KAF620, Mule 2500, 2510, 2520		Y1X-20HL-BS-PW*	–	YB16CL-B	–	620	QUV620F	'05	Y1X20HL-BS*	Y1X20L-BS	–	–
	KAF620, Mule 3000, 3010, 3020		Y1X20HL-BS*	Y1X20L-BS	–	–	<b>YAMAHA</b>						
	Mule 4000	'09-'16	Not available	–	–	–		Rhino	All	Not available	–	–	–
	KAF620F, Mule 4010 4x4 (US)	'09-'16	Not available	–	–	–	1000	YZ1000R	'16	Not available	–	–	–
	KAF620F, Mule 4010 4x4 (CN)	'09-'16	Y1X20HL-BS*	Y1X20L-BS	–	–	700	Viking	'14-'16	Not available	–	–	–
								Wolverine	'16	Not available	–	–	–

UTV  
SCOOTER

# SCOOTER APPLICATIONS

CC	Model	Year	High Performance AGM	AGM	Yumicron	Conventional	CC	Model	Year	High Performance AGM	AGM	Yumicron	Conventional
<b>APRILIA</b>							<b>HONDA</b>						
850	SRV850	'12-'13	Y1X14H-BS*	Y1X14-BS	–	–		Matrix R4-150	'12	–	Y1X9-BS	–	–
500	Scarabeo	'09-'13	–	Y1X12-BS	–	–	50	Beamer R4-150	'12	–	Y1X9-BS	–	–
300	Atlantic	'12	–	–	YB12AL-A	–		Beamer 50, Beamer III	'00-'12	Y1Z7S*	Y1X5L-BS	–	–
250	Sport City	'09-'13	–	Y1X12-BS	–	–		Matrix 50	'12	Y1Z7S*	Y1X5L-BS	–	–
200	Scarabeo	'09-'13	–	–	YB12AL-A	–		Sport 50	'12	–	Y1X7A-BS	–	–
150	Mojito	'09-'10	–	Y1X7L-BS	–	–	<b>HONDA</b>						
125	Sport City	'08-'13	–	–	YB9-B	–	600	FSC600 Silver Wing	'02-'15	Y1Z12S	–	–	–
100	Scarabeo ST	'09-'13	–	–	YB9-B	–	300	NSS300 Forza	'14-'16	Y1Z12S	–	–	–
50	SR50	'09-'15	–	–	YB9-B	–	250	CH250 Elite	'85-'90	–	Y1X12-BS	–	–
	Sport City	'08-'13	–	–	YB9-B	–		CN250 Helix	'93-'09	–	Y1X12-BS	–	–
<b>BMW</b>							<b>HONDA</b>						
650	C650 GT, Sport	'11-'16	GYZ16H	Y1X14-BS	–	–		CN250 Helix	'86-'87	–	Y1X12-BS	–	–
600	C600, Sport	'13-'16	GYZ16H	Y1X14-BS	–	–		NSS250 Reflex	'01-'09	Y1Z12S	–	–	–
	C600	'11-'12	Y1Z14S	–	–	–		PS250 Big Ruckus	'05-'08	Y1Z12S	–	–	–
<b>E-TON</b>							<b>HONDA</b>						
150	Sport 150	'12	–	Y1X7A-BS	–	–	150	CH150 Elite	'87	–	–	YB10L-B2	–
								CH150 Elite Deluxe	'85-'86	–	–	YB9-B	–
								SH150	'10-'12	–	Y1X7L-BS	–	–
								SH150	'13	Y1Z7S	–	–	–
								FES150		–	Y1R9-BS	–	–
								PCX150	'13	Y1Z7S	–	–	–

FA Must use factory activated battery  
K Available at Kawasaki dealers only

\* See Battery Cross Reference Chart on page 14

# SCOOTER APPLICATIONS

CC	Model	Year	High Performance AGM	AGM	Yumicron	Conventional	CC	Model	Year	High Performance AGM	AGM	Yumicron	Conventional
----	-------	------	----------------------	-----	----------	--------------	----	-------	------	----------------------	-----	----------	--------------

## HONDA

125	PCX150	'15-'17	YTZ8V	-	-	-
	CH125 Elite	'84	-	-	YB9-B	-
	FES125		-	YTR9-BS	-	-
	NH125 Aero	'84	-	-	YB5L-B	-
	Pantheon 125		-	YTR9-BS	-	-
	PCX125	'11	YTZ7S	-	-	-
	SH125	'10-'12	-	YTX7L-BS	-	-
	SH125	'13	YTZ7S	-	-	-
110	NHX110 Elite	'10-'13	-	YTX7L-BS	-	-
80	CH80 Elite	'93-'09	YTZ7S*	YTX5L-BS	-	-
	NH80 Aero	'85	YTZ7S*	YTX5L-BS	-	-
	NH80MD Aero	'83-'84	-	-	YB5L-B	-
50	CHF50 Metropolitan, II, SP	'02-'13	YTZ7S	-	-	-
	NB50 Aero	'85-'87	-	YTX4L-BS	-	-
	NB50M Aero	'83-'84	-	-	YB4L-B	-
	NCH50 Metropolitan	'13-'17	YTZ5S*	YTX4L-BS	-	-
	NN50MD Gyro	'84	-	-	YB4L-B	-
	NPS50, S Ruckus	'03-'17	YTZ7S	-	-	-
	NQ50 Spree, 50D SS	'86-'87	-	YTX4L-BS	-	-
	NQ50 Spree	'84-'85	-	-	YB4L-B	-
	P50 Little Honda	'67-'68	-	-	-	6N4-2A-4
	PA50I Moped, PA50II	'78-'83	-	-	-	6N4B-2A-5
	SA50 Elite LX, S, SR	'88-'01	-	YTX4L-BS	-	-
	SB50 (All)	'88-'90	-	YTX4L-BS	-	-
	SE50 Elite (All)	'87	-	YTX4L-BS	-	-
	TG50 Gyro S (All)	'85-'86	-	YTX4L-BS	-	-

## HYOSUNG

250	NS3-250	'09-'16	-	YTX9-BS	-	-
100	EZ100	All Years	YTZ7S*	YTX5L-BS	-	-
50	SB50 Super Cab, SD50 Sense, SF50 Prima, Rally, Sense	All Years	-	YTX4L-BS	-	-

## KYMCO

500	Xciting 500i	'09-'16	GYZ16H	YTX14-BS	-	-
400	Xciting 400i	'09	-	YTX12-BS	-	-
300	Downtown 300	'13	-	YT12A-BS	-	-
	People GT	'16	-	YT12A-BS	-	-
250	People 250	'09-'11	-	YTX12-BS	-	-
	Xciting 250i	'10-'11	-	YTX12-BS	-	-
200	People S 200	'11	-	YTX7A-BS	-	-
	People GT	'13	-	YT12A-BS	-	-
150	People S 150	'09-'13	-	YTX7A-BS	-	-
	Super 8 150	'09-'16	-	YTX7A-BS	-	-
125	People S 125	'09-'10	-	YTX7A-BS	-	-
	Agility 125	'16	YTZ7S*	YTX5L-BS	-	-
50	Super 8	'09-'16	-	YTX7A-BS	-	-
	Super 9	'09-'10	YTZ7S*	YTX5L-BS	-	-
	People	'09-'13	YTZ7S*	YTX5L-BS	-	-
	People S 50	'09-'10	-	YTX7A-BS	-	-
	Agility 50	'09-'16	-	YTX7A-BS	-	-

## PIAGGIO

500	MP3 500 / Sport ABS	'08-'16	GYZ16H	YTX14-BS	-	-
	BV500	'08-'13	GYZ16H	YTX14-BS	-	-
460	X9	'09	GYZ16H	YTX14-BS	-	-
400	MP3 400	'08-'13	GYZ16H	YTX14-BS	-	-
350	BV350 ABS	'13-'16	-	YTX12-BS	-	-
250	MP3 250	'08-'13	GYZ16H	YTX14-BS	-	-
	BV250	'08-'11	GYZ16H	YTX14-BS	-	-
150	FLY150	'09-'16	-	-	YB9-B	-
50	FLY 50	'09-'16	-	-	YB9-B	-
	Typhoon	'09-'16	-	-	YB9-B	-

## PIAGGIO - GILERA

500	Fuoco 500ie	'10-'13	YTX20CH-BS*	YTX16-BS	-	-
	Nexus 500ie	'10	YTX14AHL-BS*	-	YB14L-A2	-
300	Nexus 300ie	'10-'11	GYZ16H	YTX14-BS	-	-
200	Runner 200	'10-'12	-	YTX12-BS	-	-
125	Runner 125	'10-'12	GYZ16H	YTX14-BS	-	-
50	SP50	'10-'13	-	-	YB4L-B	-

## PIAGGIO - VESPA

946	Vespa 946	'13-'16	-	YTX12-BS	-	-
300	GTS300, GTV300	'10-'16	GYZ16H	YTX14-BS	-	-
250	GTS250	'10	GYZ16H	YTX14-BS	-	-
	GTV250	'10	GYZ16H	YTX14-BS	-	-
150	LX150	'07	-	-	YB9-B	-
	LX150 4T	'16	-	YTX12-BS	-	-
50	LX50	'10-'16	-	-	YB9-B	-

## SYM

250	RV250	'10-'12	-	YTX12-BS	-	-
200	HD200	'10-'13	-	YTX9-BS	-	-
125	HD125	'10-'11	-	YTX9-BS	-	-
	Fiddlel125	'10-'11	-	YTX7A-BS	-	-
50	Fiddlel50	'10-'12	-	YTX7A-BS	-	-
	SYMply50	'10-'11	-	YTX7A-BS	-	-
	MIO 50	'10-'13	-	YTX7A-BS	-	-
	JetEuro 50	'10-'12	YTZ7S	-	-	-
	RS50	'10	-	YTX4L-BS	-	-

## SUZUKI

650	AN650 Burgman	'03-'17	GYZ16H	YTX14-BS	-	-
400	AN400 Burgman	'03-'16	-	YTX9-BS	-	-
200	UH200A Burgman	'14-'17	-	YTX9-BS	-	-
50	F50, F50R	'71	-	-	-	6N4-2A
	FA50 Shuttle	'80-'91	-	-	-	6N2-2A-4
	FS50, FZ50	'79-'83	-	-	-	6N4-2A

## YAMAHA

530	T-MAX XP500F	'13-'16	YTZ12S	-	-	-
500	T-MAX XP500	'09-'13	YTZ10S	-	-	-
400	YP400 Majesty	'04-'14	-	YT9B-BS	-	-
250	Morphous	'06-'07	YTZ10S	-	-	-
	Maxam	'13	YTZ10S	-	-	-
200	XC200 Riva	'87-'91	-	-	YB10L-B2	-
180	XC180 Riva	'83-'85	-	-	YB10L-B	-
155	Smox	'15-'17	-	YT7B-BS	-	-
125	XC125 Riva	'85-'01	-	-	YB7C-A	-
	YJ125T Vino 125	'04-'09	-	YTX7A-BS	-	-
	Zuma 125	'09-'17	-	YT7B-BS	-	-
80	CV80 Riva	'83-'87	-	-	6YB11-2D	6N11-2D
50	CA50 Riva	'83-'86	-	-	6YB8L-B	-
	CE50 Riva Jog	'86-'87	-	-	YB4L-B	-
	CG50 Riva	'88-'91	-	-	YB4L-B	-
	CV50 Riva	'84	-	-	6YB8L-B	-
	CW50 Zuma	'89-'90	-	-	YB4L-B	-
	CW50 Zuma II	'97-'01	-	-	YB4L-B	-
	CY50 Riva Jog	'92-'01	-	YTX4L-BS	-	-
	SH50 Riva Razz	'87-'01	-	-	YB4L-B	-
	XC50 Vino Classic	'06-'17	YTZ7S*	YTX5L-BS	-	-
	XF50W (C3)	'07-'13	YTZ7S*	YTX5L-BS	-	-
	YW50A, F, FX Zuma	'02-'17	YTZ7S*	YTX5L-BS	-	-
	VOX	'13	YTZ7S*	YTX5L-BS	-	-
	JOG, ZR	'13	YTZ7S*	YTX5L-BS	-	-

\* See Battery Cross Reference Chart on page 14

FA Must use Factory Activated battery

# ATV (ALL TERRAIN VEHICLE) APPLICATIONS

CC	Model	Year	High Performance AGM	AGM	Yumicon	Conventional	CC	Model	Year	High Performance AGM	AGM	Yumicon	Conventional
<b>AEON (BENZA)</b>													
100	Cobra/CX-Sport 100	All	–	YTX4L-BS	–	–	680	TRX680FA Four Trax Rincon	'06-'17	YTX20HL-BS*	YTX20L-BS	–	–
90	Cobra/CX-Sport 90	All	–	YTX4L-BS	–	–	650	TRX650 FourTrax Rincon (Std.) (Optional * cold starting)	'03-'04	GYZ16H	YTX14-BS	–	–
50	Cobra/CX-Sport 50	All	–	YTX4L-BS	–	–	500	TRX500FA Fourtrax Rubicon TRX500FE, FM, TM Trax Foreman	'01-'11	YTX20HL-BS*	YTX20L-BS	–	–
<b>ARCTIC CAT</b>													
1000	Thundercat	'10	–	YTX20H-BS	–	–	450	TRX450 Fourtrax Foreman S, ES	'98-'04	GYZ16H	YTX14-BS	–	–
700	Mudpro 1000H2, TRV, 1000i GT, XT	'10-'17	–	YTX20H-BS	–	–	420	TRX420ER, TRX450R	'06-'13	YTX20H-BS	–	–	–
700	700 TRV, Mudpro, LTD, TBX, Diesel	'09-'17	–	YTX20H-BS	–	–	420	TRX420 Fourtrax Rancher 4x4	'13	GYZ16H*	YTX14-BS	–	–
650	4x4 Automatic	'04-'06	–	YTX14AH-BS*	–	YB14-A2	400	TRX400 Rancher AT	'89-'90	GYZ16H	YTX14-BS	–	–
550	550, TRV, LTD, S, XT, CORE	'10-'15	–	YTX20H-BS	–	–	350	FL350R Odyssey	'85	–	YTX12-BS	–	–
500	All Other Models	'09	–	YTX14AH-BS*	–	YB14-A2	300	TRX300 Fourtrax	'88-'00	GYZ16H	YTX14-BS	–	–
450	XC450, TRV, CORE	'11-'17	–	YTX20H-BS	–	–	250	ATC250ES Big Red	'85-'87	–	YTX12-BS	–	–
400	All Models	All	–	YTX14AH-BS*	–	YB14-A2	200	ATC200M	'84-'85	YTX14AH-BS*	–	YB14A-A2	–
366	366	'08-'12	–	YTX14AH-BS*	–	YB14-A2	90	TRX90X, EX	'06-'17	YTX14AH-BS*	–	YB14A-A2	–
300	DXV300, Utility	'09-'14	–	YTX12-BS	–	–	125	ATC125M	'86-'87	–	YTX12-BS	–	–
250	All Models	All	–	YTX14AHL-BS*	–	YB14L-A2	90	ATC90X, EX	'06-'17	YTX14AH-BS*	–	YB14A-A2	–
150	150	'17	–	YTX9-BS	–	–	450	TE450S	'13	–	YTX9-BS	–	–
90	All Models	'06	–	YTX4L-BS	–	–	<b>HYOSUNG</b>						
90	90, 90 Utility	'16-'17	–	YTX5L-BS	–	–	<b>JOHN DEERE</b>						
50	DXV50	'06-'10	–	YTX5L-BS	–	–	<b>KASEA</b>						
<b>BRP (Can-Am)</b>													
1000	Outlander 1000, Renegade, 6x6	'12-'17	–	YTX20HL-*FA	YTX20L-*FA	–	<b>KAWASAKI</b>						
850	Outlander, Renegade	'16-'17	–	YTX20HL-BS*	YTX20L-BS	–	750	KVF750 Brute Force	'05-'17	GYZ16H	KMX14-BS*	–	–
800	Outlander 800 EFI, MAX, Renegade	'06-'13	–	YTX20HL-BS*	YTX20L-BS	–	700	KVF650-A, B, D Prairie 700, 4x4	'04-'06	GYZ16H	KMX14-BS*	–	–
660	Outlander 660 EFI	'06	–	YTX20HL-BS*	YTX20L-BS	–	650	KVF650 Brute Force	'02-'13	GYZ16H	KMX14-BS*	–	–
650	DS650	'00-'06	–	YTX15L-BS	–	–	450	KFX450R	'08-'14	GYZ16H	YTX7L-BS	–	–
	Quest	'02-'05	–	YTX20HL-BS-PW*	–	YB16CL-B	400	KLF400-B Bayou 400 4x4	'93-'00	YTX20HL-BS-PW*	–	YB16CL-B	–
	Quest (Opt)	'02-'05	–	YTX24HL-BS*	–	Y50-N18L-A-CX*	50-N18L-A	400	KSF400-A (KFX400)	'03-'06	YTX9-BS	–	–
570	Outlander, Renegade	'16-'17	–	YTX20HL-BS*	YTX20L-BS	–	400	KVF400-A Prairie 400 4x4	'97-'00	YTX14AH-BS*	–	YB14A-A2	–
500	Traxter (All Models), Quest	'99-'05	–	YTX20HL-BS-PW*	–	Y50-N18L-A-CX*	50-N18L-A	400	KVF400-A Prairie 400 4x4 (CN)	'97-'00	YTX20HL-BS-PW*	–	YB16CL-B
	Traxter (All Models), Quest (Opt)	'02-'05	–	YTX24HL-BS*	–	Y50-N18L-A-CX*	50-N18L-A	400	KVF400-B Prairie 400 4x4	'98-'00	YTX14AH-BS*	–	YB14A-A2
450	DS450	'15	–	YTX20HL-BS*	YTX20L-BS	–	<b>AEON (BENZA)</b>						
	Outlander	'16-'17	–	YTX20HL-BS*	YTX20L-BS	–	<b>ARCTIC CAT</b>						
400	Outlander 400	'03-'04	–	YTX15L-BS	–	–	<b>BRP (Can-Am)</b>						
	Outlander 400, XT, MAX	'04-'15	–	YTX20HL-BS*	YTX20L-BS	–	<b>E-TON</b>						
330	Outlander 330	'04-'05	–	YTX15L-BS	–	–	<b>HONDA</b>						
250	DS250	'06-'17	–	YTX12-BS	–	–	<b>AEON (BENZA)</b>						
200	Rally	'02-'06	–	YTX14AH-BS*	–	YB14A-A2	<b>ARCTIC CAT</b>						
90	DS90, DS90F, Quest	'02-'17	–	YTX4L-BS	–	–	<b>BRP (Can-Am)</b>						
70	DS70	'17	–	YTX4L-BS	–	–	<b>E-TON</b>						
50	DS50, Quest	'02-'06	–	YTX4L-BS	–	–	<b>HONDA</b>						
<b>E-TON</b>													
250	Vector250	'13	–	YTX12-BS	–	–	<b>AEON (BENZA)</b>						
150	CXL150 Yukon II	'00-'13	–	YTX9-BS	–	–	<b>ARCTIC CAT</b>						
	YXL150 Yukon	'00-'03	–	YTX9-BS	–	–	<b>BRP (Can-Am)</b>						
	Viper150R	'13	–	YTX9-BS	–	–	<b>E-TON</b>						
90	All models	'04-'13	–	YTX5L-BS	–	–	<b>HONDA</b>						
	AXL, TXL, NXL, RXL	'99-'03	–	YTX4L-BS	–	–	<b>AEON (BENZA)</b>						
	DXL90 Sierra	'99-'03	–	YTX4L-BS	–	–	<b>ARCTIC CAT</b>						
70	Viper 70	'13	–	YTX5L-BS	–	–	<b>BRP (Can-Am)</b>						
50	All models	'04-'05	–	YTX5L-BS	–	–	<b>E-TON</b>						
	AXL, TXL, NXL, RXL	'99-'03	–	YTX4L-BS	–	–	<b>HONDA</b>						
700	TRX700XX	'08-'13	–	YTX9-BS	–	–	<b>AEON (BENZA)</b>						
<b>HONDA</b>													

\* FA Must use factory activated battery

\* See Battery Cross Reference Chart on page 14



# ATV (ALL TERRAIN VEHICLE) APPLICATIONS

CC	Model	Year	High Performance AGM	AGM	Yumicron	Conventional	CC	Model	Year	High Performance AGM	AGM	Yumicron	Conventional
<b>YAMAHA</b>													
700	YFM7FG Grizzly	'07-'17	YTX20HL-BS*	YTX20L-BS	-	-		YFM35R Raptor	'04-'13	YTZ10S	-	-	-
	Raptor 700, R, R SE	'06-'17	-	YT9B-BS	-	-		YFM35U Big Bear	'87-'99	YTX14AH-BS*	-	YB14A-A1	-
	Kodiak 700, EPS	'16-'17	YTX20HL-BS*	YTX20L-BS	-	-		YFM35X Warrior	'87-'03	-	-	YB12C-A	-
660	YFM66FA Grizzly	'02-'08	YTX20HL-BS*	YTX20L-BS	-	-		YFP35 TerraPro	'88	YTX14AH-BS*	-	YB14A-A1	-
	YFM66R Raptor	'01-'05	YTX14H-BS*	YTX14-BS	-	-	300	Grizzly 300 Automatic	'11-'13	-	YTX12-BS	-	-
600	YFM600FW Grizzly	'98-'01	YTX20HL-BS*	YTX20L-BS	-	-	250	YFB250, F Timber Wolf	'92-'00	-	-	YB12C-A	-
	YFM600FW Grizzly	'98-'01	YTX20HL-BS*	YTX20L-BS	-	-		YFM25 Bear Tracker	'99-'04	YTX14AH-BS*	-	YB14A-A2	-
550	YMF5FG Grizzly	'14	YTX20HL-BS*	YTX20L-BS	-	-		YFM250 Moto 4	'89-'91	YTX14AH-BS*	-	YB14A-A1	-
450	YFM45FG Grizzly	'07-'14	YTX20HL-BS*	YTX20L-BS	-	-		YFM25B Big Bear	'07-'10	YTX14AH-BS*	-	YB14A-A2	-
	YFM45FX Wolverine	'03-'10	YTX20HL-BS*	YTX20L-BS	-	-		YFM25B Bruin	'05-'06	YTX14AH-BS*	-	YB14A-A2	-
	YFZ450	'04-'13	-	YT7B-BS	-	-		YFM25R Raptor, R	'08-'13	YTZ7S	-	-	-
	YFZ450X	'08	-	YT7B-BS	-	-	230	YFU-1/T Pro-Hauler	'89	YTX14AH-BS*	-	YB14A-A1	-
	YFZ450R, X	'09-'17	YTZ7S	-	-	-	225	YFM225 Moto 4	'86-'88	YTX14AH-BS*	-	YB14A-A1	-
400	YFM40FB Big Bear	'00-'12	YTX20HL-BS*	YTX20L-BS	-	-		YTM225DR, DX Tri-Moto	'83-'86	YTX14AH-BS*	-	YB14A-A1	-
	YFM40FG Grizzly	'07-'08	YTX14AH-BS	-	-	-	200	YFM200, DX Moto 4	'85-'89	YTX14AH-BS*	-	YB14A-A1	-
	YFM40FW Kodiak	'93-'95	YTX14AH-BS	-	YB14A-A1	-		YTM200, E, ER Tri Moto	'83-'85	YTX14AH-BS*	-	YB14A-A1	-
	YFM40FW Kodiak/Automatic	'03-'06	YTX14AH-BS	-	-	-	125	YFA-1 Breeze	'89-'04	-	-	YB12C-A	-
	YFM40FW Kodiak/Automatic	'96-'02	YTX20HL-BS*	YTX20L-BS	-	-		YFM125S, Grizzly	'04-'13	-	-	YB12C-A	-
	YFM40FWN Big Bear	'00-'03	YTX20HL-BS*	YTX20L-BS	-	-	100	YFM100 Champ	'87-'91	-	-	-	12N7D-3B
350	YFM35B Bruin	'04-'06	YTX14AH-BS	-	-	-	90	YFM90R Raptor	'09-'17	YTZ7S*	YTX5L-BS	-	-
	YFM35ER Moto 4	'87-'95	YTX14AH-BS*	-	YB14A-A1	-	80	YFM80 Badger	'85-'01	-	-	-	12N7D-3B
	YFM35F, U Big Bear	'87-'99	YTX14AH-BS*	-	YB14A-A1	-		YFM80 Grizzly	'05-'08	-	-	-	12N7D-3B
	YFM35FX Wolverine	'95-'05	-	-	YB12C-A	-		YFM80R Raptor	'02-'08	-	-	-	12N7D-3B
	YFM35FX Wolverine	'06-'10	YTX14AH-BS	-	-	-	50	YFM50 Raptor	'04-'09	-	-	-	12N7D-3B
	YFM35FG Grizzly	'07-'14	YTX14AH-BS	-	-	-		YFZ50	'17-	YTZ7S*	YTX5L-BS	-	-

# PWC (PERSONAL WATERCRAFT) APPLICATIONS

CC	Model	Year	High Performance AGM	AGM	Yumicron	Conventional	CC	Model	Year	High Performance AGM	AGM	Yumicron	Conventional	
<b>AQUA-JET CO.</b>														
432	Aqua-Jet Sx1	'89-'90	-	-	YB16-B	-		JH750 SS, ST, Xi, XIR	'92-'99	YTX20HL-BS-PW*	-	YB16CL-B	-	
430	Aqua-Jet SX1	'91	-	-	YB16-B	-		JH750 ST, Zxi	'95-'97	YTX20HL-BS*	YTX20L-BS	-	-	
<b>ARCTIC CAT</b>														
770	Tiger Shark	'97-'99	YTX14AH-BS*	-	YB14L-A2	-		JH750 SX, ZX	'92-'95	YTX20HL-BS-PW*	-	YB16CL-B	-	
640	Tiger Shark	'97-'99	YTX14AH-BS*	-	YB14L-A2	-		JS750 SX, ZX	'92-'95	YTX20HL-BS-PW*	-	YB16CL-B	-	
	Tiger Shark	'93-'96	-	-	YB16C-B	-		JS750 SXi, SXi Pro	'95-'02	YTX20HL-BS*	YTX20L-BS	-	-	
<b>BRP (SEA-DOO)</b>														
1500	GTI, GTR, GTS, GTX, RXT, RXP, WAKE	'16-'17	GVZ20HL	YTX20L	-	-		J750 STX, STX	'96-'98	YTX20HL-BS*	YTX20L-BS	-	-	
	GTX 4-Tec, RXP	'03-'07	-	YIX30L-BS-PW	YB30CL-B	-	650	JF650 TS	'89-'96	YTX20HL-BS-PW*	-	YB16CL-B	-	
	All Models	'88-'93	YTX20HL-BS*	YTX20L-BS*	YB16L-B	-		JF650 X2	'86-'95	YTX20HL-BS-PW*	-	YB16CL-B	-	
900	SPARK	'14-'17	GVZ20HL	YTX20L	-	-		JL650 SC	'91-'95	YTX20HL-BS-PW*	-	YB16CL-B	-	
780	3D	'07	YTX20HL-BS-PW*	-	YB16CL-B	-		JS650 SX	'87-'95	YTX20HL-BS-PW*	-	YB16CL-B	-	
<b>HONDA</b>														
1470	AquaTrax F-15, F-15X	'03-'13	YTX20HL-BS*	YTX20L-BS	-	-	550	JS550	'82-'85	YTX20HL-BS*	YTX20L-BS*	YB16L-B	-	
1235	AquaTrax F/R-12, F/R-12X	'02-'09	YTX20HL-BS*	YTX20L-BS	-	-		JS550, SX	'86-'95	YTX20HL-BS-PW*	-	YB16CL-B	-	
<b>KAWASAKI (JET SKI)</b>														
1500	JT1500-A, STX, STX-15F	'04-'13	YTX20HL-BS*	YTX20L-BS	-	-	440	JS440	'87-'92	YTX20HL-BS-PW*	-	YB16CL-B	-	
	JT1500-B, C, 250X, Ultra LX, 260LX, 300LX	'07-'17	YTX20HL-BS*	YTX20L-BS	-	-		JS440	'77-'86	YTX20HL-BS*	YTX20L-BS*	YB16L-B	-	
1200	JH1200-A, B Ultra 150	'99-'05	YTX20HL-BS*	YTX20L-BS	-	-	400	JS400	'76	YTX20HL-BS*	YTX20L-BS*	YB16L-B	-	
	JT1200-A-B, C, STX-R, STX-12F	'02-'07	YTX20HL-BS*	YTX20L-BS	-	-	300	JS300 TS, SX	'86-'91	YTX20HL-BS-PW*	-	YB16CL-B	-	
1100	JH1100 Zxi	'96-'03	YTX20HL-BS*	YTX20L-BS	-	-	<b>POLARIS</b>							
	JH1100-B Ultra 130	'01-'04	YTX20HL-BS*	YTX20L-BS	-	-	All	All Models	All	YTX20HL-BS-PW*	-	YB16CL-B	-	
	JT1100 STX	'97-'03	YTX20HL-BS*	YTX20L-BS	-	-	<b>S.O.S. MARINE MFG</b>							
900	JH900 Zxi	'95-'97	YTX20HL-BS*	YTX20L-BS	-	-	All	All Models	All	YTX20H-BS*	YTX20-BS*	YB16-B-CX*	YB16-B	
	JT900 STS, STX	'97-'05	YTX20HL-BS*	YTX20L-BS	-	-	<b>ULTRANAUTICS</b>							
800	JS800 SX-R	'03-'13	YTX20HL-BS*	YTX20L-BS	-	-	1250	Jet Star1250 (Boat)	'88-'90	-	-	53030	-	
750	JH750 B1-b3	'93-'95	YTX20HL-BS-PW*	-	YB16CL-B	-		Jet Star1260 (Boat)	'91	-	-	53030	-	
	JH750 E1,F2,G1,G2	'95-'99	YTX20HL-BS*	YTX20L-BS	-	-	800	All Models	'87-'92	-	-	53030	-	
								Wet Bike	'85-'86	-	-	-	YHD-12H	
<b>WET JET INTERNATIONAL</b>														
All	All Models	All	YTX20H-BS*	YTX20-BS*	YB16-B-CX*	YB16-B	<b>YAMAHA</b>							
<b>YAMAHA</b>														
1800	FX, FZR, FZS, VXS, VXR	'09-'17	YTX20HL-BS-PW*	-	YB16CL-B	-		1800	FX, FZR, FZS, VXS, VXR	'09-'17	YTX20HL-BS-PW*	-	YB16CL-B	-
1100	VX, V1	'09-'17	YTX20HL-BS-PW*	-	YB16CL-B	-		1100	VX, V1	'09-'17	YTX20HL-BS-PW*	-	YB16CL-B	-
1049	EX	'17	YTX20HL-BS-PW*	-	YB16CL-B	-		1049	EX	'17	YTX20HL-BS-PW*	-	YB16CL-B	-
700	Superjet	'09-'17	YTX20HL-BS-PW*	-	YB16CL-B	-		700	Superjet	'09-'17	YTX20HL-BS-PW*	-	YB16CL-B	-
All	All Wave Runner Models	'87-'08	YTX20HL-BS-PW*	-	YB16CL-B	-		All	All Wave Runner Models	'87-'08	YTX20HL-BS-PW*	-	YB16CL-B	-

\* See Battery Cross Reference Chart on page 14





CC	Model	Year	High Performance AGM	AGM	Yumicron	Conventional	CC	Model	Year	High Performance AGM	AGM	Yumicron	Conventional
<b>POLARIS</b>							973	Vector	'09	YTX20HL-BS*	YTX20L-BS	-	-
	Indy, Indy Trail	'84-'91	YTX24HL-BS*	-	Y50-N18L-A-CX*	Y50-N18L-A		Viking	'09	YTX20HL-BS*	YTX20L-BS	-	-
	Sprint (Electric Start)	'86-'90	-	-	Y60-N24-A	-		RS Viking Professional	'09-'14	YTX20HL-BS*	YTX20L-BS	-	-
800	Switchback, RMK	'10	YTX20HL-BS*	YTX20L-BS	-	-	700	SXV700ER SXViper ER	'02-'05	YTX24HL-BS*	-	Y50-N18L-A-CX*	Y50-N18L-A
	Rush, Switchback, RMK	'11-'17	YTX20CH	-	-	-		VT700 Venture 700	'98-'04	YTX24HL-BS*	-	Y50-N18L-A-CX*	Y50-N18L-A
	Indy	'14-'16	YTX20CH	-	-	-		VX700DX Vmax 700 Deluxe	'99-'00	YTX24HL-BS*	-	Y50-N18L-A-CX*	Y50-N18L-A
	SKS	'16	YTX20CH	-	-	-		VX700ER Vmax 700 ER	'01-'02	YTX24HL-BS*	-	Y50-N18L-A-CX*	Y50-N18L-A
750	FS/FST, Wide Track	'06-'10	YTX20HL-BS*	YTX20L-BS	-	-		VX700XTCD Vmax 700 XTC Deluxe	'98	YTX24HL-BS*	-	Y50-N18L-A-CX*	Y50-N18L-A
	Turbo Switchback, Turbo Dragon	'06-'10	YTX20HL-BS*	YTX20L-BS	-	-	600	VT600 Venture 600	'97-'98	-	-	YB16AL-A2	-
	Turbo LX, IQ	'08-'14	YTX20HL-BS*	YTX20L-BS	-	-		VT600 Venture 600	'99-'06	YTX24HL-BS*	-	Y50-N18L-A-CX*	Y50-N18L-A
	FS Wide Track	'10-'13	YX30L	-	-	-		VX600DX Vmax 600 Deluxe	'99-'01	YTX24HL-BS*	-	Y50-N18L-A-CX*	Y50-N18L-A
600	IQ Touring	'08	YTX14AH-BS	-	-	-		VX600E/DX Vmax 600 LE/DX	'94-'96	-	-	YB16AL-A2	-
	IQ, Shift, Switchback, RMK	'09-'11	YTX20HL-BS	-	-	-		VX600ER Vmax 600 ER	'02-'03	YTX24HL-BS*	-	Y50-N18L-A-CX*	Y50-N18L-A
	Shift, Switchback, RMK	'09-'10	YTX20HL-BS	YTX20L-BS	-	-		VX600XTC Vmax 600 XTC	'97-'98	-	-	YB16AL-A2	-
	Wide Track	'10-'16	-	YX30L-BS	-	-	570	EX570E Exciter	'88-'90	-	-	YB16AL-A2	-
	Rush	'10-'17	YTX20CH	-	-	-		EX570E Exciter II LE	'91-'93	-	-	YB16AL-A2	-
	Switchback, RMK	'12-'17	YTX20CH	-	-	-	540	EC540 Excel	'79-'80	YTX24HL-BS*	-	Y50-N18L-A-CX*	Y50-N18L-A
	Indy	'14-'17	YTX20CH	-	-	-		VX540E, II, III	'89-'03	-	-	YB16AL-A2	-
	Voyager	'14-'17	YTX20CH	-	-	-		XL540 XLV	'85-'90	-	-	YB16AL-A2	-
	Wide Track	'14-'17	YX30L	-	-	-	500	Phazer	'16-'17	YTX14H-BS*	YTX14-BS	-	-
550	IQ, LXT, Shift	'13	YTX20HL-BS	-	-	-		Venture Lite, MP, RS	'16-'17	YTX14H-BS*	YTX14-BS	-	-
	Indy, VOYAGEUR	'14-'17	YTX20CH	-	-	-		PZ500DX Phazer 500 Deluxe	'01	-	-	YB16AL-A2	-
	Adventure	'17	YTX20CH	-	-	-		VT500 Venture 500	'97-'01	-	-	YB16AL-A2	-
	Wide Track	'17	YTX20CH	-	-	-		VT500 Venture 500 XL	'99-'00	-	-	YB16AL-A2	-
544	Trail, Trail Touring	'09	YTX14AH-BS*	-	YB14A-A2	-		VX500E Vmax	'94-'01	-	-	YB16AL-A2	-
500	Wide Track	'89-'14	YTX24HL-BS*	-	Y50-N18L-A-CX*	Y50-N18L-A	480	PZ480E Phazer Deluxe	'84-'89	YTX14AHL-BS*	-	YB14L-A2*	12N14-3A
<b>YAMAHA</b>								PZ480E Phazer II LE, SS	'90-'98	YTX14AHL-BS*	-	YB14L-A2*	12N14-3A
1049	FX Nitro	'14	YTX20HL-BS*	YTX20L-BS	-	-		VT480 Venture GT	'92-'93	YTX14AHL-BS*	-	YB14L-A2*	12N14-3A
	RS Venture	'14	YTX20HL-BS*	YTX20L-BS	-	-		VT480 Venture XL	'91-'97	YTX14AHL-BS*	-	YB14L-A2*	12N14-3A
	RS Vector	'16-'17	YTX20HL-BS*	YTX20L-BS	-	-		VT480TR Venture TR Electric	'98	YTX14AHL-BS*	-	YB14L-A2*	12N14-3A
	SR Viper L/M/R/S/X	'14-'17	YTX20HL-BS	-	-	-	340	CS340 Ovation Deluxe/LE	'89-'98	YTX14AHL-BS*	-	YB14L-A2*	12N14-3A
	VK Professional II	'16-'17	YTX20HL-BS*	YTX20L-BS	-	-		EC340 Excel III	'81-'88	YTX14AHL-BS*	-	YB14L-A2*	12N14-3A
1000	Apex	'06-'17	YTX14H-BS*	YTX14-BS	-	-		ET340E Enticer	'79	YTX24HL-BS*	-	Y50-N18L-A-CX*	Y50-N18L-A
	RS1000S, GT, RS	'06-'14	YTX20HL-BS*	YTX20L-BS	-	-		ET340E Enticer	'80	YTX14AHL-BS*	-	YB14L-A2*	12N14-3A
	RX1000R RX (All Models)	'03-'05	YTX20HL-BS	YTX20L-BS	-	-	300	CF300 Inviter	'86-'90	-	-	YB16AL-A2	-
							125	SV125E Sno-Sport	'90-'91	YTX14AHL-BS*	-	YB14L-A2*	12N14-3A
							80	SV80E Sno-Scoot	'88-'90	-	-	YB7L-B*	12N7-3B

\* See Battery Cross Reference Chart on page 14

## 1 AMP Automatic Battery Charger & Maintainer

Part No. YUA1201000

- 3 color LED displays battery charge status at a glance
- Automatically switches when battery is fully charged to maintenance mode
- 5 year limited warranty



## 2 AMP Dual-bank Automatic Charger & Maintainer

Part No. YUA1202262

- 2 independent charging stations
- Charges 6 volt & 12 volt batteries
- Automatic charging and maintenance maximizes battery life
- OEM-approved 5-stage charging algorithm saves time and energy
- Active desulfation to recover sulfated batteries
- Defective battery detection to eliminate surprises
- 5 year limited warranty



## 3 AMP Automatic Battery Charger & Maintainer

Part No. YUA1203000

- Automatic charging and maintenance maximizes battery life
- OEM-approved 5-stage charging algorithm saves time and energy
- Active desulfation to recover sulfated batteries
- Defective battery detection to eliminate surprises
- 5 year limited warranty



## Battery Charger Leads

Part No. YUA00ACC04 - 18AWG Wire, 3 amp fuse

Part No. YUA00ACC05 - 16AWG Wire, 15 amp fuse

- For use with electrical accessories such as heated gear & GPS units
- Can be used with all of Yuasa's consumers chargers & maintainers



## Jumper Cables

Part No. YUA00ACC07

- Convenient storage bag included
- Heavy duty, 8 ft., 8-gauge cables won't stiffen or freeze
- Tangle resistant, encased rubber grips for safer use



## **MB-2040 Battery Charger**

Part No. YUA1202040

- High output charging current (max 4 amps)
- High voltage capable (max 20 volts) – designed to improve recovery of sulfated batteries
- Switchable Mode operation
  - “Quick Mode” – for fast vehicle setup
  - “Normal Mode” – ideal for smaller batteries, initial activation, and deeply discharged batteries
- Commercial grade – perfect for dealer/shop use
- Suitable for battery types – conventional and AGM
- Automatic shut-off to prevent overcharging
- Reverse polarity protection/spark-free operation (UL/CUL approved)

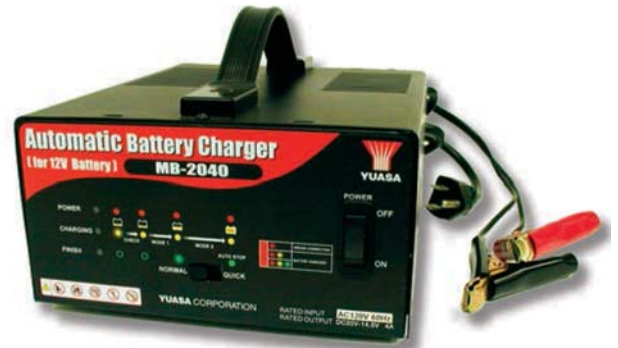

## **10-Bank Battery Maintainer**

Part No. YUA122500 - Battery Maintainer with 25 ft. leads

Part No. YUA00AC25F - 10 pack of 25 ft. leads

- Maintain up to 10 batteries at a time
- 5-stage maintenance/float charge
- Pre-qualification battery test
- Built-in timer for battery protection
- 250 mA per channel



## **Digital Battery Tester**

Part No. YUA00BTY01

- Developed exclusively for the powersports industry
- Determines battery health and charge status in seconds
- Single load, dynamic resistance technology minimizes battery drain during test
- Protective rubber boot and Amp Hr guide
- Tests both charged and discharged batteries accurately
- 250 mA per channel



## Large Display Rack

Part No. YUASARACK

- 37" wide x 62" high x 15" deep



## Small Display Rack

Part No. 60052

- 24" wide x 48" high x 10" deep

## Metal Sign / Lighted Sign

Part No. YUA-888 - Metal Sign

Part No. YUA-SIGN - Lighted Sign



## Counter Mat

Part No. YUA-016



## 3' x 5' Banner

Part No. YUA-001



## Counter Stools

Part No. YUA-999

