

RS415 INSTRUCTIONS

TO BE INSTALLED BY A CERTIFIED MECHANIC ONLY | FOR RACE USE ONLY



BRAKE SIDE EXPLODED VIEW

FOR: KAWASAKI ZX6R 2009-2010



PLEASE NOTE:
The adjustability of these rearsets will require that you install a longer hose between the rear brake master cylinder & fluid reservoir. Brake fluid hose is included in Kit. Once you decide on footpeg position hose length can be adjusted.

INDEX

-  Lubricate
-  Red Thread Lock
-  DO NOT Overtighten
-  Use Factory Piece

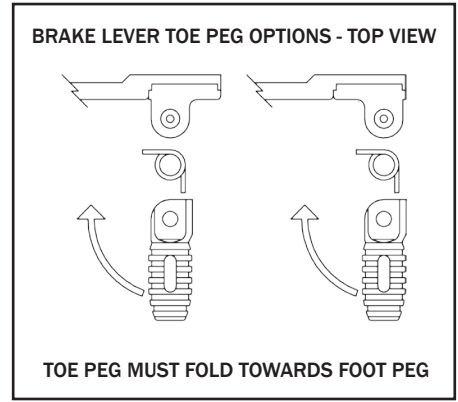
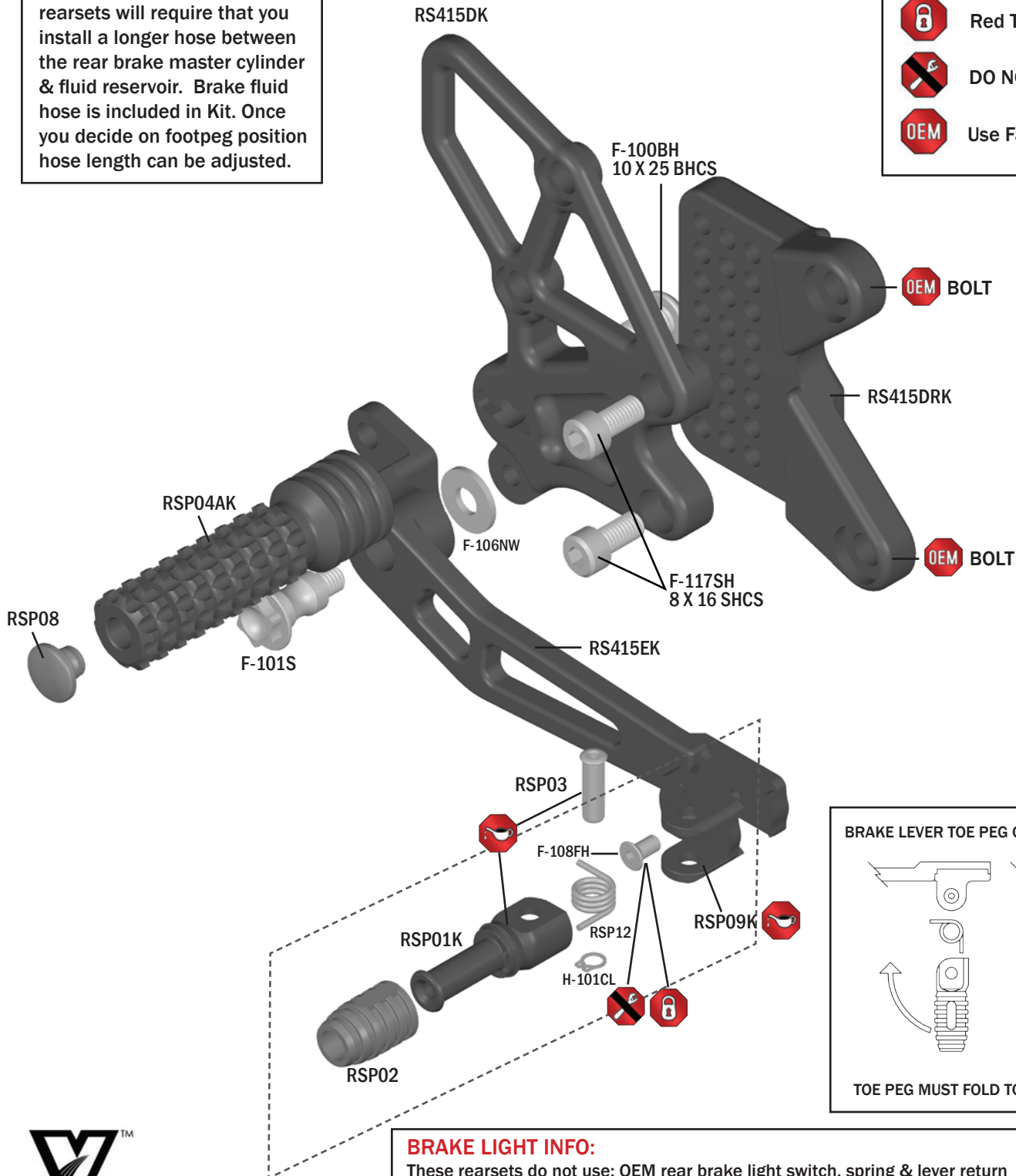

BRAKE LIGHT INFO:
These rearsets do not use: OEM rear brake light switch, spring & lever return spring. In race form these rear sets no longer activate rear brake light from rear brake lever. Street use requires rear brake light to be activated by rear & front brake levers. To achieve rear brake light activation from rear brake lever use Vortex in-line pressure switch RS100.



RS415 INSTRUCTIONS

TO BE INSTALLED BY A CERTIFIED MECHANIC ONLY | FOR RACE USE ONLY

SHIFT SIDE EXPLODED VIEW

FOR: KAWASAKI ZX6R 2009-2010

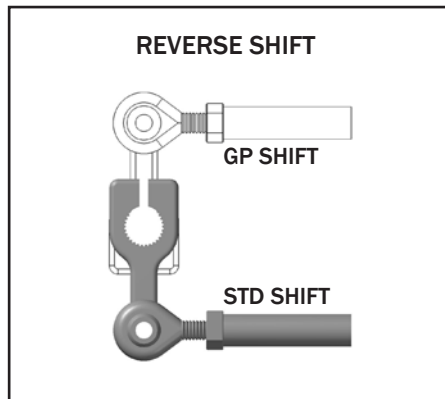

INDEX

- Lubricate
- Red Thread Lock
- DO NOT Overtighten
- Use Factory Piece

