





Truck-Lite User's Guides

These guides provide detailed training and education to help readers better understand harness and lighting concepts that are relevant to specific installations, as well as providing preventative maintenance techniques. Truck-Lite's Lighting and Harness User's Guides make for excellent training sources in a conveniently sized manual.

BASICS IN ELECTRICITY

- Definitions & Major Concepts
- Wire Calculations
- Useful Formulas

WHY LIGHTS FAIL

- Major Causes
- Tips For Longer Lasting Lighting Systems
- Chemical Impact On Lighting
- Product Pitfalls

STANDARDS AND SPECIFICATIONS

- Federal Requirements
- Proper Light Specification
- Common Legal Questions
- ID Codes
- Regulation Charts

EVOLUTION OF LIGHTING

- Lighting Evolution
- Introduction to [LED Lighting](#)
- Future of LEDs
- LED Lifetime Systems
- Systems Approach

SUPPORT TOOLS

- Laboratory Support
- Technical Support
- Industry Links

INDEX/ GLOSSARY

BASICS IN ELECTRICITY

SECTION OBJECTIVES

1. Definitions & Major Concepts
2. Wire Calculations
3. Useful Formulas

1. Definitions

A comparison between electrical energy and water flow will be useful in explaining and understanding electrical concepts, but remember — water and electricity generally should not be mixed.

1. VOLT (Potential) V

The unit of measurement applied to the difference in electrical potential between two points; that is, the potential for electricity to flow.

- Usually referenced from “ground.”
- In water, voltage is roughly equivalent to the difference in elevation from ground to a tank of water elevated above the ground; the electrical potential is similar to water pressure.
- The higher the potential (or elevation), the more force the water is able to exert and the more likely it is to flow.

2. AMP (Current) I

The unit of measurement applied to the flow of electrical current through a conductor.

- The amount of current (electrons) passing through a conductor or passing a point in a wire or other electrical devices such as a light bulb.

3. OHM (Resistance) $R\Omega$

As electrons flow through conductors, they meet opposition due to the collisions between the flowing electrons and the electrons and atoms of the conductor.

- This opposition to current flow, called resistance, is measured in **Ohms**.

4. WATT (Power) P, W or Pw

The unit of power applied to the rate at which energy is used.

- Power is the amount of work that can be accomplished in a specified amount of time.
- Work is simply defined as converting energy from one form to another, e.g., changing electrical energy into light energy.

5. WIRE SIZE (AWG)

Because everything electrical depends on current flow, the conductors that carry the electricity are a critical part of any electrical system. The size of wires is important to allow the proper flow of electrons.

- Resistance is opposition to current flow.
- Wires that are too small in diameter will oppose current flow (this opposition is due to collisions of electrons which do not have enough room to pass).
- These collisions convert electrical energy into heat (if enough of these collisions occur, the wire could overheat to the point of causing insulation melt-down and/or catch fire).
- Wire sizes are measured according to the American Wire Gauge (AWG).

6. VOLTAGE DROP Vd

Voltage drop occurs when power is dissipated across a component of the electrical system.

- In the case of a bulb or other lighting device, voltage is dropped in the production of light and heat.
- Typically, the more current that flows through a system, the higher the voltage drop will be.
- Voltage drop across a wire is undesirable, as it is an indication that power is being wasted and heat is being generated.

7. HORSEPOWER

To determine horsepower required to operate lighting equipment, calculate the total power requirements of all lamps (in watts). Then divide that total by a value of 746 (HP = P / 746).

QTY	LAMP TYPE	INCANDESCENT TOTAL AMPS	LED TOTAL AMPS
11	Clearance/Sidemarkers/Identification	3.63	0.66
1	Licence	0.33	0.06
2	Tail (minor function)	0.96	0.05
2	Rear Clearance (minor function)	0.96	0.05
2	Stop (major function)	4.20	0.61
2	Turn (major function)	4.20	0.61
		14.28	2.04

INCANDESCENT

$$P = V \times I$$

$$P = 12.8v \times 14.28a$$

$$P = 182.784 \text{ watts}$$

$$HP = P \div 746$$

$$HP = 182.784 \div 746$$

$$HP = 0.2450$$

LED

$$P = V \times I$$

$$P = 12.8v \times 2.04a$$

$$P = 26.112 \text{ watts}$$

$$HP = P \div 746$$

$$HP = 26.112 \div 746$$

$$HP = 0.0350$$

2. Wire Size Calculations

The length of wire in a circuit is a major contributing factor to voltage drop. The table below may be used to determine adequate wire gauge sizes for specific lengths of cable when the amperage (current) requirements are known.

- Everything electrical relies upon current flow.
- The conductor that carries the electricity is a critical part of the system.
- Wire size is vital to allow the proper flow of electrons (smaller diameter wire will oppose current flow).
- Constricting the room for electrons to pass within the wire causes collision of electrons, which generates heat inside the wire.

WIRE GAUGE REQUIREMENTS

TOTAL FOOTAGE OF WIRE FROM POWER SOURCE TO THE MOST DISTANT ELECTRIC LAMP

		TOTAL FOOTAGE OF WIRE FROM POWER SOURCE TO THE MOST DISTANT ELECTRIC LAMP									
		10'	20'	30'	40'	50'	60'	70'	80'	90'	100'
AMPERAGE REQUIRED	24v System	2.0	3.0	4.0	6.0	8.0	10.0	12.0	14.0	16.0	20.0
	12v System	1.0	1.5	2.0	3.0	4.0	5.0	6.0	7.0	8.0	10.0
		18	18	18	18	18	18	18	18	18	18
		18	18	18	18	18	18	18	18	18	18
		18	18	18	18	18	18	18	16	16	16
		18	18	18	18	18	16	16	16	14	14
		18	18	18	16	16	16	14	14	14	12
		18	18	18	16	14	14	14	12	12	12
		18	18	16	16	14	14	12	12	12	12
		18	18	16	14	14	12	12	12	10	10
		18	18	16	14	12	12	12	10	10	10
		18	16	14	12	12	12	10	10	10	10
		18	16	14	12	12	10	10	10	10	8
		18	16	14	12	12	10	10	10	8	8
		18	16	14	12	10	10	8	8	8	8
		16	14	12	10	10	8	8	8	8	8
	16	14	12	10	10	8	8	8	8	6	

* Values depict wire gauge

Wire Size Calculations continued on next page ->

Example: A lamp is 38' from the power source and required 10 amperes. This figure, rounded upwards to the nearest column heading given in the table is 40'. The wire gauge in the 40' column corresponding to 10 amperes is No. 12.*

*Recommended minimum wire gauge size for stop light and ground circuits.

	Stop (red)	Ground (white)
Single trailer up to 50' length	12 ga.	10 ga.
Double trailer 2-28' lengths	12 ga.	10 ga.
Doubles trailer 2-40' lengths	10 ga.	8 ga.
Triples trailer 3-28' lengths	10ga.	8 ga.

*Compiled from SAE, TMC & Other sources.

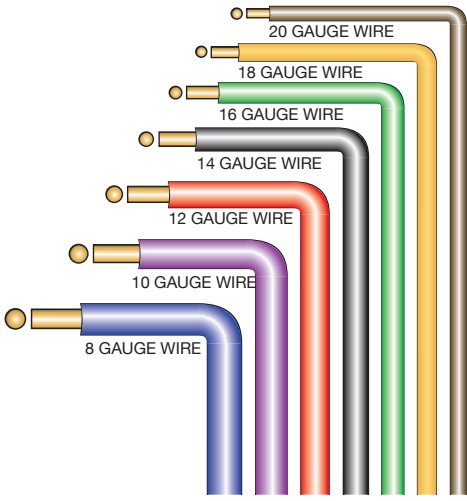
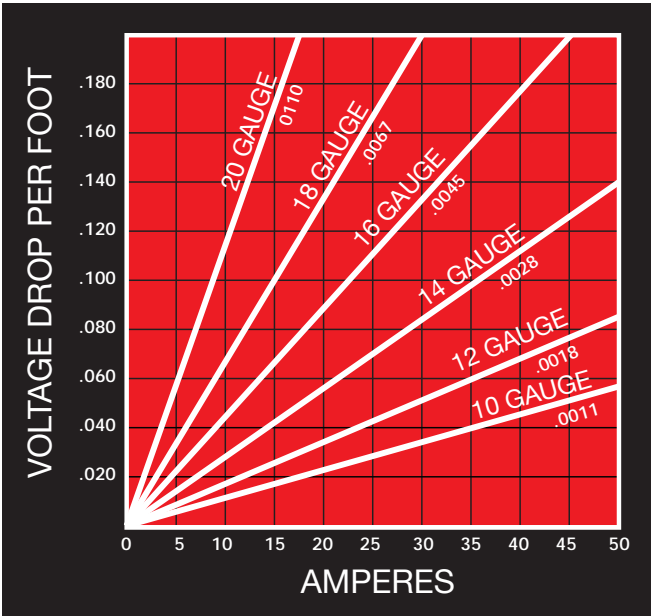

3. Useful Formulas

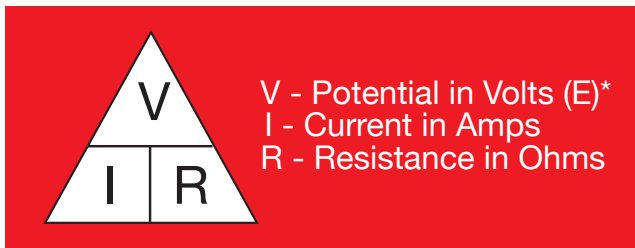

* E is the symbol for Electromotive Force in Volts, as defined in Ohms Law.

$$V = I \times R$$

Voltage (volts) = Current (amps) x Resistance (ohms)

$$I = \frac{V}{R}$$

Current (amps) = Voltage (volts) ÷ Resistance (ohms)

$$R = \frac{V}{I}$$

Resistance (ohms) = Voltage (volts) ÷ Current (amps)

Frequently stated as $E = I \times R$

Power can be represented as P, W, or Pw.

a) $Pw = V \times I$

Power (watts) = Voltage (volts) x Current (amps)

b) $Pw = I^2 \times R$

Power (watts) = Current (amps) x Current (amps) x Resistance (ohms)

c) $Pw = \frac{V^2}{R}$

Power (watts) = Voltage (volts) x Voltage (volts) ÷ Resistance (ohms)

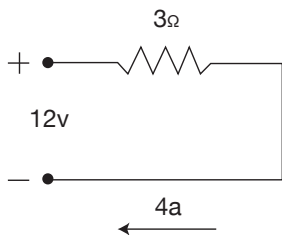

a) $P_w = V \times I$

$$P_w = 12 \times 4$$

$$P_w = 48w$$

b) $P_w = I^2 \times R$

$$P_w = 4 \times 4 \times 3$$

$$P_w = 48w$$

c) $P_w = \frac{V^2}{R}$

$$P_w = 12 \times 12 \div 3$$

$$P_w = 48w$$

WHY LIGHTS FAIL

SECTION OBJECTIVES

1. Major Causes of Failure
2. Tips For Longer Lasting Lighting Systems
3. Chemical Impact On Lighting
4. Product Pitfalls
5. Counterfeit Products

1. Major Causes Of Failure

Corrosion

Causes of Corrosion:

Water, dirt, salt, and any other road contaminants can enter a lamp or connector, providing an electrical path which can vastly accelerate corrosion.



Minimizing Corrosion:

Corrosion cannot occur when the bulb is sealed within the lamp housing, as they are in Truck-Lite's sealed lighting products.

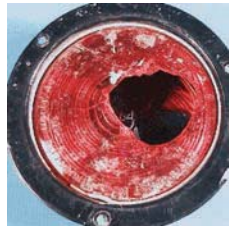

Further Protection:

Connectors should be sealed with non-conductive grease like electrical contacts, circuit switches, and junction boxes.



Purpose of Sealant:

To totally encapsulate the area to protect it from the elements.

Shock, Vibration, & Burnout

Major Causes of Shock & Vibration:

Trailers experience constant road pounding when they travel down a highway. This pounding can cause filaments in a bulb to distort and prematurely break.

In addition, shock and impact damage can be caused by things other than road vibration. Some examples are:

- Loading a container chassis on to a truck chassis
- Dump truck loading or tailgate banging
- Loose mounting of cargo hardware
- Unloading operations
- Impact with stationary objects, e.g., poles or loading docks

Solution To Shock & Vibration:

Install a lamp designed with shock-mounted mechanisms that cradle the bulb and absorb the effects of shock and vibration that would otherwise be transferred directly to fragile bulb filaments or LED lamps.

Baseless Bulbs:

Suspended to endure heavy-duty applications better than traditional S-8 non-shock mounted bulb units or standard J-slot bulb sockets.

Advanced Technology - LEDs:

LEDs are rated at 100,000 hours of operation. They are solid state, which makes them much less susceptible to shock and vibration. The electronics of LEDs are completely sealed in epoxy.

Inadequate Wiring & Cable

Suitable Wiring:

Wire size or gauge is very important; the use of a wire gauge too small can cause dim or intermittent operation or excessive voltage drop and presents a potential fire hazard.

Avoiding Excessive Voltage Fluctuation:

Suitable wiring can increase product life and safety. A sealed, waterproof wiring harness system based on electrical load of the vehicle should be selected.

Stranded copper wire should be used. Copper wire has a higher current carrying capability than an aluminum wire of the same size. It is also more flexible and less likely to break.

Truck Light Offers Harness Systems That:

- Exceed industry standards
- Eliminate troublesome splices
- Seal out the elements
- Provide a common ground
- Last the life of the trailer

Excess Voltage

Excess voltage is a difficult problem for bulb life. Many failures caused by voltage spikes are a result of load dumps (such as starting the engine with the lights on). Other sources of excessive voltage are heavy draw electrical devices such as lift gates or welders. When the units are turned off, they can create a backlash in the form of a voltage spike.

Voltage regulators that are set too high can shorten the life of a bulb, as can disconnecting the battery while the truck is in operation.

A good way to protect the lights from voltage damage is to not use heavy draw accessories or start the vehicle when the lights are on.

Voltage should be checked regularly to ensure the vehicle is operating within a safe range. One volt beyond the designed voltage will reduce the expected life of a bulb filament by more than 50 percent. LED systems eliminate this problem.

Poor Grounding

Installing a lighting product and harness system that uses an internal ground will help maintain an absolute ground because it does not depend on the chassis ground. Internal grounds will also help eliminate rust and corrosion associated with chassis grounding.

Loss of Bulb Contact

In the traditional non-shock mounting bulb units and the standard J-slot bulb sockets, corrosion and/or loss of spring tension could cause a loss of contact. With the inception of the sealed, baseless bulb lamp and soldered connections, bulb contact is certain and product life is further enhanced. Again, LED systems solve this problem.

Physical Damage

To help prevent physical damage, the lens should be a super-tough, high-impact plastic that is impervious to heat generated by the bulb.

The lens and the lamp housing should both be manufactured from a tough, durable plastic, such as polycarbonate.



The 21st Century Lighting System

Studies have shown that, when sealed shock-mounted bulbs and lighting devices are used along with sealed wiring harness systems, product life can be extended as much as 20 times beyond traditional unsealed bulb units in heavy-duty and tractor/trailer applications.

It should be everyone's goal to use an original equipment part that lasts the life of the vehicle, or requires little attention and minor cost after the initial purchase. Today's technology is capable of designing and producing lighting products that can offer 500,000 to 1,000,000 miles of maintenance-free service for most applications.

Product life performance can be extended and overall costs of vehicle operations can be reduced by doing a careful evaluation of the total vehicle lighting system, its problems, and the methods used to control and eliminate those problems.



2. Tips For A Lasting System

1. If at all possible, test probes should not be used to puncture insulation while troubleshooting lighting failure. If it becomes necessary, the hole from the probe must be resealed. If the hole is not sealed, wicking action can cause moisture to travel considerable distances inside the wire, resulting in corrosion that has the potential to destroy the circuit.

When correcting illumination problems, don't simply turn up the voltage output. Find the sources that caused the failure to prevent more (and probably more serious) problems. Over-voltage can quickly kill both lamps and batteries. To prevent the loss of current carrying capability, always replace trailer light cords with the same, or better quality and gauge of wiring.

2. Under-voltage is often caused by poor electrical connections. To correct this problem, don't simply turn up the voltage — find out the root of the problem for efficient operation.

3. Do not immediately throw away lamps if they aren't burning. It is important to play detective when solving lamp problems; determine that another source isn't the cause of your lamp failure. Testing the lamp with a meter, power supply, or battery can help determine the lamp's cause of failure. The following are common causes of lamp failure:

- a bulb with stretched or broken filaments most likely failed due to vibration
- a yellowish, whitish, or bluish glaze on the bulb indicates a rupture in the bulb's glass envelope
- a dark, metallic finish indicates old age
- a black, sooty bulb indicates a poor seal in the bulb

4. Treat the electrical system like you treat the chassis. Lubricate sockets, pigtails, battery terminals and connections with NYK-77 nonconductive anti-corrosion compound. The purpose of the sealant is to completely encapsulate and protect the electronics from corrosion and other types of water damage. Any type of corrosion preventive compound, such as grease, may be used, as long as it is not carbon based.

5. Inspect the electrical system for proper ground connections. This is a major cause of lamp failure, especially when the trailer is used for a ground. When the lamps are grounded through the lamp housing, make sure there is a clean connection (that is, metal to metal). A fifth wheel ground strap may be used for added protection on the chassis ground system.

6. Loose, bare, or unsupported wires or fixtures should be addressed immediately. Harness and wiring should be on the underside of the top frame members, rather than on the bottom where dirt and road splash connect.

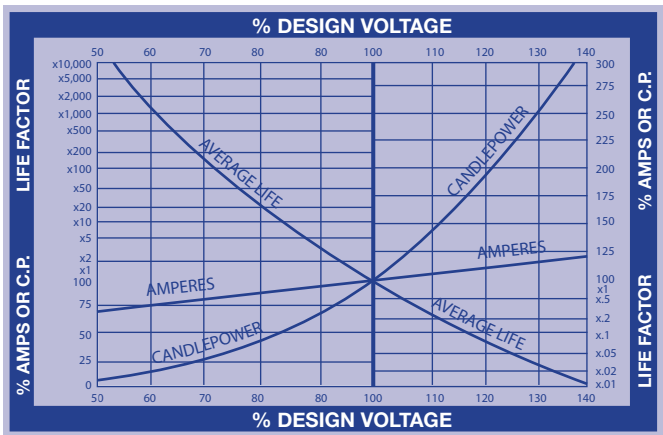

7. Heat is a major contributor to lamp problems. Lamps must “breathe” or the heat buildup will shorten a lamp’s lifespan. LED lamps have a lower power draw, which can alleviate many heat problems. However, even a

cooler LED lamp can overheat if the lens is covered in dirt. Keep your lamps clean and they will perform better in the resulting cooler environment.

8. There are many household cleaning products that are not compatible with polycarbonate lenses and housing.

The following solvents/cleaners MUST NOT BE USED with polycarbonate:		
Trichlor	Carbon Tetrachloride	Diversol [®]
Acetone	Chlorinated Hydrocarbons	Lemon Joy [®] (phosphate free)
Triclene [®]	Texize-8006, 8129, 8758	Kleenol Plastics
Methyl Ethyl Keytone (MEK)	Liquid Cleaner - 8211	Lestoil [®]
MIBK	Agitene [®]	Lysol [®]
Toluol	Ajax [®]	Stanisol Naphtha [®]
Benzol	All Liquid Detergents	Oils
Gasoline	Pink Lux [®] (phosphate free)	
The following solvents/cleaners are compatible with polycarbonate:		
Mild soap and water	10% Sol Bon Ami [®]	
Mineral Spirits	Dirtex [®]	
Hexane	2% Sol. Reg. Joy	
VM & P Naphtha	Heptane	
Varsol No. 2	White Kerosene	
#1 & #3 denatured alcohol	Methyl, isopropyl & isobutyl alcohols	
Freone TF & TE-35	Lacryl [®] PCL-2035 polycarbonate cleaner	
Ethanol	Petroleum Ether/65 degrees C boiling point	
<i>Questions as to compatibility of other specific materials should be directed to the manufacturer and/or the Truck-Lite Corporate Laboratory.</i>		

9. Always replace wiring, trailer light cables and harnesses with an equal or heavier gauge of wire than was originally used. Using a lighter gauge wire can lead to problems. See pages 8 and 9 for wire gauge details.

10. You should never crank the truck with lights on; voltage surge is hard on lamps. You should also avoid needlessly using the hazard markers and clearance lights. When parked at a truck stop or terminal yard, save the lights by turning them off. Avoid parking against the dock with the hazard markers, turn signals, or tail lamps operating.

3. Chemical Impact on Lighting

What Is It?

Almost all cracked parts are caused by incompatible chemicals or cleaners. Although lenses are very durable, they can crack due to the combination of stress induced by the molding process and chemical acceleration of the stress.

Typical Examples Include The Following:

- Lights on buses or vehicles that are frequently washed with incompatible cleaners
- Lights near engines or exhausts
- Lights exposed to some soaps, body cleaners, lubricants, paint, paint cleaners, antifreeze, washer fluids, brake fluid, and hundreds of other chemicals

What Makes The Plastic Crack?

The chemical penetrates the plastic and unhooks the long chains of molecules that make the plastic strong. Anywhere that the plastic is under stress (like a lens weld on a mounting hole) may crack.

Can Cleaning Solutions Be Damaging?

The use of solvents that are not compatible with polycarbonate will result in the softening, crazing, and/or cracking of the plastic part. Polycarbonate lamps and mounting bases may be used under stress in their normal applications.

4. Product Pitfalls

Truck-Lite has cataloged numerous problems that occur in the field. Here are a few of the repeat offenders:

Over Tightened Mounting Screws:

After a while, polycarbonate will crack under stress. The rule of thumb is to use the minimum torque possible. Never use more than 20 inch-pounds.

Loose Brackets Or Undersized Grommet Holes:

Both of these issues can prematurely knock out filaments.

Not Adding NYK-77® To Plugs Or Lights When Installing:

Truck-Lite adds only enough NYK-77 for the lamp. Additional NYK-77 should be used on the connection end.

Note: This is not recommended for use with LED lamps that use Fit 'N Forget® connectors.

Continued Stretched Or Pulling (Especially Sideways) Of A Cable On A Junction Box Or Distribution Module:

This may eventually cause a disconnection or an electrical short.

Using A Backup Light For A Dome Light Or Vice Versa:

One will cause heat damage; the other is not legal.

Not Replacing Plugs Which Show Signs Of Corrosion:

Even though they may work, they will promote rapid pin corrosion on the new replacement light pin (plug) connection.

Using Incompatible Cleaners Or Chemicals And Allowing Them To Get On The Lights:

Lights will crack and fail.

Painting A Vehicle And Allowing Paint Or Solvent To Contact Lights Or Wiring:

Most paints (excluding water based) are incompatible with polycarbonate lights. They may also cause wires or cable insulation to crack.



Allowing Lights to Contact Insulating Materials (Like Loading Dock Air Seals) While Energized:

Another variation of this is the placement of insulation too close to contacts of the light housings. This can result in heat distortion/damage and shorter life.

Failure to Orient Lights With the Word "TOP" Properly:

This is important for a couple of reasons, including the fact that the bulb life may be shortened by heat or increased shock. The other reason is that it is an obligation for legal compliance.

One Volt Beyond Designed Voltage Will Reduce Expected Life Of A Bulb Filament By More Than 50 Percent*:

It is not always controllable, but the "rule of thumb" is that vehicle voltages should be adjusted to the minimum acceptable voltage for proper operation.

5. Counterfeit Products

The primary function of vehicle safety lighting systems is to provide a safe environment for vehicle operators, pedestrians, and anyone else that is in the vicinity of vehicles. The reliance on lighting products make it extremely important that buyers trust in the products they are using.

Counterfeit lighting products are often reverse-engineered look-a-likes of reputable brand name products. Counterfeiters sometimes use identical markings, part numbers, logos, and even packaging. Imported knock-off products which resemble the look or function of brand name equipment are becoming more prevalent in the heavy-duty industry. In the case of lamps, knock-offs are often designed without care for patents or trademarks of the original lighting products. It's uncommon for knock-off lamps to meet FMVSS safety regulations, and the number of existing product violations in the domestic market is rapidly rising.

Do The Risks Outweigh The Rewards?

These products are designed to mislead customers into believing they are buying the original brand, while infringing upon copyright and trademark rights of the original manufacturer. When counterfeit vehicle safety lighting products are sold to customers who believe they are getting dependable, durable solutions for legal lighting applications, they are expecting the same road safety, maintenance, service, and support levels of brand names the products mimic.

Distributors of counterfeit products are subject to the same legal penalties as the foreign manufacturers, and in the case of direct import of the product, are classified as the manufacturer of record on such products. If a distributor or original equipment manufacturer contracts

with a manufacturer outside of the United States to have products shipped into their US facility, the distributor or OEM retains all of the responsibility that a typical lighting company would have. This includes certification compliance and product liability. The United States Congress and the National Highway Transportation Safety Administration (NHTSA) employ dedicated positions in support of enforcing actions against noncompliant vehicle lighting products.

Supplying falsely marked counterfeit products not only leads to damaged customer relations, but also has ties to legal prosecution.

Non-Compliance Issues

Combination lamps and their basic photometry are key areas of concern when it comes to counterfeit lamps. Often, these combination lamps lack basic advertised functions, such as side-reflex or combination properties. Additionally, the standard lighting requirements necessitate that light output extends beyond specific limits; counterfeit products typically do not meet these requirements.

Lack Of Industry Know-How

The growing presence of Light Emitting Diode (LED) safety lighting products in the heavy-duty industry has caused an increase in the number of companies that manufacture and export lighting solutions. Manufacturing lighting products requires close monitoring of production, and most utilize low-variance standards with supplies and materials. Though they often have some experience in the production of electronics, many of these new sources do not have the necessary experience in and understanding of the heavy-duty lighting industry as it applies to safety, legal requirements, product downfalls, and more—which Truck-Lite can offer.

As a longtime member of the traditional heavy-duty safety systems industry, Truck-Lite is familiar with the specifications and legal requirements that drivers and maintenance staff rely on. It is with that experience and education that Truck-Lite designs and manufactures many of the new products and product advancements that are being copied and reproduced elsewhere.

Opportunities With LED Advancements

When incandescent bulb technologies were the only light source capable of delivering the necessary light output that is required for legal vehicles safety applications, much of a lamp's development could rely on the standards of the internal light bulb and its proven expectations. With the use of electrically charged crystals, the appearance, color, and light output of LEDs varies from diode to diode—unless the manufacturer has standards in place to ensure each diode is grouped and driven properly. If diodes are not classified and used based on their specific output reading and bins, the resulting output can vary from lamp to lamp.

Identifying Product Markings

Product brand, a manufacturer's identification mark,



and the presence of a certification stamp are all key indicators that your lighting products can be trusted. Many off-market lighting products show no printed signs of the manufacturer, and make it nearly impossible to contact anyone in regards to product performance, installation, compliance, or warranty support. Also, look for certification notes on the lamp as evidence that the lighting product was designed to meet the regulations that your application requires.

Prevention

The NHTSA regulates safety standards to ensure certain levels of performance and safety, regardless of the manufacturer. But, as an organization, the NHTSA has no authority to address counterfeiting. Instead, the authority belongs to the U.S. Copyright Office, the U.S. Patent and Trademark Office, the Federal Bureau of Investigations, the Department of Justice, and Customs and Border Protection to stop the potentially unsafe product from import. Despite their best efforts, it simply isn't possible to keep all non-compliant products off store shelves.

Buyers can do their part to combat the downfalls of counterfeit products by inspecting lamps for product markings and classifications, as well as inquiring about the manufacturer at the point of sale.

The initial purchase of a vehicle lighting product—whether it is in the original vehicle purchase, or the costs of acquiring a replacement unit—is only the beginning of the complete vehicle life cycle cost. Any inferior products bring added costs and, more importantly, vehicle downtime. The choice to invest in a reputable brand such as Truck-Lite brings with it the reliability that ensures you won't be replacing lamps prematurely.

The value that comes with peace of mind is hard to find in an unmarked, non-compliant lamp.

NORTH AMERICAN STANDARDS & SPECIFICATIONS

SECTION OBJECTIVES

1. Federal Requirements
2. Proper Light Specification
3. Common Legal Questions
4. ID Codes
5. Regulation Charts

1. Federal Requirements

Who's who when it comes to lighting regulations?

DOT is the Department of Transportation. This functions as a large governmental umbrella for anything dealing with transportation, including the NHSTA, FHWA, etc. The DOT lettering is often put on lights to show that they conform to all government regulations.

NHTSA is the National Highway Traffic Safety Administration. They regulate lighting requirements for all new road vehicles, with the exception of pole trailers and converter dollies. Their regulations take precedence over state regulations and they have the power to implement fines, recalls, and new regulations. State Enforcement agencies often use the NHTSA regulations for their light requirements.

FMCSA is the Federal Motor Carrier Safety Administration. They issue Federal Motor Carrier Safety Regulations (FMCSR). These rules regulate vehicles

over 80" wide, such as commercial vehicles and buses. Some of these deal with lighting and wiring. Most states inspect vehicles using these standards.

FMVSS 108 is the Federal Motor Vehicle Safety Standard No. 108. This is the federal code (law) that regulates lighting and performance requirements, as well as the numbers and locations of lights on vehicles. NHTSA publishes the 108 regulations.

CMVSS 108 is Canada's analogous regulation code, which is very similar to FMVSS 108. The primary differences are that the CMVSS 108 requires daytime running lamps and allows European headlamps, while FMVSS 108 does not.

Transport Canada is the department of the Canadian government which is responsible for developing regulations, policies, and services of transportation in Canada.

2. Proper Light Specification

When it comes time to order your next heavy-duty vehicle, there are many decisions to consider. With so many costs coming into play with applications other than vehicle lighting, it is easy to justify cheaper, lesser quality equipment. Despite being marginally cheaper at the time of the initial purchase, purchasing basic equipment is often more expensive in the long run. To fully utilize industry improvements, to be sure your vehicle meets all legal requirements, and to ensure that the vehicle meets the expectations of maintenance staff and vehicle operators, it is important to properly specify the products being ordered for your vehicle.

There are two important points of interest that should be considered prior to "spec'ing" a vehicle order.

Fleet Vehicle Maintenance History and Review

It's important that Fleet and Maintenance Managers review their fleet's vehicle maintenance and warranty data before specifying a new vehicle build. This data can provide key insight into any specific areas of concern, as they relate to your particular fleet's vehicles. An appropriate investigation can yield weak areas on the vehicles, or areas that require special attention. With this data in hand, Truck-Lite Sales and Engineering Representatives can be called upon to provide additional information in terms of product resources that may aid in achieving your fleet's best lighting in an efficient full systems approach.

Once a specification has been ordered, it can be beneficial to have your supplier present at the first vehicle build to ensure that the specified equipment has been installed, is installed properly, and will optimize the benefits it offers.

Review Industry Developments

With the growing number of new LED technologies being developed that enhance safety, improve product efficiency and productivity, and provide greater functionality than ever, it's important that time is taken to review the latest offering.

Haitz's Law states that every decade, the amount of light generated per LED package increases by a factor of 20. This has proven true since Truck-Lite's LED offering that dates back to the early 1990s. Due to the energy efficiency of LED lamps vs. incandescents—a whopping 90% reduction—the U.S. Department of Energy has provided additional funding to accelerate the implementation of LED lighting. This has led to the development of LED options for work lighting, interior lighting, auxiliary lighting, and many more offerings that had previously not been possible. As development grows, lamp offerings become possible, smaller profiles,

sizes, and applications. Make sure you are taking advantage of all of the technological advancements that are available to your fleet.



3. Common Legal Questions

What lights do I need?

Browse the NHTSA charts (shown later in this section). Truck-Lite Tech Support (888.562.5012.) can be reached for additional questions. Note that states cannot require different specifications than what is in 108, but they can add regulations.

The vehicle has everything needed for 108, but the State Police still gave me a ticket.

States can regulate anything not covered by 108, for example, any accessory lights or lights in addition to those in 108. Generally, the problem lies in these areas, though sometimes, they simply make a mistake. If it is the latter, Truck-Lite Technical Support can often write a letter to clarify the issue.

Is it all right to mount a light at some angle? That is, not “square” on the vehicle?

“Maybe.” You need to contact Technical Support for a test in that position; otherwise, it can be questioned by the NHTSA or enforcement groups.

Can I ever use the Model 40 with the reflex reflector ring legally?

Yes, on any vehicle under 80" wide, as an "extra" light on vehicles over 80" (reflex is legal), or on vehicles made in 1991 or earlier.

Is it okay to use a light for "side turn" that isn't listed for that function?

It is perfectly fine, because side turns are NOT legally required. That said, be careful that it doesn't violate some state laws regarding color or location. If it is also used as a side marker, that function must be listed on the lens code.

Is SAE or DOT lettering required on lights?

No lettering is required by the NHTSA (108) except for headlights and conspicuity tape. The Federal Motor Carrier Safety Manual mentions that some lights should be marked SAE but this is not enforced. Truck-Lite marks all of their lights with SAE and/or DOT markings.

What is a combination marker/clearance light and how do I mount it?

Simply put, it is one light doing the work of two. It must be at a 45-degree angle (on corners) to be legal. It also needs to be marked PC in the lens code. If there is a question, contact Technical Support.

Are there special lighting requirements for vehicles hauling flammable or explosive materials?

There are no special Federal requirements as 108 covers all over-the-road vehicles. Some states or municipalities have regulations, but these cannot supersede 108—they can only add to it. FMCSR and the NFPA (National Fire Protection Association) publish requirements for wire protection, as well.

Truck-Lite's sealed lights and wiring systems have been tested to all known standards and certification. Reports are available from Technical Support.

108 says that some lights must be mounted as “high as practicable or as far apart as practicable.” What is “practicable?”

The NHTSA has stated that the vehicle manufacturer has the responsibility to choose the best mounting location “in light of the particular design/configuration of the vehicle involved” and they will not contest it unless it is “clearly erroneous.” Recently, Canada has started to enforce the word practical as meaning “capable of being done.” In the case of clearance markers, not more than six inches from the edge of the vehicle is practical.

I want to add some auxiliary lights like illuminate signs, deceleration lights, or decorative lights. Are these legal?

Yes, provided they do not render inoperative any device in compliance with 108, negatively affect the performance of required equipment, or create confusion or misunderstanding of lighting signals. Always contact the Technical Support if you have any questions.

What is the “12-Square Inch Rule”?

On December 1, 1991, the NHTSA made effective the final ruling regarding the 12-Square Inch Rule. This ruling requires that the total luminous lens area for a stop and turn lamp must not be less than 75 square centimeters (11.625 square inches) when used on vehicles over 80” wide.

It must be noted that the Model 40 reflex reflector ring cannot be counted as square inch lens area. When the reflex ring is subtracted from the total 12-inch lens, it leaves less than the 12-square inches that are required.

4. Explanation of ID Codes

The SAE J759 Lighting Identification Code can be difficult to interpret regarding clearance and marker applications. This additional information may be helpful.

P2: Clearance Sidemarker and Identification Lamps

This marking is currently used for both “over” 80-inch and “under” 80-inch vehicles. It has become the standard for vehicles under 80-inches, but government specifications (FMVSS-108) have never called out increased requirements for the larger width. P2 is the minimum standard for clearance, side marker, and identification lights. All Truck-Lite devices meet this standard, even if they are marked PC, P3, etc.

PC: Combination Side Marker and Clearance Lamp or Identification for vehicles over 80-inches wide

To be used as a combination light, devices must be mounted on a 45° bevel at the corner of a vehicle. This allows clearance and side marker functions to be combined in one light, and eliminates the need for a second device. A PC light can always be used anywhere a P2 light would have been used, but the reverse is not true.

P3: Clearance, Sidemarker or Identification lights for use on vehicles over 80-inches wide

A P3 designated lamp has higher light outputs than a P2 rated lamp. It is legal wherever a P2 light would be used. Because the federal regulations (FMVSS-108) have yet to adopt P3, many manufacturers have not made lights to meet the standard. Some of Truck-Lite’s lamps do not meet this standard, and are marked accordingly.

PC2: Combination Side Marker and Clearance or Identification lights used on a vehicle over 80 inches wide

PC2 Lamps meet an increased angle output, and are designed as combination lamps. When used as combination lamps, they must be mounted on a 45° beveled corner. Because the federal regulations (FMVSS-108) have yet to adopt P3, many manufacturers have not made lights to meet the standard. Some of Truck-Lite's lamps do not meet this standard, and are marked accordingly.

Additional Points of Concern:

- Currently, the FMVSS-108 standard has recognized only the standards that call for P2 or PC markings. The other markings are for SAE recommended practices.
- The PC or PC2 lights offer the widest patterns of visibility.
- FMVSS-108 does not require any of these lens markings, with the exception that they accept DOT lettering as certifying legal compliance.
- A good rule of thumb is to only buy lighting that has the manufacturer's name engraved on the lens and has the SAE/DOT Identification Codes on lamps.

Lighting ID Codes:

A	Reflex reflectors
A2	Wide angle reflex reflectors
C	Motorcycle auxiliary front lamps
D	Motorcycle and motor-driven cycle turn signal lamps
E	Side turn signal lamps—vehicles 12m or more in length
E2	Side turn signal lamps—vehicles less than 12m in length
F	Front fog lamps
F2	Fog tail lamps
G	Truck cargo lamp
H	Sealed beam headlamp
HG	Discharge forward lighting (headlamp)
HH	Sealed beam headlamp housing
HR	Replaceable bulb headlamp
I	Turn signal lamps
13	Turn signal lamps spaced from 75 mm to less than 100 mm from headlamp
14	Turn signal lamps spaced from 60 mm to less than 75 mm from headlamp
15	Turn signal lamps spaced less than 60 mm from headlamp
16	Rear mounted turn signal lamps and front mounted turn signal lamps mounted 100 mm or more from the headlamp, for use on vehicles 2032 mm or more in overall width
17	Front mounted turn signal lamps mounted less than 100 mm from the headlamp, for use on vehicles 2032 mm or more in overall width
J590	Turn signal flasher
J945	Hazard warning signal flasher
J1054	Warning lamp alternating flasher
K	Front cornering lamps
K2	Rear cornering lamps

L	License plate lamps
M	Motorcycle and motor-driven cycle headlamps—motorcycle type
N	Motorcycle and motor-driven cycle headlamps—motor driven cycle type
O	Spot lamps
P	Parking lamps
P2	Clearance, sidemarker, and identification lamps
P3	Clearance, sidemarker, and identification lamps for use on vehicles 2032 mm or more in overall width
PC	Combination clearance and sidemarker lamps
PC2	Combination clearance and sidemarker lamps for use on vehicles 2032 mm or more in overall width
Q	Turn signal operating units—Class A
QB	Turn signal operating units—Class B
QC	Vehicular hazard warning signal operating unit
R	Backup lamps
S	Stop lamps
S2	Stop lamp for use on vehicles 2032 mm or more in overall width
T	Tail lamps (rear position lamps)
T2	Tail lamps (rear position lamps) for use on vehicles 2032 mm or more in overall width
U	Supplemental high-mounted stop and turn signal lamps
U2	High-mounted stop lamps for trucks 2032 mm or more in overall width
U3	Center high-mounted stop lamp for passenger cars, light trucks, and MPVs
W	Warning lamps for emergency, maintenance, and service vehicles
W2	Warning lamps for school buses
W3	360 degree emergency warning lamps
W4	Emergency warning device

Continued on next page

Lighting ID Codes:

W5-1	360 degree gaseous discharge lamp—Class 1
W5-2	360 degree gaseous discharge lamp—Class 2
W5-3	360 degree gaseous discharge lamp—Class 3
Y	Driving lamps
Y2	Daytime running lamps
Z	Auxiliary low beam lamps

DESCRIPTION		MANDATORY REQUIREMENTS				
Area Equipment	SAE Lens Coding	Functional Purpose	Quantity	Color	Location	Height mm(in.) from the ground
1						
2						
3						
4						
			a			
			b			

BASIC EQUIPMENT REQUIRED ON ALL TRAILERS

DESCRIPTION		MANDATORY REQUIREMENTS				
Area Equipment	SAE Lens Coding	Functional Purpose	Quantity	Color	Location	Height mm(in.) from the ground
5						
			a			
			b			

ADDITIONAL EQUIPMENT FOR TRAILERS EXCEEDING 9.1m (30 ft.) or longer length

DESCRIPTION		MANDATORY REQUIREMENTS					
Area	Equipment	SAE Lens Coding	Functional Purpose	Quantity	Color	Location	Height
6							
7							
8							

Width 2032mm (80 in.) or wider

DESCRIPTION		MANDATORY REQUIREMENTS				Options
Area	Conspicuity Treatment	DOT Coding	Quantity	Color	Location	Height
9						
10		<div style="border: 1px solid black; padding: 2px; display: inline-block;"> DOT-C DOT-C2 DOT-C3 DOT-C4 </div>				
11						
12						

Reflex reflectors may not be required if they are replaced in their required location with conspicuity treatment.

Optional in Canada:
 Rear, lower body and side conspicuity treatment may also be solid white, solid yellow, or white and yellow.

Width 2032mm (80 in.) or wider AND GVWR 4536 kg (10,000 lb.)

Trailer Equipment Location Requirements

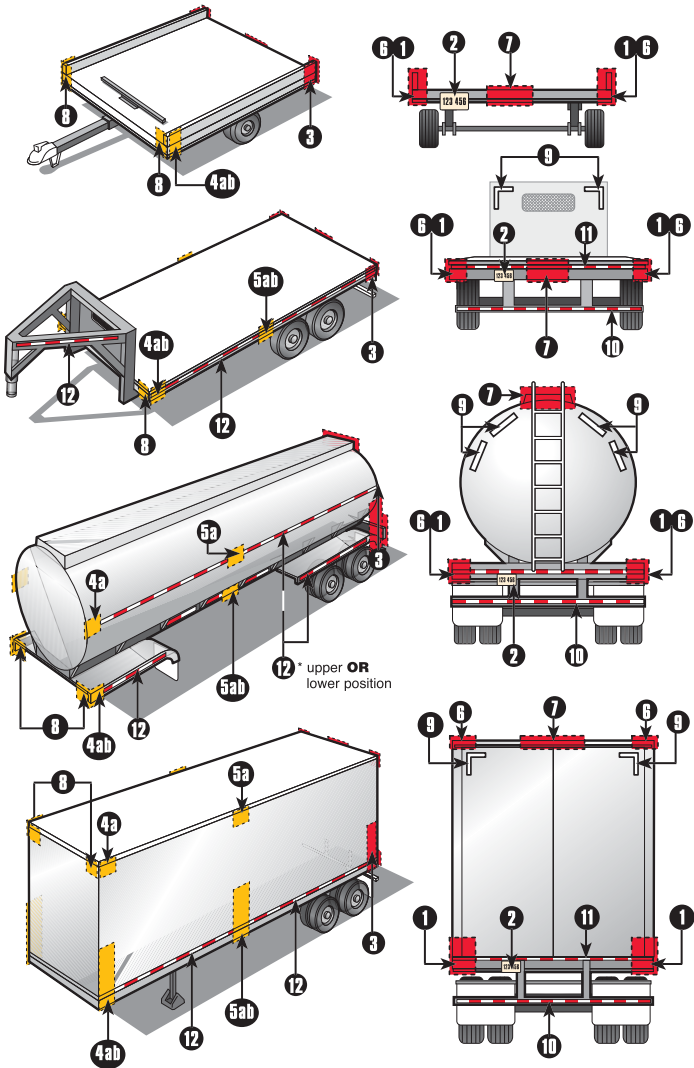

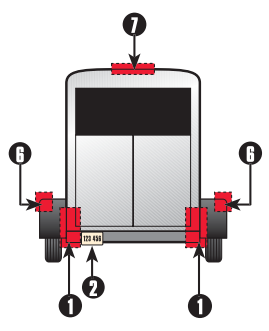
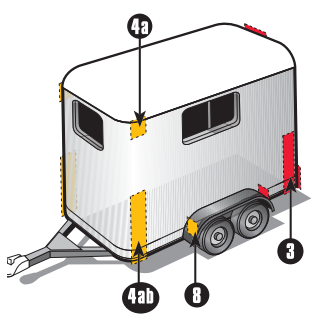
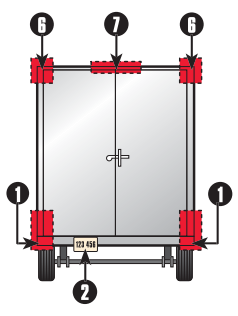
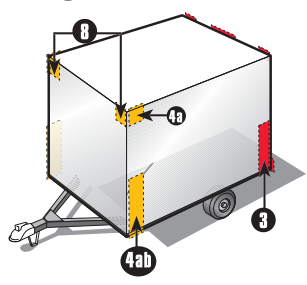
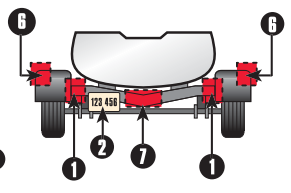
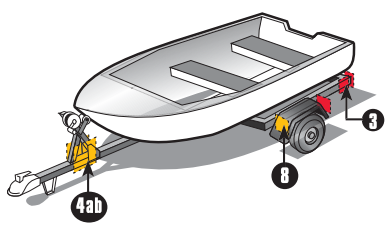
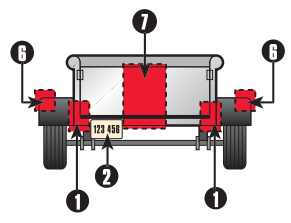
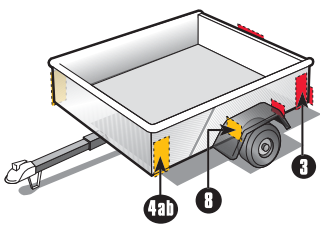

DESCRIPTION		MANDATORY REQUIREMENTS					
Area	Equipment	SAE Lens Coding	Functional Purpose	Quantity	Color	Location	Height mm(in.) from the ground
1							
2							
3							
4	a		Front and rear side marker lamps / side reflex reflector indicate vehicle's presence and length				
	b						
5	a						
	b						
6							

BASIC EQUIPMENT REQUIRED ON ALL TRUCKS, BUSES & MPVs

7									
8									
9									
10									
11									
DESCRIPTION		MANDATORY REQUIREMENTS		MANDATORY REQUIREMENTS		MANDATORY REQUIREMENTS		MANDATORY REQUIREMENTS	
Area	Equipment	SAE Lens Coding	Functional Purpose	Quantity	Color	Location	Height	Options	
12	a b								
Area	Conspicuity Treatment	DOT Coding	Quantity	Color	Location	Height	Options		
13									
14									

DOT-C
DOT-C2
DOT-C3
DOT-C4

Truck, Bus, MPV Equipment Location Requirements

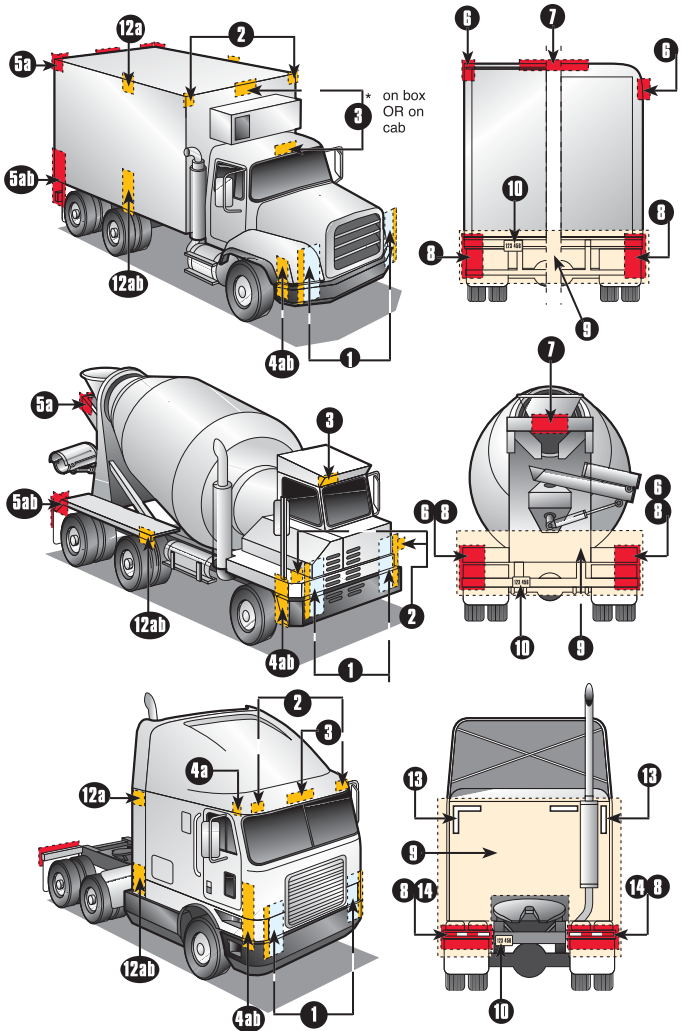

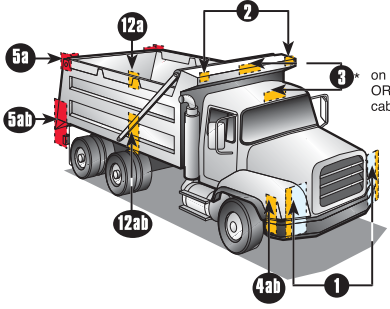
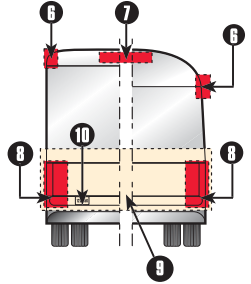
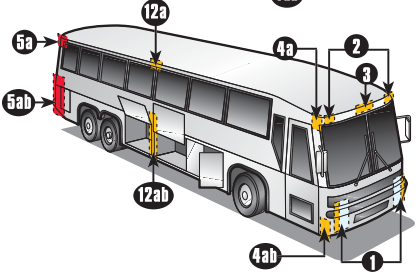
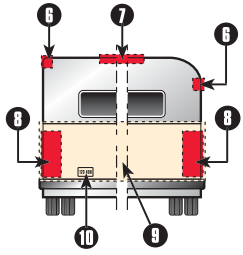
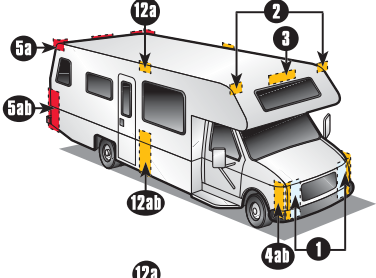
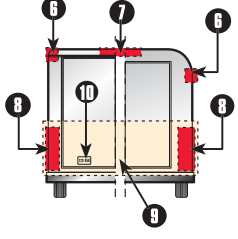
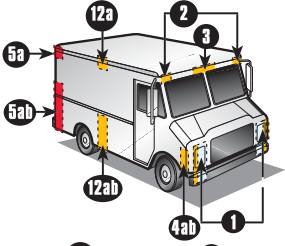

on box
 OR on
 cab

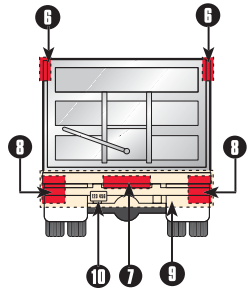

EVOLUTION OF LIGHTING

SECTION OBJECTIVES

1. Lighting Evolution
2. Introduction to LED Lighting
3. The Future of LEDs
4. LED Lifetime Systems
5. Systems Approach

1. Lighting Evolution

In 1879, Thomas Edison formally filed a patent request for his light bulb invention, a rudimentary bulb that utilized a carbonized bamboo filter that could last around 1200 hours. This invention paved the way for universal domestic use of electric light. Amazingly, for nearly 75 years after Edison's patent, there was very little technological change in incandescent lighting. There were minor improvements to the filament and support posts material, but the general design remained the same, which meant, for nearly 75 years bulbs were extremely susceptible to corrosion and vibration damage.

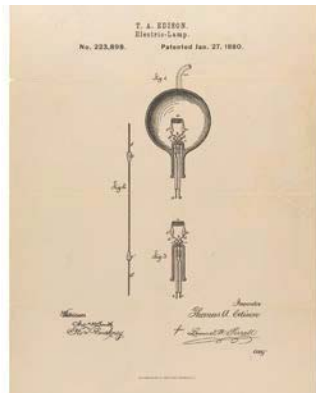

In 1955, two men, George Baldwin and Henry Grosser, provided a solution to the trucking industry with the very first sealed marker lamp. The idea of mounting a base-less bulb in a resilient compound and sealing it in the lamp allowed the light to have a longer lifespan — 10 to

15 times that of a conventional unsealed (bulb replaceable) light. And, just like that, Truck-Lite was born.

Not long after the first sealed marker lamp, lighting was taken in a vastly different direction when Nick Holonyak took lighting in a dynamic new direction. While working at General Electric in 1962, he developed the first practical visible spectrum (red) light-emitting diode (LED). It would take several years and numerous improvements before LEDs made their way into the commercial vehicle industry, but in 1991, Truck-Lite released the first LED stop lamp to the market, as an alternative light source to the traditional incandescent bulb replaceable and sealed lamps.



Truck-Lite currently offers three types of lighting: incandescent, sealed, and LED lighting.

Incandescent Lighting

An incandescent bulb is generally inexpensive. However, a bulb has many disadvantages.

The most significant disadvantages include:

- Limited life (less than 10,000 hrs.)
- Uses a fragile filament (susceptible to breakage during shock & vibration)

Some lighting manufacturers put bulbs in shock mounts to protect them from vibration, but even the best bulb will burn out or suffer a broken filament within three years. Incandescent lamps operate through the excitement of tungsten filaments that, when seeded in sealed glass housing, will provide light output. Truck-Lite has found that in the original 2-inch round and 4-inch round lighting applications, damage was most often found to have occurred due to bulb damage.

Sealed Lighting

While Truck-Lite manufactures lamps with shock-mounted systems (a method of attaching the bulb to the lamp in a suspended vibration-resistant device), not all lamp failure is a result of vibration. It was Truck-Lite's first development of the sealed lamp that began to tackle the problem of bulb failure.

Years ago, bulb replaceable lamps generally had poor lens gasketing, and often had drain holes. The drain holes allowed water into the lamp, which caused corrosion of the bulb socket and electrical contacts. Cold water could come in contact with the hot glass of the bulb, which would cause the bulb to crack. This led to a slow leak of air into the bulb, which caused failure. The filament would oxidize and produce a cloudy coating on the inside of the bulb. This dramatically reduced the bulb's light output and reduced the life to a few hours at most. If a crack was severe, failure could happen immediately.

Truck-Lite's work to prevent damage to the bulb resulted in the advent of the sealed lamp. Creating a lamp that allowed no way for chemicals or liquids to enter the lamp housing greatly decreased the possibility of damage.

2. Introduction to LED Lighting

Since they were first studied in 1988 for possible use in heavy-duty lighting applications, LEDs have become the new standard for long life, and low-current draw lighting.

LEDs are a monochromatic light source, meaning, each LED produces exactly one color. The core technology is a crystal growth onto a given medium—sometimes a silicone material, which is also used as the base for computer chips. When you expose this medium to a

combination of materials and run electricity through it, it lights up.

Even in the early days of LED use, their benefits were clear. LEDs appear brighter, with a more vibrant color. They also have a lower current draw.

In the late 1990s, Truck-Lite began to investigate the possibility of white LEDs. Because an LED diode is monochromatic, producing white—which is really a combination of the colors red, green, and blue—is very difficult. The problem was solved by creating a combination of RGB diodes that were packaged together. This final package emitted a white light.

Now, we know that there are many ways to produce white light with LEDs. The most efficient way is to use a blue LED chip and expose it to phosphor, which reacts and releases photons that fill up the rest of the color spectrum. Even now, significant improvements are being made in blue LED technology, which in turn improves white lighting technology.

In the mid-2000s, Truck-Lite was approached by the United States military, who asked for the development of white LED technology for headlights in the military market. Due to the extreme environments that military vehicles operate in, the filaments of traditional halogen bulbs easily break. With that in mind, it was important to provide a more reliable LED alternative as soon as possible. In 2007, Truck-Lite launched the world's first LED headlamp.

The next phase was to introduce military-grade LED technology to the commercial vehicle market, which was done with the 7-inch round and 5x7-inch headlights. Fleets who were already beginning the transition into custom halogen headlamps realized that there was an opportunity for life of the vehicle head lighting that offered longer life, lower current draw, better illumination, and the accompanying safety benefits.

THE BENEFITS OF LED LIGHTING

SAFETY

- Increases vehicle conspicuity with intense displays of light output
- Instantaneous response time, 200 milliseconds faster than that of incandescent lamps, creating 18 feet of additional stopping distance for trailing vehicles at highway speeds
- Low power consumption increases the length of time disabled vehicles can operate their 4-way flashers

ENERGY EFFICIENCY

- 85% reduction of load on electrical systems allows more power for other vehicle applications
- Minimizes voltage drop and reduces load on alternators, flashers and switches

RELIABILITY

- Related at 100,000 hours of operation, covering 4 million miles, and Warranted for life when equipped with Fit 'N Forget® connectors and Series 88 harnesses
- Extended period of operation translates to less vehicle downtime and zero maintenance

DURABILITY

- Solid-state construction, with extra measures taken to assure longevity of circuitry and components
- Virtually impervious to shock and vibration

Unlike their incandescent counterparts, LED lamps produce light without relying on a heated filament. This solid state method of producing current eliminates filament failure, and ultimately translates into a much longer life. LED lamps continue to gain popularity as more and more industry professionals recognize the benefits that LED lamps provide.

Truck-Lite's LED lamps are extremely reliable and efficient, because they are internally sealed with epoxy to encapsulate the electronic elements. The solid state design makes for an extremely impact resistant light source that is impervious to shock and vibration, even in the most damaging applications.

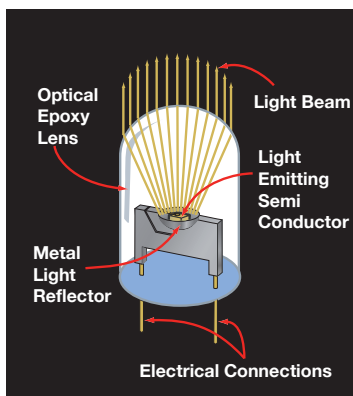

Because filament failure is not a concern for LED lights, they have an extremely fast turn-on time, and can last up to 100,000 hours. Combine this with their durability, and it's clear that they are ideal for the heavy duty industry.

LEDs come in different types:

- "T1-3/4's"
- "HPA's"
- "SnapLED®"

Colors Of Light

The colors of light produced by filament lamps in vehicle applications are the result of colored lens placement in front of an incandescent white filament. The red and amber color produced by LED lamps in vehicle applications are the result of colored light emitted from the diodes.

3. The Future of LEDs

Even in the earliest days of LED lighting, the benefits were clear, and as technology progresses, the benefits are continually improved. According to Haitz's Law, the cost per lumen of LEDs will fall by a factor of 10, and the amount of light generated per LED package will increase by a factor of 20 every decade. This continued refinement of the technology has continually led to reductions in cost and improvements in technology, which will continue to open doors to new LED lighting applications.

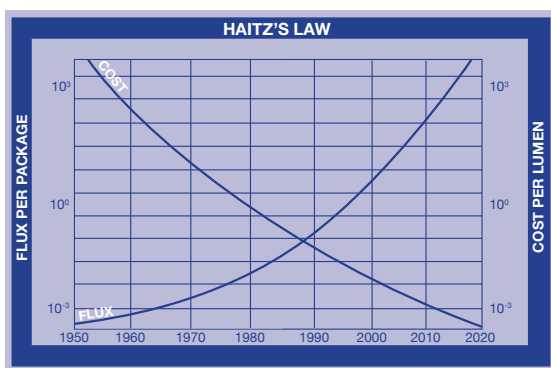

In the future, OEMs that do not currently have LED technology will look to implement it right away. There will also be the emergence of new forward lighting methodologies. Many of these developments will be focused on reducing headlight glare, which, according to NHTSA, is one of the most frequent complaints that they receive. One of the most promising new developments being tested is that of adaptive drive beam headlights.

The core principal of adaptive drive beam headlights is that vehicles will only have a high beam headlight in their vehicle. The headlight is paired with a forward facing camera, which senses oncoming traffic, and, by either mechanical or electronic beam blockers, blocks the specific area where the camera senses oncoming traffic or tail lamps.

4. LED Lifetime Systems

Customer Experience

The best warranty is one that you never have to use! Lighting has the highest frequency of failure of any device on a truck and trailer and is third in total cost. All vehicles equipped with Truck-Lite LED Lamps, Fit 'N Forget® Connectors and 88 Series “Plug Together” Harness Systems will be under warranty for the life of the vehicle!

88 Series “Plug-Together” Harness System

- Sealed, plug-together system
- Ensures solid, weather-tight contacts
- Eliminates the need for junction boxes, distribution outlets, and troublesome splices
- Internal ground guarantees reliability
- Color coded connections and wires
- Rear, 7-way adapter offers versatility

Lifetime Systems Warranty

A Lifetime Systems Warranty is a major step in making vehicles safer, by ensuring products last longer. Truck-Lite’s Lifetime Systems Warranty offers significant reduction in maintenance costs and provides the peace of mind that your lighting system will keep you on the road.

5. Complete Systems Approach

The common downtime and repair of incandescent lighting extends past the price alone of replacement lamps.

Part Cost + Labor + Downtime

Downtime is costly, and when you add in the hidden costs of halogen lamps—repairs and replacements—the initial savings from a halogen bulb quickly disappear. While the initial cost of LED lighting products may be higher, the advantages of not having to replace or repair the lamps will result in significant savings over the life of your vehicle.

Index/Glossary

Index

Look-a-likes	23
Loose or Tight Brackets	21, 23
Loss of Bulb Contact	15
Lubricant	20
Major Causes	12-16
Mounting Screws	20
NFPA	32
NHTSA	24, 26, 28, 56
Non-Conductive Grease	12
Non-Compliance	25
NYK-77®	18, 21
OHM	5
Ohm's Law	10, 63
Over-Tightening Screws	22
Over-Voltage (excess voltage)	14, 17, 20, 23
P2	34-35
P3	34-35
Paint Damage	23
PC	34-35
PC2	34-35
Physical Damage	15
Pin Corrosion	23
Polycarbonate	16, 19, 23
Poor Grounding	15
Potential	4
Power	5, 11
Product Markings	26
Product Pitfalls	22
Reflex	31, 33, 36
Resistance	5, 10
S-8 bulbs	13

SAE	9, 28, 32
Sealant	12
Sealed Lighting	12, 15
Shock	13
Shock & Vibration	13
Shock, Vibration & Burnout	13
Side Turn Lamp usage	32
SnapLED	50
Solid State	13, 50
Solvents/Cleaners	19-21
Stranded copper wire	14
Suitable Wiring	14
Systems Approach	53
Test Probes	17
Trailer Equipment Location Req.'s	38-45
Troubleshooting Lighting	17
Truck Equipment Location Req.'s	38-45
Under-voltage	17
Useful Formulas	10
Vibration	13
Vibration Resistance	13
Volt	4, 10, 15
Voltage	10, 6-8,
Voltage Drop	14
Voltage Drop Per Foot	8
Voltage Regulators	10
Voltage Spike	14
Voltage Surge	10
Warranty	27, 52, 55
Watt	5
Why Lights Fail	12
Wicking	17
Wire Gauge	8-9
Wire Gauge Size	7-9
Wire Size	4, 7, 14
Wire Size Calculations	7-9
Wiring harness	14

Index/Glossary

Glossary

Acrylic - A glassy thermoplastic polymerized from acrylonitrile which can be cast and molded, which is resistant to damage from many cleaning solvents.

Aftermarket - A term that refers to the market place for our replacement or retro-fit business. The customer in this market is replacing an existing lamp or accessory on his vehicle.

Bracket - A rigid mounting device that allows a lamp to be mounted on the surface of the vehicle body. Some brackets are designed to be used alone or with a grommet.

Bulb Replaceable - Opposite of sealed. The lens is removable on a lamp of this type. When the bulb fails, the lamp may be repaired by replacing the bulb.

Cab Marker - A lamp similar in function to the marker clearance lamp, but these are always mounted on the roof of the truck or tractor cab. Technically, these are called a front identification or ID lamp.

Custom Cut - A term that refers to the harnesses that must be cut and terminated to the customer's specifications.

DOT - United States Department of Transportation, was created to serve the United States by ensuring a fast, safe, efficient, accessible and convenient

transportation system that meets our vital national interests and enhances the quality of life of the American people, today and into the future.

Grommet - A rubber like device used to mount a lamp into a hole in a vehicle body or a mounting bracket. The grommet may allow a lamp to be mounted “flush” into the body and thereby protects the lamp from physical damage. A grommet also gives the lamp additional protection against shock and vibration.

Harness - Also a wiring device. A harness can include MULTIPLE plug connectors and be used to control different types of lamps. Harnesses tend to be heavy duty, jacketed cable as opposed to light duty, unprotected wire as in “plugs.”

HID - High Intensity Discharge, produces light by an electric arc between two closely spaced electrodes in a quartz glass bulb.

HIR - Halogen Infra Red, is a halogen lamp with an elliptical bulb envelope. The exterior of the bulb is coated with several layers of material, which are transparent to visible light but reflect infrared back to the filament. The effect is a brighter light for a given current.

ID Codes - ID Codes are the classifications given to various lighting applications in order to establish minimum requirements set forth by the SAE J759 regulations.

Junction Box - An accessory used with harness systems. All harnesses in a system are connected to this box. Signals from the control devices (switches on brake pedals, turn signal switches, etc.) are received in the accessory and are re-routed to the appropriate lamps via the harnesses.

Kit - A Truck-Lite term used to describe the combining of related products. For example, a lamp, a grommet, and a plug can be put together and sold as a unit or "Kit." A "Kit" can also be an entire "vehicle set", including all lamps, harnesses, and accessories needed to equip a vehicle.

LED - Light Emitting Diode. A "solid state" electronic device that converts electrical energy directly to light energy. When an electrical current is applied to the LED "chip," a colored light is emitted. The color depends on the chemical composition of the chip. Very little heat is produced with this process. Because the "diode" is cast into a solid block of epoxy, the LED is immune to vibrations and shock and can last up to 100,000 hours of operation.

Marker Clearance - Also called marker lamp. A small lamp used to mark the edges or corners of the trailer or truck body. These are normally amber in the front and middle of the vehicle, and red at the rear. Other colors are available for "auxiliary" use, but only red or amber (yellow) are legal for the use as marker clearance lamps in the U.S.

Module - A term used to describe a complete rear lighting assembly. The module usually consists of a housing (metal or plastic) with one or more tail lamps, and includes a harness or wiring assembly. The module may also include a marker lamp, reflector, or back-up lamps.

Multi-Function Lamp - A specialized Stop/Turn/Tail lamp. This type of lamp usually has a larger housing and can include side marker, license plate illumination, or reflectors, in addition to the basic rear lighting function.

NHTSA - The National Highway Traffic Safety Administration creates values and regulations which underpin the assurance of safe, secure, efficient automotive travel.

Ohm's Law - Ohm's Law describes mathematically how voltage, current and resistance in a circuit are related through the formula: $V = I \times R$, where V is equal to Potential in Volts, I is equal to current in amps and R is equal to Resistance in Ohms.

Plug Together Harness - The "brand name" for Truck-Lite's 88 series harness system and accessories. It features a system that eliminates the need for any type of distribution module. All components simply plug together ensuring a solid electrical contact throughout.

Plug/Pigtail - The basic wiring accessory. Usually a 1, 2, 3, or 4 wire design with termination designed to mate with a socket or pin connection area on the lamp.

Polycarbonate - Any of a family of thermoplastics characterized by high-impact strength, light weight, and flexibility, and used as a shatter-resistant substitute for glass.

Reflector - A non-powered (non-electrical) device designed to reflect light. A reflector does not emit light by itself, but will return light that is aimed at it. Reflective tape or reflectors are required by law to supplement lighting systems.

Sealed Lamp - Any lighting device that has its bulb permanently sealed inside the lens and housing assembly. When this lamp fails, the entire unit must be replaced, unlike a bulb replaceable lamp.

Shock Mounted - A system used to suspend and insulate the bulb from vibration and shock (impact).

Stop/Turn Lamp - A rear lamp that is brighter than a tail lamp used to indicate that the vehicle is turning or stopping. The “major” filament of the bulb is used to perform this function. Sometimes referred to as a “SC” or single contact lamp.

Stop/Turn/Tail Lamp - A rear lamp that contains one or more bulbs with both major and minor filament functions. This one lamp performs the duties of both the Stop/Turn lamp and Tail lamp. Sometimes referred to as a “DC” or double contact lamp.

Super System - The “brand name” for Truck-Lite’s 50 Series Harnesses and accessories. This system features both the “custom cut” and customer buildable harnesses. “Compression fittings” are used to seal outlets where harnesses enter the junction box.

Tail Lamp - This term is used in general to describe the rear lighting of the vehicle. Specifically, the tail lamp function is performed by the “minor filament” of the bulb. This red light remains “on” as long as the headlamps/parking lamps are in use. This light is not as bright as a turn or stop lamp.

Truck-Lite has a proud history of quality in-house harness production and has stood as a leader in the innovation of new technologies in the heavy-duty industry for decades.

In addition to a complete offering of standard catalog and specific harnesses, Truck-Lite has engineered a wide array of molded connectors, wire types, and end seals to complement an entire line of heavy duty lighting and visibility products. Truck-Lite can offer solutions for every facet of today's harness systems with the ability to incorporate customer specified components including grommets, split loom, tubing, braid, heat shrink, unique labels, and instructions.

Truck-Lite provides the highest levels of quality, performance, and durability in our harness products by continually working to improve equipment, processes, and production methods. We have the added strength of a fully dedicated testing facility to ensure all of our products stand up to the most rigorous of conditions. Our standard lab tests for harnesses include 500-hour corrosion testing, chemical testing, chemical compatibility checks, vibration testing hot/cold cycle exposure, salt water immersion and drop testing.

Truck-Lite Harness Products offer:

- plug to lamp interfaces with many Truck-Lite lighting products
- harnesses available for both LED or Incandescent connectors, some with internal grounds
- sonic welded splices and automated terminations contained in "sealed" molded connections
- 100% electrical testing
- PVC jacketed cable meets SAE recommendations
- many harnesses available in 12" increments to adapt to any application
- many adapters available to tailor to specific customer requirements