

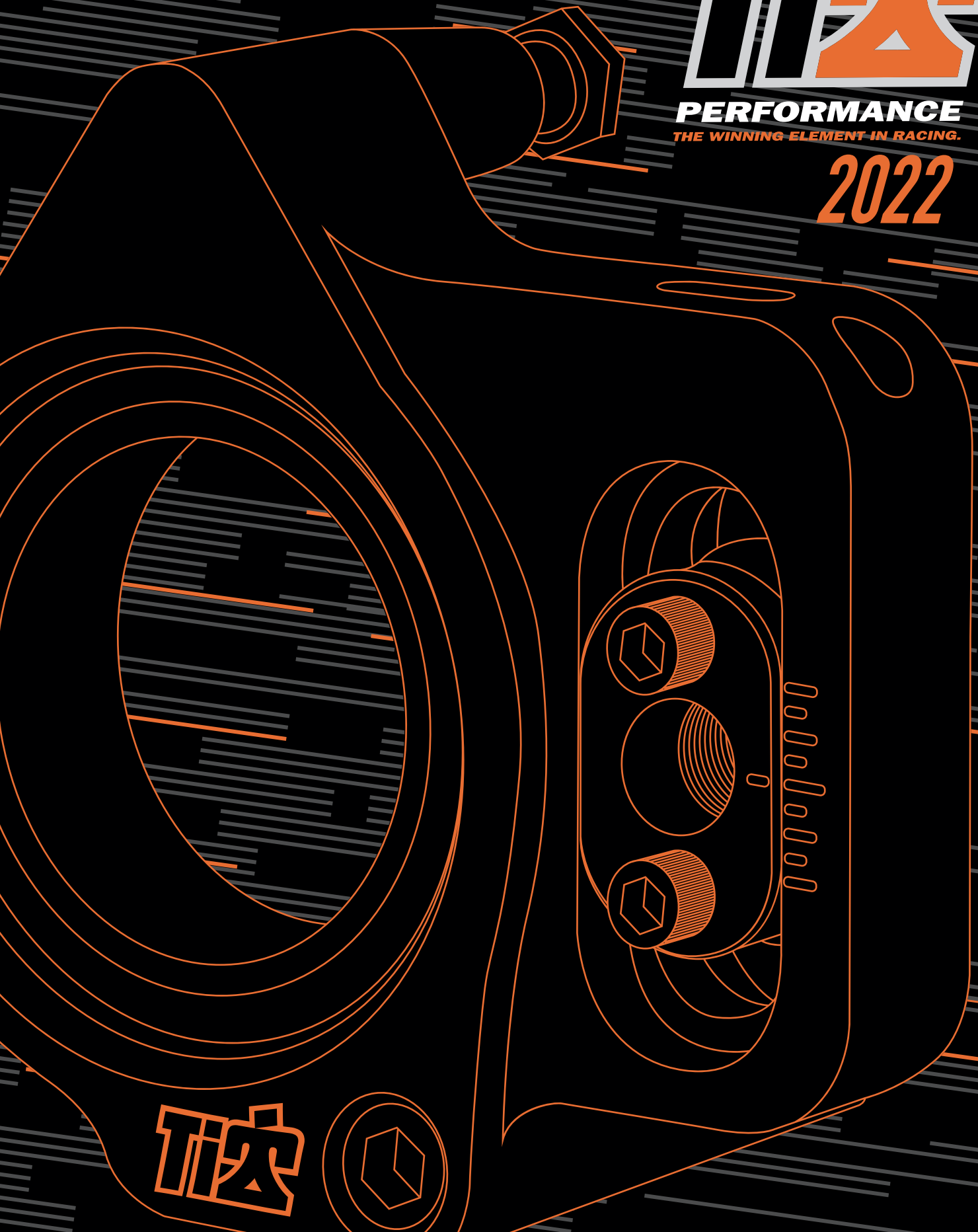

**PERFORMANCE**  
THE WINNING ELEMENT IN RACING.

**2022**





A leading manufacturer of high-performance racing components for open wheel race teams from around the globe, Ti22 Performance products are designed, engineered, and manufactured to not only outperform the competition, but to outlast them as well. Specializing in durable lightweight titanium components, Ti22's goal is to offer products that provide you with an edge on the competition. We hope that you find this catalog to be a valuable tool when sourcing high-quality products for the open wheel market. Visit our website for updates to our product line and other valuable information.

# ***CONTENTS***

<i><b>SECTION</b></i>	<i><b>DESCRIPTION</b></i>	<i><b>PAGE</b></i>
Rear Suspension	Birdcages, Jacob's Ladders, & Accessories	2-6
Front End	Front Axle, Steering Arms, Front End Kits	7-10
Steering	Pitman Arms, Steering Box Mounts	11-12
Suspension	Radius Rods, Tie Rods, Drag Links, Rod Ends	13-14
Torsion Arms	Front/Rear Torsion Arms	15
Torsion Stops	Torsion Components	16
Titanium	Wing Components, Fasteners, Torsion Components	17-21
Brake and Pedal	Brake Components	22-23
Driveline	Torque Tubes, U-Joints	24
Wheels	Wheel Center/Disconnects	25
Wing	Top and Front Wing Components	26-29
Bumpers	Bumpers, Nerfs, Fasteners	30-31
Engine	Filters, Guards, Mounts	32-35
Tools	Miscellaneous Sprint Car Tools	36-38
Body	Sprint Car Body Components	39-40
Mini Sprint	Everything For Mini Sprints	41-50
Apparel/Decals	Ti22 Performance, Shirts, Hats, Hoodies, Decals	51

# REAR SUSPENSION

## DOUBLE WIDE BIRDCAGES

Made from 7075-T5 aluminum, Ti22's Double Birdcages are among the most innovative cages on the market today. The cages were ultimately created to eliminate bind in the birdcage bearings. Bearing bind, created by twist in the birdcage, absorbs all-important horsepower that could be applied to the rear wheels. By distributing the weight between the two bearings, excess bind is eliminated, allowing for a more efficient transfer of horsepower to the rear wheels. The cages require the standard offset rear torsion arm offered by Ti22 as well as a custom rear axle. The rear axles are available from Winters, DMI, and Frankland.



TIP2032



TIP2034

Part ID	Description
TIP2032	Left Side
TIP2034	Right Side

## PRO BIRDCAGES

Ti22's Pro Birdcages are machined from 7075-T6 aluminum with a 28mm double-row angular contact bearing. The line features standard right and left cages, as well as the new Adjustable Birdcage. The adjustable feature allows for adjustment of the Jacob's Ladder pick-up point to meet changing track conditions, giving racers a competitive edge.



TIP2022



TIP2024

Part ID	Description
TIP2022	Left Side
TIP2024	Right Side

# REAR SUSPENSION

## REPLACEMENT BIRDCAGE COMPONENTS

Identify the part you need and match it with the corresponding part number and description to order. The right column denotes what parts work with each cage.

ID	Part ID	Description	Pro	Double Wide
1	TIP2100	Upper Pickup Cone	•	
2	TIP2106	Upper Pickup Cone Bolt	•	
3	TIP2102	Lower Pickup Block	•	
4	TIP2103	Lower Pickup Shoulder Bolt	•	
5	TIP2104	Lower Pickup Screw	•	
6	TIP2105	Lower Pickup Bolt	•	
7	TIP2115	Adjuster Block Set	Adjustable Cages Only	
8	TIP2116	Adjuster Plate Screw	Adjustable Cages Only	
9	TIP2117	Adjuster Plate Lock Nut	Adjustable Cages Only	
10	TIP2110	Standard Cage Bearings	•	
11	TIP2114	DBL Lower Shoulder Bolt	•	
12	TIP2128	DBL Lower Shoulder Bolt Nut		•
13	TIP2112	DBL Upper Pickup Bolt		•
14	TIP2120	DBL Cage Bearing		•
15	TIP2118	Spiral Locking Ring	•	•

7-Adjustable Block Set



TIP2115

3-Lower Pickup Block



TIP2102

1-Upper Pickup Cone



TIP2100

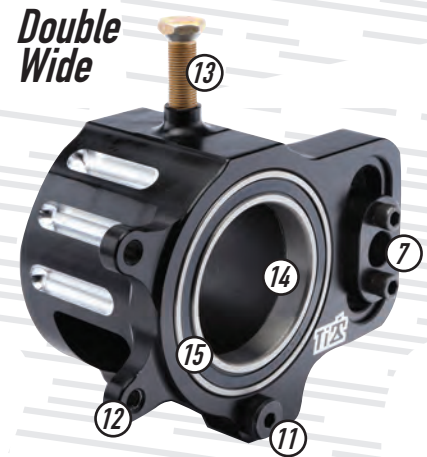

### FEATURES:

#### Tune-n-Loc Adjuster

Move the ladder position in 1/8" increments to raise or lower the roll center quickly and precisely

#### Built-In Convenience

The built-in level allows you to adjust the birdcage in seconds

#### Custom Machined Hardware

Hardware is custom machined for radius rod and torsion arm pickups

### Using The Adjustable Feature

*For a track that is tacky or has a lot of Grip:*

Move the Tune-n-Loc adjuster up on the birdcage to create less chassis roll, therefore letting the car roll the corner better.

*For a track that lacks Grip:*

Move the Tune-n-Loc adjuster down on the birdcage to promote more chassis roll therefore creating more sidebite.

### Recommended Incremental Adjustments

↑ UP	1/2" - Very Rough or Heavy Surface
	3/8" -
↓ DOWN	1/4" - Tacky Surface
	1/8" -
	0 - Baseline Starting Point
	1/8" -
	1/4" - Dry Surface
	3/8" -
	1/2" - Very Slick Surface

# REAR SUSPENSION

## STANDARD BIRDCAGES

These black anodized billet aluminum birdcages are complete with angular contact bearing, torsion arm bolt, and radius rod bolt. 5-1/4" split between radius rod and torsion arm. Left and right sold individually.

Part ID	Description
TIP2026	Left Side, 5-1/4" Center-to-Center
TIP2028	Right Side, 5-1/4" Center-to-Center



## NON-WING BIRDCAGES

These black anodized billet aluminum birdcages are complete with angular contact bearing, torsion arm bolt, and radius rod bolt. 5-1/4" split between radius rod and torsion arm. Left and right sold individually. Commonly used on non-winged sprint cars.

Part ID	Description
TIP2042	Left Side, 5-1/4" Center-to-Center
TIP2044	Right Side, 5-1/4" Center-to-Center



## REPLACEMENT BIRDCAGE COMPONENTS FOR STANDARD AND NON-WING CAGES

Part ID	Description
TIP2030	Bottom Flag
TIP2031	Top Stand-Off
TIP2110	Bearing
TIP2118	Spiral Lock Ring
TIP2029	Brake Mount



# REAR SUSPENSION

## STANDARD JACOB'S LADDER

The titanium option significantly reduces part weight by almost 1/2 lb. over the standard chromoly ladder. Titanium - 11.2 oz., Chromoly - 1 lb. 3 oz. All ladders are offered with Titanium hardware.

Size	Chromoly	Titanium
13-1/4"	TIP2430	TIP2431
13-5/8"	TIP2433	TIP2434
14"	TIP2436	TIP2437

## ADJUSTABLE JACOB'S LADDER

Ti22's Adjustable Jacob's Ladder has (3) pickup points at 5/8" increments. This provides the ability to make adjustments according to varying track conditions. Move the ladder up (bottom hole) for heavy or rough tracks to let the chassis roll the corners better. Move the ladder down (top hole) on dry, slick tracks to create more sidebite. All ladders are offered with titanium hardware.

Size	Chromoly	Titanium
13-1/4"	TIP2443	TIP2444
13-5/8"	TIP2446	TIP2447
14"	TIP2448	TIP2449

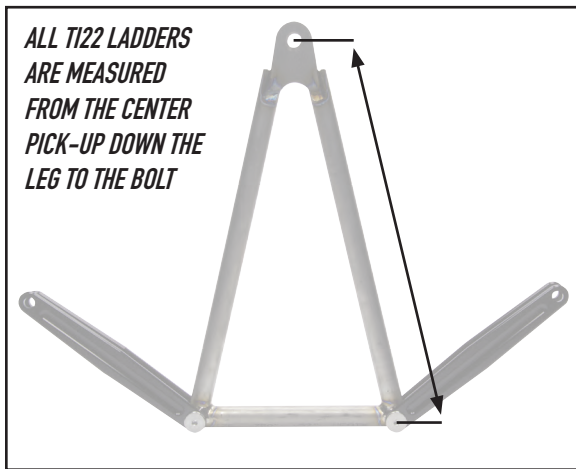

## QUICK PIN LADDER KITS

Change your Jacob's Ladder quickly with our Quick Pin Ladder kits. Kits include a 2-1/4" long chassis pin for chassis that have the top and bottom ladder tabs instead of a spud.

### Complete Kit Contains:

- (2) 3/8" Jacob's Ladder pins (2-1/4" from bottom of the head) with clips
- 1/2" Steel pin and rue clip with easy-to-remove handle for the Jacob's Ladder to birdcage
- (2) Nylatron spacers for Jacob's Ladder straps

Part No.	Description
TIP1070	Titanium Kit
TIP1076	Nylatron Arm Spacers, Sold in Pairs
TIP1570	Steel Kit

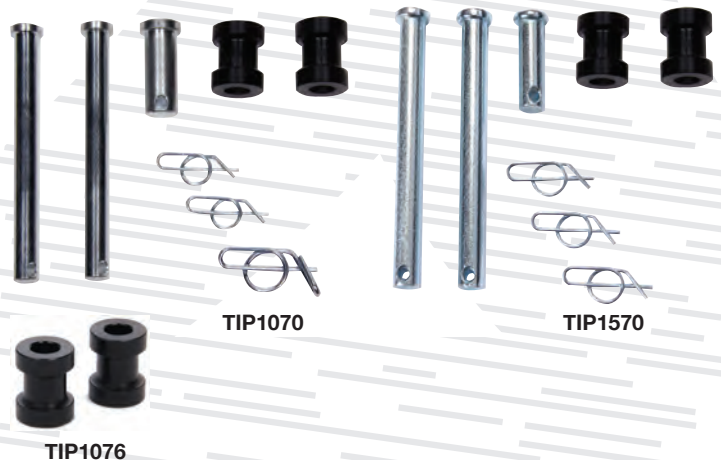

# REAR SUSPENSION

## **CARBON FIBER JACOB'S LADDER COVER**

**TIP2425**

The newest way to protect your rear axle and center section from debris. Features a 1/2" hole to connect to Jacob's Ladder with your existing 1/2" bolt or pin. Back secures with straps and bolts. Simple, lightweight, and strong cover protects against debris and keeps expensive rear ends looking new.



## **JACOB'S LADDER STRAPS & BOLTS**

**TIP2421**

CNC-machined from 2024 aluminum, the 7" long Ti22 Ladder Straps are strong and lightweight. Straps sold individually.



TIP2421



*Standard Ladder shown with  
black light-weight Ladder  
Straps*

## **TITANIUM ALLEN-HEAD LADDER STRAP BOLT KIT 1-3/4"**

**TIP2427**

Low-profile Allen-head kit includes two super strong, lightweight Allen-head titanium bolts with 6-point steel jet nuts. Allen Head bolt won't scratch up the rear axle like hex-head bolts can. This 1-3/4" long ladder strap bolt is the standard bolt for Maxim/Eagle/J&J ladders.





# FRONT END

## ADJUSTABLE STEERING ARMS WITH STEERING DAMPENER MOUNT

The Adjustable Steering Arms are CNC-machined from 2024 aluminum. Combo arms have a 5/16" threaded hole for mounting the steering damper (below).

Part No.	Style	Finish
TIP3011	Right	Aluminum
TIP3010	Right	Black
TIP3021	Combo Left	Aluminum
TIP3020	Combo Left	Black



## STANDARD FRONT STEERING ARMS

Ti22 Front Steering Arms are built with 2024 aluminum for strength and durability. 3" mount, 1" offset with a 5-3/4" split. Black or Plain.

Part No.	Style	Finish
TIP3024	Combo Left	Black
TIP3025	Combo Left	Plain
TIP3012	Right	Black
TIP3013	Right	Plain



## STEERING DAMPER TIP3265

The sprint car steering damper is designed to keep the front tires stable. Momentum is the key to speed and the front tires lead the way. Unnecessary steering wheel corrections not only disrupt the race car, they cause driver fatigue. Time trials can be extremely important and every hundredth of a second counts. This damper is light, adjustable, and installs in less than 2 minutes.

Part No.	Description
<b>Related Components</b>	
TIP3010	RH Steering Arm, Black
TIP3011	RH Steering Arm, Plain
TIP3020	LH Combo Steering Arm, Black
TIP3021	LH Combo Steering Arm, Plain
TIP3250	Steering Stabilizer Clamp 2-1/2"
TIP3251	Steering Stabilizer Clamp 2-3/8"
TIP3252	Steering Stabilizer Clamp 2-1/4"

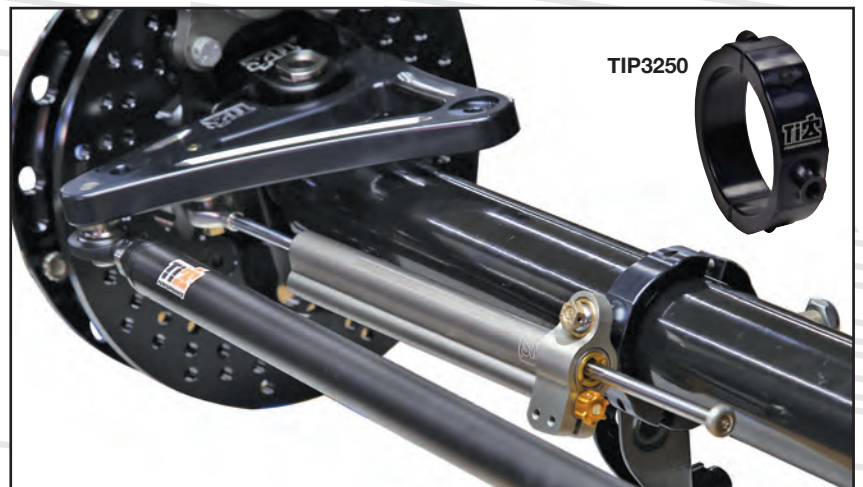

# FRONT END

## STANDARD 50" & 51" FRONT AXLES

Ti22's standard 50" Front Axles are made from 2-1/2" O.D. chromoly tubing. Camber is set at 12° RF and 9° LF. The laser-cut brackets and components are expertly welded for optimal strength, with a black powder-coated or chrome finish for durability.

Part No.	Finish	Length
TIP2000	Black	50"
TIP2002	Chrome	50"
TIP2001*	Black	51"

\*51" axle is +1" on the right side.

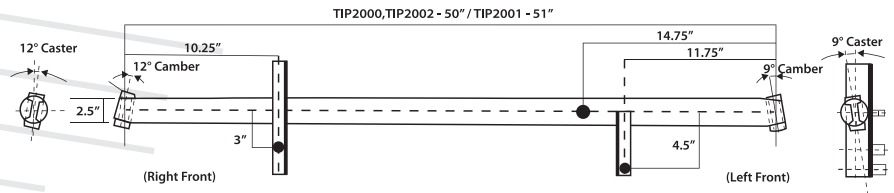

TIP2000



TIP2002



TIP2001

## OUTLAW ADJUSTABLE 50" FRONT AXLE TIP2010

Front Axle Assembly is 50" wide x 2-1/2" O.D., with 9° and 12° front spindles and adjustable shock towers. Natural chromoly.

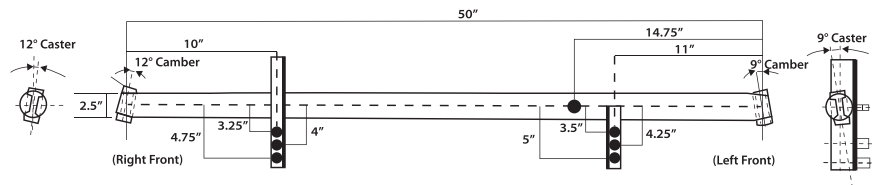

## OUTLAW ADJUSTABLE 51" FRONT AXLE TIP2011

Front Axle Assembly is 51" wide x 2-1/2" O.D., with 9° of caster and camber on the left front and 12° of caster and camber on the right front. adjustable shock towers. Natural chromoly.

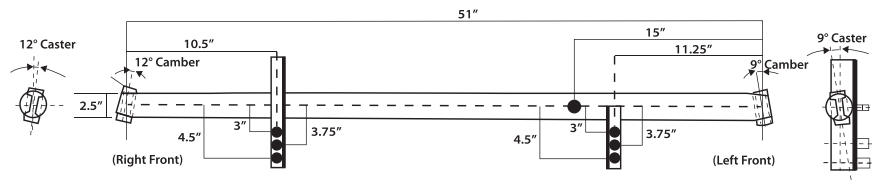

## NON-WING 53" FRONT AXLE TIP2004

Front Axle Assembly is 53" wide x 2-1/4" O.D., with 9° of caster and camber on the left front and 12° of caster and camber on the right front. Natural chromoly.

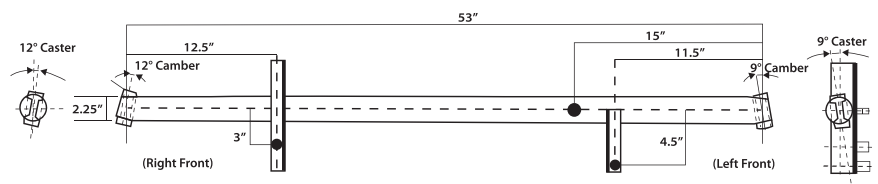

# FRONT END

## ALUMINUM FRONT HUB KITS

These black anodized direct-mount front hubs are forged from weight-saving 2024-T3 aluminum and CNC-machined to precise tolerances. Kits include left hub with rotor mount, right hub without rotor mount, bearings, seals, wheel studs, nuts, and threaded Ti22 screw-in dust caps.

Part No.	Description
TIP2800	Direct-Mount Hub Kit, Standard Bearings, Anodized Black
TIP2801	Lightweight Hub with Standard Bearings, Anodized Black
TIP2802	Standard Hub with Angular Contact Bearings, Anodized Black
TIP2803	Lightweight Hub with Angular Contact Bearings, Anodized Black
TIP2830	Hub Bearing Crush Spacer for Sprint and Midget
TIP1220	Titanium Front Hub Stud Kit
TIP1228	Titanium Nuts



TIP1220



TIP1228



TIP2830



TIP2801



TIP2800



TIP2802

## HUB REPLACEMENT COMPONENTS

Part No.	Description
TIP2808	Right Side Super Lite Only, with Races
TIP2809	Left Side Super Lite Only, with Races
TIP2810	Right Side Aluminum Hub Only, with Races
TIP2812	Left Side Aluminum Hub Only, with Races
TIP2813	Screw-In Dust Cap with Ti22 Logo
TIP2815	O-Ring For Screw-In Dust Cap (TIP2813)
TIP2816	Hub Seal, Single Lip (Grease)
TIP2817	Hub Seal, Double Lip (Oil)
TIP2818	Double Lip Oil Seal Shim, .009"
TIP2819	Bearing Race, Inner and Outer
TIP2821	Front Hub Bearing
TIP2823	Front Wheel Stud, 3/8"-16
TIP2826	Front Flange Nut, 3/8"-16
TIP2822	Angular Contact Front Hub Bearings, Pair
TIP2832	Low-Drag Seal, Sprint Car Front Hub



TIP2813



TIP2816



TIP2821



TIP2823

# FRONT END

## LIGHTWEIGHT ALUMINUM SPINDLES

Forged 7075-T6 aluminum 9° spindles with Ti22 logo on the top, 3-1/4" bolt spacing, and straight snouts. Available with either titanium or steel snouts.

Part No.	Description
TIP2850	Black Anodized Spindle with Steel Snout and Lock Nut, Mount, Weighs 2.47 lbs.
TIP2852	Black Anodized Spindle with Titanium Snout and Lock Nut, Mount, Weighs 2.18 lbs.



TIP2850



TIP2852

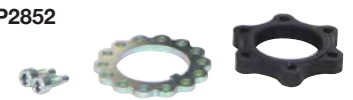

## SPINDLE COMPONENTS

Part No.	Description
TIP2840	Complete Front End Shim Kit
TIP2844	.005" Steel Spindle Shim Kit
TIP2847	.030" Steel Spindle Shim Kit
TIP2856	Spindle Steel Lock Nut, Each
TIP2857	Lock Nut Set Screws, Two
TIP2860	Spindle Bushing, Each
TIP2864	Hollow Steel King Pin, Each
TIP2865	Hollow Titanium King Pin, Each
TIP2866	Aluminum King Pin Cap, Each
TIP2870	Grease Fitting, 45°, Set of 4
TIP2871	Grease Fitting, Straight, Set of 4
TIP2872	Grease Fitting Flat, Straight, Set of 4



TIP2860



TIP2871



TIP2870



TIP2840

TIP2865



TIP2872

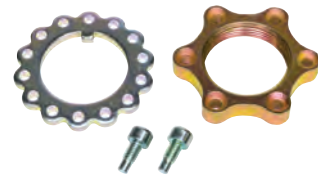

TIP2856



TIP2866

## AXLE TETHER KITS

These Ti22 Performance axle tethers are World Of Outlaws, Allstar, and Knoxville approved.

Part No.	Description
TIP2012	Complete 50" Axle Tether Kit: (2) Axle (1) King Pin
TIP2020	Complete Axle Tether Kit: (2) Axle (1) King Pin, 51"-53" Axle
TIP2013	50" King Pin Tether with Studs
TIP2014	51"-53" King Pin Tether with Studs
TIP2016	Axle Tether (Pair), Wrap Style



TIP2012

# STEERING

## PITMAN ARMS

Constructed from CNC-machined 2024 .75" thick aluminum, Ti22's Pitman Arms are available both straight and with 10° angle broach. The arms are radiused and designed with through-holes to reduce weight. Adjustable from 11-1/8" to 12-1/8"

Part No.	ID Style	Material
TIP3041	10° Broach	Aluminum
TIP3040	10° Broach	Black Aluminum
TIP3045	Straight	Aluminum
TIP3044	Straight	Black Aluminum

## HD PITMAN ARMS

Ti22's HD Pitman Arms are machined from 1" 2024 aluminum. The arm tapers from 1" to 3/4" to reduce potential flex. Straight or 10° angle broached arms are offered.

Part No.	ID Style	Material
TIP3051	10° Broach	Aluminum
TIP3050	10° Broach	Black Aluminum
TIP3055	Straight	Aluminum
TIP3054	Straight	Black Aluminum



TIP3044

TIP3041

TIP3051

TIP3050

## TIE ROD AND DRAG LINK STUD KITS

Specially designed and manufactured from lightweight titanium, low-profile Allen-head studs eliminate the need to drill out steering arms for clearance. 1/2 -20 thread pattern. Sold in kit form or individually.

Part No.	Description
TIP1164	Tie Rod and Drag Link Stud Kit, (4) Studs, (4) Nuts, and (4) Spacers
TIP1166	Tie Rod and Drag Link Stud, (1) Stud, (1) Nut, and (1) Spacer



TIP1164

## PITMAN ARM BOLTS

### TIP1240

Kit includes five titanium bolts to replace standard 3/8"-24 x 1-7/8" hardware found in most torsion and Pitman arms. Bolt kit weighs less than 90 grams.



## QUICK-RELEASE SPLINED COUPLER

Quick-release couplers allow quick, effective steering wheel removal and replacement. Assemblies accept popular 3-bolt pattern steering wheels, and combine black anodized quick releases with rigid steel couplers. Sold complete, assemblies meet stringent SFI 42.1 specifications.

Part No.	Description
TIP3216	Push-On, for Schroeder Steering Gear
TIP3218	Bolt-On, for Lee/Profile Steering Gear

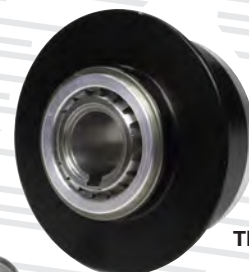

TIP3216

# STEERING

## HALF BOX STEERING GEAR MOUNTS

### TIP3070

Designed for quick installation and removal of the steering gear box. Three hex-cut slots eliminate the need to remove snap ring and end cap, and allow the steering box to slide easily into place. Mounts are CNC-machined from 3/8" thick billet aluminum. Pocketed for strength and weight savings; weighs only 0.54 lbs.



## ADJUSTABLE POWER STEERING PUMP MOUNT

The Adjustable Power Steering Pump Mount is machined from 2024 aluminum. The slotted mount makes it easy to locate the power steering pump on different engine configurations.

Part No.	Material
TIP3061	Aluminum
TIP3062	Black Aluminum

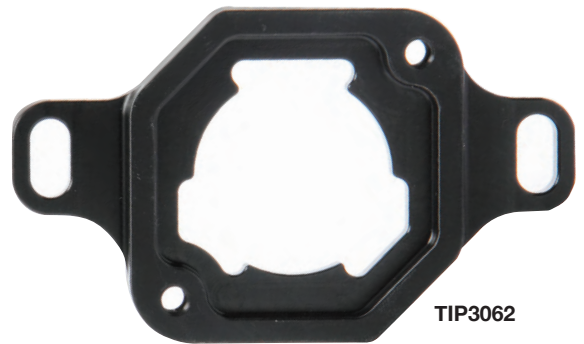

TIP3062

## ADJUSTABLE STEERING BOX MOUNT

This new adjustable steering mount has multiple holes for getting the steering wheel in the perfect location.

Part No.	Material
TIP3080	Adjustable Clamp-On Top Steering Mount
Replacement Parts	
TIP3083	Shut-Off Mount Fits TIP5585 and MPD76504 Fuel Shut-Offs



TIP3080

TIP3083

## ALUMINUM STEERING BOX MOUNTS

Steering box mounts are manufactured from American-made 2024 aluminum. Rigid design keeps steering gear in place. Mounts are offered in three versions.

Part No.	Material
TIP3077	Steering Box Top Mount, MPD Shut-Off on Left
TIP3078	Steering Box Top Mount, Waterman Shut-Off on Left
TIP3079	Steering Box Top Mount, No Shut-Off



TIP3077

TIP3078

TIP3079

# SUSPENSION

## RADIUS RODS

Ti22 offers 1-1/8" O.D. polished 6061 aluminum Radius Rods in 1/2" increments from 18" to 25". Rods are available in raw aluminum or with a black anodized finish.

Size	Raw Aluminum	Black Anodized	Size	Raw Aluminum	Black Anodized
18"	TIP2510-18	TIP2500-18	21.5"	TIP2510-215	TIP2500-215
18.5"	TIP2510-185	TIP2500-185	22"	TIP2510-22	TIP2500-22
19"	TIP2510-19	TIP2500-19	22.5"	TIP2510-225	TIP2500-225
19.5"	TIP2510-195	TIP2500-195	23"	TIP2510-23	TIP2500-23
20"	TIP2510-20	TIP2500-20	23.5"	TIP2510-235	TIP2500-235
20.5"	TIP2510-205	TIP2500-205	24"	TIP2510-24	TIP2500-24
21"	TIP2510-21	TIP2500-21	24.5"	TIP2510-245	TIP2500-245
			25"		TIP2500-25



TIP2510-18



TIP2500-18

## HD RADIUS RODS

Beef up your radius rods on the left front side with the new HD Radius Rods for a stronger, more durable part over the standard aluminum rods. These radius rods are made using 1-1/8" O.D. 4130 chromoly and are black powder coated.

Part No.	Size
TIP2520-225	22.5"
TIP2520-23	23"
TIP2520-235	23.5"



## ROD ENDS

Rod ends can be purchased individually, or in 10 packs.

Part No.	Description	Size
TIP8250	Aluminum RH Male Black	1/2"ID x 5/8" Thread
TIP8250-10	Aluminum RH Male Black 10 Pk.	1/2"ID x 5/8" Thread
TIP8251	Aluminum LH Male Black	1/2"ID x 5/8" Thread
TIP8251-10	Aluminum LH Male Black 10 Pk.	1/2"ID x 5/8" Thread
TIP8260	Narrow Head Moly RH Male Black	1/2"ID x 5/8" Thread
TIP8261	Narrow Head Moly LH Male Black	1/2"ID x 5/8" Thread
TIP8264	4130 Chromoly RH Male	1/2"ID x 5/8" Thread
TIP8265	4130 Chromoly LH Male	1/2"ID x 5/8" Thread
TIP8266	Gold Steel RH	1/2"ID x 5/8" Thread
TIP8267	Gold Steel LH	1/2"ID x 5/8" Thread



TIP8250

TIP8251

TIP8260

TIP8264

TIP8266

## JAM NUTS

Jam nuts can be purchased in 4 packs or 10 packs.

Part No.	Description	Size
TIP8270	Aluminum 4 Pk.	5/8"-18" RH Thin
TIP8270-10	Aluminum 10 Pk.	5/8"-18" RH Thin
TIP8271	Aluminum 4 Pk.	5/8"-18" LH Thin
TIP8271-10	Aluminum 10 Pk.	5/8"-18" LH Thin
TIP8272	Aluminum Black 4 Pk.	5/8"-18" RH Thin
TIP8272-10	Aluminum Black 10 Pk.	5/8"-18" RH Thin
TIP8273	Aluminum Black 4 Pk.	5/8"-18" LH Thin
TIP8273-10	Aluminum Black 10 Pk.	5/8"-18" LH Thin
TIP8276	Steel 4 Pk.	5/8"-18" RH Thin
TIP8276-10	Steel 10 Pk.	5/8"-18" RH Thin
TIP8277	Steel 4 Pk.	5/8"-18" LH Thin
TIP8277-10	Steel 10 Pk.	5/8"-18" LH Thin



TIP8270

TIP8271

TIP8272

TIP8273

TIP8276

TIP8277

# SUSPENSION

## TIE RODS & DRAG LINKS

Ti22's Tie Rods and Drag Links are made using high-strength 1-1/8" O.D. 4130 chromoly tubing.

Part No.	Material	Size	Color	Thread
TIP3100-46	Chromoly	46"	Black	5/8"-18
TIP3100-47	Chromoly	47"	Black	5/8"-18
TIP3100-48	Chromoly	48"	Black	5/8"-18
TIP3100-49	Chromoly	49"	Black	5/8"-18
TIP3100-50	Chromoly	50"	Black	5/8"-18
TIP3100-51	Chromoly	51"	Black	5/8"-18
TIP3110-46	Chromoly	46"	Chrome	5/8"-18



Part No.	Material	Size	Color	Thread
TIP3110-47	Chromoly	47"	Chrome	5/8"-18
TIP3110-48	Chromoly	48"	Chrome	5/8"-18
TIP3110-49	Chromoly	49"	Chrome	5/8"-18
TIP3110-50	Chromoly	50"	Chrome	5/8"-18
TIP3110-51	Chromoly	51"	Chrome	5/8"-18
<b>S-Bend Drag Links</b>				
TIP3101-49	Chromoly	49"	Black	5/8"-18
TIP3101-50	Chromoly	50"	Black	5/8"-18
TIP3111-49	Chromoly	49"	Chrome	5/8"-18
TIP3111-50	Chromoly	50"	Chrome	5/8"-18



## DRAG LINK / TIE ROD STUD KIT

Titanium studs thread into steering and Pitman arms to properly mount steering links. Kit includes (4) 1/2"-20 studs and (8) nylon locking half-nuts.

Part No.	Description
TIP1160	Titanium Kit with Nuts
TIP1164	Button-head Style Kit with Nuts
TIP1166	Button-head Stud with Nut



## RADIUS ROD STUD KIT

Radius rod studs feature 1/2-20 threads and are 3-1/4" long. Kits includes (6) one-nut studs and (12) nylon locking half-nuts.

Part No.	Description	Material
TIP1180	1/2" - 20, 3.250" Long	Titanium Kit
TIP1581	1/2" - 20, 3.250" Long	Steel Kit



## ROD END SPACER KITS

Spacers are made from steel or aluminum and have many uses including spacing rod ends on linkages to prevent binding or provide clearance. Packages of 2.

Part No.	Description	Thickness
TIP8210	Cone Spacers Steel	1/2" I.D. x 1/4" Long
TIP8211	Cone Spacers Steel	1/2" I.D. x 3/8" Long
TIP8212	Cone Spacers Steel	1/2" I.D. x 1/2" Long
TIP8213	Cone Spacers Steel	1/2" I.D. x 3/4" Long
TIP8214	Cone Spacers Steel	1/2" I.D. x 1" Long
TIP8220	Cone Spacers Aluminum	1/2" I.D. x 1/4" Long
TIP8221	Cone Spacers Black	1/2" I.D. x 1/4" Long
TIP8221-10	Cone Spacers Black 10 Pk.	1/2" I.D. x 1/4" Long
TIP8222	Cone Spacers Aluminum	1/2" I.D. x 1/2" Long
TIP8223	Cone Spacers Aluminum	1/2" I.D. x 3/4" Long
TIP8224	Cone Spacers Aluminum	1/2" I.D. x 1" Long





# TORSION ARMS

## FRONT TORSION ARMS

Ti22's arms are constructed of high-strength 2024 aluminum. The arms have been precisely radiused to reduce excess weight while maintaining strength and durability.

The left S-Bend Arms allow for more oversteer clearance on the left front tire—great for non-wing sprint cars!

Right torsion arm is 16-3/4" from center of torsion bar hole to end.

Left torsion arm is 18-3/4" from center of torsion bar hole to end.

Part No.	Style	Material
TIP2361	Standard Right	Aluminum
TIP2360	Standard Right	Aluminum Black
TIP2362	HD Right	Aluminum Black
TIP2374	HD Left	Aluminum Black
TIP2366	Angle Broached, Right	Aluminum Black
TIP2367	Angle Broached, Right	Aluminum
TIP2371	Standard Left	Aluminum
TIP2370	Standard Left	Aluminum Black
TIP2373	S-Bend Left	Aluminum
TIP2372	S-Bend Left	Aluminum Black

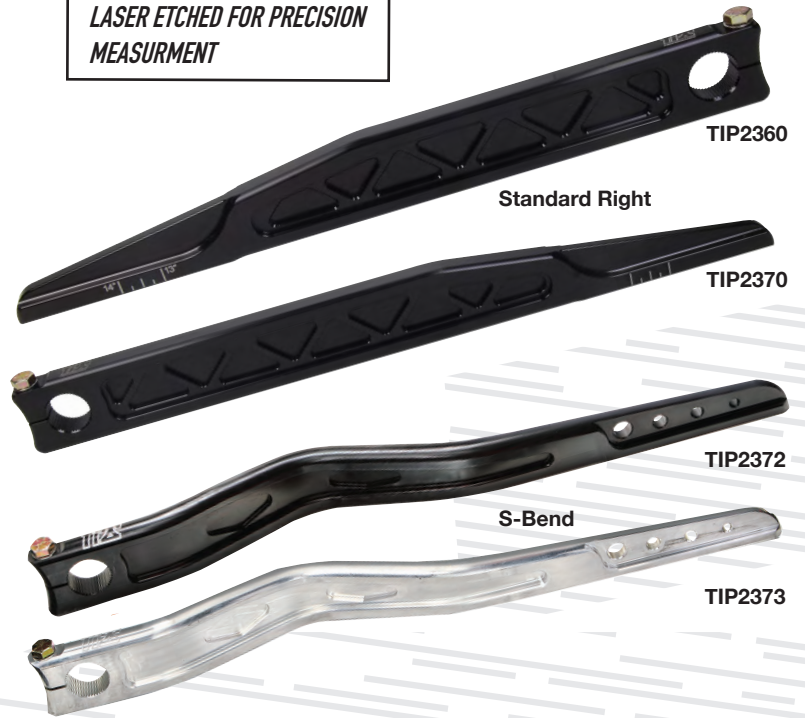
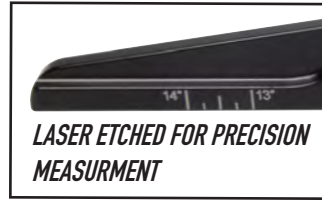

## REAR TORSION ARMS

Precision-engineered design and high-strength 2024 aluminum result in the most durable and reusable torsion arms available. Billet models are CNC-machined from a solid block of 2024 aluminum for added strength and stiffness. Left torsion bars measure 15" from center of torsion hole to end, with a 3-1/4" offset. Right torsion arms measure 13-1/4" from center of torsion hole to end, with a 5" offset.

Both series have the same dimensions and offsets.

The difference is that the 2320 series is machined from billet aluminum instead of cast, and they don't have the machining on the outside surfaces - only on the inside.

Part No.	Style	Material
TIP2301	Standard Right	Aluminum
TIP2300	Standard Right	Aluminum Black
TIP2311	Standard Left	Aluminum
TIP2310	Standard Left	Aluminum Black
TIP2320	Billet Left	Aluminum
TIP2321	Billet Left	Aluminum Black
TIP2322	Billet Right	Aluminum
TIP2323	Billet Right	Aluminum Black



# TORSION STOPS

## TORSION STOPS

With multiple options available, Ti22 has torsion stops for any budget, from lightweight aluminum to titanium for the ultimate in performance. Feature 1-3/4" split. Aluminum stops include steel pinch bolt and adjuster bolt. Chromoly stops include steel pinch bolt and titanium adjuster bolt, and titanium models include titanium hardware. See below for upgraded titanium adjuster bolt.

Part No.	Material
TIP2381	Aluminum
TIP2382	Aluminum Black
TIP2380	4130 Chromoly
TIP2383	Titanium



## TORSION ARM STOP KIT

### TIP2350

Black anodized aluminum/steel threaded rod-style kit. Sold each.



## TORSION ARM AND STOP RETAINING KIT

### TIP2355

This kit holds torsion arm and stop in place if pinch bolts loosen or break. Black. Sold in pairs.



## HARDWARE FOR TITANIUM / CHROMOLY / ALUMINUM STOPS

Part No.	Description
TIP2388	Grade 8 Steel Adjuster Bolt 7/16" -20 thread 2.000" long
TIP2389	Titanium Adjuster Bolt 7/16" -20 thread 1.750" long



## TITANIUM TORSION ARM REPLACEMENT BOLTS

### TIP1240

Keep extra bolts on hand. Lightweight, high-strength titanium.



## TORSION ARM BUSHINGS

Manufactured from friction-reducing bronze or lightweight, durable plastic. Bushing has a 1-1/8" I.D. and .095" wall. Sold each or in packs of ten.

Part No.	Description
TIP2340	.095 Bronze
TIP2340-10	.095 Bronze, 10 Pk.
TIP2342	.095 Plastic
TIP2342-10	.095 Plastic, 10 Pk.
TIP2344	.095 Plastic



# TITANIUM

Titanium components are the gold standard for racers who want maximum performance and minimum weight. From fasteners to chassis components, Ti22 Performance is built on offering top-quality titanium components - it's not just in our heritage, it's in our name.

## LOWER REAR-TO-SHOCK KIT

### TIP1170

Shock stud kits include two studs with large support cones and two nylon locking half-nuts to mount shock to most rear torsion arms. Studs and nuts weigh less than 50 grams.



## DRAG LINK /TIE ROD STUD KIT

### TIP1160

Kit includes four studs with nylon locking half-nuts that thread into steering and pitman arms with 1/2"-20 threads to properly mount steering links. 2-1/2" long.



## TIE ROD AND DRAG LINK KITS

Specially designed and manufactured from lightweight titanium, low-profile Allen-head studs eliminate the need to drill out steering arms for clearance. Sold in kit form or individually.

Part No.	Description
TIP1164	Tie Rod and Drag Link Stud Kit, (4) Studs, (4) Nuts, and (4) Spacers
TIP1166	Tie Rod and Drag Link Stud, (1) Stud, (1) Nut, and (1) Spacer



## SHOCK STUD KIT

### TIP1060

Shock stud kit includes (4) studs and (4) nylon locking half-nuts to mount shock to chassis or front axle. 2" studs have 1/2"-20 threads that thread directly into pre-threaded bungs.



## BUMPER BOLT KIT

### TIP1102

Kit contains (14) #10-32 x 1-1/2" hex-head bolts and (14) nylon lock nuts for mounting bumpers or nerf bars.

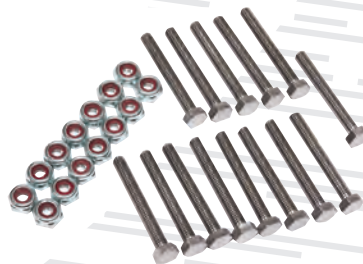

## FRONT ROTOR BOLTS

### TIP1080

Bolts are 1/2" -20 thread 1" long.



## U-JOINT BOLT KIT

### TIP1140

For the weigh-conscious racer, kit includes (4) 7/16"-20 x 7/8" long premium titanium fasteners.



# TITANIUM

## BEAD LOCK BOLT KIT

### TIP1010

Titanium bolt kit includes (16) lightweight 5/16"-18 x 1" long hex-head bolts for added weight savings.



## SHOCK STUD FOR DOUBLE TOWER

### TIP1068

Engineered exclusively for 2017 and newer Triple X sprint chassis utilizing billet, double-hole front shock towers, super-light titanium stud has 1/2"-20 threads and includes a built-in shock spacer.



## FUEL PUMP BOLT KIT

### TIP1136

Kit includes specialized, lightweight titanium hex-head fasteners to retain the fuel pump.



## ROCK SCREEN CLAMP BOLTS

### TIP1210

Required to retain the rock screen, 1/4"-20 x 3/4" long bolts are manufactured from lightweight titanium. Sold per pair.



## FRONT HUB STUD KIT WITH NUTS

### TIP1220

Used to secure the front hubs, kit includes (5) button head, 3/8"-16 x 1-1/4" long titanium studs and (5) flanged hex-head titanium nuts.



## FRONT HUB FLANGE NUTS

### TIP1228

Flanged, hex-head titanium nuts include 3/8"-16 threads are used to retain the front hubs. Set of five. The same flange nuts as those included in the TIP1220 kit.



# TITANIUM

## **TORSION AND PITMAN ARM BOLT KIT**

### **TIP1240**

Kit includes (5) 3/8"-24 x 1.875" long, hex-head titanium pinch bolts required to secure Pitman/torsion arms. Set of five complete with AN washers.



## **TORSION STOP BOLT WITH NUT**

### **TIP2389**

Lightweight titanium, 7/16"-20 hex head bolt is 1-3/4" long and is sold complete with a hex head nut, allowing precise adjustments with a 9/16" wrench. Specially-relieved bolt end prevents mushrooming.



## **JACOB'S LADDER BOLT KIT WITH FLAT HEADS**

### **TIP2427**

Required to retain a Jacob's Ladder, lightweight titanium bolt kit includes (2) flat head, Allen key 3/8"-24 x 1.875" long bolts and (2) 3/8"-24 hex-head, flanged nuts.



## **FRONT CALIPER MOUNT BOLTS**

### **TIP1084**

Front caliper mount bolts are 2" long with 1/2"-20 thread.



## **HEADER STUD KIT**

### **TIP1120**

Header stud kit bolts are 3/8"-16 base thread with 3/8"-24 top thread and are 1-1/2" long.



## **HEADER FLANGE NUT SET**

### **TIP1124**

Titanium 3/8"-24 (fine thread) nuts feature 12-point heads for improved wrenching. Set of 14. Accompanying studs must be purchased separately.



## **INBOARD CALIPER BOLT KIT**

### **TIP1090**

Inboard caliper bolt kit bolts have 7/16"-14 thread and are 1-1/2" long.



## **JACOBS LADDER QUICK PIN KIT**

### **TIP1070**

Pins are 1/2" diameter and 1-1/2" long.



# TITANIUM

## RADIUS ROD STUD KIT

### TIP1180

Radius rod stud kit bolts are 1/2"-20 thread and are 3-1/4" long.



## TORQUE TUBE STUD KIT

### TIP1050

Made of grade 5 titanium, TI22's studs are 1.875" in length, have a 3/8"-16 base thread, and a 3/8"-24 top thread. Kit includes six (6) each of titanium studs, washers, and locknuts.



## ROCK SCREEN

Constructed of lightweight titanium rod, TI22's Rock Screen provides dependable protection from rocks and other debris.

Part No.	Description
TIP4021	Rock Screen
<b>Replacement Parts</b>	
TIP4125	Rock Screen Clamp
TIP1210	Titanium Rock Screen Bolts Pk. of 2 1-3/8"

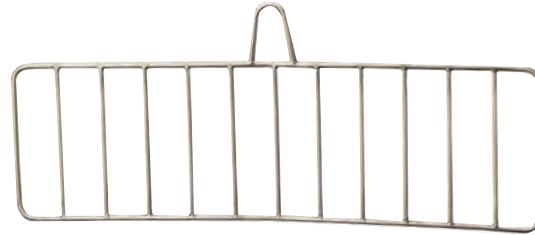

TIP4021

TIP1210



TIP4125

## MINI-SPRINT/MIDGET ROCK SCREEN

Engineered for Mini-Sprints or Midgets, Rock Screen is 22-3/4" x 8-1/2" in size and manufactured from lightweight titanium rod. Offers the driver superior protection from rocks and debris.

Part No.	Description
TIP3885	Rock Screen
<b>Replacement Parts</b>	
TIP3886	Rock Screen Clamp 1-1/4"



TIP3885



TIP3886

## TORSION STOP

### TIP2383

The titanium Torsion Stop features a 1-3/4" split. Made from high-grade titanium, the stop saves 5.6 oz. per stop over the steel stop. Includes adjuster bolt and clamp bolt.



## TITANIUM KING PINS

Part No.	Description
TIP2865	5/8"-18 thread Pin Sold Individually
TIP2866	Cap Aluminum Tip Sold Individually



TIP2865



TIP2866

# TITANIUM

## WING TREE

Save more than a 1/2 lb. by using the titanium wing tree rather than chromoly version. 16" tall.

Part No.	Description
TIP6002	Titanium Wing Tree with Inserts
TIP6012	Titanium Wing Tree Insert
TIP6005	Titanium Wing Tree, Round with Inserts



TIP6012

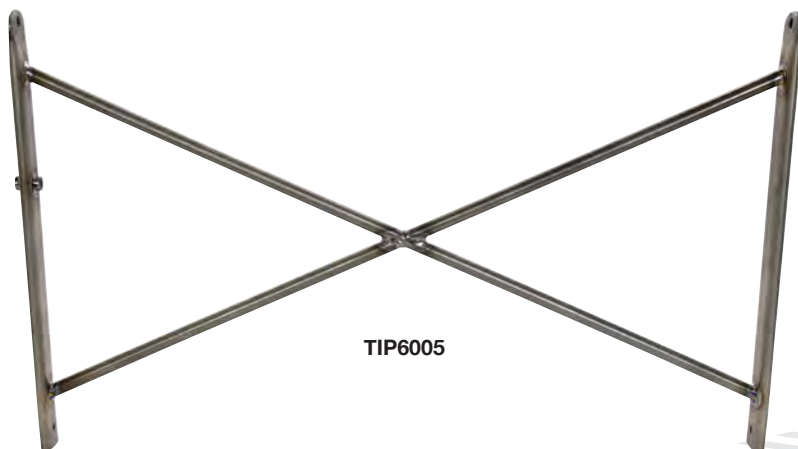

TIP6005

## TOP WING PIN KIT TIP6115



## WING CYLINDER STUDS

Part No.	Description
TIP6118	Titanium 3/8" x 24"
TIP6119	Titanium 5/16" x 24"

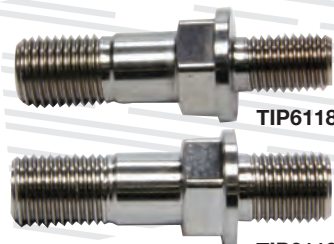

TIP6118

TIP6119

## ADJUSTABLE NOSE WING POSTS TIP6108

Titanium Adjustable Nose Wing Post allows adjustments for changing track conditions. 13" long with a 1" offset. 1" O.D. titanium tubing means maximum strength at minimal weight. Sold individually.



## STANDARD NOSE WING POSTS TIP6103

Ti22's Standard Nose Wing Post is now offered in lightweight titanium to reduce weight even further, without sacrificing strength. 13" long with a 1" offset. Sold individually.



## BRAKE AND THROTTLE PEDALS

Lightweight and strong, Ti22 Titanium Brake and Throttle Pedal Levers are available with 0" and 1" rise for raised rail cars.

Part No.	Description
TIP4002	0" Raised Rail Brake Pedal 14-1/2" long from second hole, and 5-1/4" wide
TIP4000	1" Raised Rail Brake Pedal 13-1/2" long from second hole, and 5-1/4" wide
TIP4105	Throttle Pedal Frame mount



TIP4000



TIP4002



TIP4105

# BRAKE AND PEDAL

## BRAKE AND THROTTLE PEDALS

Ti22 Brake Pedals are offered for 0" and 1" raised rail cars. Both titanium and chromoly options are offered. Brake pedal levers and 5-1/4" wide.

Part No.	Style	Material
TIP4002	Brake Pedal Straight Rail, 14-1/2" long from second hole	Titanium
TIP4001	Brake Pedal 1" Raised Rail, 13-1/2" long from second hole	Chromoly
TIP4000	Brake Pedal 1" Raised Rail, 13-1/2" long from second hole	Titanium
TIP4105	Throttle Pedal Frame mount	Titanium
TIP4100	Throttle Pedal Frame mount	Chromoly
TIP4103	Throttle Pedal Floor mount Plain	Aluminum
TIP4104	Throttle Pedal Floor mount Black	Aluminum



## HEEL RISERS

Heel risers measure 4-1/2" wide and provide the driver with improved comfort and pedal feel. Choose from 1" or 1-1/2" tall versions, in carbon fiber or aluminum. Non-skid pad included.

Part No.	Style
TIP4110	Carbon Fiber, 1" Tall
TIP4111	Aluminum, 1" Tall
TIP4112	Carbon Fiber, 1-1/2" Tall
TIP4113	Aluminum, 1-1/2" Tall

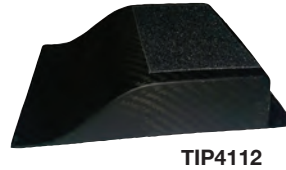

## BRAKE ROTORS AND REAR MOUNTS

Durable billet aluminum adapters accept most popular rotors. Designed for rear inboard mounting, adapters are black anodized. Sold individually.

Part No.	Style
TIP4015	2.750" x 42-spline center and 8 x 7.00" bolt pattern
TIP4018	3" X 5" 42-spline center and 6.50"W x 0.30"H x 9.00"L
TIP4060	10" Aluminum Front Brake Rotor, 3-Lug
TIP4062	11" Aluminum Front Brake Rotor, 3-Lug



## DRY BRAKE

Designed to provide quick brake line disconnection without fluid loss or air ingestion. Aluminum dry brake couplings are offered in -3AN or -4AN versions.

Part No.	Style
TIP4510	-3AN Dry Brake Coupling
TIP4515	-4AN Dry Brake Coupling



## STAUBLI DRY BRAKE

Staubli premium dry brakes offer a superior seal and will not lose pressure during use.

Part No.	Style
TIP4500	-3AN Complete Kit
TIP4501	-3AN Male Side Fitting Only
TIP4502	-3AN Female Side Fitting Only





# BRAKE AND PEDAL

## FRONT CALIPER MOUNT

CNC-machined from 2024 aluminum. The caliper mount holes are spaced at 3-1/4" and will work with 10-1/8" and 10-7/8" rotors and come with bolts. Steel mounting hardware included.

Part No.	Style
<b>10-1/8" Rotors</b>	
TIP4012	Black
TIP4013	Clear
<b>10-7/8" Rotors</b>	
TIP4010	Black
TIP4011	Clear



## BRAKE MOUNT

### TIP2029

Brake mount for standard and non-wing birdcages.



## FRONT ROTOR BOLTS

Allen-head bolts, 1/2"-20 x 1", available in steel or titanium. Sold in kits of 3.

Part No.	Style
TIP1580	Steel Kit
TIP1080	Titanium Kit



## INBOARD CALIPER BOLT KITS

Hex-head bolts, 7/16"-14 x 1-1/2", available in steel or titanium. Sold in kits of 2. Washers included.

Part No.	Style
TIP1590	Steel
TIP1090	Titanium



## CALIPER MOUNTING BOLTS

Allen-head bolts, 1/2"-20 x 2", available in steel or titanium. Sold in kits of 2.

Part No.	Style
TIP1584	Steel Kit
TIP1084	Titanium Kit



## MASTER CYLINDER RETURN SPRING KIT

### TIP4219

Engineered to prevent the driver from overheating the brakes, high-strength coil spring is sold complete with black anodized, billet aluminum retainer. Fits all master cylinders.



# DRIVE LINE

## TORQUE TUBE

### TIP4702

Made from lightweight, high-strength 6061-T6 aluminum, the Ti22 torque tube is 2.900" in diameter, 26-3/4" long, and fits any 40" car. Black anodized.



## TORQUE BALL HOUSING KIT STEEL

### TIP4710

Assembly includes stamped steel firewall housing, hydroformed aluminum torque ball, rubber torque ball dust boot, forged aluminum retaining collar, and 4 highnuts. Weighs 4 lbs. 2 oz.

Part No.	Description
<b>Replacement Components</b>	
TIP4720	Aluminum Torque Ball, Hard Anodized for Steel Housing Only
TIP4722	Forged Aluminum Retaining Collar
TIP4724	Highnut for Torque Ball Housing, Steel, 4-Pk.
TIP4728	Rubber Torque Ball Dust Boot
TIP1050	Torque Tube Stud Kit



TIP1050



TIP4724



TIP4710



TIP4720

## BILLET ALUMINUM TORQUE BALL HOUSING AND BALL

These housings are very rigid and strong to retain debris in the event of a U-joint failure. The torque ball is CNC-machined for strength and durability.

Part No.	Description
TIP4712	Billet Housing
TIP4714	Torque Ball for Billet Housing



TIP4712



TIP4714

## HD ALUMINUM U-JOINT CHEVY/ CHRYSLER

### TIP4735

Heavy-duty billet aluminum assembly features 32-spline and four-bolt flange, and is designed to endure the rigors of open wheel racing. Fitted with a premium Spicer U-joint, CNC-machined assembly is black anodized for corrosion resistance and mates to the rear of Chevy or Chrysler engines. Sold complete with premium fasteners.

## U-JOINTS

Standard-duty U-joint assemblies are exceptionally lightweight, while remaining very durable. Black anodized billet aluminum units are offered with choice of 16- or 32-spline with four-bolt flanges, are fitted with Spicer U-joints, and mate to the rear of Chevy or Chrysler engines. Sold complete with premium fasteners.

Part No.	Description
TIP4730	16 Spline
TIP4732	32 Spline
<b>Replacement Components</b>	
TIP4731	Universal Joint Spring Kit for TIP4730
TIP4733	Universal Joint Spring Kit for TIP4732



TIP4735



TIP4732



TIP4730

# WHEELS

## SPLINED REAR WHEEL CENTER

This 100% CNC-machined black wheel center is manufactured from forged 2024-T3 aluminum. Fits most popular brands of Wide 5 rear wheels, and is stronger than the original center. Sold individually.

Part No.	Description
TIP2890	Splined Rear Wheel Center
Replacement Component	
TIP2898	Threaded Wheel Insert, 1/4"-20 Self-Clinching



## REAR AXLE WHEEL NUT

Engineered exclusively for sprints, wheel nuts are manufactured from rigid billet aluminum and black powder coat finished. Sold each.

Part No.	Description
TIP2876	Rear Axle Wheel Nut, LH Threads
TIP2877	Rear Axle Wheel Nut, RH Threads



## AXLE SPACER KIT TIP2880

Easily adjust wheel spacing on the axle with these black anodized billet aluminum axle spacers. 10-piece kit includes (2) 3/8", (2) 3/4", and (1) 2" straight spacers, (2) 1" splined spacers, and (1) 1-1/4", (1) 2", and (1) 2-1/2" tapered splined spacers.



## DISCONNECTS AND COMPONENTS

Wheel disconnects allow for use of pneumatic bleeders to maintain constant air pressure and consistent stagger, and can also be used for quick filling. Available in black aluminum or white plastic, and sold individually or in sets of 4. Additional accessories and replacement parts also available.

Part No.	Description	Material
TIP4400	Wheel Disconnect	Black Aluminum
TIP4402	Wheel Disconnects 4 Pk	Black Aluminum
TIP4404	Wheel Disconnect	Plastic
TIP4406	Wheel Disconnects 4 Pk	Plastic
TIP4408	Wheel Disconnect Sealing 4 Pk	Washer
TIP4409	Wheel Disconnect 4 Pk	Grommets
TIP4410	Bleeder Plugs for Wheel	Disconnect Pair
TIP4413	Thread on Bleeder Screen	Aluminum
TIP4415	Schrader Valves 2 Pk	Aluminum
TIP4417	Bleeder Hose End	Aluminum



## WHEEL COVER RETAINING BOLT KIT

Offered with choice of steel or lightweight titanium bolts, kits include the necessary screw-in inserts, rivets, "E"-clips, and bolts to retain one mud cover to wheel.

Part No.	Description
TIP4440	Wheel Cover Retaining Bolt Kit, Steel
TIP4442	Wheel Cover Retaining Bolt Kit, Titanium



# WING

## WING TREES

Ti22's Wing Tree is designed to be a lightweight addition. With an extra inch added to the length, the tree is able to achieve the wing angles needed for a variety of wings. Both titanium and chromoly versions are offered. The Wing Tree inserts are fabricated with 1/4" offset to accommodate varying tab dimensions. The tree comes with bottom inserts for easy wing adjustment.

Part No.	Style	Material
TIP6000	Top Wing Tree Assembly 16"H x 26"W	Black Steel
TIP6001	Top Wing Tree Assembly 16"H x 26"W	Plated Steel
TIP6002	Top Wing Tree Assembly 16"H x 26"W	Titanium
TIP6004	Aero Wing Tree Assembly 16"H x 26"W	Black Steel
TIP6006	Aero Wing Tree Insert	Black Steel
TIP6010	Wing Tree Insert Black	Black Steel
TIP6011	Wing Tree Insert Plated	Plated Steel
TIP6012	Wing Tree Insert, Sold as Pair	Titanium

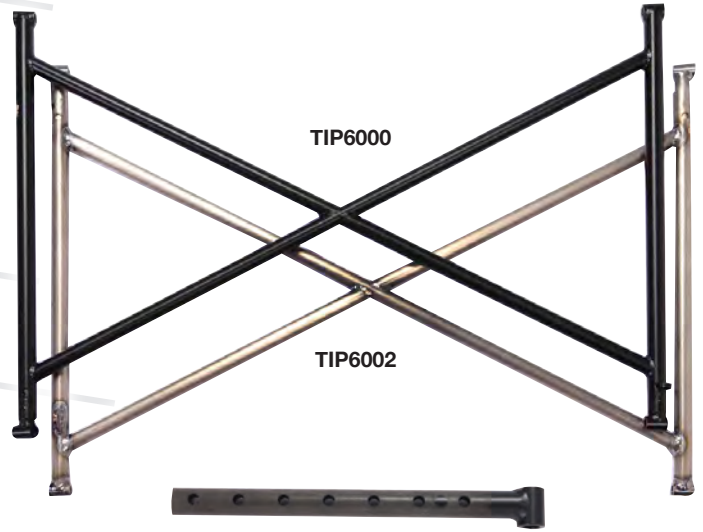

Insert with 1/4" Offset  
TIP6010

## AERO WING TREES

Engineered to place the wing at the optimum angle for wedge-style sprint chassis, Aero Wing Tree is constructed from durable 4130 steel and black powder finished. The "X" design adds strength, while 3/4" holes provide up to 3" of adjustment. Adjuster pins must be purchased separately.

Part No.	Description	Material
TIP6004	Aero Wing Tree with Pins, 16"	Black Steel
TIP6005	Aero Wing Tree with Pins, 16"	Titanium
<b>Related Components</b>		
TIP6006	Aero Wing Tree Insert	Black Aluminum
TIP6115	Top Wing Pin Kit	Titanium
TIP6118	Wing Cylinder Stud	5/16"-24 Titanium
TIP6119	Wing Cylinder Stud	3/8"-24 Titanium



## MANUAL WING SLIDERS

Manual sliders allow easy wing adjustment and are machined to resist binding.

Part No.	Description
TIP6030	Manual Wing Adjustment Kit, Black, 15" Collapsed
TIP6032	Manual Wing Adjustment Kit, Black, 20" Collapsed



## TUBULAR NOSE WING STRAP

Tubular Nose Wing Straps are available in both adjustable and non-adjustable formats, and are made from plated 4130 steel tubing. Non-adjustable straps are 10-3/4" long (hole-to-hole) from the shock towers to the nose wing side boards, and weigh 5 oz. Adjustable straps have welded tabs with adjustable bottom mounts (6", 6-3/4", 7-1/2") and weigh 4.5 oz. Straps do not interrupt airflow. Sold individually.

Part No.	Material
TIP6150	Chrome-Plated Steel
TIP6151	Chrome-Plated Black Steel
TIP6152	Adjustable Steel
TIP6153	Adjustable Black Steel



TIP6150

TIP6151

TIP6152

TIP6153

## CARBON FIBER WING CAPS

Part No.	Style
TIP6040	Top Wing Cap 59-3/4" Wide Carbon Fiber
TIP6042	Nose Wing Cap 35-3/4" Wide Carbon Fiber



TIP6042

TIP6040

## NOSE WING POSTS

### TIP6103

Made from 1" O.D. tubing, this titanium Nose Wing Post is 13" long with a 3" offset.



TIP6103

## QUICK PINS

Easily make wing adjustments on the fly with these 1/4" Quick Pins.

Part No.	Style
TIP6114	Quick Pins
TIP6115	Wing Tree Pins



TIP6115

# WING

## STRAIGHT NOSE WING POSTS

Straight Nose Wing Posts are available in aluminum or 4130 chromoly steel, in natural or black finish. Clamp into nose wing post clamps that secure to the torsion tube pinch clamps to connect the center of the nose wing. 12" long, 1" O.D.tubing. Sold individually.

Part No.	Description	Material
TIP6124	Front Wing Post Straight	Chrome-Plated Steel
TIP6125	Front Wing Post Straight	Natural Aluminum
TIP6126	Front Wing Post Straight	Black Steel
TIP6127	Front Wing Post Straight	Black Aluminum



TIP6124 TIP6125 TIP6126 TIP6127

## TOP WING POSTS

Ti22's Top Wing Posts now feature a full circle bracket, giving the "T" two contact points instead of one. An aluminum insert has been added to the titanium post for additional strength. The overall length is 12". Sold individually.

Part No.	Style	Length
TIP6016	Top Wing Post Roller	12"
TIP6017	Top Wing Post Plated	12"
TIP6018	Top Wing Post Black	12"



## CLAMP-ON NOSE WING MOUNTS

Aero Style Aluminum Nose Wing Front Post Clamps (for clamping nose wing post to the torsion tubes). Clamps securely to torsion tubes. Has aero-style I.D. for nose wing front post. Bolts included. Angled perfectly to reach side panel of nose wing with posts. For use with our Aero Style Right and Left Nose Wing Posts. Sold individually.

Part No.	Description	Material
TIP6133	Aero Nose Wing Clamp	Black Aluminum
TIP6134	Aero Nose Wing Post RH	Black Steel
TIP6135	Aero Nose Wing Post LH	Black Steel



TIP6133



TIP6134 TIP6135

## FORWARD-BENT NOSE WING POSTS

Forward-Bent Nose Wing Posts are available in natural or black anodized aluminum, or black or chrome-plated 4130 chromoly steel. Clamp into nose wing post clamps that secure to the torsion tube pinch clamps to connect the center of the nose wing. 12" long, 1" O.D. tubing. Sold individually.

Part No.	Description	Material
TIP6120	Forward-Bent Nose Wing Post	Chrome Plated Steel
TIP6121	Forward-Bent Nose Wing Post	Natural Aluminum
TIP6122	Forward-Bent Nose Wing Post	Black Steel
TIP6123	Forward-Bent Nose Wing Post	Black Aluminum



TIP6122 TIP6123 TIP6120 TIP6121

## ADJUSTABLE NOSE WING POSTS

The Adjustable Nose Wing Posts provide the flexibility to set your wing as needed without having to switch or rebend your current posts. The adjuster provides for 3/4" of extra adjustment. Sold individually.

Part No.	Description	Finish
TIP6128	Front Wing Post RH Adj. to Side Board	Chrome-Plated Steel
TIP6129	Front Wing Post LH Adj. to Side Board	Chrome Plated Steel
TIP6130	Front Wing Post RH Adj. to Side Board	Black Steel
TIP6131	Front Wing Post LH Adj. to Side Board	Black Steel



TIP6129

TIP6131

## FLAT NOSE WING STRAPS

Ti22 Flat Nose Wing Straps are available in natural or black powder coated stainless steel, and weigh only 5 oz. Overall dimensions are 11-1/2" L x 1-1/8" wide, and height is adjustable between 7-3/4" and 10-1/2" in 3/4" increments. Sold individually.

Part No.	Material
TIP6156	Stainless
TIP6157	Black Stainless



TIP6156

TIP6157

## BENT TO SIDE BOARD ADJUSTABLE STRAPS

Side board mount, black anodized aluminum nose wing rear strap straps are strong and light. Straps have a width of 1" and overall length of 11". Maximum height is 10-1/2" and minimum is 8-1/2". Offset is 5-1/2" with an adjustment of 1/2". Total weight is 0.23 lbs. Sold individually.

Part No.	Material
TIP6158	Aluminum
TIP6159	Black Aluminum



TIP6159

TIP6158

# BUMPERS

## BUMPERS & NERFS

Fabricated from 1" O.D. stainless steel, 4130 chromoly, or aluminum. Bumpers and nerfs feature specially swaged ends to fit easily into the chassis.

Part No.	Description	Material	Color
TIP7000	19 in. On-Center Front Bumper	Stainless Steel	Bare
TIP7001	19 in. On-Center Front Bumper	Aluminum	Bare
TIP7002	Stacked Front Bumper	Stainless Steel	Bare
TIP7003	Stacked Front Bumper	Aluminum	Bare
TIP7005	Stacked Front Bumper	4130 Chromoly	Black
TIP7006	19 in. On-Center Front Bumper	4130 Chromoly	Black
TIP7008	Front Bumper Pretzel Style	Stainless Steel	Bare
TIP7010	LH Nerf Bar	Stainless Steel	Bare
TIP7011	LH Nerf Bar 3-Point	Stainless Steel	Bare
TIP7012	LH Nerf Bar 3-Point	4130 Chromoly	Black
TIP7013	LH Nerf Bar 2-Point	Stainless Steel	Bare
TIP7014	LH Nerf Bar 2-Point	4130 Chromoly Ultra-Lt.	Black
TIP7015	LH Nerf Bar 3-Point Battle Bar	Stainless Steel	Bare
TIP7020	RH Nerf Bar 3-Point	Stainless Steel	Bare
TIP7021	RH Nerf Bar 3-Point	4130 Chromoly	Black
TIP7022	RH Nerf Bar 2-Point	Stainless Ultra-Light	Bare
TIP7023	RH Nerf Bar 2-Point	4130 Chromoly Ultra-Lt.	Black
TIP7024	RH Nerf Bar 3-Point Battle Bar	Stainless Steel	Bare
TIP7030	Lightweight Rear Bumper	Stainless Steel	Bare
TIP7031	Lightweight Rear Bumper No Brace	4130 Chromoly	Black
TIP7032	Rear Bumper w/Brace	Stainless Steel	Bare
TIP7033	Rear Bumper w/Brace	4130 Chromoly	Black
TIP7036	Rear Bumper Basket Style	Stainless Steel	Bare
TIP7037	Rear Bumper Basket Style	4130 Chromoly	Black

TIP7008



TIP7010



TIP7011



TIP7012



TIP7013



TIP7000



TIP7001



TIP7002



TIP7003



TIP7005



TIP7006





# BUMPERS

TIP7014



TIP7022



TIP7031



TIP7015



TIP7023



TIP7032



TIP7020



TIP7024



TIP7033



TIP7021



TIP7030

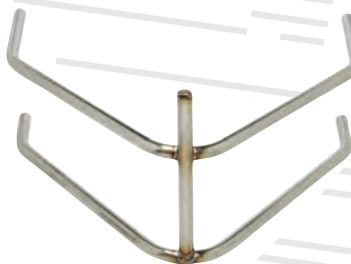

TIP7036

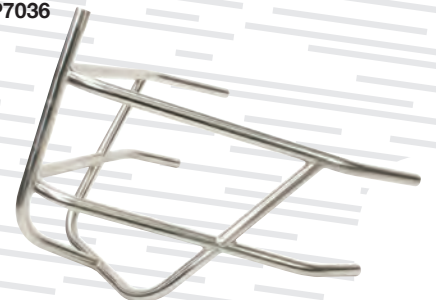

TIP7037



## BUMPER BOLT KIT

### TIP1102

Kit contains 14 #10-32 x 1-1/2" titanium bolts for the bumper, nerfs, and torque tube hoop and includes all lock nuts.

# ENGINE

## BILLET CAM PLATE SEAL

Manufactured with high-quality SKF seals, these billet aluminum plates are precision-machined to exact dimensions, providing maximum sealing to prevent any possible leakage.

Part No.	Description
TIP5080	Billet Cam Plate with Seal, SB Chevy Steel Block 2.100" O.D.
TIP5082	Billet Cam Plate with Seal, Rodeck Aluminum Block 2.256" O.D.
TIP5084	Billet Cam Plate with Seal, SB Chevy Dart Little M Block 2.384" O.D.
TIP5088	Replacement Cam Seal Only
TIP5089	Replacement Cam Spud 9/16 -18 Right Hand, 3/8" Hex



TIP5089

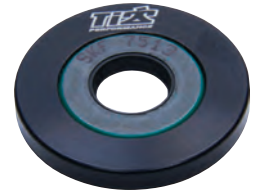

TIP5080

## IN-TANK FUEL FILTERS

Manufactured with 60-micron pleated stainless mesh filter.

Part No.	Description
TIP5140	In-Tank Filter, -12AN Straight Inlet Fitting
TIP5142	In-Tank Filter, 90° Rotating 3/4" Slip-On Style Inlet



TIP5142



TIP5140

## ADJUSTABLE TAIL TANK CLAMP SET

### TIP8012

Clamps feature an adjustable design to allow mounting virtually any brand of fuel tank. Lightweight, CNC-machined aluminum clamps mount to the tail tank bar and utilize recessed bolt heads to conceal and protect them from debris.



TIP5004

## FRONT AND REAR MOTOR PLATES

Manufactured from 3/8" thick 6061 aluminum. These raised rail rear plates are lightened on the inside to keep dirt from getting trapped in lightening pockets. Designed to fit both standard and raised cam engines, the plates have multiple drilled and tapped holes for mounting pumps and accessories. Lower edge holes allow mounting floor pan securely to motor plate. Available in natural or black anodized finish. 24-5/8"W x 12-7/16"H, weighs 7.5 lbs.

Part No.	Description
TIP5002	Rear Motor Plate, Plain
TIP5004	Rear Motor Plate, Black
TIP5010	Front Motor Plate, Plain
TIP5012	Front Motor Plate, Black

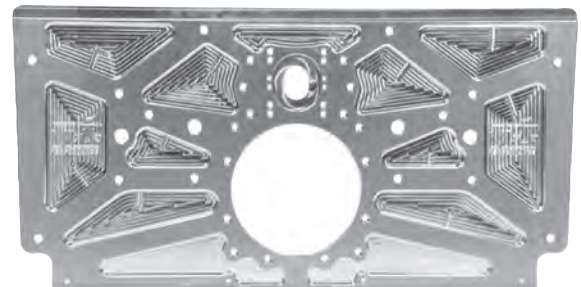

TIP5012



TIP5010



## EXHAUST PORT BLOCKOFFS

Keep the engine clean and dry in storage or when performing maintenance.

Part No.	Description
TIP5120	Aluminum Exhaust Port Blockoffs - Spreadport
TIP5124	Aluminum Exhaust Port Blockoffs - Standard Port



## SPARK PLUG GUARDS

### TIP5100

Spark Plug Guards have lightweight brackets that bolt to the headers, keeping plugs clean and safe.

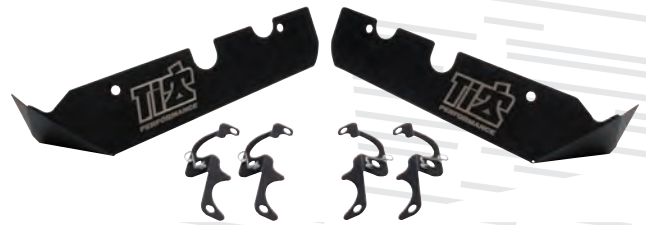

## DOUBLE BEARING BELL CRANK

### TIP5536

These Double Bearing Bell Cranks are ultra smooth and make for great throttle response.



## THROTTLE PEDALS

Part No.	Description
TIP4100	Frame Mount
TIP4103	Floor Mount, Plain
TIP4104	Floor Mount, Black
TIP4105	Frame Mount, Titanium



## SPRINT CAR HOOD AND TANK COVER

Tail tank cover helps reduce heat build-up from the sun, keeping fuel cooler. Silver-colored aluminized insulated mat includes strap.

Part No.	Description
TIP5460	Tank Cover
TIP5465	Hood Blanket

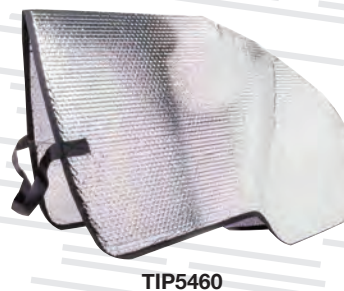

# ENGINE

## FUEL BLOCK

### TIP5500

Comes with three -6AN female ports, one -8AN female port, male adapter fittings included, one -8AN male fitting, a black anodized aluminum, each.



## IN-LINE FUEL FILTERS

Black anodized, billet aluminum fuel filters. Available in two different sizes: short style with -6AN male inlet/outlet fittings or long style -12AN male inlet/outlet fittings. Stainless steel replacement elements available.

Part No.	Description
TIP5526	-6AN Short Style Filter, 70-Micron Stainless Element
TIP5528	-12AN Long Style Filter, 100-Micron Stainless Element
Replacement Components	
TIP5527	Replacement Element for TIP5526 Short Filter, 70-Micron
TIP5529	Replacement Element for TIP5528 Long Filter, 100-Micron
TIP5523	Replacement O-Ring Kit for TIP5526/TIP5528



TIP5526

## IN-LINE FUEL FILTERS WITH BUILT-IN SHUT-OFF VALVE

Black anodized billet aluminum 100-micron fuel filters. Available in -6AN, -8AN, -10AN, and -12AN. Stainless steel replacement elements available.

Part No.	Description
TIP5506	-6AN
TIP5508	-8AN
TIP5510	-10AN
TIP5512	-12AN
Replacement Components	
TIP5520	Replacement Element
TIP5522	Replacement O-Ring Kit



## BILLET FUEL FILTER MOUNTING CLAMPS

Part No.	Description
Engine Mount Fuel Filter Clamp	
TIP5540	Designed to Mount #6 Pressure Filter to the Fuel Injector Bridge, Two-Piece Black Anodized Aluminum Billet Construction
Fuel Filter Clamp	
TIP5544	Designed to Mount 2" Diameter Filter on 1-1/4" Tube, Black Anodized Billet Construction with Countersunk Allen Bolt for Easy Tightening
TIP5546	Designed to Mount 2" Diameter Filter on 1-3/8" Tube, Black Anodized Billet Construction with Countersunk Allen Bolt for Easy Tightening
TIP5548	Designed to Mount 2" Diameter Filter on 1-1/2" Tube, Black Anodized Billet Construction with Countersunk Allen Bolt for Easy Tightening



TIP5540

## FUEL BLOCK MOUNTING BRACKET

### TIP5504

Master Cylinder Mount allows easy mounting of fuel block to the master cylinder. Black anodized aluminum. Each.



# ENGINE

## FUEL SHUT OFF

Part No.	Description
TIP5580	-6 Waterman Style 4.0"W x 1.5"H x 7.0"L
TIP5585	-6 MP Style 4.0"W x 1.0"H x 7.0"L



## CARBON MOUNTS

Part No.	Description
TIP4200	Carbon TelTac Tach Mount
TIP4202	Carbon Fiber MSD Ignition Box Bracket
TIP4204	Carbon Fiber MSD Ignition Box Bracket, Bent Dash

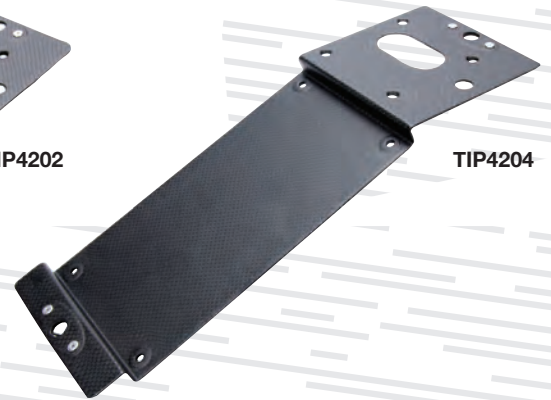
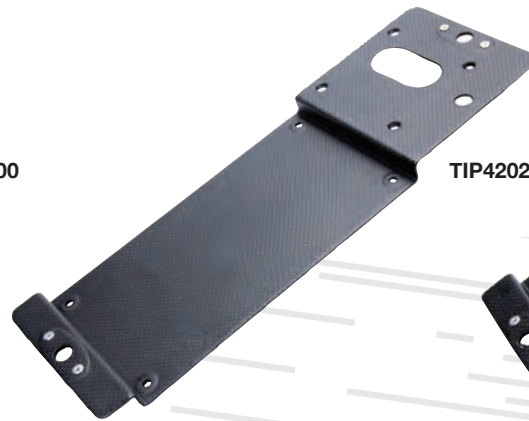
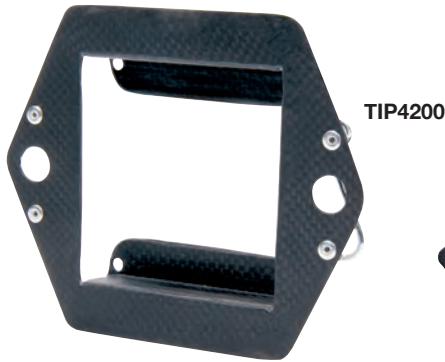

## LOWER SPRINT RADIATOR HOSE

Molded silicone hose is built specifically for sprint car lower radiator hose applications. Molded 90° elbow and 45° elbow separated by 5" fits most combinations of Sprint Car radiator and pump.

Part No.	Description
TIP5160	Lower Sprint Radiator Hose, Black, 1-1/2"
TIP5163	Lower Sprint Radiator Hose Black 1-3/4"
TIP5165	Lower Sprint Radiator Hose, 3-pcs, Black, 1-1/2"
TIP5168	Lower Sprint Radiator Hose, 1-1/2" I.D. to 1-3/4" I.D. 22" long
TIP5170	1.5" Billet Hose Clamp
TIP5172	1.75" Billet Hose Clamp
TIP5570	Dash Bulkhead Plate -6



## HONEYCOMB RADIATOR SCREEN

### TIP5184

Protect radiators from small rocks and debris. 20" x 20" x 1/2". Durable tan-colored plastic. Each.

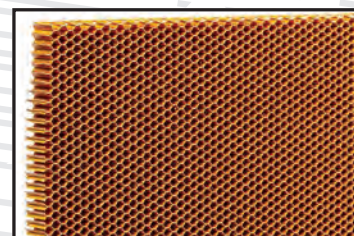

# TOOLS

## LOCKING TEAR-OFF POST KIT

### TIP4900

Quick adjusting, true locking tear-off post eliminates the problem of loose tear-offs on any helmet. Makes installing tear-offs very quick. Includes installation tool. Two posts per kit.



## SET-UP BLOCKS

Aluminum blocks feature a contoured bottom with integrated magnets to hold tight to steel tubing or any flat steel surface. Quick-release pin keeps the block at the desired height. Short blocks adjust from 1-3/4"-4" and tall blocks adjust from 3"-6". Sold in pairs. Available accessories include set-up rollers with easy rolling wheels, or set-up cups to securely cradle axle tubes.

Part No.	Description
TIP2980	Short Set-Up Blocks, 1.75"-4", Pair
TIP2981	Tall Set-Up Blocks, 3"-6", Pair
TIP2985	Set-Up Block Hardware Kit, Includes (2) Quick Release Pins & (8) Screws
TIP2986	Accessory Set-Up Rollers, Pair
TIP2987	Accessory Set-Up Cups, Pair



TIP2981

TIP2986



## BEAD BREAKERS

Part No.	Description
TIP8502	For 10" Wheel, Narrow Jaw, Steel, Black Powder Coat
TIP8503	For 13" Wheel, Narrow Jaw, Steel, Black Powder Coat
TIP8504	For 15" Wheel, Narrow Jaw, Steel, Black Powder Coat
TIP8505	For 15" Wheel, Wide Jaw, Steel, Black Powder Coat



TIP8504

## QUICK-CHANGE DRAIN PAN

### TIP8520

Black anodized aluminum drain pan is 10-1/4" wide x 12" long x 3-3/4" deep. Features a built-in perforated shelf to hold gears and allow lube to drain into pan.



# TOOLS

## **-3 TO -16 ALUMINUM AN WRENCH SET**

### **TIP8530**

Seven-piece AN wrench set is the best value on the market. -3 through -16. Black anodized aluminum wrenches won't mar fittings and are labeled for easy identification.



## **QUICK WRENCH**

### **TIP8535**

Designed to work on all -6AN fittings. Works great on all fuel bypass fittings for quick adjustments.



## **SONIC CLEANING SOLUTION**

### **TIP5610**

Use with Ultrasonic Cleaners. It effectively breaks down dirt, oils, and works great for cleaning methanol residue from fuel system components. One-gallon container.



## **ULTRASONIC CLEANER WITH 9" STAINLESS BASKET**

### **TIP8580**

This professional-grade ultrasonic cleaner is designed to remove methanol residue from your entire fuel system. Just place bolts, quick fasteners, fittings, rod ends, or any other small part in this heavy-duty cleaner and within minutes everything will look brand new. The tank measures 9.5"L x 5.5"W x 4.5"D and holds one gallon of cleaning solution (TIP5610). The heating element gets the solution up to 180°F for a quick deep clean. Complete with a stainless lid and mesh basket. Good maintenance is the key to victory—don't let crud and mud slow you down!



## **ULTRASONIC CLEANER PARTS WASHER KIT WITH 19" STAINLESS BASKET**

### **TIP8582**

Easily remove grease, varnish, and dirt from smaller parts. Features a 19-1/2"L x 11-1/2"W x 7-3/4"D internal cleaning tank with a 2-gallon capacity, heater, and digital timer. Includes stainless steel basket and lid.



# TOOLS

## ROLLING CHASSIS STANDS

Frame stand and dolly set is built with black powder-coated steel, making it tough enough for shop duty, but nice enough for showroom use! Adjusts easily from 13" to 19" in height to put a sprint chassis at the ideal working height, while heavy-duty locking casters make it easy to move around the shop, even under heavy loads. High-density rubber pads help prevent scratches on lower frame rails. Includes all pins, casters, and hardware needed for assembly. Sold in sets of two.



Part No.	Description
TIP5410	Frame Stand and Dolly, Steel, Pair
<b>Replacements Parts</b>	
TIP5415	Frame Stand Replacement Rubber Mount
TIP5416	Frame Stand Replacement Rubber Mount w/ Spacer
TIP5417	Frame Stand Pin Hardware 4 Short 2 Long
TIP5418	Frame Stand Replacement Caster No Lock
TIP5420	Frame Stand Replacement Caster with Lock

## PIT STANDS FOR SPRINT CAR

### TIP5414

These pit stands work great at both the shop or at the track. Black powder-coated steel. Sold in pairs.



TIP5414

## TIRE TOOLS

Part No.	Description
<b>Digital Remote Tire Inflators</b>	
TIP5480	Tire Pressure Gauge, 0-100 PSI, Digital, 2-1/4" Diameter, Black Face, Schrader Valve / Tire Chuck, Kit
TIP5481	Tire Pressure Gauge, 0-100 PSI, Digital, 2-1/4" Diameter, Black Face, Ball Chuck / Tire Chuck, Kit
<b>Replacements Parts</b>	
TIP5482	Tire Pressure Gauge, 0-100 PSI, Digital, 2-1/4" Diameter, Black Face, Each
TIP5485	Tire Pressure Gauge, 0-100 PSI, Digital, 2-1/4" Diameter, Black Face, Each
TIP5486	Fill Hose, Schrader Valve Female to Tire Chuck, TI22 Tire Pressure Gauge, Each
TIP5487	Fill Hose, Schrader Valve Female to Schrader Valve Male, TI22 Tire Pressure Gauge, Each
TIP5488	Fill Hose, Schrader Valve Female to Ball Chuck, TI22 Tire Pressure Gauge, Each



TIP5480

## 6-PIECE RUBBER TIE-DOWN STRAP KIT

### TIP8512

(2) 15", (2) 21", (2) 31"

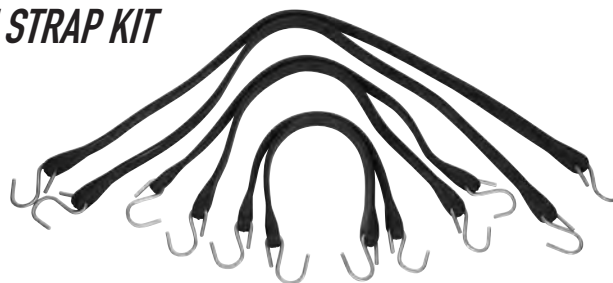



# BODY COMPONENTS

## FIBERGLASS BODY COMPONENTS

Our body components are made with the highest quality fiberglass, then finished with a very strong gel-coat in either white or black.

### OUTLAW STYLE HOODS

Part No.	Color
<b>Hoods</b>	
TIP8200	Black
TIP8202	White
<b>Nose</b>	
TIP8201	Black
TIP8203	White
<b>Dash</b>	
TIP8204	Black
TIP8205	White



TIP8200

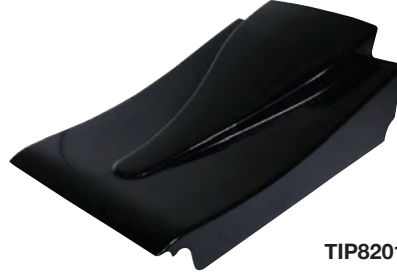

TIP8201



TIP8204

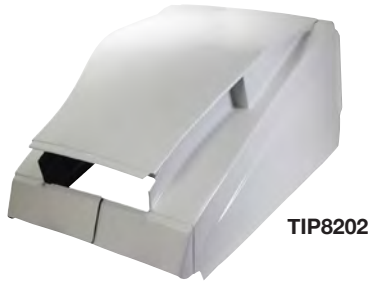

TIP8202

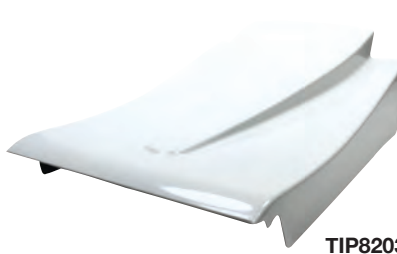

TIP8203



TIP8205

### MAX AIR STYLE HOODS

Part No.	Color
<b>Hoods</b>	
TIP8230	Black
TIP8232	White
<b>Nose</b>	
TIP8240	Black
TIP8242	White
<b>Dash</b>	
TIP8241	Black
TIP8243	White



TIP8230



TIP8240



TIP8241

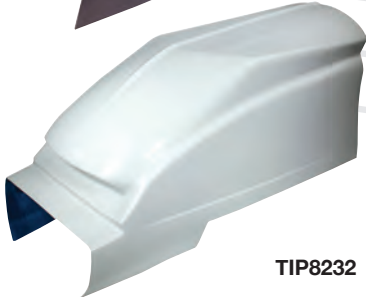

TIP8232

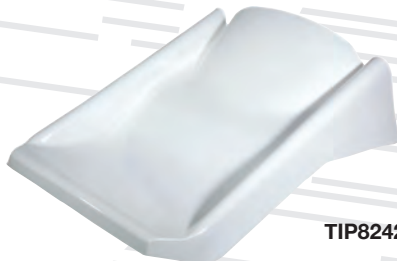

TIP8242



TIP8243

### PLASTIC SHOCK COVERS

Our shock covers have fit every shock we've tried them on and will add life to your shocks by keeping the shock body safe from rocks and debris. Easy snap-on installation. Available for small or large-body shocks. Sold each.

Part No.	Description
TIP8308	Shock Cover Plastic - Small Body
TIP8312	Shock Cover Plastic - Big Body



TIP8308



TIP8312

# BODY COMPONENTS

## ARM GUARDS

Part No.	Color
<b>Right Side</b>	
TIP8300	Black
TIP8304	White
<b>Left Side With Safety Cage</b>	
TIP8310	Black
TIP8314	White

TIP8300

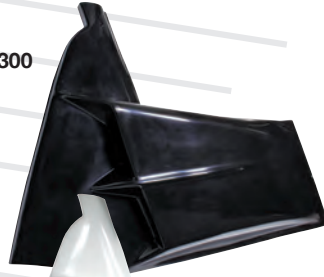

TIP8310



TIP8304



TIP8314



## RADIUS ROD COVERS

Part No.	Color
<b>Right Side</b>	
TIP8330	Black
TIP8332	White
<b>Left Side</b>	
TIP8334	Black
TIP8336	White

TIP8336



TIP8332

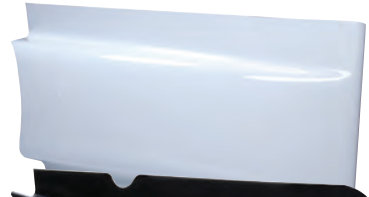

TIP8334



TIP8330



## QUICK-TURN BUTTONS

Part No.	Description	Quantity
TIP8100	Oval-Head Quick-Turn Buttons, .500" Long	10 Pk.
TIP8100-50	Oval-Head Quick-Turn Buttons, .500" Long	50 Pk.
TIP8102	Oval-Head Quick-Turn Buttons, Black, .500" Long	10 Pk.
TIP8102-50	Oval-Head Quick-Turn Buttons, Black, .500" Long	50 Pk.
TIP8104	Oval-Head Quick-Turn Buttons, .550" Long	10 Pk.
TIP8104-50	Oval-Head Quick-Turn Buttons, .550" Long	50 Pk.
TIP8106	Oval-Head Quick-Turn Buttons, Black, .550" Long	10 Pk.
TIP8106-50	Oval-Head Quick-Turn Buttons, Black, .550" Long	50 Pk.
TIP8108	Large Head Quick-Turn Buttons .500" Long	10 Pk.
TIP8108-50	Large Head Quick-Turn Buttons .500" Long	50 Pk.
TIP8110	Large Head Quick-Turn Buttons, Black, .500" Long	10 Pk.
TIP8110-50	Large Head Quick-Turn Buttons, Black, .500" Long	50 Pk.
TIP8120	Steel Quick-Turn Springs	10 Pk.
TIP8120-50	Steel Quick-Turn Springs	50 Pk.
TIP8150	Quick Turn Mounting Bracket, 1-1/4" Tubing	1
TIP8151	Quick Turn Mounting Bracket, 1-3/8" Tubing	1
TIP8152	Quick Turn Mounting Bracket, 1-1/2" Tubing	1
TIP8153	Quick Turn Mounting Bracket, 1-5/8" Tubing	1

TIP8100



TIP8102



TIP8150



## BODY-SAVER PLATES

Help protect body panels when using quick-turn fasteners. Body reinforcing plates are 2" L x 1" W, and attach using 1/8" rivets.

Part No.	Description	Material
TIP8140	Body-Saver Plates, 10 Pk	Stainless Steel
TIP8140-50	Body-Saver Plates, 50 Pk	Stainless Steel
TIP8142	Body Saver Plates 10 Pk	Steel, Black
TIP8142-50	Body Saver Plates 50 Pk	Steel, Black



TIP8140



TIP8142

# MINI SPRINT

## 600 MINI SPRINT FRONT END COMPONENTS

### FRONT STEERING ARMS

Precision machined from 2024 aluminum, arms are engineered for use with XB spindles. Arms may be used on the right or left spindle, and are offered with plain or black finish. Fits TIP3522 and TIP3523 spindles.

Part No.	Description
TIP3540	Aluminum
TIP3541	Black



### STEERING ARMS

Precision machined from 2024 aluminum arms are engineered for standard height mini sprint spindles. Arms can be used a steering arm only or combo arm and are offered in plain aluminum or black anodized. Fits TIP3520 and TIP3521 spindles.

Part No.	Description
TIP3542	Aluminum
TIP3543	Black



### SPINDLES

CNC-machined from rigid 6061-T6 billet aluminum, spindles include a machined aluminum snout. Plain finish.

Part No.	Description
TIP3520	Left Front
TIP3521	Right Front

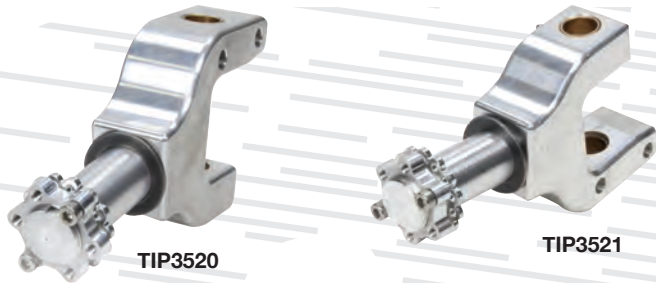

### XB SPINDLES

Made from billet 2024 aluminum, XB spindles feature an extra-tall boss design and a machined aluminum snout. Choose from plain or black finished.

Part No.	Description
TIP3522	2024 Billet 2024 Aluminum, Tall Boss
TIP3523	2024 Billet 2024 Aluminum, Black, Tall Boss

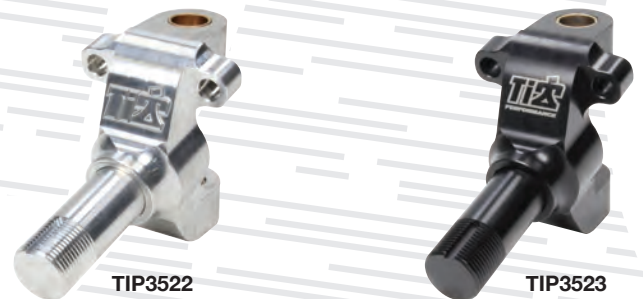

### STEEL KING PINS

Part No.	Description
TIP3532	Short Boss King Pin, 5/8" dia. x 3-5/8" tall
TIP3533	Tall Boss King Pin, 5/8" dia. x 3-7/8" tall



### SPINDLE NUT KIT

Part No.	Description
TIP3530	Fits standard or XB spindles



# MINI SPRINT

## THRUST BEARING KIT

Part No.	Description
TIP3534	Kit includes roller bearing and shims required for one spindle



## FRONT AXLES

Manufactured from durable 1-1/2" x .120" wall 4130 chrome moly steel with 10° front spindles, front axles are offered in torsion bar or coil-over configurations. Choose from chrome or black finished.

Part No.	Description
TIP3500	39-1/2" Long, Coil-Over, Chrome
TIP3501	39-1/2" Long, Coil-Over, Black
TIP3502	39-1/2" Long, Torsion Bar, Tall Boss, Chrome
TIP3503	39-1/2" Long, Torsion Bar, Tall Boss, Black
TIP3504	40" Long, Coil-Over, Chrome
TIP3505	40" Long, Coil-Over, Black
TIP3506	42" Long, Coil-Over, Non-Winged, Chrome
TIP3507	42" Long, Coil-Over, Non-Winged, Black



## MINI SPRINT TORSION COMPONENTS

### TORSION STOPS

Torsion stop is CNC-machined from billet aluminum and incorporates a high-grade, full-thread stainless steel bolt with nut to provide exact adjustments. The bolt end is additionally relieved to prevent mushrooming. Choose from natural or black finish.

Part No.	Description
TIP3600	7/8" Torsion Stop, 1-1/2" Tube Split, Natural
TIP3601	7/8" Torsion Stop, 1-1/2" Tube Split, Black



### TORSION BAR BUSHING

Durable Nylatron-composite bushing offers less friction and a longer life. Designed for use with 7/8" dia. bars, .083" wall bushing features a tapered end for ease of installation.

Part No.	Description
TIP3608	Torsion Bar Bushing



TIP3608

# MINI SPRINT

## MINI SPRINT TORSION COMPONENTS (CONT.)

### TORSION ARMS

Manufactured from durable billet 2024 aluminum, Torsion Arms are offered for a wide variety of applications. Offered with polished or black anodized finish.

Part No.	Description
TIP3610	Left Front, 13-1/2" Long, 7/8" Spline, 3/4" Thick, Polished
TIP3611	Right Front, 12" Long, 7/8" Spline, 3/4" Thick, Polished
TIP3614	Left Front, 13-1/2" Long, 7/8" Spline, 3/4" Thick, Black
TIP3615	Right Front, 12" Long, 7/8" Spline, 3/4" Thick, Black
TIP3620	Left Rear, Straight, 11-1/2" Long, 7/16" Thread, Polished
TIP3621	Left Rear, Straight, 11-1/2" Long, 7/16" Thread, Black
TIP3624	Right Rear, 4-1/8" Offset, 9-3/4" Long, 7/16" Thread, Polished
TIP3625	Right Rear, 4-1/8" Offset, 9-3/4" Long, 7/16" Thread, Black
TIP3626	Fusion Chassis, Right Rear, 1-1/2" Offset, 9-1/2" Long, 7/16" Thread, Polished
TIP3627	Fusion Chassis, Right Rear, 1-1/2" Offset, 9-1/2" Long, 7/16" Thread, Black



TIP3620



TIP3621



TIP3624



TIP3625



TIP3626



TIP3627



TIP3610



TIP3611



TIP3614

### PANHARD ARMS

Specific to panhard rear axle assemblies, rigid 2024 aluminum arm provides a structurally stout piece. Arm has no offset and includes an integrated spacer on the end to allow a full range of motion. Will not work with Watts link style rear end. Choose from polished or black anodized.

Part No.	Description
TIP3630	Left Rear, 11-1/8" Center of Torsion Hole to End, Polished
TIP3631	Right Rear, 9-1/2" Center of Torsion Hole to End, Polished
TIP3632	Left Rear, 9-1/2" Center of Torsion Hole to End, Black
TIP3633	Right Rear, 9-1/2" Center of Torsion Hole to End, 2024 Black



TIP3631



TIP3633

### STEEL TORSION ARM SHOCK STUD W/NUTS

#### TIP3640

Steel stud is 2" long with 3/8"-24 threads. Sold complete with (2) nylon insert nuts.



# MINI SPRINT

## 600 MINI SPRINT RADIUS RODS AND ACCESSORIES

### 600 MINI SPRINT BATTERY BOX

#### TIP3800

Lightweight aluminum battery box installs easily into the floor pan with included quick fasteners. Easy-to-assemble box accepts most popular batteries. 4" width x 4" height x 6-1/2" length.



### RADIUS RODS

Rigid aluminum radius rods include 7/16" threads. Choose from polished or black anodized finish.

Part No.	Description
TIP3702-20	Left Rear, 20" Long, Black, Each
TIP3702-21	Right Rear, 21" Long, Black, Each
TIP3706-20	Left Rear, 20" Long, Polished, Each
TIP3706-21	Right Rear, 21" Long, Polished, Each



TIP3702-20



TIP3706-20

### FRONT/PANHARD ADJUSTER ROD

Part No.	Description
TIP3704-155	Front Radius Rod, 15-1/2" Long, 3/8" Threads, Polished, Each
TIP3704-145	Front Radius Rod, 14-1/2" Long, 3/8" Threads, Polished, Each



### PANHARD HEIGHT/SHIFTER LINKAGE ROD

Part of our new panhard rear end package that connects the bell crank to the panhard slider sleeve via 3/8" aluminum rod ends.

Part No.	Description
TIP3704-45	Panhard Height/Shifter Linkage Rod, 4-1/2" Long



### BRAKE ROD

Manufactured from 4130 chrome moly steel, right rear brake rod is designed to help stabilize the rear axle assembly. Significantly more durable than aluminum units, brake rod is 20" long with welded/threaded 7/16" inserts.

Part No.	Description
TIP3710-20	Brake Rod, 20" Long



# MINI SPRINT

## 600 MINI SPRINT ROD ENDS

Choose from a variety of popular rod ends. Rod ends feature nylon inserts for added durability.

Part No.	Description
TIP3750	3/8"-24, RH Thread, Nickel-Plated, Each
TIP3751	3/8"-24, LH Thread, Nickel-Plated, Each
TIP3752	7/16"-20, LH Thread, 3-Pc., Black Anodized, Each
TIP3753	7/16"-20, RH Thread, 3-Pc., Black Anodized, Each
TIP3756	7/16"-20, LH Thread, Nickel-Plated, Each
TIP3757	7/16"-20, RH Thread, Nickel-Plated, Each



TIP3750

TIP3753

## 600 MINI SPRINT JACOB'S LADDER

Jacob's Ladder is 10-1/4" long. Sold complete with straps. Choose from chrome or black finish.

Part No.	Description
TIP3960	Jacob's Ladder, Chrome
TIP3962	Jacob's Ladder, Black



TIP3960

TIP3962

## 600 MINI SPRINT REAR SPROCKETS

Sprockets are manufactured from hardened aluminum to be lightweight, yet durable. Sprockets feature 5.25" bolt circle with 5/16" pre-drilled holes. Fits Triple X and other mini sprint sprocket hubs.

Part No.	5.25" Bolt Circle	Part No.	6.43" Bolt Circle
TIP3840-35	35T	TIP3841-40	40T
TIP3840-36	36T	TIP3841-41	41T
TIP3840-37	37T	TIP3841-42	42T
TIP3840-38	38T	TIP3841-43	43T
TIP3840-39	39T	TIP3841-44	44T
TIP3840-40	40T	TIP3841-45	45T
TIP3840-41	41T	TIP3841-46	46T
TIP3840-42	42T	TIP3841-47	47T
TIP3840-43	43T	TIP3841-48	48T
TIP3840-44	44T	TIP3841-49	49T
TIP3840-45	45T	TIP3841-50	50T
TIP3840-46	46T	TIP3841-51	51T
TIP3840-47	47T	TIP3841-52	52T
TIP3840-48	48T	TIP3841-53	53T
TIP3840-49	49T	TIP3841-54	54T
TIP3840-50	50T	TIP3841-55	55T
TIP3840-51	51T	TIP3841-56	56T
TIP3840-52	52T	TIP3841-57	57T
TIP3840-53	53T	TIP3841-58	58T
TIP3840-54	54T	TIP3841-61	61T
TIP3840-55	55T	TIP3841-62	62T
TIP3840-56	56T	TIP3841-63	63T
TIP3840-57	57T		
TIP3840-58	58T		
TIP3840-61	61T		
TIP3840-62	62T		
TIP3840-63	63T		

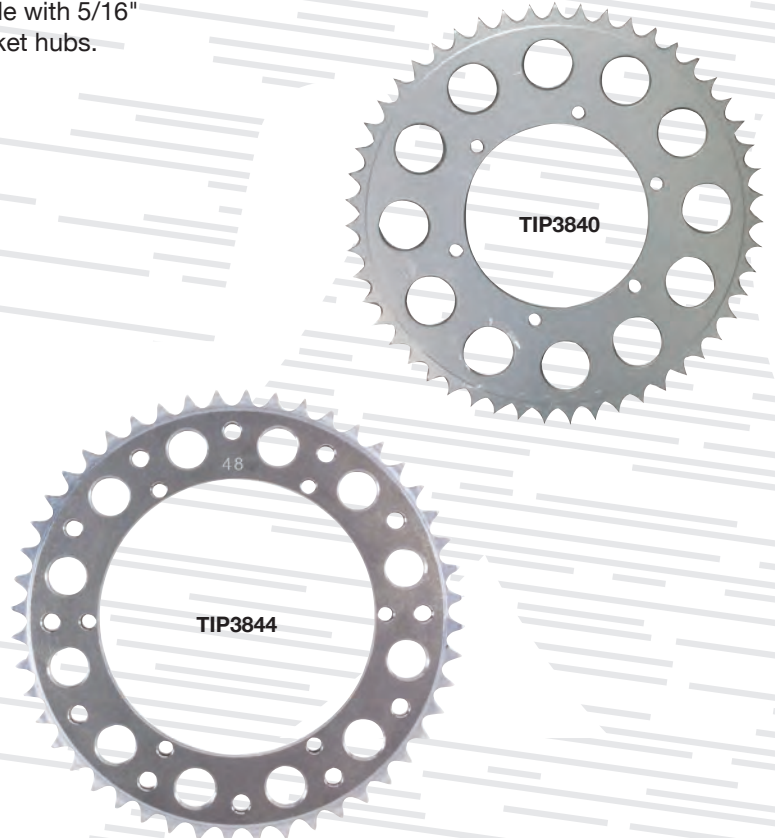

TIP3840

TIP3844

# MINI SPRINT

## 600 MINI SPRINT WING TREE AND MOUNTS

### TOP WING POSTS

Manufactured from 4130 chrome moly steel for maximum durability. Sold individually. Choose from chrome plated or black finished.

Part No.	Description
TIP3760	8" Long, 3/4" Dia. x .065" Wall, Chrome, Each
TIP3761	8" Long, 3/4" Dia. x .065" Wall, Black, Each
TIP3765	8" Long with Sealed Roller Bearings, 3/4" Dia. x .065" Wall, Chrome, Each
TIP3766	8" Long with Sealed Roller Bearings, 3/4" Dia. x .065" Wall, Black, Each



### 600 MINI SPRINT NOSE WING POSTS

Part No.	Description
TIP3789	Pinch Clamp, Black, 4.00"W x 1.50"H x 7.00"L
TIP3794	10" Tall Nose Wing Post, Straight, Black, 4.00"W x 0.80"H x 12.75"L
TIP3795	10" Long Nose Wing Post, Straight, Black, 4.05"W x 1.70"H x 15.80"L
TIP3796	10" Tall Nose Wing Post, Straight, Aluminum, 4.00"W x 1.00"H x 13.00"L



### TOP WING TREES

Featuring up to 6" of adjustment through use of 1" adjustment holes, Top Wing Trees are 25" wide x 11" high with a 5/8" upright diameter and .050" upright wall thickness. Constructed from 4130 chrome moly steel, top wing trees are complete with 3/8" wing slider mount. Offered in chrome plated or black.

Part No.	Description
TIP3770	Top Wing Tree, Chrome, Each
TIP3771	Top Wing Tree, Black, Each

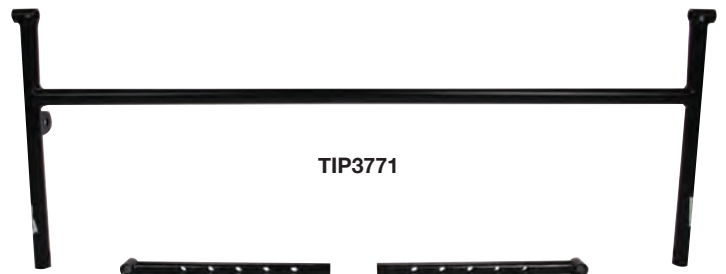

### TOP WING MANUAL SLIDERS

Top wing manual slider has 1" adjustment holes and offers up to 7" of adjustment for 14"-21" length. Constructed from 3/4" dia. x .050" wall 4130 chrome moly, unit is complete less adjuster pins. Offered in chrome or black.

Part No.	Description
TIP3775	Top Wing Manual Slider, Chrome, Each
TIP3776	Top Wing Manual Slider, Black, Each





# MINI SPRINT

## 600 MINI SPRINT CLUTCH, CHAIN, AND RELATED COMPONENTS

Part No.	Description
TIP3810	Clutch Lever, Cable Holder/Adjuster, Clamps to Shifter, 7/8" O.D. Tube, Black
TIP3812	Shift Lever, Fits Left Side of Chassis, 4130 Chrome Moly, Black
TIP3813	Shift Lever to Motor Linkage, Aluminum, 4" Long, Includes (2) Rod Ends and (1) Jam Nut
TIP3815	Throttle Cable, Yamaha R6, 56" Case Length, 66" Cable Length, Aluminum Pinched End
TIP3817	Sprocket/Chain Guide Kit, Aluminum Bracket, Nylon Block, Includes Mounting Bolt
TIP3860	Sprocket/Chain Guide Aluminum Disc 12.50"W x 3.00"H x 12.50"L
TIP3862	Sprocket/Chain Guide Kit, Aluminum Bracket, Nylon Block, Mounting Bolts
TIP3864	Chain Tensioner Kit, Double-Roller Style, Includes Bearings, (2) Springs, and (2) Spring Clips
TIP3865	Chain Tensioner Wheel, Roller Bearings, 7/8" Wide
TIP3870	Chain, 130 Link, 520 Pitch, Steel with Gold-Tone Finish, Includes Master Link
TIP3871	Chain Master Link, Rivet-Type
TIP3872	Chain Master Link, Clip-Type

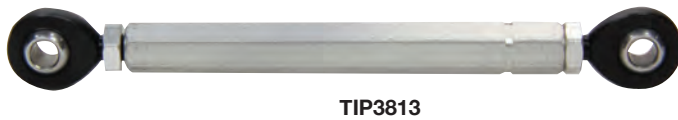
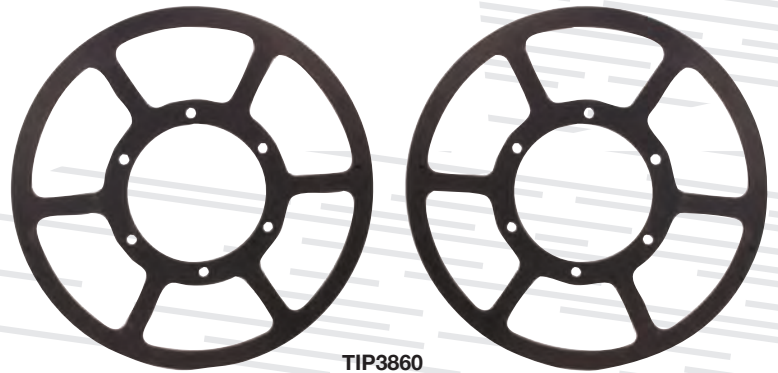
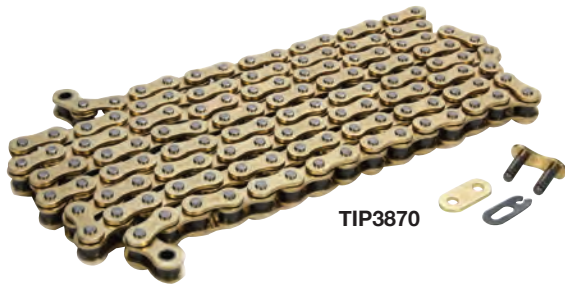

# MINI SPRINT

## 600 MINI SPRINT BIRDCAGES

### STANDARD-STYLE BIRDCAGES

Rigidly constructed, CNC-machined billet aluminum birdcages feature a double-bearing design with a 6" spread between the torsion bar mount and radius rod mount. Sold complete with bearings, snap ring, and bolts. Black anodized finish.

Part No.	Description
TIP3905	Left Side Birdcage, 1-7/8" Axle
TIP3906	Right Side Birdcage, 1-7/8" Axle



TIP3905



TIP3906

### PANHARD-STYLE BIRDCAGES

Specifically designed to help maintain the forward bite needed to win, panhard-style birdcages are manufactured from billet aluminum and feature a dual bearing design. Includes dual mounting holes for torsion arm shackle, while the left rear unit is drilled for a panhard clevis. Sold complete with bearings, snap ring, and bolts. Choose from polished or black anodized finished. Double-row splined bearing inserts sold separately.

Part No.	Description
TIP3909	Left Side Birdcage, 1-7/8" Axle, Polished
TIP3910	Right Side Birdcage, 1-7/8" Axle, Polished
TIP3911	Left Side Birdcage, 1-7/8" Axle, Black
TIP3912	Right Side Birdcage, 1-7/8" Axle, Black



TIP3909



TIP3911



TIP3910



TIP3912

## 600 MINI SPRINT PANHARD WISHBONES

Durable, 4130 chrome moly panhard wishbones feature a custom rod length adjuster in the front to allow adjustment without the need for removal. Includes rod ends. Choose from chrome or black finished.

Part No.	Description
TIP3970	Left Side, 17-1/2" Long, 5-1/4" Top-to-Bottom Spread, (2) 7/16" LH Rod Ends Front, (2) 7/16" RH Rod Ends, Chrome
TIP3971	Right Side, 18-1/2" Long, 5-1/4" Top-to-Bottom Spread, (2) 7/16" LH Rod Ends Front, (2) 7/16" RH Rod Ends Rear, Chrome
TIP3972	Left Side, 17-1/2" Long, 5-1/4" Top-to-Bottom Spread, (2) 7/16" LH Rod Ends Front, (2) 7/16" RH Rod Ends Rear, Black
TIP3973	Right Side, 18-1/2" Long, 5-1/4" Top-to-Bottom Spread, (2) 7/16" LH Rod Ends Front, (2) 7/16" RH Rod Ends Rear, Black



TIP3973



TIP3972

# MINI SPRINT

## 600 MINI SPRINT REAR END COMPONENTS

### STANDARD-STYLE BIRDCAGES

Rigidly constructed, CNC-machined billet aluminum birdcages feature a double bearing design with a 6" spread between the torsion bar mount and radius rod mount. Sold complete with bearings, snap ring, and bolts. Black anodized finished.

Part No.	Description
TIP3916	Rear Brake Carrier with 3-1/4" Caliper Mount, 1.968" I.D. Single Bearing, Includes Snap Ring and Bolts. Black Anodized.
TIP3918	Ultra Light Steel Rotor, 9-1/2" O.D. x 1/4" Thick, 6 x 5-1/4" B.C.



### AXLE SPACERS

Engineered for use with 1-7/8" axles, 27-spline spacers are 1-3/4" I.D. and are offered in a variety of widths. Black anodized. Sold each.

Part No.	Description
TIP3930	Axle Spacer, 1/4" Wide
TIP3931	Axle Spacer, 1/2" Wide
TIP3932	Axle Spacer, 3/4" Wide
TIP3933	Axle Spacer, 1" Wide
TIP3935	Axle Spacer, 2" Wide
TIP3936	Axle Spacer, 2-3/8" Wide
TIP3938	Axle Spacer, 3-1/4" Wide
TIP3940	Axle Spacer, 4-5/8" Wide
TIP3942	Axle Spacer, 7-3/4" Wide



### AXLE SPACER KIT TIP3925

Axle spacer kit includes (6) standard and (5) tapered spacers to fit 1-7/8" axles. Black anodized aluminum.

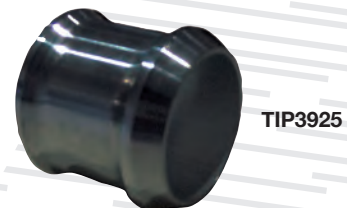

### TAPERED AXLE SPACERS

Part No.	Description
TIP3945	Tapered Axle Spacer, 3/4" Wide
TIP3946	Tapered Axle Spacer, 1" Wide
TIP3947	Tapered Axle Spacer, 2" Wide



### REAR AXLE NUTS

Designed for use with 27-spline axles, rear axle nuts are sold in right side (LH thread) and left side (RH thread) versions. Sold each.

Part No.	Description
TIP3949	Right Side Axle Nut, RH Threads
TIP3950*	Left Side Axle Nut, LH Threads

\*Axle nut has a notch on each corner of the flat sides to identify left-hand threads.



# MINI SPRINT

## 600 MINI SPRINT BUMPERS AND NERF BARS

### NERF STEPS

Manufactured from durable stainless steel and polished to perfection. Universal design allows mounting to a variety of chassis.

Part No.	Description
TIP3980	Front Bumper
TIP3982	Stacked Front Bumper
TIP3984	Left Nerf Bar, Includes Quick Fastener Tab for Chain Guard
TIP3986	Right Nerf Bar

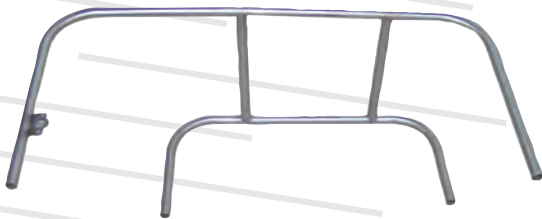

TIP3984



TIP3980



TIP3986



TIP3982

### REAR BUMPERS

Part No.	Description
TIP3988	Rear Bumper without Basket
TIP3990	Rear Bumper with Basket



TIP3990

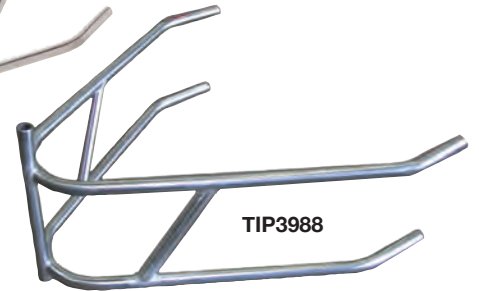

TIP3988

### PIT STANDS FOR SPRINT CAR

#### TIP5414

These pit stands work great at both the shop or at the track. Black powder-coated steel. Sold in pairs.



TIP5414

### WHEEL BEAD BREAKER

#### TIP8502

For 10" Wheel, Narrow Jaw. Black powder-coated steel.



# Ti22 APPAREL & ACCS.

## Ti22 LOGO T-SHIRT

Part No.	SIZE
TIP9140S	Small
TIP9140M	Medium
TIP9140L	Large
TIP9140XL	X-Large
TIP9140XXL	2X-Large
TIP9140XXXL	3X-Large



## TI GUY SOFTSTYLE SHIRTS

Part No.	SIZE
TIP9142S	Small
TIP9142M	Medium
TIP9142L	Large
TIP9142XL	X-Large
TIP9142XXL	2X-Large
TIP9142XXXL	3X-Large



## Ti22 SPORT-TEK HOODIE

Part No.	SIZE
TIP9210S	Small
TIP9210M	Medium
TIP9210L	Large
TIP9210XL	X-Large
TIP9210XXL	2X-Large
TIP9210XXXL	3X-Large



## TI GUY TRUCKER HAT

Part No.	SIZE
TIP9075	Large/X-Large



## TI GUY KNIT BEANIE

Part No.	SIZE
TIP9070	OSFA



## TI FOLDING CHAIR

TIP9240



## TI GUY FITTED HAT

Part No.	SIZE
TIP9076SM	Small/Medium
TIP9076XL	Large/Extra Large



## TI GUY HAT

Part No.	SIZE
TIP9074	Large/X-Large



## 12" X 14" DECAL

TIP0060



## 6" X 8" BLACK DECAL

TIP0051



## 4" X 6" WHITE DECAL

TIP0050



Learn more about racing gear and equipment we have.