

NO 8034



2021 SIERRA MARINE PARTS

CATALOG

ENGINE & DRIVE PARTS • POWER SYSTEMS • INSTRUMENTATION
SWITCHES • ENGINE DIAGNOSTICS • SHIELDS HOSE
OILS & LUBRICANTS • TOOLS & ACCESSORIES

sierra
Marine Engine and Drive Parts

SONAR^{PRO}

SIERRA ONLINE APPLICATION RESOURCE



Finding the right Sierra part has never been easier.

- Up-To-Date Product Info
- Search by Sierra or OEM part number or Engine Model No.
- Includes Images & Exploded Views

sierra
Marine Engine and Drive Parts

THE BEST
**MARINE
GRADE OIL
ON THE MARKET**



Part Number	Description	OEM	OEM Part Number
116-126-2000G	Hose, Sterntflex 2 X 50, Gray	Shields	116-126-2000G
116-126-2000W	Hose, Sterntflex 2 X 50, White	Shields	116-126-2000W
116-126-2003G	Hose, Sterntflex 2 X 10 Gray	Shields	116-126-2003G
116-126-2003W	Hose, Sterntflex 2 X 10, White	Shields	116-126-2003W
116-157-0120	Hose, Natural LLDPE Tubing 1/2" X 100'	Shields	116-157-0120
116-157-0380	Hose, Natural LLDPE Tubing 3/8" X 100'	Shields	116-157-0380
116-254-0340	Hose, 3/4" x 50' Exoflex	N/A	116-254-0340
116-254-0344	HOSE, 3/4 X 12 1/2 EXOFLEX	N/A	116-254-0344
116-254-1000	HOSE, 1" X 50' EXOFLEX	N/A	116-254-1000
116-254-1001	HOSE, 1 X 6 1/4 EXOFLEX	N/A	116-254-1001
116-254-1004	HOSE, 1 X 12 1/2 EXOFLEX	N/A	116-254-1004
116-254-1120	HOSE, 1 1/2 X 50 EXOFLEX	N/A	116-254-1120
116-254-1124	HOSE, 1 1/2 X 12 1/2 EXOFLEX	N/A	116-254-1124
116-254-1140	HOSE, 1 1/4 X 50 EXOFLEX	N/A	116-254-1140
116-254-1144	HOSE, 1 1/4 X 12 1/2 EXOFLEX	N/A	116-254-1144
116-254-1340	HOSE, 1 3/4 X 50 EXOFLEX	N/A	116-254-1340
116-254-1344	HOSE, 1 3/4 X 12 1/2 EXOFLEX	N/A	116-254-1344
116-254-1580	HOSE, 1 5/8 X 50 EXOFLEX	N/A	116-254-1580
116-254-1584	HOSE, 1 5/8 X 12 1/2 EXOFLEX	N/A	116-254-1584
116-254-2000	HOSE, 2 X 50 EXOFLEX	N/A	116-254-2000
116-254-2001	HOSE, 2 X 6 1/4 EXOFLEX	N/A	116-254-2001
116-254-2004	HOSE, 2 X 12 1/2 EXOFLEX	N/A	116-254-2004
116-254-2120	HOSE, 2 1/2 X 50 EXOFLEX	N/A	116-254-2120
116-254-2121	HOSE, 2 1/2 X 6 1/4 EXOFLEX	N/A	116-254-2121
116-254-2124	HOSE, 2 1/2 X 12 1/2 EXOFLEX	N/A	116-254-2124
116-254-2140	HOSE, 2 1/4 X 50 EXOFLEX	N/A	116-254-2140
116-254-2141	HOSE, 2 1/4 X 6 1/4 EXOFLEX	N/A	116-254-2141
116-254-2144	HOSE, 2 1/4 X 12 1/2 EXOFLEX	N/A	116-254-2144
116-254-2380	HOSE, 2 3/8 X 50 EXOFLEX	N/A	116-254-2380
116-254-2384	HOSE, 2 3/8 X 12 1/2 EXOFLEX	N/A	116-254-2384
116-254-3000	HOSE, 3 X 50 EXOFLEX	N/A	116-254-3000
116-254-3001	HOSE, 3 X 6 1/4 EXOFLEX	N/A	116-254-3001
116-254-3004	HOSE, 3 X 12 1/2 EXOFLEX	N/A	116-254-3004
116-254-3120	HOSE, 3 1/2 X 50 EXOFLEX	N/A	116-254-3120
116-254-3121	HOSE, 3 1/2 X 6 1/4 EXOFLEX	N/A	116-254-3121
116-254-3124	HOSE, 3 1/2 X 12 1/2 EXOFLEX	N/A	116-254-3124
116-254-4000	HOSE, 4 X 50 EXOFLEX	N/A	116-254-4000
116-254-4001	HOSE, 4 X 6 1/4 EXOFLEX	N/A	116-254-4001
116-254-4004	HOSE, 4 X 12 1/2 EXOFLEX	N/A	116-254-4004
116-254-4120	HOSE, 4 1/2 X 50 EXOFLEX	N/A	116-254-4120
116-254-4121	HOSE, 4 1/2 X 6 1/4 EXOFLEX	N/A	116-254-4121
116-254-4124	HOSE, 4 1/2 X 12 1/2 EXOFLEX	N/A	116-254-4124
116-254-5001	HOSE, 5 X 6 1/4 EXOFLEX	N/A	116-254-5001
116-254-5004	HOSE, 5 X 12 1/2 EXOFLEX	N/A	116-254-5004
116-254-6000	HOSE, 6 X 50 EXOFLEX	N/A	116-254-6000
116-254-6004	HOSE, 6 X 12 1/2 EXOFLEX	N/A	116-254-6004
116-254-8000	HOSE, 8 X 50 EXOFLEX	N/A	116-254-8000
116-254-8001	Hose, 8" x 6' 1/4" EXOFLEX	N/A	116-254-8001
116-254-8004	HOSE, 8 X 12 1/2 EXOFLEX	N/A	116-254-8004

Part Number	Description	OEM	OEM Part Number
116-375-0380-36	3/8" x 36" Fuel Line w/ Straight Quick Connector and Fire Sleeve	Shields	116-375-0380-36
116-375-0380-96	3/8" x 96" Fuel Line w/ Straight Quick Connector and Fire Sleeve	Shields	116-375-0380-96
118-1524	Trim Relay Assembly	Yamaha	6H1-81950-01-00
118-1525	Relay Assembly	Yamaha	60E-81950-00-00
118-2456	Plug, Crankcase Oil Drain	Yamaha	90340-14M06-00
118-3513	Pump, Circulation	Volvo Penta	22844837
118-55505	Starter, Outboard	Mercury	8M0142679
118-55506	Starter, Outboard	Mercury	8M0137769
118-55510	Starter, Inboard	Mercury	8M0095471
118-7516	Filter, Fuel	Yamaha	67F-24251-02-00
118-7517	Filter, Fuel	Yamaha	65L-24563-00-00
118-7521	Filter, Fuel	Honda	16910-ZVL-003
118-7596	Filter, Fuel	Mercury	35-866594K01
118-7962	Filter, Oil	Volvo Penta	3840525
118-8701	Filter, Oil	Volvo Penta	861476
118-8702	Filter, Oil 20 micron	Volvo Penta	30788490
118-9761G	Rigging Hose Flange, Gray	Shields	118-9761G
118-9761W	Rigging Hose Flange, White	Shields	118-9761W
118-9883G	Rigging Hose Kit, Gray	Shields	118-9883G
118-9883W	Rigging Hose Kit, White	Shields	118-9883W
118-99180	Cartridge-Fuel 1000 30Mi	Racor	2020N-30
118-99181	Cartridge-Fuel 1000 10Mi	Racor	2020N-10
118-99182	Cartridge-Fuel 500 10Mi	Racor	2010TM-OR
118-99183	Cartridge-Fuel 500 30 Micron	Racor	2010PM-OR
118-99184	Cartridge-Fuel 900 30Micron	Racor	2040N-30
118-99185	Cartridge-Fuel 900 10Micron	Racor	2040N-10
118-99187	Cartridge-Fuel 1000 2Micron	Racor	2020N-02
118-99188	Cartridge-Fuel 32002 10 Micron	Racor	S3228TUL
118-99190	Cartridge-Fuel 120R RAC-01	Racor	S3240TUL
118-99191	Cartridge-Fuel 900 2Micron	Racor	2040N-02
118-99193	Cartridge-Fuel 120 10Micron	Racor	R12T
118-99194	Cartridge-Fuel 121 2Micron	Racor	R12S
118-99196	Cartridge-Fuel 230 2Micron	Racor	R20S
118-99199	Cartridge-Fuel 120 30Micron	Racor	R12P
118-99200	Cartridge-Fuel R20P 30Micron	Racor	R20P
118-99201	120 Aquaview Clear Bowl- Mini 2 Port	Racor	RK10215
118-99202	230 Series Aquaview Clear Bowl 2 Port	Racor	RK350-02
118-99203	230 Series Metal Bowl	Racor	RK22368
18-5909	Starter, Outboard	Evinrude	587078, 587291
18-73995	Kit, Propeller Nut	Yamaha	66T-W4599-00-00
18-73996	Kit, Propeller Nut	Yamaha	67F-W4599-00-00
18-7514	Pump, Power Steering	Volvo Penta	22797780
20000P	Premier Stainless Series 5" Multi-Function Gauge Kit (Merc/Yam)	VeeThree Instruments	71691P
20010P	Premier Stainless Series 5" Multi-Function Gauge Kit, (Ev/Suz)	VeeThree Instruments	71692P
21000P	White Series 5" Multi-Function Gauge (Merc/Yam)	VeeThree Instruments	71693P
21010P	White Series 5" Multi-Function Gauge Kit (Ev/Suz)	VeeThree Instruments	71694P

Part Number	Description	OEM	OEM Part Number
22000P	DeepVee Series 5" Multi-Function Gauge Kit (Merc/ Yam)	VeeThree Instruments	71695P
22010P	DeepVee Series 5" Multi-Function Gauge Kit (Ev/Suz)	VeeThree Instruments	71696P
22020P	DeepVee Series 5" Multi-Function Gauge Kit (Honda)	VeeThree Instruments	71697P
26000P	Kit, Depth Gauge and Transducer	Norcross	26000P
AP10010	Dual Port USB 2.0 Charger, Curved Door	N/A	AP10010
AP10020	Dual Port USB 2.0 Charger, Square Door	N/A	AP10020
AV10030	Push Button Switch	N/A	AV10030
AV10030B	Push Button Switch, Blue Halo	N/A	AV10030B
AV10030G	Push Button Switch, Green Halo	N/A	AV10030G
AV10030R	Push Button Switch, Red Halo	N/A	AV10030R
AV10030W	Push Button Switch, White Halo	N/A	AV10030W
AV10040	Push Button Switch	N/A	AV10040
AV10040B	Push Button Switch, Blue Halo	N/A	AV10040B
AV10040G	Push Button Switch, Green Halo	N/A	AV10040G
AV10040R	Push Button Switch, Red Halo	N/A	AV10040R
AV10040W	Push Button Switch, White Halo	N/A	AV10040W
AV10050R	Push Button Horn Switch, Red Halo	N/A	AV10050
AV10060B	Push Button Power Switch, Blue Halo	N/A	AV10070
AV10060G	Push Button Power Switch, Green Halo	N/A	AV10080
AV10060R	Push Button Power Switch, Red Halo	N/A	AV10060
AV10060W	Push Button Power Switch, White Halo	N/A	AV10090
AV10100B	Push Button Switch, Blue Halo 20A	N/A	AV10110
AV10100R	Push Button Switch, Red Halo 20A	N/A	AV10100
AV10120B	Push Button Switch, Blue Halo	N/A	AV10120
AV10130B	Push Button Switch, Halo (20A)	N/A	
BS11000	Battery Switch	N/A	
BS11010	Battery Switch w/ AFD	N/A	
BS11020	Battery Switch (1-2-Both-Off)	N/A	
BS11030	Battery Switch (1-2-Both-Off) w/ AFD	N/A	
BS11040	Voltage Sensitive Relay (VSR)	N/A	
BS11050	Voltage Sensitive Relay and Cable Kit	N/A	
Bulk Only	Base Switch, Contura (ON) - OFF - (ON), SPDT	N/A	RK1906
CB41250	CIRCUIT BREAKER, PUSH BUTTON, 25A	Universal	Universal
CB41260	CIRCUIT BREAKER, PUSH BUTTON, 30A	Universal	Universal
CB41270	CIRCUIT BREAKER, PUSH BUTTON, 40A	Universal	Universal
CB50300	Circuit Breaker, Rocker, Flat, Single Pole, 5A	Universal	Universal
CB50310	Circuit Breaker, Rocker, Flat, Single Pole, 10A	Universal	Universal
CB50320	Circuit Breaker, Rocker, Flat, Single Pole, 20A	Universal	Universal
CB50330	CIRCUIT BREAKER, ROCKER, FLAT, SNG POLE, 30A	Universal	Universal
CB50340	CIRCUIT BREAKER, ROCKER, FLAT, SNG POLE, 50A	Universal	Universal
CB50350	CIRCUIT BREAKER, ROCKER, FLAT, SNG POLE, 60A	Universal	Universal
CB50360	CIRCUIT BREAKER, ROCKER, FLAT, SNG POLE, 80A	Universal	Universal
CB50370	CIRCUIT BREAKER, ROCKER, FLAT, SNG POLE, 100A	Universal	Universal
CB50380	CIRCUIT BREAKER, ROCKER, FLAT, DBL POLE, 150A	Universal	Universal
CB50390	CIRCUIT BREAKER, ROCKER, FLAT, DBL POLE, 200A	Universal	Universal
CB50400	CIRCUIT BREAKER, STD BLK TOGGLE, SNG POLE, 5A	Universal	Universal

Part Number	Description	OEM	OEM Part Number
CB50410	CIRCUIT BREAKER, STD BLK TOGGLE, SNG POLE, 10A	Universal	Universal
CB50420	CIRCUIT BREAKER, STD BLK TOGGLE, SNG POLE, 25A	Universal	Universal
CB50430	CIRCUIT BREAKER, STD WHT TOGGLE, SNG POLE, 25A	Universal	Universal
CB50440	CIRCUIT BREAKER, STD BLK TOGGLE, SNG POLE, 40A	Universal	Universal
CB50450	CIRCUIT BREAKER, STD BLK TOGGLE, SNG POLE, 50A	Universal	Universal
CB50460	CIRCUIT BREAKER, STD WHT TOGGLE, DBL POLE, 30A	Universal	Universal
CB50470	CIRCUIT BREAKER, STD WHT TOGGLE, DBL POLE, 50A	Universal	Universal
CB50480	CIRCUIT BREAKER FLAT ROCKER 20A	Universal	Universal
CB50490	CIRCUIT BREAKER FLAT ROCKER 50A	Universal	Universal
CB50500	CIRCUIT BREAKER RCKR FLAT DBL POLE 30A	Universal	Universal
CB50510	CIRCUIT BREAKER RCKR FLAT DBL POLE 100A	Universal	Universal
CB50520	CIRCUIT BREAKER, Flush Mount, 25A	Universal	Universal
CB50530	CIRCUIT BREAKER, Flush Mount, 30A	Universal	Universal
CB50540	CIRCUIT BREAKER, Flush Mount, 40A	Universal	Universal
CB50550	CIRCUIT BREAKER, Flush Mount, 50A	Universal	Universal
CB50560	CIRCUIT BREAKER, Flush Mount, 80A	Universal	Universal
CB50570	CIRCUIT BREAKER, Flush Mount, 100A	Universal	Universal
CB50580	CIRCUIT BREAKER, Flush Mount, 135A	Universal	Universal
CB50590	CIRCUIT BREAKER, Flush Mount, 150A	Universal	Universal
CB50600	CIRCUIT BREAKER, Flush Mount, 200A	Universal	Universal
CB50610	CIRCUIT BREAKER, Panel Mount, 40A	Universal	Universal
CB50620	CIRCUIT BREAKER, Panel Mount, 50A	Universal	Universal
CB50630	CIRCUIT BREAKER, Panel Mount, 60A	Universal	Universal
CB50640	CIRCUIT BREAKER, Panel Mount, 80A	Universal	Universal
CB50650	CIRCUIT BREAKER, Panel Mount, 100A	Universal	Universal
CB50660	CIRCUIT BREAKER, Panel Mount, 150A	Universal	Universal
CB50670	CIRCUIT BREAKER, Panel Mount, 200A	Universal	Universal
EA01000	USB Charger w/ Voltmeter and Graph Display	N/A	
EA01010	12v Aux Power Socket w/ Voltmeter and Graph Display	N/A	
EA01020	Voltmeter Panel, Weather Resistant	N/A	
EA01040	Buzzer, Stainless Steel w/ Flashing LED Warning	N/A	
EA01050	Aux Power Socket, Illuminated	N/A	
EA01070	Voltmeter, Digital	N/A	
EA01080	Voltmeter, Digital, Switch Mount	N/A	
EA01090	Voltmeter, Digital, Graph Display	N/A	
EA01100	Aux Power Socket, Illuminated, Curve Mount	N/A	
FS40800	408 Series Fuse Block, 6 Gang w/ Cover	Blue Sea	5028
FS40810	408 Series Ground Bus Bar, 12 Terminal w/ Cover	N/A	FS40812
FS40820	408 Series Fuse Block, 12 Gang w/ Cover	Blue Sea	5029
FS40830	408 Series Fuse Block, 6 Gang w/ Bus Bar and Cover	Blue Sea	5025
FS40840	408 Series Fuse Block, 12 Gang w/ Bus Bar and Cover	Blue Sea	5026
FS40900	409 Series Fuse Block, AGC Glass Type with Bus Bar	N/A	
FS40910	409 Series Fuse Block, AGC Glass Type Common Source	N/A	
FS40920	409 Series Fuse Block, AGC Glass Type Independent Source	N/A	

Part Number	Description	OEM	OEM Part Number
FS46560	Terminal Stud, Single Heavy Duty M10	N/A	
FS46570	Terminal Stud, Single Heavy Duty M8	N/A	
FS46580	Terminal Stud, Dual Heavy Duty M10 with Isolating Plate	N/A	
FS46590	Terminal Stud, Dual Heavy Duty M8/M10 with Isolating Plate	N/A	
FS46600	Dual Bus Bar, 100A Heavy Duty 12 Gang	N/A	
FS46610	Dual Bus Bar, 100A Heavy Duty 6 Gang	N/A	
FS46620	Dual Bus Bar, 150A Heavy Duty 6 Gang	N/A	
FS46630	Dual Bus Bar, 150A Heavy Duty 12 Gang	N/A	
FS46660	Dual Bus Bar, 2-Step 6P	N/A	
FS46670	Dual Bus Bar, 2-Step 12P	N/A	
FS46680	Bus Bar, 100A Mini - 5 Gang with Cover	N/A	
FS46690	Bus Bar, 100A Mini - 4 Stud with Cover	N/A	
FS46700	Bus Bar, 150A Common - 12 Gang with Cover	N/A	
FS46710	Bus Bar, 250A Maxi Power - 6 Stud	N/A	
FS82000	Fuse Holder, ANL	N/A	
FS82010	ANL Fuse, 100A	N/A	
FS82020	ANL Fuse, 150A	N/A	
FS82030	ANL Fuse, 200A	N/A	
FS82040	ANL Fuse, 250A	N/A	
FS82050	ANL Fuse, 300A	N/A	
FS82060	ANL Fuse, 350A	N/A	
FS82070	ANL Fuse, 400A	N/A	
PC51000	"NMEA 2000 EXTENSION 2FT Cable Micro-C Hi-Power 20AWG2C 18AWG2C MF (Metal)"		
PC51010	"NMEA 2000 EXTENSION 3FT Cable Micro-C Hi-Power 20AWG2C 18AWG2C MF (Metal)"		
PC51020	"NMEA 2000 EXTENSION 6FT Cable Micro-C Hi-Power 20AWG2C 18AWG2C MF (Metal)"		
PC51030	"NMEA 2000 EXTENSION 12FT Cable Micro-C Hi-Power 20AWG2C 18AWG2C MF (Metal)"		
PC51040	"NMEA 2000 EXTENSION 30FT Cable Micro-C Hi-Power 20AWG2C 18AWG2C MF (Metal)"		
PC51050	NMEA 2000 POWER T CABLE 3FT (Metal)		
PC51060	NMEA MICRO 1 T PIECE (Metal)		
PC51070	NMEA 2000 Female Termination Resistor (Metal)		
PC51080	NMEA 2000 Male Termination Resistor (Metal)		
PC51090	NMEA MICRO 90 ELBOW (Metal)		
PC51100	NMEA MICRO 2 T PIECE (Metal)		
PC51110	NMEA MICRO 4 T PIECE (Metal)		
PC51120	M12 Metal Cap for Female Conn		
PC51130	M12 Metal Cap for Male Conn		
PC51140	"NMEA 2000 Drop Cable 2FT Cable Micro-C Ext 24AWG2C 22AWG2C MF (Metal)"		
PC51150	"NMEA 2000 Drop Cable 3FT Cable Micro-C Ext 24AWG2C 22AWG2C MF (Metal)"		
PC51160	"NMEA 2000 Drop Cable 6FT Cable Micro-C Ext 24AWG2C 22AWG2C MF (Metal)"		

Part Number	Description	OEM	OEM Part Number
PCS1170	"NMEA 2000 Drop Cable 16FT Cable Micro-C Ext 24AWG2C 22AWG2C MF (Metal)"		
PC51180			
RK19000	Rocker Switch, Contura XIV SPST, Illuminated	N/A	RK19000
RK19010	Rocker Switch, Contura XIV SPST, Illuminated	N/A	RK19010
RK19020	Rocker Switch, Contura XIV SPST, Illuminated	N/A	RK19020
RK19030	Rocker Switch, Contura XIV SPST, Illuminated	N/A	RK19030
RK19040	Rocker Switch, Contura XIV SPDT, Illuminated	N/A	RK19040
RK19050	Rocker Switch, Contura XIV SPDT, Illuminated	N/A	RK19050
RK19060	Rocker Switch, Contura XIV SPDT, Illuminated	N/A	RK19060
RK19070	Rocker Switch, Contura XIV DPST, Illuminated	N/A	RK19070
RK19080	Rocker Switch, Contura XIV DPST, Illuminated	N/A	RK19080
RK19090	Rocker Switch, Contura XIV DPDT, Illuminated	N/A	RK19090
RK19100	Rocker Switch, Contura XIV DPDT, Illuminated	N/A	RK19100
RK19110	Rocker Switch, Contura XIV DPDT, Illuminated	N/A	RK19110
RK19120	Rocker Switch, Contura XIV SPDT, Illuminated	N/A	RK19120
RK19130	Rocker Switch, Contura XIV SPDT, Illuminated	N/A	RK19130
RK19140	Actuator, Contura XIV Red Square Lens	N/A	RK19140
RK19150	Actuator, Contura XIV Red Square and Red Line Lens	N/A	RK19150
RK19160	Actuator, Contura XIV Two Red Square Lenses	N/A	RK19160
RK19170	Actuator, Contura XIV 2 Red Line Lenses	N/A	RK19170
RK40610B	Rocker Switch, Halo SPST, Blue Halo	N/A	RK40610B
RK40610G	Rocker Switch, Halo SPST, Green Halo	N/A	RK40610G
RK40620B	Rocker Switch, Halo SPST, Blue Halo	N/A	RK40620B
RK40620G	Rocker Switch, Halo SPST, Green Halo	N/A	RK40620G
RK40630B	Rocker Switch, Halo SPST, Blue Halo	N/A	RK40630B
RK40630G	Rocker Switch, Halo SPST, Green Halo	N/A	RK40630G
RK40640B	Rocker Switch, Halo SPDT, Blue Halo	N/A	RK40640B
RK40640G	Rocker Switch, Halo SPDT, Green Halo	N/A	RK40640G
RK40650B	Rocker Switch, Halo DPST, Blue Halo	N/A	RK40650B
RK40650G	Rocker Switch, Halo DPST, Green Halo	N/A	RK40650G
RK40660B	Rocker Switch, Halo DPST, Blue Halo	N/A	RK40660B
RK40660G	Rocker Switch, Halo DPST, Green Halo	N/A	RK40660G
RK40670B	Rocker Switch, Halo DPDT, Blue Halo	N/A	RK40670B
RK40670G	Rocker Switch, Halo DPDT, Green Halo	N/A	RK40670G
RK40680B	Rocker Switch, Halo DPDT, Blue Halo	N/A	RK40680B
RK40680G	Rocker Switch, Halo DPDT, Green Halo	N/A	RK40680G
RK40690B	Rocker Switch, Halo SPDT, Dependent Blue Halo	N/A	RK40690B
RK40690G	Rocker Switch, Halo SPDT, Dependent Green Halo	N/A	RK40690G
RK40700B	Rocker Switch, Halo DPDT, Dependent Blue Halo	N/A	RK40700B
RK40700G	Rocker Switch, Halo DPDT, Dependent Green Halo	N/A	RK40700G
RK40800	Rocker Switch, Compact Rocker SPST	N/A	RK40800
RK40810	Rocker Switch, Compact Rocker SPST	N/A	RK40810
RK40820	Rocker Switch, Compact Rocker SPST	N/A	RK40820
RK40830	Rocker Switch, Compact Rocker SPDT	N/A	RK40830
RK40840	Rocker Switch, Compact Rocker SPDT	N/A	RK40840
RK40850	Rocker Switch, Compact Rocker SPDT	N/A	RK40850
RK40860	Rocker Switch, Compact Rocker SPDT	N/A	RK40860
RK40870	Rocker Switch, Compact Rocker SPDT	N/A	RK40870
RS20000	Rotary Switch, Contura, Red/Green	N/A	RS20000

Part Number	Description	OEM	OEM Part Number
RS20010	Rotary Switch, Contura, Red	N/A	RS20010
RS20020	Rotary Switch, Contura, Red	N/A	RS20020
RS20030	Rotary Switch, Contura, Red	N/A	RS20030
RS20040	Rotary Switch, Contura	N/A	RS20040
RS20050	Rotary Switch, Contura, Starter	N/A	RS20050
RS20060	Rotary Switch, Contura, Progressive	N/A	RS20060
RS20180	Terminal, 17-20AWG Wire	N/A	RS20180
RS20190	Terminal, 13.5-17AWG Wire	N/A	RS20190
RS20200	Housing, Terminal	N/A	RS20200
SP21000	Switch Panel, Weather Resistant 4P Contura Rocker w/ Circuit Breaker	N/A	
SP21010	Switch Panel, Weather Resistant 6P Contura Rocker w/ Circuit Breaker	N/A	
SP21020	Panel, 6 Function Touch 12V/24V	N/A	
SP21030	Panel, 10 Function Touch 12V/24V	N/A	

ONE STOP SHOP FOR ALL YOUR FUEL NEEDS

- Fuel line assemblies utilizing Silverado 4000 hose available for all OE manufacturers
- Fuel filters for the most popular engine applications
- Meets or exceeds major governing body requirements
- High flow capacity fuel water separators rated at 90 gallons per hour



NOW AVAILABLE FROM SIERRA HIGH PERFORMANCE ATV/UTV OILS & LUBRICANTS



10W-40
FULL SYNTHETIC OIL

0W-40
FULL SYNTHETIC OIL

80W-90
SEMI-SYNTHETIC HYPOID OIL

2-STROKE
FULL SYNTHETIC OIL

5W-50
FULL SYNTHETIC OIL

FOAM FILTER OIL

**PRIME
LINE**
Powersports Service Parts



All references to Original Equipment Manufacturers, their trade names, or their part numbers are for replacement part identification only. All Sierra Marine Products are designed to meet or exceed the OEM part they are intended to replace and are backed by the best warranty in the business.

TABLE OF CONTENTS

GAUGE SECTION

Ordering Information.....	2-3	Driftwood	11	Heavy Duty	18
Eyebrow Bezels.....	21	Lido Pro/Lido	9-10	Premier Stainless Multifunction	19
GPS Speedometers.....	5	Sahara	12	White Multifunction	19
Multi Gauges	14	Sterling	13	Deep-Vee Multifunction	19
Matrix Gauges	4	Black Sterling.....	14	Depth Gauge	19
Premier Pro	6	Amega	15	Senders	20
White Premier Pro	7	Arctic.....	16	Sender Codes/Accessories	22-23
Argent Pro	8	Eclipse.....	17		

SIERRA SWITCH & POWER SYSTEMS (MARINE WORKS SECTION)

Audible Engine Warning System.....	63	Indicator Lights	52	Terminal Studs	61
Battery Cables.....	76	Interior RV Style Switches	44	Waterproof Terminals and	
Battery Isolators.....	70	Junction Blocks.....	60	Connectors	71
Battery Switches.....	69	Lanyards.....	32	Solenoid Switches	76
Battery Accessories.....	76	Lever Switches	69	Switch/Control Panels	35
Bus Bars/Covers.....	58-61	NMEA Cabels.....	65	Test Clips.....	72
Circuit Breakers.....	63-64	Push Button Switches.....	50-52	Testers.....	72
Compartment Locks		Push Pull Switches	50-52	Toggle Switches	45-48
and Latches	73-74	Replacement Knobs	33	Trailer Bearing Kits/Sets.....	70
Contura® Switches.....	37-41	Rocker Switches.....	35-43	Trailer Connectors	66-67
Cotter Pins.....	70	Rotary Switches		Adapters.....	67
Docking Lights	74	& Accessories	33-34	Converters and Isolators.....	66
Electrical Tools and Testers	73	Solderless Terminals and		Universal (Splice-In Style)	
Emergency Engine		Connectors.....	71-72	Trailer Connectors	66-67
Cutoff Switches.....	32, 53	Electrical Accessories.....	71-72	Heavy Duty Connectors	67
Face and Boot Nuts.....	32, 48	Quick Disconnects,		Polarized Connectors.....	67
Fuse Blocks	55-57	Butt Connectors &		Trailer Seals	70
Fuse Holders	62-63	Bullet Terminals	71-72	Transom Plates	70
Fuse Kits.....	53-54	Ring, Spade and Hook		Trim Motors	74
Fuses.....	53-55	Terminals	71-72	Trolling Motor Plugs.....	35
Ignition Switches.....	25-26	Terminal and Wiring			
Illumination Modules.....	33	Accessory Kits	71-72		

SHIELDS MARINE HOSE SECTION

Air Conditioner.....	110-111	Exhaust Hose	88-93	Oil Hose.....	98
Bilge Hose	83-86	Exhaust Protector Valves	122	Potable Hose	94-97
Brass Connectors.....	104	Fuel Hose	98-105	Product Application Guide	78-80
Conduit.....	123-124	Gasket Material	125	Sanitation Hose	106-109
Coolant/Engine		Hose Clamps.....	122	Speedometer Pitot Tubing.....	125
Intake Hose.....	87-88	Hump Couplers.....	118, 220	Ventilation Hose	110-111
Drain Hose.....	83-86	Livewell Hose	83-86	Wet Exhaust Hose.....	112-121

GENERATOR PARTS SECTION

FUEL 126-127 Air Filters 126 Carb Kits 126 Fuel Filters 126-127 Senders 127 COOLING..... 128-133 Impellers 128 Impeller Kits 128-129 Thermostats 130	Cooling (Cont.)..... Thermostat Gaskets..... 131-132 Thermostat Kits..... 132-133 IGNITION..... 133-134 Distributor Caps 133 Plug Wire Sets 134 Rotors 134 INTERNAL ENGINE.. 134-135 Oil Filters..... 134-135	OIL & LUBE 135 Oil 135 ELECTRICAL..... 135-136 Alternators/Alternator Belts 136 Anodes 136 Hourmeters 135 Solenoid 136 Starters 136 APPLICATION GUIDE . 138-151
--	---	--

SIERRA MARINE SECTION

ACCESSORIES/MISCELLANEOUS 153-238

FUEL 152-179 Bowl Wrench 157-158 Carburetor to Carburetor Kit Interchange 175-179 Carburetors 170-179 Drain Bowls/O-Rings..... 154-157 Fuel Connectors..... 163 Fuel Filters 152-158 Fuel Hose..... 163-164, 172 Fuel Line Assemblies 159-162, 165-166 Fuel Pumps 167-169 Fuel Water Separators/Brackets 152-160 Intake Manifolds 170 International Fuel Products... 164-166 Primer Bulbs 158, 164 Racor Filters 156 Fuel / Gas Filters w/ Replacement Bowls 156	Gas Filled Lift Supports and Accessories (Nautalift™) 221-222 IGNITION..... 180-199 Distributors..... 180-183 Distributor Parts 183-184 Spark Plug Wire Sets..... 189-199 OIL FILTERS 200-202 Quick-Reference Guide . 1167-1190 Alpha Cross Reference 1191-1193 OIL & LUBE 203-218 Engine Care Products..... 204-220 Engine Oil 204-212 Fluid Dispensers 218 Fuel Injection Cleaning 217 Gear Lube 214 Gear Lube Capacity Charts 1194-1199 Oil Change Kits..... 215-216 Oil Cross Ref. Charts 210 Oil Display Rack..... 203	Oil Drain Kits 215 Hydro Defense Marine Grease . 215 TOOLS & SHOP SUPPLIES 216-238 Clamp Assortments..... 220 Degreasers 217 Engine Flushers 220 Fuel Tester..... 216 Fuel Inj. Cleaners/Boosters..... 217 Fuel Injector Cleaning Kit..... 217 Gear Lube Adapters..... 218 Grease Guns..... 218-219 Loctite® Products..... 219 Manuals, Seloc 231-233 Oil Extractors 218 Oil Filter Wrenches 218 Oil Pads 218 STATS 234-236 Sanitation System Cleaner 217 Safe-Skeg 230 Testers 228-229 Tools 217-230
---	---	--

CHRIS-CRAFT® 578-589

COOLING..... 587-589 Manifolds & Related Product 587-589 ELECTRICAL..... 583-584 Battery Cables 583 Solenoids 583 Starters 583 Voltage Regulators 584 FUEL 584-589 Carburetor Kits 584 Exhaust Protector Valves..... 586	Fuel (Cont.) Floats 584 Freeze Plugs..... 584 Fuel Hose..... 585 Fuel Pumps 585 Fuel Water Separators/Brackets 152-160, 586 IGNITION..... 578-583 Contact Sets 578-579 Coils 582 Condensers..... 579 Conversion Kits..... 581	Ignition (Cont.)..... Distributor Caps 579 Distributors..... 581-582 Multi Meter/DVA Tester..... 581 Rotors 579 Spark Plug Wire/Sets..... 580 Tune-Up Kits..... 578, 580 INTERNAL ENGINE..... 589 Gaskets..... 589 Head Gaskets 589 Oil Filters..... 589
---	--	--

CHRYSLER/FORCE® 239-257

COOLING..... 247

Impellers/Repair Kits 247-248
 Thermostats 247

DRIVE..... 256-257

Gear Bearings 257
 O-Rings 257
 Oil Seals 257
 Prop Nut Kits 256
 Seal Kits 256
 Trailing Sticks 257

ELECTRICAL..... 242-243

Starters 242
 Trim & Tilt Motors 242
 Voltage Regulators 242

FUEL 243-247

Carburetor Kits and
 Related Products 243
 Fuel Connectors 247
 Fuel Line Assemblies 247
 Fuel Pump Kits 243
 Fuel Water
 Separators/Brackets 152-160, 246
 Primer Bulbs 247

IGNITION..... 239-241

Battery Cables 241
 Coils 239
 Condensers 239
 Contact Sets 239
 Ignition Wire 241

Ignition (Cont.)

Solenoids 239
 Spark Plug Boots 241
 Spark Plug Wires/Sets 241
 Strators/Kits 239
 Switch Boxes 239
 Tune-Up Kits 239

INTERNAL ENGINE.. 251-257

Bearing Carriers 254
 Gaskets/Sets 251-254
 Head Gaskets 252
 Pistons/Rings 251

CHRYSLER INBOARD® 590-606

COOLING..... 596-606

Exhaust Protector Valves 597
 Exploded Views 598-603
 Impellers/Kits 597
 Manifolds &
 Related Product 604-606
 Thermostats 596
 Water Pumps 597

ELECTRICAL..... 594-595

Alternators 595
 Battery Cables 594
 Solenoids 594
 Starters 595
 Voltage Regulators 594-595

FUEL 595-596

Carburetor Kits and
 Related Products 595
 Flame Arrestors 596
 Fuel Hose 596
 Fuel Pumps 596
 Fuel Water
 Separators/Brackets 152-160, 596

IGNITION..... 590-593

Coils 592
 Condensers 590
 Contact Sets 590
 Conversion Kits 591-592
 Distributor Caps 590

Ignition (Cont.)

Distributors 591
 Rotors 590
 Spark Plug Wires/Kits 591
 Tune-Up Kits 590-591

INTERNAL ENGINE..... 597

Gaskets 597
 Oil Filters 597

CRUSADER® 607-630

COOLING..... 618-629

Exhaust Protector Valves 619
 Exploded Views 620-624
 Impellers/Repair Kits 618
 Manifolds &
 Related Product 625-629
 Senders 619
 Thermostats/Kits 619
 Water Pumps 619

ELECTRICAL..... 615-616

Solenoids 615
 Starter Brush Set 615
 Starters 615
 Voltage Regulators 616

FUEL 616-618

Carburetor Kits and
 Related Products 616-617
 Carburetors 616
 Flame Arrestors 617
 Fuel Hose 617
 Fuel Pumps 616-618
 Fuel Water
 Separators/Brackets ..152-160, 618

IGNITION..... 607-615

Coils 614
 Condensers 609
 Contact Sets 609
 Conversion Kits 611-612
 Distributor Caps 610-611

Ignition (Cont.)

Ignition Modules 614
 Distributors/Parts 613-614
 Rotors 609-610
 Spark Plug Wires/Kits 612-613
 Tune-Up Kits 607-610

INTERNAL ENGINE..... 630

Gasket Sets/Gaskets 630
 Head Gaskets 630
 Oil Filters 630

MODEL IDENTIFICATION CHART 607

DIESEL 679-691

HIGH PERFORMANCE PRODUCTS 662-666

HONDA® 258-268

COOLING..... 262-267	ELECTRICAL..... 258-259	IGNITION..... 261
Gaskets..... 266-267	Starters..... 259	Camshaft Sensors..... 261
Impellers/Repair Kits..... 262-264	Tilt/Trim Motors..... 259	Coils..... 257
Thermostats..... 262	Wiring Harness..... 259	Spark Plug Wire/Kits/Boots..... 258
DRIVE..... 267	FUEL..... 260-261	INTERNAL ENGINE..... 267
Anodes..... 268	Fuel Connectors..... 260	Bearings..... 267
Oil Seals..... 268	Fuel Filters/Kits..... 152-160, 260	Oil Filters..... 267
Seal Kits..... 268	Fuel Line Assemblies..... 260	MODEL IDENTIFICATION
Prop Nut Kits..... 268	Primer Bulbs..... 260	CHART..... 269

INBOARD ACCESSORIES 573-577

Anodes..... 577	Packing..... 577	Transmission Repair Kits..... 577
Flywheel Bell Housing..... 576	Seals & Seats..... 576	Water Pumps..... 575
Impellers/Kits..... 573-576	Transmission Oil Coolers..... 576	Water Pump Gaskets..... 579

INDMAR® 631-634

INTERNAL ENGINE COMPONENTS 667-678

JABSCO® 574

JOHNSON/EVINRUDE® 269-371

COOLING..... 294-310	ELECTRICAL..... 278-284	Ignition (Cont.)
Exploded Views..... 308	Rectifiers/Regulators..... 281	Coils..... 271
Impellers/Kits..... 294-295	Solenoids..... 279-280	Power Packs..... 273-274
Thermostats/Kits..... 307	Starters..... 282-284	Spark Plug Wires/Kits..... 276-277
Water Pump	Stators..... 278	Switches..... 277
Housings/Kits..... 298-303	Tilt/Trim Motors..... 278	Tune-Up Kits..... 270
DRIVE..... 327-371	FUEL..... 285-294	INTERNAL ENGINE.. 310-327
Anodes..... 361	Carburetor Kits and	Bearings/Kits..... 313-314
Bearings..... 349-350	Related Products..... 285-288	Connecting Rods..... 313
Drive Shafts..... 352	Clamp Assortment..... 294	Crankshaft Seal Kits..... 318
Exploded Views..... 336-345	Fuel Connectors..... 293	Gaskets/Sets..... 319-323
Gears/Sets..... 354-355	Fuel Filters..... 292	Head Gaskets..... 324-325
Lower Gearcase Assemblies... 346	Fuel Hose..... 293	Hose..... 319
Oil Seals..... 365	Fuel Line Assemblies..... 293	Oil Filters..... 319
O-Rings..... 368	Fuel Pumps/Kits..... 288-290	Pistons/Rings..... 310-312
Prop Nuts/Kits..... 347	Fuel Water Separators/	Stainless Steel Bolts..... 327
Prop Shafts..... 353	Brackets..... 290-291	MODEL IDENTIFICATION
Seal Kits..... 361-364	Primer Bulbs..... 293	CHART..... 269-270
Shims..... 359	IGNITION..... 270-278	STARTER SYSTEM..... 334
Spacers/Washers..... 347-349	Condensers..... 270	Rewind Springs..... 334
Throttle Cables..... 359	Contact Sets..... 270	Starter Pawls..... 334
Trailerling Sticks..... 355		Starter Rope..... 334

JOHNSON PUMP® 574-575

MALLORY® 1014-1015

MARINE POWER® 635-636

MCCULLOCH/SCOTT-ATWATER® 372

MERCURISER® 692-879

COOLING.....752-807

Exploded Views .756-757, 781-793
 Impellers/Kits 752-759
 Manifolds and
 Related Products 794-807
 Molded Hose 770-773
 Oil/Temperature Senders..... 769
 Pulleys 751
 Serpentine Belts..... 780
 Thermostat Housings 759
 Thermostats/Kits 758-759
 V-Belts 774-779
 Water Pumps/Kits 754-755
 Water Circulating Pumps 752

DRIVE.....831-879

Anodes..... 861-862
 Bearings/Kits..... 858-864
 Bellows..... 852
 Carrier Bearings..... 860-861
 Drive Shafts 850, 860
 Engine Couplers 855
 Exhaust Protector Valves..... 874
 Exploded Views 834-843
 Gear Housing Assemblies. 844-845
 Gears/Sets 846-848, 858-859
 Gimbal Bearings 849
 Lower Gear Cases 844-845
 O-Rings..... 876
 Oil Seals..... 875
 Outdrive Gasket Sets 832
 Pivot Pins 870

Drive (Cont.).....

Power Trim Cylinders/Kits..... 868
 Power Trim Hoses 865-867
 Prop Nuts/Kits 865
 Prop Shafts 859
 Seal Kits 872-873
 Shift Cables/Kits..... 853-854
 Shift Spool Assemblies 860
 Shims/Kits 844
 Transom Seal/Kits..... 851-852
 U-Joints..... 848
 Upper Gear Cases 845
 Upper Units/Kits 845-848
 Yokes/Yoke Assemblies 848

ELECTRICAL.....714-726

Alternators..... 720-722
 Solenoids 718-719
 Starters 714-717
 Trim/Tilt Motors 719-720
 Voltage Regulators 722

FUEL727-751

Carburetor Kits and
 Related Product 737-738
 Carburetors 732-733
 Electrical Fuel Pumps 742-743
 Flame Arrestors 742
 Fuel Filters 750-751
 Fuel Hose..... 737
 Fuel Water Separators/
 Brackets 748-750

Fuel (Cont.)

Fuel Injection Components.. 727-731
 Mechanical Fuel Pumps.... 742-748

IGNITION.....694-714

Coils 697-698
 Condensers..... 696
 Contact Sets 695
 Conversion Kits 699
 Distributor Caps 696-697
 Distributors 700-703
 Ignition Modules..... 698
 Rotors 696
 Spark Plug Wires/Kits 711-714
 Tune-Up Kits 694-695

INTERNAL ENGINE.. 808-833

Bearings..... 813-818
 Crankshaft/Timing
 Cover Seals 818
 Cylinder Head Assemblies..... 808
 Gaskets/Sets..... 820-830
 Head Gaskets 825
 Hydraulic Lifters 809
 Modular Gasket Sets 671-678
 Oil Filters..... 808
 Oil Pans 808
 Pistons/Rings 809-813
 Valve Stem Seals..... 818

**MODEL IDENTIFICATION
 CHART692-693**

MERCURY/MARINER® 373-472

COOLING.....409-420

Impellers/Repair Kits..... 409-413
 Thermostats/Kits 409
 Water Pump
 Housings/Kits..... 411-416

DRIVE.....444-472

Anodes..... 458-459
 Bearings/Kits..... 450-453
 Clutches 454-455
 Drive Shafts 454
 Exploded Views 444-449
 Gearcases/Housings..... 455
 Gears/Sets 454-455
 Manual Release Valve 381
 Oil Seals..... 464
 O-Rings..... 467
 Power Trim Hoses 457
 Prop Nuts/Kits..... 457
 Prop Shafts 454
 Seal Kits 459-462
 Spanner Nuts/Washers 456

ELECTRICAL.....382-394

Alternators..... 390
 Relays 387
 Serpentine Belts..... 390
 Solenoids 386-387
 Starters 391
 Stators..... 383-384
 Tilt/Trim Motors..... 382-383
 Trigger Assemblies 384
 Voltage Regulators 386

FUEL395-408

Air Filters..... 408
 Carburetor Kits and
 Related Products 395-396
 Fuel Connectors..... 402-404
 Fuel Filters 407-408
 Fuel Line Assemblies..... 402-403
 Fuel Pumps/Kits..... 400
 Fuel Water Separators/
 Brackets 405-407
 Primer Bulbs 403-404

IGNITION.....373-381

Condensers..... 375
 Contact Sets 374-375
 Coils 376
 Spark Plug Wires/Kits 380-381
 Switch Boxes 376-377
 Switches..... 381
 Tune-Up Kits 374

INTERNAL ENGINE.. 421-443

Bearings..... 424
 Gasket/Sets 430-443
 Motor Mounts 429
 Oil Filters..... 429
 Pistons/Rings 421-424
 Timing Belts 429

**MODEL IDENTIFICATION
 CHART373-374**

STARTER SYSTEM 394
 Rewind Springs/Rope 394

NISSAN/TOHATSU® 473-471**OBERDORFER® 575-576****OMC STERNDRIVE/COBRA® 880-935****COOLING..... 905-919**

Exploded Views	912-914
Impellers/Kits	906-909
Manifolds and Related Products	915-919
Molded Hose	910
Temperature Senders	909
Thermostats/Kits	909-910
V-Belts	911
Water Circulating Pumps	905
Water Pump Housings/Kits ..	908-909

DRIVE..... 930-935

Anodes	944-945
Bearing Housings	942
Bearings	938
Bellows /Kits	936-937
Carrier Bearings	938, 941
Drive Shafts	939-931
Engine Couplers	937
Exploded Views	930-931
Gear Housings	932
Gears/Sets	940
Gimbal Bearings	932
Oil Seals	949
O-Rings	951
Prop Nuts/Kits	943
Prop Shafts	940
Seal Kits	944, 946-948

Drive (Cont.).....

Shafts	943
Shims	932
Shift Rods	942
Trailer Clips	943
Transom Seals/Kits ..	936-937, 948
U-Joints	933
Yoke Assemblies	933

ELECTRICAL..... 891-896

Alternators/Rebuild Kits	895
Relays	896
Solenoids	883
Starters	891-892
Tilt/Trim Motors	896
Voltage Regulators	895

ENGINE MANAGEMENT. 905

Oil Pressure Light Switch	905
---------------------------------	-----

FUEL 896-905

Carburetor Kits and Related Products	898-899
Carburetors	897
Flame Arrestors	902
Fuel Filters	904-905
Fuel Hose	901
Fuel Injection Components	896
Fuel Pumps	901-902
Fuel Water Separators/ Brackets	902-904

Fuel (Cont.)

Hose Barbs	905
------------------	-----

IGNITION..... 880-890

Coils	883
Condensers	881
Contact Sets	881
Conversion Kits	884-885
Distributor Caps	882
Distributors	885-887
Ignition Modules	882
Rotors	881-882
Spark Plug Wires/Kits	889-890
Tune-Up Kits	880-881

INTERNAL ENGINE.. 920-929

Bearings	922
Crankshaft/Timing Cover Seals	922
Cylinder Head Assemblies	920
Drain Screws	929
Gaskets/Sets	923-929
Head Gaskets	925
Hydraulic Lifters	921
Modular Gasket Sets	671-678
Oil Filters	920
Pistons/Rings	921
Valve Stem Seals	929

PERSONAL WATER CRAFT® 569-572**PLEASURECRAFT® 637-650****COOLING..... 646-649**

Exploded Views	647
Impellers/Kits	646
Manifolds and Related Products	648-649
Thermostats/Kits	646
Water Pumps	646

DRIVE..... 650

Power Trim Hoses	650
Prop Nuts/Kits	650

ELECTRICAL..... 643-644

Alternators	644
Solenoids	644
Starters	643-644

FUEL 644-646

Carburetor Kits and Related Products	645
Float	644
Fuel Filters	646
Fuel Pumps	646
Fuel Water Separators/Brackets	645
Sensors	645

IGNITION..... 637-643

Coils	642-643
Condensers	638
Contact Sets	638
Conversion Kits	639-640
Distributor Caps	638-639

Ignition (Cont.)

Distributors	640-641
Rotors	638
Spark Plug Wires/Kits	641-642
Tune-Up Kits	637-638

INTERNAL ENGINE.. 649-650

Gaskets/Sets	649
Head Gaskets	650
Oil Filters	650
Pipe Plugs	649

**MODEL IDENTIFICATION
CHART 637**

PRESTOLITE® 1016

SHERWOOD PUMP® 576

SUZUKI® 478-490

COOLING..... 482-485

- Impellers/Kits 482-484
- Thermostat Gaskets..... 485
- Water Pump Gaskets/Kits . 484-485

DRIVE..... 488-490

- Anodes..... 488
- Lower Unit Seal Kits..... 488-490
- O-Rings..... 490
- Oil Seals..... 490
- Prop Nuts/Kits..... 488

ELECTRICAL..... 479-480

- Starters 479
- Tilt/Trim Motors 480

FUEL..... 480-482

- Carburetor Kits..... 480
- Fuel Connectors..... 482
- Fuel Water
 - Separators/Brackets 481
- Oxygen Sensor 481
- Primer Bulbs 482

IGNITION..... 478

- Spark Plug Wires/Kits 478

INTERNAL ENGINE.. 486-487

- Bearings..... 486
- Connecting Rods/Kits 486
- Gaskets..... 486-487
- Head Gaskets 486-487
- Oil Filters..... 487
- Pistons/Rings..... 486

MODEL IDENTIFICATION CHART 478

UNIVERSAL 651-661

COOLING..... 654-661

- Exploded Views 654-659
- Manifolds and
 - Related Products 660-661

ELECTRICAL..... 652

- Alternators..... 652
- Solenoids 652

FUEL..... 653

- Carburetor Kits..... 653
- Fuel Water Separators..... 653
- Fuel Hose..... 653

IGNITION..... 651-652

- Coils/Leads 652
- Condensers..... 651

Ignition (Cont.).....

- Contact Sets 651
- Distributor Caps 651-652
- Rotors 651
- Tune-Up Kits..... 651

VOLVO-PENTA® 954-1011

COOLING..... 981-992

- Exploded Views 985-986
- Gaskets/Sets..... 988-990
- Hose..... 984
- Impellers/Kits 982-983
- Manifolds and
 - Related Products 987-990
- Molded Hose..... 984
- Thermostats/Kits 991-992
- V-Belts 984
- Water Pump Kits 982-983
- Water Pumps 981

DRIVE..... 1005-1011

- Anodes..... 1009-1010
- Bellows/Kits..... 1006, 1010
- Engine Couplers 1005
- Exhaust Hose..... 1006
- Gimbal Bearings 1007
- O-Rings..... 1011
- Oil Seals..... 1011
- Power Trim Hoses 1005
- Prop Nuts/Kits..... 1008
- Seal Kits..... 1010-1011
- Trailer Clips..... 1006
- U-Joints..... 1007
- Yokes..... 1007

ELECTRICAL..... 969-974

- Alternators..... 970-971
- Relays 973
- Solenoids 972
- Starters 969-970
- Tilt/Trim Motors 973-974

ENGINE APPLICATION GUIDE 954-956

ENGINE MANAGEMENT. 980

- Oil Pressure Light Switch..... 980

FUEL..... 974-980

- Air Filters 980
- Carburetor Kits and
 - Related Product 974-975
- Carburetors 974
- Electrical Fuel Pumps 976
- Fuel Filters 978-980
- Fuel Hose..... 975
- Fuel Water Separators/
 - Brackets 977-978
- Mechanical Fuel Pumps..... 976
- Sensors..... 980

IGNITION..... 954-968

- Camshaft Sensor 959

Ignition (Cont.).....

- Coils 959
- Condensers..... 957
- Contact Sets 957
- Conversion Kits..... 960-961
- Crankshaft Sensor 959
- Distributor Caps 958-959
- Distributors..... 960-961
- Rotors 957-958
- Spark Plug Wires/Kits 962-964
- Tune-Up Kits 957

INTERNAL ENGINE.994-1005

- Air Filters..... 995
- Bearings..... 998
- Belts..... 994
- Camshafts/Kits..... 994
- Cylinder Head Assemblies..... 996
- Expansion Plugs 995
- Gaskets/Sets..... 999-1005
- Head Gaskets 999-1001
- Hydraulic Lifters 997
- Modular Gasket Sets 671-678
- Oil Filters..... 995-996
- Pistons/Rings..... 997
- Power Steering Pump Pulley ... 995
- Valves 994
- Valve Lifters 994
- Valve Stem Seals..... 998

YAMAHA® 494-568

COOLING..... 513-532
 Impellers/Kits 513-514
 Thermostats/Kits 528-529
 Water Pump Housing/Kits.. 514-523

ELECTRICAL..... 495-500
 Brush Holder Assemblies..... 499
 Starters 495-496
 Tilt/Trim Motors 499-500

IGNITION..... 491-494
 CDIs/Assemblies..... 491-492
 Coils 491-492
 Ignition Switches 493
 Spark Plug Wires/Kits 492

DRIVE..... 550-568
 Anodes..... 551
 Carrier Bearings..... 550
 Exploded Views 554-563
 O-Rings..... 568
 Oil Seals..... 568
 Prop Nuts/Kits 551-552
 Prop Shafts 550
 Seal Kits..... 564-567

FUEL 500-513
 Carburetor Kits and
 Related Products 500-502
 Fuel Connectors..... 512-513
 Fuel Filters 508-511
 Fuel Line Assemblies..... 512
 Fuel Pump Diaphragms/Kits... 505-506
 Fuel Pumps 505
 Fuel Water Separators/
 Brackets 506-508
 Primer Bulbs 512

INTERNAL ENGINE.. 533-550
 Bearings/Kits..... 534
 Connecting Rods/Kits 534
 Gaskets/Sets..... 536-550
 Head Gaskets 539
 Oil Filters..... 535-539
 Timing Belts 536
 Pistons/Rings 533-534

**MODEL IDENTIFICATION
 CHART 491**

YAMAHA STERNDRIVE® 1012-1013

INTERCHANGE SECTION

Gear Lube Capacity Charts . 1194-1199
 Oil Filter Quick-Reference ... 1167-1190
 Carburetor to Carburetor Kit
 Interchange..... 175-179
 Competitive Interchange.... 1029-1047
 Mallory Distributor Parts
 Guide 1014-1015

Original Equipment Part No.
 Interchange Guide 1048-1092
 Outboard Model to Year to
 Horsepower Guide..... 1017-1028
 Part Number to Page Number Guide
 Electrical Products..... 1095-1098
 Gauges 1094-1095

Part Number to Page Number Guide (Cont.)
 Generator Parts 1099
 Shields 1098
 Sierra 1100-1164
 Prestolite Distributor Parts Guide.. 1016
 Sierra Oil Cross-Reference 210





	Premier Pro	White Premier Pro	Driftwood	Lido	Lido Pro	Argent Pro
Fuel Gauge	2" 62718P	2" 62551P	2" 61548P	2" 65486P	2" 58655P	2" 65524P
Hourmeter 10,000 hrs (non-illuminated)	2" 62718P	2" 62538P	2" 62952P	2" 65487P	2" 58418P	
Oil Pressure Gauge (SW) 0-80 PSI	2" 62720P	2" 62542P	2" 61550P	2" 65501P	2" 58653P	2" 65526P
Oil Pressure Gauge (SW) 0-100 PSI		2" 62843P		2" 65488P		2" 65525P
Water Pressure Kit (Outboard) 30 PSI	2" 62721P		2" 62980P	2" 65507P	2" 63529P	2" 68591P
Water Pressure Kit (Outboard) 40 PSI		2" 67657P				
GPS Speedo 35 MPH	2" 781-627-035P	2" 781-625-035P			2" 781-310-035P	
GPS Speedo 60 MPH	2" 781-627-060P	2" 781-625-060P			2" 781-310-060P	2" 781-294-060P
GPS Speedo 80 MPH	2" 781-627-080P	2" 781-625-080P				
GPS Speedo 120 MPH	2" 781-627-120P	2" 781-625-120P				
Speedo Kit 35 MPH (Pitot Type)				2" 61751P	2" 61751P	
Speedo Kit 50 MPH (Pitot Type)			2" 61647P	2" 61752P	2" 61752FP	2" 65528P, 2" 65530P
Speedo Kit 60 MPH (Pitot Type)						
Speedo Kit 65 MPH (Pitot Type)	2" 62722P	2" 62546P		2" 65510P	2" 58713P	
Speedo Kit 70 MPH (Pitot Type)						2" 65531P
Speedo Kit 80 MPH (Pitot Type)				2" 65870P		
Tachometer, 0-6000 RPM O/B & 4 Cycle Gas	2" 62724P					
Tachometer, 0-7000 RPM O/B & 4 Cycle Gas		2" 62961P	2" 61948P	2" 65693P	2" 58737P	2" 65536P, 2" 65538P
Tachometer, 0-8000 RPM O/B & 4 Cycle Gas	2" 62725P					
Tachometer 0-4000 RPM Diesel Aft		2" 62547P		2" 65671P		2" 65537P
Diesel Magnetic Pickup, 90-180 Teeth		2" 62548P		2" 65682P		
Tach/Hour 0-7000 RPM O/B & 4 Cycle Gas		2" 62566P		2" 65129P		2" 65645P
Tachometer - System check gauge				2" 64477FP		
Water Temp (SW) 120-240°F	2" 62728P	2" 62540P	2" 61952P*	2" 65508P	2" 58654P	2" 65553P
Water Temperature Kit (Outboards)	2" 62719P			2" 65505P		
Trim Gauge Evinrude/Johnson	2" 62726P	2" 62550P		2" 65502P		2" 65547P
Trim Gauge Honda			2" 62375P	2" 65503P		
Trim Gauge Mercury OB & IQ, Mariner, Forza, Cobra, Volvo DP & SX, Yamaha 2001 & Up	2" 62727P	2" 62549P	2" 61551P	2" 65504P	2" 58657P	2" 65548P
Trim Gauge 2002 and newer Suzuki 4-Stroke	2" 62726P	2" 62550P		2" 65502P		2" 65547P
Trim Gauge pre 2001 Yamaha outboards	2" 62728P			2" 65505P		
Voltmeter 12v	2" 62730P 1	2" 62552P	2" 61549P	2" 65506P	2" 58656P	2" 65550P
Voltmeter 24v						
12V Battery Condition Indicator						
Engine Synchronizer Gauge				2" 65485P		
System Check Gauge - Evinrude/Johnson				2" 662055P		
Systems Monitor - Suzuki						
Ammeter 60-0-60						

* **Twin Engine Outboard Add On Kit - Tachometer, Voltmeter**

* **Twin Engine Inboard/Sterndrive Kit - Tachometer, Water Temperature, Oil Pressure, Voltmeter**

* **Outboard Kit - Tachometer, Speedometer (65 MPH with pitot tube), Fuel Gauge (compatible with common marine senders), and Voltmeter. Matching Trim Gauges, Hourmeters and Water Pressure or Temperature Kits are available separately. (Not for diesels.)**

* **Sterndrive Kit - Tachometer, Speedometer (65 MPH with pitot tube), Fuel Gauge, Water Temperature Gauge, Oil Pressure Gauge (all compatible with common marine senders), and Voltmeter. Matching Trim Gauges and Hourmeters are available separately for stern drive applications. (Not for diesels.)**

* (100-220°F) range.

* 0-3500 RPM.



Sahara	Sterling	Black Sterling	Omega	Arctic	Eclipse	Heavy Duty
2" 59707P	2" 63477P	2" 67021P	2" 57902P	2" 68360P	2" 68300P	2" 80150P
			2" 64760P	2" 68360P	2" 68311P	2" 82760P
2" 59705P	2" 63479P	2" 67022P	2" 57903P	2" 68367P	2" 68382P	2" 80180P
			2" 57909P		2" 68383P	2" 80191P
2" 69670P	2" 63481P		2" 61238P			
		2" 67382P	2" 68357P	2" 68369P	2" 68394P	
			2" 781-579-035P	2" 781-683-035P	2" 781-684-035P	
			2" 781-579-080P	2" 781-683-080P	2" 781-684-080P	
			2" 781-579-080P	2" 781-683-080P	2" 781-684-080P	
2" 61625P			2" 58342P	2" 68370P	2" 68385P	
2" 81163P		2" 69960P	2" 57889P			2" 80514P
2" 59704P	2" 63478P		2" 57900P	2" 68371P	2" 68395P	
2" 63070P	2" 63476P	2" 67245P	2" 57909P	2" 68372P	2" 68397P	
						2" 82288P
2" 59703P	2" 63478P	2" 67363P	2" 58255P	2" 68374P	2" 68399P	
			2" 68368P	2" 68373P	2" 68398P	2" 82302P
						2" 82303P
2" 69743P	2" 63474P	2" 67364P	2" 66443P	2" 68375P	2" 68400P	
2" 81901P			2" 38915P			
2" 59706P	2" 63480P	2" 67020P	2" 57904P	2" 68376P	2" 68401P	2" 80590P
			2" 58920P	2" 68377P	2" 68402P	
2" 81908P	2" 63483P	2" 67365P	2" 58431P	2" 68378P	2" 68402P	
2" 82388P	2" 64475P	2" 67855P	2" 68328P	2" 68379P	2" 68404P	
2" 59709P	2" 63482P	2" 67023P	2" 57905P	2" 68380P	2" 68405P	
2" 81909P	2" 63483P	2" 67366P	2" 58431P	2" 68379P	2" 68403P	
			2" 81748P	2" 68381P	2" 68405P	
2" 59708P	2" 63478P	2" 67018P	2" 57901P	2" 68382P	2" 68406P	2" 80134P
			2" 68361P	2" 68384P	2" 68407P	2" 80131P
						2" 80730P
2" 68958P	2" 63585P		2" 65205P	2" 68385P	2" 68410P	
			2" 68294P	2" 68386P	2" 68389P	2" 80710P

* **Outboard Kit w/ Tach/Hr** - Tachometer/Hourmeter, Speedometer (65 MPH w/ Pitot Tube, Fuel Gauge (compatible with common marine senders), and Voltmeter.

* **Inboard/Stern Drive Kit** - Tachometer/Hourmeter, Speedometer (65 MPH w/ Pitot Tube, fuel Gauge, Water Temperature Gauge, Oil Pressure Gauge (all compatible with common marine senders), and Voltmeter.

* **Matching Trim Gauges** are available separately. Not for diesels.

† 8-16 VDC



MATRIX GAUGES - The Matrix gauge set is intended to operate on Mercury SmartCraft engines (max 4 engines/2 stations) utilizing the SmartCraft® protocol. The gauges operate on 12 volt systems and support single, dual, triple or quad engine applications. In a Matrix gauge set, the 3" tachometer is the master and connects directly to the SmartCraft data bus. All other gauges are slaves and connect to the tachometer RS-485 private bus (immune to electrical noise, more robust and reliable). The tachometer reads SmartCraft engine parameters and forwards them on the private bus for the slave gauges.



FEATURES:

- Smart Tachometer CANbus driven
- All 2" gauges receive data from tachometers
- LCD on Tachometer and Speedo displays all available data and alarms
- IP67 waterproof/ submersible housings (with Connector fitted)
- Dry Nitrogen filled to minimize fogging
- LED dimmable, automotive style backlighting (red)
- CANbus connectivity

SELECTION GUIDE:

GAUGE DESCRIPTION	SIZE	PART NO.
Speedometer w/ LCD US 90 MPH	3"	70002D
Fuel Primary	2"	70003D
Fuel Secondary	2"	69992D
Voltmeter 10 - 16 VDC	2"	70004D
Temperature 240F	2"	70006D
Water pressure 40 PSI	2"	69994D
Oil Pressure 80 PSI	2"	70005D
Trim	2"	69993D
Tachometer - Smartcraft	3"	70000D
Tachometer - NEMA 2000	3"	70001D

PART NO.	DESCRIPTION
69995K	Harness - Tachometer to Smartcraft, 30"
69996K	Harness - Tachometer to NMEA 2000, 30"
69997K	Harness - Tachometer to Speedometer, 48"
69998K	Terminator - Needed when no speedo is used
69999K	Harness - Any 2" gauge to another, 8"

PARAMETERS SUPPORTED			
• Engine RPM	• Reserve Oil Level	• Throttle Position	• Tank 2
• Coolant Temperature	• Water Pressure	• Load Percent	• RPM Synch
• Engine Oil Pressure	• Coolant Pressure	• Oil Level	• Trim Synch
• Engine Hours	• Oil Temperature	• Boost Pressure	
• Fuel Low	• Fuel Pressure	• Tank 1	



GPS SPEEDOMETERS - These GPS speedometers provide accurate speed over ground readings and heading information all in one attractive package. Available in various speed ranges to meet your application, the GPS speedometer is offered in a number of popular styles to match the colors in your boat like Premier Pro, White Premier Pro, Omega, Arctic, Eclipse, Lido Pro and Argent Pro instrument lines.



FEATURES:

- Available in speed ranges of 35 MPH, 60 MPH, 80 MPH and 120 MPH.
- Included LCD heading display to show course over ground.
- Use our GPS antenna (sold separately) or connect to an existing NMEA 0183 GPS device – connectors included.
- Speed accuracy of +/-1 MPH (once moving).
- Heading accuracy of +/-1 degree (once moving).
- Ideal for slow speed applications like pontoon boats and for high speed performance boats where pitot tubes do not perform well.

SELECTION GUIDE:

PART NUMBER	GAUGE DESCRIPTION	SIZE	DIAL RANGE	SENDER CODE
Premier Pro: 781-627-035P	35 MPH	3"	0-35 MPH	GPS RECEIVER
781-627-060P	60 MPH	3"	0-60 MPH	GPS RECEIVER
781-627-080P	80 MPH	3"	0-80 MPH	GPS RECEIVER
781-627-120P	120 MPH	3"	0-120 MPH	GPS RECEIVER
White Premier Pro: 781-625-035P	35 MPH	3"	0-35 MPH	GPS RECEIVER
781-625-060P	60 MPH	3"	0-60 MPH	GPS RECEIVER
781-625-080P	80 MPH	3"	0-80 MPH	GPS RECEIVER
781-625-120P	120 MPH	3"	0-120 MPH	GPS RECEIVER
Omega: 781-579-035P	35 MPH	3"	0-35 MPH	GPS RECEIVER
781-579-060P	60 MPH	3"	0-60 MPH	GPS RECEIVER
781-579-080P	80 MPH	3"	0-80 MPH	GPS RECEIVER
Arctic: 781-683-035P	35 MPH	3"	0-35 MPH	GPS RECEIVER
781-683-060P	60 MPH	3"	0-60 MPH	GPS RECEIVER
781-683-080P	80 MPH	3"	0-80 MPH	GPS RECEIVER
Eclipse: 781-684-035P	35 MPH	3"	0-35 MPH	GPS RECEIVER
781-684-060P	60 MPH	3"	0-60 MPH	GPS RECEIVER
781-684-080P	80 MPH	3"	0-80 MPH	GPS RECEIVER
Lido Pro: 781-310-035P	35 MPH	3"	0-35 MPH	GPS RECEIVER
781-310-060P	60 MPH	3"	0-60 MPH	GPS RECEIVER
Argent Pro: 781-294-060P	60 MPH	3"	0-35 MPH	GPS RECEIVER

• Display Packaged Item

GPS RECEIVERS

- Highly sensitive receiver
- Precise information output even when mounted under a fiberglass console or bimini top
- Durable exterior
- Updates once every second to output accurate NMEA 0183 information (*Updates 10 times per second.)



68982P
GPS RECEIVER
4 ft. long

69053P*
GPS RECEIVER (HIGH SPEED)
4 ft. long



68755P
GPS RECEIVER
25 ft. long

PREMIER PRO - A very popular OEM line, Premier features black dials with modern white and blue graphics. When lighted, white dial grads become red and pointer lights white. These instruments feature automotive type light-piping and a fog-resistant design for outstanding readability.



FEATURES:

- Full automotive type lighting, no “halo” around dial edges. When lit, white dial grads become red, pointer lights white.
- Black dial, white graduations/numerals (metrics in blue), white pointer staff.
- Scratch resistant curved glass lenses, with black, near-flush bezels.
- U.S. and metric scales, with ISO symbols, where appropriate.
- Optional add-on eyebrow or square bezels available (See Gauge Accessories for details).
- Line includes standard ignition engine synchronizer kits including module.
- Fog-Resistant Design! Complies with SAE J-1810.

SELECTION GUIDE:

GAUGE DESCRIPTION	SIZE	DIAL RANGE	SENDER CODE	PART NUMBER
Fuel Gauge:	2"	E-1/2-F	REQUIRES "F"	62718P *
Hourmeter:	2"	10,000 Hrs.	NONE REQUIRED	62719P *
Oil Pressure Gauge (Electric):				
Oil Pressure 80 PSI	2"	0-80 PSI	REQUIRES "C"	62720P *
GPS Speedometer:				
35 MPH	3"	0-35 MPH	GPS RECEIVER	781-627-035P
60 MPH	3"	0-60 MPH	GPS RECEIVER	781-627-060P
80 MPH	3"	0-80 MPH	GPS RECEIVER	781-627-080P *
120 MPH	3"	0-120 MPH	GPS RECEIVER	781-627-120P
Speedometer Kits:				
65 MPH (Pitot type)	3"	10-65 MPH	INCLUDES "G"	62722P *
80 MPH (Pitot type) Head Only	3"	20-80 MPH		62723PH
Tachometers (Electric):				
O/B & 4-Stroke Gas Engines*	3"	0-6000 RPM	O/B ALT./COIL	62724P *
O/B & 4-Stroke Gas Engines*	3"	0-8000 RPM	O/B ALT./COIL	62725P *
Trim Gauges (Outboard, I/O):				
Johnson/Evinrude (All) & Suzuki 4-stroke 2002 & Up	2"	UP-DOWN	BY ENG. MFR	62726P *
Mercury O/B & I/O, Mariner, Force, Cobra,				
Volvo DP & SX, Yamaha 2001 & Up	2"	UP-DOWN	BY ENG. MFR	62727P *
Yamaha Outboards pre-2001	2"	UP-DOWN	BY ENG. MFR	62728P *
Voltmeter-12 Volt:	2"	8-16 VDC	NONE REQUIRED	62730P *
Water Pressure Kit (Outboard):** (Each kit includes fittings and 20 feet of tubing)	2"	30 PSI	INCLUDES "WP"	62721P *
Water Temp. Kit (Outboard):** (For all electric-start outboards)	2"	COLD-HOT	INCLUDES "J"	62748P *
Water Temp. Gauge (I/O, I/B):	2"	120-240°F	REQUIRES "D"	62729P *
Instrument Set "INBOARD/STERNDRIVE"	Contains: 62724P, 62722P, 62718P, 62730P, 62729P, 62720P			62715P *

* Display Packaged Item

* Not tested for complete aftermarket ignition systems, will work with aftermarket replacement parts.

** Adapter (P/N 61886P) is required for Yamaha.

Use 4000 RPM tachometer or lower for diesel applications.

WHITE PREMIER PRO — Ideal for inboards, including diesels, Premier White features polished stainless steel bezels and clean white dials with modern black and blue graphics. When illuminated, black dial grads become red and pointer lights red. Automotive type light-piping and fog-resistant design combine for outstanding readability.



FEATURES:

- Full automotive type lighting, no "halo" around dial edges. When illuminated, black dial grads become red, pointer lights red.
- White dial, black graduations/numerals (metrics in blue), red pointer staff.
- Scratch resistant curved glass lenses, with polished stainless steel near-flush bezels.
- U.S. and metric scales, with ISO symbols, where appropriate.
- Optional add-on eyebrow or square bezels available (See Gauge Accessories for details).
- Fog-Resistant Design! Complies with SAE J-1810.

SELECTION GUIDE:

GAUGE DESCRIPTION	SIZE	DIAL RANGE	SENDER CODE	PART NUMBER
Fuel Gauge:	2"	E-1/2-F	REQUIRES "F"	62551P *
Hourmeter:	2"	10,000 Hrs.	NONE REQUIRED	62538P *
Oil Pressure Gauges (Electric):				
Oil Pressure 80 PSI	2"	0-80 PSI	REQUIRES "C"	62542P *
Oil Pressure 100 PSI	2"	0-100 PSI	REQUIRES "C"	62543P *
GPS Speedometer:				
35 MPH	3"	0-35 MPH	GPS RECEIVER	781-625-035P
60 MPH	3"	0-60 MPH	GPS RECEIVER	781-625-060P
80 MPH	3"	0-80 MPH	GPS RECEIVER	781-625-080P *
120 MPH	3"	0-120 MPH	GPS RECEIVER	781-625-120P
Speedometer Kits:				
65 MPH (Pitot type)	3"	10-65 MPH	INCLUDES "G"	62546P *
65 MPH (Pitot type) Head Only	3"	10-65 MPH		62546PH
Tachometer (Electric):				
O/B & 4-Stroke Gas Engines*	3"	0-7000 RPM	O/B ALT./COIL	62561P *
Tachometer/Hourmeter (Electric):				
O/B & 4-Stroke Gas Engines*	3"	0-7000 RPM	O/B ALT./COIL	62565P *
Tachometers (Electric):				
Diesel Alternator**	3"	0-4000 RPM	SEE "T"	62547P *
Diesel Magnetic Pickup, 90-180 Teeth	3"	0-4000 RPM	REQUIRES "B"	62548P
Trim Gauges (Outboard, I/O):				
Johnson/Evinrude (All) & Suzuki 4-Stroke 2002 & Up	2"	UP-DOWN	BY ENG. MFR	62550P *
Mercury O/B & I/O, Mariner, Force, Cobra, Volvo DP & SX, Yamaha 2001 & Up	2"	UP-DOWN	BY ENG. MFR	62549P *
Voltmeters-12 & 24 Volt:				
12 Volt System	2"	8-18 VDC	NONE REQ'D	62555P *
Water Temp. Gauge (I/O, I/B):	2"	120-240°F	REQUIRES "D"	62540P *
Water Pressure Kit, O/B	2"	40 PSI	INCLUDES "WP"	67657P *
Instrument Set "INBOARD/STERNDRIVE"	Contains: 62561P, 62546P, 62551P, 62555P, 62540P, 62542P			67654P *

* Display Packaged Item

* Not tested for complete aftermarket ignition systems, will work with aftermarket replacement parts.

** May require alternator tap.

Use 4000 RPM tachometer or lower for diesel applications.

ARGENT PRO - Black graphics on a silver background, pointer has black hub with fade resistant acrylic orange staff. Pointer is internally illuminated for excellent night visibility. Dial graphics light red when illuminated and scratch resistant glass lens with fog-resistant design and polished stainless steel bezel.



FEATURES:

- Translucent dial as well as internally illuminated pointer staff, provides the best in night visibility.
- Easy to read black graphics on a silver dial background.
- Domed glass lenses are scratch resistant.
- Low profile bezels follow the curvature of the lens, with no 'lip' to trap and hold water.
- Optional add-on eyebrow or Square bezels available (See gauge accessories for details)

FOG RESISTANT GAUGE FEATURES:

- Fog-Resistant Design! Complies with SAE J-1810.

SELECTION GUIDE:

GAUGE DESCRIPTION	SIZE	DIAL RANGE	SENDER CODE	PART NUMBER
Fuel Gauge:	2"	E-1/2-F	REQUIRES "F"	65524P *
Oil Pressure Gauge (Electric):				
Oil Pressure 80 PSI	2"	0-80 PSI	REQUIRES "C"	65526P *
Oil Pressure 100 PSI	2"	0-80 PSI	REQUIRES "C"	65525P *
GPS Speedometer:				
60 MPH (Head Only)	3"	0-60 MPH	GPS RECEIVER	781-294-060P
Speedometer Kits:				
50 MPH (Pitot type)	3"	5-50 MPH	INCLUDES "G"	65529P *
50 MPH (Pitot type)	5"	5-50 MPH	INCLUDES "G"	65530P
70 MPH (Pitot type)	3"	20-70 MPH	INCLUDES "G"	65531P *
Tachometers (Electric):				
O/B & 4-Stroke Gas Engines*	3"	0-7000 RPM	O/B ALT./COIL	65535P *
O/B & 4-Stroke Gas Engines*	5"	0-7000 RPM	O/B ALT./COIL	65536P *
Diesel Alternator*	3"	0-4000 RPM	O/B ALT./COIL	65537P *
Tachometer/Hourmeter (Electric):				
O/B & 4-Stroke Gas Engines*	3"	0-7000 RPM	O/B ALT./COIL	65545P *
Trim Gauges (Outboard, I/O):				
Johnson/Evinrude (All) & Suzuki 4-stroke 2002 & Up	2"	UP-DOWN	BY ENG. MFR	65547P *
Mercury O/B & I/O, Mariner, Force, Cobra, Volvo DP & SX, Yamaha 2001 & Up	2"	UP-DOWN	BY ENG. MFR	65548P *
Voltmeter-12 Volt:	2"	10-16 VDC	NONE REQUIRED	65550P *
Water Pressure Kit (Outboard):*** Each kit includes fittings & 20 feet of tubing)	2"	30 PSI	INCLUDES "WP"	65551P *
Water Temp. Gauge (I/O) (Electric):	2"	120-240°F	REQUIRES "D"	65553P *

* Display Packaged Item

* Not tested for non-original-equipment (aftermarket) ignition systems.

*** Adapter (P/N 61886P) is required for Yamaha.

Use 4000 RPM tachometer or lower for diesel applications.



LIDO PRO - We have added a selection of fog resistant gauges to our hottest white dial line. Lido Pro features a crisp, white dial with a fire orange pointer tip. Red through-dial and white perimeter lighting provide great night readability. Coverage for popular OB and I/O applications - complete gauge kits available **.



FEATURES:

- White dial, black numerals, black pointer with fire-orange tip.
- Scratch resistant curved glass lenses, with polished stainless steel, near-flush bezels.
- U.S. and metric scales, with ISO symbols.
- Optional add-on eyebrow or square bezels available (See Gauge Accessories for details).
- White perimeter and red thru-dial lighting.

FOG RESISTANT GAUGE FEATURES:

- Fog-Resistant Design! Complies with SAE J-1810.

SELECTION GUIDE:

GAUGE DESCRIPTION	SIZE	DIAL RANGE	SENDER CODE	FOG RESISTANT
Fuel Gauge:	2"	E-1/2-F	REQUIRES "F"	59655P *
Hourmeter:	2"	10,000 Hrs.	NONE REQ'D	59416P *
Oil Pressure Gauges (Electric):				
Oil Pressure 80 PSI	2"	0-80 PSI	REQUIRES "C"	59653P *
GPS Speedometer:				
35 MPH	3"	0-35 MPH	GPS RECEIVER	781-310-035P
60 MPH	3"	0-60 MPH	GPS RECEIVER	781-310-060P
Speedometer Kits:				
50 MPH (Pitot type)	3"	10-50 MPH	INCLUDES "G"	61752FP *
65 MPH (Pitot type)	3"	10-65 MPH	INCLUDES "G"	59713P *
Tachometer (Electric):				
O/B & 4-Stroke Gas Engines*	3"	0-7000 RPM	O/B ALT./COIL	59737P *
Trim Gauges (Outboard, I/O):				
Mercury O/B & I/O, Mariner, Force, Cobra, Volvo DP & SX, Yamaha 2001 & Up	2"	UP-DOWN	BY ENG. MFR.	59657P *
Voltmeter-12 Volt:	2"	8-18 VDC	NONE REQ'D	59656P *
Water Pressure Kit (Outboard):***				
Each kit includes fittings and 20 feet of tubing)	2"	30 PSI	INCLUDES "WP"	63523P *
Water Temp. Gauge (I/O, I/B):	2"	120-240°F	REQUIRES "D"	59654P *
Instrument Set "OUTBOARD"	Contains: 59737P, 59713P, 59655P, 59656P			67669P *
Instrument Set "INBOARD/STERNDRIVE"	Contains: 59737P, 59713P, 59655P, 59656P, 59654P, 59653P			67653P *

* Display Packaged Item

* Not tested for complete aftermarket ignition systems, will work with aftermarket replacement parts.

*** Adapter (P/N 61886P) is required for Yamaha.

Use 4000 RPM tachometer or lower for diesel applications.



LIDO - Hottest selling white dial line! A comprehensive family of instruments for most engine types, Lido features crisp white dials and fire-orange pointer tips. Red through-dial and white perimeter lighting provide great night readability. Excellent inboard coverage with engine sync gauges* and diesel alternator and magnetic pickup tachometers**.

*Module required, not included with gauge. **Magnetic Pickup sender available separately.



FEATURES:

- White dial, black numerals, black pointer with fire-orange tip.
- Scratch resistant curved glass lenses, with polished stainless steel, near-flush bezels.
- U.S. and metric scales, with ISO symbols.
- Optional add-on eyebrow or square bezels available (See Gauge Accessories for details).
- White perimeter and red thru-dial lighting.
- Comprehensive line includes tachometers for diesel alternator and magnetic pickup PLUS synchronizer gauge (Suitable for gas or diesel engines with appropriate module. Module required, not included with gauge).

SELECTION GUIDE:

GAUGE DESCRIPTION	SIZE	DIAL RANGE	SENDER CODE	PART NUMBER
Engine Sync (gauge only)	2"	PORT-STBD.	REQUIRES "L"	65495P *
Fuel Gauge:	2"	E-1/2-F	REQUIRES "F"	65496P *
Hourmeter:	2"	10,000 Hrs.	NONE REQ'D	65497P *
Oil Pressure Gauges (Electric):				
Oil Pressure 80 PSI	2"	0-80 PSI	REQUIRES "C"	65501P *
Oil Pressure 100 PSI	2"	0-100 PSI	REQUIRES "C"	65498P *
Speedometer Kits:				
35 MPH (Pitot type)	3"	5-35 MPH	INCLUDES "G"	61751P
35 MPH (Pitot type) Head Only	3"	5-35 MPH		61751PH
50 MPH (Pitot type)	3"	10-50 MPH	INCLUDES "G"	61752P *
50 MPH (Pitot type) Head Only	3"	10-50 MPH		61752PH
65 MPH (Pitot type)	3"	10-65 MPH	INCLUDES "G"	65510P *
80 MPH (Pitot type)	3"	20-80 MPH	INCLUDES "G"	65670P *
80 MPH (Pitot type) Head Only	3"	20-80 MPH		65670PH
Systems Check-Evinrude/Johnson:	2"	SYSTEM DATA	BY ENG. MFR.	65206SSP
Tachometer (Electric):				
O/B & 4-Stroke Gas Engines*	3"	0-7000 RPM	O/B ALT./COIL	65693P *
Systems Check - Evinrude/Johnson	3"	0-7000 RPM	O/B ALT./COIL	64477FP *
Tachometer/Hourmeters (Electric):				
O/B & 4-Stroke Gas Engines*	3"	0-7000 RPM	O/B ALT./COIL	65129P *
Diesel Alternator**	3"	0-4000 RPM	SEE "T"	65671P *
Diesel Magnetic Pickup, 90-180 Teeth	3"	0-4000 RPM	REQUIRES "B"	65692P *
Trim Gauges (Outboard, I/O):				
Johnson/Evinrude (All) & Suzuki	2"	UP-DOWN	BY ENG. MFR.	65502P *
4-stroke 2002 & Up	2"	UP-DOWN	BY ENG. MFR.	65503P
Honda:	2"	UP-DOWN	BY ENG. MFR.	65503P
Mercury O/B & I/O, Mariner, Force, Cobra,	2"	UP-DOWN	BY ENG. MFR.	65504P *
Volvo DP & SX, Yamaha 2001 & Up	2"	UP-DOWN	BY ENG. MFR.	65505P *
Yamaha Outboards pre-2001	2"	UP-DOWN	BY ENG. MFR.	65505P *
Voltmeter-12 Volt:	2"	8-18 VDC	NONE REQ'D	65506P *
Water Pressure Kit (Outboard):***				
Each kit includes fittings and 20 feet of tubing	2"	30 PSI	INCLUDES "WP"	65507P *
Water Temp. Kit (Outboard):***				
(For all electric-start outboards)	2"	COLD-HOT	INCLUDES "J"	65508P *
Water Temp. Gauge (I/O, I/B):	2"	120-240°F	REQUIRES "D"	65509P *

* Display Packaged Item

* Not tested for complete aftermarket ignition systems, will work with aftermarket replacement parts.

** May require alternator tap. *** Adapter (P/N 61886P) is required for Yamaha.

Use 4000 RPM tachometer or lower for diesel applications.

DRIFTWOOD - Features light gray dials, clean black numerals and a black pointer hub with white staff. These instruments lend a sophisticated look to any dash. Combination blue through-dial and white perimeter lighting are included for excellent readability at night.



FEATURES:

- Light gray dial, black graduations/numerals, white pointer staff.
- Scratch resistant curved glass lenses, with black, near-flush bezels.
- White perimeter and blue thru-dial lighting.
- U.S. and metric scales, with ISO symbols, where appropriate.
- Optional add-on eyebrow or square bezels available (See Gauge Accessories for details).

SELECTION GUIDE:

GAUGE DESCRIPTION	SIZE	DIAL RANGE	SENDER CODE	PART NUMBER
Fuel Gauge:	2"	E-1/2-F	REQUIRES "F"	61549P *
Hourmeter:	2"	10,000 Hrs.	NONE REQ'D	62952P *
Oil Pressure Gauge (Electric):	2"	0-80 PSI	REQUIRES "C"	61550P *
Speedometer Kits:				
50 MPH (Pitot type)	3"	10-50 MPH	INCLUDES "G"	61547P *
Tachometer (Electric):				
O/B & 4-Stroke Gas Engines*	3"	0-7000 RPM	O/B ALT./COIL	61546P *
Trim Gauges (Outboard, I/O):				
Honda	2"	UP-DOWN	BY ENG. MFR.	62375P
Mercury O/B & I/O, Mariner, Force, Cobra, Volvo DP & SX, Yamaha 2001 & Up	2"	UP-DOWN	BY ENG. MFR.	61551P *
Voltmeter-12 Volt:	2"	8-18 VDC	NONE REQ'D	61548P *
Water Pressure Kit (Outboard):** (Kit includes fittings/20 feet of tubing)	2"	30 PSI	INCLUDES "WP"	62960P *
Water Temp. Gauge (I/O, I/B):	2"	100-220°F	REQUIRES "D"	61552P *

* Display Packaged Item

* Not tested for complete aftermarket ignition systems, will work with aftermarket replacement parts.
 ** Adapter (P/N 61886P) is required for Yamaha.
 Use 4000 RPM tachometer or lower for diesel applications.



SAHARA - With crisp tan dials and fire-orange pointer tip, Sahara gives any dash the elegant OEM look. Combined red through-dial and white perimeter lighting provide great night readability. These aren't merely "close enough" — they're the real thing!



FEATURES:

- Tan dial and retainer, black graduations and numerals, black pointer with fire-orange tip.
- Scratch resistant curved glass lenses, with black matte, near-flush bezels.
- White perimeter and red thru-dial lighting.
- U.S. and metric scales, with ISO symbols, where appropriate.
- Optional add-on eyebrow or square bezels available (See Gauge Accessories for details).

SELECTION GUIDE:

GAUGE DESCRIPTION	SIZE	DIAL RANGE	SENDER CODE	PART NUMBER
Fuel Gauge:	2"	E-1/2-F	REQUIRES "F"	59707P •
Oil Pressure Gauge (Electric):	2"	0-80 PSI	REQUIRES "C"	59705P •
Speedometer Kits:				
35 MPH (Pitot type)	3"	5-35 MPH	INCLUDES "G"	61826P •
35 MPH (Pitot type) Head Only	3"	5-35 MPH		61826PH
50 MPH (Pitot type)	3"	10-50 MPH	INCLUDES "G"	61163P •
65 MPH (Pitot type)	3"	10-65 MPH	INCLUDES "G"	59704P •
65 MPH (Pitot type) Head Only	3"	10-65 MPH		59704PH
80 MPH (Pitot type)	3"	20-80 MPH	INCLUDES "G"	63076P •
80 MPH (Pitot type) Head Only	3"	20-80 MPH		63076PH
Systems Check — Evinrude/Johnson:	2"	SYSTEM DATA	BY ENG. MFR.	66956P
Tachometer (Electric):				
O/B & 4-Stroke Gas Engines*	3"	0-7000 RPM	O/B ALT./COIL	59703P •
Systems Check — Evinrude/Johnson	3"	0-7000 RPM	O/B ALT./COIL	61901P •
Tach/Hourmeter 0-7000 RPM	3"	0-7000 RPM	O/B ALT./Coil	69743P •
Trim Gauges (Outboard, I/O):				
Johnson/Evinrude (All) & Suzuki				
4-stroke 2002 & Up	2"	UP-DOWN	BY ENG. MFR.	61908P •
Honda	2"	UP-DOWN	BY ENG. MFR.	62369P
Mercury O/B & I/O, Mariner, Force, Cobra, Volvo DP & SX, Yamaha 2001 & Up	2"	UP-DOWN	BY ENG. MFR.	59709P •
Voltmeter-12 Volt:	2"	8-18 VDC	NONE REQ'D	59708P •
Water Pressure Kits (Outboard):** (Each kit includes fittings and 20 feet of tubing)	2"	40 PSI	INCLUDES "WP"	69870P •
Water Temp. Gauge (I/O, I/B):	2"	120-240°F	REQUIRES "D"	59706P •
Instrument Set "OUTBOARD"	Contains: 59703P, 59704P, 59707P, 59708P			65481P •
Instrument Set "INBOARD/STERNDRIIVE"	Contains: 59703P, 59704P, 59707P, 59708P, 59706P, 59705P			65485P •
Twin Engine Add On IB/IO Gauge Kit	Contains: 59703P, 59708P, 59706P, 59705P			69717P
Twin Engine Add On OBGauge Kit	Contains: 59703P, 59708P			69716P
Instrument Set OB w/Tach/Hr	Contains: 69743P, 59704P, 59707P, 59708P			69703P •
Instrument Set IB/IO w/Tach/Hr	Contains: 69743P, 59704P, 59707P, 59708P, 59706P, 59705P			69704P •

• Display Packaged Item

* Not tested for complete aftermarket ignition systems, will work with aftermarket replacement parts.

** Adapter (P/N 61886P) is required for Yamaha.

Use 4000 RPM tachometer or lower for diesel applications.

STERLING - Ideal for outboards and stern drives! With stainless steel bezels, brushed aluminum dials and black pointers, Sterling instruments give a bright, gleaming look to any dash. Perimeter lighting provided for night operation.



FEATURES:

- Brushed aluminum dial, black graduations/numerals, black pointer.
- Scratch resistant curved glass lenses, with polished stainless steel, near-flush bezels.
- Perimeter lighting.
- U.S. and metric scales, with ISO symbols, where appropriate.
- Optional add-on eyebrow or square bezels available (See Gauge Accessories for details).

SELECTION GUIDE:

GAUGE DESCRIPTION	SIZE	DIAL RANGE	SENDER CODE	PART NUMBER
Fuel Gauge:	2"	E-1/2-F	REQUIRES "F"	63477P *
Oil Pressure Gauge (Electric):	2"	0-80 PSI	REQUIRES "C"	63479P *
Speedometer Kits:				
65 MPH (Pitot type)	3"	10-65 MPH	INCLUDES "G"	63475P *
65 MPH (Pitot type) Head Only	3"	10-65 MPH		63475PH
80 MPH (Pitot type)	3"	20-80 MPH	INCLUDES "G"	63476P *
80 MPH (Pitot type) Head Only	3"	20-80 MPH		63476PH
Systems Check – Evinrude/Johnson:	2"	SYSTEM DATA	BY ENG. MFR.	63585P *
Tachometer (Electric):				
O/B & 4-Stroke Gas Engines*	3"	0-7000 RPM	O/B ALT./COIL	63473P *
Tachometer/Hourmeter (Electric):				
O/B & 4-Stroke Gas Engines*	3"	0-7000 RPM	O/B ALT./COIL	63474P *
Trim Gauges (Outboard, I/O):				
Honda	2"	UP-DOWN	BY ENG. MFR.	64475P
Johnson/Evinrude (All) & Suzuki 4-stroke 2002 & Up	2"	UP-DOWN	BY ENG. MFR.	63483P *
Mercury O/B & I/O, Mariner, Force, Cobra, Volvo DP & SX, Yamaha 2001 & Up	2"	UP-DOWN	BY ENG. MFR.	63482P *
Voltmeter-12 Volt:	2"	8-18 VDC	NONE REQ'D	63478P *
Water Pressure Kit (Outboard):** (Kit includes fittings/20 feet of tubing)	2"	30 PSI	INCLUDES "WP"	63481P *
Water Temp. Gauge (I/O, I/B):	2"	120-240°F	REQUIRES "D"	63480P *

* Display Packaged Item

* Not tested for complete aftermarket ignition systems, will work with aftermarket replacement parts.

** Adapter (P/N 61886P) is required for Yamaha.

Use 4000 RPM tachometer or lower for diesel applications.

BLACK STERLING - With its rich luster and polish, Black Sterling instruments convey a look of utmost sophistication and add elegance to any dash. These instruments have fire-orange pointer tips and stainless graphics for a contemporary, ultra stylish look. Black Sterling instruments have clean, crisp black dials which highlight the stainless accents.



FEATURES:

- Scratch-resistant domed glass lens.
- Perimeter lit dial.
- Elite stainless steel bezel.
- Black pointer with fire orange tip.
- White graphics and black background on spun aluminum dial.
- Optional add-on eyebrow or square bezels available (See Gauge Accessories for details).
- Fits most stern drive and outboard applications.
- US and Metric scales where appropriate.

MULTI-GAUGE FEATURES:

- Combines 2 gauges in one.
- Saves dash space.
- Fog-Resistant Design! Complies with SAE J-1810.

SELECTION GUIDE:

GAUGE DESCRIPTION	SIZE	DIAL RANGE	SENDER CODE	PART NUMBER
Fuel Gauge	2"	E-1/2-F	REQUIRES "F"	67021P *
Voltmeter	2"	8-18 VDC	NONE REQ'D	67019P *
Water Temperature (Electric)	2"	100-240°F	REQUIRES "D"	67020P *
Oil Pressure (Electric)	2"	0-80 PSI	REQUIRES "C"	67022P *
50 MPH Speedometer	3"	0-50 MPH	INCLUDES "G"	68960P *
50 MPH Speedometer (Head Only)	3"	0-50 MPH		68960PH
70 MPH Speedometer Kit	3"	0-70 MPH	INCLUDES "G"	67285P *
Tachometer: O/B & 4 Cycle Gas	3"	0-7000 RPM	O/B ALT./COIL	67363P *
Tach/LCD Hr, O/B & 4 Cycle Gas	3"	0-7000 RPM	O/B ALT./COIL	67364P *
Trim: Honda	2"	UP-DOWN	BY ENG. MFR.	67855P
Trim: Mercury O/B & I/O, Mariner, Force, Cobra, Volvo DP & SX, Yamaha 2001 & Up	2"	UP-DOWN	BY ENG. MFR.	67023P *
Trim: Johnson/Evinrude (All) & Suzuki 4-stroke 2002 & Up	2"	UP-DOWN	BY ENG. MFR.	67365P *
O/B Water Pressure Kit	2"	0-40 PSI	INCLUDES "WP"	67382P *
MULTI-GAUGE DESCRIPTION	SIZE	DIAL RANGE	SENDER CODE	PART NUMBER
Speedo/Fuel	3"	0-50 MPH	REQUIRES "G"	69073FP *
		E-1/2-F	REQUIRES "F"	
Tach/Volt	3"	0-7000 RMP	O/B ALT./COIL	69074FP *
		8-18 VDC	NONE REQ'D	

* Display Packaged Item

* Not tested for complete aftermarket ignition systems, will work with aftermarket replacement parts.

** Adapter (P/N 61886P) is required for Yamaha.

Use 4000 RPM tachometer or lower for diesel applications.

AMEGA - Hottest selling black dial line! Amega® Domed has clean-looking black dials with white and red graphics plus through-dial and perimeter lighting for great readability. Amega has been very popular, available in several styles since its debut in 1986.



FEATURES:

- Black dial, red graduations, white numerals, vivid white pointer staff.
- Scratch resistant curved glass lenses, with black, near-flush bezels.
- U.S. and metric scales, with ISO symbols, where appropriate.
- Perimeter and thru-dial lighting.
- A comprehensive array of outboard water pressure instrument kits.
- Optional add-on eyebrow or square bezels available (See Gauge Accessories for details).

SELECTION GUIDE:

GAUGE DESCRIPTION	SIZE	DIAL RANGE	SENDER CODE	PART NUMBER
Fuel Gauge:	2"	E-1/2-F	REQUIRES "F"	57902P *
Hourmeter:	2"	10,000 Hrs.	NONE REQ'D	84760P *
Oil Pressure Gauges (Electric):				
Oil Pressure 80 PSI	2"	0-80 PSI	REQUIRES "C"	57903P *
Oil Pressure 100 PSI	2"	0-100 PSI	REQUIRES "C"	57929P *
GPS Speedometer:				
35 MPH	3"	0-35 MPH	GPS RECEIVER	781-579-035P
60 MPH	3"	0-60 MPH	GPS RECEIVER	781-579-080P
80 MPH	3"	0-80 MPH	GPS RECEIVER	781-579-080P *
Speedometer Kits:				
35 MPH (Pitot type)	3"	5-35 MPH	INCLUDES "G"	58342P *
35 MPH (Pitot type) Head Only	3"	5-35 MPH		58342PH
50 MPH (Pitot type)	3"	10-50 MPH	INCLUDES "G"	57898P *
50 MPH (Pitot type) Head Only	3"	10-50 MPH		57898PH
65 MPH (Pitot type)	3"	10-65 MPH	INCLUDES "G"	57900P *
65 MPH (Pitot type) Head Only	3"	10-65 MPH		57900PH
80 MPH (Pitot type)	3"	20-80 MPH	INCLUDES "G"	57899P *
80 MPH (Pitot type) Head Only	3"	20-80 MPH		57899PH
Systems Check – Evinrude/Johnson:	2"	SYSTEM DATA	BY ENG. MFR.	65205P *
Tachometer (Electric):				
O/B & 4-Stroke Gas Engines*	3"	0-7000 RPM	O/B ALT./COIL	58255P *
Systems Check – Evinrude/Johnson	3"	0-7000 RPM	O/B ALT./COIL	58935P *
Diesel Alt	3"	0-4000 RPM	ALTERNATOR	68358P *
Force	3"	0-7000 RPM		69044P *
Tachometer/Hourmeter (Electric):				
O/B & 4-Stroke Gas Engines*	3"	0-6000 RPM	O/B ALT./COIL	57897P *
Tach/Hourmeter	3"	0-7000		68443P *
Trim Gauges (Outboard, I/O):				
Johnson/Evinrude (All) & Suzuki	2"	UP-DOWN	BY ENG. MFR.	58431P *
4-stroke 2002 & Up	2"	UP-DOWN	BY ENG. MFR.	68359P *
Honda				
Mercury O/B & I/O, Mariner, Force,	2"	UP-DOWN	BY ENG. MFR.	57905P *
Cobra, Volvo DP & SX, Yamaha 2001 & Up	2"	UP-DOWN	BY ENG. MFR.	61748P *
Yamaha Outboards pre-2001	2"	UP-DOWN	BY ENG. MFR.	57901P *
Voltmeter-12 Volt:	2"	8-18 VDC	NONE REQ'D	57901P *
Water Pressure Kits (Outboard):**				
(Each kit includes fittings	2"	40 PSI	INCLUDES "WP"	68357P *
and 20 feet of tubing)	2"	30 PSI	INCLUDES "WP"	61238P *
Water Temp. Kit (Outboard):**				
(For all electric-start outboards)	2"	100-220°F	INCLUDES "J"	58862P *
Water Temp. Gauge (I/O, I/B):	2"	120-240°F	REQUIRES "D"	57904P *
Ammeter, Amega 60-0-60	2"	60-0-60	NONE REQ'D	68356P *
Battery Condition Indicator, 12 VDC			NONE REQ'D	68361P *
Instrument Set "OUTBOARD"	Contains: 58255P, 57900P, 57902P, 57901P			68362P *
Instrument Set "INBOARD/STERNDRIIVE"	Contains: 58255P, 57900P, 57902P, 57901P, 57904P, 57903P			68363P *
Twin Engine Add On IB/IO Gauge Kit	Contains: 58255P, 57901P, 57904P, 57903P			69722P *
Twin Engine Add On OB Gauge Kit:	Contains: 58255P, 57901P			69721P *
Instrument Set OB w/Tach/Hr	Contains: 68443P, 57900P, 57902P, 57901P			69708P *
Instrument Set IB/IO w/Tach/Hr	Contains: 68443P, 57900P, 57902P, 57901P, 57904P, 57903P			69709P *

* Display Packaged Item

* Not tested for complete aftermarket ignition systems, will work with aftermarket replacement parts.
 ** Adapter (P/N 61886P) is required for Yamaha.
 Use 4000 RPM tachometer or lower for diesel applications.

ARCTIC - Stylish white bezel design, black on white graphics, accurate and reliable, these tough instruments look good on all types of boats. Domed glass sheds water and resists scratching.



FEATURES:

- Instruments available for most outboards, stern drives and gasoline-powered inboards.
- Scratch-resistant domed glass lenses.
- Enhanced illumination: through-dial and perimenter lighting for excellent readability at night.
- Low-range speedometers.
- U.S. and metric scales, with ISO symbols, where appropriate.
- Optional add-on eyebrow or square bezels available (See Gauge Accessories for details).

SELECTION GUIDE:

GAUGE DESCRIPTION	SIZE	DIAL RANGE	SENDER CODE	PART NUMBER
Ammeter	2"	60-0-60	NONE REQ'D	68364P *
Fuel Gauge	2"	(E-F)	REQUIRES "F"	68365P *
Hourmeter	2"	10,000 hrs		68366P *
Eng Oil Pressure gauge 0-80 PSI	2"	0-80 PSI	REQUIRES "C"	68367P *
Water Pressure Kits (Outboard): (Each kit includes fittings and 20 feet of tubing).	2"	0-40 PSI	INCLUDES "WP"	68369P *
GPS Speedometer:				
35 MPH	3"	0-35 MPH	GPS RECEIVER	781-683-035P
60 MPH	3"	0-60 MPH	GPS RECEIVER	781-683-060P
80 MPH	3"	0-80 MPH	GPS RECEIVER	781-683-080P *
Speedo Kit 0-35 mph (inc Pitot and Hose)	3"	5-35 MPH	INCLUDES "G"	68370P *
Speedo Kit 0-65 mph (inc Pitot and Hose)	3"	10-65 MPH	INCLUDES "G"	68371P *
Speedo Kit 0-80 mph (inc Pitot and Hose)	3"	20-80 MPH	INCLUDES "G"	68372P *
Tachometer 0-4000 RPM Diesel Alt	3"	0-4000 RPM	ALTERNATOR	68373P *
Tachometer 0-7000 RPM	3"	0-7000 RPM	O/B ALT./COIL	68374P *
Tach/Hourmeter 0-7000 RPM Petrol/Gas	3"	0-7000 RPM	O/B ALT./COIL	68375P *
I/O, I/B Water Temp Gauge	2"	120-240°F	REQUIRES "D"	68376P *
Outboard Water Temp Kit (Cold-Hot)	2"	100-220°F	INCLUDES "J"	68377P *
Trim, Johnson/Evinrude (All) & Suzuki 4-stroke 2002 & Up	2"	UP-DOWN	BY ENG. MFR.	68378P *
Trim, Honda	2"	UP-DOWN	BY ENG. MFR.	68379P *
Trim, Mercury O/B & I/O, Mariner, Force, Cobra, Volvo DP & SX, Yamaha 2001 & Up	2"	UP-DOWN	BY ENG. MFR.	68380P *
Trim, Yamaha Outboards pre-2001	2"	UP-DOWN	BY ENG. MFR.	68381P *
12v Voltmeter, 8-18 Volts	2"	8-18 VDC	NONE REQ'D	68383P *
12 Battery Condition Indicator	2"		NONE REQ'D	68384P *
System Check - Evinrude/Johnson	2"		BY ENG. MFR.	68385P *
Instrument Set "OUTBOARD"	Contains: 68374P, 68371P, 68365P, 68383P			68387P *
Instrument Set "INBOARD/STERNDRIVE"	Contains: 68374P, 68371P, 68365P, 68383P, 68376P, 68367P			68388P *
Instrument Set OB w/Tach/Hr	Contains: 68375P, 68371P, 68365P, 68383P			69710P *
Instrument Set IB/IO w/Tach/Hr	Contains: 68375P, 68371P, 68365P, 68383P, 68376P, 68367P			69711P *
Twin Engine Add On IB/IO Gauge Kit	Contains: 68374P, 68383P, 68376P, 68367P			69724P *
Twin Engine Add On OB Gauge Kit	Contains: 68374P, 68383P			69723P *

* Display Packaged Item

* Not tested for complete aftermarket ignition systems, will work with aftermarket replacement parts.

** Adapter (P/N 61886P) is required for Yamaha.
Use 4000 RPM tachometer or lower for diesel applications.

ECLIPSE - Smart white and blue graphics on a black dial background, these very low profile bezels follow the curve of the lense to eliminate water trapping. Design with domed glass sheds water and resists scratching.



FEATURES:

- Instruments available for most outboards, stern drives and gasoline-powered inboards.
- Scratch-resistant domed glass lenses.
- Perimeter lighting for excellent readability at night.
- U.S. and metric scales, with ISO symbols, where appropriate.
- Optional add-on eyebrow or square bezels available (See Gauge Accessories for details).

SELECTION GUIDE:

GAUGE DESCRIPTION	SIZE	DIAL RANGE	SENDER CODE	PART NUMBER
Ammeter	2"	60-0-60	NONE REQ'D	68389P*
Fuel Gauge	2"	(E-F)	REQUIRES "F"	68390P*
Hourmeter	2"	10,000 hrs		68391P*
Eng Oil Pressure gauge 0-80 PSI	2"	0-80 PSI	REQUIRES "C"	68392P*
Eng Oil Pressure gauge 0-100 PSI	2"	0-100 PSI	REQUIRES "C"	68393P*
Water Pressure Kits (Outboard): (Each kit includes fittings and 20 feet of tubing).	2"	0-40 PSI	INCLUDES "WP"	68394P*
GPS Speedometer:				
35 MPH	3"	0-35 MPH	GPS RECEIVER	781-684-035P
60 MPH	3"	0-60 MPH	GPS RECEIVER	781-684-060P
80 MPH	3"	0-80 MPH	GPS RECEIVER	781-684-080P*
Speedo Kit 0-35 mph (inc Pitot and Hose)	3"	5-35 MPH	INCLUDES "G"	68395P*
Speedo Kit 0-65 mph (inc Pitot and Hose)	3"	10-65 MPH	INCLUDES "G"	68396P*
Speedo Kit 0-80 mph (inc Pitot and Hose)	3"	20-80 MPH	INCLUDES "G"	68397P*
Tachometer 0-4000 RPM Diesel Alt	3"	0-4000 RPM	ALTERNATOR	68398P*
Tachometer 0-7000 RPM	3"	0-7000 RPM	O/B ALT./COIL	68399P*
Tach/Hourmeter 0-7000 RPM Petrol/Gas	3"	0-7000 RPM	O/B ALT./COIL	68400P*
I/O, I/B Water Temp Gauge	2"	120-240°F	REQUIRES "D"	68401P*
Outboard Water Temp Kit (Cold-Hot) - includes "J"	2"	100-220°F	INCLUDES "J"	68402P*
Trim, Johnson/Evinrude (All) & Suzuki 4-stroke 2002 & Up	2"	UP-DOWN	BY ENG. MFR.	68403P*
Trim, Honda	2"	UP-DOWN	BY ENG. MFR.	68404P
Trim, Mercury O/B & I/O, Mariner, Force, Cobra, Volvo DP & SX, Yamaha 2001 & Up	2"	UP-DOWN	BY ENG. MFR.	68405P*
Trim, Yamaha Outboards pre-2001	2"	UP-DOWN	BY ENG. MFR.	68406P*
12v Voltmeter, 8-18 Volts	2"	8-18 VDC	NONE REQ'D.	68408P*
12v Battery Condition Indicator	2"		NONE REQ'D.	68409P*
System Check - Evinrude/Johnson	2"		BY ENG. MFR.	68410P*
Instrument Set "OUTBOARD"	Contains: 68399P, 68396P, 68390P, 68408P			68412P*
Instrument Set "INBOARD/STERNDRIVE"	Contains: 68399P, 68396P, 68390P, 68408P, 68401P, 68392P			68413P*
Twin Engine Add On IB/I/O Gauge Kit	Contains: 68399P, 68408P, 68401P, 68392P			69726P
Twin Engine Add On OB Gauge Kit	Contains: 68399P, 68408P			69725P
Instrument Set OB w/Tach/Hr	Contains: 68400P, 68396P, 68390P, 68408P			69712P*
Instrument Set IB/I/O w/Tach/Hr	Contains: 68400P, 68396P, 68390P, 68408P, 68401P, 68392P			69713P*

* Display Packaged Item

* Not tested for complete aftermarket ignition systems, will work with aftermarket replacement parts.

** Adapter (P/N 61886P) is required for Yamaha.

Use 4000 RPM tachometer or lower for diesel applications.

HEAVY DUTY - A classic line for inboards including diesels, Heavy Duty includes mechanical water temperature and oil pressure gauges, ammeters, engine sync gauges* and a range of diesel tachometers, including a programmable tach/hourmeter.

*Module required, not included with gauge.



FEATURES:

- Classic white graphics and pointer on deep black faces.
- Low-profile polished stainless steel bezels.
- Perimeter lighting and scratch resistant glass lenses.
- Tachometers for diesels available.
- Several temperature and mechanical oil pressure gauges available.
- Programmable tach/hourmeter offered.
- Ideal replacement for Stewart-Warner® "Deluxe" instruments.
- Optional add-on eyebrow or square bezels available (See Gauge Accessories for details).

SELECTION GUIDE:

GAUGE DESCRIPTION	SIZE	DIAL RANGE	SENDER CODE	PART NUMBER
Ammeters:				
Direct Reading 40 Amp Range	2"	40-0-40A	NONE REQ'D.	80712P
Direct Reading 60 Amp Range	2"	60-0-60A	NONE REQ'D.	80710P *
Engine Synchronizer Gauge:	2"	Port-Starboard	REQUIRES "L"	80730P *
Fuel Gauge:	2"	E-1/2-F	REQUIRES "F"	80150P *
Hourmeter:	2"	10,000 Hrs.	NONE REQ'D.	82760P *
Oil Pressure Gauges (Electric):				
Oil Pressure 80 PSI	2"	0-80 PSI	REQUIRES "C"	80180P *
Oil Pressure 100 PSI	2"	0-100 PSI	REQUIRES "C"	80181P *
Oil Temperature Gauge (Electric):				
Oil Temperature 320°F	2"	140-320°F	REQUIRES "E"	80596P *
Speedometer Kits:				
60 MPH (Pitot Type)	3"	10-60 MPH	INCLUDES "G"	80514P *
60 MPH (Pitot Type) Head Only	3"	10-60 MPH		80514PH *
Tachometers (Electric):				
Diesel Alternator**	3"	0-3500 RPM	SEE "T"	82302P *
Diesel Magnetic Pickup, 90-180 Teeth	3"	0-3500 RPM	REQUIRES "B"	82303P *
Diesel Signaflex ***	3"	0-3500 RPM	SIGNAFLEX	82301P *
O/B & 4-Stroke Gas Engines*	3"	0-6000 RPM	O/B ALT /COIL	82288P *
Water Temp. Gauges (Electric):				
Water Temp 240°F	2"	120-240°F	REQUIRES "D"	80590P *
Water Temp 280°F, Nylon	2"	100-280°F	REQUIRES "P"	80593P *
Voltmeters - 12 & 24 Volt:				
12 Volt System	2"	10-16 VDC	NONE REQ'D.	80134P *
24 Volt System	2"	20-32 VDC	NONE REQ'D.	80131P *

* Display Packaged Item

* Not tested for complete aftermarket ignition systems, will work with aftermarket replacement parts.

** May require alternator tap.

*** Signaflex senders and drive tips are for domestic diesel engines only (not for Lehman, Renault, Volvo, Yanmar, etc.)

Use 4000 RPM tachometer or lower for diesel applications.



SIERRA DEPTH GAUGE AND TRANSDUCER KIT

- Clamshell packaging for easy POP display
- Depth range to 600ft and on plane readings up to 60mph
- Includes two interchangeable faces (Black, White) and three bezels (Black, White, Chrome) designed to match most Sierra gauge series
- Automatic range and sensitivity adjustments for no-worry usage
- Polarized LCD display for easy viewing in any environment
- 30ft transducer cable length for small or large boat installations on package
- Installation and User Manual available on SierraMarine.com or using the QR code
- Dual-mount transducer can be transom mounted or internally glue mounted to hull
- Dual Depth alarms can be set to warn of depth changes
- 1 touch alarm muting instantly silences audible alarm
- User selected unit of measure (feet or meter)
- Keel offset designed to properly adjust depth readings
- LED backlit display for easy viewing at night
- High speed transducer resolution of 7X per second
- Covered by Sierra Limited Lifetime Warranty



26000P
Fits 2-1/8" hole

PREMIER STAINLESS SERIES 5" MULTI FUNCTION GAUGE KIT

- Anti-fog coated lens reduces fogging
- Domed glass lens resists scratching and total lens washout in sunlight
- Stainless steel Bezel,
- Silicon dampened pointers reduces pointed bounce in rough waters,
- Reverse polarity protection
- Optional eyebrow bezels available for stylish look,
- Perimeter lit dial and pointer, incandescent bulb lighting
- Includes pitot tube and water pressure installation kit

20000P
Fits: Mercury and Yamaha Engines:
Tachometer/Trim/Water (30PSI)
Speedometer (80MPH)
Fuel, Voltmeter

20010P
Fits: Evinrude and Suzuki Engines
Tachometer/Trim/Water (30PSI)
Speedometer (80MPH)
Fuel, Voltmeter



WHITE SERIES 5" MULTI FUNCTION GAUGE KIT

- Anti-fog coated lens reduces fogging
- Fully backlit dial with white numerals and gradients while backlit red for balanced lighting
- Fully backlit pointer, incandescent bulb lighting
- Domed glass lens resists scratching and total lens washout in sunlight
- Stainless steel Bezel
- Silicon dampened pointers reduces pointed bounce in rough waters
- Reverse polarity protection
- Optional eyebrow bezels available for stylish look
- Speedometer pitot tube and water pressure installation kit included

21000P
Fits: Mercury and Yamaha engines
Tachometer/Trim/Water (40PSI)
Speedometer (80MPH)
Fuel, Voltmeter

21010P
Fits: Evinrude and Suzuki Engines
Tachometer/Trim/Water (40PSI)
Speedometer (80MPH)
Fuel, Voltmeter



DEEP-VEE SERIES 5" MULTI FUNCTION GAUGE KIT

- Anti-fog coated lens reduces fogging
- GPS speedometer for accurate speed readings, no clogged or damaged pitots and tubing to worry about
- Fully backlit dial with gray numerals and gradients while backlit blue for balanced lighting
- Fully backlit pointer, 3D dial design provides larger dial viewing area without increasing gauge footprint
- Domed glass lens resists scratching and total lens washout in sunlight
- Stainless steel Bezel
- Silicon dampened pointers reduces pointed bounce in rough waters
- Reverse polarity protection
- Optional eyebrow bezels available for stylish look
- LED lighting
- Hourmeter included in tachometer
- GPS receiver included, Deutsch electrical connectors included

22000P
Fits: Mercury and Yamaha engines
Tachometer/Hourmeter/Fuel/Voltmeter
GPS Speedometer/Trim

22010P
Fits: Evinrude and Suzuki Engines
Tachometer/Hourmeter/Fuel/Voltmeter
GPS Speedometer/Trim

22020P
Fits: Honda Engines
Tachometer/Hourmeter/Fuel/Voltmeter
GPS Speedometer/Trim



MARINE OIL PRESSURE AND TEMPERATURE SENDER INTERCHANGE



Illustration A
Oil Pressure Switch



Illustration B
Oil Pressure Sender



Illustration C
Temperature Sender



Illustration D
Temperature Switch



Illustration E
Safety Shut-Off Switch

PART NO.	Stewart Warner Part No.	Faria Part No.	Medallion Part No.	Datcon Part No.	YDO Part No.	Crusader Part No.	Mercuriser Part No.	Volvo Part No.	BRP Part No.	VesThree Part No.	Range	N.P.T. Thread Size	Terminal Type
----------	-------------------------	----------------	--------------------	-----------------	--------------	-------------------	---------------------	----------------	--------------	-------------------	-------	--------------------	---------------

OIL PRESSURE SWITCHES (ILLUSTRATION A)

OP22900	364L-F										6 psi Trip	1/8-27	10-32 stud
OP22891	364K-F										15 psi Trip	1/8-27	10-32 stud
18-5894								3852215	0379948		9 psi Trip	1/8-27	Spade

OIL PRESSURE SENDERS (ILLUSTRATION B) - Code C

18-5899	279-A	90512	A-2547	02504-00	360 801	700425	815425T	3857532	982650	1A15001	80 psi	1/8-27	10-32 stud
OP24301	279B-F	90519	A-2547-1	02505-00	360 811		850362			1A15016	100 psi	1/8-27	10-32 stud
OP24891	82514	90511	A-2622	02504-01				872064		1A15003	80 psi DS	1/8-27	10-32 stud

TEMPERATURE SWITCHES (ILLUSTRATION D)

TS25101	83304				232011017088						200 Trip	3/8-18	1/4" blade
---------	-------	--	--	--	--------------	--	--	--	--	--	----------	--------	------------

TEMPERATURE SENDERS (ILLUSTRATION C) - Code D

18-5896	362CZ-D	90401	B-936							52320S010	240°	1/8-27	10-32 stud
TS26611	362AN-D	90402	B-936-1							52320S004	240°	1/4-18	10-32 stud
TS26621	362AJ-D	90403	B-936-2				97257A 1			52320S009	240°	3/8-18	10-32 stud
TS26631	362AH-D	90404	B-936-3			700427	97258A 1		171960	52320S003	240°	1/2-14	10-32 stud
TS26641		90406	B-936	02017	323094						240° DS	1/8-27	10-32 stud
TS26651	362BD-D		A-2618-2								240° DS	1/4-18	10-32 stud
18-5897	352BC-D		A-2618-3					872068		52320S018	240° DS	3/8-18	10-32 stud
18-5898	362BB-D		A-2618-4							52320S017	240° DS	1/2-14	10-32 stud
18-7513								3862500			239°	1/8-27	

OIL PRESSURE SAFETY SHUT-OFF SWITCH (ILLUSTRATION E)

*OP72533												1/4-18	1/4" spade
----------	--	--	--	--	--	--	--	--	--	--	--	--------	------------

* Retail Packaged Item

*Note: DS specifies Dual Station sender

*3-wire hookup to starter, pump and ignition. I/O and inboard units require a method to shut off the electronic fuel pump when the engine fails or is shut down. This switch senses low oil pressure and shuts the fuel pump off.

HOURMETERS



56966P
HOURMETER, ROUND
 (2")



56967P
HOURMETER, RECT.
 (Hole Size: 1.5" x 1")
 Outside dimensions: 2.1" x 1.2"



56968P
SMALL ENGINE HOURMETER (W/ 5' SENSOR WIRE)
Replaces: Yamaha ENG-METER-2C-01
 2 or 4 Stroke Gasoline
 * No power or ground required



56969P
SMALL ENGINE TACH/HOURMETER (W/ 5' SENSOR WIRE)
Fits: 2 or 4 stroke, 2 Cylinders or Less
 -No power or ground required



GAUGE ACCESSORIES

BEZELS

EYEBROW BEZELS - Our Eyebrow Bezels give any boat that sporty race boat look. Durable and corrosion proof, these chrome plated bezels attach directly to the gauge. The bezels can be rotated to any angle allowing you to customize the look of your dash.



FEATURES:

- Directly attach to the gauge
- No extra holes to drill
- Can be set at any angle
- Corrosion proof ABC/PVC construction
- Buy individually or in 4 or 6 gauge sets.



69380P
BEZEL KIT
 For: 4 Gauge Kit
Contains:
 69268P (x2) and 69269P (x2)



69381P
BEZEL KIT
 For: 6 Gauge Kit
Contains:
 69268P (x4) and 69269P (x2)



69269P
EYEBROW BEZEL (3")
 3 1/8" I.D.



69270P
EYEBROW BEZEL
 (5")



IA65476
ACCESSORY, AIRCRAFT BEZEL
 (2")



IA65477
ACCESSORY, AIRCRAFT BEZEL (3")
 3 1/8" I.D.

FUEL SENDERS (CODE F): 240-33 OHM RANGE



56948P
FUEL SENDER KIT (W/GAUGE)
4-24" Tank



90424P
FUEL SENDER
4-24" tank depth



64082
FUEL SENDER GASKET

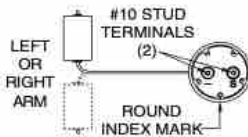
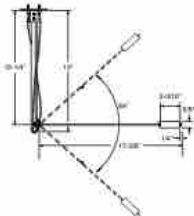

FLANGE MOUNTING DETAIL:

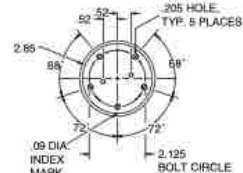

(Bend float arm as shown above for tanks less than 6" deep).

TACHOMETER ACCESSORIES (CODE B)



IH14767
TACH HARNESS
For: Evinrude/Johnson



IH15105
TACH HARNESS
For: Mariner/Merc O/B

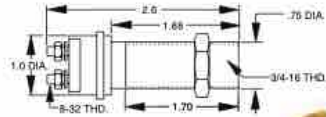

1507678P
MAGNETIC
PROXIMITY SENDER

SPEEDOMETER SENDERS AND ACCESSORIES (CODE G)



56973P
PITOT
For: 30-80 mph Speedometers



59677P
PACK O'PITOTS
(Package of 12)



67437P
PITOT HOSE KIT (W/ HARDWARE)
• 25' of hose
0.150" I.D. • 0.250" O.D.



56353P
PITOT TUBING
For: 30-80 mph, 100'
0.150" I.D. • 0.250" O.D.



67457P
PITOT TUBING
25'
0.150" I.D. • 0.250" O.D.

ENGINE SYNCHRONIZER MODULE (CODE L)

1508370P
ENG SYNCH MODULE
 4-Cycle Gas



CODE T

Diesel Alternator Tachometers alternator

NOTE: Alternator must have an AC tap, usually marked "AC", "R" or "W". If such a tap is not present, a local alternator repair shop can usually add one.

You will need to know the number of magnetic poles in your alternator.

Consult the alternator maker or local alternator repair shop if you do not know this.

Also, you will have to calculate the pulley ratio from crankshaft to alternator.

Tachometers are factory calibrated for several combinations of poles and pulley ratios, but in almost all cases you will need a Portable Master Shop Tachometer for initial calibration.

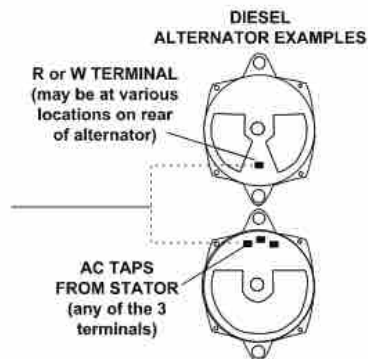

CODE WP

Water Pressure (0-15/0-30/0-40/0-60 PSI):
 (Included with water pressure gauge kits, which contain the instrument, 20 feet of pitot tubing and the parts shown at right.)

NOTE: For Yamaha, also order adapter **61886P**

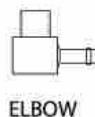
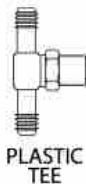

MISCELLANEOUS ACCESSORIES



61886P
YAMAHA ADAPTER FOR
WP KIT/TEMP SENDER
 I.D. 1/8" NPT



1502778
RUDDER ANGLE IND.
SENDER, SINGLE STATION



1827871P
BULB & SOCKET KIT



10860
BLANK GAUGE INSERT (2")



IA62995
LIGHT KIT, WEDGE
BASE
 12VDC



FS45430
FUSE HOLDER, PANEL
MOUNT



IA55009
Z BRACKET
 O/B Temp, Sender



sierra
Marine Engine and Drive Parts



POWER SYSTEMS

Sierra offers a range of electrical marine components such as battery accessories, tools and testers, terminals and connectors, switches, and circuit breakers.

Like all Sierra products, quality is insured by our industry leading Limited Lifetime Warranty.



THE VERY BEST PARTS OF BOATING

IGNITION SWITCHES FOR WORLD OUTBOARD MOTORS

- Exact OEM replacement installation
- Ideal for DFI, EFI and MPI engines
- Heavy duty potted construction
- Minimal bleed per circuit
- Molded umbrella type key



MP51090**
MP51092 – BULK 100 PCS/CTN
 IGNITION SWITCH
 3 Position Magneto – OFF- RUN-START
 PUSH to Choke
 Replaces: Mercury 87-17009A5



MP52000**
MP52002 – BULK 100 PCS/CTN
 IGNITION SWITCH
 3 Position Magneto – OFF- RUN-START
 PUSH to Choke
 Replaces: Mercury 87-88107A5



MP51010**
MP51012 – BULK 100 PCS/CTN
 IGNITION SWITCH
 Suzuki 2 & 4 stroke Outboards
 Replaces: 37110-99E00
 Colors on wires match factory color codes



MP51020**
MP51022 – BULK 100 PCS/CTN
 IGNITION SWITCH
 Yamaha Control Box 2 & 4 stroke
 Replaces: 703-82510-12-00
 Colors on wires match factory color codes



MP51030**
MP51032 – BULK 100 PCS/CTN
 IGNITION SWITCH
 Yamaha Dash Mount 2 & 4 stroke
 Dual Engine Application
 Replaces: 61B-82510-01-00,
 61B-82510-00-00
 Colors on wires match factory color codes



MP51040**
MP51042 – BULK 100 PCS/CTN
 IGNITION SWITCH
 Yamaha Control Box 2 & 4 stroke
 Push to Choke
 Replaces: 703-82510-43-00
 Colors on wires match factory color codes

MP51050**
MP51052 – BULK 100 PCS/CTN
 IGNITION SWITCH
 Yamaha Dash Mount 2 & 4 stroke
 Dual Engine Application, Push to Choke
 Replaces: 6K1-82510-06-00
 Colors on wires match factory color codes



** Display Packaged

Sierra offers the most complete selection of high quality polyester and brass ignition switches for the marine industry.

Marine grade glass-filled polyester switches

- Maximum corrosion protection – eliminates oxidation
- Inner seal between cylinder lock and contact plate
- Non-conductive housing eliminates potential shorts
- 20 Amp rating
- 2, 3 and 4 position switches
- Switches for magneto and conventional ignitions

Brass ignition switches

- Corrosion resistant construction
- Up to 15 Amp rating
- 2, 3 and 4 position switches
- Switches for magneto and conventional ignitions

** Display Packaged

4 POSITION CONVENTIONAL - ACCESSORY - OFF - RUN - START



MP39800**
MP39802 – BULK 100 PCS/CTN

DESCRIPTION	
Material	Polyester
Length	Long: 1 1/8" maximum panel thickness
Terminal Type	4 Blade
Back Up Nut	Brass
Face Nut	Hex black plastic face nut
Hole Size	7/8"
Rated:	
Ignition	15 Amp @ 12v DC
Solenoid	30 Amp @ 12v DC
Accessory	15 Amp @ 12v DC

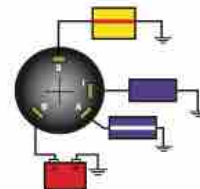

MP41040**
MP41042 – BULK 100 PCS/CTN

DESCRIPTION	
Material	Polyester
Length	Long: 1 1/8" maximum panel thickness
Terminal Type	4 Screw Tab
Type	
Back Up Nut	Brass
Face Nut	Knurled black plastic w/rubber cap
Hole Size	7/8"
Rated:	
Ignition	15 Amp @ 12v DC
Solenoid	30 Amp @ 12v DC
Accessory	15 Amp @ 12v DC

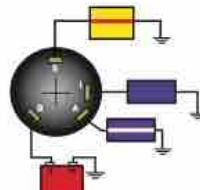

MP39070**
MP39072 – BULK 100 PCS/CTN

DESCRIPTION	
Material	Brass
Length	Long: 1" maximum panel thickness
Terminal Type	4 Screw Tab
Type	
Back Up Nut	Brass
Face Nut	Knurled black chrome w/rubber cap
Hole Size	7/8"
Rated:	
Ignition	15 Amp @ 12v DC
Solenoid	30 Amp @ 12v DC
Accessory	15 Amp @ 12 VDC

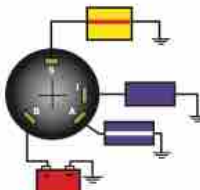

MP39700-1**
MP39702-1 – BULK 100 PCS

DESCRIPTION	
Material	Polyester
Length	Long: 1 1/8" maximum panel thickness
Terminal Type	4 Color Code Wires
Back Up Nut	Brass
Face Nut	Knurled black plastic w/rubber cap
Hole Size	7/8"
Rated:	
Ignition	15 Amp @ 12 VDV
Solenoid	30 Amp @ 12 VDC
Accessory	15 Amp @ 12 VDC

WIRE & DIAGRAM COLOR CODES

Red - Battery
Black - Magneto Ground
Yellow w/ Red Stripe - Solenoid
Black w/ Yellow Stripe - Magneto

Purple - Ignition
Yellow w/ Black Stripe - Choke

Purple w/ White Stripe - Accessory

4 POSITION CONVENTIONAL - ACCESSORY - OFF - RUN - START



MP41020**
MP41022 – BULK 100 PCS/CTN

DESCRIPTION	
Material	Brass
Length	Long: 1" maximum panel thickness
Terminal	4 Screw Tab
Type	
Back Up Nut	Brass
Face Nut	Hex Chrome Face Nut
Hole Size	7/8"
Rated:	
Ignition	15 Amp @ 12v DC
Solenoid	30 Amp @ 12v DC
Accessory	15 Amp @ 12 VDC

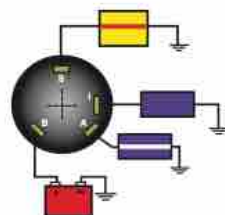

UN12140**
UN12142 – BULK 100 PCS/CTN

DESCRIPTION	
Material	Die Cast Zinc
Length	Short: 5/8" maximum panel thickness
Terminal	4-Threaded Stud
Type	
Back Up Nut	Die Cast Zinc
Face Nut	Knurled Chrome Face Nut
Hole Size	9/16"
Rated:	
Ignition	15 Amp @ 12v DC
Solenoid	30 Amp @ 12v DC
Accessory	15 Amp @ 12v DC

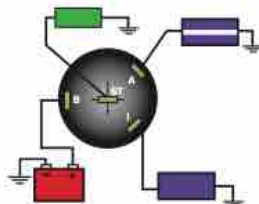

3 POSITION CONVENTIONAL - OFF - RUN - START



MP39060-1**
MP39062-1 – BULK 100 PCS/CTN

DESCRIPTION	
Material	Brass
Length	Long: 1 1/8" maximum panel thickness
Terminal	3 Screw Tab
Type	
Back Up Nut	Brass
Face Nut	Hex Chrome Face Nut
Hole Size	7/8"
Rated:	
Ignition	15 Amp @ 12v DC
Solenoid	30 Amp @ 12v DC

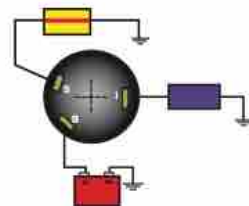

MP39080-1**
MP39082-1 – BULK 100 PCS/CTN

DESCRIPTION	
Material	Brass
Length	Long: 1 1/8" maximum panel thickness
Terminal	3 Screw Tab
Type	
Back Up Nut	Brass
Face Nut	Knurled black plastic w/rubber cap
Hole Size	7/8"
Rated:	
Ignition	15 Amp @ 12v DC
Solenoid	30 Amp @ 12v DC

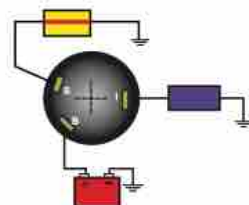

MP39120**
MP39122 – BULK 100 PCS/CTN

DESCRIPTION	
Material	Polyester
Length	Long: 1 1/8" maximum panel thickness
Terminal	3 Screw Tab
Type	
Back Up Nut	Brass
Face Nut	Hex black plastic face nut
Hole Size	7/8"
Rated:	
Ignition	15 Amp @ 12v DC
Solenoid	30 Amp @ 12v DC

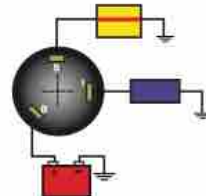

MP39780**
MP39782 – BULK 100 PCS/CTN

DESCRIPTION	
Material	Polyester
Length	Short: 5/8" maximum panel thickness
Terminal	3 Screw Tab
Type	
Back Up Nut	Brass
Face Nut	Hex black plastic face nut
Hole Size	7/8"
Rated:	
Ignition	15 Amp @ 12v DC
Solenoid	30 Amp @ 12v DC

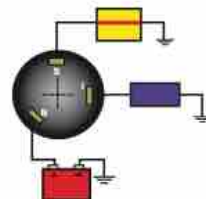

** Display Packaged

3 POSITION CONVENTIONAL - OFF - RUN - START



MP39200**
MP39202 – BULK 100 PCS/CTN

DESCRIPTION:	
Material	Polyester
Length	Long, 1 1/8" maximum panel thickness
Terminal Type	3 Screw Tab
Back Up Nut	Brass
Face Nut	Knurled black plastic w/rubber cap
Hole Size	7/8"
Rated:	
Ignition	15 Amp @ 12v DC
Solenoid	30 Amp @ 12v DC



MP39770**
MP39772 – BULK 100 PCS/CTN

DESCRIPTION:	
Material	Polyester
Length	Long, 1 1/8" maximum panel thickness
Terminal Type	3 Blade
Back Up Nut	Brass
Face Nut	Knurled black plastic w/rubber cap
Hole Size	7/8"
Rated:	
Ignition	15 Amp @ 12v DC
Solenoid	30 Amp @ 12v DC



MP41030**
MP41032 – BULK 100 PCS/CTN

DESCRIPTION:	
Material	Polyester
Length	Short, 5/8" maximum panel thickness
Terminal Type	3 Screw Tab
Back Up Nut	Brass
Face Nut	Knurled black plastic w/rubber cap
Hole Size	7/8"
Rated:	
Ignition	15 Amp @ 12v DC
Solenoid	30 Amp @ 12v DC

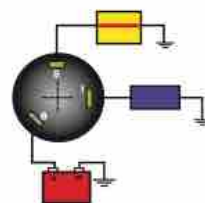
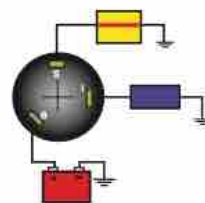
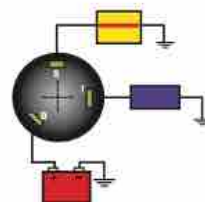

2 POSITION CONVENTIONAL - OFF - RUN USE WITH SEPARATE STARTER BUTTON



MP39010
MP39012 – BULK 100 PCS/CTN

DESCRIPTION:	
Material	Brass
Length	Short, 5/8" maximum panel thickness
Terminal Type	2 Screw Tab
Back Up Nut	Brass
Face Nut	Hex Chrome Face Nut
Hole Size	3/4"
Rated:	
Ignition	5 Amp @ 12 VDV



MP39020**
MP39022 – BULK 100 PCS/CTN

DESCRIPTION:	
Material	Brass
Length	Long, 1 1/8" maximum panel thickness
Terminal Type	2 Screw Terminal
Back Up Nut	Brass
Face Nut	Hex Chrome Face Nut
Hole Size	7/8"
Rated:	
Ignition	15 Amp @ 12v DC



MP39820-1 – INDIVIDUAL BOX
MP39822-1 – BULK 100 PCS/CTN

DESCRIPTION:	
Material	Brass
Length	Long, 1 1/8" maximum panel thickness
Terminal Type	2 Screw Terminal
Back Up Nut	Brass
Face Nut	Knurled Chrome Plated w/rubber cap
Hole Size	7/8"
Rated:	
Ignition	15 Amp @ 12v DC

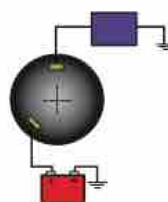
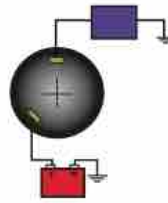
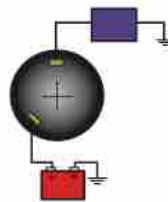

WIRE & DIAGRAM COLOR CODES

Red - Battery

Black - Magneto Ground

Yellow w/ Red Stripe - Solenoid

Black w/ Yellow Stripe - Magneto

Purple - Ignition

Yellow w/ Black Stripe - Choke

Purple w/ White Stripe - Accessory

** Display Packaged



MP39710-1**
MP39712-1 - BULK 100 PCS
PUSH TO CHOKE

DESCRIPTION	
Material	Polyester
Length	Short: 5/8" maximum panel thickness
Terminal Type	7 Color Code Wires
Back Up Nut	Brass
Face Nut	Knurled black plastic w/rubber cap
Hole Size	7/8"
Rated:	
Ignition	15 Amp @ 12 VDV
Solenoid	30 Amp @ 12 VDC
Accessory	15 Amp @ 12 VDC
Choke	7 Amp @ 12 VDC



MP39720-1**
MP39722-1 - BULK 100 PCS

For Outboard engines without choke circuit

DESCRIPTION	
Material	Polyester
Length	Short: 5/8" maximum panel thickness
Terminal Type	6 Color Code Wires
Back Up Nut	Brass
Face Nut	Knurled black plastic w/rubber cap
Hole Size	7/8"
Rated:	
Ignition	15 Amp @ 12 VDV
Solenoid	30 Amp @ 12 VDC
Accessory	15 Amp @ 12 VDC



MP41010**
MP41012 - BULK 100 PCS/CTN
PUSH TO CHOKE

DESCRIPTION	
Material	Polyester
Length	Short: 5/8" maximum panel thickness
Terminal Type	7 Screw Tab
Back Up Nut	Brass
Face Nut	Hex black plastic face nut
Hole Size	7/8"
Rated:	
Ignition	15 Amp @ 12v DC
Solenoid	30 Amp @ 12v DC
Choke	7 Amp @ 12v DC
Accessory	15 Amp @ 12v DC

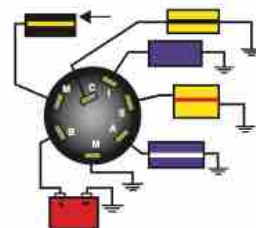

MP41080**
MP41082 - BULK 100 PCS/CTN
PUSH TO CHOKE

DESCRIPTION	
Material	Polyester
Length	Short: 5/8" maximum panel thickness
Terminal Type	6 Screw Tab, 1 Boss Screw
Back Up Nut	Plastic
Face Nut	Hex black plastic face nut
Hole Size	7/8"
Rated:	
Ignition	15 Amp @ 12v DC
Solenoid	30 Amp @ 12v DC
Choke	7 Amp @ 12v DC
Accessory	15 Amp @ 12v DC

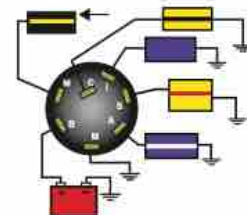

MP39730**
MP39732 - BULK 100 PCS

For Outboard engines without choke circuit

DESCRIPTION	
Material	Polyester
Length	Short: 5/8" maximum panel thickness
Terminal Type	6 Screw Tab
Back Up Nut	Brass
Face Nut	Hex black plastic face nut
Hole Size	7/8"
Rated:	
Ignition	15 Amp @ 12v DC
Solenoid	30 Amp @ 12v DC
Accessory	15 Amp @ 12v DC

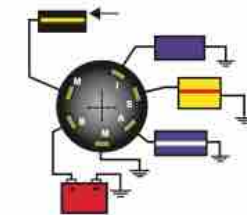

** Display Packaged

3 POSITION MAGNETO - OFF - RUN - START



MP39760**
MP39762 - BULK 100 PCS/CTN
PUSH TO CHOKE

DESCRIPTION	
Material	Polyester
Length	Short: 5/8" maximum panel thickness
Terminal Type	5 Screw Tab, 1 Boss Screw
Back Up Nut	Plastic
Face Nut	Hex black plastic face nut
Hole Size	7/8"
Rated:	
Ignition	15 Amp @ 12v DC
Solenoid	30 Amp @ 12v DC
Choke	7 Amp @ 12v DC

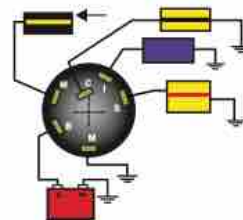

MP41000**
MP41002 - BULK 100 PCS/CTN
PUSH TO CHOKE

DESCRIPTION	
Material	Polyester
Length	Short: 5/8" maximum panel thickness
Terminal Type	6 Screw Tab
Back Up Nut	Brass
Face Nut	Hex black plastic face nut
Hole Size	7/8"
Rated:	
Ignition	15 Amp @ 12v DC
Solenoid	30 Amp @ 12v DC
Choke	7 Amp @ 12v DC

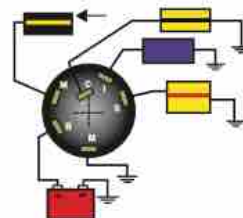

For Outboard engines without choke circuit



MP39740-1**
MP39742-1 - BULK 100 PCS

DESCRIPTION	
Material	Polyester
Length	Short: 5/8" maximum panel thickness
Terminal Type	5 Color Code Wires
Back Up Nut	Plastic
Face Nut	Knurled black plastic w/hubber cap
Hole Size	7/8"
Rated:	
Ignition	15 Amp @ 12 VDV
Solenoid	30 Amp @ 12 VDC
Accessory	15 Amp @ 12 VDC



MP41090-1**
MP41092-1 - BULK 100 PCS
PUSH TO CHOKE
 (Colors on switch wires match factory color codes.)

DESCRIPTION	
Material	Polyester
Length	Short: 5/8" maximum panel thickness
Terminal Type	6 Color Coded Wires
Back Up Nut	Brass
Face Nut	Knurled black plastic w/hubber cap
Hole Size	7/8"
Rated:	
Ignition	15 Amp @ 12v DC
Solenoid	30 Amp @ 12v DC
Choke	7 Amp @ 12v DC



MP41070-2**
MP41072-2 - BULK 100 PCS/CTN
PUSH TO CHOKE / MERCURY CONTROL BOX APPLICATIONS
 (Colors on switch wires match factory color codes.)

DESCRIPTION	
Material	Polyester
Length	Short: 5/8" maximum panel thickness
Terminal Type	6 Color Coded Wire Leads/Potted
Back Up Nut	Not Required
Face Nut	Hex black plastic face nut
Hole Size	7/8"
Rated:	
Ignition	15 Amp @ 12v DC
Solenoid	30 Amp @ 12v DC
Choke	7 Amp @ 12v DC

WIRE & DIAGRAM COLOR CODES

Red - Battery
 Black - Magneto Ground

Yellow w/ Red Stripe - Solenoid
 Black w/ Yellow Stripe - Magneto

Purple - Ignition
 Yellow w/ Black Stripe - Choke

Purple w/ White Stripe - Accessory

** Display Packaged

3 POSITION MAGNETO - OFF - RUN - START

MP52000**
MP52002 - BULK 100 PCS
PUSH TO CHOKE

DESCRIPTION	
Material	Polyester
Length	Short: 5/8" maximum panel thickness
Terminal Type	6 Color Coded Wire Leads/Potted
Back Up Nut	Plastic
Face Nut	Hex black plastic face nut
Hole Size	7/8"
Rated:	
Ignition	15 Amp @ 12v DC
Solenoid	30 Amp @ 12v DC
Choke	7 Amp @ 12v DC



MP51090**
MP51092 - BULK 100 PCS
PUSH TO CHOKE

DESCRIPTION	
Material	Polyester
Length	Short: 5/8" maximum panel thickness
Terminal Type	6 Color Coded Wire Leads/Potted
Back Up Nut	Not Required
Face Nut	Hex black plastic face nut
Hole Size	7/8"
Rated:	
Ignition	15 Amp @ 12v DC
Solenoid	30 Amp @ 12v DC
Choke	7 Amp @ 12v DC



MP39090**
MP39092 - BULK 100 PCS/CTN
PUSH TO CHOKE

DESCRIPTION	
Material	Polyester
Length	Long: 1 1/8" maximum panel thickness
Terminal Type	6 Screw Tab
Back Up Nut	Anodized steel
Face Nut	Hex plastic face nut w/snap on rubber cap
Hole Size	7/8"
Rated:	
Ignition	15 Amp @ 12v DC
Solenoid	30 Amp @ 12v DC
Choke	7 Amp @ 12v DC

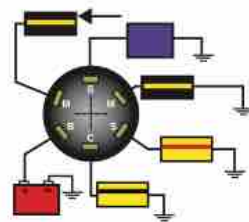

MP39040**
MP39042 - BULK 100 PCS/CTN

DESCRIPTION	
Material	Brass
Length	Long: 1 1/8" maximum panel thickness
Terminal Type	5 Screw Tab
Back Up Nut	Brass
Face Nut	Hex Chrome Face Nut
Hole Size	7/8"
Rated:	
Ignition	10 Amp @ 12v DC
Solenoid	30 Amp @ 12v DC

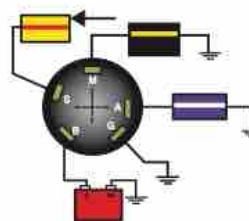

MP39100**
MP39102 - BULK 100 PCS/CTN

DESCRIPTION	
Material	Polyester
Length	Long: 1 1/8" maximum panel thickness
Terminal Type	5 Screw Tab
Back Up Nut	Brass
Face Nut	Hex black plastic face nut
Hole Size	7/8"
Rated:	
Ignition	15 Amp @ 12v DC
Solenoid	30 Amp @ 12v DC

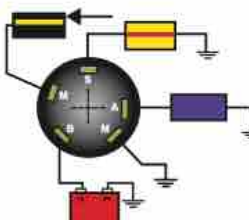

MP39830**
MP39832 - BULK 100 PCS/CTN

DESCRIPTION	
Material	Polyester
Length	Long: 1 1/8" maximum panel thickness
Terminal Type	6 Screw Tab
Back Up Nut	Brass
Face Nut	Hex black plastic face nut
Hole Size	7/8"
Rated:	
Ignition	15 Amp @ 12v DC
Solenoid	30 Amp @ 12v DC

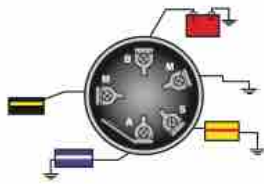

*Terminal to power separately controlled choke circuit

EMERGENCY ENGINE CUT-OFF SWITCHES

- Kills ignition when lanyard is pulled
- For use with conventional or magneto ignitions
- Unique design of MP40960 and MP40970 keeps plunger down when lanyard connected
- Seals out moisture
- Makes reconnection easier
- Panel thickness up to 1/4"



18-65450
EMERGENCY CUT-OFF SWITCH
Replaces: Yamaha 6E9-82575-02-00
Push button kill feature
Circuit closed with lanyard off.
Use **MP28860** replacement lanyard.



MP28870**
EMERGENCY CUT-OFF SWITCH
Replaces: OMC 585134
Circuit closed with lanyard off.
Use **MP28900** replacement lanyard.

MP28872-1
"Bulk" - 100 pieces per carton



MP40950**
EMERGENCY CUT-OFF SWITCH
4 terminals allow selection of normally open or normally closed circuit.
Use **MP40990** replacement lanyard.



MP40960**
EMERGENCY CUT-OFF SWITCH
4 terminals allow selection of normally open or normally closed circuit.
Use **MP40980** replacement lanyard.
MP40962
"Bulk" - 100 pieces per carton



MP40970-1**
EMERGENCY CUT-OFF SWITCH
4 terminals allow selection of normally open or normally closed circuit.
Use **MP40990** replacement lanyard.

MP40972-1
"Bulk" - 100 pieces per carton.

REPLACEMENT LANYARDS



18-1282
LANYARD
Replaces: OMC 398602
Tiller Steer Models - ALL



18-1294
DESS PROGRAMMABLE
SAFETY LANYARD
Replaces: Sea-Doo/BRP 278-002-199, 1
Fits: All BRP crafts equipped with DESS.
Programmable with STATS



MP28850**
LANYARD
Replaces: Honda, Mercury, Mariner, BRP,
Yamaha, Suzuki, OMC



MP28860**
LANYARD
Replaces: Yamaha 682-82556-00-00



MP28880**
LANYARD
Replaces: OMC 432230
1995-Older



MP28890**
LANYARD
Replaces: OMC 176288
1996 and Newer



MP28900**
LANYARD
Replaces: OMC 432230
1995-Older
MP28902-1 "Bulk" - 100 pieces per carton



MP40980**
LANYARD
MP40982
"Bulk" - 100 pieces per carton



MP40990**
LANYARD
MP40992
"Bulk" - 100 pieces per carton

FACE AND BOOT NUTS



MP39190**
WEATHER PROOF BOOT NUT
Fits: All Sierra polyester ignition switches,
1996 & later. 13/16"-16 Thread. Rotating
rubber seal. Seals out moisture and dust
from lock cylinder



MP39270**
FACENUT
For polyester ignition switches MP39100 thru
MP39120. Nut has extra long threads for positive
engagement on mounting bushing for early
(Pre-1995) style with 13/16"-20 thread ONLY!

** Display Packaged

ROTSWITCH® ROTARY SWITCHES

- Unique ergonomic design, styling and performance
- 20 AMP @ 12 Volts DC
- Durable cam design for long life
- UV stabilized thermoplastic housing
- Knob acts as umbrella - Silicone lip seal mates with stalk
- Separate light modules optional
- Replaces toggle or rocker switches with minimal panel alterations
- 1/2" hole size

** Display Packaged



RotoSwitch® provides illumination with different colors providing immediate visual information of switch position.

	BULK ① NUMBER	PART NUMBER	NUMBER OF BATTERY FEEDS	CIRCUITS "ON"			
				45° COUNTER CLOCKWISE	12 O'CLOCK	45° CLOCKWISE	90° CLOCKWISE
	MP78712 *MP59012	MP78710**	1	—	OFF	#1	—
	MP78722	MP78720	1	—	OFF	#1(M)	—
	*MP59032	MP78730**	1	#1	OFF	#2	—
	MP59042	MP78740	1	#1(M)	OFF	#2(M)	—
	MP78802 *MP59102	MP78800**	2	#1	OFF	#2	—
	MP78822 *MP59122	MP78820	1	#2	OFF	#1&2	—
	*MP59132	MP78830	1	—	OFF	#2	#1&2
	*MP59162	MP78860**	1	OFF	#1	#2	#1&2

①Bulk - 100 pieces per carton.

* Switch Only - No Knob

(M)=MOMENTARY

REPLACEMENT KNOBS

All include rubber umbrella seal. Original Ergotech design knob.



MP79740
MP79742 (BULK 100 PCS/CTN)
Black knob with black indicator.



MP79760**
MP79762 (BULK 100 PCS/CTN)
Black knob with light tube. Use with illumination module.



MP78372
Black knob with light tube for use with light module.

Mounting Accessories for RotoSwitch®.



MP78960
MP78962 (BULK 100 PCS/CTN)
Anti-rotation collar. Use when installing non-illuminated RotoSwitches in very thin dash panels. This adapter prevents the switch from "slipping" if excessive force is used to actuate the switch.

ILLUMINATION MODULES

Add flexibility and function to any installation of RotoSwitch® rotary switches. By using a variety of colored lenses, the status of each switch - "Off", "On-1", "On-2" - can instantly be determined.



MP78870**
MP78872 (BULK 100 PCS/CTN)



MP78910**
MP78912 (BULK 100 PCS/CTN)



MP78942 ①



MP78950
MP78952

C = Clear R = Red G = Green B = Black

** Display Packaged



- Fits in industry standard panel opening
- Patented mechanism that translates rotary to linear motion
- Secondary cam provides definitive detent positions
- Integrated illumination module up to 3 LED's for effortless installation
- IP67 sealing protection for above-panel components*

NEW

DIAGRAM	PART #	SWITCH FUNCTION
	RS20000 RED/GREEN	ON-ON
	RS20010	OFF - (ON)
	RS20020 RED	ON - OFF - ON
	RS20030	(ON) - OFF - (ON)
	RS20040	ON - ON - ON / 1 - 2 - 3
	RS20050 STARTER	OFF - ON - (ON) / OFF - 1 - 1&2
	RS20060 PROGRESSIVE	OFF - ON - ON2 / OFF - 1 - 1&2

	BULK ^① NUMBER	PART NUMBER	NUMBER OF BATTERY FEEDS	CIRCUITS "ON"		
				#1	#2	#3
	RS2004	RS20040	2	3, 6	3, 4	1, 4
	RS2002	RS20020	2	1, 4	OFF	3, 6
	RS2006	RS20060	2	OFF	3	3, 6
	RS2003	RS20030	2	(1, 4)	OFF	(3, 6)
	RS2001	RS20010	2	3, 6	-	OFF
	RS2000	RS20000	2	3, 6	-	1, 4
	RS2005	RS20050	2	OFF	3	(1, 3)

①Bulk - 100 pieces per carton.
(M)=MOMENTARY

* Switch Only - No Knob

COMPACT ROCKER SWITCHES

- Ideal for applications with panel size constraints
- Fits standard rectangular cutout
- High profile rocker action provides crisp, positive-type feel
- Rated to 12A @ 125VAC/ 10A @ 250VAC
- Suitable for low voltage 12/24 VDC
- Legends printed on switch
- Visi-rocker indicated if switch is 'ON'



NEW

PART NUMBER	SWITCH FUNCTION	PART NUMBER	SWITCH FUNCTION	PART NUMBER	SWITCH FUNCTION
RK40800	ON - OFF SPST	RK40830	OFF - (ON) SPDT	RK40860	ON - OFF - (ON) SPDT
RK40810	OFF - (ON) SPST	RK40840	OFF - ON SPDT	RK40870	(ON) - OFF - (ON) SPDT
RK40820	OFF - ON SPST	RK40850	ON - OFF - ON SPDT		

SWITCH PANELS

NEW

WEATHER RESISTANT SWITCH PANELS

- IP66 Rated
- Push to reset circuit breakers with weather boot
- LED illuminated rocker switches with 12V/24V Rating
- Watertight mounting gasket included
- Designed for Vertical or Horizontal installation



SP21000
SP21002 (BULK)
4P Contura Rocker
w/ Circuit Breaker
Replaces: Blue Sea 8372



SP21010
SP21012 (BULK)
6P Contura Rocker
w/ Circuit Breaker
Replaces: Blue Sea 8371



SP21020
SP21022 (BULK)
6 Function Touch 12V/24V
Backlit Panel



SP21030
SP21032 (BULK)
10 Function Touch
12V/24V Backlit Panel

Panel Dimensions: 91mm x 75mm
Control Box Dimensions: 136 x 90 x 32mm
Panel Cut-Out: 15mm hole

MEMBRANE TOUCH CONTROL PANELS

NEW

- CE Certified, Panel is IP67 rated
- LED- ON indication
- 10A Self-resettable fuse for each function
- Programmable buttons
- Faceplate PET membrane touch panel
- Circuit Protection: Built-in Resettable Fuse (PPTC)
- Switch Ratings: 10A per function at 12VDC
- Panel Rating: Max Cumulative Amp: 35A
- Voltage Rating: 11-30VDC

NEW



RS20180
(PACK OF 10)
TERMINAL, 17-20AWG WIRE
15A Current Rating Tin Crimp
Type Wire Terminal

RS20190
(PACK OF 10)
TERMINAL, 13.5-17AWG WIRE
15A Current Rating Tin Crimp
Type Wire Terminal



RS20200
HOUSING, TERMINAL
Direct Fit for Halo Rocker
Switches

HALO ROCKER SWITCHES



- Perimeter Illuminated for unique and stylish look Independent Illumination of rocker actuator
- IP68 sealed rocker switch
- Switch rated up to 20A at 12VDC
- Fit industry standard panel cutout
- Dedicated TE connector for use with .110 terminals



RK40660B

NEW

DIAGRAM	PART #	HALO COLOR	SWITCH FUNCTION
	RK40610B** RK40610G**	Blue Halo Green Halo	ON-OFF SPST
	RK40620B** RK40620G**	Blue Halo Green Halo	(ON-OFF) SPST
	RK40630B** RK40630G**	Blue Halo Green Halo	ON - ON SPST
	RK40640B** RK40640G**	Blue Halo Green Halo	ON - OFF - ON SPDT
	RK40650B** RK40650G**	Blue Halo Green Halo	ON - OFF DPST
	RK40660B** RK40660G**	Blue Halo Green Halo	ON - ON DPST
	RK40670B** RK40670G**	Blue Halo Green Halo	ON - OFF - ON DPDT
	RK40680B** RK40680G**	Blue Halo Green Halo	(ON) - OFF - (ON) DPDT
	RK40690B** RK40690G**	Dependent Blue Halo Dependent Green Halo	ON - OFF - ON SPDT
	RK40700B** RK40700G**	Dependent Blue Halo Dependent Green Halo	ON - OFF - ON DPDT

** Display Packaged

ILLUMINATED CONTURA® XIV ROCKER SWITCHES

- Sealed to IP66/68 for above-panel components
- Silver plated butt contact mechanism provides maximum reliability
- Greaseless construction designed for extreme temperatures
- Removable actuator for easy style change or replacement
- Panel seal prevents water ingress beneath panel to protect critical connections
- LED illuminated

NEW



RK19140
ACTUATOR
Square Lens



RK19150
ACTUATOR
Square and
Red Line Lens



RK19160
ACTUATOR
Two Square Lenses



RK19170
ACTUATOR
Two Line Lenses

Diagram	Part Number	Switch Function
	RK19000**	ON - OFF SPST
	RK19010**	(ON) - OFF SPST
	RK19020**	ON - OFF SPST
	RK19030**	ON - ON SPST
	RK19040**	ON - OFF - ON SPDT
	RK19050**	ON - OFF - ON SPDT
	RK19060**	(ON) - OFF - (ON) SPDT
	RK19070**	ON - OFF DPST
	RK19080**	(ON) - OFF DPST
	RK19090**	ON - OFF - ON DPDT
	RK19100**	ON - OFF - (ON) DPDT
	RK19110**	(ON) - OFF - (ON) DPDT
	RK19120**	OFF - ON - (ON) SPDT
	RK19130**	OFF - ON - ON SPDT

** Display Packaged

STANDARD WEATHER RESISTANT CONTURA® V ROCKER SWITCHES

- Non-corrosive plastic construction
- Protects against dust and prolonged spray to IP66 and IP68 standards
- Meets UL 1500, ISO 8846 ignition protection requirements
- Supplied with neoprene mounting gasket
- Removable actuators
- Brass blade terminals, silver contacts - Rated: 20 amps @ 12 VDC

Diagram	Part Number	Switch Function
	RK19210**	ON-OFF SPST
	RK19220**	ON-OFF-ON SPDT
	RK19230**	MOM ON-OFF SPST
	RK19240**	MOM ON-OFF-MOM ON DPDT

** Display Packaged



RK22180
ACTUATOR
BLACK CONTURA V
(2EA)

ILLUMINATED WEATHER RESISTANT CONTURA® V ROCKER SWITCHES

- Non-corrosive plastic construction
- Protects against dust and prolonged spray to IP66 and IP68 standards
- Meets UL 1500, ISO 8846 ignition protection requirements
- Supplied with neoprene mounting gasket
- Illuminates red in "ON" position
- Removable actuators
- Brass blade terminals, silver contacts - Rated: 20 amps @ 12 VDC



DIAGRAM	PART NUMBER	SWITCH FUNCTION
	RK19310**	ON-OFF SPST
	RK19320**	ON-OFF-ON SPDT



RK22190**
ACTUATOR
BLACK CONTURA V
WITH LENS (2EA)



RK22200**
ACTUATOR
BLACK CONTURA V
WITH 2 LENS (2EA)



RK22290**
ACTUATOR
REMOVAL TOOL

** Display Packaged

STANDARD WEATHER RESISTANT CONTURA® III ROCKER SWITCHES



- Non-corrosive plastic construction
- Protects against dust and prolonged spray to IP66 and IP68 standards
- Meets UL 1500, ISO 8846 ignition protection requirements
- Supplied with neoprene mounting gasket
- Removable actuators
- Brass blade terminals, silver contacts - Rated: 20 amps @ 12 VDC

DIAGRAM	ONE PADDLE PART #	TWO PADDLES (GREY & BLACK) PART #	SWITCH FUNCTION
	BLACK RK19680**	RK19680TP**	ON-OFF SPST
	BLACK RK19690**	RK19690TP**	ON-OFF-ON SPDT
	BLACK RK19720**	RK19710TP**	MOM ON-OFF SPST
	BLACK RK19760**	RK19750TP**	MOM ON-OFF-MOM ON SPDT
	BLACK RK19850**	RK19850TP**	MOM ON-OFF-MOM ON DPDT
	BLACK RK19880**	RK19870TP**	MOM ON-OFF DPST



**RK22100
ACTUATOR
BLACK CONTURA III
(2EA)



**RK22110
ACTUATOR
GRAY CONTURA III
(2EA)

** Display Packaged

ILLUMINATED WEATHER RESISTANT CONTURA® III ROCKER SWITCHES



- Non-corrosive plastic construction
- Protects against dust and prolonged spray to IP66 and IP68 standards
- Meets UL 1500, ISO 8846 ignition protection requirements
- Supplied with neoprene mounting gasket
- Illuminates red in "ON" position - 12V LED bulb
- Removable actuators
- Brass blade terminals, silver contacts - Rated: 20 amps @ 12 VDC

DIAGRAM	ONE PADDLE PART #	TWO PADDLES (GREY & BLACK) PART #	SWITCH FUNCTION
	BLACK RK19700**	RK19700TP**	OFF-ON SPST
	BLACK RK19780**	RK19770TP**	MOM ON-OFF-ON SPDT
	BLACK RK19820	RK19810TP**	MOM ON-OFF-ON DPDT
	BLACK RK19910**	RK19890TP**	OFF-ON DPST
	BLACK RK19740**	RK19730TP**	ON-OFF-ON SPDT
	BLACK RK19840**	RK19830TP**	ON-OFF-ON DPDT



RK22120**
ACTUATOR
BLACK CONTURA III
WITH LENS (2EA)



RK22130**
ACTUATOR
GRAY CONTURA III
WITH LENS (2EA)



RK22140**
ACTUATOR
BLACK CONTURA III
WITH 2 LENSES (2EA)



RK22150**
ACTUATOR
GRAY CONTURA III
WITH 2 LENSES (2EA)

** Display Packaged

STANDARD WEATHER RESISTANT CONTURA® II ROCKER SWITCHES



- Protects against dust and prolonged spray to IP66 and IP68 standards
- Supplied with neoprene mounting gasket
- Removable actuators
- Brass blade terminals, silver contacts - Rated: 20 amps @ 12 VDC

DIAGRAM	PART NUMBER	SWITCH FUNCTION
	RK19400-1**	OFF-ON SPST
	RK19410-1**	OFF-MOM ON SPST
	RK19410-RED**	OFF-MOM ON SPST Red actuator - for horn
	RK19420-1**	ON-OFF-ON SPDT

DIAGRAM	PART NUMBER	SWITCH FUNCTION
	RK19920-1**	MOM ON-OFF-ON SPDT
	RK19930-1**	MOM ON-OFF-ON DPDT
	RK19430-1**	MOM ON-OFF-MOM ON SPDT
	RK19940-1**	OFF-MOM ON DPST
	RK19480-1**	MOM ON-OFF-MOM ON DPDT
	RK19450-1**	ON-OFF-ON DPDT



RK22160**
ACTUATOR
BLACK CONTURA II
(2EA)



RK22170**
ACTUATOR
RED CONTURA II
(2EA)

ILLUMINATED WEATHER RESISTANT CONTURA® II ROCKER SWITCHES



- Non-corrosive plastic construction
- Removable actuators
- Brass blade terminals, silver contacts
- Rated: 20 amps @ 12 VDC

DIAGRAM	PART NUMBER	SWITCH FUNCTION
	RK19440-1**	OFF-ON SPST
	RK19450-1**	MOM ON - OFF SPST
	RK19460-1**	ON-OFF-ON SPDT
	RK19540-1**	ON-OFF-ON DPDT
	RK19550-1**	MOM ON-OFF-MOM ON DPDT

** Display Packaged

STANDARD ROCKER SWITCHES - WITH BLACK ACTUATORS



- Non-corrosive plastic construction
- Black actuators w/ black face plate
- Silver contacts
- Brass blade terminals
- Rated: 20 amps @ 12 VDC

DIAGRAM	BULK #	PART NUMBER	SWITCH FUNCTION
	RK40142	RK40140**	ON-OFF SPST
	RK40152	RK40150**	MOM ON - OFF SPST
	RK40172	RK40170**	ON-OFF-ON SPDT
	RK40352	RK40350**	MOM ON-OFF-MOM ON SPDT
	RK40472	RK40470**	MOM ON-OFF-MOM ON DPDT
	RK40482	RK40480**	ON-OFF-ON DPDT
	RK40362	RK40360**	ON-OFF-MOM ON SPDT
	RK19572	RK19570	ON(1)-OFF-ON(1&2) DPDT



ILLUMINATED ROCKER SWITCHES

- Dependent pilot light - illuminates in "on" position
- Non-corrosive plastic construction
- Silver contacts
- Brass blade terminals
- Rated: 20 amps @ 12 VDC



DIAGRAM	BULK #	PART NUMBER	SWITCH FUNCTION
	RK40102	RK40100**	ON-OFF SPST
	RK40112	RK40110**	ON-OFF-ON SPDT
	RK40122	RK40120**	MOM ON - OFF SPST
	RK40132	RK40130**	MOM ON-OFF-MOM ON SPDT

** Display Packaged

ILLUMINATED ROCKER SWITCHES - SOFT SPOT LIGHT



- Independent pilot light - illuminates when panel lights ON
- Illuminates white when panel lights are ON, changes to red when switch is ON
- Soft spotlight helps preserve night vision • Non-corrosive plastic construction
- Silver contacts • Brass blade terminals • Rated: 20 amps @ 12 VDC

DIAGRAM	BULK #	PART NUMBER	SWITCH FUNCTION
	RK40372	RK40370**	ON-OFF SPST
	RK40382	RK40380**	MOM ON - OFF SPST
	RK40392	RK40390**	ON-OFF-ON SPDT
	RK40402	RK40400**	MOM ON-OFF-MOM ON SPDT



WEATHER RESISTANT ILLUMINATED ROCKER SWITCHES



- Certified to IP 66 and IP 68 - protected against dust, prolonged spray and submersion
- Supplied with neoprene mounting gasket
- Removable actuators
- Brass blade terminals, silver contacts
- Snap in lens of choice (Amber, Clear, Green, Red)
- Rated: 20 amps @ 12 VDC

DIAGRAM	PART NUMBER	SWITCH FUNCTION	KIT DETAILS
	RK19500K	OFF-ON SPST	Dependent pilot light - illuminates in "on" position Includes 1 lens of each color
	RK19510K	OFF-ON SPST	Independent pilot light - illuminates when panel light is turned "on" Includes 1 lens of each color
	RK19520K	ON-OFF-ON SPDT	Dependent pilot lights - each light illuminates in "on" position Includes 2 lenses of each color
	RK19530K	OFF-ON SPST	One dependent pilot light - illuminates in "on" position. One independent pilot light - illuminates when panel lights "on" Includes 2 lenses of each color

** Display Packaged

ROCKER SWITCH MOUNTING BRACKETS FOR INSTALLING TWO OR MORE ROCKER SWITCHES

- Fits Sierra Standard and Contura® Rocker Switches
- Sections snap together without tools
- Mounting hole for 2 end unit set - 2.02" (51.31 mm) wide x 1.90" (48.26 mm) high add 1.03" (26.16 mm) for additional sections



UN19700
BLANK COVER



UN19710**
1 CENTER SECTION



UN19720
TWO END SECTIONS



UN19730**
2 CENTER SECTIONS



UN19740**
1 END SECTION



UN19750**
2 - **UN19740 END SECTIONS
KIT CONTAINS: 1 - **UN19710 - CENTER SECTION
1 - **UN19700 - BLANK COVER

INTERIOR & RV STYLE SWITCHES

NARROW BODY ROCKER SWITCHES ON - OFF SPST



- RK21880**** Non Illuminated
- For use in RK22070 panel
 - Fits 7/16" X 1 1/4" cut out
 - Blade Terminals
 - 20 Amp @ 12 VDC

NARROW BODY ROCKER SWITCH ON - OFF SPST



- RK19640****
RK19642 (Bulk - 100pcs./carton)
- Fits .550" X 1.125" cut out
 - Blade Terminals
 - 10 Amp @ 12 VDC

NARROW BODY ROCKER SWITCH ON - OFF SPST



- RK19630****
RK19632 (Bulk - 100pcs./carton)
- Fits .550" x 1.125" cut out
 - Blade Terminals
 - 10 Amp @ 12 VDC
 - Glows red in ON position

SURFACE MOUNT ILLUMINATED ROCKER SWITCHES OFF-ON SPST



- RK21420**** Red
RK21430 Green
- Illuminates in ON position
 - Mount in 1/2" round holes
 - Brass blade terminals
 - 16 Amp @ 12 VDC

STANDARD TOGGLE SWITCHES



- Non-corrosive plastic construction
- Brass blade terminals, silver contacts
- 15/32" L x 15/32"-32 mounting stem
- Rated: 20 amps @ 12 VDC or 25 amp @ 12 VDC
-
- **Rated 25 amp @ 12 VDC**

DIAGRAM	BULK #	PART NUMBER	SWITCH FUNCTION
	TG4002252*	TG40020-1***	ON-OFF SPST
	TG4003252*	TG40030-1***	MOM ON-OFF SPST
	TG4004252*	TG40040-1***	ON-OFF-ON SPDT
	TG4005252*	TG40050-1***	MOM ON-OFF-MOM ON SPDT
	TG4016252*	TG40160-1***	ON-OFF-MOM ON SPDT
	TG4045252*	TG40450-1***	ON-OFF-ON DPDT
	TG4046252*	TG40460-1***	MOM ON-OFF-MOM ON DPDT
	TG40492	TG40490**	ON(1)-OFF-ON(1&2) DPDT

ILLUMINATED TOGGLE SWITCHES



- Non-corrosive plastic construction
- Illuminates white when panel lights are ON, changes to red when switch is ON
- Brass blade terminals, silver contacts
- 15/32" L x 15/32"-32 mounting stem
- Rated: 20 amps @ 12 VDC
-

DIAGRAM	BULK #	PART NUMBER	SWITCH FUNCTION
	TG40062	TG40060**	ON-OFF SPST
	TG40072	TG40070**	ON-OFF-ON SPDT
	TG40082	TG40080	MOM ON-OFF SPST
	TG40092	TG40090	MOM ON-OFF-MOM ON SPDT

TIP LIT TOGGLE SWITCHES



- Lights through tip of handle
- Non-corrosive plastic construction
- Illuminates white when panel lights are ON, changes to red when switch is ON
- Brass blade terminals, silver contacts
- 15/32" L x 15/32"-32 mounting stem
- Rated: 20 amps @ 12 VDC
-

** Display Packaged

DIAGRAM	BULK #	PART NUMBER	SWITCH FUNCTION
	TG40302	TG40300**	ON-OFF SPST
	TG40312	TG40310**	MOM ON-OFF SPST
	TG40322	TG40320**	ON-OFF-ON SPDT
	TG40332	TG40330**	MOM ON-OFF-MOM ON SPDT
	TG40342	TG40340	ON-OFF-MOM ON SPDT
	TG19522	TG19520**	ON-OFF-ON DPDT
	TG19532	TG19530**	MOM ON-OFF-MOM ON DPDT

WEATHER RESISTANT TOGGLE SWITCH ON-OFF-ON SPDT



- Illuminates red in "on 1" position
- Illuminated white in "off" or "on 2" position
- O-ring seal in bushing seals out moisture and dirt
- Can be wired for independent or dependent illumination
- Rated: 20 amps @ 12 VDC

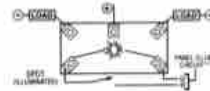

TG40010
TG40012 (Bulk - 100pcs/carton)

SATIN CHROME TIP TOGGLE SWITCHES



- Satin Chrome Handle with matching retaining ring
- Lights through tip of handle
- Non-corrosive plastic construction
- Illuminates white when panel lights are ON, changes to red when switch is ON
- Brass blade terminals, silver contacts
- 15/32" L X 13/32"-32 mounting stem
- Rated: 20 Amp @ 12 VDC

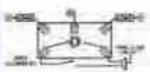

TG23010**
TG23012 (Bulk 100pcs/carton)
TOGGLE SWITCH
ON-OFF-ON SPDT

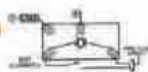

TG23030**
TG23032 (Bulk 100pcs/carton)
TOGGLE SWITCH
(ON)-OFF SPST



TG23050**
TG23052 (Bulk 100pcs/carton)
TOGGLE SWITCH
(ON)-OFF (ON) DPDT

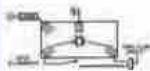

TG23000**
TG23002 (Bulk 100pcs/carton)
TOGGLE SWITCH
ON-OFF SPST



TG23020**
TG23022 (Bulk 100pcs/carton)
TOGGLE SWITCH
ON-OFF-ON DPDT



TG23040**
TG23042 (Bulk 100pcs/carton)
TOGGLE SWITCH
(ON)-OFF-(ON) SPDT

HEAVY DUTY 25 AMP TOGGLE SWITCHES



- Nickel Plated Brass Mounting Stem and Hardware
- Handle 11/16" (17.46mm) long
- Mounting Stem 15/32"-32 thread, 15/32" (11.81mm) long
- Fits panels up to 1/4" (6.35 mm) thick
- Rated : 25 Amp @ 12 VDC



TG22000**
TG22002 (Bulk 100pcs/carton)
ON-OFF SPST



TG22010**
TG22012 (Bulk 100pcs/carton)
ON-OFF-ON SPDT



TG22020**
TG22022 (Bulk 100pcs/carton)
ON-OFF-ON DPDT



TG22030**
TG22032 (Bulk 100pcs/carton)
MOM ON-OFF SPST



TG22040**
TG22042 (Bulk 100pcs/carton)
MOM ON-OFF-MOM
ON SPDT

** Display Packaged

HEAVY DUTY 50 AMP TOGGLE SWITCHES



- Super tough zinc die cast
- Heavy copper screw terminals
- Chrome plated plastic handle w/ metal core
- 15/32" L x 15/32"-32 mounting stem
- Rated: 50 Amp @ 12 VDC

TG21500**
TG21502 (Bulk - 100pcs./carton)
ON-OFF SPST

TG21590
TG21592 (Bulk - 100pcs./carton)
ON-OFF-ON SPST

TG21600**
TG21602 (Bulk - 100pcs./carton)
MOM ON-OFF-MOM ON SPDT

WEATHER RESISTANT TOGGLE SWITCHES



- Plasticized coating seals out moisture and dirt
- Nickel plated brass handle, mounting stem and hardware
- 10" L 16 gauge wire leads
- Handle 11/16" (17.46 mm) long
- Mounting stem 15/32"-32, 13/32" (10.31mm) long
- Fits panel up to 3/16" (4.76 mm) thick
- Includes MP39030 weather proof boot nut
- Rated: 15 amps @ 12 VDC

TG19560-1
TG19562-1 (Bulk - 100pcs./carton)
OFF-ON SPST

TG19540-1
TG19542-1 (Bulk - 100pcs./carton)
OFF-MOM ON SPST



TG40000**
TG40002 (Bulk - 100pcs./carton)
ON-OFF SPST

- Heavy duty all brass construction
- Chrome plated brass handle
- 3/8" L x 7/16"-28 mounting stem
- 2 screw terminals
- Rated: 20 Amps @ 12 VDC



TG21050-1**
TG21052-1 (Bulk - 100pcs./carton)
ON-OFF SPST

- Heavy duty toggle switch
- Chrome plated brass handle
- 15/32" L x 15/32"-32 mounting stem
- Two 6' wire leads
- Rated: 35 Amps @ 12 VDC
- Rated: 6 Amps @ 125 VAC



TG21040**
TG21042 (Bulk - 100pcs./carton)
ON-OFF SPST

- Heavy duty toggle switch
- Chrome plated brass handle
- 3/8" L x 15/32"-32 mounting stem
- 2 screw terminals
- Rated: 35 Amps @ 12 VDC
- Rated: 20 Amps @ 125 VAC



TG21020-2
*TG21022-2 (Bulk - 100pcs./carton)
ON-OFF SPST

- Heavy duty die cast toggle switch
- Chrome plated brass handle
- 15/32" L x 15/32"-32 mounting stem
- Sealed bushing
- 2 screw terminals
- Rated: 35 Amps @ 12 VDC
- Rated: 20 Amps @ 125 VAC



TG21070**
TG21072 (Bulk - 100pcs./carton)
ON-OFF SPST

- Heavy duty toggle switch
- Chrome plated brass handle
- 15/32" L x 15/32"-32 mounting stem
- 2 screw terminals
- Rated: 35 Amps @ 12 VDC
- Rated: 20 Amps @ 125 VAC



TG21080
TG21082 (Bulk - 100pcs./carton)
ON-OFF-ON SPDT

- Heavy duty toggle switch
- Chrome plated brass handle
- 3/8" L x 15/32"-32 mounting stem
- 3 screw terminals
- Rated: 35 Amps @ 12 VDC
- Rated: 20 Amps @ 125 VAC

** Display Packaged

DUCKBILL TOGGLE SWITCHES



- Non-corrosive plastic construction
- Brass blade terminals
- 1/2" mounting hole
- Supplied with bezel nut and spacer ring
- Rated: 15 Amps @ 12 VDC

TG21360**

TG21362 (Bulk 100pcs/carton)
ON-OFF SPST
Glowes Red in ON position

1" translucent plastic handle

TG21390

TG21392 (Bulk 100pcs/carton)
ON-OFF SPST
Glowes Green in ON position



TG21130**

TG21132 (Bulk 100pcs/carton)
ON-OFF SPST

1" black plastic handle

TG21140

TG21142 (Bulk 100pcs/carton)
ON-OFF-ON SPDT



MP39220**

MP39222 (Bulk 100pcs/carton)

WEATHER PROOF BOOT NUT

- For illuminated toggle switches (except Duckbill)
- 1/2" boot seals out moisture yet allows illumination to show



MP39030**

MP39032 (Bulk 100pcs/carton)

WEATHER PROOF BOOT NUT (GRAY)

- For standard toggles w/ 15/32" mounting stem
- Completely covers toggle handle
- Seals out moisture & dirt
- Nickel plated brass nut



MP39240-1**

MP39242 (Bulk 100pcs/carton)

WEATHER PROOF BOOT NUT (BLACK)

- For standard toggles w/ 15/32" mounting stem
- Completely covers toggle handle
- Seals out moisture & dirt



MP39280**

MP39282 (Bulk 100pcs/carton)

WEATHER PROOF BOOT NUT (BLACK)

- For standard toggles w/ 15/32" mounting stem
- Completely covers toggle handle
- Seals out moisture & dirt
- 2 piece construction chrome ring retains switch

WEATHER-RESISTANT PUSH SWITCHES



MP39380**
MP39382 (Bulk 100pcs./carton)
 OFF-ON SPST

- Solid brass construction
- Gasket sealed case
- 3/8" mounting bushing
- 2 screw terminals
- 3/4" chrome plated brass knob
- For panels up to 1" thick
- Rated: 15 amp @ 12 VDC



MP39390**
MP39392 (Bulk 100pcs./carton)
 OFF-ON SPST
 with chrome plated plastic knob

MP39390B**
MP39392B (Bulk 100pcs./carton)
 OFF-ON SPST
 with chrome plated brass knob

- Solid brass construction
- Vinyl coated body to resist moisture
- Two 18 gauge x 12" wire leads
- 3/8" mounting bushing
- For panels up to 1" thick
- Rated: 15 amp @ 12 VDC

HEAVY DUTY MARINE PUSH PULL SWITCHES



MP39600
MP39602 (Bulk 100pcs./carton)
 OFF-ON (1 & 2) SPST

- Pull for ON - turns on two separate circuits
- Solid brass construction
- 3/8" mounting bushing
- 3 screw terminals
- For panels up to 1" thick
- Chrome plated solid brass knob
- Rated: 15 amp @ 12 VDC



MP39580**
MP39582 (Bulk 100pcs./carton)
 OFF-ON(1)-ON(1&2) SPDT

- First pull energizes #1
- Second pull energizes both circuits
- Solid brass construction
- 3/8" mounting bushing
- 3 screw terminals
- For panels up to 1" thick
- Chrome plated solid brass knob
- Rated: 15 amp @ 12 VDC



MP39590**
MP39592 (Bulk 100pcs./carton)
 OFF-ON(1)-ON(1&2) SPDT

- First pull energizes #1
- Second pull energizes both circuits
- Solid brass construction
- 3/8" mounting bushing
- 3 blade terminals
- For panels up to 1" thick
- Chrome finish plastic knob
- Rated: 15 amp @ 12 VDC



MP39620
MP39622 (Bulk 100pcs./carton)
 OFF-ON(1)-ON(2&3) SPDT

- First pull energizes #1
- Second pull energizes two separate circuits
- For anchor/running lights or similar function
- Solid brass construction
- 3/8" mounting bushing
- 4 screw terminals
- For panels up to 1" thick
- Chrome plated solid brass knob
- Rated: 15 amp @ 12 VDC



MP39640
MP39642 (Bulk 100pcs./carton)
 OFF-ON(1)-ON(2) SPDT

- First pull energizes #1
- Second pull energizes circuit 2
- Solid brass construction
- 3/8" mounting bushing
- 3 screw terminals
- For panels up to 1" thick
- Chrome plated solid brass knob
- Rated: 15 amp @ 12 VDC



** Display Packaged

HEAVY DUTY PUSH BUTTON SWITCHES

MOMENTARY ON-OFF SPST



MP39160**
MP39162 (Bulk 100pcs./carton)
with rubber boot nut

MP39180**
MP39182(Bulk 100pcs./carton)
with std. chrome face nut

- Corrosion resistant plastic construction
- 1 7/16"L x 5/8" mounting stem
- 2 boss screw terminals
- Rated: 30 Amp @ 12 VDC



MP21460
MP21462 (Bulk 100pcs./carton)
PUSH ON - PUSH OFF
• Two 5" wire leads for easy connection
• 3/8"L x 15/32" mounting stem
• Rated: 3 amps @125 VAC

PUSH BUTTON ANTI-VANDAL SWITCHES



- Sleek, Stainless Steel Design with Halo LED illumination
- Quick connect tab terminals for easy installation and daisy chaining
- Sealed to IP67 for above panel components
- UL1500 Ignition Protection



PART NUMBER	SWITCH FUNCTION	AMP RATING	ILLUMINATION COLOR	BLUE SEA#
AV10030	OFF-(ON)	10	None	-
AV10030B	OFF-(ON)	10	Blue	4161
AV10030G	OFF-(ON)	10	Green	-
AV10030R	OFF-(ON)	10	Red	4163
AV10030W	OFF-(ON)	10	White	-
AV10040	OFF-ON	10	None	-
AV10040B	OFF-ON	10	Blue	4160
AV10040G	OFF-ON	10	Green	-
AV10040R	OFF-ON	10	Red	4162
AV10040W	OFF-ON	10	White	-
AV10050R**	OFF-(ON)	10	Red	-
AV10060R*	OFF-ON	10	Red	-
AV10060B	OFF-ON	10	Blue	-
AV10060G	OFF-ON	10	Green	-
AV10060W	OFF-ON	10	White	-
AV10100R	OFF-ON	20	Red	4192
AV10100B	OFF-ON	20	Blue	4190
AV10120B	(ON2)-(ON1)-OFF	20	Blue/Red	-
AV10130B	OFF-ON	20	Blue	-

* Power legend on Switch

** Legend Horn Switch

** Display Packaged

HEAVY DUTY MARINE PUSH PULL SWITCHES



- MP39510**
MP39512 (Bulk 100pcs/carton)
 OFF-ON SPST
 • Pull for ON
 • Solid brass construction
 • 3/8" mounting bushing
 • 2 screw terminals
 • For panels up to 1" thick
 • Cream plastic knob
 • Rated: 15 amp @ 12 VDC



- MP39520****
MP39522 (Bulk 100pcs/carton)
 OFF-ON SPST
 • Pull for ON
 • Solid brass construction
 • 3/8" mounting bushing
 • 2 screw terminals
 • For panels up to 1" thick
 • Chrome plated plastic knob
 • Rated: 15 amp @ 12 VDC



- MP39530****
MP39532 (Bulk 100pcs/carton)
 OFF-ON SPST
 • Pull for ON
 • Solid brass construction
 • 3/8" mounting bushing
 • 2 screw terminals
 • For panels up to 1" thick
 • Chrome plated solid brass knob
 • Rated: 15 amp @ 12 VDC



- MP39540****
MP39542 (Bulk 100pcs/carton)
 OFF-ON SPST
 • Pull for ON
 • Solid brass construction
 • 3/8" mounting bushing
 • 2 blade terminals
 • For panels up to 1" thick
 • Chrome finish plastic knob
 • Rated: 15 amp @ 12 VDC



- MP39570****
MP39572 (Bulk 100pcs/carton)
 OFF-ON(1)-ON(1&2) SPDT
 • First pull energizes #1
 • Second pull energizes both circuits
 • Solid brass construction
 • 3/8" mounting bushing
 • 3 screw terminals
 • For panels up to 1" thick
 • Chrome finish plastic knob
 • Rated: 15 amp @ 12 VDC



- MP39610****
MP39612 (Bulk 100pcs/carton)
 OFF-ON(1)-ON(2&3) SPDT
 • First pull energizes #1
 • Second pull energizes two separate circuits
 • For anchor/running lights or similar function
 • Solid brass construction
 • 3/8" mounting bushing
 • 4 screw terminals
 • For panels up to 1" thick
 • Chrome finish plastic knob
 • Rated: 15 amp @ 12 VDC

BRASS PUSH BUTTON SWITCHES

MOMENTARY ON-OFF SPST

- Solid brass construction
- For starter, horn or other functions
- 1 1/4"L x 5/8" mounting stem
- 2 screw terminals (except MP39340)
- Rated: 20 amp @ 12 VDC



- MP39310****
MP39312 (Bulk 100pcs/carton)
 with chrome plated brass
 face nut and button



- MP39320****
MP39322 (Bulk 100pcs/carton)
 with rubber boot nut



- MP39340****
MP39342 (Bulk 100pcs/carton)
 with rubber boot nut
 blade terminals

** Display Packaged

HEAVY DUTY BRASS PUSH BUTTON SWITCHES

MOMENTARY ON-OFF SPST

- Solid brass construction
- For starter, horn or other functions
- 1 3/8" L x 5/8" -32 mounting stem
- 2 boss screw terminals
- Rated: 35 amp @ 12 VDC



MP39360
MP39362 (Bulk 100pcs/carton)
 with recessed plunger button
 prevents accidental actuation



MP39410
MP39412 (Bulk 100pcs/carton)
 with large 15/16" anodized
 face nut and button

MP39420
MP39422 (Bulk 100pcs/carton)
 with chrome plated brass face
 nut and button

COMPACT PUSH BUTTON SWITCHES

MOMENTARY ON-OFF SPST

- Contoured plastic button
- Chrome plated brass mounting stem
- 1/2" Mounting hole
- 2 brass blade terminals
- Rated 15 amp @ 12 VDC
- MP39690 commonly used as Horn Switch



MP39680**
MP39682 (Bulk 100pcs/carton)
 Black Button

MP39690**
MP39692 (Bulk 100pcs/carton)
 Red Button

MP39670
MP39672 (Bulk 100pcs/carton)
 White Button



MP39300**
MP39302 (Bulk 100pcs/carton)
 MOM ON-OFF SPST

- Large black plastic button
- Chrome plated brass housing
- For fog horns or sirens
- Overall width 2 5/8"

INDICATOR LIGHTS

UN22100**
UN22102 (Bulk 100pcs/carton)
 RED



UN22110**
UN22112 (Bulk 100pcs/carton)
 GREEN

UN22120**
UN22122 (Bulk 100pcs/carton)
 AMBER

SMALL INDICATOR LIGHTS
 12 VDC use only

- 5/16" mounting hole
- 5" tinned copper wire leads

UN22150**
UN22152 (Bulk 100pcs/carton)
 RED



UN22160
UN22162 (Bulk 100pcs/carton)
 GREEN

SMALL INDICATOR LIGHTS
 125 VAC use only

- 5/16" mounting hole
- 5" tinned copper wire leads

LARGE INDICATOR LIGHTS
 12 VDC use only

- 1/2" mounting hole
- 4" tinned copper wire leads



UN21280**
UN21282 (Bulk 100pcs/carton)
 RED



UN21290**
UN21292 (Bulk 100pcs/carton)
 GREEN



UN21320
UN21322 (Bulk 100pcs/carton)
 AMBER

** Display Packaged

EMERGENCY ENGINE CUT-OFF SWITCHES

MOMENTARY ON-OFF SPST



MP39350**
MP39352 (Bulk 100pcs/carton)
PUSH BUTTON SWITCH
MOM ON - OFF SPST
 • Solid brass construction
 • Weather resistant plasticized coating
 • Rubber boot nut
 • Two 12" L 18 gauge wire leads
 • Mounting bushing 15/16" L X 5/8"-32
 • Rated: 10 amps @ 12 VDC



MP39260**
MP39262 (Bulk 100pcs/carton)
WEATHER PROOF BOOT NUT
(BLACK)
 • For push button switches
 • Chrome face nut
 • Seals out moisture & dirt
 • Tapered design



UN42000**
UN42002 (Bulk 100pcs/carton)
MOM ON - OFF SPST
 • Extra heavy duty die cast construction
 • Silver contacts
 • 2 boss screw terminals
 • Rubber boot nut
 • Rated: 60 amp @ 12 VDC



MP39140
MP39142 (Bulk 100pcs/carton)
PUSH BUTTON SWITCH
COVER (BLACK)

FUSES



AGA GLASS TUBE FUSES
1/4" X 5/8"

PART #	RATING	PER PACK
FS79060**	20 AMP	5
FS79070	30 AMP	5



SFE GLASS TUBE FUSES

PART #	RATING	SIZE	PER PACK
FS79270	14 AMP	1/4" X 1"	5
FS79280	20 AMP	1/4" X 1 1/4"	5



AGU GLASS TUBE FUSES
13/32" X 1 1/2"

PART #	RATING	PER PACK
FS79820	20 AMP	2
FS79870**	50 AMP	2



AGC GLASS TUBE FUSES
1/4" X 1 1/4"

PART #	RATING	PER PACK
FS79090	1 AMP	5
FS79100	1.5 AMP	5
FS79110**	2 AMP	5
FS79470	2.5 AMP	5
FS79120**	3 AMP	5
FS79130**	4 AMP	5
FS79140**	5 AMP	5
FS79150**	6 AMP	5
FS79160**	7.5 AMP	5
FS79170**	10 AMP	5
FS79180**	15 AMP	5
FS79190**	20 AMP	5
FS79200**	25 AMP	5
FS79210**	30 AMP	5
FS79220	35 AMP	5



FS79600**
EMERGENCY FUSE KIT
 Contains SIX fuses (1 each)
 SFE 9, 14, 20 and AGC 10, 15, 30.



FS79630**
BILGE PUMP & ACCESSORY FUSE KIT
 Contains FIVE fuses (1 each)
 AGC 5, 10, 15, 30 amp, and 1 SFE 20 amp.

** Display Packaged

ATM & ATO STYLE FUSES

*Color coded AMP ratings, plug in automotive style.



ATO® STYLE FUSES
0.207" W X 0.752" H X 0.76" L

PART #	RATING	COLOR	PER PACK
FS79480**	1 AMP	BLACK	5
FS79490**	2 AMP	GRAY	5
FS79500**	3 AMP	VIOLET	5
FS79510**	4 AMP	PINK	5
FS79520**	5 AMP	TAN	5
FS79530**	7.5 AMP	BROWN	5
FS79540**	10 AMP	RED	5
FS79550**	15 AMP	BLUE	5
FS79560**	20 AMP	YELLOW	5
FS79570**	25 AMP	CREAM	5
FS79580**	30 AMP	GREEN	5
FS79590**	40 AMP	ORANGE	5



ATM STYLE FUSES
0.15" W x 0.429" H x 0.76" L

PART #	RATING	COLOR	PER PACK
FS80000**	2 AMP	GRAY	5
FS80010**	3 AMP	VIOLET	5
FS80030**	5 AMP	TAN	5
FS80040**	7.5 AMP	BROWN	5
FS80050**	10 AMP	RED	5
FS80060**	15 AMP	BLUE	5
FS80070**	20 AMP	YELLOW	5
FS80080**	25 AMP	CLEAR	5
FS80090**	30 AMP	GREEN	5



FS79590**
ATO® FUSE KIT ASSORTMENT



FS79580**
ATM FUSE KIT ASSORTMENT

MAXI™ FUSES

PART #	RATING	COLOR	PER PACK
FS81000	20 AMP	YELLOW	1
FS81010	30 AMP	GREEN	1
FS81020	40 AMP	ORANGE	1
FS81030	50 AMP	RED	1
FS81040	60 AMP	BLUE	1
FS81050	70 AMP	AMBER	1
FS81060	80 AMP	CLEAR	1



- Tin plated copper blades for corrosion protection
- Visible indication of blown condition
- Maximum voltage - 32 VDC

MAXI™ FUSE BLOCK



FS81080
FS81082
(Bulk 100pcs/carton)

- Black Reinforced Polycarbonate
- For Maxi™ fuses 30-80 A
- Snap-on cover insulates conductive parts - meets ABYC & USCG requirements
- Accepts 18-4 AWG wire from sides or bottom
- Maximum voltage - 32 VDC
- Meets SAE J1171

** Display Packaged



FS82000
ANL FUSE HOLDER
Replaces: Blue Sea 5005

- Works with 35-300A ANL Fuses (Not Included)
- Compact design Width 49mm x Length 98mm x Height 50mm (Including Cover)
- Stainless Steel Studs for superior corrosion protection
- ABYC/USCG Compliant transparent cover for clear view of fuse
- Cover features recessed area to apply labels for easy circuit identification
- Bendable/Removable side plates for flexible wiring options
- LED Blown Fuse Indicator
- Max Operating Voltage 32VDC
- Max Continuous Current 35-300A
- Terminal Stud Size 2 x M10



Available with various AMP ratings at 32VDC.
Ceramic Body for Superior Insulation
Brass, Gold-Plated Element for Superior Electrical Contact
Ignition Protected (ISO8846)

NEW

PART #	AMP	BULK #	BLUE SEA#
FS82010	100	FS82012	-
FS82020	150	FS82022	5127
FS82030	200	FS82032	5129
FS82040	250	FS82042	5131
FS82050	300	FS82052	5133
FS82060	350	FS82062	5135
FS82070	400	FS82072	5136

- 100% rating: 4 Hours Min
- 150% Rating: 60 Seconds Min
- 200% Rating: 15 Secs Min

FUSE BLOCK FOR GLASS TUBE STANDARD FUSE BLOCKS

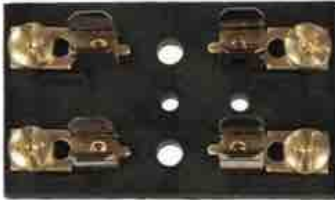

- Use with SFE, AGC, or MDL fuses up to 20 Amp
- Heavy duty black molded base
- 8-32 terminal screws
- Tin plated brass fuse clips

PART #	# OF GANGS
FS40500-1	2
FS40502-1*	2
FS40510-1**	4
FS40512-1*	4
FS40520-1**	6
FS40522-1*	6
FS40530-1	8

* Bulk 100pcs./carton

HOT FEED FUSE BLOCKS



- Use with SFE, AGC, or MDL fuses up to 20 Amp
- Common bus bar connects hot side of fuses for power feed
- Heavy duty black molded base
- 8-32 terminal screws and stud terminal for power connection
- Tin plated brass fuse clips

PART #	# OF GANGS
FS40590-1**	4
FS40592-1*	4
FS40600-1	6
FS40602-1*	6
FS40610-1	8
FS40612-1*	8

* Bulk 100pcs./carton

** Display Packaged

HOT FEED/COMMON GROUND FUSE BLOCKS



- Use with SFE, AGC, or MDL fuses up to 20 Amp
- Common bus bar connects hot side of fuses for power feed
- Separate bus bar for ground or unfused common hot feed
- Heavy duty black molded base
- 8-32 stud terminals for power/ground connection
- 1/4" Q.D. terminals for circuit hookup
- Tin plated brass fuse clips

PART #	# OF GANGS
FS40630-1	4
FS40632-1*	4
FS40640-1	6
FS40642-1*	6
FS40650-1	8
FS40652-1*	8

* Bulk 100pcs/carton



- Use with SFE, AGC, or MDL fuses up to 20 Amp
- Common bus bar connects hot side of fuses for power feed
- Separate bus bar for ground or unfused common hot feed
 - Heavy duty black molded base
- 8-32 terminal screws and stud terminals for power/ground connection
 - Tin plated brass fuse clips

PART #	# OF GANGS
FS40540-1	2
FS40542-1*	2
FS40550-1**	4
FS40552-1*	4
FS40560-1**	6
FS40562-1*	6
FS40570-1**	8
FS40572-1*	8

* Bulk 100pcs/carton

408 SERIES FUSE BLOCKS



Accepts ATP/ATC/ATO blade type fuses up to 30A
 Transparent cover with recessed area for label decals (60pc decal set included)
 Storage for 2 spare fuses | Blown fuse LED indication for easy determination
 32VDC Max Rating | 100A Maximum Cumulative | M5 Stud Size, M4 Screw Size



- FS40800****
- 6 Gang w/ Cover
 - Replaces: Blue Sea 5028
- Overall size - 3 3/8"W x 3 11/16"L x 1 5/8"H



- FS40820****
- 12 Gang w/ Cover
 - Replaces: Blue Sea 5029
- Overall size - 3 3/8"W x 5 1/4"L x 1 5/8"H



- FS40830****
- 6 Gang w/ Bus Bar and Cover
 - Replaces: Blue Sea 5025
- Overall size - 3 3/8"W x 3 11/16"L x 1 5/8"H



- FS40840****
- 12 Gang w/ Bus Bar and Cover
 - Replaces: Blue Sea 5026
- Overall size - 3 3/8"W x 5 1/4"L x 1 5/8"H



- FS40810****
- 408 SERIES GROUND BUS BAR
- 12 Terminal w/ Cover
 - Transparent cover with recessed area for label decals
 - M5 Stud Size, M4 Screw Size
- Overall size - 3 3/8"W x 2 1/4"L x 1 5/8"H

** Display Packaged

409 SERIES FUSE BLOCKS

NEW



FS40900**

FS40902 (Bulk)
AGC GLASS TYPE WITH BUS BAR

- Replaces: Blue Sea 5015
- Available in 4 and 6 gang options with or without bus bars
- Common source fuse block with negative busbar and cover
- Includes blown fuse indication LED's



FS40910**

FS40912 (Bulk)
AGC GLASS TYPE COMMON SOURCE

- Replaces: Blue Sea 5018
- Available in 4 and 6 gang options with or without bus bars
- Common source fuse block with negative busbar and cover
- Includes blown fuse indication LED's



FS40920**

FS40922 (Bulk)
AGC GLASS TYPE INDEPENDENT SOURCE

- Available in 4 and 6 gang options
- Compact and designed for 24-hour circuits
- Includes blown fuse indication LED's

ATO/ATC STYLE FUSE BLOCKS



WITH GROUND BUS BAR

PART #	# OF GANGS
FS40420**	6
FS40422*	6
FS40430**	4
FS40432*	4
FS40440**	14
FS40442*	14
FS40450**	8
FS40452*	8
FS40740**	10
FS40742*	10

* Bulk 100pcs/carton



WITHOUT GROUND BUS BAR

PART #	# OF GANGS
FS40410**	14
FS40412*	14
FS56242*	4
FS56232*	6
FS56252*	10

* Bulk 100pcs/carton

- For ATO/ATC fuses
- Interlocking modules snap together
- 1/4" tin plated copper tab terminals
- Flame resistant reinforced polyester base
- Rated 30 Amps per circuit, 160 Amp total for block

GROUND BUS BAR FOR ATO/ATC FUSE BLOCKS



FS40730**

FS40732 (Bulk 100pcs/carton)

- Replacement bus bar for Sierra ATO/ATC fuse blocks
- 14 - 1/4" tin plated copper tab terminals

** Display Packaged

New

100-150 AMP HEAVY DUTY

FS46600**
FS46602 (Bulk)

- 100A, 12 Gang
- Tin-plated copper bus allowing current up to 100A

FS46610**
FS46612 (Bulk)

- 100A, 6 Gang
- Tin-plated copper bus allowing current up to 100A

FS46620**
FS46622 (Bulk)

- Replaces: Blue Sea 2722
- 100A, 6 Gang
- Tin-plated copper bus allowing current up to 150A

FS46630**
FS46632 (Bulk)

- 100A, 12 Gang
- Tin-plated copper bus allowing current up to 150A



- Combines negative and positive buses in one block
- Stainless steel studs and M4 screws

150 AMP 2-STEP

FS46660**
FS46662 (Bulk)

- Replaces: Blue Sea 2701
- 6 Gang

FS46670**
FS46672 (Bulk)

- Replaces: Blue Sea 2702
- 12 Gang



- Stepped bus bars allowing more flexible wiring options
- Stainless steel studs and M4 screws

DUAL BRASS BUS BARS

FS40660**
FS40662 (Bulk 100pcs/carton)

- 4 - 8-32 Screw Terminals
- Overall size - 1.5"L x 1.5"W x .44"H



- Combines negative and positive buses in one block
- Brass terminal bar
- 150 AMP

FS40680**
FS40682 (Bulk 100pcs/carton)

- 12 - 8-32 Screw Terminals
- Overall size - 4.5"L x 1.5"W x .44"H

FS40690**
FS40692 (Bulk 100pcs/carton)

- 16 - 8-32 Screw Terminals
- Overall size - 6"L x 1.5"W x .44"H

FS40670**
FS40672 (Bulk 100pcs/carton)

- 8 - 8-32 Screw Terminals
- Overall size - 3"L x 1.5"W x .44"H



FS56152 (Bulk 100pcs/carton)

- 20 - 8-32 Screw Terminals
- Overall size - 7.5"L x 1.5"W x .44"H



MINI BUS BARS

NEW

100 AMP



FS46680**
FS46682 (Bulk)

- Replaces: Blue Sea 2314
 - 5 Gang w/ Cover
 - 3/16" - 24 Stud Size
 - #8 - 32 Screw Size
- Overall size - 4.2" x 0.88" x 1.37"**



FS46690**
FS46692 (Bulk)

- Replaces: Blue Sea 2315
 - 4 Stud w/ Cover
 - 3/16" - 24 Stud Size
- Overall size - 4.2" x 0.88" x 1.37"**

• Tin-Plated Copper Bus Bar • Flame Retardant ABS Base



FS46700**
FS46702 (Bulk)
150A COMMON BUS BAR

- Replaces: Blue Sea 2300
 - 12 Gan w/ Cover
 - 3/16" - 24 Stud Size
 - #8 - 32 Screw Size
 - 60lb-in Stud Torque
 - 15lb-in Screw Torque
- Overall size - 4.2" x 0.88" x 1.37"**



FS46710**
FS46712 (Bulk)
250A MAXI POWER

- 6 Stud
 - 5/16"-18 Stud Size
 - 60lb-in Stud Torque
- Overall size - 7.925" x 1.5" x 1.62"**

• Tin-Plated Copper Bus Bar • Stainless Steel Screws and Studs

CORROSION RESISTANT COMMON BUS BARS



- Use as common hot feed or common ground block
- Tin plated copper bus
- Stainless steel studs & screws
- Large diameter nuts provide large electrical contact area
- Stainless steel screws with lock washers

150 AMP COMMON BUS



FS46100**
FS46102 (Bulk 100pcs/carton)

- 5 - 8-32 Screw Terminals
 - 2 - 10-24 Stud Terminals
- Over all size - 4.13"L x .75"W x 1.44"H**



FS46150**
FS46152 (Bulk 100pcs/carton)

- 4 - 10-24 Stud Terminals
- Over all size - 4.13"L x .75"W x 1.44"H**



FS46200**
FS46202 (Bulk 100pcs/carton)

- 10 - 8-32 Screw Terminals
 - 2 - 1/4"-20 Stud Terminals
- Over all size - 6"L x 1.25"W x 1.44"H**



FS46250**
FS46252 (Bulk 100pcs/carton)

- 4 - 1/4"-20 Stud Terminals
- Over all size - 6"L x 1.25"W x 1.44"H**



FS46400
FS46402 (Bulk 100pcs/carton)

- 20 - 8-32 Screw Terminals
 - 2 - 1/4"-20 Stud Terminals
- Over all size - 9 1/4"L x 1.25"W x 1.44"H**



FS46450
FS46452 (Bulk 100pcs/carton)

- 6 - 1/4"-20 Stud Terminals
- Over all size - 9 1/4"L x 1.25"W x 1.44"H**

CORROSION RESISTANT COMMON BUS BARS

250 AMP COMMON BUS



FS46300

FS46302 (Bulk 100pcs./carton)

- 12 - 8-32 Screw Terminals
 - 2 - 1/4"-20 Stud Terminals
- Over all size - 7.88"L x 1.5"W x 1.75"H



FS46350

FS46352 (Bulk 100pcs./carton)

- 4 - 1/4"-20 Stud Terminals
- Over all size - 7.88"L x 1.5"W x 1.75"H

600 AMP COMMON BUS



FS46551

FS46552 (Bulk 100pcs./carton)

- 4 x 3/8-16 Stud Terminals
- Over all size - 7.00"L x 2"W x 2"H



FS46561

FS46562 (Bulk 100pcs./carton)

- 8 x 3/8-16 Stud Terminals
- Over all size - 11.375"L x 2"W x 2"H

BARRIER TYPE JUNCTION BLOCKS



FS45620**

FS45622 (Bulk 100pcs./carton)

- 4 Gang Block
 - 8 - 10-32 Screw Terminals
- Overall size - 3.94"L x 1.312"W x 0.812"H

- Each screw pair is 1 isolated circuit
- Closed back insulates power from mounting circuit
- Nickel plated brass bus bar



FS45630

FS45632 (Bulk 100pcs./carton)

- 6 Gang Block
 - 12 - 10-32 Screw Terminals
- Overall size - 4.36"L x 1.312"W x 0.812"H



FS45640

FS45642 (Bulk 100pcs./carton)

- 8 Gang Block
 - 16 10-32 Screw Terminals
- Overall size - 5.33"L x 1.312"W x 0.812"H



FS45650

FS45652 (Bulk 100pcs./carton)

- 10 Gang Block
 - 20 10-32 Screw Terminals
- Overall size - 6.31"L x 1.312"W x 0.812"H

BUS BARS INSULATING COVERS



- ABS cover designed to prevent accidental shorting



FSC46100
Fits FS46100, FS46150



FSC46200
Fits FS46200, FS46250



FSC46300
Fits FS46300, FS46350



FSC46400
Fits FS46400, FS46450



FSC46550
Fits FS46551



FSC46560
Fits FS46561

BRASS BUS BARS

- Use as common hot feed or common ground block
- Brass terminal bar
- 150 AMP

FS40720**
FS40722 (Bulk 100pcs/carton)

- 4 - 8-32 Screw Terminals
- Overall size - 4.5"L x .5" W x 1"H**



FS40750
FS40752 (Bulk 100pcs/carton)

- 10 - 10-32 Screw Terminals
 - 2 - 1/4"-20 Stud Terminals
- Overall size - 5.75"L x 1.25 W x 1.19"H**



HEAVY DUTY TERMINAL STUDS



- 48VDC Max Operating Voltage
- Glass Fiber reinforced Nylon base ensures great mechanical strength and durability



FS46540**
FS46542 (Bulk)
TERMINAL STUD,
SINGLE M10
REPLACES: BLUE SEA 2003
• Replaces 3/8"



FS46570**
FS46572 (Bulk)
TERMINAL STUD,
SINGLE M8
REPLACES: BLUE SEA 2002
• Replaces 5/16"



FS46580**
FS46582 (Bulk)
TERMINAL STUD,
DUAL M10
REPLACES: BLUE SEA 2017
• Replaces 3/8"
• Includes isolating plate



FS46590**
FS46592 (Bulk)
TERMINAL STUD,
SINGLE M8/M10
REPLACES: BLUE SEA 2018
• Replaces 5/16"
• Includes isolating plate

** Display Packaged

ATO/ATC STYLE FUSE HOLDERS



- FS35870****
FS35872 (Bulk 100pcs./carton)
FUSE HOLDER
- Weather proof sealed case
 - 5" - 12 gauge wire leads
 - For ATO/ATC style fuses up to 30 amps



- FS69130****
N-186913 (Bulk 100pcs./carton)
FUSE HOLDER
- 5" - 12 gauge wire leads
 - For ATO/ATC style fuses up to 30 amps
 - Includes 30 amp fuse



- FS45410****
FS45412 (Bulk 100pcs./carton)
FUSE HOLDER
- 8" - 14 gauge wire loop
 - For ATO/ATC style fuses up to 20 amps

WEATHER RESISTANT GLASS TUBE STYLE FUSE HOLDERS



WEATHER RESISTANT FUSE HOLDER
 WITH SPARE FUSE COMPARTMENT

PART #	DETAILS
FS69150**	10 GA 8" wire loop w/ two 30 Amp fuses
FS69160**	12 GA 8" wire loop w/ two 20 Amp fuses
FS69170**	14 GA 8" wire loop w/ two 15 Amp fuses
FS69180**	16 GA 8" wire loop w/ two 10 Amp fuses



- FS69140****
HEAVY DUTY FUSE HOLDER
- Weather resistant
 - 5" - 8 gauge wire leads
 - For 30 to 50 Amp AGC fuses

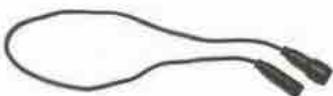

- FS45440****
FS45442 (Bulk 100pcs./carton)
FUSE HOLDER
- Weather proof sealed case
 - 15" - 14 gauge wire loop
 - For up to 20 amp SFE, AGC, MDL fuses



- FS45470****
FS45472 (Bulk 100pcs./carton)
FUSE HOLDER
- Weather proof sealed case
 - 15" - 10 gauge wire loop
 - Includes 30 amp SFE fuse



- FS45460****
FS45462 (Bulk 100pcs./carton)
FUSE HOLDER
- Weather proof sealed case
 - 15" - 14 gauge wire loop
 - Includes 20 amp SFE fuse

IN-LINE GLASS TUBE STYLE FUSE HOLDERS



- FS45350****
FS45352 (Bulk 100pcs./carton)
FUSE HOLDER
- Black plastic twist lock case
 - 8" - 14 gauge wire loop
 - Includes 20 amp SFE fuse



- FS45400****
FS45402 (Bulk 100pcs./carton)
FUSE HOLDER
- White plastic twist lock case
 - 7" - 16 gauge wire loop
 - For glass fuses up to 10 amp



- FS45360****
FS45362 (Bulk 100pcs./carton)
FUSE HOLDER
- Red plastic twist lock case
 - 8" - 14 gauge wire loop
 - Includes 14 amp SFE fuse



- FS69100****
FUSE HOLDER
- Black plastic twist lock case
 - 7" - 14 gauge wire loop
 - Includes 15 amp fuse



- FS45380****
FS45382 (Bulk 100pcs./carton)
FUSE HOLDER
- Black plastic threaded case
 - 7" - 12 gauge wire loop
 - Includes 30 amp SFE fuse



- FS69110****
FUSE HOLDER
- Black plastic twist lock case
 - 7" - 14 gauge wire loop
 - Includes 20 amp fuse



- FS45390****
FS45392 (Bulk 100pcs./carton)
FUSE HOLDER
- Black plastic threaded case
 - 7" - 12 gauge wire loop
 - Includes 20 amp SFE fuse



- FS69120****
FUSE HOLDER
- Heavy Duty
 - 12 gauge tinned copperwire
 - Includes 30 amp fuse

** Display Packaged

PANEL MOUNT GLASS TUBE STYLE FUSE HOLDERS

- FS22090****
FS22082 (Bulk 100pcs/carton)
FUSE HOLDER
- Panel mount with red fuse label
 - For glass fuses up to 20 amp
 - For panels up to 5/16" thick



- FS45430****
FS45432 (Bulk 100pcs/carton)
FUSE HOLDER
- Panel mount
 - Weather resistant gasket sealed
 - For AGC, MDL fuses
 - For panels up to 5/16" thick



HIGH AMPERAGE CIRCUIT BREAKERS

* Perfect for rigging trolling motors, windless, and other high amp electrical equipment

AUTO RESET

* INCLUDES STUD MOUNTING PLATE



- CB42240****
 40 Amp • 12V
- CB42250-1****
 50 Amp • 12V

MANUAL RESET

* INCLUDES STUD MOUNTING PLATE



- CB43240**** **CB43250****
 40 Amp • 12V 50 Amp • 12V

- CB45240** **CB45250**
 40 Amp • 24V 50 Amp • 24V

TOGGLE TYPE CIRCUIT BREAKERS

- High quality exact replacement on many top brands
- Color coded handles for quick identification of AC/DC
- White handles for DC, black handles for AC
- Clamshell packaging



PART #	AMP RATING	COLOR
CB40200	5	WHITE
CB40220	10	WHITE
CB40230	15	WHITE
CB40240	20	WHITE
CB40250	35	WHITE
CB40190	50	WHITE
CB41240	40	WHITE
CB40260	15	BLACK
CB40270	20	BLACK
CB40280	30	BLACK

PUSH BUTTON RESETTABLE CIRCUIT BREAKERS

- Ignition protected design for safe use in below deck boat applications.
- Compatible with AC and DC circuits
- Push-to-Reset Operation
- Mounts in 3/8" hole
- Uses optional MP39210 weatherproof boot to protect circuit breaker in harsh environments*

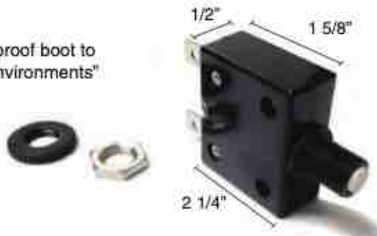

PART #	AMP RATING	COLOR
CB41100	3	WHITE
CB41200**	5	WHITE
CB41210	10	WHITE
CB41220**	15	WHITE
CB41230**	20	WHITE
CB41210B**	10	BLACK

NEW



CB41250
 25A
 BLUE SEA# 7058



CB41260
 30A
 BLUE SEA# 7059



CB41270
 45A
 BLUE SEA# 7061

** Display Packaged

STD TOGGLE CIRCUIT BREAKERS

- Compatible with AC and DC circuits
- Exact OEM replacement for many top brands
- Hydraulic-magnetic trip mechanism will not trip by surges caused by start-up currents.
- Standard safety 'Trip Free' feature so switch cannot be held 'ON.'



PART #	AMP RATING	COLOR	POLE	BLUE SEA#
CB50400	5	BLACK	SINGLE	7200
CB50410	10	BLACK	SINGLE	7204
CB50420	25	BLACK	SINGLE	7216
CB50430	25	WHITE	SINGLE	7218
CB50440	404	BLACK	SINGLE	7224
CB50450	50	BLACK	SINGLE	7228
CB50460	30	WHITE	DOUBLE	7238
CB50470	50	WHITE	DOUBLE	7242

FLAT ROCKER CIRCUIT BREAKERS

- Compatible with AC and DC circuits
- Exact OEM replacement for many top brands
- Hydraulic-magnetic trip mechanism will not trip by surges caused by start-up currents.
- Standard safety 'Trip Free' feature so switch cannot be held 'ON.'

NEW



PART #	AMP RATING	POLE	BLUE SEA#
CB50300	5	SINGLE	7540
CB50310	10	SINGLE	7541
CB50320	15	SINGLE	7542
CB50480	20	SINGLE	7543
CB50330	30	SINGLE	7545
CB50500	30	DOUBLE	7560
CB50340	50	SINGLE	7546
CB50490	50	DOUBLE	7561
CB50350	60	SINGLE	7547
CB50360	80	SINGLE	7548
CB50370	100	SINGLE	7549
CB50380	150	DOUBLE	7475
CB50390	200	DOUBLE	7476
CB50510	100	DOUBLE	7564

FLUSH/PANEL MOUNT CIRCUIT BREAKERS

- 1/4" Stainless Steel Studs on the face of the circuit breaker for easy installation
- Connected terminal boots
- Combined use as a switch and circuit protection
- Standard safety 'Trip Free' feature so switch cannot be held 'ON'
- Ignition protected design for safe use in below deck boat applications

NEW



PART #	AMP RATING	MOUNT	BLUE SEA#
CB50520	25	FLUSH	7180
CB50530	30	FLUSH	7181
CB50540	40	FLUSH	7182
CB50550	50	FLUSH	7183
CB50560	80	FLUSH	7186
CB50570	100	FLUSH	7187
CB50580	135	FLUSH	-
CB50590	150	FLUSH	7189
CB50600	200	FLUSH	-
CB50610	40	PANEL	7082
CB50620	50	PANEL	7083
CB50630	60	PANEL	7084
CB50640	80	PANEL	7086
CB50650	100	PANEL	7087
CB50660	150	PANEL	7089
CB50670	200	PANEL	-



- CB60000-1****
CB60002-1 (std. pk of 25)
- Ignition Protected
 - Waterproof
 - Can be used as switch and circuit breaker
 - Replaces Minnkota MKR-19
 - Rated - 60 A
 - Maximum voltage 42 VDC
 - Stainless steel hardware

** Display Packaged

Sierra's NMEA 2000 series of waterproof cables and adapters are NMEA approved and specifically designed to fit marine requirements. Our NMEA series follow the requirements of a serial data communication network to interconnect marine electronic equipment on vessels. Equipment designed to this system will have the ability to share data, including commands and status with other compatible equipment over a single channel. From fish finders to deep sea vessels autopilot, you can always find suitable products for your devices' usage with Sierra!



2000 EXTENSION CABLES MICRO-C HI-POWER (METAL)

PART #	SIZE	BULK #	ANCOR#
PC51000	2'	PC51002	270001
PC51010	3'	PC51012	
PC51020	6'	PC51022	270002
PC51030	12'	PC51032	270005
PC51040	30'	PC51042	270010

2000 DROP CABLES MICRO-C (METAL)

PART #	SIZE	BULK #	ANCOR#
PC51140	2'	PC51142	270300
PC51150	3'	PC51152	270301
PC51160	6'	PC51162	270302
PC51170	16'	PC51172	270305



PC51050
PC51052 (Bulk)
 NMEA 2000 POWER T CABLE
 ANCOR# 270000
 • 3 ft.
 • Metal



PC51060
PC51062 (Bulk)
 NMEA MICRO 1 T PIECE
 ANCOR# 270101
 • Metal



PC51070
PC51072 (Bulk)
 NMEA 2000 TERMINATION RESISTOR
 ANCOR# 270105
 • Female
 • Metal



PC51080
PC51082 (Bulk)
 NMEA 2000 TERMINATION RESISTOR
 ANCOR# 270106
 • Male
 • Metal



PC51090
PC51092 (Bulk)
 NMEA MICRO 90 ELBOW
 ANCOR# 270108
 • Metal



PC51100
PC51102 (Bulk)
 NMEA MICRO 2 TEE PIECE
 ANCOR# 270103
 • Metal



PC51110
PC51112 (Bulk)
 NMEA MICRO 4 T PIECE
 ANCOR# 270104
 • Male
 • Metal



PC51120
PC51122 (Bulk)
 M12 METAL CAP FOR FEMALE CONN
 ANCOR# 270112
 • Female



PC51130
PC51132 (Bulk)
 M12 METAL CAP FOR CONN
 ANCOR# 270111
 • Male

** Display Packaged



- MP41400****
COMPLETE AUDIBLE WARNING KIT
 Contains:
OP22900** Oil pressure switch 6 PSI (1/8" - 27) normal closed
TS25101 Temperature switch (3/8" - 18)
MC33502 Buzzer switch
OP22891 Optional oil pressure switch 15 PSI (1/8" - 27) normal closed

Buzzer alerts operator of high engine temperatures or low engine oil pressure. Kit includes instructions, oil pressure switch (set at 6 PSI) and temperature switch (set at 200° F).



- MP39210****
WEATHER PROOF BOOT NUT
 • Seals out dirt and moisture
 • For use with push button resettable circuit breakers

4 POLE FLAT CONNECTORS

Shrouded connectors provide better protection against weather dirt and moisture. Unshrouded connectors are found on most OEM trailers. The plugs are interchangeable and can connect together.

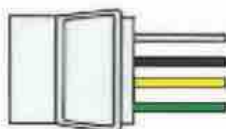

- White** Ground
Brown Tail, License, Marker Lamps
Yellow Left Turn Signal/Stop Lamp
Green Right Turn Signal/Stop Lamp

** Display Packaged

UNSHROUDED



Trailer Side



Tow Vehicle Side

SHROUDED



Trailer Side



Tow Vehicle Side



DESCRIPTION	SET OF BOTH HALVES PART #	TOW VEHICLE SIDE PART #	WIRE LENGTH	TRAILER SIDE PART NUMBER	WIRE LENGTH
4 Pole Flat - Unshrouded	TC43654**	NSS	4-12"	TC44054**	4-12"
4 Pole Flat - Unshrouded		TC44094	3-48", 1-18"	TC44054**	4-12"
4 Pole Flat - Shrouded			4-12"	TC44254	4-12"
4 Pole Flat - Shrouded		TC44224	3-48", 1-18"	TC44254	4-12"
4 Pole Flat - Shrouded rewire kit	TC43754	TC44224	3-48", 1-18"	NSS	4-20'
4 Pole Flat - Shrouded rewire kit w/ Splicers	TC43744	TC44224	3-48", 1-18"	NSS	4-20'
4 Pole Flat - Shrouded 5' Extension Harness	WH10350				
4 Pole Flat - Shrouded 25' rewire kit				WH10003	4-25'



TC52000
 TESTER



TC42884
 TESTER

Allows for quick and easy diagnosis of trailer/tow vehicle lighting problems; simply plug into vehicle trailer connector, LED lighting allows for each circuit to be quickly tested and evaluated.

5 POLE FLAT CONNECTORS



- White** Ground
Brown Tail, License, Marker Lamps
Yellow Left Turn Signal/Stop Lamp
Green Right Turn Signal/Stop Lamp
Blue Trailer Brake Solenoid

** Display Packaged



DESCRIPTION	SET OF BOTH HALVES PART #	TOW VEHICLE SIDE PART #	WIRE LENGTH	TRAILER SIDE PART NUMBER	WIRE LENGTH
5 Pole Flat - Unshrouded 18" Extension Harness	TC51000**				
5 Pole Flat - Unshrouded		TC51100	5-48"	TC51200	5-70"

POLARIZED CONNECTORS

These polarized connector sets plug together only one way to prevent cross connections. Constructed of rugged plastic with molded-in terminals for durability. Wire connections are easy and fast with just a screwdriver. Soft, pliable rubber caps protect the rear of each connector. Dozens of uses. Sold only in mating pairs.



TC43604**
2 Pole Polarized Round

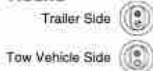

TC43614
3 Pole Polarized Round

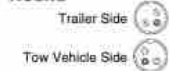

TC43624
4 Pole Polarized Round

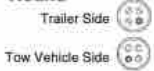

TC43634**
2 Pole Polarized - Flat with 12" wires on each half.

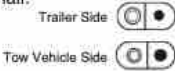

2-WIRE FLAT CONNECTOR
WH10300**
12", 16 GA. 2 Plugs Ready Wired #E301120
WH10310
60", 16 GA. 2 Plugs Ready-Wired #E302120

HEAVY DUTY CONNECTORS



TC44984**
7 Pole (Blade) RV Style

Thermoplastic Converter Kit
This kit is used on tow vehicle to convert any Sierra standard 4 pole flat connector to a 7 pole blade connector used on RV's.



TC43904
Non-Strip Splicers

Four blue non-strip splice connectors for making secure, permanent splices without stripping wires manually. Crimp with pliers and metal insert makes connection. Plastic top folds over to insulate connection.



TC43944
7 Pole RV Style Connector

Trailer Side

ELECTRONIC TAILLIGHT CONVERTERS

These reliable electronic devices enable tow vehicles and trailers with mismatched light systems to work together.



TC43504

Amber/Red to Red Taillight Converter

Universal SPLICE-IN trailer converter for cars and trucks with separate stop and turn signals. Electronic taillight module converts tow vehicle's amber turn signal and red brake light into one combined red brake/turn signal on your trailer.

ADAPTERS

These adapters allow a tow vehicle with a 4, 6 or 7 pole socket to tow a trailer with a different configuration plug. Quality molded plastic connector stores in glove box when not in use.



TC50000**

7 Pole RV Style Blade

to 5 pole flat - 18" extension harness



TC51300**

7 Pole RV Style Blade

to 5 pole flat



TC42634

7 POLE RV STYLE BLADE

to 6 Pole Pin



TC42694

4 POLE ROUND

to 4 Pole Flat



TC42904

6 POLE ROUND

to 4 Pole Flat



TC42914**

7 POLE RV STYLE BLADE

to 4 Pole Flat

** Display Packaged

TROLLING MOTOR PLUGS



WH10600-1**
WH10602-1 (PKG OF 100)
 V-GROOVE FEMALE MOTOR
 SIDE TROLLING MOTOR
 SOCKET
 12 Volt
 6" - 8 gauge w/ butt connectors
 Use with WH10610-1



WH10610-1**
WH10612-1 (PKG OF 100)
 V-GROOVE MALE BOAT SIDE
 TROLLING MOTOR PLUG
 12 Volt
 6" - 8 gauge w/ butt connectors
 Use with WH10600-1



WH10520-1**
WH10522 (PKG OF 100)
 MALE BOAT SIDE
 TROLLING MOTOR PLUG
 12 Volt
 6" - 8 gauge w/ butt connectors
 Use with WH10530-1



WH10530-1**
WH10532 (PKG OF 100)
 FEMALE MOTOR SIDE
 TROLLING MOTOR SOCKET
 12 Volt
 6" - 8 gauge w/ butt connectors
 Use with WH10520-1



WH10540-1**
WH10542 (PKG OF 100)
 MALE BOAT SIDE
 TROLLING MOTOR PLUG
 24 Volt
 6" - 8 gauge w/ butt connectors
 Use with WH10550-1



WH10550-1**
WH10552 (PKG OF 100)
 FEMALE MOTOR SIDE
 TROLLING MOTOR SOCKET
 24 Volt
 6" - 8 gauge w/ butt connectors
 Use with WH10540-1



WH10470-1**
WH10472 (PKG OF 100)
 FEMALE BOAT SIDE
 TROLLING MOTOR SOCKET
 12 Volt
 6" - 10 gauge w/ butt connectors
 Use with WH10480-1



WH10480-1**
WH10482 (PKG OF 100)
 MALE MOTOR SIDE
 TROLLING MOTOR PLUG
 12 Volt
 6" - 10 gauge w/ butt connectors
 Use With WH10470-1



WH10490-1**
WH10492 (PKG OF 100)
 FEMALE BOAT SIDE
 TROLLING MOTOR SOCKET
 24 Volt
 6" - 10 gauge w/ butt connectors
 Use with WH10500-1



WH10500-1**
WH10502 (PKG OF 100)
 MALE MOTOR SIDE
 TROLLING MOTOR PLUG
 24 Volt
 6" - 10 gauge w/ butt connectors
 Use with WH10490-1



WH10560**
 FEMALE BOAT SIDE
 TROLLING MOTOR SOCKET
 12 Volt • 3 Slots
 10" - 10 gauge w/ butt connectors
 Use with WH10570



WH10570**
 MALE MOTOR SIDE
 TROLLING MOTOR PLUG
 12 Volt • 3 Plugs
 10" - 10 gauge w/ butt connectors
 Use with WH10560



WH10640**
 MALE BOAT SIDE
 TROLLING MOTOR PLUG
 24 Volt • 60 AMP
 Use with WH10650



WH10650**
 FEMALE MOTOR SIDE
 TROLLING MOTOR SOCKET
 24 Volt • 60 AMP
 Use with WH10640

TRAILER ACCESSORIES



CARSIDE CONNECTORS

WH10040
 48", 16 GA 4/Pole
 Ready-Wired #B240010

WH10230**
 48", 16GA 5/Pole
 Ready-Wired #M242010

** Display Packaged

TRAILER ACCESSORIES



WH10220
TRAILER SIDE CONNECTOR
24", 16 GA, 4/Pole
Ready-Wired #M241120



WH10240**
TRAILER SIDE CONNECTOR
24", 16 GA 5/Pole
Ready-Wired #M243120
Use with WH10230



WH10320
3- WIRE FLAT CONNECTOR
12", 16 GA, 2 Plugs
Ready Wired #E303120

VOLTAGE SENSITIVE RELAY



BS11040**
BS11042 (BULK)
VOLTAGE SENSITIVE RELAY
REPLACES: BLUE SEA 7601

Automatically combines two batteries when charging and isolates the two batteries when not charging
Built-in LED indication when VSR is engaged
Port for remote LED indicating VSR status
CE and IP67 Certifications

Specifications

- 12VDC Nominal Voltage
- 13.9VDC Combine Voltage
- 12.8VDC Open Voltage
- 125A Continuous Current Rating
- 140A Intermittent Current Rating
- Power Consumption: 10mA (Standby)/ 330mA (Engage), 0mA (Storage Mode)



BS11050**
BS11052 (BULK)
VOLTAGE SENSITIVE RELAY
AND CABLE KIT

Includes

- 1x VSR with mounting screws
- 1x 6 Meter red cable terminated at both ends
- 2x Positive marine battery terminals
- 1x Negative marine battery terminal
- 2x Copper crimp lugs for red cable
- 1x Copper crimp lugs for black cable
- 2x Red heat shrink
- 1x Insulated blue ring terminal
- 6x 200mm cables ties
- 1x Instruction Manual



LEVER / BATTERY SWITCHES



MP38910
LEVER OPERATED
BATTERY DISCONNECT SWITCH
Rated 175 A continuous, 800 A intermittent
• 3/8" brass terminals
• Chrome Plated Brass Lever
• Includes faceplate



UN77310**
BATTERY SWITCH

Polyester housing is rust and corrosion proof. Removable plastic key for security. Two position switch "Off-On". Two 10MM X 1.5MM stud terminals. For panels up to 1.25 thick. Four mounting holes in a rectangle 1.3" and .8" on centers. 350 amp continuous rating. 500 amp intermittent rating.



BS11000**
BS11002 (BULK)
BATTERY SWITCH
REPLACES: BLUE SEA 6006



BS11010**
BS11012 (BULK)
BATTERY SWITCH W/ AFD



BS11020**
BS11022 (BULK)
BATTERY SWITCH
(1-2-BOTH-OFF)
REPLACES: BLUE SEA 6007



BS11030**
BS11032 (BULK)
BATTERY SWITCH W/ AFD
(1-2-BOTH-OFF)

M4x35 Mounting Screws (Qty: 4) Included
Meets Ignition Protection Standard (ISO8846/ SAE J1171), IP66 Rated

- On-Off Function
- 48VDC Maximum Voltage Rating
- M10 Stud Size
- 1250A Cranking Rating (10 Seconds)
- 455A Intermittent Rating (5 Minutes)
- 275A Continuous Rating
- 1 Battery Input
- 2 Switch Positions
- Tin-plated Copper Battery Studs
- 4/0 AWG Cable Size to Meet Ratings
- Tinned Copper Studs
- 120 lb-in Stud Torque

M4x35 Mounting Screws (Qty: 4) Included
Meets Ignition Protection Standard (ISO8846/ SAE J1171), IP66 Rated

- 1-2-Both-Off Function
- 48VDC Maximum Voltage Rating
- M8 Stud Size
- 1000A Cranking Rating (10 Seconds)
- 300A Intermittent Rating (5 Minutes)
- 200A Continuous Rating
- 1 Battery Input
- 4 Switch Positions
- Tin-Plated Battery Studs
- 4/0 AWG Cable Size to Meet Ratings
- Tinned Copper Studs
- 120 lb-in Stud Torque

** Display Packaged

BATTERY ISOLATORS

Sierra battery isolators allow for worry free protection against discharging you start battery along with you house battery. Insures battery isolation without needing to check a switch. Allows two or three batteries to be charged at once. All are negative ground.



18-6851



18-6852



18-6853

PART NO.	DIMENSIONS	BATTERIES	ALTERNATORS	TERMINALS	MAX. OUTPUT
18-6851	6 1/2" w x 4 1/2" d x 3 1/2" h	3	1	4 - 3/8-16	120 Amp
18-6852	8" w x 4 1/2" d x 3 1/2" h	2	1	3 - 3/8-16	165 Amp
18-6853	11" w x 4 1/2" d x 3 1/2" h	3	1	4 - 3/8-16	200 Amp
18-6854	8" w x 4 1/2" d x 3 1/2" h	3	1	4 - 3/8-16	160 Amp
18-6855	3 1/4" w x 4 1/2" d x 3 1/2" h	2	1	4-1/4"-18	75 Amp
18-6856	15" w x 4 1/2" d x 3 1/2" h	2	1	3 - 3/8-16 • 1-1/4"-28	270 Amp

◆ Will not work with Delco CS series alternators ◆ Will work with Delco CS series alternators



18-6854



18-6855



18-6856

TRAILER BEARINGS



18-1100
STANDARD TRAILER BEARING DUST COVER
For Trailer Bearings
1.980 Dia.



TRAILER BEARING KITS

FOR STRAIGHT SPINDLES	
18-1105	1" Bearing Kit (BRG #L44643-L44610)
18-1106	1 1/16" Bearing Kit (BRG #L44649-L44610)
18-1107	1 1/4" Bearing Kit (BRG # LM67048-LM67010)
FOR STEP SPINDLES	
18-1109	1 1/4" & 3/4" Bearing Kit (BRG #LM67048-LM67010, LM11949-LM11910)
18-1110	1 3/8" & 1 1/16" Bearing Kit (BRG #L68149-L68111, L44649-L44610)



18-79987
TRANSOM PLATE (SMALL)
Size: 2" x 15"
Universal fit plate designed to add transom support.



18-79988
TRANSOM PLATE (LARGE)
Size: 4" x 17"
Oversized universal fit plate designed to add transom support.



TRAILER BEARING SEALS

PART #	O.D.	DIMENSIONS	
		SHAFT SIZE	WIDTH
18-1175	1.985	1.125	.467
18-1176	1.985	1.250	.257
18-1177	2.330	1.500	.408
18-1178	2.566	1.750	.500



COTTER PINS (PKG. OF 10)

PART #	DIMENSIONS	STD. PKG.
18-1199	1/8" x 2"	10
18-3745	7/64" x 1 1/2"	5
18-3746	1/8" x 1"	10
18-3747	5/32" x 1 1/2"	10

WATERPROOF TERMINALS



16-14 GAUGE RING TERMINALS

STUD SIZE	WIRE GAUGE	INSUL COLOR	PKG. OF 10
8	16-14	Blue	EC63120
10	16-14	Blue	EC63130
1/4"	16-14	Blue	EC63140
5/16"	16-14	Blue	EC63190
3/8"	16-14	Blue	EC63200

12-10 GAUGE RING TERMINALS

STUD SIZE	WIRE GAUGE	INSUL COLOR	PKG. OF 10
8	12-10	Yellow	EC63720
10	12-10	Yellow	EC63240
1/4"	12-10	Yellow	EC63250
5/16"	12-10	Yellow	EC63260
3/8"	12-10	Yellow	EC63300

WATERPROOF CONNECTORS

22-10 GAUGE BUTT CONNECTORS

WIRE GAUGE	INSUL COLOR	PKG. OF 10	100 PACK BOX
22-18	Red	EC64000	EC64000-100
16-14	Blue	EC64110	EC64110-100
12-10	Yellow	EC64230	EC64230-100

AWG 18-20AWG 18-20AWG 18-2

RING TERMINALS

22-18 GAUGE RING TERMINALS

STUD SIZE	WIRE GAUGE	INSUL COLOR	PKG. OF 10	100 PACK BOX PART #
6	22-18	Red	EC04010	EC04010-100
8	22-18	Red	EC04020	EC04020-100
10	22-18	Red	N/A	EC04030-100
1/4"	22-18	Red	N/A	EC04040-100



16-14 GAUGE RING TERMINALS

STUD SIZE	WIRE GAUGE	INSUL COLOR	PKG. OF 10	100 PACK BOX PART #
8	16-14	Blue	EC04120	EC04120-100
10	16-14	Blue	EC04130	EC04130-100
1/4"	16-14	Blue	EC04140	EC04140-100
5/16"	16-14	Blue	EC04190	EC04190-100
3/8"	16-14	Blue	EC04200	EC04200-100



12-10 GAUGE RING TERMINALS

STUD SIZE	WIRE GAUGE	INSUL COLOR	PKG. OF 10	100 PACK BOX PART #
6	12-10	Yellow	N/A	EC04710-100
8	12-10	Yellow	N/A	EC04720-100
10	12-10	Yellow	EC04240	EC04240-100
1/4"	12-10	Yellow	EC04250	EC04250-100
5/16"	12-10	Yellow	EC04260	EC04260-100
3/8"	12-10	Yellow	EC04300	EC04300-100



** Display Packaged

QUICK DISCONNECTS, BULLET, BUTT & SPADE TERMINALS

.157 BULLET TERMINALS

WIRE TYPE	WIRE GAUGE	INSUL COLOR	VISUAL PART # / QTY.	PKG. OF 10	100 PACK BOX PART #
FEMALE	22-18	Red	N/A	EC04080	EC04080-100
MALE	22-18	Red	N/A	N/A	EC04070-100
FEMALE	16-14	Blue	N/A	EC04180**	EC04180-100
MALE	16-14	Blue	N/A	EC04170**	EC04170-100
SET	16-14	Blue	EC01570** / 3 SETS	N/A	N/A



SPADE LUG TERMINALS

STUD SIZE	WIRE GAUGE	INSUL COLOR	PKG. OF 10	100 PACK BOX PART #
8	22-18	Red	EC04090	EC04090-100
10	22-18	Red	EC04100	EC04100-100
8	16-14	Blue	EC04210	EC04210-100
10	16-14	Blue	EC04220	EC04220-100



.250 QUICK DISCONNECTS

Wire Type	Gauge	Insul. Color	Pkg. of 10	100 Pack Box Part #
Female	22-18	Red	EC04050	EC04050-100
Female	16-14	Blue	EC04150	EC04150-100
Male	16-14	Blue	N/A	EC04160-100
Female	12-10	Yellow	EC04280	EC04280-100
Fully Insul. Female	16-14	Blue	EC04500	EC04500-100
Fully Insul. Male	16-14	Blue	EC04490	EC04490-100

BUTT CONNECTORS

Wire Gauge	Insul. Color	Pkg. of 10	100 Pack Box Part #
22-18	Red	EC04000**	EC04000-100
16-14	Blue	EC04110**	EC04110-100
12-10	Yellow	EC04230	EC04230-100

SHRINK/PROTECTIVE FLEX TUBING



TYPE	DIA.	VISUAL PACK PART #	QTY	LENGTH
FLEX TUBING	3/8"	EC01620	1	3'
FLEX TUBING	1/2"	EC01690	1	3'
SHRINK TUBE	ASSORT.	EC01750**	7	ASSORT.

NYLON CABLE CLAMPS



DIA.	VISUAL PACK PART #	QTY
5/16"	EC01440	7
3/8"	EC01450	6
1/2"	EC01460	5



EC06230**
CHARGING CLIP
Rating: 30 AMP
PKG OF 2

CLIPS & LEADS



EC01380



EC01370

ALLIGATOR CLIPS/TEST LEADS

TYPE/SIZE	PKG OF 2
CLIP 2" w/SCREW TERM	EC01370**
CLIP 1-1/4" INSULATED	EC01380**

EC10250**
3/4" TEST CLIPS
50 AMP
Replaces: OMC 390926
(One Pair)



** Display Packaged



EC09090

DIGITAL MINI MULTIMETER

Compact design and the functions you need for overall convenience. Its low price will surprise you!

- 3 1/2 digit LCD display • 16 test ranges, 6 functions
- Battery & protective holster included • Fuse protected, removable safety leads and jacks

DC Volts: 0-200mV, 2000mV 20V, 200V, 500V
 AC Volts: 0-200V, 500V
 DC Amps: 0-2mA, 20mA, 200mA
 Ohms: 0-200W, 2000W, 20KW, 200KW, 2000KW
 Diode Test: 0-2000W
 Battery Test: 0-9v



EC09040

DUAL VOLTAGE CIRCUIT TESTER

Dual bulb tester for testing both 6 and 12 volt circuits. Also can be used to check spark plug wires. This is the most commonly used tester for troubleshooting auto, truck, van and boat wiring. Supplied with ground wire and clip. Packed one per card.



EC01310

TERMINALS & CONNECTORS

175 of the most popular terminals in a shatterproof nylon box.



EC01350

TERMINALS & CONNECTORS W/CRIMP TOOL

30 pc. terminal assortment packed with crimp tool/wire cutter. Attractive 5 compartment clamshell fits neatly in tool box or glove compartment.

Handy for emergencies. Perfect for the do-it-yourselfers.

LOCKS & LATCHES



MP49410-1**

MP49412 (Bulk 100pcs./carton)

- Turn to open mechanism – no finger pull
- Can be locked or left in latch only position
- Totally corrosion resistant
- Black glass reinforced polyester
- Supplied with 2 keys
- 1" hole size - 1" depth
- 3/4" panel thickness



MP49430**

MP49432 (Bulk 100pcs./carton)

- Turn to open mechanism – no finger pull
- Non-Locking version
- Totally corrosion resistant
- Black glass reinforced polyester
- 1" hole size - 1" depth
- 3/4" panel thickness



MP50560**

MP50562 (Bulk 100pcs./carton)

- Black sculpted knob
- Turn to open mechanism – no finger pull
- Can be locked or left in latch only position
- Totally corrosion resistant
- Black glass reinforced polyester
- Supplied with 2 keys
- 1" hole size - 1" depth
- 3/4" panel thickness

** Display Packaged

LOCKS & LATCHES



Secure lockers, hatches, compartments and drawers. 1001 uses. 5 sizes available.

- 3/4" hole size
- +/- 1/4" offset
- 1 1/4" grip length from center of hole.

CAM LOCKS

SIZE	PART #
3/8" DEPTH	CL49300**
5/8" DEPTH	CL49310 **
7/8" DEPTH	CL49320**
1-1/8" DEPTH	CL49330**
1-1/8" DEPTH	CL52922 (Bulk - 100 pcs)
1-1/8" DEPTH	CL49330KA**
1-3/8" DEPTH	CL49332 (Bulk - 100pcs)

LIFT LATCH

Dozens of applications: bait lockers, fish wells, equipment lockers, hatches, storage compartments. Locking and non-locking styles available. Plate/ring are stainless steel. Holes for #8 mounting screws are 1.5" (w) and 1.312" (h) on center. 3/4" hole size.



MP49500 Non-locking hatch lift only. Measures 2.16" x 1.90" x.25"(h)

HEAVY DUTY DOCKING LIGHTS



Recess 5 1/8"

Protect your boat from damage while docking at night!

- ✗ 30,000 cp. bulb illuminates below the declivity. Makes nighttime docking **SAFE & EASY!**
- ✗ Newly-designed housing is **FULLY** sealed! Water cannot enter hull through Docking Light! Old-style O-ring no longer needed to seal hull.
- ✗ **ALIGN & CHANGE** Eyeball from **EXTERIOR** of the hull. Just loosen set screw to align or change Eyeball.
- ✗ **ELIMINATES** the need for access to the rear of the installed Docking Light!
- ✗ New Eyeball **WILL** fit into "old-style" Docking Light housing!
- ✗ New-style housing will fit existing cut-out with only slight modification.
- ✗ Mil-Spec sealed **Waterproof/Dustproof** rocker switch panel included.
- ✗ US Patent #5672004
- ✗ **Intended for Docking Only, Not for Continuous Use.**

DOCKING LIGHTS			
PART #	DESCRIPTION	COLOR	WATTS
95001	12v Marine Docking Light Set - Incandescent Bulb (Set of 2)	White	100
95002	12v Marine Replacement Light for 95001 (bulb w/ eyeball)		
95013	28v Marine Docking Light Set - Incandescent Bulb (Set of 2)	White	50
95004	28v Marine Replacement Light for 95013 (bulb w/ eyeball)		
95016	12v Marine Replacement Light for 95021 (bulb w/ eyeball)	-	100
AUXILIARY LIGHTS			
95011	12v Single Light Kit - Halogen Bulb (Set of 1)	White	100
95026	12v Marine Docking Light Set - Halogen Bulb (bulb w/ eyeball)		
PARTS			
95005	Housing	White	--
95006	Hardware Kit	-	--

POWER POLE REPLACEMENT PUMPS



18-6818
TRIM MOTOR
Replaces:
Power Pole PUMP SPN-F
Fits: Power Pole Sportsman Models



18-6819
TRIM MOTOR
Replaces:
Power Pole PUMP PRO-F
Fits: Power Pole Pro Models

** Display Packaged

NEW



EA01000**
USB CHARGER W/ VOLTMETER AND GRAPH DISPLAY

- Fits perfect with Contura rocker switch panels
- Modern, curved panel design
- USB Charger and Voltmeter included
- CE Certified
- Water-tight mounting gasket included

Dimensions: 114mm x 58mm
Mounting Depth: 56mm
Panel Cut-Out: 105mm x 45mm

NEW



EA01010**
12V AUX POWER SOCKET W/ VOLTMETER AND GRAPH DISPLAY

- Socket panel
- Contura Rocker Switch Panels.
- Modern, curved panel design
- IP66 Rated protects against strong water jets
- CE Certified
- Water-tight mounting gasket included

Dimensions: 114mm x 58mm
Mounting Depth: 56mm
Panel Cut-Out: 105mm x 45mm

NEW



EA01020**
VOLTMETER PANEL, WEATHER RESISTANT

- Weather resistant volt meter panel with 3-digit LED display.
- Modern, curved panel design
- Digital volt meter features a 3 digit LED display
- Backlit label allows for easy readability in darkness
- Fits perfect with Contura rocker switch panels
- CE Certified. IP66 Rated

Dimensions: 114 x 54 x 75mm
Input Range: 2.5-30VDC
Mounting Depth: 75mm
Panel Cut-Out 105mm x 45mm

NEW



EA01050**
12VDC AUX POWER SOCKET, ILLUMINATED

- Watertight cap
- Twist locks system securely locks plug into socket
- Quick Connect 1/4" Terminals
- 9-36V 20A Rated
- Flame retardant Nylon reinforced enclosure
- 1 1/8" Diameter Cut-Out Dimensions

NEW



EA01100**
12VDC AUX POWER SOCKET, ILLUMINATED, CURVE MOUNT

- Mounted vertically, horizontally, or underneath a dash.
- Watertight cap
- Quick Connect 1/4" Terminals
- 9-36V 20A Rated
- Flame retardant Nylon reinforced enclosure
- Surface-Mount allowing easy installation on any surface (no cut-out hole required!)

NEW



EA01040**
BUZZER, STAINLESS STEEL W/ FLASHING LED WARNING

- 80dB warning buzzer with flashing red LED halo
- IP50 Rated
- 12VDC Rated

NEW

- Compact Size
- Digital LED 3-digit display
- Self-powered from DC Voltage being measured
- Floating decimal point for better resolution below 10V
- IP67 Rated, Completely Sealed
- Reverse polarity protection
- 2-Wire Design



EA01070**
VOLTMETER, DIGITAL

- Fits a standard 1 1/8" Cutout



EA0180**
VOLTMETER, DIGITAL, SWITCH MOUNT

- Fits in standard Contura switch cutout



EA01090**
VOLTMETER, DIGITAL, GRAPH DISPLAY

- Battery Level Display around the circumference of the display
- Fits a standard 1 1/8" Cutout

Voltage Range	Current	Sampling Rate	Resolution
2.5-3.0	< 30mA	20ms	0.01V

** Display Packaged

SOLENOIDS



- BA58050**
- Steel housing copper contacts
 - 12 Volts insulated
 - Intermittent rating:
 - 750 amp make
 - 100 amp break
 - 10 seconds ON
 - 20 minutes OFF



- 18-5840**
- Steel housing copper contacts
 - 12 Volts grounded
 - Continuous rating:
 - 85 amp @ 12 VDC



- BA58003**
- Use as battery isolation switch
 - Steel housing copper contacts
 - 12 Volts insulated
 - Continuous rating:
 - 80 amp @ 12 VDC
 - Intermittent rating:
 - 750 amp make
 - 100 amp break
 - 10 seconds ON
 - 30 minutes OFF



- BA58010**
SOLENOID SWITCH
- Weather resistant plastic coating
 - Composite mounting bracket
 - 12 V insulated
 - Rated 85 A continuous duty



- BA58020**
- Motor reversing
 - Dynamic braking when both coils are in same electrical state
 - 12/24V DC
 - Intermittent rating: 150A
 - Continuous rating: 75 amp (5 min.)

BATTERY ACCESSORIES



BATTERY CABLES
Gauge cable with soldered lug terminals on each end to accept a 3/8" stud.

PART #	SIZE	COLOR	GAUGE	PART #	SIZE	COLOR	GAUGE
BC86523	2'	RED	4	BC86563	6'	RED	2
BC86533	2'	BLACK	4	BC86573	6'	BLACK	2
BC86543	4'	RED	2	BC86583	8'	RED	1
BC86553	4'	BLACK	2	BC86593	8'	BLACK	1



BT44430
LEAD UNIVERSAL BATTERY TERMINAL

MISCELLANEOUS ACCESSORIES

- Total current of 3.15A delivers fast charging times even in extreme temperatures
- Designed to charge tablets, e-readers, mobiles, gaming devices, cameras, and many other compatible devices
- Integrated over-current and thermal overload protection to safeguard electronics
- Center Green LED indicated charging status
- Fits industry standard 1.45" x 0.83" panel cutout for effortless installation
- Curved access doors for stylish look
- Sealed up to IP65 for above-panel components
- Panel seal prevents water ingress beneath panel to protect critical connections
- Designed for 12V and 24V operation"



AP10010**
DUAL PORT USB 2.0 CHARGER
CURVED DOOR



AP10020**
DUAL PORT USB 2.0 CHARGER
SQUARE DOOR

** Display Packaged



Sierra
Marine Engine and Drive Parts



SHIELDS HOSES

Each Shields hose is designed for a specific application and meets strict standards set by the USCG, ABYC and other regulatory agencies.

Four of our marine exhaust hoses have qualified for Lloyd's Register Type Approval, meeting the highest standards of production quality..



THE VERY BEST PARTS OF BOATING

Product Application Guide

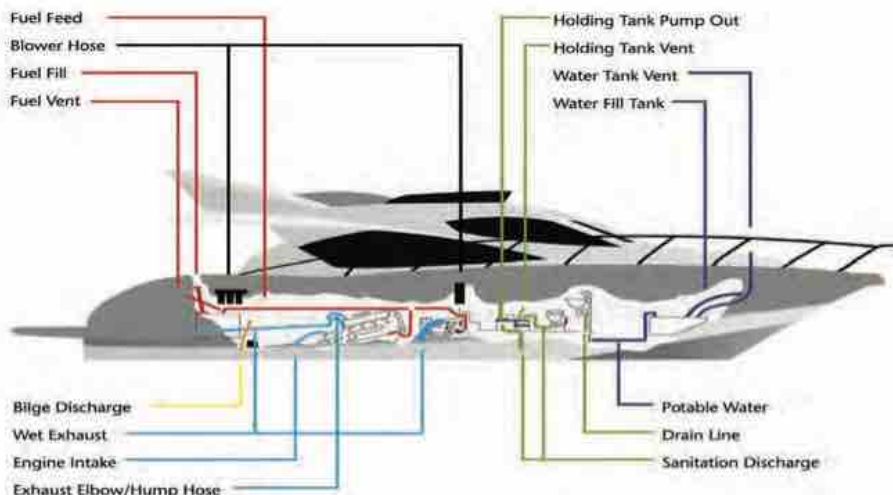

PRODUCT APPLICATION GUIDE KEY

- E** — Designed to give excellent service
G — Designed to give good service in normal applications
C — Product can give good service with proper installation, may not be suitable in all applications.
X — Not recommended
NA — Not available in size range
1 — Can easily be bent into tight radius
2 — Can be bent into gradual radius
3 — May kink in applications requiring bend radius

SERIES NO.	NAME	PG. NO.	SIZE RANGE	APPLICATION							
				Submersible Bilge Pump	Remote Bilge Pump	Hand Bilge Pump	Livewell Inlet	Livewell Drain Above Water Line	Livewell Drain Below Water Line	Flexibility	
 BILGE/LIVEWELL											
Series 120	Shields Bilgeflex	83	5/8" - 1 1/2"	G	X	C	X	X	X	1	
Series 123	Shields Bilgevac	83	3/4" - 1 1/8"	EX	G	EX	X	C	X	1	
Series 140	Shields Vac Std.	84	1 1/4" - 1 1/2"	EX	EX	EX	G	G	C	1	
Series 141	Shields Multiflex	85	5/8" - 3"	EX	G	EX	X	G	X	1	
Series 142	Shields Vac Cuffs	84	1 1/4" - 1 1/2"								
Series 146	Shields Vac Extra Heavy										
	Duty/Commercial Grade	85	5/8" - 3"	EX	EX	EX	EX	EX	EX	2	
Series 147	Shields Vac H.D. Cuffs	84	1 1/2"								
Series 148	Shields Vac Extra Heavy Duty	86	5/8" - 1 1/2"	EX	EX	EX	EX	EX	EX	2	
Series 149	Shields Livewell Hose	86	5/8" - 1 1/2"	EX	EX	EX	EX	EX	EX	1	

SERIES NO.	NAME	PG. NO.	SIZE RANGE	APPLICATION					Flexibility
				Engine Intake	Generator Intake	Engine Coolant Hose Straight or Limited Bend	Engine Coolant Hose Severe Bend	Exhaust Water Injection	
 ENGINE HOSE									
Series 130	Shields #1300 Heater Hose	87	1/2" - 3/4"	X	X	G	X	X	3
Series 135	Shields #1350 H.D. Water Hose	87	1/2" - 1"	X	C	G	X	G	3
Series 160	Shields #1600 Water Hose	87	3/8" - 1 1/4"	X	G	EX	X	G	2
Series 200	Shields Marine Exhaust	88	1/2" - 14"	X	C	EX	X	G	3
Series 202	Shields Nautiflex Silicone Exhaust Hose	89	1" - 14"	X	X	EX	X	C	3
Series 250	Shieldsflex II	90	1/2" - 8"	EX	EX	EX	EX	EX	2
Series 252	Shieldsaust - C	91	3/4" - 8"	EX	EX	EX	EX	EX	1
Series 254	Shields ExoFlex	81	3/4" - 8"	EX	EX	EX	EX	EX	1
Series 262	Shields Corrugated Nautiflex								
	Silicone Exhaust Hose	92	3/4" - 10"	EX	EX	EX	EX	EX	1
Series 321	Shields Comflex All in One Hose	93	5/8" - 2"	EX	EX	EX	EX	EX	2

Product Application Guide (Cont.)

SERIES NO.	NAME	PG. NO.	SIZE RANGE	APPLICATION							
				Non-Pressurized Supply	Pressurized Supply		Water Tank Fill	Drain Lines Below Water Line	Drain Lines To Sump or Above Water Line	Water Tank Vent	Flexibility
					Hot	Cold					
 FRESH WATER SYSTEM/POTABLE											
Series 141	Shields Multiflex	94	5/8" - 3"	C	X	X	EX	X	EX	C	1
Series 148	Shields Vac Extra Heavy Duty	94	5/8" - 1 1/2"	N/A	X	X	EX	EX	EX	EX	2
Series 149	Shields Livewall Hose	95	5/8" - 1 1/2"	X	X	X	X	EX	EX	C	2
Series 150	Shields PVC Tubing — Clear	95	3/16" - 1 1/2"	G	X	X	C	X	G	G	3
Series 162	Shields All Clear Reinforced PVC — Red Tracer	96	3/8" - 1 1/2"	EX	EX	EX	G	G	G	G	2
Series 163	Shields Braided Wash Down Hose	96	5/8"								
Series 164	Shields Clear White Reinforced PVC — Blue Tracer	97	1/2" - 3/4"	EX	G	EX	N/A	G	G	G	3
Series 168	Shields Heavy Duty Reinforced PVC Tubing	97	1/4" - 1 1/2"	EX	EX	EX	G	EX	EX	EX	2

SERIES NO.	NAME	PG. NO.	SIZE RANGE	APPLICATION						
				Oil Tank Fill	Fuel Tank Fill	Fuel Feed Inboard/Outboard	Fuel Feed Outboard	Fuel Tank Vent Inboard	Fuel Tank Vent Outboard	Flexibility
 FUEL SYSTEM										
Series 309	Shields Oil Tank Fill Hose	98	1 1/2"	EX	X	N/A	N/A	N/A	N/A	1
Series 315	Shields 315 - Silverado 2000	98	3/8" - 5/8"	N/A	N/A	X	EX	C	EX	2
Series 337	Shields Silverado 4000	99	5/16" - 3/8"	N/A	N/A	X	EX	N/A	N/A	1
Series 350	Shields FIRE-ACOL	100	1 3/8" - 2 3/8"	EX	EX	N/A	N/A	N/A	N/A	1
Series 351	Shields FIRE-ACOL-C	100	1 1/2"	EX	EX	N/A	N/A	N/A	N/A	1
Series 355	Shields Fuel Fill	101	1 1/2" - 2"	EX	EX	N/A	N/A	N/A	N/A	1
Series 365	Shields FIRE-ACOL-15	101	3/8" - 1/2"	N/A	N/A	EX	EX	N/A	N/A	1
Series 375	Shields Fire Sleeve	82	3/8"	N/A	N/A	EX	N/A	N/A	N/A	1
Series 368	Shields Low Permeation Marine Fuel Hose	102	1/4" - 1/2"	N/A	N/A	EX	EX	N/A	N/A	1
Series 369	Shields FIRE-ACOL Fuel Vent Hose	102	5/8"	N/A	N/A	X	X	EX	EX	1
Series 321	Shields Complex All in One Hose	103	3/8" - 2"	EX	EX	C	X	EX	X	1
Fuel Accessories	Ferrule Vise / Dies	104	1/4" - 1/2"	For making fuel line assemblies without clamps						
Fuel Accessories	Shields Brackets / Filters / Fuel Line Assemblies	105								

SERIES NO.	NAME	PG. NO.	SIZE RANGE	APPLICATION					
				Toilet to Holding Tank	Holding Tank Pump Out	Holding Tank to Overboard Discharge	Toilet Water Inlet	Holding Tank Vent	Flexibility
 SANITATION SYSTEM									
Series 101	Shields Sanitation Hose	106	1" & 1 1/2"	EX	EX	EX	N/A	N/A	1
Series 105	Shields Poly X Sanitation Hose	106	1" & 1 1/2"	EX	EX	EX	N/A	N/A	1
Fittings	Shields For Series: 101, 105, 144, 148	106	3/4" - 1 1/2"						
Series 144	Shields Super PVC Sanitation	107	1" & 1 1/2"	EX	EX	EX	N/A	N/A	2
Series 146	Shields Vac Extra Heavy Duty/Industrial	107	5/8" - 3"	G	EX	G	EX	EX	2
Series 148	Shields Vac Extra Heavy Duty	108	3/8" - 1 1/2"	G/EX	EX	EX	EX	EX	2
Series 250	Shieldsflex II	109	1/2" - 8"	EX	EX	EX	EX	EX	2
	Shields Sanitation System Cleaners	108	1 Gallon	Cleans contaminants that restrict system performance					

SERIES NO.	NAME	PG. NO.	SIZE RANGE	APPLICATION		
				Blower Hose	AC Duct	Exhaust Vent Above Head
 VENTILATION/ AC DUCT						
Series 400	Shields Vinylvent	110	3" - 4"	EX	X	X
Series 402	Shields Vinylvent	110	3" - 4"	EX	X	X
Series 420	Shields Extra Heavy Duty Vinylvent	110	3" - 4"	EX	X	G
Series 450	Shields Fibervent	111	3" - 6"	EX	G	EX
Series 460	Shields AC Ducting Hose	111	3" - 7"	EX	EX	EX

Product Application Guide (Cont.)

SERIES NO.	NAME	PG. NO.	SIZE RANGE	APPLICATION				
				Straight Pipe Connector Less than 4" I.D. of Hose	Straight Pipe Connector More than 4" I.D. of Hose	Requires Moderate Bend	Severe Bend	Flexibility
 WET EXHAUST SYSTEM								
Series 200	Shields Marine Exhaust	112	1/2" - 14"	EX	C	X	X	3
Series 202	Nautiflex Silicone Exhaust Hose	113	1" - 14"	EX	C	X	X	3
Series 250	Shieldsflex II	114	1/2" - 8"	EX	EX	EX	C	2
Series 252	Shieldsaust - C	115	3/4" - 8"	EX	EX	EX	EX	1
Series 254	Shields ExoFlex	81	3/4" - 8"	EX	EX	EX	EX	1
Series 262	Corrugated Nautiflex Silicone Exhaust Hose	116	3/4" - 16"	EX	EX	EX	EX	1
Series 321	Shields Comflex All in One Hose	117	5/8" - 2"	EX	EX	EX	C	2
Various	Hump Hose & Elbows	118-121	2" - 10"	See our selection for straight or angled connections				

SERIES NO.	NAME	PG. NO.	SIZE RANGE	APPLICATION
MISCELLANEOUS				
	Exhaust Protector Valves	122	4" - 6"	Prevents water from entering exhaust system
	Hose Clamps	122	5/16" - 7"	Marine grade 316 stainless steel
	Exhaust Hose Clamps - T-Bolt Band Clamps	122	1" - 14"	Designed to fit Shields Series: 200, 201, 210, 250, 252
Series 128	Flame Retardant Split Wire Conduit	123	1/4" - 2"	Provides chafing protection for wiring systems
Series 129	Expandable Braided Sleeving (Scissor Cut)	123	1/2" - 2"	Conduit designed to be cut with scissors
Series 126	Shields Sternflex	124	2"	Provides protection for outboard rigging cables & hose
	Neoprene Sheet Rubber	125	1/8" - 1/4"	Used under fuel tanks to comply with USCG requirements
Series 151	Speedometer Pitot Tubing	125	1/8" - 4mm	Connection from pitot to speedometer
Series 157	LLDPE Tubing	82		Transfer of air and liquids in industrial applications



SHIELDS CODE NUMBERS

All Shields Marine Hoses are identified by a 9 digit code number.

Example:

16-120-0580

The first two digits identify the product as a Shields hose:
16 = Shields Hose

The third three digits identify the size of the hose:
058 = 5/8"

The second three digits identify the type of hose:
120 = Bilflex

The last digit identifies the package quantity as follows:

- 1 — 6' or 6 1/2' Length
- 2 — 9' Length
- 3 — 10' Length
- 4 — 12 1/2' Length
- 5 — 25' Length
- 6 — 50' Length
- 7 — 100' Length
- 8 — 75' Length
- 0 — Standard Bulk Pack
- 0-xx — Special Bulk Length (Example: 0-36 = 3')

SHIELDS EXOFLEX 254 SERIES MARINE WET EXHAUSE/WATER HOSE



Shields Marine ExoFlex Hose has a EPDM cover and is constructed of synthetic plies with steel wire helices. It is black corrugated material is very flexible with a 1.5" x ID" radius. ExoFlex hose is suitable for delivery of cooling water and exhaust gas. Tighter corrugations allow for optimal clamp locations. The hose is resistant to ozone and abrasions as well as heat and saltwater. This hose is Lloyd's approved. The temperature ranges from -22°F – + 212°F with peaks to 239°F. The hose meets SAE J2006 Type 2 standards.



Now double the ozone resistance required by SAEJ2006

NEW

I.D.	Bend Radius	50' Coil Code #	12 1/2' Coil Code #	6 1/4' Coil Code #
3/4"	1 1/8"	16-254-0340	16-254-0344	—
1"	1 1/2"	16-254-1000	16-254-1004	16-254-1001
1 1/4"	1 7/8"	16-254-1140	16-254-1144	—
1 1/2"	2 1/4"	16-254-1120	16-254-1124	—
1 5/8"	2 7/16"	16-254-1580	16-254-1584	—
1 3/4"	2 5/8"	16-254-1340	16-254-1344	—
2"	3"	16-254-2000	16-254-2004	16-254-2001
2 1/4"	3 3/8"	16-254-2140	16-254-2144	16-254-2141
2 3/8"	3 9/16"	16-254-2380	16-254-2384	—
2 1/2"	3 3/4"	16-254-2120	16-254-2124	16-254-2121
3"	4 1/2"	16-254-3000	16-254-3004	16-254-3001
3 1/2"	5 1/4"	16-254-3120	16-254-3124	16-254-3121
4"	6"	16-254-4000	16-254-4004	16-254-4001
4 1/2"	6 3/4"	16-254-4120	16-254-4124	16-254-4121
5"	7 1/2"	—	16-254-5004	16-254-5001
6"	9"	16-254-6000	16-254-6004	—
8"	12"	—	16-254-8004	16-254-8001



This certification provides unbiased, third party confirmation worldwide that these Shields hoses meet the highest standards of production quality. Certification ensures the proper level of product safety and inspires user confidence.

SHIELDS FUEL FEED LINE WITH FIRE SLEEVE

NEW

I.D.	Length	Code No.
3/8"	36"	16-375-0380-96
3/8"	96"	16-375-0380-96
3/8"	30"	16-375-0380-30

Shields Stainless Steel Braided PTFE hose is an ideal choice for marine applications. The Fire Sleeve includes a straight quick connector and fire sleeve. This hose is designed to dissipate any potential static charges for added safety. It is compatible with a wide range of chemicals and additives, and is not affected by heat aging, ozone or UV exposure. Operating temperature ranges from -60°C to +260°C.

CFR 33 USCG Approved. Ultra low Permeation.



SHIELDS NATURAL LLDPE TUBING

NEW

I.D.	Length	Code No.
1/2"	100'	16-157-0120
3/8"	100'	16-157-0380

Shields Natural LLDPE Tubing is useful for the transfer of air and liquids in industrial applications such as fiberglass hull production, water and water softener lines and vending equipment. This hose is flexible and lightweight and comes in a natural color. It's linear low-density polyethylene has a superior chemical and moisture resistance. Operating temperature ranges from -50°C to +125°F.

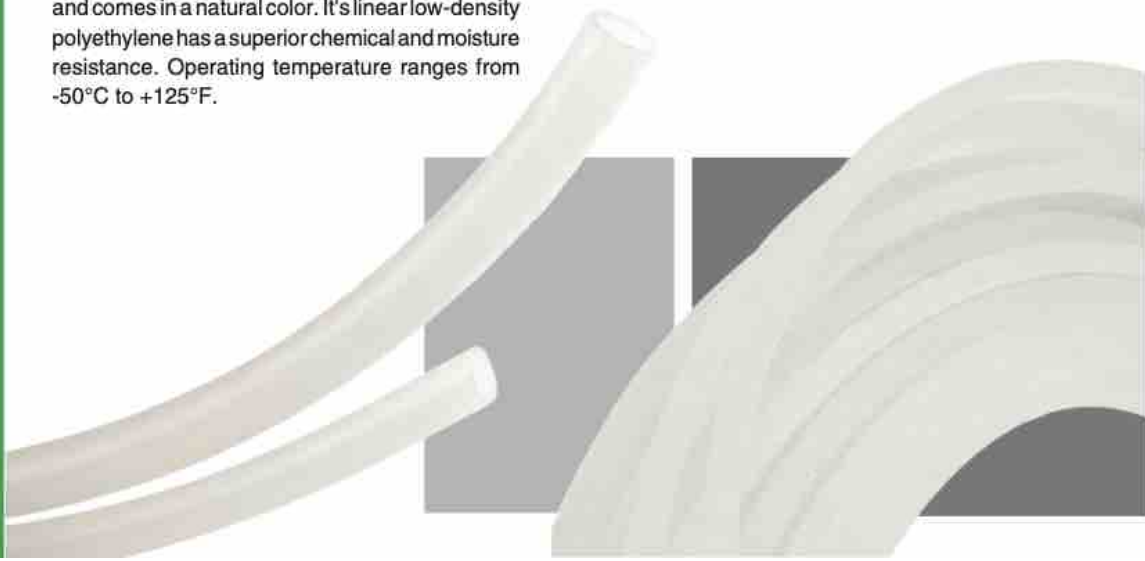

SHIELDS BILGEFLEX



Shields Bilgeflex Hose is a single layer corrugated polyethylene hose. It is resistant to mild chemicals and salt water and there is a clamping cuff every foot. It is available in black or white (add B or W to suffix to specify color). This hose is primarily used for bilge pump discharge.

Do not attach to thru hull fitting below the water line.



I.D.	mm	Bend		Vac Rating	Wt. "C"	Code # *	Bulk Pack	m	50' (15.2m)	Dist. Pkg.	6' (1.8M)	25' (7.6M)
		Radius	mm						R/O Ctn.	9' (2.7M)	Polypac Code #	R/O Ctn.
5/8"	15.9	1/2"	12.7	20	5	16-120-0580	600'	182.9	16-120-0588	16-120-0582	16-120-0581	—
3/4"	19.1	3/4"	19.1	20	6	16-120-0340	500'	152.4	16-120-0346	16-120-0342	16-120-0341	—
1 1/8"	28.6	1"	25.4	20	7	16-120-1180	300'	91.4	16-120-1186	16-120-1182	16-120-1181	—
1 1/4"	31.8	1 1/2"	38.1	20	10	16-120-1140	200'	61.0	16-120-1146	—	—	—
1 1/2"	38.1	2"	50.8	20	13	16-120-1120	150'	45.7	16-120-1126	—	—	16-120-1125

* Add B or W suffix to specify black or white

SHIELDS BILGEVAC



Shields Bilgevac Hose is a black PVC hose with a flexible vinyl helix. It is very flexible, abrasion resistant and is resistant to mild chemicals and saltwater. This hose is primarily used for bilge pump discharge and drains (sinks, shower, scupper, and livewell). **Do not attach to thru hull fitting below the water line.**

I.D.	mm	Bend		Wt. "C"	Bulk Pack	Dist. Pkg.
		Radius	mm		100' (30.5m)	50' (15.2m)
3/4"	19.1	3/4"	50.8	8	16-123-0340	16-123-0346
1 1/8"	28.6	1"	76.2	16	16-123-1180	16-123-1186



SHIELDS VAC STANDARD



Shields Vac Standard Hose is PVC supported by vinyl covered steel wire and is very flexible. It is Nylon reinforced and is resistant to mild chemicals and saltwater. This hose is primarily used for bilge pump intake and discharge, diaphragm style hand operated bilge pump intake and discharge and drains (sinks, shower, and scupper). This hose uses 142 left hand thread cuffs. **Do not attach to thru hull fitting below the water line.**

I.D.	mm	Bend Radius	mm	Vac Rating	Wt. "C"	Bulk Pack Code #	Dist. Pkg. 50' (15.2m) R/O Ctn. Code #
1 1/4"	31.8	3/4"	19.1	28	19	16-140-1140	16-140-1146
1 1/2"	38.1	7/4"	19.1	28	23	16-140-1120	16-140-1126

① 2 x 50' per box



SHIELDS VAC CUFFS

Shields Vac Cuffs provide added clamping protection for Shields Vac Hose. For watertight seal apply with sealing compound. Use with Series 140 & 141. Glue using PVC cement.



Size	mm	Wt. "C"	Code No.	For	Thread
1 1/4"	31.8	12.5	16-142-1140	Series 140	Left Hand
1 1/2"	38.1	13.0	16-142-1120	Series 140	Left Hand
1 1/2"	38.1	13.0	16-147-1120	Series 141	Right Hand

SHIELDS MULTIFLEX



Shields Multiflex Hose has a clear FDA formula PVC with black vinyl helix. It is abrasion resistant, flexible and is resistant to mild chemicals and saltwater. This hose is primarily used for bilge pump discharge, potable water tank fill and drains (sinks, shower, livewell and scupper). This hose uses 147 right hand thread cuffs. **Do not attach to thru hull fitting below the water line. Do not use ethylene glycol based antifreeze in hose.**

I.D.	mm	Bend Radius	mm	Wt. "C"	Bulk Pack 100' (30.5m) Coil Code #	Dist. Pkg. 50' (15.2m) R/O Ctn. Code #	10' (3.1m) Length Code #
5/8"	15.9	1 1/2"	12.7	8	16-141-0580B	16-141-0586B	—
3/4"	19.1	2 1/4"	19.1	10	16-141-0340B	16-141-0346B	—
1"	25.4	3 1/2"	22.2	13	16-141-1000B	16-141-1006B	—
1 1/8"	28.6	4 1/2"	25.4	16	16-141-1180B	16-141-1186B	—
1 1/4"	31.8	5 1/2"	38.1	19	16-141-1140B	16-141-1146B	—
1 1/2"	38.1	6 1/2"	50.8	24	16-141-1120B	16-141-1126B	—
2"	50.8	8"	127.0	34	16-141-2000B	—	16-141-2003B
1 1/2"	38.1	2"	50.8	24	16-141-1120W	—	16-141-1123W

SHIELDS VAC EXTRA HEAVY DUTY - INDUSTRIAL GRADE



Shields Vac Extra Heavy Duty/Industrial Grade Hose has a smooth cover and clear FDA formula PVC with a white vinyl helix. It is rated for full vacuum and is resistant to mild chemicals and saltwater. This hose is primarily used for bilge pump intake and discharge, potable water tank fill, drains (sinks, shower, and scupper), livewell intake and drain, and sanitation (intake, vent and pump out). This hose is utilized for below the waterline connections. **Do not use ethylene glycol based antifreeze in hose. Do not use in pressurized water systems.**

I.D.	mm	Bend Radius	mm	Vac Rating	Wt. "C"	Bulk Pack 100' (30.5m) Coil Code #	50' (15.2m) R/O Ctn. Code #	Dist. Pkg. 10' (3.1m) Length Code #
5/8"	15.9	3	76.2	28	15	16-146-0580	16-146-0586	—
3/4"	19.1	3	76.2	28	16	16-146-0340	16-146-0346	—
1"	25.4	3	76.2	28	27	16-146-1000	16-146-1006	—
1 1/8"	28.6	4	101.6	28	25	16-146-1180	16-146-1186	—
1 1/4"	31.8	3	76.2	28	30	16-146-1140	16-146-1146	—
1 1/2"	38.1	4	101.6	28	40	16-146-1120	16-146-1126	—
2"	50.8	5	127.0	28	57	16-146-2000	—	16-146-2003
2 1/2"	63.5	7	177.8	28	74	16-146-2120	—	16-146-2123
3"	76.2	9	228.6	28	94	16-146-3000	—	16-146-3003

SHIELDS VAC EXTRA HEAVY DUTY/FDA



Shields Vac Extra Heavy Duty/FDA Hose has a smooth white FDA grade PVC with vinyl helix. It is rated for full vacuum and is resistant to mild chemicals, permeation, and saltwater. This hose is primarily used for bilge pump intake and discharge, drains (sinks, shower, and scupper), livewell intake and drain, potable watertank fill, and sanitation (toilet holding tank, intake, self draining lines vent and pump out). This hose is resistant to odor permeation. **Do not use ethylene glycol based antifreeze in hose. Do not use in pressurized water systems.**

I.D.	mm	Bend Radius	mm	Vac Rating	WL "C"	Bulk Pack 100' (30.5m) Coil Code #	Dist. Pkg. 50' (15.2m) R/O Ctn. Code #	25' (7.6m) R/O Ctn. Code #
5/8"	15.9	3	76.2	28	15	16-148-0580W	16-148-0586W	—
3/4"	19.1	3	76.2	28	20	16-148-0340W	16-148-0346W	—
1"	25.4	3	76.2	28	27	16-148-1000W	16-148-1006W ①	—
1 1/8"	28.6	4	101.6	28	29	16-148-1180W	16-148-1186W	—
1 1/4"	31.8	4	101.6	28	31	16-148-1140W	16-148-1146W	—
1 1/2"	38.1	5	127.0	28	40	16-148-1120W	16-148-1126W ①	16-148-1125W

① WARNING: Lines containing raw sewage should be plumbed to be self-draining.

SHIELDS LIVEWELL HOSE



Shields Livewell Hose has a black smooth cover with vinyl helix. It is rated for full vacuum and is resistant to mild chemicals and saltwater. This hose is primarily used for bilge pump intake and discharge, drains (sinks, shower, and scupper), livewell intake and drain, and sanitation (intake and vent). This hose is utilized for below the waterline connections. **Do not use ethylene glycol based antifreeze in hose.**

I.D.	mm	Bend Radius	mm	Vac Rating	WL "C"	Bulk Pack 100' (30.5m) Coil Code #	Dist. Pkg. 50' (15.2m) R/O Ctn. Code #
5/8"	15.9	3	76.2	28	15	16-149-0580	16-149-0586
3/4"	19.1	3	76.2	28	16	16-149-0340	16-149-0346
1"	25.4	3	76.2	28	24	16-149-1000	16-149-1006
1 1/8"	28.6	4	101.6	28	25	16-149-1180	16-149-1186
1 1/4"	31.8	4	101.6	28	28	16-149-1140	16-149-1146
1 1/2"	38.1	5	127.0	28	39	16-149-1120	16-149-1126

SHIELDS 1300/1350 WATER/HEATER HOSE



Shields 1300/1350 Water / Heater Hose is fabric reinforced and has an EPDM tube and cover. This hose is primarily used for engine heater hose, heat exchanger, A/C circulation, and drain lines (sink, icebox, shower and livewell). It is resistant to mild chemicals, heat, cold, ozone and saltwater. The temperature ranges from -40°F – +212°F.

SHIELDS 1300 Water/Heater Hose

I.D.	mm	O.D.	mm	Working Pressure	Wt. "C"	Bulk Pack Code #	m	Bulk Pack 50' (15.2m) R/O Ctn. Code #	Dist. Pkg. 25' (7.6m) R/O Ctn. Code #
1/2"	12.7	3/4"	18.69	62 PSI	17	16-130-0120 (500' reel)	152.4	16-130-0126	—
5/8"	15.9	7/8"	22.3	62 PSI	21	16-130-0580 (500' reel)	152.4	16-130-0586	16-130-0585
3/4"	19.1	1"	25.48	50 PSI	26	16-130-0340 (500' reel)	152.4	16-130-0346	16-130-0345

SHIELDS 1350 HEAVY DUTY Water/Heater Hose

I.D.	mm	O.D.	mm	Working Pressure	Wt. "C"	Bulk Pack Code #	m	Dist. Pkg. 50' (15.2m) R/O Ctn. Code #
1/2"	12.7	13/16"	20.6	200 PSI	19	16-135-0120 (550' reel)	167.6	16-135-0126
5/8"	15.9	31/32"	24.59	200 PSI	26	16-135-0580 (450' reel)	137.2	16-135-0586
3/4"	19.1	1 1/16"	28.4	200 PSI	33	16-135-0340 (400' reel)	121.9	16-135-0346
1"	25.4	1 3/16"	36.6	150 PSI	52	16-135-1000 (300' reel)	91.4	16-135-1006

SHIELDS 1600 WATER/HEATER HOSE

Shields 1600 Water/Heater Hose has a good bend radius, is fabric reinforced, and has an EPDM tube and cover. This hose is primarily used for critical water connections, heat exchanger, toilet intake, small engine intake, bilge pump intake/discharge, and below water line drains and scuppers. It is resistant to mild chemicals, heat, cold, ozone and saltwater. The temperature ranges from -40°F – +190°F



I.D.	mm	O.D.	mm	Working Pressure	Wt. "C"	Bulk Pack Code #	m	Dist. Pkg. 50' (15.2m) R/O Ctn. Code #
3/8"	9.5	45/64"	17.8	300 PSI	17	16-160-0380B (500' reel)	152.4	16-160-0386B
1/2"	12.7	27/32"	21.3	300 PSI	22	16-160-0120B (450' reel)	137.2	16-160-0126B
5/8"	15.9	1"	25.4	300 PSI	28	16-160-0580B (400' reel)	121.9	16-160-0586B
3/4"	19.1	1 5/16"	28.8	300 PSI	34	16-160-0340B (300' reel)	91.4	16-160-0346B
1"	25.4	1 23/64"	36.8	300 PSI	52	16-160-1000B (250' reel)	76.2	16-160-1006B
1 1/4"	31.8	1 3/4"	44.5	200 PSI	62	16-160-1140B (200' reel)	61.0	16-160-1146B

SHIELDS MARINE EXHAUST/WATER HOSE (No Wire)



Shields Marine Exhaust / Water Hose is reinforced with 2 or 4 plies of synthetic cord and is made of black, heavy-walled synthetic rubber. This hose is primarily used for straight connections in wet exhaust systems and engine water circulation lines. It is resistant to engine heat, exhaust fumes, ozone, mild chemicals, antifreeze and saltwater. This hose also has double the ozone resistance required by SAEJ2006. The temperature ranges from -20°F – + 200°F continuous, +250°F intermittent. The hose meets SAE J2006 Type R1 standards.



Now double the ozone resistance required by SAEJ2006



This certification provides unbiased, third party confirmation worldwide that these Shields hoses meet the highest standards of production quality. Certification ensures the proper level of product safety and inspires user confidence.

I.D.	mm	O.D.	Ply	Wt. "C"	50' Coil Code #	12 1/2' Length Code #	6 1/4' Length Code #
1/2"	13	7/8"	2	24	16-200-0120	16-200-0124	16-200-0121
5/8"	16	1 1/32"	2	33	16-200-0580	16-200-0584	16-200-0581
3/4"	19	1 1/16"	2	37	16-200-0340	16-200-0344	16-200-0341
7/8"	22	1 3/16"	2	42	16-200-0780	16-200-0784	16-200-0781
1"	25	1 3/8"	2	48	16-200-1000	16-200-1004	16-200-1001
1 1/8"	28	1 7/8"	2	52	16-200-1180	16-200-1184	16-200-1181
1 1/4"	32	1 45/64"	2	60	16-200-1140	16-200-1144	16-200-1141
1 3/8"	33	1 47/64"	2	62	—	—	—
1 1/2"	35	1 13/16"	2	66	16-200-1380	16-200-1384	16-200-1381
1 5/8"	38	1 15/16"	2	70	16-200-1120	16-200-1124	16-200-1121
1 7/8"	42	2 3/32"	2	77	16-200-1580	16-200-1584	16-200-1581
1 3/4"	45	2 19/64"	2	82	16-200-1340	16-200-1344	16-200-1341
1 7/8"	48	2 23/64"	2	96	16-200-1780	16-200-1784	16-200-1781
2"	51	2 31/64"	2	102	16-200-2000	16-200-2004	16-200-2001
2 1/8"	54	2 19/32"	2	107	16-200-2180	16-200-2184	—
2 1/4"	58	2 3/4"	2	114	16-200-2140	16-200-2144	16-200-2141
2 3/8"	60	2 7/8"	2	132	16-200-2380	16-200-2384	—
2 1/2"	63	3"	2	136	16-200-2120	16-200-2124	16-200-2121
2 5/8"	67	3 3/32"	2	147	—	16-200-2584	16-200-2581
2 3/4"	70	3 17/64"	2	152	—	—	16-200-2341
2 7/8"	73	3 7/16"	2	174	—	16-200-2784	16-200-2781
3"	76	3 3/16"	2	182	16-200-3000	16-200-3004	16-200-3001
3 1/8"	80	3 45/64"	2	190	—	16-200-3184	16-200-3181
3 1/2"	90	4 7/32"	2	198	—	16-200-3124	16-200-3121
3 3/4"	95	4 3/32"	2	221	—	16-200-3344	16-200-3341
4"	102	4 17/32"	4	229	—	16-200-4004	16-200-4001
4 1/2"	114	5 1/8"	2	300	—	16-200-4124	16-200-4121
5"	127	5 3/8"	2	332	—	16-200-5004	16-200-5001
5 1/2"	140	6 3/16"	2	396	—	—	—
6"	152	6 11/16"	2	427	—	16-200-6004	16-200-6001
8"	203	8 25/64"	4	670	—	16-200-8004	—
10"	254	10 7/8"	4	934	—	16-200-10004	16-200-10001
12"	305	12 7/8"	4	1095	—	16-200-12004	16-200-12001
14"	350	14 7/8"	4	1430	—	—	—

* Special Order

SHIELDS NAUTFLEX SILICONE EXHAUST HOSE

Wet Exhaust Hose SAE J2006 Type R1

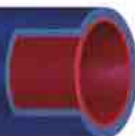

Shields Nautiflex Silicone Exhaust Hose has a blue silicone cover with a smooth finish for easy clean up. This hose is flexible, easy to install and has four plies of synthetic fabric. It also remains stable at elevated temperatures. This hose is primarily used for straight connections in the wet exhaust system and engine water circulation lines. The temperature ranges from -20°F – $+350^{\circ}\text{F}$. The hose meets SAE J2006 Type R1 and ISO 13363:2004 – Type 2 – Class B standards.

I.D.	mm	O.D.	Wt. "C"	3' (.9m) Length Code No.	6' (1.8m) Length Code No.	12' (3.7m) Length Code No.
1"	25	1 ³ / ₈ "	33.1	—	16-202-1001	16-202-1004
1 ¹ / ₈ "	28	1 ¹ / ₂ "	37.2	—	—	—
1 ¹ / ₄ "	32	1 ⁵ / ₈ "	41.3	16-202-1140-36	16-202-1141	16-202-1144
1 ³ / ₈ "	35	1 ³ / ₄ "	45.4	—	—	—
1 ¹ / ₂ "	38	1 ⁷ / ₈ "	49.6	16-202-1120-36	16-202-1121	16-202-1124
1 ³ / ₄ "	45	2 ¹ / ₈ "	57.8	—	—	—
2"	51	2 ³ / ₈ "	66.1	—	16-202-2001	16-202-2004
2 ¹ / ₈ "	60	2 ¹ / ₄ "	78.5	16-202-2380-36	—	16-202-2384
2 ¹ / ₂ "	63	2 ⁷ / ₈ "	82.6	16-202-2120-36	16-202-2121	16-202-2124
2 ³ / ₈ "	67	2 ⁶ / ₁₆ "	86.8	16-202-2580-36	16-202-2581	16-202-2584
2 ³ / ₄ "	70	3 ¹ / ₈ "	90.9	—	—	—
2 ⁷ / ₈ "	73	3 ¹ / ₄ "	94.1	—	—	—
3"	76	3 ³ / ₈ "	99.2	16-202-3000-36	16-202-3001	16-202-3004
3 ¹ / ₈ "	82	3 ¹ / ₂ "	103.4	16-202-3140-36	16-202-3141	16-202-3144
3 ¹ / ₂ "	90	3 ⁷ / ₈ "	115.7	16-202-3120-36	16-202-3121	16-202-3124
4"	102	4 ¹ / ₈ "	132	16-202-4000-36	16-202-4001	16-202-4004
5"	127	5 ³ / ₈ "	165	16-202-5000-36	16-202-5001	16-202-5004
5 ¹ / ₂ "	140	5 ⁷ / ₈ "	181.5	—	—	—
6"	152	6 ¹ / ₈ "	198	16-202-6000-36	16-202-6001	16-202-6004
8"	203	8 ³ / ₈ "	264	16-202-8000-36	16-202-8001	16-202-8004
10"	254	10 ³ / ₈ "	330	16-202-1000036	—	16-202-10004
12"	305	12 ³ / ₈ "	396	16-202-1200036	—	16-202-12004
14"	350	14 ³ / ₈ "	462	16-202-1400036	—	—



SHIELDSFLEX II MARINE WATER/EXHAUST HOSE (w/ Wire)

Shieldsflex II Marine Water/Exhaust Hose has a black synthetic rubber tube and cover. It is reinforced with wire helix imbedded between plies of HD synthetic cord. It is resistant to exhaust fumes, ozone, mild chemicals, antifreeze and saltwater. This hose is abrasion and odor permeation resistant. It now has double the ozone resistance required by the SAEJ2006. Shieldsflex II is primarily used for engine intake, wet exhaust connections (use where bends or long lengths are required), bilge pump intake/discharge, scupper lines, toilet intake/discharge, and holding tank vent/pump out. The temperature ranges from -20° F – +200°F continuous, +250°F intermittent. The hose meets SAE J2006 Type R2 standards. Bend Radius = 5 x I.D.

I.D.	mm	O.D.	Ply	Wt. "C"	50' (15.2m) Coil Code #	25' (7.6m) Cartons	12 1/2' (3.8m) Length Code #	6 1/4' (1.9m) Length Code #
1/2"	13	27/32"	2	24	16-250-0120	16-250-0125	16-250-0124	16-250-0121
5/8"	16	61/64"	2	28	16-250-0580	—	16-250-0584	16-250-0581
3/4"	19	1 1/16"	2	32	16-250-0340	16-250-0345	16-250-0344	16-250-0341
7/8"	22	1 3/16"	2	36	16-250-0780	—	16-250-0784	16-250-0781
1"	25	1 5/16"	2	40	16-250-1000	16-250-1005	16-250-1004	16-250-1001
1 1/8"	28	1 7/16"	2	44	16-250-1180	16-250-1185	16-250-1184	16-250-1181
1 1/4"	32	1 9/16"	2	50	16-250-1140	16-250-1145	16-250-1144	16-250-1141
1 5/16"	33	1 5/8"	2	51	16-250-1560	—	16-250-1564	16-250-1561
1 3/8"	35	1 23/32"	2	58	16-250-1380	—	16-250-1384	16-250-1381
1 1/2"	38	1 55/64"	2	62	16-250-1120	16-250-1125	16-250-1124	16-250-1121
1 5/8"	42	2"	2	80	16-250-1580	—	16-250-1584	16-250-1581
1 3/4"	45	2 1/8"	2	88	16-250-1340	—	16-250-1344	16-250-1341
1 7/8"	48	2 19/64"	2	93	16-250-1780	—	16-250-1784	16-250-1781
2"	51	2 13/32"	2	99	16-250-2000	—	16-250-2004	16-250-2001
2 1/8"	54	2 17/32"	2	107	16-250-2180	—	16-250-2184	16-250-2181
2 1/4"	58	2 11/16"	2	127	16-250-2140	—	16-250-2144	16-250-2141
2 3/8"	60	2 3/4"	2	132	16-250-2380	—	16-250-2384	16-250-2381
2 1/2"	63	2 7/8"	2	137	16-250-2120	—	16-250-2124	16-250-2121
2 5/8"	67	3 1/16"	2	147	—	—	16-250-2584	16-250-2581
2 3/4"	70	3 3/16"	2	164	16-250-2340	—	16-250-2344	16-250-2341
2 7/8"	73	3 5/16"	2	170	16-250-2780	—	16-250-2784	16-250-2781
3"	76	3 7/16"	2	177	16-250-3000	—	16-250-3004	16-250-3001
3 1/8"	80	3 5/8"	2	200	16-250-3180	—	16-250-3184	16-250-3181
3 1/4"	90	4"	2	223	16-250-3120	—	16-250-3124	16-250-3121
4"	102	4 5/8"	2	269	16-250-4000	—	16-250-4004	16-250-4001
4 1/8"	105	4 47/64"	2	276	—	—	—	—
4 1/2"	114	5 1/32"	2	319	16-250-4120	—	16-250-4124	16-250-4121
5"	127	5 3/8"	2	398	16-250-5000	—	16-250-5004	16-250-5001
5 1/8"	130	5 1/4"	2	417	—	—	—	—
5 1/2"	140	6 7/16"	2	443	—	—	—	—
6"	152	6 21/32"	2	482	—	—	16-250-6004	16-250-6001
8"	203	8 23/32"	2	780	—	—	16-250-8004	—



Now double the ozone resistance required by SAEJ2006



This certification provides unbiased, third party confirmation worldwide that these Shields hoses meet the highest standards of production quality. Certification ensures the proper level of product safety and inspires user confidence.

SHIELDSAUST-C

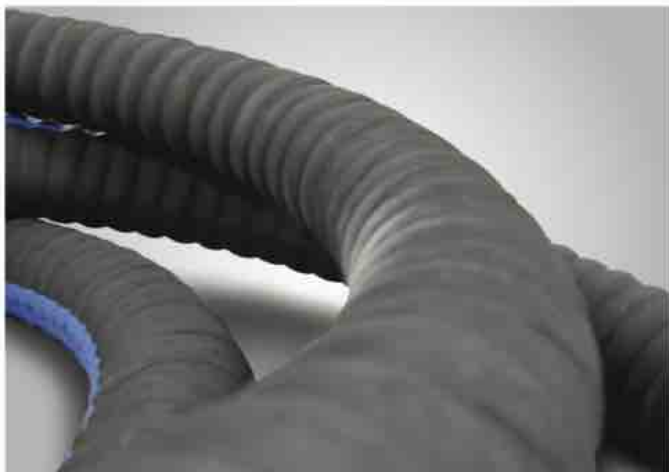

Now double the ozone resistance required by SAEJ2006

Shieldsaust – C Hose has a black synthetic rubber tube and cover. It is reinforced with double wire helix imbedded between plies of synthetic cord and is abrasion resistant. It is resistant to exhaust fumes, ozone, mild chemicals, antifreeze, and saltwater. This hose is primarily used for wet exhaust connections with significant bends, engine intake and scupper lines. The temperature ranges from -20°F to +200°F continuous, +250°F intermittent. The hose now has double the ozone resistance required by SAEJ2006. This hose meets SAE J2006 Type R2 standards. Bend Radius = 4 x I.D.

I.D.	mm	O.D.	Ply	Wt. "C"	50' (15.2m) Coil Code #	12 1/2' (3.8m) Length Code #	6 1/4' (1.9m) Length Code #
3/8"	19	1 1/8"	2	27	16-252-0340	16-252-0344	16-252-0341
1"	25	1 11/32"	2	33	16-252-1000	16-252-1004	16-252-1001
1 1/4"	32	1 39/64"	2	45	16-252-1140	16-252-1144	16-252-1141
1 1/2"	38	1 15/16"	2	70	16-252-1120	16-252-1124	16-252-1121
1 5/8"	42	2 3/32"	2	80	16-252-1580	16-252-1584	—
1 3/4"	45	2 7/32"	2	85	16-252-1340	16-252-1344	16-252-1341
1 7/8"	48	2 37/64"	2	91	16-252-1780	16-252-1784	16-252-1781
2"	51	2 7/16"	2	95	16-252-2000	16-252-2004	16-252-2001
2 1/8"	54	2 9/16"	2	100	—	16-252-2184	16-252-2181
2 1/4"	58	2 23/32"	2	107	—	16-252-2144	—
2 3/8"	60	2 51/64"	2	110	16-252-2380	16-252-2384	16-252-2381
2 1/2"	63	2 39/64"	2	115	16-252-2120	16-252-2124	16-252-2121
2 3/4"	70	3 3/16"	2	126	—	16-252-2344	16-252-2341
2 7/8"	73	3 7/16"	2	137	16-252-2780	16-252-2784	—
3"	76	3 7/16"	2	143	16-252-3000	16-252-3004	16-252-3001
3 1/8"	80	3 19/32"	2	150	—	16-252-3184	16-252-3181
3 1/2"	90	4 1/16"	2	200	16-252-3120	16-252-3124	16-252-3121
4"	102	4 7/16"	2	231	16-252-4000	16-252-4004	16-252-4001
4 1/8"	105	4 17/16"	2	238	—	16-252-4184	16-252-4181
4 1/2"	114	5 1/8"	2	278	—	16-252-4124	—
5"	127	5 9/16"	2	300	—	16-252-5004	16-252-5001
6"	152	6 39/16"	2	394	16-252-6000	16-252-6004	16-252-6001
8"	203	8 11/16"	2	607	—	16-252-8004	16-252-8001



This certification provides unbiased, third party confirmation worldwide that these Shields hoses meet the highest standards of production quality. Certification ensures the proper level of product safety and inspires user confidence.

SHIELDS NAUTIFLEX CORRUGATED SILICONE EXHAUST HOSE



Shields Nautiflex Corrugated Silicone

Exhaust Hose has a blue silicone tube and cover with a smooth finish for easy cleaning. The hose is wire reinforced and will not collapse under suction or in a bend. The corrugated cover allows the hose to bend for easy installation. The Nautiflex, two ply construction, has wire captured between fabric plies. This hose is primarily used for main engine exhaust, generator exhaust, engine coolant circulation, engine intake and generator intake. It is resistant to exhaust fumes, ozone, mild chemicals, antifreeze and saltwater. The hose remains stable at elevated temperatures. The temperatures ranges from -20°F – +350°F. This hose meets SAEJ2006 Type R2 and ISO 13362:2004 – Type 1 – Class B standards. Bend Radius = 4 x I.D.

ID	mm	OD	WT "C"	10' (3.1m) length Code No.	12 1/2' (3.8m) Length Code No.	50' (15.2m) coil Code No.	6 1/4' (3.8m) Length Code No.
3/4"	19	1 3/8"	34	—	16-262-0344	16-262-0340	—
1"	25	1 27/64"	42	16-262-1003	16-262-1004	16-262-1000	—
1 1/8"	28	1 1/2"	46	16-262-1183	16-262-1184	16-262-1180	—
1 1/4"	32	1 45/64"	52	16-262-1143	16-262-1144	16-262-1140	—
1 3/8"	35	1 55/64"	60	16-262-1383	16-262-1384	16-262-1380	—
1 1/2"	38	2"	71	16-262-1123	16-262-1124	16-262-1120	—
1 5/8"	42	2 11/64"	74	16-262-1583	—	—	—
1 3/4"	45	2 19/64"	78	16-262-1343	16-262-1344	16-262-1340	—
1 7/8"	48	2 13/32"	82	16-262-1783	16-262-1784	16-262-1780	—
2"	51	2 17/32"	87	16-262-2003	16-262-2004	16-262-2000	—
2 1/8"	54	2 3/8"	94	—	—	—	—
2 3/8"	60	2 7/8"	101	16-262-2383	16-262-2384	16-262-2380	—
2 1/2"	63	3 1/4"	113	16-262-2123	16-262-2124	16-262-2120	—
2 3/4"	70	3.312"	125	16-262-2343	16-262-2344	16-262-2340	—
2 7/8"	73	3 7/16"	134	16-262-2783	16-262-2784	16-262-2780	—
3"	76	3 35/64"	139	16-262-3003	16-262-3004	16-262-3000	—
3 1/2"	90	4 18/64"	227	16-262-3123	16-262-3124	16-262-3120	—
4"	102	4 49/64"	255	16-262-4003	16-262-4004	16-262-4000	—
5"	127	5 3/4"	310	16-262-5003	—	16-262-5000	—
6"	152	6 18/16"	484	16-262-6003	—	—	16-262-6001
8"	203	9 7/64"	768	16-262-8003	—	—	—
10"	254	11 17/64"	1136	16-262-10003	—	—	—
12"	305	13.359"	1518	16-262-12003	—	—	—
14"	350	15.281"	1812	—	—	—	—
16"	404	17.562"	2277	—	—	—	—

* Special Order

SHIELDS COMPLEX - ALL IN ONE HOSE FOR INSPECTED VESSELS

Shields Complex is a versatile wire reinforced hose specially designed for inspected vessels. Complex is rated for fuel, vital water and non-vital water systems on boats requiring SAE J1942 hoses. Applications include bilge, coolant, oil and fuel systems using gasoline, gasohol, diesel, bio-diesel, wet exhaust systems, non-potable water systems, engine intake, toilet and holding tank connections.



Tube: Black Nitrile

Reinforcement: 2 textile plies w/ dual wire helix

Cover: Black Chlorprene

Temp. Range: -20F to +212F

Specifications - SAE J1942 Code F, VW, NVW; SAE J1527 A1; SAE J2006 R2; SAE 20R2 B; SAE J20R4 B; SAE 20R5 B, SAE 30R5, ISO 7840 A1

Additional sizes available. 150' minimum order.

I.D.	mm	O.D.	PLY	Wt. °C"	Bend Radius	WP	50' Coil Code #	12 1/2' (3.8m) Length Code #	10' (3.1m) Length Code #	6 1/4' (3.8m) Length Code #
5/8"	15.9	1"	2	33	1.5	75	16-321-0580	16-321-0584	16-321-0583	16-321-0581
3/4"	19.1	1.19"	2	39	1.5	75	16-321-0340	16-321-0344	16-321-0343	16-321-0341
1"	25.4	1.41"	2	53	2	75	16-321-1000	16-321-1004	16-321-1003	16-321-1001
1 1/8"	28.6	1.56"	2	62	3	75	16-321-1180	16-321-1184	—	16-321-1181
1 1/4"	31.8	1.66"	2	64	3	75	16-321-1140	16-321-1144	16-321-1143	16-321-1141
1 1/2"	38.1	1.91"	2	78	3	50	16-321-1120	16-321-1124	16-321-1123	16-321-1121
2"	50.8	2.48"	2	118	5	50	16-321-2000	16-321-2004	16-321-2003	16-321-2001

SHIELDS MULTIFLEX



Shields Multiflex Hose has a clear FDA formula PVC with black vinyl helix. It is abrasion resistant, flexible and is resistant to mild chemicals and saltwater. This hose is primarily used for bilge pump discharge, potable water tank fill and drains (sinks, shower, livewell and scupper). This hose uses 147 right hand thread cuffs. **Do not attach to thru hull fitting below the water line. Do not use ethylene glycol based antifreeze in hose.**

I.D.	mm	Bend Radius	mm	WL "C"	Bulk Pack 100' (30.5m) Coil Code #	Dist. Pkg. 50' (15.2m) R/O Ctn. Code #	10' (3.1m) Length Code #
5/8"	15.9	1/2"	12.7	8	16-141-0580B	16-141-0586B	
3/4"	19.1	3/4"	19.1	10	16-141-0340B	16-141-0346B	
1"	25.4	7/8"	22.2	13	16-141-1000B	16-141-1006B	
1 1/8"	28.6	1"	25.4	16	16-141-1180B	16-141-1186B	
1 1/4"	31.8	1 1/2"	38.1	19	16-141-1140B	16-141-1146B	
1 1/2"	38.1	2"	50.8	24	16-141-1120B	16-141-1126B	
2"	50.8	5"	127.0	34	16-141-2000B	-	16-141-2003B
1 1/2"	38.1	2"	50.8	24	16-141-1120W	-	16-141-1123W

SHIELDS VAC EXTRA HEAVY DUTY/FDA



Shields Vac Extra Heavy Duty/FDA Hose has a smooth white FDA grade PVC with vinyl helix. It is rated for full vacuum and is resistant to mild chemicals, permeation, and saltwater. This hose is primarily used for bilge pump intake and discharge, drains (sinks, shower, and scupper), livewell intake and drain, potable water tank fill, and sanitation (toilet to holding tank, intake, self draining lines vent and pump out). This hose is resistant to odor permeation. **Do not use ethylene glycol based antifreeze in hose. Do not use in pressurized water systems.**

I.D.	mm	Bend Radius	mm	Vac Rating	WL "C"	Bulk Pack 100' (30.5m) Coil Code #	Dist. Pkg. 50' (15.2m) R/O Ctn. Code #	25' (7.6m) R/O Ctn. Code #
5/8"	15.9	3	76.2	28	15	16-148-0580W	16-148-0586W	—
3/4"	19.1	3	76.2	28	20	16-148-0340W	16-148-0346W	—
1"	25.4	3	76.2	28	27	16-148-1000W	16-148-1006W ①	—
1 1/8"	28.6	4	101.6	28	29	16-148-1180W	16-148-1186W	—
1 1/4"	31.8	4	101.6	28	31	16-148-1140W	16-148-1146W	—
1 1/2"	38.1	5	127.0	28	40	16-148-1120W	16-148-1126W ①	16-148-1125W

① WARNING: Lines containing raw sewage should be plumbed to be self-draining.

SHIELDS LIVEWELL HOSE



Shields Livewell Hose has a black smooth cover with vinyl helix. It is rated for full vacuum and is resistant to mild chemicals and saltwater. This hose is primarily used for bilge pump intake and discharge, drains (sinks, shower, and scupper), livewell intake and drain, and sanitation (intake and vent). This hose is utilized for below the waterline connections. **Do not use ethylene glycol based antifreeze in hose. Not for potable water.**

I.D.	mm	Bend Radius	mm	Vac Rating	Wt. "C"	Bulk Pack 100' (30.5m) Coil Code #	Dist. Pkg. 50' (15.2m) R/O Ctn. Code #
5/8"	15.9	3	76.2	28	15	16-149-0580	16-149-0586
3/4"	19.1	3	76.2	28	16	16-149-0340	16-149-0346
1"	25.4	3	76.2	28	24	16-149-1000	16-149-1006
1 1/8"	28.6	4	101.6	28	25	16-149-1180	16-149-1186
1 1/4"	31.8	4	101.6	28	28	16-149-1140	16-149-1146
1 1/2"	38.1	5	127.0	28	39	16-149-1120	16-149-1126

SHIELDS PVC TUBING - CLEAR



Shields Clear PVC Tubing has a single layer FDA formula vinyl. This hose is primarily used for non-pressurized potable water system supply and drain lines (sink, shower, icebox). This hose is NOT for use in hot water or pressurized water systems.

I.D.	mm	Wall	mm	Burst Pressure 70°	Wt. "C"	Code #	Bulk Pack	mm	100' (30.5m) R/O Ctn. Code #	Dist. Pkg. 50' (15.2m) R/O Ctn. Code #	25' (7.6m) Polypac Code #
3/16"	4.8	.062	1.6	65#	3	16-150-0360	750'	228.6	16-150-0367	16-150-0366	16-150-0365
1/8"	6.4	.078	2.0	60#	4	16-150-0140	500'	152.4	16-150-0147	16-150-0146	16-150-0145
5/16"	7.9	.093	2.4	55#	5	16-150-0560	200'	61.0	16-150-0567	16-150-0566	16-150-0565
3/8"	9.5	.094	2.4	55#	6	16-150-0380	200'	61.0	—	16-150-0386	16-150-0385
1/2"	12.7	.11	2.8	45#	12	16-150-0120	200'	61.0	16-150-0127	16-150-0126	16-150-0125
5/8"	15.9	.11	2.8	40#	15	16-150-0580	200'	61.0	16-150-0587	16-150-0586	16-150-0585
3/4"	19.1	.11	2.8	35#	19	16-150-0340	200'	61.0	16-150-0347	16-150-0346	16-150-0345
1"	25.4	.125	3.2	20#	27	16-150-1000	100'	30.5	16-150-1007	16-150-1006	16-150-1005
1 1/8"	28.6	.125	3.2	20#	29	16-150-1180	100'	30.5	—	16-150-1186	—
1 1/4"	31.8	.125	3.2	20#	31	16-150-1140	100'	30.5	—	16-150-1146	16-150-1145
1 1/2"	38.1	.125	3.2	20#	34	16-150-1120	50'	15.2	—	16-150-1126	16-150-1125

SHIELDS ALL CLEAR PVC TUBING POLYESTER REINFORCED (Red-Tracer)

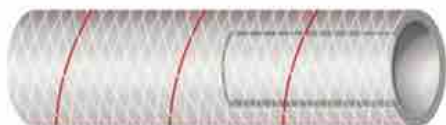

Shields Clear Polyester Reinforced Red Tracer PVC Tubing has a clear heavy wall FDA formula vinyl. It has a polyester braid reinforcement. This hose is primarily used for pressurized water system supply (hot or cold), drain lines (sink, shower, icebox), wash down pump connections and head intake.



I.D.	mm	O.D.	mm	Burst Pressure	Wt. "C"	Bulk Pack 250' (76.2m) Coll Code #	Dist. Pkg. 50' (15.2m) R/O Ctn. Code #	25' (7.6m) Polypac Code #	10' (3.1m) Polypac Code #
3/8"	9.5	9/16"	14.3	500#	7	16-162-0380	16-162-0386	16-162-0385	16-162-0383
1/2"	12.7	29/32"	18.3	500#	11	16-162-0120	16-162-0126	16-162-0125	16-162-0123
5/8"	15.9	27/32"	21.4	400#	14	16-162-0580	16-162-0586	16-162-0585	16-162-0583
3/4"	19.1	31/32"	24.6	325#	17	16-162-0340	16-162-0346	16-162-0345	16-162-0343
1"	25.4	1 5/16"	33.3	325#	24	16-162-1000	16-162-1006	16-162-1005	16-162-1003
1 1/8"	28.6	1 3/8"	34.9	375#	32	16-162-1180	16-162-1186	—	—
1 1/4"	31.8	1 5/8"	41.3	325#	44	16-162-1140	16-162-1146	—	—
1 1/2"	38.1	1 15/16"	49.2	300#	67	16-162-1120	16-162-1126	—	—

① 100' roll

SHIELDS BRAIDED WASH DOWN HOSE



Shields Braided Wash Down Hose has a white FDA formula vinyl tube and clear vinyl cover. It has a polyester braid reinforcement and a 250 PSI burst pressure. This hose has brass ends, is lightweight and easy to handle. This hose is primarily used for dockside wash down and is safe for potable water.

I.D.	mm	Length	mm	Bulk Pack	Wt.	Code No.
5/8"	15.9	25'	7.6	5	3.25	16-163-0585
5/8"	15.9	50'	15.2	5	6.50	16-163-0586
5/8"	15.9	75'	22.9	5	9.75	16-163-0588
5/8"	15.9	100'	30.5	5	13.00	16-163-0587

SHIELDS CLEAR WHITE PVC TUBING POLYESTER REINFORCED (Blue-Tracer)



Clear White Blue Tracer PVC Tubing has a white FDA formula vinyl tube. It has a clear vinyl cover, polyester braid reinforcement. This hose is primarily used for pressurized water system supply (hot or cold), drain lines (sink, shower, icebox), wash down pump connections and head intake.



I.D.	mm	O.D.	mm	Burst Pressure	Wt. "C"	Bulk Pack 250' (76.2m) Coll Code #	50' (15.2m) R/O Ctn. Code #	Dist. Pkg. 25' (7.6m) Polypac Code #	10' (3.1m) Polypac Code #
1/2"	12.7	1 1/16"	17.5	500#	10	16-164-0120	16-164-0126	16-164-0125	16-164-0123
3/8"	15.9	1 3/16"	20.6	400#	13	16-164-0580	16-164-0586	16-164-0585	16-164-0583
1/4"	19.1	1 5/16"	23.8	325#	17	16-164-0340	16-164-0346	16-164-0345	16-164-0343

SHIELDS HEAVY DUTY POLYESTER REINFORCED PVC TUBING

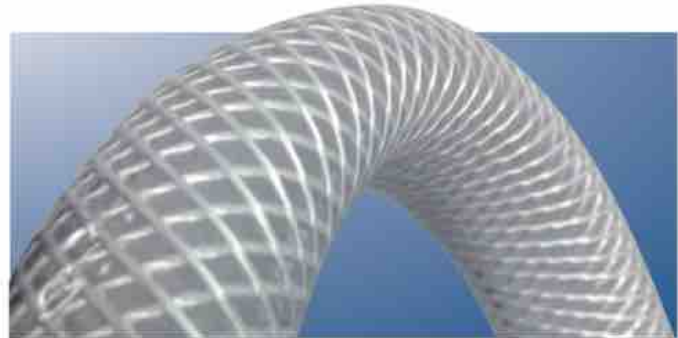

Shields Heavy-Duty Polyester Reinforced PVC Tubing has a clear extra heavy wall FDA formula vinyl. It has superior kink resistance and a polyester braid reinforcement. This hose is primarily used for pressurized water system supply (hot or cold), wash down pump connections and head intake.

I.D.	mm	O.D.	mm	Burst Pressure	Wt. "C"	Code #	Bulk Pack	Dist. Pkg. 50' (15.2m) R/O Ctn. Code #
1/4"	6.4	.438"	11.1	250#	5.6	16-168-0140	300'	16-168-0146
3/8"	9.5	.594"	15.1	225#	9.2	16-168-0380	300'	16-168-0386
1/2"	12.7	.750"	19.1	200#	13.5	16-168-0120	300'	16-168-0126
5/8"	15.9	.875"	22.2	200#	16.2	16-168-0580	300'	16-168-0586
3/4"	19.1	1.025"	26.0	150#	21.1	16-168-0340	300'	16-168-0346
1"	25.4	1.312"	33.3	125#	31.2	16-168-1000	200'	16-168-1006
1 1/4"	31.8	1.656"	42.1	100#	51	16-168-1140	100'	16-168-1146
1 1/2"	38.1	1.937"	49.2	100#	65	16-168-1120	100'	16-168-1126

SHIELDS OIL TANK FILL HOSE



Shields Oil Tank Fill Hose has a nitrile/PVC blend for excellent oil resistance. It has a flexible corrugated design, smooth bore and a vinyl helix to prevent collapse. It also resists ozone and cold temperature cracking. This hose is primarily used for 2-cycle oil tank fill.

I.D.	mm	Bend Radius	mm	Wt "C"	Bulk Pack 100' (30.5m) Coils Code #	Dist. Pkg. 50' (15.2m) R/O Ctn. Code #	10' (3.1m) Ctn Code #
1 1/2"	38.1	4"	101.6	22	16-309-1120	16-309-1126	16-309-1123

SHIELDS SILVERADO 2000 FUEL VENT LINE



Silverado 2000 Fuel Vent Line is primarily used for fuel tank vent (outside the engine compartment) and is for pleasure boats only. The Temperature range is -5°F to +180°F. It meets SAE J1527 Type B2 standards.

I.D.	mm	O.D.	mm	Ply	Burst Pressure	Wt. "C"	Bulk Pack Code #	50' (15.2m) R/O Ctn. Code #	Dist. Pkg. 25' (7.6m) R/O Ctn. Code #	10' (3.1m) Polypac Code #	Bulk Pack 100' (30.5m) Coil Code #
5/8"	15.9	29/32"	23.0	2	175#	24.0	16-315-0580 (250' reel)	16-315-0586	16-315-0585	16-315-0583	16-315-0587

SHIELDS SILVERADO 4000 OUTBOARD FUEL LINE



CONSTRUCTION

The series 337 fuel lines (Silverado 4000) is the best B1 fuel line in the market place. Utilizing a complex construction technique involving a THV500 barrier layer, a Nitrile jacket, Polyester reinforcement and a CPE cover; we are able to offer a hose that outperforms all competitors. The Silverado 4000 hose has a small O.D., is extremely flexible and easy to clamp. Not only does the Silverado 4000 meet all requirements it has become the only fuel line worthy to be utilized in Sierra's fuel line assemblies.



Silverado 4000 Outboard Fuel Line is resistant to ethanol blended fuels. This hose is EPA and CARB compliant. Silverado 4000 has a THV barrier layer to prevent permeation, polyester reinforcement for strength and a weather and UV resistant CPE cover. The gray color keeps hose cooler and helps prevent vapor lock. This hose is for above deck primer bulb applications, and is not fire retardant.



Meets SAE J1527 Type B1-15
Meets ISO 8469 B1

I.D.	mm	O.D.	mm	Wt. "C"	Bulk Pack Code #	50' (15.2m) R/O Ctn. Code #	Dist. Pkg. 25' (7.6m) R/O Ctn. Code #	10' (3.1m) Polypac Code #
1/4"	6.4	7/16"	10.90	6	16-337-0140	16-337-0146	16-337-0145	16-337-0143
3/16"	7.9	1/2"	12.75	7	16-337-0560	16-337-0566	16-337-0565	16-337-0563
3/8"	9.5	5/8"	13.72	7.65	16-337-0380	16-337-0386	16-337-0385	16-337-0383

SHIELDS FIRE-ACOL FUEL FILL HOSE

Shields Fire – Acol – Fuel Fill Hose resists gasoline/alcohol blends and is compounded for low permeation. Special compound resists cover deterioration due to alcohol fuel resting in hose. It is abrasion resistant and it is reinforced with wire helix imbedded between plies of HD synthetic cord. This imported hose is primarily used for fuel fill (gas or diesel) and is for pleasure boats only. The temperature range is -5°F to 180°F. It meets SAE J1527 Type A2 and ISO 7840 Type A2 NMMA/CE Type Accepted standards.



I.D.	mm	O.D.	mm	Ply	Burst Pressure	Wt. "C"	50' (15.2m) Coils Code #	12 1/2' (3.8m) Length Code #	12 1/2' (3.8m) Carton Code #	10' (3.1m) Length Code #	10' (3.1m) Carton Code #
1 1/2"	38	1 37/64"	48	2	90	77	16-350-1120	16-350-1124	—	16-350-1123	—
1 5/8"	41.3	2 3/64"	52.0	2	90#	89	—	16-350-1584	—	16-350-1583	—
1 7/8"	47.6	2 9/32"	58.0	2	90#	114	16-350-1780	16-350-1784	—	16-350-1783	16-350-1783BX
2"	50.8	2 31/64"	63.1	2	90#	121	16-350-2000	16-350-2004	—	16-350-2003	—
2 3/8"	60.3	2 27/32"	72.2	2	90#	137	16-350-2380	16-350-2384	—	16-350-2383	—

SHIELDS FIRE-ACOL "C" FUEL FILL HOSE



Shields Fire – Acol – "C" Fuel Fill Hose resists gasoline/alcohol blends and has a corrugated cover for extra flexibility. This hose is compounded for low permeation and is reinforced with a wire helix imbedded between plies of HD synthetic cord. It is also abrasion resistant. This hose is primarily used for extra flexible fuel fill (gas or diesel) and is for pleasure boats only. The temperature range is -5°F to 180°F. It meets SAE J1527 type A2 and NMMA Type Accepted standards.



I.D.	mm	O.D.	mm	Ply	Burst Pressure	Wt. "C"	Bulk Pack	Dist. Pkg.	
							50' (15.2m) Coils	12 1/2' (3.8m) Length	10' (3.1m) Length
1 7/8"	38.1	1 57/64"	48.0	2	90#	77	16-351-1120	16-351-1124	16-351-1123

SHIELDS FUEL FILL HOSE



Shields Fire – Acol – Fuel Fill Hose resists gasoline/alcohol blends and is compounded for low permeation. It is abrasion resistant and it is reinforced with wire helix imbedded between piles of HD synthetic cord. This imported hose is primarily used for fuel fill (gas or diesel) and is for pleasure boats only. It meets SAE J1527 Type A2 and ISO 7840 Type A2 NMMA/CE Type Accepted standards.

I.D.	mm	O.D.	mm	Ply	Burst Pressure	Wt. "C"	50' (15.2m) Coils Code #	12 1/2' (3.8m) Length Code #	12 1/2' (3.8m) Carton Code #	10' (3.1m) Length Code #	10' (3.1m) Carton Code #	25' (7.6m) Length Code #
1 1/2"	38.1	1 57/64"	48.0	2	90#	77	16-355-1120	16-355-1124	16-355-1124BX	16-355-1123	16-355-1123BX	16-355-1125
2"	51	2 71/64"	63.1	2	90#	111	16-355-2000	16-355-2004	—	16-355-2003	—	—

SHIELDS FIRE-ACOL 15 LOW PERMEATION FUEL HOSE

Shields Fire-Acol 15 – Low Permeation Fuel Hose has a special design NBR tube with an embedded plastic barrier layer to prevent permeation. The design of this hose provides easy coupling insertion and the NBR/PVC cover is weather and UV resistant. The hose is also polyester reinforced and fire-resistant. This hose is primarily used for fuel feed (gasoline up to 85% ethanol blended fuels/diesel/bio-diesel all blends). The temperature range is -20°F to 212°F.

★ Meets new CARB 10 g/M2/24 hrs. standard



I.D.	mm	O.D.	mm	Max WP	Wt. C	Bulk Pack 250' reel Code #	50' B/O Ctn. Code #	10' Polypac Code #
3/4"	9.5	49/64"	19.3	100	22	16-365-0380	16-365-0386	—
1 1/2"	12.7	23/32"	22.86	100	27	16-365-0120	16-365-0126	—

This hose complies with EPA and CARB very low permeation requirements. It meets USCG Type A1-15 requirements for pleasure boats, SAE J1527 Type A1-15, ISO 7840 Type A1, and NMMA/CE Type accepted standards

SHIELDS LOW PERMEATION MARINE FUEL HOSE

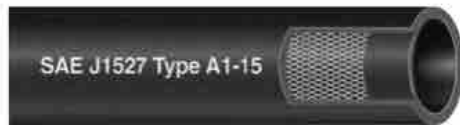

Shields Low Permeation Marine Fuel Hose has a plastic barrier veneer with an NBR outer layer tube to prevent permeation. This polyester reinforced hose complies with EPA and CARB very low permeation requirements and is weather/UV resistant. This hose is primarily used for fuel feed (gasoline up to 85% ethanol blended fuels/diesel/all bio-diesel blends). It meets USCG Type A1 – 15 requirements for pleasure boats and meets SAE J1527 Type A1-15, ISO 7840 Type A1, and NMMA/CE type accepted standards. The temperature ranges from -20°F to 212°F.

★Meets new CARB 10 g/M2/24 hrs. standard



I.D.	mm	O.D.	mm	Max WP	Wt. C	Bulk Pack 250' reel Code #	50' R/O Ctn. Code #	25' R/O Ctn Code #	10' Polypac Code #
1/4"	6.4	2 3/16"	13.72	100	11	16-368-0140	16-368-0146	16-368-0145	16-368-0143
3/8"	7.9	2 7/8"	15.49	100	13	16-368-0560	16-368-0566	16-368-0565	16-368-0563
1/2"	9.5	3 1/8"	17.27	100	16	16-368-0380	16-368-0386	16-368-0385	16-368-0383
3/4"	12.7	3 7/8"	20.83	100	20	16-368-0120	16-368-0126	16-368-0125	16-368-0123

SHIELDS FIRE-ACOL FUEL VENT



Shields Fire-Acol Fuel Vent hose resists gasoline/alcohol blended fuel and is fire resistant. It features a weather/UV resistant NBR/PVC cover. This hose is primarily used for fuel vent lines (gasoline up to 85% ethanol blended fuels/diesel fuels). It meets USCG Type A2 requirements for pleasure boats and meets SAE J1527 Type A2, ISO 7840 Type A2 and NMMA/CE Type accepted standards. The temperature ranges from -20°F to 160°F.



I.D.	mm	O.D.	mm	Max WP	Wt. C	Bulk Pack 250' reel Code #	50' R/O Ctn. Code #	25' R/O Ctn Code #	10' Polypac Code #
1/2"	15.9	2 1/2"	24.6	50	.25	16-369-0580	16-369-0586	16-369-0585	16-369-0583

SHIELDS COMPLEX - ALL IN ONE HOSE FOR INSPECTED VESSELS

Shields Complex is a versatile wire reinforced hose specially designed for inspected vessels. Complex is rated for fuel, vital water and non-vital water systems on boats requiring SAE J1942 hoses. Applications include bilge, coolant, oil and fuel systems using gasoline, gasohol, diesel, bio-diesel, wet exhaust systems, non-potable water systems, engine intake, toilet and holding tank connections.



Tube: Black Nitrile

Reinforcement: 2 textile plies w/ dual wire helix

Cover: Black Chlorprene

Temp. Range: -20F to +212F

Specifications - SAE J1942 Code F, VW, NVW;
SAE J1527 A1; SAE J2006 R2; SAE 20R2 B;
SAE J20R4 B; SAE 20R5 B, SAE 30R5,
ISO 7840 A1

Additional sizes available. 150' minimum order.

I.D.	mm	O.D.	PLY	Wt. "C"	Bend Radius	WP	50' Coil Code #	12 1/2' (3.8m) Length Code #	10' (3.1m) Length Code #	6 1/4' (3.8m) Length Code #
5/8"	15.9	1"	2	33	1.5	75	16-321-0580	16-321-0584	16-321-0583	16-321-0581
3/4"	19.1	1.19"	2	39	1.5	75	16-321-0340	16-321-0344	16-321-0343	16-321-0341
1"	25.4	1.41"	2	53	2	75	16-321-1000	16-321-1004	16-321-1003	16-321-1001
1 1/8"	28.6	1.56"	2	62	3	75	16-321-1180	16-321-1184	—	16-321-1181
1 1/4"	31.8	1.65"	2	64	3	75	16-321-1140	16-321-1144	16-321-1143	16-321-1141
1 1/2"	38.1	1.91"	2	78	3	50	16-321-1120	16-321-1124	16-321-1123	16-321-1121
2"	50.8	2.48"	2	118	5	50	16-321-2000	16-321-2004	16-321-2003	16-321-2001



FERRULE VISE/DIES

Hand operated vise for making fuel line assemblies without clamps. Vise uses ordinary barbed fittings with series 700 solid brass ferrules. Makes professional looking leak proof fuel lines. Furnished with removable handle. Dies must be ordered separately. When ordering dies, please consult chart under brass ferrules to determine proper size.

Part #	Description
No. 18-J662-xxx	Dies give longitudinal crimp.
No. 18-J664-xxx	Dies give circular and longitudinal crimp.

* Special Order Only

45° SAE FEMALE SWIVEL



Code No.	Hose I.D.	Tube	Thread
18-502-1476	1/4"	1/4"	7/16-20
18-502-5612	3/16"	3/16"	1/2-20
18-502-5658	5/16"	3/8"	5/8-18
18-502-3858	3/8"	3/8"	5/8-18
18-502-1234	1/2"	1/2"	3/4-16
18-502-1278	1/2"	5/8"	7/8-14

Standard Package: 100 pieces

ADAPTER — MALE PIPE TO SAE 45° FLARE



Code No.	Tube	Pipe
18-600-1418	1/4"	1/8"
18-600-1414	1/4"	1/4"
18-600-5618	3/16"	1/8"
18-600-3818	3/8"	1/8"
18-600-3814	3/8"	1/4"
18-600-3838	3/8"	3/8"
18-600-1212	1/2"	1/2"
18-600-5812	5/8"	1/2"

Standard Package: 100 pieces

ADAPTER — MALE PIPE TO SAE 45° FLARE 90°



Code No.	Tube	Pipe
18-601-3814	3/8"	1/4"

MALE PIPE



Bulk Pack Code No.	Hose Barb Sierra No.	Hose I.D.	Thread
18-500-1418	18-8043	1/4"	1/8"
18-500-1414	18-8042	1/4"	1/4"
18-500-5618	18-8054	3/16"	1/8"
18-500-5614	18-8055	5/16"	1/4"
18-500-3818	18-8073	3/8"	1/8"
18-500-3814	18-8074	3/8"	1/4"
18-500-3838	18-8108	3/8"	3/8"
18-500-1238	—	1/2"	3/8"
18-500-1212	—	1/2"	1/2"
18-500-5838	18-8041	5/8"	3/8"

STD. PKG. 100
STD. CTN. 12
(1 PER CARD)

SOLID BRASS FERRULES



Code No.	Hose Type	Die Set
18-700-5500	16-368-0140	18-J662-550
18-700-6250	16-368-0560	18-J662-625
18-700-6500		
18-700-6750	16-368-0140	18-J662-675
18-700-7000	16-368-0380	18-J662-700
18-700-7250	16-368-0560	18-J662-725
18-700-7500		
18-700-7750	16-365-0380	18-J662-775
18-700-8000	16-368-0380	18-J662-775
18-700-8250	16-368-0120	18-J662-825
18-700-8500		
18-700-9000		
18-700-9000A		
18-700-9250	16-368-0120	18-J662-900
18-700-9500		
18-700-1025	16-369-0580	18-J662-1025

FUEL WATER SEPARATORS



Compact

30 GPH for up to 115 HP motors
(Use with N-187774S head.)



Standard



Extra Capacity



Drain Bowl

AquaVue™ drain bowl style filters with see through plastic bowl or fire resistant metal bowl for below deck installation.

Part #	Description	Rating
18-7928-1	Filter w/ AquaVue™ bowl	10 Micron
18-7929	Filter w/ Metal bowl	10 Micron
18-7866	Extra Capacity - 6"	10 Micron
18-7944	Short - 3.88"	10 Micron
18-7945	Long - 4.35"	10 Micron
18-7844	Short - 3.88"	21 Micron
18-7845	Long - 4.35"	21 Micron
18-7865	Compact Filter	10 Micron

Available in standard packs of 12.

FEATURES

Ethanol blended fuel absorbs more water and loosens more particulates than regular fuels. Proper filtration is required for every horsepower engine. Sierra fuel water separators remove over 99.8% of emulsified water from your gasoline. Sierra's 10 micron filters are over 90% efficient at removing particles as small as 10 micron. All filters flow at 90 GPH to feed even the hungriest motor. Sierra 10 micron filters are recommended to prevent damage to sensitive inboard and outboard fuel injection systems.

PRIMER BULBS

Sierra is a leading supplier of primer bulbs to the marine aftermarket. Our bulbs are molded in house. We use double check valves with viton balls and stainless steel springs.



Part #	Description
18-8002EP-1	Primer bulb for 1/4" hose
18-8004EP-1	Primer bulb for 5/16" hose
18-8005EP-1	Primer bulb for 3/8" hose

CUSTOM FUEL LINE ASSEMBLIES

- Sierra can fabricate custom assemblies for OEM applications.
- Any combination of hose and fittings is possible.
- Use type A hose to the splash well and type B hose to the engine.
- Customizable length.
- Inlet can be 3/8" with 5/16" outlet.
- Numerous OEM connectors available.



BRACKETS

Sierra brackets are precision machined powder coated aluminum or marine grade stainless steel. They are available with 3/8" or 1/4" inlets.



Part # Boxed	Description	Bulk Standard Pack
18-7776	3/8" Thread Stainless Steel	14
18-7777	1/4" Thread Stainless Steel	14
18-7775	3/8" Thread Aluminum	48
18-7853-1	1/4" Thread Aluminum	48
18-7774	1/4" Thread Aluminum (Compact)	60
18-4264	3/8" Pipe Plugs	—
18-4256	1/4" Pipe Plugs	—

SHIELDS SANITATION HOSE

Shields Sanitation Hose is kink resistant and flexible. It has an EPDM tube and cover, it is wire reinforced and has two fabric plies. This sanitation hose is resistant to toilet chemicals, odor permeation, ozone, salt water and heat. This hose is primarily used for toilet to holding tank, holding tank pump out, and maximum resistance to odor permeation.

Bend Radius = 5 x I.D.



I.D.	mm	O.D.	Ply	Burst Pressure	Wt. "C"	Bulk Pack 50' (15.2m) Coil Code #	Dist. Pkg. 12 1/2' (3.8m) Length Code #	25' (7.6mm) Coil Code #	10' (3.1m) Code #
1"	25	1 7/16"	2	200#	38	16-101-1000	16-101-1004	—	16-101-1003
1 1/2"	38	1 55/64"	2	150#	55	16-101-1120	16-101-1124	16-101-1125	16-101-1123

SHIELDS POLY X SANITATION HOSE



Shields Poly X Sanitation Hose has a lifetime warranty against odor permeation. This ultimate sanitation hose combines the flexibility of a rubber hose with the permeation resistance of polyurethane. Poly X can easily be slipped over most fittings and the polyurethane cover is extremely abrasion resistant. This hose has a glossy cover for easy clean up. This hose is primarily used for head to holding tank and holding tank pump out.

The tube is made of smooth, white NBR and is chemical and detergent resistant. The cover is comprised of smooth polyurethane and has a glossy cover. It is heat, weather, ozone and abrasion resistant. Bend Radius = 5 x I.D.

I.D.	mm	O.D.	mm	Ply	Vac Rating	Wt. "C"	50' (15.2m) Code #	12 1/2' (3.8m) Code #	10' (3.1m) Code #
3/4"	19	1 7/16"	36.5	2	28	38	16-105-0340	16-105-0344	—
1"	25	1 21/64"	33.7	2	28	46	16-105-1000	16-105-1004	16-105-1003
1 1/2"	38	1 27/32"	46.8	2	28	66	16-105-1120	16-105-1124	16-105-1123

SHIELDS SANITATION HOSE FITTINGS

Fiberglass reinforced nylon fittings designed to fit Series 101, Series 105 and Series 144 and 148 hoses without heating or special tools. For use in sanitation systems, deck drain systems and water tank fill. Fittings are durable, chemical and fuel resistant, will not rust or cause electrolysis.

Style	Bulk Code #	Blister Pack Code #	Hose I.D.	mm	Thread
Straight Male	N800-0340	—	3/4"	19.1	7/8" MP
Straight Male	N800-1000	—	1"	25.4	1" MP
Straight Male	N800-1180	—	1 1/8"	28.6	1" MP
Straight Male	N800-1140	—	1 1/4"	31.8	1 1/8" MP
Straight Male	N800-1120B	18-800-1120	1 1/2"	38.1	1 1/8" MP
Straight Female	N801-1120	18-801-1120	1 1/2"	38.1	1 1/8" FP
90 Degree Male	N802-1120	18-802-1120	1 1/2"	38.1	1 1/8" MP
90 Degree Female	N803-1120	18-803-1120	1 1/2"	38.1	1 1/8" FP
Hose Tee	N806-1120	18-806-1120	1 1/2"	38.1	N/A



SHIELDS SUPER PVC SANITATION HOSE



Shields Super PVC Sanitation Hose is smooth off white PVC with a vinyl helix. It contains an anti-fungus /bacterial agent to inhibit odor causing growth. It is resistant to mild chemicals, saltwater, and permeation. This hose is primarily used for toilet to holding tank (self draining lines) and holding tank pump out. It has a five year limited warranty. **Do not use ethylene glycol based anti-freeze in hose. CAUTION - Do not use for potable water.**

I.D.	mm	Bend Radius	mm	Vac Rating	Wt. "C"	Bulk Pack 100' (30.5m) Coll Code #	Dist. Pkg. 50' (15.2m) R/O Ctn. Code #
1"	25.4	3	76.2	28	27	16-144-1000	16-144-1006
1 1/2"	38.1	5	127.3	28	40	16-144-1120	16-144-1126

Ⓢ **WARNING:** Lines containing raw sewage should be plumbed to be self-draining.

SHIELDS VAC EXTRA HEAVY DUTY - INDUSTRIAL GRADE



Shields VacExtra Heavy Duty/Commercial Grade Hose has a smooth cover and clear FDA formula PVC with a white vinyl helix. It is rated for full vacuum and is resistant to mild chemicals and saltwater. This hose is primarily used for bilge pump intake and discharge, potable water tank fill, drains (sinks, shower, and scupper), livewell intake and drain, and sanitation (intake, vent and pump out). This hose is utilized for below the waterline connections. **Do not use ethylene glycol based antifreeze in hose. Do not use in pressurized water systems.**

I.D.	mm	Bend Radius	mm	Vac Rating	Wt. "C"	Bulk Pack 100' (30.5m) Coll Code #	50' (15.2m) R/O Ctn. Code #	Dist. Pkg. 10' (3.1m) Length Code #
5/8"	15.9	3	76.2	28	15	16-146-0580	16-146-0586	—
3/4"	19.1	3	76.2	28	16	16-146-0340	16-146-0346	—
1"	25.4	3	76.2	28	27	16-146-1000	16-146-1006	—
1 1/8"	28.6	4	101.6	28	25	16-146-1180	16-146-1186	—
1 1/4"	31.8	3	76.2	28	30	16-146-1140	16-146-1146	—
1 1/2"	38.1	4	101.6	28	40	16-146-1120	16-146-1126	—
2"	50.8	5	127.0	28	57	16-146-2000	—	16-146-2003
2 1/2"	63.5	7	177.8	28	74	16-146-2120	—	16-146-2123
3"	76.2	9	228.6	28	94	16-146-3000	—	16-146-3003

SHIELDS VAC EXTRA HEAVY DUTY/FDA



Shields Vac Extra Heavy Duty/FDA Hose has a smooth white FDA grade PVC with vinyl helix. It is rated for full vacuum and is resistant to mild chemicals, permeation, and saltwater. This hose is primarily used for bilge pump intake and discharge, drains (sinks, shower, and scupper), livewell intake and drain, potable water tank fill, and sanitation (toilet to holding tank, intake, self draining lines vent and pump out). This hose is resistant to odor permeation. **Do not use ethylene glycol based antifreeze in hose. Do not use in pressurized water systems.**

I.D.	mm	Bend Radius	mm	Vac Rating	Wt. "C"	Bulk Pack 100' (30.5m) Coil Code #	Dist. Pkg. 50' (15.2m) R/O Ctn. Code #	25' (7.6m) R/O Ctn. Code #
5/8"	15.9	3	76.2	28	15	16-148-0580W	16-148-0586W	—
3/4"	19.1	3	76.2	28	20	16-148-0340W	16-148-0346W	—
1"	25.4	3	76.2	28	27	16-148-1000W	16-148-1006W ①	—
1 1/8"	28.6	4	101.6	28	29	16-148-1180W	16-148-1186W	—
1 1/4"	31.8	4	101.6	28	31	16-148-1140W	16-148-1146W	—
1 1/2"	38.1	5	127.0	28	40	16-148-1120W	16-148-1126W ①	16-148-1125W

① **WARNING:** Lines containing raw sewage should be plumbed to be self-draining.

SHIELDS SANITATION SYSTEM CLEANER

Shields Sanitation Hose Cleaner is a USDA certified bio-based product safe for all sanitation system components. This powerful cleaner removes uric scale, calcium carbonate and other solids to help keep sanitation systems working at their best. Available in concentrate and ready to use.



Part No.	Size	Description
18-9093	1 Gallon	Ready to Use
18-9095	1 Gallon	Concentrate



SHIELDSFLEX II MARINE WATER/EXHAUST HOSE (w/ Wire)

Shieldsflex II Marine Water/Exhaust Hose has a black synthetic rubber tube and cover. It is reinforced with wire helix imbedded between plies of HD synthetic cord. It is resistant to exhaust fumes, ozone, mild chemicals, antifreeze and saltwater. This hose is abrasion and odor permeation resistant. It now has double the ozone resistance required by the SAEJ2006. Shieldsflex II is primarily used for engine intake, wet exhaust connections (use where bends or long lengths are required), bilge pump intake/discharge, scupper lines, toilet intake/discharge, and holding tank vent/pump out. The temperature ranges from -20° F – +200°F continuous, +250°F intermittent. The hose meets SAE J2006 Type R2 standards.



I.D.	mm	O.D.	Ply	Wt. "C"	50' (15.2m) Coll Code #	25' (7.6m) Cartons	12 1/2' (3.8m) Length Code #	6 1/4' (1.9m) Length Code #	10' (3.1m) Length Code #
1/2"	13	27/32"	2	24	-0120	16-250-0125	16-250-0124	16-250-0121	16-250-0123
3/8"	16	31/32"	2	28	16-250-0580	16-250-0585	16-250-0584	16-250-0581	16-250-0583
1/2"	19	1 1/16"	2	32	16-250-0340	16-250-0345	16-250-0344	16-250-0341	16-250-0343
3/4"	22	1 1/8"	2	36	16-250-0780	—	16-250-0784	16-250-0781	16-250-0783
1"	25	1 5/16"	2	40	16-250-1000	16-250-1005	16-250-1004	16-250-1001	16-250-1003
1 1/8"	28	1 7/16"	2	44	16-250-1180	16-250-1185	16-250-1184	16-250-1181	16-250-1183
1 1/4"	32	1 19/32"	2	50	16-250-1140	16-250-1145	16-250-1144	16-250-1141	16-250-1143
1 5/16"	33	1 5/8"	2	51	16-250-1560	—	16-250-1564	16-250-1561	16-250-1563
1 3/8"	35	1 23/32"	2	58	16-250-1380	—	16-250-1384	16-250-1381	16-250-1383
1 1/2"	38	1 53/64"	2	62	16-250-1120	16-250-1125	16-250-1124	16-250-1121	16-250-1123
1 5/8"	42	2"	2	80	16-250-1580	—	16-250-1584	16-250-1581	16-250-1583
1 3/4"	45	2 1/8"	2	88	16-250-1340	—	16-250-1344	16-250-1341	16-250-1343
1 7/8"	48	2 19/64"	2	93	16-250-1780	—	16-250-1784	16-250-1781	16-250-1783
2"	51	2 13/32"	2	99	16-250-2000	—	16-250-2004	16-250-2001	16-250-2003
2 1/8"	54	2 17/32"	2	107	16-250-2180	—	16-250-2184	16-250-2181	16-250-2183
2 1/4"	58	2 11/16"	2	127	16-250-2140	—	16-250-2144	16-250-2141	16-250-2143
2 3/8"	60	2 3/4"	2	132	16-250-2380	—	16-250-2384	16-250-2381	16-250-2383
2 1/2"	63	2 7/8"	2	137	16-250-2120	—	16-250-2124	16-250-2121	16-250-2123
2 3/4"	67	3 1/16"	2	147	—	—	16-250-2584	16-250-2581	—
2 5/8"	70	3 3/16"	2	164	16-250-2340	—	16-250-2344	16-250-2341	16-250-2343
2 3/4"	73	3 5/16"	2	170	16-250-2780	—	16-250-2784	16-250-2781	16-250-2783
3"	76	3 7/16"	2	177	16-250-3000	—	16-250-3004	16-250-3001	16-250-3003
3 1/8"	80	3 5/8"	2	200	16-250-3180	—	16-250-3184	16-250-3181	16-250-3183
3 1/2"	90	4"	2	223	16-250-3120	—	16-250-3124	16-250-3121	16-250-3123
4"	102	4 5/8"	2	269	16-250-4000	—	16-250-4004	16-250-4001	16-250-4003
4 1/8"	105	4 47/64"	2	276	—	—	—	—	—
4 1/2"	114	5 3/32"	2	319	16-250-4120	—	16-250-4124	16-250-4121	—
5"	127	5 5/8"	2	398	16-250-5000	—	16-250-5004	16-250-5001	16-250-5003
5 1/8"	130	5 3/4"	2	417	—	—	—	—	—
5 1/2"	140	6 7/16"	2	443	—	—	—	—	—
6"	152	6 21/32"	2	482	—	—	16-250-6004	16-250-6001	—
8"	203	8 25/32"	2	780	—	—	16-250-8004	—	—



Now double the ozone resistance required by SAEJ2006



This certification provides unbiased, third party confirmation worldwide that these Shields hoses meet the highest standards of production quality. Certification ensures the proper level of product safety and inspires user confidence.

SHIELDS 400/402 VINYLVENT



Shields Vinylvent Ducting Hose is PVC supported by anodized wire helix. It is resistant to UV and the ozone. This hose is primarily used for venting of bilge fumes.

I.D.	mm	O.D.	mm	Wt. "C"	Bulk Pack 50' (76.2m) Length Code # White	Dist. Pkg. 10' (3.1m) Polypac Code # White
3"	76.2	3 1/8"	79.4	8	16-400-3000W	16-400-3003-1
4"	101.6	4 1/8"	104.8	10	16-400-4000W	16-400-4003-1
3"	76.2	3 1/8"	79.4	8	16-402-3000	16-402-3003-1
4"	101.6	4 1/8"	104.8	10	16-402-4000	16-402-4003-1



SHIELDS EXTRA HEAVY DUTY VINYLVENT



Shields Extra Heavy Duty Vinylvent has an extra heavy PVC wall. It is supported by vinyl coated helical wire and is resistant to ozone, UV, and corrosion. It is flame resistant and meets the UL 94V standard. This hose is primarily used for venting of bilge fumes.



I.D.	mm	O.D.	mm	Wt. "C"	Code No.
3"	76	3 1/8"	79.4	17	16-420-3000
4"	102	4 1/8"	104.8	25	16-420-4000

Bulk Pack: 3" 8 x 50 4" 4 x 50

SHIELDS FIBERVENT



Shields Fibervent is vinyl coated, woven fiberglass hose. It is supported by vinyl coated helical wire and is resistant to ozone, UV, and corrosion. The hose is flame resistant and meets the UL 181 Class 1 standard. This hose is primarily used for venting of bilge fumes and A/C ducting hose. The temperature ranges from -20° F to +250° F.

Bulk	m	I.D.	mm	O.D.	mm	Rating	Vac Wt. "C"	Code No.
6 x 25'	1.8x7.6	3"	76.2	3 1/4"	82.6	20	13	16-450-3000
8 x 25'	2.4x7.6	4"	101.6	4 1/4"	108	20	15	16-450-4000
8 x 25'	2.4x7.6	5"	127	5 1/4"	133.4	20	17	16-450-5000
4 x 25'	1.2x7.6	6"	152.4	6 1/4"	158.8	20	19	16-450-6000

SHIELDS AIR CONDITIONER DUCTING HOSE



Shields Air Conditioner Ducting Hose has a smooth tube for maximum airflow. This is a vinyl coated, woven fiberglass hose and is supported by vinyl coated helical wire. It is resistant to ozone, UV, and corrosion. The hose is flame resistant and meets the UL 94-V-0 standard. This hose is primarily used for venting of bilge fumes and A/C ducting hose. The temperature ranges from -20° – +200°F

Bulk	m	I.D.	mm	O.D.	mm	Wt. "C"	Code No.
5 x 25'	1.5x7.6	3"	76	3 1/4"	82.5	22	—
6 x 25'	1.8x7.6	4"	102	4 1/4"	108	24	16-460-4000
5 x 25'	1.5x7.6	5"	127	5 1/4"	133.4	32	16-460-5000
4 x 25'	1.2x7.6	6"	152	6 1/4"	158.8	36	—
2 x 25'	.6x7.6	7"	178	7 1/4"	184.2	44	16-460-7000

SHIELDS MARINE EXHAUST/WATER HOSE (No Wire)



Shields Marine Exhaust / Water Hose is reinforced with 2 or 4 plies of synthetic cord and is made of black, heavy-walled synthetic rubber. This hose is primarily used for straight connections in wet exhaust systems and engine water circulation lines. It is resistant to engine heat, exhaust fumes, ozone, mild chemicals, antifreeze and saltwater. This hose also has double the ozone resistance required by SAEJ2006. The temperature ranges from -20°F – +200°F continuous, +250°F intermittent. The hose meets SAE J2006 Type R1 standards.



This certification provides unbiased, third party confirmation worldwide that these Shields hoses meet the highest standards of production quality. Certification ensures the proper level of product safety and inspires user confidence.

Now double the ozone resistance required by SAEJ2006

I.D.	mm	O.D.	Ply	Wt. "C"	50' Coil Code #	12 1/2' Length Code #	6 1/4' Length Code #	10' Length Code #
1/2"	13	7/8"	2	24	16-200-0120	16-200-0124	16-200-0121	16-200-0123
5/8"	16	1 1/32"	2	33	16-200-0580	16-200-0584	16-200-0581	16-200-0583
3/4"	19	1 9/16"	2	37	16-200-0340	16-200-0344	16-200-0341	16-200-0343
7/8"	22	1 1/2"	2	42	16-200-0780	16-200-0784	16-200-0781	16-200-0783
1"	25	1 3/8"	2	48	16-200-1000	16-200-1004	16-200-1001	16-200-1003
1 1/8"	28	1 1/2"	2	52	16-200-1180	16-200-1184	16-200-1181	—
1 1/4"	32	1 5/8"	2	60	16-200-1140	16-200-1144	16-200-1141	—
1 3/8"	33	1 7/8"	2	62	—	—	—	—
1 3/4"	35	1 13/16"	2	66	16-200-1380	16-200-1384	16-200-1381	—
1 1/2"	38	1 15/16"	2	70	16-200-1120	16-200-1124	16-200-1121	16-200-1123
1 5/8"	42	2 1/32"	2	77	16-200-1580	16-200-1584	16-200-1581	—
1 3/4"	45	2 1/8"	2	82	16-200-1340	16-200-1344	16-200-1341	16-200-1343
1 7/8"	48	2 23/64"	2	96	16-200-1780	16-200-1784	16-200-1781	—
2"	51	2 31/64"	2	102	16-200-2000	16-200-2004	16-200-2001	16-200-2003
2 1/8"	54	2 19/32"	2	107	16-200-2180	16-200-2184	—	—
2 1/4"	58	2 3/4"	2	114	16-200-2140	16-200-2144	16-200-2141	—
2 3/8"	60	2 7/8"	2	132	16-200-2380	16-200-2384	—	16-200-2383
2 1/2"	63	3"	2	136	16-200-2120	16-200-2124	16-200-2121	16-200-2123
2 5/8"	67	3 1/32"	2	147	—	16-200-2584	16-200-2581	—
2 3/4"	70	3 1/8"	2	152	—	—	16-200-2341	—
2 7/8"	73	3 7/16"	2	174	—	16-200-2784	16-200-2781	—
3"	76	3 1/4"	2	182	16-200-3000	16-200-3004	16-200-3001	16-200-3003
3 1/8"	80	3 13/64"	2	190	—	16-200-3184	16-200-3181	—
3 1/4"	90	4 7/32"	2	198	—	16-200-3124	16-200-3121	16-200-3123
3 3/4"	95	4 9/32"	2	221	—	16-200-3344	16-200-3341	—
4"	102	4 17/32"	4	229	—	16-200-4004	16-200-4001	16-200-4003
4 1/2"	114	5 1/8"	2	300	—	16-200-4124	16-200-4121	—
5"	127	5 5/8"	2	392	—	16-200-5004	16-200-5001	16-200-5003
5 1/2"	140	6 3/16"	2	396	—	—	—	—
6"	152	6 1/16"	2	427	—	16-200-6004	16-200-6001	16-200-6003
8"	203	8 25/32"	4	670	—	16-200-8004	—	16-200-8003
10"	254	10 7/8"	4	934	—	16-200-10004	16-200-10001	—
12"	305	12 7/8"	4	1095	—	16-200-12004	16-200-12001	—
14"	350	14 7/8"	4	1430	—	—	—	—

* Special Order

SHIELDS NAUTIFLEX SILICONE EXHAUST HOSE

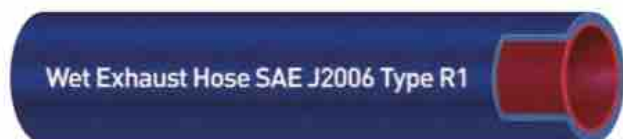

Shields Nautiflex Silicone Exhaust Hose has a blue silicone cover with a smooth finish for easy clean up. This hose is flexible, easy to install and has four plies of synthetic fabric. It also remains stable at elevated temperatures. This hose is primarily used for straight connections in the wet exhaust system and engine water circulation lines. The temperature ranges from -20°F – $+350^{\circ}\text{F}$. The hose meets SAE J2006 Type R1 and ISO 13363:2004 – Type 2 – Class B standards.

I.D.	mm	O.D.	Wt. "C"	3' (.9m) Length Code No.	6' (1.8m) Length Code No.	12' (3.7m) Length Code No.
1"	25	1 $\frac{3}{8}$ "	33.1	—	16-202-1001	16-202-1004
1 $\frac{1}{8}$ "	28	1 $\frac{1}{2}$ "	37.2	—	—	—
1 $\frac{1}{4}$ "	32	1 $\frac{5}{8}$ "	41.3	16-202-1140-36	16-202-1141	16-202-1144
1 $\frac{3}{8}$ "	35	1 $\frac{3}{4}$ "	45.4	—	—	—
1 $\frac{1}{2}$ "	38	1 $\frac{7}{8}$ "	49.6	16-202-1120-36	16-202-1121	16-202-1124
1 $\frac{3}{4}$ "	45	2 $\frac{1}{8}$ "	57.8	—	—	—
2"	51	2 $\frac{3}{8}$ "	66.1	—	16-202-2001	16-202-2004
2 $\frac{3}{8}$ "	60	2 $\frac{3}{4}$ "	78.5	16-202-2380-36	—	16-202-2384
2 $\frac{1}{2}$ "	63	2 $\frac{7}{8}$ "	82.6	16-202-2120-36	16-202-2121	16-202-2124
2 $\frac{3}{4}$ "	67	2 $\frac{33}{64}$ "	86.8	16-202-2580-36	16-202-2581	16-202-2584
2 $\frac{7}{8}$ "	70	3 $\frac{1}{8}$ "	90.9	—	—	—
2 $\frac{7}{8}$ "	73	3 $\frac{1}{4}$ "	94.1	—	—	—
3"	76	3 $\frac{3}{8}$ "	99.2	16-202-3000-36	16-202-3001	16-202-3004
3 $\frac{1}{4}$ "	82	3 $\frac{1}{2}$ "	103.4	16-202-3140-36	16-202-3141	16-202-3144
3 $\frac{1}{2}$ "	90	3 $\frac{7}{8}$ "	115.7	16-202-3120-36	16-202-3121	16-202-3124
4"	102	4 $\frac{3}{8}$ "	132	16-202-4000-36	16-202-4001	16-202-4004
5"	127	5 $\frac{1}{8}$ "	165	16-202-5000-36	16-202-5001	16-202-5004
5 $\frac{1}{2}$ "	140	5 $\frac{7}{8}$ "	181.5	—	—	—
6"	152	6 $\frac{3}{8}$ "	198	16-202-6000-36	16-202-6001	16-202-6004
8"	203	8 $\frac{3}{8}$ "	264	16-202-8000-36	16-202-8001	16-202-8004
10"	254	10 $\frac{3}{8}$ "	330	16-202-1000036	—	16-202-10004
12"	305	12 $\frac{3}{8}$ "	396	16-202-1200036	—	16-202-12004
14"	350	14 $\frac{5}{8}$ "	462	16-202-1400036	—	—



SHIELDSFLEX II MARINE WATER/EXHAUST HOSE (w/ Wire)

Shieldsflex II Marine Water/Exhaust Hose has a black synthetic rubber tube and cover. It is reinforced with wire helix imbedded between plies of HD synthetic cord. It is resistant to exhaust fumes, ozone, mild chemicals, antifreeze and saltwater. This hose is abrasion and odor permeation resistant. It now has double the ozone resistance required by the SAEJ2006. Shieldsflex II is primarily used for engine intake, wet exhaust connections (use where bends or long lengths are required), bilge pump intake/discharge, scupper lines, toilet intake/discharge, and holding tank vent/pump out. The temperature ranges from -20° F – +200°F continuous, +250°F intermittent. The hose meets SAE J2006 Type R2 standards.



I.D.	mm	O.D.	Ply	Wt. "C"	50' (15.2m) Coil Code #	25' (7.6m) Cartons	12 1/2' (3.8m) Length Code #	6 1/4' (1.9m) Length Code #	10' (3.1m) Length Code #
1/8"	13	27/32"	2	24	16-250-0120	16-250-0125	16-250-0124	16-250-0121	16-250-0123
5/16"	16	81/64"	2	28	16-250-0580	16-250-0585	16-250-0584	16-250-0581	16-250-0583
3/4"	19	1 1/16"	2	32	16-250-0340	16-250-0345	16-250-0344	16-250-0341	16-250-0343
7/8"	22	1 3/16"	2	36	16-250-0780	—	16-250-0784	16-250-0781	16-250-0783
1"	25	1 3/8"	2	40	16-250-1000	16-250-1005	16-250-1004	16-250-1001	16-250-1003
1 1/8"	28	1 7/16"	2	44	16-250-1180	16-250-1185	16-250-1184	16-250-1181	16-250-1183
1 1/4"	32	1 1/2"	2	50	16-250-1140	16-250-1145	16-250-1144	16-250-1141	16-250-1143
1 3/16"	33	1 5/8"	2	51	16-250-1560	—	16-250-1564	16-250-1561	16-250-1563
1 3/8"	35	1 23/32"	2	58	16-250-1380	—	16-250-1384	16-250-1381	16-250-1383
1 1/2"	38	1 53/64"	2	62	16-250-1120	16-250-1125	16-250-1124	16-250-1121	16-250-1123
1 5/8"	42	2"	2	80	16-250-1580	—	16-250-1584	16-250-1581	16-250-1583
1 3/4"	45	2 1/8"	2	88	16-250-1340	—	16-250-1344	16-250-1341	16-250-1343
1 7/8"	48	2 19/64"	2	93	16-250-1780	—	16-250-1784	16-250-1781	16-250-1783
2"	51	2 13/32"	2	99	16-250-2000	—	16-250-2004	16-250-2001	16-250-2003
2 1/8"	54	2 17/32"	2	107	16-250-2180	—	16-250-2184	16-250-2181	16-250-2183
2 1/4"	58	2 11/16"	2	127	16-250-2140	—	16-250-2144	16-250-2141	16-250-2143
2 3/8"	60	2 3/4"	2	132	16-250-2380	—	16-250-2384	16-250-2381	16-250-2383
2 1/2"	63	2 7/16"	2	137	16-250-2120	—	16-250-2124	16-250-2121	16-250-2123
2 5/8"	67	3 1/16"	2	147	—	—	16-250-2584	16-250-2581	—
2 3/4"	70	3 3/16"	2	164	16-250-2340	—	16-250-2344	16-250-2341	16-250-2343
2 7/8"	73	3 5/16"	2	170	16-250-2780	—	16-250-2784	16-250-2781	16-250-2783
3"	76	3 7/16"	2	177	16-250-3000	—	16-250-3004	16-250-3001	16-250-3003
3 1/8"	80	3 5/8"	2	200	16-250-3180	—	16-250-3184	16-250-3181	16-250-3183
3 1/2"	90	4"	2	223	16-250-3120	—	16-250-3124	16-250-3121	16-250-3123
4"	102	4 5/8"	2	269	16-250-4000	—	16-250-4004	16-250-4001	16-250-4003
4 1/8"	105	4 17/64"	2	276	—	—	—	—	—
4 1/2"	114	5 3/32"	2	319	16-250-4120	—	16-250-4124	16-250-4121	—
5"	127	5 5/8"	2	398	16-250-5000	—	16-250-5004	16-250-5001	16-250-5003
5 1/8"	130	5 3/4"	2	417	—	—	—	—	—
5 1/2"	140	6 3/16"	2	443	—	—	—	—	—
6"	152	6 21/32"	2	482	—	—	16-250-6004	16-250-6001	—
8"	203	8 23/32"	2	780	—	—	16-250-8004	—	—



Now double the ozone resistance required by SAEJ2006



This certification provides unbiased, third party confirmation worldwide that these Shields hoses meet the highest standards of production quality. Certification ensures the proper level of product safety and inspires user confidence.

SHIELDSAUST-C

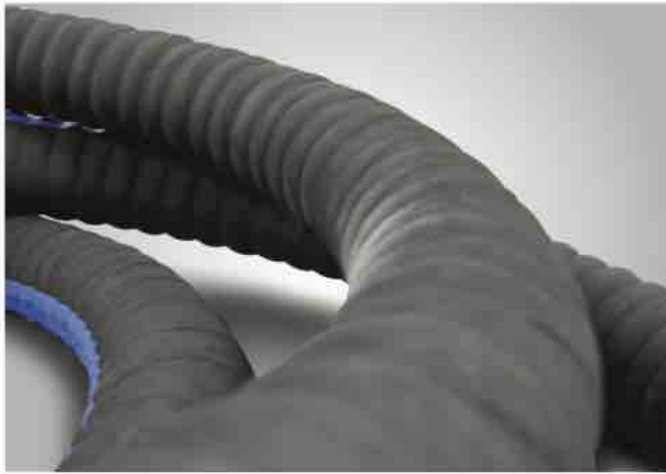

Now double the ozone resistance required by SAEJ2006

Shieldsaust – C Hose has a black synthetic rubber tube and cover. It is reinforced with double wire helix imbedded between plies of synthetic cord and is abrasion resistant. It is resistant to exhaust fumes, ozone, mild chemicals, antifreeze, and saltwater. This hose is primarily used for wet exhaust connections with significant bends, engine intake and scupper lines. The temperature ranges from -20°F to +200°F continuous, +250°F intermittent. The hose now has double the ozone resistance required by SAEJ2006. This hose meets SAE J2006 Type R2 standards.

I.D.	mm	O.D.	Ply	Wt. "C"	50' (15.2m) Coil Code #	12 1/2' (3.8m) Length Code #	6 1/4' (1.9m) Length Code #	10' (3.1m) Length Code #
3/4"	19	1 1/8"	2	27	16-252-0340	16-252-0344	16-252-0341	16-252-0343
1"	25	1 11/32"	2	33	16-252-1000	16-252-1004	16-252-1001	16-252-1003
1 1/2"	32	1 39/64"	2	45	16-252-1140	16-252-1144	16-252-1141	16-252-1143
1 7/8"	38	1 15/16"	2	70	16-252-1120	16-252-1124	16-252-1121	16-252-1123
1 5/8"	42	2 1/32"	2	80	16-252-1580	16-252-1584	—	16-252-1583
1 3/4"	45	2 1/16"	2	85	16-252-1340	16-252-1344	16-252-1341	16-252-1343
1 7/8"	48	2 3/16"	2	91	16-252-1780	16-252-1784	16-252-1781	16-252-1783
2"	51	2 1/16"	2	95	16-252-2000	16-252-2004	16-252-2001	16-252-2003
2 1/8"	54	2 3/16"	2	100	—	16-252-2184	—	—
2 1/4"	58	2 29/32"	2	107	—	16-252-2144	—	—
2 5/8"	60	2 51/64"	2	110	16-252-2380	16-252-2384	16-252-2381	16-252-2383
2 1/2"	63	2 59/64"	2	115	16-252-2120	16-252-2124	16-252-2121	16-252-2123
2 3/4"	70	3 1/16"	2	126	—	16-252-2344	16-252-2341	—
2 7/8"	73	3 3/16"	2	137	16-252-2780	16-252-2784	—	16-252-2783
3"	76	3 7/16"	2	143	16-252-3000	16-252-3004	16-252-3001	16-252-3003
3 1/8"	80	3 29/32"	2	150	—	16-252-3184	16-252-3181	16-252-3183
3 1/2"	90	4 1/16"	2	200	16-252-3120	16-252-3124	16-252-3121	16-252-3123
4"	102	4 7/16"	2	231	16-252-4000	16-252-4004	16-252-4001	16-252-4003
4 1/8"	105	4 11/16"	2	238	—	16-252-4184	16-252-4181	—
4 1/2"	114	5 1/8"	2	278	—	16-252-4124	—	—
5"	127	5 9/16"	2	300	—	—	16-252-5001	—
6"	152	6 3/16"	2	394	16-252-6000	16-252-6004	16-252-6001	16-252-6003
8"	203	8 11/16"	2	607	—	16-252-8004	16-252-8001	—



This certification provides unbiased, third party confirmation worldwide that these Shields hoses meet the highest standards of production quality. Certification ensures the proper level of product safety and inspires user confidence.

SHIELDS NAUTIFLEX CORRUGATED SILICONE EXHAUST HOSE



Shields Nautiflex Corrugated Silicone

Exhaust Hose has a blue silicone tube and cover with a smooth finish for easy cleaning. The hose is wire reinforced and will not collapse under suction or in a bend. The corrugated cover allows the hose to bend for easy installation. The Nautiflex, two ply construction, has wire captured between fabric plies. This hose is primarily used for main engine exhaust, generator exhaust, engine coolant circulation, engine intake and generator intake. It is resistant to exhaust fumes, ozone, mild chemicals, antifreeze and saltwater. The hose remains stable at elevated temperatures. The temperatures ranges from -20°F – +350°F. This hose meets SAEJ2006 Type R2 and ISO 13362:2004 – Type 1 – Class B standards.

ID	mm	OD	WT °C"	10' (3.1m) length Code No.	12 1/2' (3.8m) Length Code No.	50' (15.2m) coll Code No.	6 1/4' (3.8m) Length Code No.
3/4"	19	1 3/8"	34	—	16-262-0344	16-262-0340	—
1"	25	1 27/64"	42	16-262-1003	16-262-1004	16-262-1000	—
1 1/8"	28	1 1/2"	46	16-262-1183	16-262-1184	16-262-1180	—
1 1/4"	32	1 45/64"	52	16-262-1143	16-262-1144	16-262-1140	—
1 3/8"	35	1 55/64"	60	16-262-1383	16-262-1384	16-262-1380	—
1 1/2"	38	2"	71	16-262-1123	16-262-1124	16-262-1120	—
1 5/8"	42	2 11/64"	74	16-262-1583	—	—	—
1 3/4"	45	2 19/64"	78	16-262-1343	16-262-1344	16-262-1340	—
1 7/8"	48	2 13/32"	82	16-262-1783	16-262-1784	16-262-1780	—
2"	51	2 7/16"	87	16-262-2003	16-262-2004	16-262-2000	—
2 1/8"	54	2 5/8"	94	—	—	—	—
2 3/8"	60	2 7/8"	101	16-262-2383	16-262-2384	16-262-2380	—
2 1/2"	63	3 3/64"	113	16-262-2123	16-262-2124	16-262-2120	—
2 3/4"	70	3 31/64"	125	16-262-2343	16-262-2344	16-262-2340	—
2 7/8"	73	3 7/16"	134	16-262-2783	16-262-2784	16-262-2780	—
3"	76	3 35/64"	139	16-262-3003	16-262-3004	16-262-3000	—
3 1/2"	90	4 13/64"	227	16-262-3123	16-262-3124	16-262-3120	—
4"	102	4 49/64"	255	16-262-4003	16-262-4004	16-262-4000	—
5"	127	5 3/8"	310	16-262-5003	—	16-262-5000	—
6"	152	6 15/64"	484	16-262-6003	—	—	16-262-6001
8"	203	9 7/64"	768	16-262-8003	—	—	—
10"	254	11 17/64"	1136	16-262-10003	—	—	—
12"	305	13.359"	1518	16-262-12003	—	—	—
14"	350	15.281"	1812	—	—	—	—
16"	404	17.562"	2277	—	—	—	—

* Special Order

SHIELDS COMPLEX - ALL IN ONE HOSE FOR INSPECTED VESSELS

Shields Complex is a versatile wire reinforced hose specially designed for inspected vessels. Complex is rated for fuel, vital water and non-vital water systems on boats requiring SAE J1942 hoses. Applications include bilge, coolant, oil and fuel systems using gasoline, gasohol, diesel, bio-diesel, wet exhaust systems, non-potable water systems, engine intake, toilet and holding tank connections.



Tube: Black Nitrile

Reinforcement: 2 textile plies w/ dual wire helix

Cover: Black Chlorprene

Temp. Range: -20F to +212F

Specifications - SAE J1942 Code F, VW, NVW;
SAE J1527 A1; SAE J2006 R2; SAE 20R2 B;
SAE J20R4 B; SAE 20R5 B, SAE 30R5,
ISO 7840 A1

Additional sizes available. 150' minimum order.

I.D.	mm	O.D.	PLY	WL °C*	Bend Radius	WP	50' Coil Code #	12 1/2' (3.8m) Length Code #	10' (3.1m) Length Code #	6 1/4' (3.6m) Length Code #
5/8"	15.9	1"	2	33	1.5	75	16-321-0580	16-321-0584	16-321-0583	16-321-0581
3/4"	19.1	1.19"	2	39	1.5	75	16-321-0340	16-321-0344	16-321-0343	16-321-0341
1"	25.4	1.41"	2	53	2	75	16-321-1000	16-321-1004	16-321-1003	16-321-1001
1 1/8"	28.6	1.56"	2	62	3	75	16-321-1180	16-321-1184	—	16-321-1181
1 1/4"	31.8	1.66"	2	64	3	75	16-321-1140	16-321-1144	16-321-1143	16-321-1141
1 1/2"	38.1	1.91"	2	78	3	50	16-321-1120	16-321-1124	16-321-1123	16-321-1121
2"	50.8	2.48"	2	118	5	50	16-321-2000	16-321-2004	16-321-2003	16-321-2001

SHIELDS SILICONE COUPLERS - SINGLE & DOUBLE HUMP W/ Reinforced Fabric



SINGLE HUMP

DOUBLE HUMP

Shields Single and Double Hump Couplers have a blue silicone cover with a smooth finish for easy clean up and are fabric reinforced. The couplers remain stable at elevated temperatures and provide angular and longitudinal vibration absorption in wet exhaust systems. Shields couplers correct slight offsets in pipes. They are resistant to exhaust fumes, ozone, mild chemicals, antifreeze and saltwater. The temperature range is -20°F to +350°F. It meets SAE J2006 Type R1 standards.

	I.D.	mm	Length	mm	Wt. Es. (lbs)	Code No.
SINGLE	4"	102	6"	152	2	16-272-4000
	5"	127	6"	152	2	16-272-5000
	6"	152	8"	203	2	16-272-6000
	8"	203	8"	203	3	16-272-8000
	10"	254	12"	305	4	16-272-10000
DOUBLE	6"	152.4	14"	356	3	16-274-6000
	8"	203.2	14"	356	3	16-274-8000
	10"	254	14"	356	4	16-274-10000

SHIELDS SILICONE COUPLERS - SINGLE HUMP

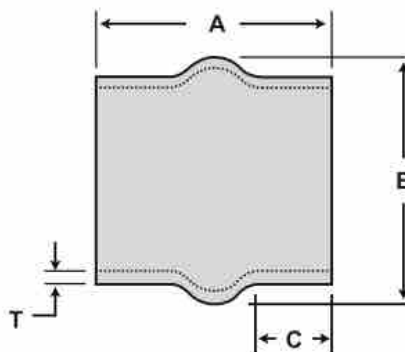

Hump Hose

Shields Silicone Single and Double Hump Couplers are very high temperature silicone exhaust connectors. The maximum operating temperature is 450°F (232°C). It meets SAE J2006 Type R1 standards.

Part Number	ID	mm	A	mm	B	mm	C	mm	T	mm
16-220S4000	4.0	101.6	5.25	133	5.50	140	2.00	51	.25	6
16-220S5000	5.0	127	6.00	152	6.50	165	2.25	57	.25	6
16-220S8000	6.0	152.4	7.00	178	7.50	190	2.75	70	.25	6

SHIELDS SILICONE ELBOWS - 45°

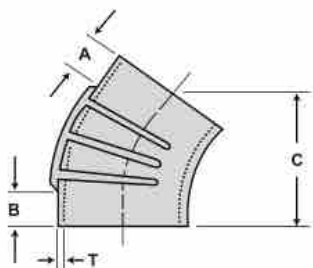

45° Elbow



Part Number	ID	mm	A	mm	B	mm	C	mm	T	mm
16-245S3000	3.0	76.2	1.50	38	1.50	38	5.50	140	.25	6
16-245S4000	4.0	101.6	1.50	38	1.50	38	5.50	140	.25	6
16-245S5000	5.0	127	1.62	41	1.62	41	5.25	133	.25	6
16-245S6000*	6.0	152.4	2.00	51	2.00	51	6.50	165	.25	6

* Asterisk indicates ribbed elbow

SHIELDS SILICONE ELBOWS - 90°

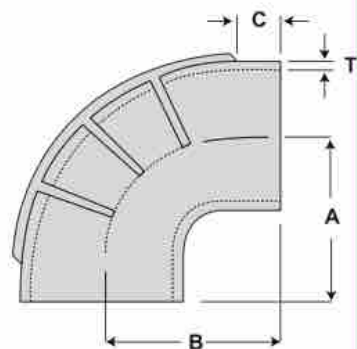

90° Elbow

Part Number	ID	mm	A	mm	B	mm	C	mm	T	mm
16-290S2000	2.0	50.8	4.25	108	5.25	133	2.75	70	.20	5
16-290S3000	3.0	76.2	5.25	133	5.25	133	1.50	38	.25	6
16-290S4000	4.0	101.6	5.75	146	5.75	146	1.50	38	.25	6
16-290S5000	5.0	127	6.00	152	6.00	152	1.62	41	.25	6
16-290S6000*	6.0	152.4	7.00	178	7.00	178	2.25	57	.25	6
16-290S8000*	8.0	203.2	8.50	216	8.50	216	2.00	51	.37	9

*Asterisk indicates ribbed elbow 90S6000

SHIELDS EPDM COUPLERS - SINGLE HUMP

100% High temperature EPDM rubber. Maximum operating temperature 250° F (120° C).

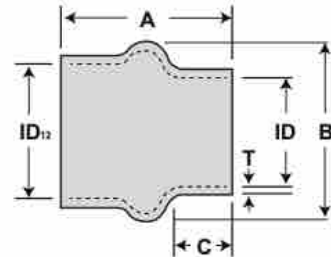

Reducing Hump Hose

Hump Hoses

Part Number	ID	mm	A	mm	B	mm	C	mm	T	mm	mm
16-220-3000-1	3.00	76.2	5.25	133.35	4.50	114.3	2.00	50.8	0.25	6.35	
16-220-3120-1	3.50	88.9	5.25	133.35	5.00	127	2.00	50.8	0.25	6.35	
16-220-4000-1	4.00	101.6	5.25	133.35	5.50	139.7	2.00	50.8	0.25	6.35	
16-220-4120-1	4.50	114.3	5.25	133.35	6.00	152.4	1.75	44.45	0.25	6.35	
16-220-5000-1	5.00	127	6.00	152.4	6.50	165.1	2.25	57.15	0.25	6.35	
16-220-6000-1	6.00	152.4	7.00	177.8	7.50	190.5	2.75	69.85	0.25	6.35	
16-220-8000-1	8.00	203.2	5.00	127	9.50	241.3	1.50	38.1	0.25	6.35	
16-220-10000-1	10.00	254	6.00	152.4	11.50	292.1	2.00	50.8	0.25	6.35	

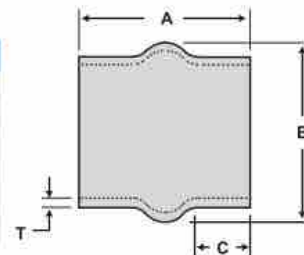

Hump Hose

Reducing Hump Hoses

Part Number	ID1	mm	ID2	mm	A	mm	B	mm	C	mm	T	mm
16-221-4X3	4.00	101.6	3.00	76.2	5.25	133.8	5.50	139.7	1.50	38.1	0.25	6.35
16-221-5X4	5.00	127	4.00	101.6	5.50	139.7	6.50	165.1	1.50	38.1	0.25	6.35
16-221-6X5	6.00	152.4	5.00	127	6.00	152.4	7.50	190.5	2.12	53.85	0.25	6.35
16-221-8X6	8.00	203.2	6.00	152.4	6.00	152.4	9.50	241.3	1.38	35.05	0.25	6.35

SHIELDS EPDM ELBOWS - 45°

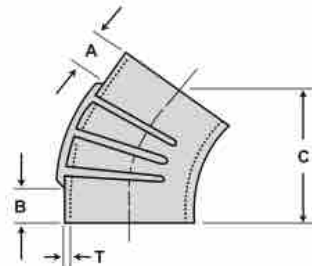

45° Elbow

*Asterisk indicates ribbed elbow

Part Number	ID	mm	A	mm	B	mm	C	mm	T	mm	mm
16-245-3000-1	3.00	76.2	1.50	38.1	1.50	38.1	5.50	139.7	0.25	6.35	
16-245-3120-1	3.50	88.9	1.50	38.1	1.50	38.1	5.50	139.7	0.25	6.35	
16-245-4000-1	4.00	101.6	1.50	38.1	1.50	38.1	5.50	139.7	0.25	6.35	
16-245-4120-1	4.50	114.3	1.50	38.1	1.50	38.1	5.75	146.1	.25	6.35	
16-245-5000-1	5.00	127	1.62	41.15	1.62	41.15	5.25	133.35	0.25	6.35	
16-245-6000-1*	6.00	152.4	2.00	50.8	2.00	50.8	6.50	165.1	0.25	6.35	
16-245-8000-1*	8.00	203.2	2.25	57.15	2.25	57.15	8.25	209.6	0.37	9.40	

SHIELDS EPDM ELBOWS - 90°

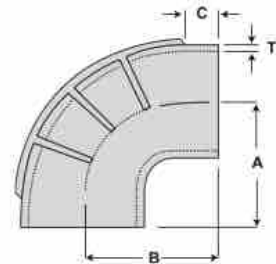

90° Elbow

*Asterisk indicates ribbed elbow

Part Number	ID	mm	A	mm	B	mm	C	mm	T	mm
16-290-2000-1	2.00	50.8	4.25	107.95	5.25	133.35	2.75	69.85	0.20	5.08
16-290-2120-1	2.50	63.5	4.25	107.95	4.25	107.95	1.50	38.1	0.20	5.08
16-290-3000-1	3.00	76.2	5.25	133.35	5.25	133.35	1.50	38.1	0.25	6.35
16-290-3120-1	3.50	88.9	5.50	139.7	5.50	139.7	1.75	44.45	0.25	6.35
16-290-4000-1	4.00	101.6	5.75	146.05	5.75	146.05	1.50	38.1	0.25	6.35
16-290-4120-1	4.50	114.3	6.00	152.4	6.00	152.4	1.50	38.1	0.25	6.35
16-290-5000-1	5.00	127	6.00	152.4	6.00	152.4	1.62	41.15	0.25	6.35
16-290-6000-1*	6.00	152.4	7.00	177.8	7.00	177.8	2.25	57.15	0.25	6.35
16-290-8000-1*	8.00	203.2	8.50	215.9	8.50	215.9	2.00	50.8	0.37	9.40

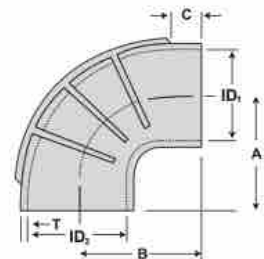
SHIELDS EPDM ELBOWS
- 90° REDUCING ELBOW

90° Reducing Elbow

Part Number	ID1	mm	ID2	mm	A	mm	B	mm	C	mm	T	mm
16-291-5004001	4.00	101.6	5.00	127	5.75	146	6.00	152.4	1.75	44.45	0.25	6.35

Also available with series 720 T-bolt clamps. Order part number with "Kit" Suffix.



SHIELDS EXHAUST PROTECTOR VALVES

Specially compounded rubber flapper valves designed to prevent water from entering the exhaust system in following seas or when backing down. Made with weather resistant EPDM with U/V stabilizer.

Code #	Pipe Size	mm	O.E.M.	O.E. #
18-4456*	3"	76.2	Mercury	34765A1
18-4457*	4"	101.6	Mercury	12644A1
18-4458*	5" or 6"	127 or 152.4	—	—

* Display Packaged

Must be cut to fit 5" pipe (two 45° cuts required)

18-#s include stainless steel hose clamp.



SHIELDS EXHAUST HOSE CLAMPS T-BOLT BAND CLAMPS

Diameter Range	mm	Hose I.D.	mm	Wt. "C"	Code No.
1.18 - 1.47	30.0 - 37.3	1"	25.4	9.4	18-720-1000 ②
1.70 - 2.03	43.2 - 51.6	1 1/2"	38.1	12.5	18-720-1120 ②
1.48 - 1.62	37.59 - 41.15	1 1/4"	31.75	11	18-720-1140 ②
2.27 - 2.67	57.7 - 67.8	2"	50.8	12.8	18-720-2000
2.68 - 3.34	68.1 - 84.8	2 1/2"	63.5	15.6	18-720-2120
3.10 - 3.76	78.7 - 95.5	3"	76.2	15.8	18-720-3000
3.59 - 4.25	91.2 - 108	3 1/2"	88.9	17.2	18-720-3120
4.18 - 4.84	106.2 - 122.9	4"	101.6	18.8	18-720-4000
4.25 - 4.91	108.0 - 124.7	4 1/8"	104.8	18.9	18-720-4180
4.75 - 5.41	120.7 - 137.4	4 1/2"	114.3	20	18-720-4120
4.68 - 5.34	118.9 - 135.6	4 1/2"	114.3	20	18-720-4120S *
5.30 - 5.96	134.6 - 151.4	5"	127.0	22	18-720-5000
5.18 - 5.84	131.6 - 148.3	5"	127.0	22	18-720-5000S *
5.75 - 6.41	146.1 - 162.8	5 1/2"	139.7	25	18-720-5120
5.68 - 6.34	144.3 - 161.0	5 1/2"	139.7	25	18-720-5120S *
6.38 - 7.04	162.1 - 178.8	6"	152.4	27	18-720-6000
6.18 - 6.84	157.0 - 173.7	6"	152.4	27	18-720-6000S *
8.42 - 9.08	213.9 - 230.6	8"	203.2	29	18-720-8000
8.18 - 8.84	207.8 - 224.5	8"	203.2	29	18-720-8000S *
10.45 - 11.11	265.4 - 282.2	10"	254.0	31	18-720-10000
10.18 - 10.84	258.6 - 275.3	10"	254.0	31	18-720-10000S *
12.38 - 13.04	314.5 - 331.2	12"	304.8	33	18-720-12000
12.18 - 12.84	309.4 - 326.1	12"	304.8	33	18-720-12000S *
14.50 - 15.16	368.3 - 385.1	14"	355.6	41.1	18-720-14000
14.30 - 14.96	363.2 - 380.0	14"	355.6	41.1	18-720-14000S *

② Clamps for 1" and 1 1/2" are 1/4" wide

* Designed to fit Series 202 silicone exhaust hose

SHIELDS CONSTANT TENSION CLAMPS

Diameter Range (in.)	Sierra No.	Fits Series 202 Sizes
1.75 - 2.625	18-725-2000	1 3/4", 1 7/8", 2"
4.25 - 5.125	18-725-4000	4", 4 1/2"

• Clamping Silicone Heater/Exhaust Hose

SHIELDS HOSE CLAMPS

All components are manufactured from marine grade 316 stainless steel. These clamps are designed to fit many applications from 5/16" to 7" diameter hoses.



Sierra No.	Bulk No.	Diameter Size	Std. No.
18-710-06-2	18-710-06	7/16" to 3/4"	006
18-710-08-2	18-710-08	1/2" to 7/8"	008
18-710-10-2	18-710-10	5/16" to 1 1/16"	010
18-710-12-2	18-710-12	1 1/16" to 1 1/4"	012
18-710-16-2	18-710-16	1 1/16" to 1 1/2"	016
18-710-20-2	18-710-20	1 3/16" to 1 3/4"	020
18-710-24-2	18-710-24	1 1/16" to 2"	024
18-710-28-2	18-710-28	1 5/16" to 2 1/4"	028
18-710-32-2	18-710-32	1 9/16" to 2 1/2"	032
18-710-36-2	18-710-36	1 13/16" to 2 3/4"	036
18-710-40-2	18-710-40	2 1/16" to 3"	040
18-710-44-2	18-710-44	2 5/16" to 3 1/4"	044
18-710-48-2	18-710-48	2 9/16" to 3 1/2"	048
18-710-52-2	18-710-52	2 13/16" to 3 3/4"	052
18-710-56-2	18-710-56	3 1/16" to 4"	056
18-710-60-2	18-710-60	3 5/16" to 4 1/4"	060
18-710-64-2	18-710-64	3 9/16" to 4 1/2"	064
18-710-72-2	18-710-72	4 1/16" to 5"	072
18-710-80-2	18-710-80	4 9/16" to 5 1/2"	080
18-710-88-2	18-710-88	5 1/16" to 6"	088
18-710-96-2	18-710-96	5 5/8" to 6 1/2"	096
18-710-104-2	18-710-104	5" to 7"	104

SHIELDS EXPANDABLE BRAIDED SLEEVING (Scissor Cut)

Shields Expandable Conduit is designed to be cut with a scissors making it ideal for field installation where a hot knife required by other conduit is not practical. Conduit features a dense braid for excellent coverage and high abrasion resistance. Temperature range -94°F to 257°F, melt temperature 482°F. Meets RoHS, ABYC & UL 94 V2 standards.

Part Number	Description	Expansion Range		Shop Spool Ft.	Wt./Spool lbs.
		Min.	Max.		
16-129-0147	1/4" Expandable Braided Sleevng	5/32"	7/16"	100	0.46
16-129-0127	1/2" Expandable Braided Sleevng	1/4"	3/4"	100	0.82
16-129-0348	3/4" Expandable Braided Sleevng	5/8"	1"	75	0.84
16-129-1006	1" Expandable Braided Sleevng	3/4"	1 3/16"	50	0.62
16-129-1126	1 1/2" Expandable Braided Sleevng	1 1/4"	2"	50	0.93
16-129-2006	2" Expandable Braided Sleevng	1 3/4"	2 1/2"	50	1.75



SHIELDS FLAME RETARDANT SPLIT WIRE CONDUIT

Flame retardant polypropylene is black with a blue stripe. It provides chafing protection for wiring systems and is split longitudinally for easy access to harness. It has a temperature range of +275°F. It meets ABYC standard 8.15.19. and UL 94 V2.



I.D.	mm	Wt. "C"	Code #	Pack	m	Dist. Pkg.		
						100' (30.1m) R/O Ctn. Code #	50' (15.2m) R/O Ctn. Code #	50' (15.2m) Box Code #
1/4"	6.4	1.26	16-128-0140B	3200'	975	16-128-0147B	16-128-0146B	16-128-0146B-1
3/8"	9.5	1.58	16-128-0380B	1800'	549	16-128-0387B	16-128-0386B	16-128-0386B-1
1/2"	12.7	2.31	16-128-0120B	1100'	335	16-128-0127B	16-128-0126B	16-128-0126B-1
5/8"	15.9	2.94	16-128-0580B	750'	229	16-128-0587B	16-128-0586B	16-128-0586B-1
3/4"	19.1	3.47	16-128-0340B	450'	137	16-128-0347B	16-128-0346B	16-128-0346B-1
1"	25.4	5.78	16-128-1000B	300'	91	16-128-1007B	16-128-1006B	16-128-1006B-1
1 1/4"	31.8	9.24	16-128-1140B	200'	61	—	16-128-1146B	—
1 1/2"	38.1	15.23	16-128-1120B	100'	31	—	16-128-1126B	—
2"	50.8	21.00	16-128-2000B	100'	31	—	—	—

SHIELDS STERNFLEX



Shields Sternflex has a polyethylene co-polymer wall with an integral polyethylene helix. It is resistant to abrasion, crushing and UV. This hose is primarily used as a cover for the harness and for the hoses on the bracket mounted on outboard engines.



	I.D.	mm	Bend Radius	mm	Wt. "C"	Bulk Pack 50' (15.2m) Length Code No.	Dist. Pkg. 10' (3.1m) Box Code No.
	2"	50.8	3	76.2	39	16-126-2000B	16-126-2003B
NEW	2"	50.8	3	76.2	39	16-126-2000G	16-126-2003G
NEW	2"	50.8	3	76.2	39	16-126-2000W	16-126-2003W

B= Black

G= Grey

W= White

RIGGING FLANGE

Use with Shields
2" Sternflex P/N 16-126-2000B



18-9761B - Part No.

- U/V stabilized black plastic flange

NEW

18-9761G - Part No.

- U/V stabilized grey plastic flange

NEW

18-9761W - Part No.

- U/V stabilized white plastic flange

RIGGING HOSE KIT

Hides all engine cables and hoses
Can be added to any style outboard



18-9883B - Part No.

- Contains:
 - (1) U/V stabilized flange
 - 5' 2" Black Sternflex

NEW

18-9883G - Part No.

- Contains:
 - (1) U/V stabilized flange
 - 5' 2" Grey Sternflex

NEW

18-9883W - Part No.

- Contains:
 - (1) U/V stabilized flange
 - 5' 2" White Sternflex

SHIELDS NEOPRENE SHEET RUBBER

Solid Neoprene sheet rubber is designed for use under fuel tanks to comply with USCG requirements for air space. Also for gaskets, component padding and under wire straps. It can be custom cut to a variety of strips and shapes. It is offered in bulk rolls 36" wide x 10' long.



BULK SHEET

Thickness	mm	Width	mm	Length	mm	Code No.
1/8"	3.2	36"	914.4	10'	3.1	N18NEO60
3/16"	4.8	36"	914.4	10'	3.1	N316NEO60
1/4"	6.4	36"	914.4	10'	3.1	N14NEO60
3/8"	9.5	36"	914.4	10'	3.1	N38NEO60

DISTRIBUTOR BOXES

Thickness	mm	Width	mm	Length	mm	Code No.
1/8"	3.2	2"	50.8	10'	3.1	16-18X2X10
1/4"	6.4	2"	50.8	10'	3.1	16-14X2X10
3/8"	9.5	2"	50.8	10'	3.1	16-38X2X10
1/8"	3.3	1"	25.4	10'	3.1	16-18X1X10
1/4"	6.4	1"	25.4	10'	3.1	16-14X1X10
3/8"	9.7	1"	25.4	10'	3.1	16-38X1X10



SHIELDS SPEEDOMETER PITOT TUBING

This black vinyl tubing is HW reinforced with a polyester braid and provides a tight connection between your speedometer pickup (Pitot) and your speedometer.



Nominal I.D.	mm	Braid	Wt. "C"	Code #	Bulk Pack	mm	Dist. Pkg. 25' (7.6m) Polypac Code #
1/8" (.125")	3.2	0	2.2	16-151-0180	1500'	457.2	16-151-0185
4 mm (.157")	4.0	1	4.3	16-151-0180H.W.	300'	91.4	16-151-0185 H.W.



23-1100
AIR FILTER

Replaces: Kohler 267709
Fits: 3.5 CFZ, 4 CZ, 5 CFZ, 6.5 CZ



23-1101
AIR FILTER

Replaces: Westerbeke 39705
Fits: 8.0 BTDA(60Hz) / 8.0 BTDA(50Hz), 10.0 BTDA(60Hz) / 7.5 BTDA(50Hz), 12.5 BTDB(60Hz) / 9.4 BTDB(50Hz), 15.0 BTDC(60Hz) / 12.0 BTDC(50Hz)

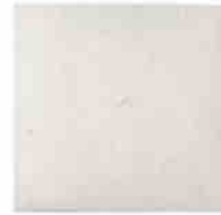

23-1104
AIR FILTER

Replaces:
Fischer Panda IC78.460.000B
Fits: PMS 4200, PMS04, PMS15, PMS 15 DP, PMS 20, PMS 22



23-1105
AIR FILTER

Replaces: Fischer Panda IC78.460.000A
Fits: PMS 8 Mini, PMS 8 DP, PMS 6500, PMS 12 DP, PMS 12 Mini



23-1102
AIR FILTER ELEMENT

Replaces: Northern Lights 24-22009
Fits: M843NW3: 12/10Kw, M844W3: 16/12KW, M844LW3: 20/16Kw



23-1103
AIR FILTER ELEMENT

Replaces: Northern Lights 24-28003
Fits: M673LD3: 5 / 4.5Kw, M673L3: 6/5Kw



23-1130
AIR FILTER

Replaces: Kohler 278857
Fits: 4 CCF0Z(variation 4), 4EFOZ(variation 4), 5 CCOZ(variation 4), 5EOZ(variation 4), 6.5 EFOZ(variation 4), 8EOZ(variation 4), 8EFOZ, 9 CCOZ, 9EOZ, 9EFOZ, 10EOZ, 6.5EFOZD, 7 EFOZD, 8EOZD, 8.5 EFOZD, 9 EOZD, 9EFOZD, 10EOZD



23-7200
CARB KIT

Replaces: Westerbeke 36450
Fits: 6.5 TWG(60Hz)/4.9 TWG(50Hz), 8.0 TWG(60Hz)/6.4 TWG(50Hz), 8.5 BTG(60Hz)/6.5 BTG(50Hz), 12.5 BTG(60Hz)/10.0 BTG(50Hz), 15.0 BTG(A)(60Hz)/12.0 BTG(A)(50Hz), 20.0 BEG(60Hz)/16.0 BEG(50Hz), 25.0 BEG(60Hz)/20.0 BEG(50Hz)



23-7201
CARB KIT

Replaces: Westerbeke 38100
Fits: 4.0 BCG(60Hz)/3.0 BCG(50Hz), 4.5 BCG(60Hz)/3.75 BCG(50Hz), 4.5 BCGTC(60Hz)/3.75 BCGTC(50Hz), 5.0 BCG(60Hz)/4.2 BCG(50Hz), 6.5 BCG(60Hz)/4.8 BCG(50Hz), 7.0 BCG(60Hz)/5.0 BCG(50Hz), 7.0 BCG(A)(60Hz)/5.0 BCG(A)(50Hz), 7.0 BCGB(60Hz)/6.0 BCGB(50Hz), 7.2 BCGTC(60Hz)/6.0 BCGTC(50Hz), 8.0 BEG(60Hz)/6.4 BEG(50Hz), 9.6 BCGTC(60Hz)/8.0 BCGTC(50Hz), 10.0 BEG(60Hz)/8.0 BEG(50Hz), 12.5 BEG(60Hz)/10.0 BEG(50Hz), 15.0 BEG(60Hz)/12.0 BEG(50Hz)



23-7202
CARB KIT

Replaces: Kohler GM24510
Fits: 4EF, 5E, 6EF, 7.3E, 6ECD, 4EFCD, 6EFCD and 7.3 ECD



23-7740
FUEL FILTER

Replaces: Kohler 252898
Fits: 11 CCF0Z (variation 2), 11.5 CCF0Z (variation 2), 11EFOZ (variation 2), 11.5EFOZ (variation 2), 13EOZ (variation 2), 13EFOZ (variation 2), 13.5 CCOZ (variation 2), 14 CCOZ (variation 2), 14EOZ (variation 2), 15 CCF0Z (variation 3), 15.5EOZ (variation 2), 18EFOZ (variation 3), 17.5EFOZ (variation 3), 18.5 CCOZ (variation 3), 19EFOZ (variation 3), 20 CCF0Z (variation 3), 20EOZ (variation 3), 20EFOZ (variation 3), 23EOZ (variation 3), 24 CCOZ (variation 3), 24EOZ (variation 3), 17EFOZD (variation 3), 17.5EFOZD (variation 3), 19EFOZD (variation 3), 20EOZD (variation 3), 20EFOZD (variation 3), 23EOZD (variation 3), 24EOZD (variation 3)



23-7751
FUEL FILTER

Replaces: Kohler 229715
Fits: 4 CCF0Z, 4EFOZ, 5 CCOZ, 5EOZ, 6.5 EFOZ, 8EOZ, 6.5EFOZD, 8EOZD



23-7760

FUEL FILTER

Replaces: Onan A026K278, 149-2106
Fits: MDKAU, MDKAV, MDK6G, MDKAW (Spacesaver), MDKAZ, MDKBD, MDKBE, MDKBF, MDKBD (w/ Isolated Ground), MDKBE (w/ Isolated Ground), MDKBF (w/ Isolated Ground), MDKAD/E/F



23-7761

FUEL FILTER

Replaces: Kohler GM32359
Fits: 7 EFOZD(variation 1), 8.5 EFOZD(variation 1), 9 EOZD(variation 1), 9EFOZD(variation 1), 10EOZD(variation 1), 11EFOZD(variation 3), 11.5EFOZD(variation 3), 13EOZD(variation 3), 13EFOZD(variation 3), 14 EOZD(variation 3), 15.5 EOZD(variation 3), 17 EFOZD(variation 1), 17.5EFOZD(variation 1), 19EFOZD(variation 1), 20EOZD(variation 1), 20EFOZD(variation 1), 23EOZD(variation 1), 24EOZD(variation 1), 23EFOZD, 27EFOZD, 28EOZD, 32EOZD



23-7762

FUEL FILTER

Replaces: Kohler 267987
Fits: 4EF, 5E, 6EF, 7.3E, 8E (GR4 Version), 10E (GR4 Version), 12.5E (GR4 Version)



23-7764

FUEL FILTER

Replaces: Westerbeke 24363
Fits: 15.0 BTD(60Hz) / 12.0 BTD(50Hz), 15.0 BTDA(60Hz) / 12.0 BTDA(50Hz), 15.0 BTDB(60Hz) / 12.0 BTDB(50Hz), 15.0 WTA(60Hz) / 12.0 WTA(50Hz), 20.0 BED(60Hz) / 16.0 BED(50Hz), 20.0 BEDA(60Hz) / 16.0 BEDA(50Hz), 20.0 WTA(60Hz) / 16.0 WTA(50Hz), 25.0 BED(60Hz) / 20.0 BED(50Hz), 25.0 WTA(60Hz) / 20.0 WTA(50Hz), 32.0 BED(60Hz) / 25.0 BED(50Hz), 32.0 BEDB(60Hz) / 25.0 BEDB(50Hz), 32.0 WTF(60Hz) / 25.0 WTF(50Hz)



23-7780

FUEL FILTER

Replaces: Kohler GM34570
Fits: 9 EFGD, 10 EG, 10 EGD, 13 EG, 13 EGD, 13 EGZ, 15 EG, 15 EGD, 15 EGZ



23-7750

FUEL FILTER ELEMENT

Replaces: Onan 149-0428
Fits: MDJA (Spec A-R), MDJB (Spec A-R), MDJC (Spec A-R), MDJE (Spec A), MDJF (Spec A)



23-7720

FUEL FILTER KIT

Replaces: Westerbeke 35920
Onan 149-1445
Fits: Westerbeke: 4.0 BCG(60Hz)/3.0 BCG(50Hz), 6.5 BCG(60Hz)/4.8 BCG(50Hz), 6.5 TWG(60Hz)/4.9 TWG(50Hz), 8.0 TWG(60Hz)/6.4 TWG(50Hz), 9.0 BTG(60Hz)/7.0 BTG(50Hz), 11.0 TWG(60Hz)/8.5 TWG(50Hz)



23-7770

FUEL FILTER KIT

Replaces: Westerbeke 47006, 30200
Fits several models: See application chart on pages 120-131



23-7771

FUEL FILTER KIT

Replaces: Kohler 249433
Fits: 3.5 CFZ(Variation 2), 4 CZ(Variation 2), 5 CFZ(Variation 2), 6.5 CZ(Variation 2), 8E(Variation 2), 10E(Variation 2), 12.5E(Variation 2)



23-1000

GLOW PLUG (12 Volt)

Replaces: Westerbeke 24353
Fits: 4.4 BCD(60Hz), 4.4 WMD(60Hz) / 3.3 WMD(50Hz), 6.0 BCD(60Hz) / 4.5 BCD(50Hz), 7.7 WMD(60Hz) / 5.8 WMD(50Hz), 8.0 BTD(60Hz) / 6.0 BTD(50Hz), 8.0 BTDA(60Hz) / 6.0 BTDA(50Hz), 8.0 WMD(60Hz) / 6.0 WMD(50Hz), 10.0 BTD(60Hz) / 7.5 BTD(50Hz), 10.0 BTDA(60Hz) / 7.5 BTDA(50Hz), 11.0 BTD(60Hz) / 8.3 BTD(50Hz), 11.0 WMD(60Hz) / 8.3 WMD(50Hz), 12.5 BTD(60Hz) / 9.4 BTD(50Hz), 12.5 BTDA(60Hz) / 9.4 BTDA(50Hz), 12.5 BTDB(60Hz) / 9.4 BTDB(50Hz), 12.5 WMD(60Hz) / 9.4 WMD(50Hz), 15.0 BTD(60Hz) / 12.0 BTD(50Hz), 15.0 BTDA(60Hz) / 12.0 BTDA(50Hz), 15.0 BTDB(60Hz) / 12.0 BTDB(50Hz), 15.0 BTDC(60Hz) / 12.0 BTDC(50Hz), 15.0 WTA(60Hz) / 12.0 WTA(50Hz), 20.0 BED(60Hz) / 16.0 BED(50Hz), 20.0 BEDA(60Hz) / 16.0 BEDA(50Hz), 20.0 WTA(60Hz) / 16.0 WTA(50Hz), 25.0 BED(60Hz) / 20.0 BED(50Hz), 25.0 WTA(60Hz) / 20.0 WTA(50Hz), 32.0 BED(60Hz) / 25.0 BED(50Hz), 32.0 BEDB(60Hz) / 25.0 BEDB(50Hz), 32.0 WTF(60Hz) / 25.0 WTF(50Hz)



23-5840

TEMPERATURE SENDER

Replaces: Westerbeke 35109
Fits several models: See application chart on pages 120-131



23-5880

OIL PRESSURE SENDER

Replaces: Westerbeke 24132
Fits several models: See application chart on pages 120-131



**23-2000
IMPELLER**

Replaces: Westerbeke 33112
(Impeller Only)

Fits: 6.5 TWG(60Hz)/4.9 TWG(50Hz), 8.0 TWG(60Hz)/6.4 TWG(50Hz), 8.5 BTG(60Hz)/6.5 BTG(50Hz), 11.0 TWG(60Hz)/8.5 TWG(50Hz), 12.5 BTG(60Hz)/10.0 BTG(50Hz), 15.0 BTG(60Hz)/12.0 BTG(50Hz), 15.0 BTGA(60Hz)/12.0 BTGA(50Hz), 20.0 WTA(60Hz)/16.0 WTA(50Hz)



**23-2001
IMPELLER**

Replaces: Westerbeke 32620
(Impeller Only)

Fits: 4.0 BCG(60Hz)/3.0 BCG(50Hz), 4.5 BCG(60Hz)/3.75 BCG(50Hz), 4.5 BCGB(60Hz)/3.75 BCGB(50Hz), 4.5 BCGTC(60Hz)/3.75 BCGTC(50Hz), 6.5 BCG(60Hz)/4.8 BCG(50Hz), 7.0 BCG(60Hz)/5.0 BCG(50Hz), 7.0 BCGA(60Hz)/5.0 BCGA(50Hz), 7.0 BCGB(60Hz)/5.0 BCGB(50Hz), 7.2 BCGTC(60Hz)/6.0 BCGTC(50Hz), 9.0 BTG(60Hz)/7.0 BTG(50Hz), 9.6 BCGTC(60Hz)/8.0 BCGTC(50Hz), 3.0 WWD(60Hz)/2.4 WWD(50Hz), 3.8/4.2 BCDT(60Hz) / 3.5 BCDT(50Hz), 5.0 BCG(60Hz)/4.2 BCG(50Hz), 5.0 BCGA(60Hz)/5.2 BCGA(50Hz), 7.0 BCGC(60Hz)/5.9 BCGC(50Hz), 8.0 BEG(60Hz)/6.4 BEG(50Hz), 10.0 BEG(60Hz)/8.0 BEG(50Hz), 12.5 BEG(60Hz)/10.0 BEG(50Hz), 15.0 BEG(60Hz)/12.0 BEG(50Hz)



**23-2002
IMPELLER**

Replaces:
Kohler 229826

Fits: 8E (SN 296899 and Up), 10E (SN 296899 and Up), 12.5E (SN 296899 and Up), 12.5CF (SN 296899 and Up), 15C, 16CF, 20C



**23-2003
IMPELLER**

Replaces:

Kohler 250872, Jabsco 22799-0001
Fits: 8E (SN 296898 and Below), 10E (SN 296898 and Below), 12.5E (SN 296898 and Below), 12.5CF (SN 296898 and Below)



**23-2004
IMPELLER KIT**

Replaces: Kohler 359978
(Impeller only)

Fits: Kohler Pump GM28487; Fits Models 4EF, 5E, 6EF, 7.3E, 4 EFCD, 5 ECD, 6 EFCD, 7.3 ECD.



**23-2005
IMPELLER KIT**

Replaces: Northam Lights 25-12009
(Impeller only)



**23-3300
IMPELLER KIT**

Replaces: Onan 132-0349

Fits: MDKAV, MDKBB, MDKAW (Spacesaver), MDKAZ, MDKBD, MDKBE, MDKBF, MDKBD (w/ Isolated Ground), MDKBE (w/ Isolated Ground), MDKBF (w/ Isolated Ground)



**23-3301
IMPELLER KIT**

Replaces: Westerbeke 11907

Fits: 20.0 BEG(60Hz)/16.0 BEG(50Hz), 25.0 BEG(60Hz)/20.0 BEG(50Hz), 20.0 SBEGA(60Hz)/16.0 SBEGA(50Hz), 20.0 SBEGA(60Hz)/16.0 SBEGA(50Hz), 22.5 SBEG(60Hz)/18.7 SBEG(50Hz), 22.5 SBEGA(60Hz)/18.7 SBEGA(50Hz), 20.0 BED(60Hz)/16.0 BED(50Hz), 20.0 BEDA(60Hz)/16.0 BEDA(50Hz), 25.0 BED(60Hz)/20.0 BED(50Hz), 25.0 WTA(60Hz)/20.0 WTA(50Hz), 32.0 BED(60Hz)/25.0 BED(50Hz), 32.0 BEDA(60Hz)/25.0 BEDA(50Hz), 32.0 BEDB(60Hz)/25.0 BEDB(50Hz), 32.0 WTF(60Hz)/25.0 WTF(50Hz)



**23-3302
IMPELLER KIT**

Replaces: Westerbeke 33112

Fits: 6.5 TWG(60Hz)/4.9 TWG(50Hz), 8.0 TWG(60Hz)/6.4 TWG(50Hz), 8.5 BTG(60Hz)/6.5 BTG(50Hz), 11.0 TWG(60Hz)/8.5 TWG(50Hz), 12.5 BTG(60Hz)/10.0 BTG(50Hz), 15.0 BTG(60Hz)/12.0 BTG(50Hz), 15.0 BTGA(60Hz)/12.0 BTGA(50Hz), 20.0 WTA(60Hz)/16.0 WTA(50Hz)
Includes 23-2000 Impeller

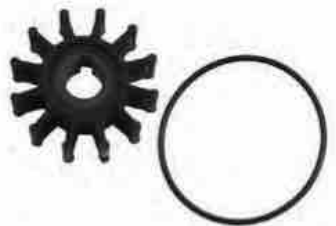

**23-3303
IMPELLER KIT**

Replaces: Kohler 229826

Fits: Kohler Pump GM46962; Fits: Models 8E (SN 296899 and Up), 10E (SN 296899 and Up), 12.5E (SN 296899 and Up), 12.5CF (SN 296899 and Up), 15C, 16CF, 20C

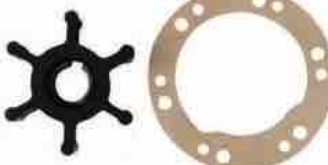

**23-3304
IMPELLER KIT**

Replaces: Kohler 229955

Fits: 8E (SN 296898 and Below), 10E (SN 296898 and Below), 12.5E (SN 296898 and Below), 12.5CF (SN 296898 and Below)



**23-3305
IMPELLER KIT**

Replaces: Westerbeke 32620

Fits: 4.0 BCG(60Hz)/3.0 BCG(50Hz), 4.5CG(60Hz)/3.75 BCG(50Hz), 4.5 BCGB(60Hz)/3.75 BCGB(50Hz), 4.5 BCGTC(60Hz)/3.75 BCGTC(50Hz), 6.5 BCG(60Hz)/4.8 BCG(50Hz), 7.0 BCG(60Hz)/5.0 BCG(50Hz), 7.0 BCGA(60Hz)/5.0 BCGA(50Hz), 7.0 BCGB(60Hz)/5.0 BCGB(50Hz), 7.2 BCGTC(60Hz)/6.0 BCGTC(50Hz), 9.0 BTG(60Hz)/7.0 BTG(50Hz), 9.6 BCGTC(60Hz)/8.0 BCGTC(50Hz), 3.0 WWD(60Hz)/2.4 WWD(50Hz), 3.8/4.2 BCDT(60Hz) / 3.5 BCDT(50Hz)



**23-3306
IMPELLER KIT**

Replaces: Westerbeke 46622
Fits: 5.0 BCG(60Hz)/4.2 BCG(50Hz), 5.0 BCGA(80Hz)/5.2 BCGA(50Hz), 7.0 BCGC(60Hz)/5.9 BCGC(50Hz), 8.0 BEG(60Hz)/6.4 BEG(50Hz), 10.0 BEG(60Hz)/9.0 BEG(50Hz), 12.5 BEG(60Hz)/10.0 BEG(50Hz), 15.0 BEG(60Hz)/12.0 BEG(50Hz)



**23-3307
IMPELLER KIT**

Replaces: Westerbeke 34440
Fits: 4.0 BCD(60Hz), 4.4 BCD(60Hz), 4.4 WMD(60Hz)/3.3 WMD(50Hz), 5.0 BCD(60Hz)/4.0 BCD(50Hz), 5.0 BCDA(60Hz)/4.0 BCDA(50Hz), 5.0 BCDB(60Hz)/4.0 BCDB(50Hz), 6.0 BCD(60Hz)/4.5 BCD(50Hz), 7.6 BTD(60Hz)/5.7 BTD(50Hz), 7.7 WMD(60Hz)/5.8 WMD(50Hz), 8.0 BTD(60Hz)/6.0 BTD(50Hz), 8.0 BTDA(60Hz)/6.0 BTDA(50Hz)(Before March 2004), 8.0 WMD(60Hz)/6.0 WMD(50Hz), 10.0 BTD(60Hz)/7.5 BTD(50Hz), 10.0 BTDA(60Hz)/7.5 BTDA(50Hz), 11.0 BTD(60Hz)/8.3 BTD(50Hz), 11.0 WMD(60Hz)/8.3 WMD(50Hz), 12.5 BTD(60Hz)/9.4 BTD(50Hz), 12.5 BTDA(60Hz)/9.4 BTDA(50Hz), 12.5 BTDB(60Hz)/9.4 BTDB(50Hz), 12.5 WMD(60Hz)/9.4 WMD(50Hz), 15.0 BTDC(60Hz)/12.0 BTDC(50Hz)



**23-3308
IMPELLER KIT**

Replaces: Kohler 352122
Fits: 33EFOZ, 33 CFOZ, 40 CFOZ, 40EOZ, 40EFOZ, 50 COZ, 50 CFOZ, 50EOZ, 55EFOZ, 65 COZ, 65EOZ, 70EFOZ, 80EOZ, 80EFOZ, 99EOZ



**23-3309
IMPELLER KIT**

Replaces: Onan 132-0436
Fits: MDDCA, MDDCB, MDDCC, MDDCF, MDDCG, MDDCD, MDDCE, MDDCH, MDDCJ



**23-3310
IMPELLER KIT**

Replaces: Onan 541-1519
Fits: MDKKB, MDKBL, MDKBM, MDKBN, MDKAL/A/B



**23-3311
IMPELLER KIT**

Replaces: Fischer Panda J009-46840
Mase 80161
Fits: AGTPM 4, PMS 4, IS 2.5, IS 4.0, IS 4.7, IS 7.1



**23-3312
IMPELLER KIT**

Replaces: Fischer Panda J009-1027B-1
Mase 92911
Fits: IS 13.2, IS 10.2, IS 14.0, IS 18.0, IS 23.1T, PMS 15, PMS 16 DP, PMS 20, PMS 22, PMS 25, PMS 30, PMS 40, PMS 50



**23-3313
IMPELLER KIT**

Replaces: Westerbeke 33104
Fits: 15.0 BTD(60Hz) / 12.0 BTD(50Hz), 15.0 BTDA(60Hz) / 12.0 BTDA(50Hz), 15.0 BTDB(60Hz) / 12.0 BTDB(50Hz), 15.0 WTA(60Hz) / 12.0 WTA(50Hz)



**23-3314
IMPELLER KIT**

Replaces: Kohler 359978
Fits: Kohler Pump GM28487; Fits Models 4EF, 5E, 6EF, 7.3E, 4 EFCD, 5 ECD, 6 EFCD, 7.3 ECD



**23-3315
IMPELLER KIT**

Replaces: Northern Lights 25-12009
Fits: M673LD3, M673L3, M673LD2, M673L2



**23-0400
QUAD RING**

Replaces: Northern Lights 25-12031



**23-4005
SEA WATER PUMP BELT**

Replaces: Westerbeke 13810
Fits: 32.0 BED(60Hz) / 25.0 BED(50Hz), 32.0 BEDA(60Hz) / 25.0 BEDA(50Hz), 32.0 BEDB(60Hz) / 25.0 BEDB(50Hz)



23-4006

SEA WATER PUMP BELT

Replaces: Westerbeke 31152
Fits: 20.0 BED(60Hz) / 16.0 BED(50Hz), 20.0 BEDA(60Hz) / 16.0 BEDA(50Hz), 20.0 WTA(60Hz) / 16.0 WTA(50Hz), 25.0 BED(60Hz) / 20.0 BED(50Hz)



23-4007

SEA WATER PUMP BELT

Replaces: Westerbeke 30376
Fits: 4.0 BCD(60Hz), 4.4 BCD(60Hz), 4.4 WMD(60Hz) / 3.3 WMD(50Hz), 5.0 BCD/BCDA/BCDB(60Hz) / 4.0 BCD/BCDA/BCDB(50Hz)



23-3600 THERMOSTAT

Replaces: Westerbeke 24688
Temperature Rating: 180°
Fits: 3.0 WMD(60Hz)/2.4 WMD(50Hz), 4.4 BCD(60Hz), 4.4 WMD(60Hz) / 3.3 WMD(50Hz), 7.7 WMD(60Hz) / 5.8 WMD(50Hz), 8.0 BTD(60Hz) / 8.0 BTD(50Hz), 8.0 BTDA(60Hz) / 8.0 BTDA(50Hz), 8.0 WMD(60Hz) / 8.0 WMD(50Hz), 10.0 BTD(60Hz) / 7.5 BTD(50Hz), 10.0 BTDA(60Hz) / 7.5 BTDA(50Hz), 11.0 BTD(60Hz) / 8.3 BTD(50Hz), 11.0 WMD(60Hz) / 8.3 WMD(50Hz), 12.5 BTD(60Hz) / 9.4 BTD(50Hz), 12.5 BTDA(60Hz) / 9.4 BTDA(50Hz), 12.5 BTDB(60Hz) / 9.4 BTDB(50Hz), 12.5 WMD(60Hz) / 9.4 WMD(50Hz), 12.6 BTD(60Hz) / 10.4 BTD(50Hz), 15.0 BTD(60Hz) / 12.0 BTD(50Hz), 15.0 BTDC(60Hz) / 12.0 BTDC(50Hz), 20.0 SBEG(60Hz) / 16.0 SBEG(50Hz), 20.0 SBEGA(60Hz), 16.0 SBEG(50Hz), 22.5 SBEG(60Hz) / 18.7 SBEG(50Hz), 22.5 SBEGA(60Hz) / 18.7 SBEGA(50Hz)



23-3601 THERMOSTAT

Replaces: Westerbeke 35736
Temperature Rating: 140°
Fits: 6.5 BCG(60Hz)/4.8 BCG(50Hz), 6.5 TWG(60Hz)/4.9 TWG(50Hz), 8.0 TWG(60Hz)/6.4 TWG(50Hz), 8.5 BTG(60Hz)/6.5 BTG(50Hz), 9.0 BTG(60Hz)/7.0 BTG(50Hz), 11.0 TWG(60Hz)/8.5 TWG(50Hz), 12.5 BTG(60Hz)/10.0 BTG(50Hz), 15.0 BTG/A(60Hz)/12.0 BTG/A(50Hz), 20.0 BEG(60Hz)/16.0 BEG(50Hz), 25.0 BEG(60Hz)/20.0 BEG(50Hz)



23-3602 THERMOSTAT

Replaces: Westerbeke 37387
Temperature Rating: 140°
Fits: 4.5 BCG(60Hz)/3.75 BCG(50Hz), 7.0 BCG(60Hz)/5.0 BCG(50Hz), 7.0 BCGA(60Hz)/5.0 BCGA(50Hz)



23-3603 THERMOSTAT

Replaces: Westerbeke 39378
Temperature Rating: 160°
Fits: 4.5 BCGB(60Hz)/3.75 BCGB(50Hz), 4.5 BCGTC(60Hz)/3.75 BCGTC(50Hz), 5.0 BCG(60Hz)/4.2 BCG(50Hz), 5.0 BCGA(60Hz)/5.2 BCGA(50Hz), 7.0 BCGB(60Hz)/6.0 BCGB(50Hz), 7.0 BCGC(60Hz)/5.9 BCGC(50Hz), 7.2 BCGTC(60Hz)/6.0 BCGTC(50Hz), 5.0 SBCG(60Hz)/4.0 SBEG(50Hz), 6.5 SBCG(60Hz) / 5.4 SBCG(50Hz)



23-3604 THERMOSTAT

Replaces: Westerbeke 46097
Temperature Rating: 140°
Fits: 8.0 BEG(60Hz)/6.4 BEG(50Hz), 10.0 BEG(60Hz)/8.0 BEG(50Hz), 12.5 BEG(60Hz)/10.0 BEG(50Hz), 15.0 BEG(60Hz)/12.0 BEG(50Hz)



23-3605 THERMOSTAT

Replaces: Westerbeke 24690
Temperature Rating: 180°
Fits: 8.0 SBEG(60Hz) / 6.4 SBEG(50Hz), 10.0 SBEG(60Hz) / 8.0 SBEG(50Hz), 12.5 SBEG(60Hz) / 10.0 SBEG(50Hz), 14.0 SBEG(60Hz) / 11.6 SBEG(50Hz), 15.0 BTDA(60Hz) / 12.0 BTDA(50Hz), 15.0 BTDB(60Hz) / 12.0 BTDB(50Hz), 20.0 BED(60Hz) / 16.0 BED(50Hz), 20.0 BEDA(60Hz) / 16.0 BEDA(50Hz), 20.0 WTA(60Hz) / 16.0 WTA(50Hz), 25.0 BED(60Hz) / 20.0 BED(50Hz)



23-3606 THERMOSTAT

Replaces: Onan 309-0130
Temperature Rating: 143°
Fits: MDJA, MDJB, MDJC, MDJE, MDJF, MJA, MJB, MJC



23-3607 THERMOSTAT

Replaces: Kohler 352018
Temperature Rating: 195°
Fits: 33EFOZ(Variation 1), 33 CFOZ(Variation 1), 40 CFOZ(Variation 1), 40EFOZ(Variation 1), 40EFOZ(Variation 1), 50 COZ(Variation 1), 50 CFOZ(Variation 1), 50EFOZ(Variation 1), 55EFOZ(Variation 1), 65 COZ(Variation 1), 65EFOZ(Variation 1), 70EFOZ(Variation 1), 80EFOZ(Variation 1), 80EFOZ(Variation 1), 99EFOZ(Variation 1), 100EFOZ(Variation 1), 125EFOZ(Variation 1), 125EFOZ(Variation 1), 150EFOZ(Variation 1)



23-3608 THERMOSTAT

Replaces: Kohler 249930
Temperature Rating: 190°
Fits: 4EF, 5E, 6EF, 7.3E, 8E, 10E, 12.5E, 12.5CF, 15C, 16CF, 20C



23-3609 THERMOSTAT

Replaces: Kohler 252896
Temperature Rating: 170°
Fits: 11 CCF0Z, 11.5 CCF0Z, 11EFOZ, 11.5EFOZ, 13EFOZ, 13EFOZ, 13.5 CCOZ, 14 CCOZ, 14 EFOZ, 15.5EFOZ, 16EFOZ, 17.5EFOZ, 18.5 CCOZ, 19EFOZ, 20 CCF0Z, 20EFOZ, 20EFOZ, 23EFOZ, 24 CCOZ, 24EFOZ



23-0800
THERMOSTAT GASKET

Replaces: *Westerbeke* 42260
Fits: 4.5 BCG(60Hz)/3.75 BCG(50Hz), 4.5 BCGTC(60Hz)/3.75 BCGTC(50Hz), 7.0 BCG(60Hz)/6.0 BCG(50Hz), 7.2 BCGTC(60Hz)/ 6.0 BCGTC(50Hz), 9.6 BCGTC(60Hz)/8.0 BCGTC(50Hz)



23-0801
THERMOSTAT GASKET

Replaces: *Westerbeke* 46124
Fits: 5.0 BCG(60Hz)/4.2 BCG(50Hz), 5.0 BCGA(60Hz)/5.2 BCGA(50Hz), 7.0 BCGC(60Hz)/5.9 BCGC(50Hz), 5.0 SBCG(60Hz) / 4.2 SBEG(50Hz), 6.5 SBCG(60Hz) / 5.4 SBEG(50Hz)



23-0802
THERMOSTAT GASKET

Replaces: *Westerbeke* 34196
Fits: 4.0 BCG(60Hz)/3.0 BCG(50Hz), 6.5 BCG(60Hz)/4.8 BCG(50Hz), 8.0 TWG(60Hz)/6.4 TWG(50Hz), 9.0 BTG(60Hz)/7.0 BTG(50Hz), 11.0 TWG(60Hz)/8.5 TWG(50Hz), 6.0 BCD(60Hz) / 4.5 BCD(50Hz), 8.0 BTD(60Hz) / 6.0 BTD(50Hz), 10.0 BTD(60Hz) / 7.5 BTD(50Hz), 11.0 BTD(60Hz) / 8.3 BTD(50Hz), 12.5 BTD(60Hz) / 9.4 BTD(50Hz), 12.5 BTDA(60Hz) / 9.4 BTDA(50Hz), 12.6 BTD(60Hz) / 10.4 BTD(50Hz)



23-0803
THERMOSTAT GASKET

Replaces: *Westerbeke* 33417
Fits: 6.5 TWG(60Hz)/4.9 TWG(50Hz), 8.0 BEG(60Hz)/6.4 BEG(50Hz), 8.5 BTG(60Hz)/6.5 BTG(50Hz), 10.0 BEG(60Hz)/8.0 BEG(50Hz), 12.5 BEG(60Hz)/10.0 BEG(50Hz), 12.5 BTG(60Hz)/10.0 BTG(50Hz), 15.0 BEG(60Hz)/12.0 BEG(50Hz), 15.0 BTG/A(60Hz)/ 12.0 BTG/A(50Hz), 8.0 SBEG(60Hz) / 6.4 SBEG(50Hz), 10.0 SBEG(60Hz) / 8.0 SBEG(50Hz), 12.5 SBEG(60Hz) / 10.0 SBEG(50Hz), 14.0 SBEG(60Hz) / 11.6 SBEG(50Hz)



23-0804
THERMOSTAT GASKET

Replaces: *Westerbeke* 33373
Fits: 15.0 BTDA(60Hz) / 12.0 BTDA(50Hz), 15.0 BTDB(60Hz) / 12.0 BTDB(50Hz), 15.0 WTA(60Hz) / 12.0 WTA(50Hz), 20.0 BED(60Hz) / 16.0 BED(50Hz), 20.0 BEDA(60Hz) / 16.0 BEDA(50Hz), 20.0 WTA(60Hz) / 16.0 WTA(50Hz), 25.0 BED(60Hz) / 20.0 BED(50Hz), 25.0 WTA(60Hz) / 20.0 WTA(50Hz)



23-0805
THERMOSTAT GASKET

Replaces: *Westerbeke* 40434
Fits: 20.0 BEG(60Hz)/16.0 BEG(50Hz), 25.0 BEG(60Hz)/20.0 BEG(50Hz), 20.0 SBEG(60Hz) / 16.0 SBEG(50Hz), 20.0 SBEGA(60Hz) / 16.0 SBEGA(50Hz), 22.5 SBEG(60Hz) / 18.7 SBEG(50Hz), 22.5 SBEGA(60Hz) / 18.7 SBEGA(50Hz)



23-0806
THERMOSTAT GASKET

Replaces: *Westerbeke* 24323
Fits: 4.4 BCD(60Hz), 4.4 WMD(60Hz) / 3.3 WMD(50Hz), 7.7 WMD(60Hz) / 5.6 WMD(50Hz), 8.0 WMD(60Hz) / 6.0 WMD(50Hz), 11.0 WMD(60Hz) / 8.3 WMD(50Hz), 12.5 WMD(60Hz) / 9.4 WMD(50Hz)



23-0807
THERMOSTAT GASKET

Replaces: *Westerbeke* 33966
Fits: 15.0 BTD(60Hz) / 12.0 BTD(50Hz)



23-0808
THERMOSTAT GASKET

Replaces: *Westerbeke* 37922
Fits: 4.5 BCG(60Hz)/3.75 BCG(50Hz), 7.0 BCG(60Hz)/5.0 BCG(50Hz), 7.0 BCGA(60Hz)/5.0 BCGA(50Hz)



23-0809
THERMOSTAT GASKET

Replaces: *Kohler* 267718
Fits: 3.5CFZ, 4CZ, 5CFZ, 6.5CZ



23-0810
THERMOSTAT GASKET

Replaces: *Kohler* 229432
Fits: 11CCFOZ(variation 1,6), 11.5CCFOZ(variation 1,6), 11EFOZ(variation 1,6), 11.5EFOZ(variation 1,6), 13EOZ(variation 1,6), 13EFOZ(variation 1,6), 13.5CCOZ(variation 1,6), 14CCOZ(variation 1,6), 14EOZ(variation 1,6), 15CCFOZ, 15.5 EOZ(variation 1,6), 16EFOZ, 17.5EFOZ, 18.5CCOZ, 19EFOZ, 20CCFOZ, 20EOZ, 20EFOZ, 23EOZ, 24CCOZ, 24EOZ



23-0811
THERMOSTAT GASKET

Replaces: *Kohler* 249865
Fits: 11CCFOZ(variation 2,3,4,5), 11.5CCFOZ(variation 2,3,4,5), 11EFOZ(variation 2,3,4,5), 11.5EFOZ(variation 2,3,4,5), 13EOZ(variation 2,3,4,5), 13EFOZ(variation 2,3,4,5), 13.5CCOZ(variation 2,3,4,5), 14CCOZ(variation 2,3,4,5), 14EOZ(variation 2,3,4,5), 15.5 EOZ(variation 2,3,4,5), 11EFOZD, 11.5EFOZD, 13EOZD, 13EFOZD, 14EOZD, 15.5EOZD, 17EFOZD, 17.5EFOZD, 19EFOZD, 20EOZD, 20EFOZD, 23EOZD, 24EOZD



23-0812
THERMOSTAT GASKET

Replaces: Kohler 229433
Fits: 11 GCFOZ, 11.5 CGFOZ, 11EFOZ, 11.5EFOZ, 13EOZ, 13EFOZ, 13.5 CCOZ, 14 CCOZ, 14 EOZ, 15 CCFOZ, 15.5EOZ, 18EFOZ, 17.5EFOZ, 18.5 CCOZ, 19EFOZ, 20 CCFOZ, 20EFOZ, 20EFOZ, 23EFOZ, 24 CCOZ, 24EOZ, 11EFOZD, 11.5EFOZD, 11.5EFOZD, 13EFOZD, 14 EOZD, 15.5 EOZD, 17 EFOZD, 17.5EFOZD, 19EFOZD, 20EOZD, 20EFOZD, 23EOZD, 24EOZD



23-0813
THERMOSTAT GASKET

Replaces: Kohler 229963
Fits: 8E, 10E, 12.5E, 12.5CF, 15C, 16CF, 20C, 10EG, 13EG, 13EGZ, 15EG, 15EGZ, 4CCFOZ, 4EFOZ, 5CCOZ, 5EOZ, 6.5EFOZ, 8CGFOZ, 8EOZ, 8EFOZ, 8CGOZ, 9EOZ, 9EFOZ, 10EOZ, 23EFOZ, 27EFOZ, 28EOZ, 32EOZ, 6.5EFOZD, 7EFOZD, 8EOZD, 8.5EFOZD, 9EOZD, 9EFOZD, 10EOZD



23-0814
THERMOSTAT GASKET

Replaces: Kohler 352031
Fits: 33EFOZ(variation 1,2,3), 33CFOZ(variation 1,2,3), 40CFOZ(variation 1,2,3), 40EOZ(variation 1,2,3), 40EFOZ(variation 1,2,3), 50COZ(variation 1,2,3), 50CFOZ(variation 1,2,3), 50EFOZ(variation 1,2,3), 55EFOZ(variation 1,2,3), 55COZ(variation 1,2,3), 65EFOZ(variation 1,2,3), 70EFOZ(variation 1,2,3), 80EFOZ(variation 1,2,3), 80EFOZ(variation 1,2,3), 99EFOZ(variation 1,2,3), 100EFOZ(variation 1,2,3), 125EOZ(variation 1,2,3), 125EFOZ(variation 1,2,3), 150EOZ(variation 1,2,3)



23-0830
THERMOSTAT GASKET

Replaces: Northern Lights 11-10015
Fits: Used with 35-12500 and 35-11000 thermostats



23-3650
THERMOSTAT KIT

Replaces: Westerbeke 24688, 24323
Temperature Rating: 180°
Fits: 4.4 BCD(60Hz), 4.4 WMD(60Hz) / 3.3 WMD(50Hz), 7.7 WMD(60Hz) / 5.8 WMD(50Hz), 8.0 WMD(60Hz) / 6.0 WMD(50Hz), 11.0 WMD(60Hz) / 8.3 WMD(50Hz), 12.5 WMD(60Hz) / 9.4 WMD(50Hz)



23-3651
THERMOSTAT KIT

Replaces: Westerbeke 35736, 34196
Temperature Rating: 140°
Fits: 4.0 BCG(60Hz)/3.0 BCG(50Hz), 6.5 BCG(60Hz)/4.8 BCG(50Hz), 8.0 TWG(60Hz)/6.4 TWG(50Hz), 9.0 BTG(60Hz)/7.0 BTG(50Hz), 11.0 TWG(60Hz)/8.5 TWG(50Hz)



23-3652
THERMOSTAT KIT

Replaces: Westerbeke 35736, 33417
Temperature Rating: 140°
Fits: 6.5 TWG(60Hz)/4.9 TWG(50Hz), 8.5 BTG(60Hz)/6.5 BTG(50Hz), 12.5 BTG(60Hz)/10.0 BTG(50Hz), 15.0 BTG(A)(60Hz)/12.0 BTG(A)(50Hz)



23-3653
THERMOSTAT KIT

Replaces: Westerbeke 24688, 34196
Temperature Rating: 180°
Fits: 8.0 BTD(60Hz) / 6.0 BTD(50Hz), 10.0 BTD(60Hz) / 7.5 BTD(50Hz), 11.0 BTD(60Hz) / 8.3 BTD(50Hz), 12.5 BTD(60Hz) / 9.4 BTD(50Hz), 12.5 BTDA(60Hz) / 9.4 BTDA(50Hz), 12.6 BTD(60Hz) / 10.4 BTD(50Hz)



23-3654
THERMOSTAT KIT

Replaces: Westerbeke 39378, 42260
Temperature Rating: 160°
Fits: 4.5 BCGB(60Hz)/3.75 BCGB(50Hz), 4.5 BCGTC(60Hz)/3.75 BCGTC(50Hz), 7.0 BCGB(60Hz)/6.0 BCGB(50Hz), 7.2 BCGTC(60Hz)/ 6.0 BCGTC(50Hz), 9.6 BCGTC(60Hz)/8.0 BCGTC(50Hz)



23-3655
THERMOSTAT KIT

Replaces: Westerbeke 39378, 46124
Temperature Rating: 160°
Fits: 5.0 BCG(60Hz)/4.2 BCG(50Hz), 5.0 BCGA(60Hz)/5.2 BCGA(50Hz), 7.0 BCGC(60Hz)/5.9 BCGC(50Hz), 5.0 SBCG(60Hz) / 4.0 SBEG(50Hz), 6.5 SBCG(60Hz) / 5.4 SBEG(50Hz)



23-3656
THERMOSTAT KIT

Replaces: Westerbeke 46097, 33417
Temperature Rating: 140°
Fits: 8.0 BEG(60Hz)/6.4 BEG(50Hz), 10.0 BEG(60Hz)/8.0 BEG(50Hz), 12.5 BEG(60Hz)/10.0 BEG(50Hz), 15.0 BEG(60Hz)/12.0 BEG(50Hz)



23-3657
THERMOSTAT KIT

Replaces: Westerbeke 24690, 33417
Temperature Rating: 180°
Fits: 8.0 SBEG(60Hz) / 6.4 SBEG(50Hz), 10.0 SBEG(60Hz) / 8.0 SBEG(50Hz), 12.5 SBEG(60Hz) / 10.0 SBEG(50Hz), 14.0 SBEG(60Hz) / 11.6 SBEG(50Hz)



23-3658
THERMOSTAT KIT
Replaces: *Westerbeke* 24688, 33966
Temperature Rating: 180°
Fits: 15.0 BTD(60Hz) / 12.0 BTD(50Hz)



23-3659
THERMOSTAT KIT
Replaces: *Westerbeke* 37387, 37922
Temperature Rating: 140°
Fits: 4.5 BCG(60Hz)/3.75 BCG(50Hz), 7.0 BCG(60Hz)/5.0 BCG(50Hz), 7.0 BCGA(60Hz)/5.0 BCGA(50Hz)



23-3660
THERMOSTAT KIT
Replaces: *Westerbeke* 24690, 33373
Temperature Rating: 180°
Fits: 15.0 BTDA(60Hz) / 12.0 BTDA(50Hz), 15.0 BTDB(60Hz) / 12.0 BTDB(50Hz), 15.0 WTA(60Hz) / 12.0 WTA(50Hz), 20.0 BED(60Hz) / 16.0 BED(50Hz), 20.0 BEDA(60Hz) / 16.0 BEDA(50Hz), 20.0 WTA(60Hz) / 16.0 WTA(50Hz), 25.0 BED(60Hz) / 20.0 BED(50Hz), 25.0 WTA(60Hz) / 20.0 WTA(50Hz)



23-3661
THERMOSTAT KIT
Replaces: *Westerbeke* 35736, 40434
Temperature Rating: 140°
Fits: 20.0 BEG(60Hz)/16.0 BEG(50Hz), 25.0 BEG(60Hz)/20.0 BEG(50Hz)



23-3662
THERMOSTAT KIT
Replaces: *Westerbeke* 24688, 40434
Temperature Rating: 180°
Fits: 20.0 SBEG(60Hz) / 16.0 SBEG(50Hz), 20.0 SBEGA(60Hz) / 16.0 SBEGA(50Hz), 22.5 SBEG(60Hz) / 18.7 SBEG(50Hz), 22.5 SBEGA(60Hz) / 18.7 SBEGA(50Hz)



23-3663
THERMOSTAT KIT
Replaces: *Kohler* 267717, 267718
Temperature Rating: 180°
Fits: 3.5 CFZ, 4 CZ, 5 CFZ, 6.5 CZ



23-3664
THERMOSTAT KIT
Replaces: *Kohler* 249930, 29963
Temperature Rating: 190°
Fits: 8E, 10E, 12.5E, 12.5CF, 15C, 16CF, 20C, 10 EG, 13 EG, 13 EGZ, 15 EG, 15 EGZ



23-3665
THERMOSTAT KIT
Replaces: *Kohler* 252896, 229432
Temperature Rating: 170°
Fits: 11 CCFQZ(Variation 1, 6), 11.5 CCFQZ(Variation 1, 6), 11.5EFOZ(Variation 1, 6), 13.5 CCOZ(Variation 1, 6), 14 CCOZ(Variation 1, 6), 14 EOZ(Variation 1, 6), 15.5EOZ(Variation 1, 6), 16EFOZ, 17.5EFOZ, 18.5 CCOZ, 19EFOZ, 20 CCFQZ, 20EOZ, 20EFOZ, 23EOZ, 24 CCOZ, 24EOZ



23-3666
THERMOSTAT KIT
Replaces: *Kohler* 352018, 352031
Temperature Rating: 195°
Fits: 33EFOZ(Variation 1), 33 CFOZ(Variation 1), 40 CFOZ(Variation 1), 40EOZ(Variation 1), 40EFOZ(Variation 1), 50 COZ(Variation 1), 50 CFOZ(Variation 1), 50EOZ(Variation 1), 55EFOZ(Variation 1), 65 COZ(Variation 1), 65EOZ(Variation 1), 70EFOZ(Variation 1), 80EOZ(Variation 1), 80EFOZ(Variation 1), 99EOZ(Variation 1), 100EFOZ(Variation 1), 125EOZ(Variation 1), 125EFOZ(Variation 1), 150EOZ(Variation 1)



23-2700
DISTRIBUTOR CAP
Replaces: *Westerbeke* 40859
Fits: 20.0 BEG(60Hz)/16.0 BEG(50Hz), 25.0 BEG(60Hz)/20.0 BEG(50Hz), 20.0 SBEG(60Hz) / 16.0 SBEG(50Hz), 20.0 SBEGA(60Hz) / 16.0 SBEGA(50Hz), 22.5 SBEG(60Hz) / 18.7 SBEG(50Hz), 22.5 SBEGA(60Hz) / 18.7 SBEGA(50Hz)



23-2701
DISTRIBUTOR CAP
Replaces: *Westerbeke* 34113
Fits: 6.5 TWG(60Hz)/4.9 TWG(50Hz), 8.0 TWG(60Hz)/6.4 TWG(50Hz), 11.0 TWG(60Hz)/8.5 TWG(50Hz), 8.5 BTG(60Hz)/6.5 BTG(50Hz), 12.5 BTG(60Hz)/10.0 BTG(50Hz), 15.0 BTG(A)(60Hz)/12.0 BTG(A)(50Hz)



23-2702
DISTRIBUTOR CAP
Replaces: *Westerbeke* 35608
Fits: 6.5 BCG(60Hz)/4.8 BCG(50Hz), 9.0 BTG(60Hz)/7.0 BTG(50Hz)



23-2703
DISTRIBUTOR CAP
Replaces: *Westerbeke* 46592
Fits: 8.0 BEG(60Hz)/6.4 BEG(50Hz), 10.0 BEG(60Hz)/8.0 BEG(50Hz), 12.5 BEG(60Hz)/10.0 BEG(50Hz), 15.0 BEG(60Hz)/12.0 BEG(50Hz), 8.0 SBEG(60Hz) / 6.4 SBEG(50Hz), 10.0 SBEG(60Hz) / 8.0 SBEG(50Hz), 12.5 SBEG(60Hz) / 10.0 SBEG(50Hz), 14.0 SBEG(60Hz) / 11.6 SBEG(50Hz)



**23-4500
PLUG WIRE SET**

Replaces: Westerbeke 43060
Fits: 4.5 BCGB(60Hz)/3.75 BCGB(50Hz), 4.5 BCGTC(60Hz)/3.75 BCGTC(50Hz), 4.5 BCGTE(60Hz)/3.75 BCGTE(50Hz), 5.0 BCG(60Hz)/4.2 BCG(50Hz), 5.0 BCGA(60Hz)/5.2 BCGA(50Hz), 7.0 BCGB(60Hz)/8.0 BCGB(50Hz), 7.0 BCGC(60Hz)/5.9 BCGC(50Hz), 7.0 BCGD(60Hz)/5.8 BCGD(50Hz), 7.2 BCGTC(60Hz)/6.0 BCGTC(50Hz), 9.6 BCGTC(60Hz)/8.0 BCGTC(50Hz), 9.6 BCGTE(60Hz)/8.0 BCGTE(50Hz)



**23-4501
PLUG WIRE SET**

Replaces: Westerbeke 46596
Fits: 8.0 BEG(60Hz)/6.4 BEG(50Hz), 10.0 BEG(60Hz)/8.0 BEG(50Hz), 12.5 BEG(60Hz)/10.0 BEG(50Hz), 15.0 BEG(60Hz)/12.0 BEG(50Hz), 8.0 SBEG(60Hz) / 6.4 SBEG(50Hz), 10.0 SBEG(60Hz) / 8.0 SBEG(50Hz), 12.5 SBEG(60Hz) / 10.0 SBEG(50Hz), 14.0 SBEG(60Hz) / 11.6 SBEG(50Hz)



**23-2800
ROTOR**

Replaces: Westerbeke 34093
Fits: 6.5 TWG(60Hz)/4.9 TWG(50Hz), 8.0 TWG(60Hz)/6.4 TWG(50Hz), 8.5 BTG(60Hz)/6.5 BTG(50Hz), 11.0 TWG(60Hz)/8.5 TWG(50Hz), 12.5 BTG(60Hz)/10.0 BTG(50Hz), 15.0 BTG/A(60Hz)/12.0 BTG/A(50Hz)



**23-2801
ROTOR**

Replaces: Westerbeke 35610
Fits: 4.0 BCG(60Hz)/3.0 BCG(50Hz)



**23-2802
ROTOR**

Replaces: Westerbeke 40860
Fits: 20.0 BEG(60Hz)/16.0 BEG(50Hz), 25.0 BEG(60Hz)/20.0 BEG(50Hz), 20.0 SBEG(60Hz) / 16.0 SBEG(50Hz), 20.0 SBEGA(60Hz) / 16.0 SBEGA(50Hz), 22.5 SBEG(60Hz) / 18.7 SBEG(50Hz), 22.5 SBEGA(60Hz) / 18.7 SBEGA(50Hz)



**23-2803
ROTOR**

Replaces: Westerbeke 43050
Fits: 4.5 BCGB(60Hz)/3.75 BCGB(50Hz), 4.5 BCGTC(60Hz)/3.75 BCGTC(50Hz), 5.0 BCG(60Hz)/4.2 BCG(50Hz), 5.0 BCGA(60Hz)/5.2 BCGA(50Hz), 7.0 BCGB(60Hz)/6.0 BCGB(50Hz), 7.0 BCGC(60Hz)/5.9 BCGC(50Hz), 7.2 BCGTC(60Hz)/6.0 BCGTC(50Hz), 8.0 BEG(60Hz)/6.4 BEG(50Hz), 9.6 BCGTC(60Hz)/8.0 BCGTC(50Hz), 10.0 BEG(60Hz)/8.0 BEG(50Hz), 12.5 BEG(60Hz)/10.0 BEG(50Hz), 15.0 BEG(60Hz)/12.0 BEG(50Hz), 5.0 SBCG(60Hz) / 4.0 SBEG(50Hz), 6.5 SBCG(60Hz) / 5.4 SBCG(50Hz), 8.0 SBEG(60Hz) / 6.4 SBEG(50Hz), 10.0 SBEG(60Hz) / 8.0 SBEG(50Hz), 12.5 SBEG(60Hz) / 10.0 SBEG(50Hz), 14.0 SBEG(60Hz) / 11.6 SBEG(50Hz)



**23-2804
ROTOR**

Replaces: Westerbeke 42201
Fits: 4.5 BCG(60Hz)/3.75 BCG(50Hz), 7.0 BCG(60Hz)/5.0 BCG(50Hz), 7.0 BCGA(60Hz)/5.0 BCGA(50Hz), 9.0 BTG(60Hz)/7.0 BTG(50Hz), 6.5 BCG(60Hz)/4.8 BCG(50Hz)



**23-7800
OIL FILTER**

Replaces: Westerbeke 36918
Fits: several models. See application chart on page 120-131



**23-7801
OIL FILTER**

Replaces: Westerbeke 35595
Notem Lights 24-0200
Fits: 4.0 BCG(60Hz)/3.0 BCG(50Hz), 6.5 BCG(60Hz)/4.8 BCG(50Hz), 9.0 BTG(60Hz)/7.0 BTG(50Hz), M753, M753G, M753K, M753W, M753W2, M773, LW2



**23-7802
OIL FILTER**

Replaces: Westerbeke 48078
Fits: 3.0 BPMG (60Hz)



**23-7803
OIL FILTER**

Replaces: Kohler 326817
Fits: 8E, 10E, 12.5E



**23-7804
OIL FILTER**

Replaces: Onan 185-7444
(Fits: MDKAU, MDKBH)
Fischer Panda. 15853-99170
Fits: PMS 8 MINI, PMS 8 DP, PMS 4200, PMS 6500, PMS 12 DP, PMS 12 Mini



**23-7820
OIL FILTER**

Replaces: Kohler 279449
Fits: 12.5CF, 15C, 16CF, 20C



23-7821
OIL FILTER
Replaces: Kohler 359771
Fits: 4EF, 5E, 6EF, 7.3E



23-7822
OIL FILTER
Replaces: Kohler 229678
Fits: 4 CCFDZ, 4 EFDZ, 5 CCOZ, 5 E0Z, 6.5 EFDZ, 8 E0Z



23-7823
OIL FILTER
Replaces: Kohler 267714
Fits: 3.5 CFZ, 3.5 EFZ, 4 CZ, 4 ESZ, 5 CFZ, 5 EFZ, 6.5 CZ, 6.5 ESZ



23-7824
OIL FILTER
Replaces: Kohler GM47465
Fits: 7 EFOZD(Var 1), 8.5 EFOZD(Var 1), 9 EOZD(Var 1), 9 EFOZD (Var 1), 10 EOZD(Var 1), 11 EFOZD, 11.5 EFOZD, 13 EOZD, 13 EFOZD, 14 EOZD, 15.5 EOZD, 17 EFOZD, 17.5 EFOZD, 19 EFOZD, 20 EOZD, 20 EFOZD, 23 EOZD, 24 EOZD



23-7825
OIL FILTER
Replaces: Westerbeke 35828
Fits: 11.0 BTD(60Hz) / 8.3 BTD(50Hz), 12.5 BTD(60Hz) / 9.4 BTD(50Hz), 12.5 BTDA(60Hz) / 9.4 BTDA(50Hz), 12.5 WMD(60Hz) / 9.4 WMD(50Hz), 15.0 BTD(60Hz) / 12.0 BTD(50Hz), 15.0 BTDA(60Hz) / 12.0 BTDA(50Hz), 15.0 BTDB(60Hz) / 12.0 BTDB(50Hz)



23-7826
OIL FILTER
Replaces: Westerbeke 40154
Fits: 20.0 BED(60Hz) / 16.0 BED(50Hz), 20.0 BEDA(60Hz) / 16.0 BEDA(50Hz), 25.0 BED(60Hz) / 20.0 BED(50Hz), 25.0 WTA(60Hz) / 20.0 WTA(50Hz), 32.0 BED(60Hz) / 25.0 BED(50Hz), 32.0 BEDA(60Hz) / 25.0 BEDA(50Hz)



23-7840
OIL FILTER
Replaces: Onan 122-0810
Fits: MDKBD, MDKBE, MDKBF, MDKBD (w/ Isolated Ground), MDKBE (w/ Isolated Ground), MDKBF (w/ Isolated Ground), MDKAD/E/F



23-7841
OIL FILTER
Replaces: Onan 122-0185
Fits: MDJB, MDJC, MDJE, MDJF, MJA, MJB, MJC



23-7842
OIL FILTER
Replaces: Onan 185-5835
Fits: MDKAV, MDKBG, MDKAW (Spacesaver), MDKAZ, MDKAL/A/B, MDKKB, MDKBL, MDKBM, MDKBN

As with Marine Engines, Generators require routine maintenance and changing of engine oil is critical to maintaining and extending their useful life. With the addition of many oil filters for the Marine Generator market, Sierra offers several grades of oil for the gasoline and diesel Generator applications. These oils are specifically formulated for the Marine Industry to provide excellent lubrication and corrosion protection. All of these oils are backed by Sierra's **Industry Leading Warranty**.

Part#	Description	Qty	Case Qty
18-9420-2	10W30 4-Stroke	Qt.	12
18-9400-2	25W40 4-Stroke	Qt.	12
18-9553-2	15W40 Diesel Oil	Qt.	12
18-9410-2	SAE 30 Full Syn.	Qt.	12



56966P
HOURLMETER
Round



56967P
HOURLMETER
Rectangular





23-6400

ANODE

Replaces:

Westerbeke 11885, Kohler 260085

Fits several models. See application chart on page 120-131



23-6401

ANODE

Replaces: Onan 130-4434

Fits: MDKAV, MDKBG, MDKAW (Spacesaver), MDKAZ, MDKBD, MDKBE, MDKBF, MDKBD (w/ Isolated Ground), MDKBE (w/ Isolated Ground), MDKBF (w/ Isolated Ground), MDKBB, MDKBB, MDKBL, MDKBM, MDKBN, MDKBP, MDKBR, MDKBS, MDKBV, MDKBT, MDKBU



23-6402

ANODE

Replaces: Onan 130-6228

Fits: MDDCA, MDDCB, MDDCC, MDDCF, MDDCG, MDDCD, MDDCE, MDDCH, MDDCJ

23-5800

SOLENOID

Replaces: Westerbeke 24639

Fits: 3.0 WMD(60Hz)/2.4 WMD(50Hz), 4.0 BCD(60Hz), 4.4 BCD(60Hz), 4.4 WMD(60Hz) / 3.3 WMD(50Hz), 5.0 BCD/BCDA/BCDB(60Hz) / 4.0 BCD/BCDA/BCDB(50Hz), 6.0 BCD(60Hz) / 4.5 BCD(50Hz), 7.6 BTD(60Hz) / 5.7 BTD(50Hz), 7.7 WMD(60Hz) / 5.8 WMD(50Hz), 8.0 BTD(60Hz) / 8.0 BTD(50Hz), 8.0 BTDA(60Hz) / 6.0 BTDA(50Hz), 8.0 WMD(60Hz) / 6.0 WMD(50Hz), 10.0 BTD(60Hz) / 7.5 BTD(50Hz), 10.0 BTDA(60Hz) / 7.5 BTDA(50Hz), 11.0 BTD(60Hz) / 8.3 BTD(50Hz), 11.0 WMD(60Hz) / 8.3 WMD(50Hz), 12.5 BTD(60Hz) / 9.4 BTD(50Hz), 12.5 BTDA(60Hz) / 9.4 BTDA(50Hz), 12.5 BTDB(60Hz) / 9.4 BTDB(50Hz), 12.5 WMD(60Hz) / 9.4 WMD(50Hz), 15.0 BTD(60Hz) / 12.0 BTD(50Hz), 15.0 BTDA(60Hz) / 12.0 BTDA(50Hz), 15.0 BTDB(60Hz) / 12.0 BTDB(50Hz), 15.0 BTDC(60Hz) / 12.0 BTDC(50Hz), 15.0 WTA(60Hz) / 12.0 WTA(50Hz), 20.0 BED(60Hz) / 16.0 BED(50Hz), 20.0 BEDA(60Hz) / 16.0 BEDA(50Hz), 20.0 WTA(60Hz) / 16.0 WTA(50Hz), 25.0 BED(60Hz) / 20.0 BED(50Hz), 25.0 WTA(60Hz) / 20.0 WTA(50Hz), 32.0 BED(60Hz) / 25.0 BED(50Hz), 32.0 BEDA(60Hz) / 25.0 BEDA(50Hz), 32.0 BEDB(60Hz) / 25.0 BEDB(50Hz), 32.0 WTF(60Hz) / 25.0 WTF(50Hz)

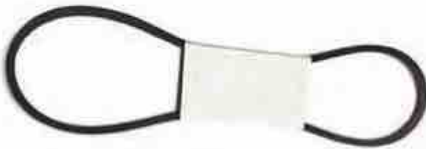

23-4000

ALTERNATOR BELT

Replaces: Westerbeke 39181

Fits: 20.0 BED(60Hz) / 16.0 BED(50Hz), 20.0 BEDA(60Hz) / 16.0 BEDA(50Hz), 25.0 BED(60Hz) / 20.0 BED(50Hz)



23-4001

ALTERNATOR BELT

Replaces: Westerbeke 11672

Fits: 15.0 BTDA(60Hz) / 12.0 BTDA(50Hz), 15.0 BTDB(60Hz) / 12.0 BTDB(50Hz), 20.0 WTA(60Hz) / 16.0 WTA(50Hz)



23-4002

ALTERNATOR BELT

Replaces: Westerbeke 30592

Fits: 6.5 TWG(60Hz)/4.9 TWG(50Hz), 8.0 TWG(60Hz)/6.4 TWG(50Hz), 11.0 TWG(60Hz)/8.5 TWG(50Hz), 8.0 BCD(60Hz) / 4.5 BCD(50Hz), 7.7 WMD(60Hz) / 5.8 WMD(50Hz), 8.0 WMD(60Hz) / 6.0 WMD(50Hz), 11.0 BTD(60Hz) / 8.3 BTD(50Hz)



23-4003

ALTERNATOR BELT

Replaces: Westerbeke 45232

Fits: 4.4 WMD(60Hz)/3.3 WMD(50Hz), 7.7 WMD(60Hz)/5.8 WMD(50Hz), 8.0 BTDA(60Hz)/6.0 BTDA(50Hz), 8.0 WMD(60Hz)/6.0 WMD(50Hz), 10.0 BTDA(60Hz)/7.5 BTDA(50Hz), 11.0 BTD(60Hz)/8.3 BTD(50Hz), 11.0 WMD(60Hz)/8.3 WMD(50Hz), 12.5 BTD(60Hz)/9.4 BTD(50Hz), 12.5 BTDA(60Hz)/9.4 BTDA(50Hz), 12.5 BTDB(60Hz)/9.4 BTDB(50Hz), 12.5 WMD(60Hz)/9.4 WMD(50Hz), 12.6 BTD(60Hz)/10.4 BTD(50Hz), 15.0 BTDC(60Hz) / 12.0 BTDC(50Hz)



23-4004

ALTERNATOR BELT

Replaces: Westerbeke 30475

Fits: 12.5 BTG(60Hz)/10.0 BTG(50Hz), 15.0 BTG/A(60Hz)/12.0 BTG/A(50Hz), 8.0 BTD(60Hz) / 6.0 BTD(50Hz), 10.0 BTD(60Hz) / 7.5 BTD(50Hz), 12.5 BTD(60Hz) / 9.4 BTD(50Hz), 12.5 BTDA(60Hz) / 9.4 BTDA(50Hz), 12.5 WMD(60Hz) / 9.4 WMD(50Hz), 15.0 BTD(60Hz) / 12.0 BTD(50Hz)



23-5600

STARTER

Replaces: Westerbeke 30593

Fits: 4.4 WMD(60Hz)/3.3 WMD(50Hz), 7.7 WMD(60Hz)/5.8 WMD(50Hz), 8.0 BTDA(60Hz)/6.0 BTDA(50Hz), 8.0 WMD(60Hz)/6.0 WMD(50Hz), 10.0 BTDA(60Hz)/7.5 BTDA(50Hz), 11.0 BTD(60Hz)/8.3 BTD(50Hz), 11.0 WMD(60Hz)/8.3 WMD(50Hz), 12.5 BTD(60Hz)/9.4 BTD(50Hz), 12.5 BTDA(60Hz)/9.4 BTDA(50Hz), 12.5 BTDB(60Hz)/9.4 BTDB(50Hz), 12.5 WMD(60Hz)/9.4 WMD(50Hz), 12.6 BTD(60Hz)/10.4 BTD(50Hz), 15.0 BTD(60Hz)/12.0 BTD(50Hz), 15.0 BTDA(60Hz)/12.0 BTDA(50Hz), 15.0 BTDB(60Hz)/12.0 BTDB(50Hz), 15.0 BTDC(60Hz)/12.0 BTDC(50Hz)



Sierra
Marine Engine and Drive Parts

GENERATOR PARTS

Sierra offers over 100 products focused entirely on servicing the generator market. Applications cover all applicable product categories with a focus on Kohler®, Onan® & Westerbeke® Generator Sets.

Like all Sierra products, quality is insured by our industry leading Limited Lifetime Warranty.



THE VERY BEST PARTS OF BOATING

Model	OEM	Start-er	Alternator	Fuel Filter	Impeller	Impeller Kit	Thermostat
3.0 WMD(60Hz)/2.4 WMD(50Hz)	Westerbeke	—	—	23-7770	23-2001	23-3305	23-3600
3.8/4.2 BCDT(60Hz) / 3.5 BCDT(50Hz)	Westerbeke	—	—	—	23-2001	23-3305	—
4.0 BCD(60Hz)	Westerbeke	—	—	23-7770	—	23-3307	—
4.4 BCD(60Hz)	Westerbeke	—	—	—	23-2001	23-3307	23-3600
4.4 WMD(60Hz) / 3.3 WMD(50Hz)	Westerbeke	23-5600	—	23-7770	—	23-3307	23-3600
5.0 BCD/BCDA/BCDB(60Hz) / 4.0 BCD/BCDA/BCDB(50Hz)	Westerbeke	—	—	23-7770	—	23-3307	—
5.0 BCDR(60Hz) / 4.0 BCDR(50Hz)	Westerbeke	—	—	—	—	—	—
6.0 BCD(60Hz) / 4.5 BCD(50Hz)	Westerbeke	—	—	23-7770	—	23-3307	23-3600
7.6 BTD(60Hz) / 5.7 BTD(50Hz)	Westerbeke	—	—	23-7770	—	23-3307	—
7.7 WMD(60Hz) / 5.8 WMD(50Hz)	Westerbeke	23-5600	—	23-7770	—	23-3307	23-3600
8.0 BTD(60Hz) / 6.0 BTD(50Hz)	Westerbeke	—	—	23-7770	—	23-3307	23-3600
8.0 BTDA(60Hz) / 6.0 BTDA(50Hz)	Westerbeke	23-5600	—	23-7770	23-3307 (Before March 2004)	23-3307	23-3600
8.0 BCDT(60Hz) / 7.0 BCDT(50Hz)	Westerbeke	—	—	23-7770	—	—	—
8.0 WMD(60Hz) / 6.0 WMD(50Hz)	Westerbeke	23-5600	—	23-7770	—	23-3307	23-3600
10.0 BTD(60Hz) / 7.5 BTD(50Hz)	Westerbeke	—	—	23-7770	—	23-3307	23-3600
10.0 BTDA(60Hz) / 7.5 BTDA(50Hz)	Westerbeke	23-5600	—	23-7770	—	23-3307	23-3600
11.0 BTD(60Hz) / 8.3 BTD(50Hz)	Westerbeke	23-5600	—	23-7770	—	23-3307	23-3600
11.0 WMD(60Hz) / 8.3 WMD(50Hz)	Westerbeke	23-5600	—	23-7770	—	23-3307	23-3600
12.5 BTD(60Hz) / 9.4 BTD(50Hz)	Westerbeke	23-5600	—	23-7770	—	23-3307	23-3600
12.5 BTDA(60Hz) / 9.4 BTDA(50Hz)	Westerbeke	23-5600	—	23-7770	—	23-3307	23-3600
12.5 BTDB(60Hz) / 9.4 BTDB(50Hz)	Westerbeke	23-5600	—	23-7770	—	23-3307	23-3600
12.5 WMD(60Hz) / 9.4 WMD(50Hz)	Westerbeke	23-5600	—	23-7770	—	23-3307	23-3600
12.6 BTD(60Hz) / 10.4 BTD(50Hz)	Westerbeke	23-5600	—	23-7770	—	—	23-3600
15.0 BTD(60Hz) / 12.0 BTD(50Hz)	Westerbeke	23-5600	—	23-7764	—	23-3313	23-3600
15.0 BTDA(60Hz) / 12.0 BTDA(50Hz)	Westerbeke	23-5600	—	23-7764	—	23-3313	23-3605
15.0 BTDB(60Hz) / 12.0 BTDB(50Hz)	Westerbeke	23-5600	—	23-7764	—	23-3313	23-3605
15.0 BTDC(60Hz) / 12.0 BTDC(50Hz)	Westerbeke	23-5600	—	23-7770	—	23-3307	23-3600
15.0 WTA(60Hz) / 12.0 WTA(50Hz)	Westerbeke	—	—	23-7764	—	23-3313	23-3605
20.0 BED(60Hz) / 16.0 BED(50Hz)	Westerbeke	—	—	23-7764	—	23-3301	23-3605
20.0 BEDA(60Hz) / 16.0 BEDA(50Hz)	Westerbeke	—	—	23-7764	—	23-3301	23-3605
20.0 WTA(60Hz) / 16.0 WTA(50Hz)	Westerbeke	—	—	23-7764	23-2000	23-3302	23-3605
25.0 BED(60Hz) / 20.0 BED(50Hz)	Westerbeke	—	—	23-7764	—	23-3301	23-3605
25.0 WTA(60Hz) / 20.0 WTA(50Hz)	Westerbeke	—	—	23-7764	—	23-3301	23-3605
32.0 BED(60Hz) / 25.0 BED(50Hz)	Westerbeke	—	—	23-7764	—	23-3301	—
32.0 BEDA(60Hz) / 25.0 BEDA(50Hz)	Westerbeke	—	—	23-7764	—	23-3301	23-3605
32.0 BEDB(60Hz) / 25.0 BEDB(50Hz)	Westerbeke	—	—	—	—	23-3301	—
32.0 WTF(60Hz) / 25.0 WTF(50Hz)	Westerbeke	—	—	23-7764	—	23-3301	—
3.0 BPMG (60Hz)	Westerbeke	—	—	23-7770	—	—	—
4.0 BCG(60Hz)/3.0 BCG(50Hz)	Westerbeke	—	—	23-7720	23-2001	23-3305	23-3601
4.5 BCG(60Hz)/3.75 BCG(50Hz)	Westerbeke	—	—	—	23-2001	23-3305	23-3602

Thermostat Kit	Oil Filter	Air Filter	Thermostat Gasket	Anode	Carburetor Kit	Glow Plug	Temperature Sender	Oil Pressure Sender	Solenoid
—	23-7800	—	—	23-6400	—	—	23-5840	23-5880	23-5800
—	—	—	—	—	—	—	—	—	—
—	23-7800	—	—	—	—	—	23-5840	23-5880	23-5800
23-3650	23-7800	—	23-0806	23-6400	—	23-1000	23-5840	23-5880	23-5800
23-3650	23-7800	—	23-0806	23-6400	—	23-1000	23-5840	23-5880	23-5800
—	23-7800	—	—	23-6400	—	—	23-5840	23-5880	23-5800
—	23-7800	—	—	—	—	—	—	—	—
—	23-7800	—	23-0802	23-6400	—	23-1000	23-5840	23-5880	23-5800
—	23-7800	—	—	—	—	—	—	23-5880	23-5800
23-3650	23-7800	—	23-0806	—	—	23-1000	23-5840	23-5880	23-5800
23-3653	23-7800	—	23-0802	—	—	23-1000	23-5840	23-5880	23-5800
—	23-7800	23-1101	—	—	—	23-1000	23-5840	23-5880	23-5800
—	23-7800	—	—	23-6400	—	—	—	—	—
23-3650	23-7800	—	23-0806	—	—	23-1000	23-5840	23-5880	23-5800
23-3653	23-7800	—	23-0802	23-6400	—	23-1000	23-5840	23-5880	23-5800
—	23-7800	23-1101	—	—	—	23-1000	23-5840	23-5880	23-5800
23-3653	23-7825	—	23-0802	—	—	23-1000	23-5840	23-5880	23-5800
23-3650	23-7800	—	23-0806	23-6400	—	23-1000	23-5840	23-5880	23-5800
23-3653	23-7825	—	23-0802	—	—	23-1000	23-5840	23-5880	23-5800
23-3653	23-7825	—	23-0802	—	—	23-1000	23-5840	23-5880	23-5800
—	23-7800	23-1101	—	—	—	23-1000	23-5840	23-5880	23-5800
23-3650	23-7825	—	23-0806	—	—	23-1000	23-5840	23-5880	23-5800
23-3653	23-7800	23-1101	23-0802	23-6400	—	—	—	—	—
23-3658	23-7825	—	23-0807	—	—	23-1000	23-5840	—	23-5800
23-3660	23-7825	—	23-0804	—	—	23-1000	23-5840	—	23-5800
23-3660	23-7825	—	23-0804	—	—	23-1000	23-5840	—	23-5800
—	23-7800	23-1101	—	—	—	23-1000	23-5840	—	23-5800
23-3660	—	—	23-0804	—	—	23-1000	23-5840	—	23-5800
23-3660	23-7826	—	23-0804	—	—	23-1000	23-5840	—	23-5800
23-3660	23-7826	—	23-0804	—	—	23-1000	23-5840	—	23-5800
23-3660	—	—	23-0804	—	—	23-1000	23-5840	—	23-5800
23-3660	23-7826	—	23-0804	—	—	23-1000	23-5840	—	23-5800
23-3660	23-7826	—	23-0804	—	—	23-1000	23-5840	—	23-5800
—	23-7826	—	—	—	—	23-1000	23-5840	—	23-5800
—	23-7826	—	—	—	—	—	23-5840	—	23-5800
—	23-7826	—	—	—	—	23-1000	23-5840	—	23-5800
—	23-7826	—	—	—	—	23-1000	23-5840	—	23-5800
—	23-7802	—	—	—	—	—	—	—	—
23-3651	23-7801	—	23-0802	23-6400	23-7201	—	23-5840	—	—
23-3659	23-7800	—	23-0808	23-6400	23-7201	—	23-5840	—	—

Model	OEM	Start-er	Alternator	Fuel Filter	Impeller	Impeller Kit	Thermostat
4.5 BCGB(60Hz)/3.75 BCGB(50Hz)	Westerbeke	—	—	—	23-2001	23-3305	23-3603
4.5 BCGTC(60Hz)/3.75 BCGTC(50Hz)	Westerbeke	—	—	—	23-2001	23-3305	23-3603
4.5 BCGTE(60Hz) / 3.75 BCGTE(50Hz)	Westerbeke	—	—	—	—	—	—
5.0 BCG(60Hz)/4.2 BCG(50Hz)	Westerbeke	—	—	23-7770	23-2001	23-3306	23-3603
5.0 BCGA(60Hz)/5.2 BCGA(50Hz)	Westerbeke	—	—	23-7770	23-2001	23-3306	23-3603
8.5 BCG(60Hz)/4.8 BCG(50Hz)	Westerbeke	—	—	23-7720	23-2001	23-3305	23-3601
6.5 TWG(60Hz)/4.9 TWG(50Hz)	Westerbeke	—	—	23-7720	23-2000	23-3302	23-3601
7.0 BCG(60Hz)/5.0 BCG(50Hz)	Westerbeke	—	—	—	23-2001	23-3305	23-3602
7.0 BCGA(60Hz)/5.0 BCGA(50Hz)	Westerbeke	—	—	—	23-2001	23-3305	23-3602
7.0 BCGB(60Hz)/6.0 BCGB(50Hz)	Westerbeke	—	—	—	23-2001	23-3305	23-3603
7.0 BCGC(60Hz)/5.9 BCGC(50Hz)	Westerbeke	—	—	23-7770	23-2001	23-3306	23-3603
7.0 BCGD(60Hz) / 5.8 BCGD(50Hz)	Westerbeke	—	—	23-7770	23-2001	23-3306	—
7.2 BCGTC(60Hz)/6.0 BCGTC(50Hz)	Westerbeke	—	—	23-7770	23-2001	23-3305	23-3603
8.0 BEG(60Hz)/6.4 BEG(50Hz)	Westerbeke	—	—	23-7770	23-2001	23-3306	23-3605
8.0 TWG(60Hz)/6.4 TWG(50Hz)	Westerbeke	—	—	23-7720	23-2000	23-3302	23-3601
8.5 BTG(60Hz)/6.5 BTG(50Hz)	Westerbeke	—	—	—	23-2000	23-3302	23-3601
8.5 BTGA(60Hz) / 6.6 BTGA(50Hz)	Westerbeke	—	—	—	23-2000	23-3302	23-3601
9.0 BTG(60Hz)/7.0 BTG(50Hz)	Westerbeke	—	—	23-7720	23-2001	23-3305	23-3601
9.6 BCGTC(60Hz)/8.0 BCGTC(50Hz)	Westerbeke	—	—	—	23-2001	23-3305	23-3603
10.0 BEG(60Hz)/8.0 BEG(50Hz)	Westerbeke	—	—	23-7770	23-2001	23-3306	23-3605
11.0 TWG(60Hz)/8.5 TWG(50Hz)	Westerbeke	—	—	23-7720	23-2000	23-3302	23-3601
12.5 BEG(60Hz)/10.0 BEG(50Hz)	Westerbeke	—	—	23-7770	23-2001	23-3306	23-3605
12.5 BTG(60Hz)/10.0 BTG(50Hz)	Westerbeke	—	—	—	23-2000	23-3302	23-3601
15.0 BEG(60Hz)/12.0 BEG(50Hz)	Westerbeke	—	—	23-7770	23-2001	23-3306	23-3605
15.0 BTG/A(60Hz)/12.0 BTG/A(50Hz)	Westerbeke	—	—	—	23-2000	23-3302	23-3601
20.0 BEG(60Hz)/16.0 BEG(50Hz)	Westerbeke	—	—	—	—	23-3301	23-3601
25.0 BEG(60Hz)/20.0 BEG(50Hz)	Westerbeke	—	—	—	—	23-3301	23-3601
5.0 SBCE(60Hz) / 4.0 SBCE(50Hz)	Westerbeke	—	—	23-7770	23-2001	23-3306	23-3603
6.5 SBCE(60Hz) / 5.4 SBCE(50Hz)	Westerbeke	—	—	23-7770	23-2001	23-3306	23-3603
8.0 SBEG(60Hz) / 6.4 SBEG(50Hz)	Westerbeke	—	—	23-7770	23-2001	23-3306	23-3605
10.0 SBEG(60Hz) / 8.0 SBEG(50Hz)	Westerbeke	—	—	23-7770	23-2001	23-3306	23-3605
12.5 SBEG(60Hz) / 10.0 SBEG(50Hz)	Westerbeke	—	—	23-7770	23-2001	23-3306	23-3605
14.0 SBEG(60Hz) / 11.6 SBEG(50Hz)	Westerbeke	—	—	23-7770	23-2001	23-3306	23-3605
18.0 SBEG	Westerbeke	—	—	—	—	—	—
18.0 SBEGA	Westerbeke	—	—	—	—	—	—
20.0 SBEG(60Hz) / 16.0 SBEG(50Hz)	Westerbeke	—	—	23-7770	—	23-3301	23-3600
20.0 SBEGA(60Hz) / 16.0 SBEGA(50Hz)	Westerbeke	—	—	23-7770	—	23-3301	23-3600
22.5 SBEG(60Hz) / 18.7 SBEG(50Hz)	Westerbeke	—	—	23-7770	—	23-3301	23-3600
22.5 SBEGA(60Hz) / 18.7 SBEGA(50Hz)	Westerbeke	—	—	23-7770	—	23-3301	23-3600
5.5 EDC(60Hz) / 5.0 EDC(50Hz)	Westerbeke	—	—	23-7770	—	—	—

Thermostat Kit	Oil Filter	Air Filter	Thermostat Gasket	Anode	Carburetor Kit	Glow Plug	Temperature Sender	Oil Pressure Sender	Solenoid
23-3654	23-7800	—	23-0800	23-6400	23-7201	—	—	—	—
23-3654	23-7800	—	23-0800	23-6400	23-7201	—	—	—	—
	23-7800								
23-3655	23-7800	—	23-0801	23-6400	23-7201	—	—	—	—
23-3655	23-7800	—	23-0801	23-6400	—	—	—	—	—
23-3651	23-7801	—	23-0802	23-6400	23-7201	—	23-5840	—	—
23-3652	23-7800	—	23-0803	23-6400	23-7200	—	23-5840	—	—
23-3659	23-7800	—	23-0808	23-6400	23-7201	—	23-5840	—	—
23-3659	23-7800	—	23-0808	23-6400	23-7201	—	23-5840	—	—
23-3654	23-7800	—	23-0800	23-6400	23-7201	—	—	—	—
23-3655	23-7800	—	23-0801	23-6400	—	—	—	—	—
—	23-7800	—	—	23-6400	—	—	—	—	—
23-3654	23-7800	—	23-0800	23-6400	23-7201	—	—	—	—
23-3656	23-7800	—	23-0803	23-6400	23-7201	—	23-5840	23-5880	—
23-3651	23-7800	—	23-0802	23-6400	23-7200	—	23-5840	—	—
23-3652	23-7800	—	23-0803	23-6400	23-7200	—	23-5840	23-5880	—
—	23-7800	—	—	23-6400	23-7200	—	—	—	—
23-3651	23-7801	—	23-0802	23-6400	—	—	23-5840	—	—
23-3654	23-7800	—	23-0800	23-6400	23-7201	—	—	—	—
23-3656	23-7800	—	23-0803	23-6400	23-7201	—	23-5840	23-5880	—
23-3651	23-7800	—	23-0802	23-6400	—	—	23-5840	—	—
23-3656	23-7800	—	23-0803	23-6400	23-7201	—	23-5840	23-5880	—
23-3652	23-7800	—	23-0803	23-6400	23-7200	—	23-5840	23-5880	—
23-3656	23-7800	—	23-0803	23-6400	23-7201	—	23-5840	23-5880	—
23-3652	23-7800	—	23-0803	23-6400	23-7200	—	23-5840	23-5880	—
23-3661	23-7800	—	23-0805	23-6400	23-7200	—	23-5840	23-5880	—
23-3661	23-7800	—	23-0805	23-6400	23-7200	—	23-5840	23-5880	—
23-3655	23-7800	—	23-0801	23-6400	—	—	—	—	—
23-3655	23-7800	—	23-0801	23-6400	—	—	—	—	—
23-3657	23-7800	—	23-0803	23-6400	—	—	—	—	—
23-3657	23-7800	—	23-0803	23-6400	—	—	—	—	—
23-3657	23-7800	—	23-0803	23-6400	—	—	—	—	—
23-3657	23-7800	—	23-0803	23-6400	—	—	—	—	—
	23-7800								
	23-7800								
23-3662	23-7800	—	23-0805	23-6400	—	—	—	—	—
23-3662	23-7800	—	23-0805	23-6400	—	—	—	—	—
23-3662	23-7800	—	23-0805	23-6400	—	—	—	—	—
23-3662	23-7800	—	23-0805	23-6400	—	—	—	—	—
—	23-7800	—	—	23-6400	—	—	—	—	—

Model	OEM	Start-er	Alternator	Fuel Filter	Impeller	Impeller Kit	Thermostat
7.6 EDT(60Hz) / 5.7 EDT(50Hz)	Westerbeke	—	—	23-7770	—	—	—
8.0 EDT(60Hz) / 6.0 EDT(50Hz)	Westerbeke	—	—	23-7770	—	—	—
10.0 EDT(60Hz) / 7.5 EDT(50Hz)	Westerbeke	—	—	23-7770	—	—	—
11.5 EDT(60Hz) / 9.2 EDT(50Hz)	Westerbeke	—	—	23-7770	—	—	—
12.5 EDT(60Hz) / 9.4 EDT(50Hz)	Westerbeke	—	—	23-7770	—	—	—
12.6 EDT(60Hz) / 10.4 EDT(50Hz)	Westerbeke	—	—	23-7770	—	—	—
15.0 EDT(60Hz) / 12.0 EDT(50Hz)	Westerbeke	—	—	23-7770	—	—	—
4 CCFOZ	Kohler	—	—	23-7751	23-2002(SN 296899 & Up) 23-2003(SN 296898 & below)	23-3303(SN 296899 & Up) 23-3304(SN 296898 & below)	—
4EFOZ	Kohler	—	—	23-7751	23-2002(SN 296899 & Up) 23-2003(SN 296898 & below)	23-3303(SN 296899 & Up) 23-3304(SN 296898 & below)	—
5 CCOZ	Kohler	—	—	23-7751	23-2002(SN 296899 & Up) 23-2003(SN 296898 & below)	23-3303(SN 296899 & Up) 23-3304(SN 296898 & below)	—
5EOZ	Kohler	—	—	23-7751	23-2002(SN 296899 & Up) 23-2003(SN 296898 & below)	23-3303(SN 296899 & Up) 23-3304(SN 296898 & below)	—
6.5 EFOZ	Kohler	—	—	23-7751	23-2002(SN 296899 & Up) 23-2003(SN 296898 & below)	23-3303(SN 296899 & Up) 23-3304(SN 296898 & below)	—
8EOZ	Kohler	—	—	23-7751	23-2002(SN 296899 & Up) 23-2003(SN 296898 & below)	23-3303(SN 296899 & Up) 23-3304(SN 296898 & below)	—
8EFOZ	Kohler	—	—	—	23-2002(SN 296899 & Up) 23-2003(SN 296898 & below)	23-3303(SN 296899 & Up) 23-3304(SN 296898 & below)	—
8CCFOZ	Kohler	—	—	—	23-2002(SN 296899 & Up) 23-2003(SN 296898 & below)	23-3303(SN 296899 & Up) 23-3304(SN 296898 & below)	—
9CCOZ	Kohler	—	—	—	23-2002(SN 296899 & Up) 23-2003(SN 296898 & below)	23-3303(SN 296899 & Up) 23-3304(SN 296898 & below)	—
9EOZ	Kohler	—	—	—	23-2002(SN 296899 & Up) 23-2003(SN 296898 & below)	23-3303(SN 296899 & Up) 23-3304(SN 296898 & below)	—
9EFOZ	Kohler	—	—	—	23-2002(SN 296899 & Up) 23-2003(SN 296898 & below)	23-3303(SN 296899 & Up) 23-3304(SN 296898 & below)	—
10EOZ	Kohler	—	—	—	23-2002(SN 296899 & Up) 23-2003(SN 296898 & below)	23-3303(SN 296899 & Up) 23-3304(SN 296898 & below)	—
11 CCFOZ	Kohler	—	—	—23-7740(Var 2)	23-2003	23-3304	23-3609
11.5 CCFOZ	Kohler	—	—	23-7740(Var 2)	23-2003	23-3304	23-3609
11EFOZ	Kohler	—	—	23-7740(Var 2)	23-2003	23-3304	23-3609
11.5EFOZ	Kohler	—	—	23-7740(Var 2)	23-2003	23-3304	23-3609
13EOZ	Kohler	—	—	23-7740(Var 2)	23-2003	23-3304	23-3609
13EFOZ	Kohler	—	—	23-7740(Var 2)	23-2003	23-3304	23-3609
13.5 CCOZ	Kohler	—	—	23-7740(Var 2)	23-2003	23-3304	23-3609
14 CCOZ	Kohler	—	—	23-7740(Var 2)	23-2003	23-3304	23-3609
14 EOZ	Kohler	—	—	23-7740(Var 2)	23-2003	23-3304	23-3609
15 CCFOZ	Kohler	—	—	23-7740(Var 3)	23-2003	23-3304	23-3609
15.5EOZ	Kohler	—	—	23-7740(Var 2)	23-2003	23-3304	23-3609
16EFOZ	Kohler	—	—	23-7740(Var 3)	23-2003	23-3304	23-3609
17.5EFOZ	Kohler	—	—	23-7740(Var 3)	23-2003	23-3304	23-3609
18.5 CCOZ	Kohler	—	—	23-7740(Var 3)	23-2003	23-3304	23-3609
19EFOZ	Kohler	—	—	23-7740(Var 3)	23-2003	23-3304	23-3609
20 CCFOZ	Kohler	—	—	23-7740(Var 3)	23-2003	23-3304	23-3609

Model	OEM	Start-er	Alternator	Fuel Filter	Impeller	Impeller Kit	Thermostat
20EOZ	Kohler	—	—	23-7740(Var 3)	23-2003	23-3304	23-3609
20EFOZ	Kohler	—	—	23-7740(Var 3)	23-2003	23-3304	23-3609
23EOZ	Kohler	—	—	23-7740(Var 3)	23-2003	23-3304	23-3609
24 COOZ	Kohler	—	—	23-7740(Var 3)	23-2003	23-3304	23-3609
24EOZ	Kohler	—	—	23-7740(Var 3)	23-2003	23-3304	23-3609
6.5EFOZD	Kohler	—	—	23-7751	23-2002	23-3303	—
7 EFOZD	Kohler	—	—	23-7761(Var 1)	23-2002	23-3303	—
8EOZD	Kohler	—	—	23-7751	23-2002	23-3303	—
8.5 EFOZD	Kohler	—	—	23-7761(Var 1)	23-2002	23-3303	—
9 EOZD	Kohler	—	—	23-7761(Var 1)	23-2002	23-3303	—
9EFOZD	Kohler	—	—	23-7761(Var 1)	23-2002	23-3303	—
10EOZD	Kohler	—	—	23-7761(Var 1)	23-2002	23-3303	—
11EFOZD	Kohler	—	—	23-7761(Var 1)	23-2003	23-3304	—
11.5EFOZD	Kohler	—	—	23-7761(Var 1)	23-2003	23-3304	—
13EOZD	Kohler	—	—	23-7761(Var 1)	23-2003	23-3304	—
13EFOZD	Kohler	—	—	23-7761(Var 1)	23-2003	23-3304	—
14 EOZD	Kohler	—	—	23-7761(Var 1)	23-2003	23-3304	—
15.5 EOZD	Kohler	—	—	23-7761(Var 1)	23-2003	23-3304	—
17 EFOZD	Kohler	—	—	23-7740(Var 3), 23-7761(Var 1)	23-2003	23-3304	—
17.5EFOZD	Kohler	—	—	23-7740(Var 3), 23-7761(Var 1)	23-2003	23-3304	—
19EFOZD	Kohler	—	—	23-7740(Var 3), 23-7761(Var 1)	23-2003	23-3304	—
20EOZD	Kohler	—	—	23-7740(Var 3), 23-7761(Var 1)	23-2003	23-3304	—
20EFOZD	Kohler	—	—	23-7740(Var 3), 23-7761(Var 1)	23-2003	23-3304	—
23EFOZ		—	—	—	23-2002	23-3303	—
23EOZD	Kohler	—	—	23-7740(Var 3), 23-7761(Var 1)	23-2003	23-3304	—
23EFOZD	Kohler	—	—	23-7761	23-2002	23-3303	—
24EOZD	Kohler	—	—	23-7740(Var 3), 23-7761(Var 1)	23-2003	23-3304	—
27EFOZ		—	—	—	23-2002	23-3303	—
27EFOZD	Kohler	—	—	23-7761	23-2002	23-3303	—
28EOZ		—	—	—	23-2002	23-3303	—
28EOZD	Kohler	—	—	23-7761	23-2002	23-3303	—
32EOZ		—	—	—	23-2002	23-3303	—
32EOZD	Kohler	—	—	23-7761	23-2002	23-3303	—
33EFOZ	Kohler	—	—	—	—	23-3308	—
33 CFOZ	Kohler	—	—	—	—	23-3308	23-3607
40 CFOZ	Kohler	—	—	—	—	23-3308	23-3607
40EOZ	Kohler	—	—	—	—	23-3308	—
40EFOZ	Kohler	—	—	—	—	23-3308	—
50 COZ	Kohler	—	—	—	—	23-3308	23-3607
50 CFOZ	Kohler	—	—	—	—	23-3308	23-3607
50EOZ	Kohler	—	—	—	—	23-3308	—
55EFOZ	Kohler	—	—	—	—	23-3308	—
65 COZ	Kohler	—	—	—	—	23-3308	23-3607
66EOZ	Kohler	—	—	—	—	23-3308	—
70EFOZ	Kohler	—	—	—	—	23-3308	—
80EOZ	Kohler	—	—	—	—	23-3308	—
80EFOZ	Kohler	—	—	—	—	23-3308	—
99EOZ	Kohler	—	—	—	—	23-3308	—
100EFOZ	Kohler	—	—	—	—	—	—
125EOZ	Kohler	—	—	—	—	—	—
125EFOZ	Kohler	—	—	—	—	—	—

Model	OEM	Start-er	Alternator	Fuel Filter	Impeller	Impeller Kit	Thermostat
150EOZ	Kohler	—	—	—	—	—	—
3.5 CFZ	Kohler	—	—	23-7771(Var 2)	23-2003(SN 296898 & below)	—	—
3.5 EFZ	Kohler	—	—	—	—	—	—
4 CZ	Kohler	—	—	23-7771(Var 2)	23-2003(SN 296898 & below)	—	—
4EF	Kohler	—	—	23-7782	23-2004	23-3314	23-3608
4EFGD	Kohler	—	—	—	—	—	—
4EFKD	Kohler	—	—	—	—	—	—
4 ESZ	Kohler	—	—	—	—	—	—
5 CFZ	Kohler	—	—	23-7771(Var 2)	23-2003(SN 296898 & below)	—	—
5ECD	Kohler	—	—	—	23-2004	23-3314	—
5 EFZ	Kohler	—	—	23-7762	—	—	—
5EKD	Kohler	—	—	—	—	—	—
5E	Kohler	—	—	23-7762	23-2004	23-3314	23-3608
6EF	Kohler	—	—	23-7762	23-2004	23-3314	23-3608
6EFGD	Kohler	—	—	—	23-2004	23-3314	—
6EFKD	Kohler	—	—	—	—	—	—
6.5 CZ	Kohler	—	—	23-7771(Var 2)	23-2003(SN 296898 & below)	—	—
6.5 ESZ	Kohler	—	—	23-7762	—	—	—
7.3E	Kohler	—	—	23-7762	23-2004	23-3314	23-3608
7.3ECD	Kohler	—	—	—	23-2004	23-3314	—
7.3EKD	Kohler	—	—	—	—	—	—
8E	Kohler	—	—	23-7762(GR4 Ver), 23-7771(Var 2) Inline	23-2002 (296899 & Up), 23-2003 (296898 & below)	23-3303 (SN 296899 & Up), 23-3304 (SN 296898 & below)	23-3608
8EFKD	Kohler	—	—	—	—	—	—
8EFGD	Kohler	—	—	23-7780	—	—	—
10E	Kohler	—	—	23-7762(GR4 Ver), 23-7771(Var 2) Inline	23-2002 (296899 & Up), 23-2003 (296898 & below)	23-3303 (SN 296899 & Up), 23-3304 (SN 296898 & below)	23-3608
10EG	Kohler	—	—	23-7780	—	—	—
10EGD	Kohler	—	—	23-7780	—	—	—
10EKD	Kohler	—	—	—	—	—	—
11EFGD	Kohler	—	—	—	—	—	—
12.5E	Kohler	—	—	23-7762(GR4 Ver), 23-7771(Var 2) Inline	23-2002 (296899 & Up), 23-2003 (296898 & below)	23-3303 (SN 296899 & Up), 23-3304 (SN 296898 & below)	23-3608
12.5CF	Kohler	—	—	—	23-2002 (296899 & Up), 23-2003 (296898 & below)	23-3303 (SN 296899 & Up), 23-3304 (SN 296898 & below)	23-3608
13EG	Kohler	—	—	23-7780	—	—	—
13EGZ	Kohler	—	—	23-7780	—	—	—
13EGD	Kohler	—	—	—	—	—	—
15C	Kohler	—	—	—	23-2002	23-3303	23-3608
15EG	Kohler	—	—	23-7780	—	—	—
15EGD	Kohler	—	—	23-7780	—	—	—
15EGZ	Kohler	—	—	23-7780	—	—	—
16CF	Kohler	—	—	—	23-2002	23-3303	23-3608
17.5CF	Kohler	—	—	—	—	—	—
20C	Kohler	—	—	—	23-2002	23-3303	23-3608
MDKAU	Onan	—	—	23-7760	—	—	—
MDKAV	Onan	—	—	23-7760	—	23-3300	—
MDKBG	Onan	—	—	23-7760	—	23-3300	—
MDKAW (Spacesaver)	Onan	—	—	23-7760	—	23-3300	—
MDKAZ	Onan	—	—	23-7760	—	23-3300	—
MDKBD	Onan	—	—	23-7760	—	23-3300	—
MDKBE	Onan	—	—	23-7760	—	23-3300	—
MDKBF	Onan	—	—	23-7760	—	23-3300	—
MDKBD (w/ Isolated Ground)	Onan	—	—	23-7760	—	23-3300	—
MDKBE (w/ Isolated Ground)	Onan	—	—	23-7760	—	23-3300	—
MDKBF (w/ Isolated Ground)	Onan	—	—	23-7760	—	23-3300	—

Model	OEM	Start-er	Alternator	Fuel Filter	Impeller	Impeller Kit	Thermostat
MDKBH	Onan	—	—	—	—	—	—
MDKBK	Onan	—	—	—	23-2000	23-3310	—
MDKBL	Onan	—	—	—	23-2000	23-3310	—
MDKBM	Onan	—	—	—	23-2000	23-3310	—
MDKBN	Onan	—	—	—	23-2000	23-3310	—
MDKBP	Onan	—	—	—	—	—	—
MDKBR	Onan	—	—	—	—	—	—
MDKBS	Onan	—	—	—	—	—	—
MDKBV	Onan	—	—	—	—	—	—
MDKBT	Onan	—	—	—	—	—	—
MDKBU	Onan	—	—	—	—	—	—
MDDCA	Onan	—	—	—	—	23-3309	—
MDDCB	Onan	—	—	—	—	23-3309	—
MDDCC	Onan	—	—	—	—	23-3309	—
MDDCF	Onan	—	—	—	—	23-3309	—
MDDCG	Onan	—	—	—	—	23-3309	—
MDDCD	Onan	—	—	—	—	23-3309	—
MDDCE	Onan	—	—	—	—	23-3309	—
MDDGH	Onan	—	—	—	—	23-3309	—
MDDCJ	Onan	—	—	—	—	23-3309	—
MDJA	Onan	—	—	23-7750 (Spec A-R)	—	—	23-3606
MDJB	Onan	—	—	23-7750 (Spec A-R)	—	—	23-3606
MDJC	Onan	—	—	23-7750 (Spec A-R)	—	—	23-3606
MDJE	Onan	—	—	23-7750 (Spec A)	—	—	23-3606
MDJF	Onan	—	—	23-7750 (Spec A)	—	—	23-3606
MJA	Onan	—	—	—	—	—	23-3606
MJB	Onan	—	—	—	—	—	23-3606
MJC	Onan	—	—	—	—	—	23-3606
MDKAD/E/F	Onan	—	—	23-7760	—	—	—
MDKAL/A/B	Onan	—	—	—	23-2000	23-3310	—
AGTPM 4	Fischer Panda	—	—	—	23-2001	23-3311	—
PMS 4	Fischer Panda	—	—	—	23-2001	23-3311	—
PMS 8 Mini	Fischer Panda	—	—	—	23-2001	23-3305	—
PMS 8 DP	Fischer Panda	—	—	—	23-2001	23-3305	—
PMS 4200	Fischer Panda	—	—	—	23-2001	23-3305	—
PMS 6600	Fischer Panda	—	—	—	23-2001	23-3305	—
PMS 12 DP	Fischer Panda	—	—	—	23-2001	23-3305	—
PMS 12 Mini	Fischer Panda	—	—	—	23-2001	23-3305	—
PMS 15	Fischer Panda	—	—	—	—	23-3312	—
PMS 16 DP	Fischer Panda	—	—	—	—	23-3312	—
PMS 20	Fischer Panda	—	—	—	—	23-3312	—
PMS 22	Fischer Panda	—	—	—	—	23-3312	—
PMS 25	Fischer Panda	—	—	—	—	23-3312	—
PMS 30	Fischer Panda	—	—	—	—	23-3312	—
PMS 40	Fischer Panda	—	—	—	—	23-3312	—
PMS 50	Fischer Panda	—	—	—	—	23-3312	—
M673LD3	Northern Lights	—	—	—	23-2005	23-3315	—
M673L3	Northern Lights	—	—	—	23-2005	23-3315	—
M673LD2	Northern Lights	—	—	—	23-2005	23-3315	—
M673L2	Northern Lights	—	—	—	23-2005	23-3315	—
M753	Northern Lights	—	—	—	—	—	—
M753G	Northern Lights	—	—	—	—	—	—
M753K	Northern Lights	—	—	—	—	—	—
M753W	Northern Lights	—	—	—	—	—	—
M753w2	Northern Lights	—	—	—	—	—	—
M773L	Northern Lights	—	—	—	—	—	—
M773LW2	Northern Lights	—	—	—	—	—	—
M773LW3: 9/7Kw	Northern Lights	—	—	—	—	—	—
M843	Northern Lights	—	—	—	—	—	—

Model	OEM	Start- er	Alternator	Fuel Filter	Impeller	Impeller Kit	Thermostat
M843N	Northern Lights	—	—	—	—	—	—
M843NK	Northern Lights	—	—	—	—	—	—
M843NK2	Northern Lights	—	—	—	—	—	—
M843NW	Northern Lights	—	—	—	—	—	—
M843NW2	Northern Lights	—	—	—	—	—	—
M843NW3	Northern Lights	—	—	—	—	—	—
M844	Northern Lights	—	—	—	—	—	—
M844K	Northern Lights	—	—	—	—	—	—
M844L	Northern Lights	—	—	—	—	—	—
M844LK	Northern Lights	—	—	—	—	—	—
M844LW	Northern Lights	—	—	—	—	—	—
M844LW2	Northern Lights	—	—	—	—	—	—
M844W	Northern Lights	—	—	—	—	—	—
M844W2	Northern Lights	—	—	—	—	—	—
M844W3: 16/12KW	Northern Lights	—	—	—	—	—	—
M844LW3: 20/16KW	Northern Lights	—	—	—	—	—	—
M844NK2	Northern Lights	—	—	—	—	—	—
M844LK2	Northern Lights	—	—	—	—	—	—
M844NW2	Northern Lights	—	—	—	—	—	—
M844NW3	Northern Lights	—	—	—	—	—	—
ML844	Northern Lights	—	—	—	—	—	—
ML844K	Northern Lights	—	—	—	—	—	—
ML844L	Northern Lights	—	—	—	—	—	—
ML844LK	Northern Lights	—	—	—	—	—	—
M864K	Northern Lights	—	—	—	—	—	—
M864W	Northern Lights	—	—	—	—	—	—
M864W3: 25/20Kw	Northern Lights	—	—	—	—	—	—
M16C	Northern Lights	—	—	—	—	—	—
M20CL	Northern Lights	—	—	—	—	—	—
M20CR	Northern Lights	—	—	—	—	—	—
IS 2.5	Mase	—	—	—	—	23-3311	—
IS 4.0	Mase	—	—	—	—	23-3311	—
IS 4.7	Mase	—	—	—	—	23-3311	—
IS 7.1	Mase	—	—	—	—	23-3311	—
IS 13.2	Mase	—	—	—	—	—	—
IS 8.1	Mase	—	—	23-7751	—	—	—
IS 10.2	Mase	—	—	—	—	23-3312	—
IS 14.0	Mase	—	—	—	—	23-3312	—
IS 15.6T	Mase	—	—	—	—	—	—
IS 19.0	Mase	—	—	—	—	23-3312	—
IS 23.1T	Mase	—	—	—	—	23-3312	—
IS 28.0	Mase	—	—	—	—	—	—
IS 31.0	Mase	—	—	—	—	—	—
IS 42.0	Mase	—	—	—	—	—	—



A MARINE PARTS SELECTION THAT'S **SECOND TO NONE**



Quality products backed by an industry-leading warranty.

ENGINE & DRIVE PARTS **INSTRUMENTATION** **SWITCHES**
ENGINE DIAGNOSTICS **SHIELDS HOSE** **OILS & LUBRICANTS**
TOOLS & ACCESSORIES

FUEL WATER SEPARATORS

Sierra fuel water separators remove over 99.8% of emulsified water from your gasoline. Sierra's 10 micron filters are over 90% efficient at removing particles as small as 10 micron. All filters flow @ 90 GPH to feed even the hungriest motor. Sierra 10 micron filters are recommended to prevent damage to sensitive inboard, sterndrive and outboard fuel injection systems.



11/16" - 16 thread size



Includes Bracket, Filter & 2 pipe plugs*

3/8" Pipe Plugs - 18-4264
1/4" Pipe Plugs - 18-4256

* Display Packaged

- UNIVERSAL DESIGN -

FUEL WATER SEPARATOR BRACKETS

Part No.	Thread	Material	Replaces
18-7777	1/4"	Stainless Steel	Yamaha MAR-FLTHD-SS-12
18-7776	3/8"	Stainless Steel	
18-7853-1	1/4"	Aluminum	Mercury 89876A3, 89876, 55481 Yamaha MAR-FLTHD-AL-12
18-7775	3/8"	Aluminum	

FILTERS

Part No.	Description	Micron Rating	Replaces
18-7944	Short - 3.875"	10	Mercury - 35-807172, 35-802893Q, 35-806771, 35-8053691, 35-805369, 35-604941, 35-60494, 35-57250, 35-55501, 35-52456
18-7945	Long - 4.35"	10	Mercury - 35-802893Q, 35-806771, 35-8053691, 35-805369, 35-604941, 35-60494, 35-57250, 35-55501, 35-52456 Yamaha - ABB-FUELF-IL-TR
18-7866	High Capacity - 6"	10	Yamaha - MAR-FUELF-IL-TR
18-7967	V6 EFI 1995-Earlier with sensor (black)	10	Mercury - 35-18458Q3, 35-18458A3, 35-18458A2, 35-17808A1, 35-14571A1
18-7968	V6 EFI 1996-Up with sensor (blue)	10	Mercury - 35-18458Q4, 35-184585
18-7844	Short - 3.875"	21	Mercury - 35-807172, 35-802893Q
18-7845	Long - 4.35"	21	Mercury - 35-806771, 35-8053691, 35-60494A4, 35-604941, 35-57250, 35-55501 Yamaha - ABB-FUELF-IL-TR
18-79911	Long - 8.5"	10	Mercury - 35-8M0079962

FUEL WATER SEPARATOR COVERS

Part No.	Description
18-8953	Fits: Yamaha mini-10 size filter
18-8954	Fits: Yamaha 18-7866 sized filter
18-8955	Fits: 18-7944 & 18-7945 sized filter

FUEL WATER SEPARATOR KITS

Part No.	Kit Type	Micron Rating	Contents	Replaces
18-79912	1/4" Aluminum (Tail Filter)	10	1 - 18-79911 & 1 - 18-7853-1	Mercury - 35-8M0082290
18-7983-1	1/4" Aluminum (Short Filter)	10	1 - 18-7944 & 1 - 18-7853-1	Mercury - 35-802893A4, Q4, 35-60494A4, 35-807172A4, 35-60494A1, 35-57250A1, 35-55501A1, 35-52456A1
18-7982-1	1/4" Aluminum (Tail Filter)	10	1 - 18-7945 & 1 - 18-7853-1	
18-7966-1	1/4" Aluminum (High Capacity Filter)	10	1 - 18-7866 & 1 - 18-7853-1	Yamaha - MAR-SEPAR-AT-OR
18-7986-1	3/8" Aluminum (Tail Filter)	10	1 - 18-7945 & 1 - 18-7775	
18-7984-1	1/4" Stainless Steel (Tail Filter)	10	1 - 18-7945 & 1 - 18-7777	Yamaha - MAR-SPRTR-HD-SS
18-7985-1	3/8" Stainless Steel (Tail Filter)	10	1 - 18-7945 & 1 - 18-7776	
18-7848-1	1/4" Aluminum (Short Filter)	21	1 - 18-7844 & 1 - 18-7853-1	Mercury - 35-807172A4, Q4, 35-60494A4, 35-805369A4, 35-57250A1, 35-55501A1, 35-52456A1, 35-60494A1, 52444
18-7852-1	1/4" Aluminum (Tail Filter)	21	1 - 18-7845 & 1 - 18-7853-1	Yamaha - MAR-SEPAR-AT-OR
18-7775-1	3/8" Aluminum (Tail Filter)	21	1 - 18-7845 & 1 - 18-7775	
18-7777-1	1/4" Stainless Steel (Tail Filter)	21	1 - 18-7845 & 1 - 18-7777	Yamaha - ABB-SPRTR-HD-SS
18-7776-1	3/8" Stainless Steel (Tail Filter)	21	1 - 18-7845 & 1 - 18-7776	



FUEL WATER SEPARATOR KITS - BONUS PACK CONTAINS SPARE FILTER

Part No.	Kit Type	Micron Rating	Contents
18-7983-2	1/4" Aluminum	10	2 - 18-7944 & 1 - 18-7853-1
18-7982-2	1/4" Aluminum	10	2 - 18-7945 & 1 - 18-7853-1
18-7848-2	1/4" Aluminum	21	2 - 18-7844 & 1 - 18-7853-1
18-7852-2	1/4" Aluminum	21	2 - 18-7845 & 1 - 18-7853-1

*Each kit contains 2 brass pipe plugs

SIERRA AquaVue™ & METAL COLLECTION BOWL FUEL WATER SEPARATOR KITS

Sierra AquaVue™ and metal collection bowl separator filters allow water to be drained from the filter to extend service life. Use the AquaVue™ collection bowl for outboard, above deck installations. USCG regulations require the use of the flame resistant metal collection bowl below deck.



1 1/16" - 16 thread size



*Each kit contains 2 brass pipe plugs

10 MICRON FILTER KITS WITH COLLECTION BOWLS

Part No.	Kit Type	Contents
18-7932-1	1/4" Aluminum w/ AquaVue™ collection bowl	1 - 18-7919 & 1 - 18-7853-1, 1 - 18-7922-1
18-7951	1/4" Aluminum w/ metal collection bowl	1 - 18-7919 & 1 - 18-7853-1, 1 - 18-7924
18-7937-1	1/4" Stainless Steel w/ AquaVue™ collection bowl	1 - 18-7919 & 1 - 18-7777, 1 - 18-7922-1
18-7938	1/4" Stainless Steel w/ metal collection bowl	1 - 18-7919 & 1 - 18-7777, 1 - 18-7924

REPLACEMENT BOWLS

Part No.	Description	Replaces
18-7922-1	AquaVue™ Collection Bowl	Suzuki 99105-20004-BWL
18-7924	Metal Collection Bowl	Yamaha MAR-10171-00-10

REPLACEMENT ELEMENTS & ELEMENT BOWL ASSEMBLIES

Part No.	Description	Replaces
18-7919	Spin on replacement 10 Micron, 7 1/2" tall	Mercury 35-809097, 35-8M0103095 Yamaha MAR-24563-00-00 Racor S3213
18-7928-1	Filter & AquaVue™ Collection Bowl Mercury/Yamaha Style Contains: 18-7919, 18-7922-1	Racor B32013
18-7929	Filter & Metal Collection Bowl Mercury/Yamaha Style Contains: 18-7919, 18-7924	Mercury 35-809100 Racor B32020MAM
18-0179	Bowl O-Ring Standard Metal and AquaVue™ Collection Bowl	Racor RK22244
18-7394	Bowl O-Ring Mini 10 AquaVue™ Collection Bowl	Racor RK10012
18-9884	Bowl Wrench	Racor RK22628

3/8" Pipe Plugs - 18-4264
1/4" Pipe Plugs - 18-4256

* Display Packaged

COMPACT BRACKET & SEPARATOR KIT FOR OUTBOARDS UP TO 115HP 10 MICRON FILTRATION FOR SMALL OUTBOARD MOTORS

 <p>18-7965-1 10 MICRON COMPACT SEPARATOR KIT Replaces: <i>Yamaha</i> MAR-MINIF-LT-AS Contains: 1 - 18-7774 bracket 1 - 18-7865 filter</p>	 <p>18-7774 COMPACT ALUMINUM BRACKET 1 3/16" - 18 thread size</p>	 <p>18-7865 REPLACEMENT FILTER Replaces: <i>Yamaha</i> MAR-MINIF-IL-TR</p>
 <p>18-79906 FUEL FILTER For: Racor style Mini-10. Bowl-style filter Use with drain bowls 18-7987 & 18-7988</p>	 <p>18-7987 AquaVue™ BOWL For: Racor style Mini-10</p>	 <p>18-7988 COLLECTION BOWL For: Racor style Mini-10</p>

OMC REPLACEMENT FUEL FILTERS

 <p>18-7920 10 MICRON REPLACEMENT FILTER Replaces: <i>OMC</i> 771839, <i>Racor</i> S3214, <i>Mercury</i> 35-809099 1" - 12 thread size</p>	 <p>18-7941-1 FILTER & AquaVue™ BOWL OMC style Contains: 18-7920, 18-7922-1</p>	 <p>18-7943 FILTER & METAL BOWL OMC style Contains: 18-7920, 18-7924</p>
 <p>18-7946 10 MICRON REPLACEMENT FILTER Replaces: <i>OMC</i> 502905 OMC thread</p>	 <p>18-7846 21 MICRON REPLACEMENT FILTER Replaces: <i>OMC</i> 502905 OMC thread</p>	 <p>18-7930 FUEL FILTER Replaces: <i>OMC</i> 173326 For: 1977-83 Fuel system with add-on filter kit</p>

VOLVO STYLE FUEL WATER SEPARATOR KITS

 <p>18-8149 HIGH CAPACITY FUEL WATER SEPARATING FILTER 10 MICRON Replaces: <i>Volvo</i> 3847644 For use with side-by-side fuel pump applications.</p>	<p align="center">10 MICRON REPLACEMENT FILTERS</p>	 <p>18-6999 UNIVERSAL FUEL WATER SEPARATOR KIT MOUNTING BRACKET Fits: All 305 and 350 Mercruiser engines with Center Fliser manifolds</p>								
	<table border="1"> <thead> <tr> <th>Part No.</th> <th>Description</th> <th>Replaces</th> </tr> </thead> <tbody> <tr> <td rowspan="2">18-7989</td> <td>Volvo SX/EFI</td> <td>Volvo 3851218-2, 3852413, 3862228</td> </tr> <tr> <td>Cobra EFI</td> <td>OMC 502906</td> </tr> </tbody> </table>		Part No.	Description	Replaces	18-7989	Volvo SX/EFI	Volvo 3851218-2, 3852413, 3862228	Cobra EFI	OMC 502906
	Part No.		Description	Replaces						
18-7989	Volvo SX/EFI	Volvo 3851218-2, 3852413, 3862228								
	Cobra EFI	OMC 502906								
<p align="center">21 MICRON REPLACEMENT FILTERS</p> <table border="1"> <thead> <tr> <th>Part No.</th> <th>Description</th> <th>Replaces</th> </tr> </thead> <tbody> <tr> <td rowspan="2">18-7789</td> <td>Volvo SX/EFI</td> <td>Volvo 3851218-2, 3852413</td> </tr> <tr> <td>Cobra EFI</td> <td>OMC 502906</td> </tr> </tbody> </table>	Part No.	Description	Replaces	18-7789	Volvo SX/EFI	Volvo 3851218-2, 3852413	Cobra EFI	OMC 502906		
Part No.	Description	Replaces								
18-7789	Volvo SX/EFI	Volvo 3851218-2, 3852413								
	Cobra EFI	OMC 502906								
 <p>18-7778 VOLVO ALUMINUM REPLACEMENT BRACKET Replaces: <i>Volvo</i> 3850861 1 3/16" - 18 thread size</p>										

REPLACEMENT RACOR® CARTRIDGES & SPIN-ON FILTERS

NEW

TURBINE SERIES FILTERS

PART #	DESCRIPTION	OEM PART NO.	MICRON RATING
18-99186	Fuel Cartridge - 500 Series	2010SM-OR	2
18-99182	Fuel Cartridge - 500 Series	2010TM-OR	10
18-99183	Fuel Cartridge - 500 Series	2010PM-OR	30
18-99191	Fuel Cartridge - 900 Series	2040N-02	2
18-99185	Fuel Cartridge - 900 Series	2040N-10	10
18-99184	Fuel Cartridge - 900 Series	2040N-30	30
18-99187	Fuel Cartridge - 1000 Series	2020N-02	2
18-99181	Fuel Cartridge - 1000 Series	2020N-10	10
18-99180	Fuel Cartridge - 1000 Series	2020N-30	30

- Filters offer lift tabs on top of the caps for easy installation and removal.
 - Media is SAE approved.
 - Remove 99% of particles per ISO 19438
- All Sierra filters are designed to meet or EXCEED your engine manufacturers' requirements.

Matches OE letter color code:

Red = 30 microns
 Blue = 10 microns
 Brown = 2 microns

NEW

SPIN-ON FILTERS

PART #	DESCRIPTION	OEM PART NO.	MICRON RATING
18-99193	Fuel Cartridge 120	R12T	10
18-99194	Fuel Cartridge - 121	R12S	2
18-99196	Fuel Cartridge - 230	R20S	2
18-99199	Fuel Cartridge - 120	R12P	30
18-99200	Fuel Cartridge - R20P	R20P	30



- 2, 10, 30 Micron Filter offerings
- Filters water to be drained from the bowl to extend service life of the filter
 - 10 Micron gas filters offer 90GPH to feed the hungriest of motors
 - All filters include bowl O-rings
- Prevents engine damage such as fouled injectors and increases the life of downstream filters
 - Remove 99% of particles per ISO 19438

REPLACEMENT BOWLS

NEW

PART #	DESCRIPTION	REPLACES	
18-99201	120 Aquaview Clear Bowl- Mini 2 Port	RK10215	Use With 120 Series Filters; Replacement Bowl For R121, R12s, R12p, 18-99193, 18-99194, 18-99199
18-99203	230 Series Metal Bowl	RK22368	Use with 230 Series Racor Style Filters; Replacement bowl for 18-99196, 18-99200.
18-99202	230 Series Aquaview Clear Bowl 2 Port	RK350-02	Use with 230 Series Racor Filters; Replacement bowl for 18-99196, 18-99200.

REPLACEMENT ELEMENTS & ASSEMBLIES FOR RACOR FILTER KITS



• Display Packaged

ELEMENT & BOWL KITS		
PART #	DESCRIPTION	CONTAINS
18-7969 *	Filter & Metal Bowl	18-7948, 18-7924
18-7994-1 *	Filter & AquaVue™ Bowl	18-7948, 18-7922-1
REPLACEMENT ELEMENT ONLY		
PART #	ELEMENT FOR RACOR	REPLACES
18-7947	120RRAC01 (Uses Mini Bowl below)	Honda 17670-ZW1-030GH Racor S3240 Suzuki 99105-20006
18-7948	320RRAC01 (1" - 14 thread size) (short filter)	Honda 17670-ZW1-801AH Mercury 35-886638 Racor S3227 Suzuki 99105-20005
18-7949	660RRAC02 (1" - 14 thread size) (tall filter)	Racor S3232
REPLACEMENT BOWL		
PART #	DESCRIPTION	REPLACES
18-7987	AquaVue™ Mini Bowl	Racor RK10222 Suzuki 99105-20006-BWL
18-7988	Mini Metal Bowl	-
BOWL WRENCH		
18-9884	Bowl Wrench	Racor RK22628

DIESEL FUEL FILTERS

20 MICRON



18-7931
Replaces: **Ceriat Diesel** 5574508
For: 8V-92, 8V-71

20 MICRON



18-7934
Replaces: **Ceriat Diesel** 1512904
Model M

20 MICRON



18-7935
Replaces: **Fram** CCS 1136
Fram FCS 1136 Filter Bracket

20 MICRON



18-7970
Replaces: **Ceriat Diesel** 1512903
Model 3M

18-79960 FUEL FILTER ELEMENT

Replaces: **Yanmar** 104500-55710
Fits: All GM Series, YM Series, HM Series, QM Series



20 MICRON



18-7858
Replaces: **Volvo** 858201
For: CAV Type Unit
For: AQ120B, 125A, B, 131A, 140A, 145A, B, 151, BB, 140, 145A

20 MICRON



18-7942
Replaces: **Volvo** 466987, 3825133
For: MD100A, TMD100A, MD100B, MD120A, TMD120A, TAMD120A, MD120B, TMD120B, TAMD120B, MD70B, TMD70B, TAMD70B, THAMD70B, AQAD70B, MD70C, TMD70C, TAMD70C, AQD70C, TAMD60A, TAMD60B, TAMD60C, D5/D7 MARINE GENSET, D5A-T, D5A-TA, D7A-T, D7A-TA, D7C-TA, D63 MARINE, D71/73 MARINE, KAD32P, TAMD42WJ, KAD43P/44P/300, KAMD43P/44P/300, TAMD103A, TAMD61A, TAMD62A, TAMD71A, TAMD72A, TAMD72P, TAMD72WJ, TAMD74, TAMD75 MARINE, TMD102A, TAMD102A, TAMD102D, TMD122A, TAMD122A, TAMD122P, TMD31L, TAMD31P/L/M/S, AD31P/L, TMD41L, TAMD41P/L/M/H

18-7873

Replaces: **Mercurier** 35-808275
For models: D7 3/270 Bravo & MIE Diesel Engines (1994-96)



18-8124

Replaces: **Volvo** 829913
For: 2001, 2001B, 2002, 2002B, 2003, 2003B/T/TB, AQD2B, MD11C/D, MD17C/D, MD1B, MD2B, MD3B, MD5A/B/C, MD7/B



18-8125

Replaces: **Volvo** 3583443
For: D4-180-B, D4-180-C, D4-210A-A, D4-210A-B, D4-210-A, D4-210-B, D4-225A-B, D4-225A-C, D4-225-B, D4-225-C, D4-260A-A, D4-260A-B, D4-260A-C, D4-260D-B, D4-260D-C, D4-260A-A, D4-260A-B, D4-260A-C, D4-300A-A, D4-300A-C, D4-300D-A, D4-300D-C, D4-300A-A, D4-300-C, D6-280A-A, D6-280A-B, D6-280-A, D6-280-B, D6-310A-A, D6-310A-B, D6-310D-A, D6-310D-B, D6-310-A, D6-310-B, D6-330A-B, D6-330A-C, D6-330D-B, D6-330C-C, D6-330-B, D6-330-C, D6-350A-A, D6-350A-B, D6-370A-B, D6-370A-C, D6-370D-A, D6-370D-B, D6-370D-C, D6-370-A, D6-370-B, D6-370-C, D6-435D-A, D6-435D-C, D6-435-A, D6-435-C



18-8126

Replaces: **Volvo** 861477
For: D1-13 A, D1-13 B, D1-20 A, D1-20 B, D1-30 A, D1-30 B, D2-40 A, D2-40 B, D2-55 A, D2-55 B, D2-55 C, D2-55 D, D2-55 E, D2-55F, D2-75 A, D2-75 B, D2-75 C, D2-75F, MD2010A, MD2010B, MD2020A, MD2020B, MD2030A, MD2030B, MD2040A, MD2040B



FUEL FILTERS



20 MICRON



FUEL FILTER

18-7723
Fits: 1/4" and 5/16" hose
18-7724
Fits: 3/8" and 7/16" hose



18-7828-1
FUEL FILTER
Small Capacity for 1/4" Fuel Line



FUEL FILTERS

PART #	REPLACES	APPLICATION
18-7829	Mercury 35-16494, 35-816296, T, Q, 35-816296K03	1/4" Large Cap. (For 1/4" Fuel Line)
18-7830	Mercury 35-164941, 35-816296 1, 35-816296T1, Q2, 35-8162961, 35-816396Q1, 35-816296B2 35-816296B1, 35-134301	5/16"
18-7831	Mercury 802128A1 Johnson/Evinrude 398319	3/8"



18-7856-1
FUEL FILTER
Replaces: A.C. Delco GF-61
For: 5/16" Fuel Line



18-7857-1
FUEL FILTER
Replaces: A.C. Delco GF-61P
For: 3/8" Fuel Line



18-7790
FUEL FILTER KIT
Complete Kit Contains: Housing, Replaceable Element & Fittings for 1/4", 5/16", & 3/8" Fuel Lines.



18-7791
FUEL FILTER ELEMENT
Replacement element for 18-7790 filter kit



18-9884
BOWL WRENCH
Replaces: Racor RK22628
Fits: Sierra, Racor and other aftermarket filter bowls

PRIMER BULBS



- Meets current EPA regulations in effect 1/1/2011 of 15 g/m²/24 hrs.
- Both EPA/CARB certified
- Utilizes Fluoroelastomer (FKM) material for traditional look and operation.
- 7 1/2" overall length including barbs



18-8002EP-1
PRIMER BULB ASSEMBLY
1/4" I.D.



18-8004EP-1
18-8004-10EP-1
PRIMER BULB ASSEMBLY
Replaces: Mercury 89396A38, 89396Q38
Johnson/Evinrude 174511
3/16" I.D.



18-8005EP-1
18-8005-10EP-1
PRIMER BULB ASSEMBLY
Replaces: Mercury 13330A3, 13330Q,
Johnson/Evinrude 174512
3/8" I.D.

SILVERADO 4000 COMPLETE FUEL LINE ASSEMBLIES



- Premium Rubber Fuel Line
 - Polyester braid
 - Weather resistant CPE cover
 - Flexible THV barrier layer
- Updated packaging
- Best hose on the market-resists kinking & easy to clamp.



CHRYSLER / FORCE

8' LENGTH COMPLETE FUEL LINE ASSEMBLIES

3/8"
FUEL LINE ASSEMBLY

18-8011EP-2 *SILVERADO 4000 Premium*

OE# FS409752



*



18-8071
TANK
CONNECTOR
(SOLD SEPARATELY)



18-8005EP-1
PRIMER
BULB



18-8062
FUEL
CONNECTOR



*

FUEL LINE ASSEMBLY COMPONENTS

HONDA

9' LENGTH COMPLETE FUEL LINE ASSEMBLIES

3/8"
FUEL LINE ASSEMBLY

18-81042EP-2 *SILVERADO 4000 Premium* OE# 17700-ZW9-010
17700-ZW9-020



*



18-80400
TANK
CONNECTOR
(SOLD SEPARATELY)



18-80401
FUEL
CONNECTOR

18-8005EP-1
PRIMER
BULB

18-80403
FUEL
CONNECTOR



*

FUEL LINE ASSEMBLY COMPONENTS

Honda Fuel Application: 8, 9.9, 15, 25, 30, 40, 50, 75, 90, 115, 130 HP (2001-02)

* Tanks and Engines for picture purpose only.

JOHNSON / EVINRUDE**8' LENGTH COMPLETE FUEL LINE ASSEMBLIES****3/8" High Flow
FUEL LINE ASSEMBLY****18-8009EP-2** *SILVERADO 4000 Premium***OE# 398549**

*

**18-8063**
TANK
CONNECTOR
(SOLD SEPARATELY)**18-8092**
FUEL
CONNECTOR**18-8005EP-1**
PRIMER
BULB**18-8092**
FUEL
CONNECTOR

*

FUEL LINE ASSEMBLY COMPONENTS

Fits: All V8, 1984 & later V6, 1985 & later 120 HP, 140 HP outboards, 2 HP (1 cyl.) - 75 HP (3 cyl.) (1976-02)

**3/8"
FUEL LINE ASSEMBLY****18-8014EP-2** *SILVERADO 4000 Premium***OE# 174509**

*

**18-8074**
HOSE BARB
(SOLD SEPARATELY)**18-8005EP-1**
PRIMER
BULB**18-8092**
FUEL
CONNECTOR

*

FUEL LINE ASSEMBLY COMPONENTS

Fits: All V6 & V8 (1976-02)

MERCURY / MARINER**8' LENGTH COMPLETE FUEL LINE ASSEMBLIES****3/8"
FUEL LINE ASSEMBLY****18-8010EP-2** *SILVERADO 4000 Premium*

*

**18-8068**
18-8082
TANK
CONNECTOR
(SOLD SEPARATELY)**18-8084**
FUEL
CONNECTOR**18-8005EP-1**
PRIMER
BULB**18-8083**
FUEL
CONNECTOR

*

FUEL LINE ASSEMBLY COMPONENTS**3/8"
FUEL LINE ASSEMBLY****18-8012EP-2** *SILVERADO 4000 Premium***OE# 32-858114Q08,**
32-858114K08

*

**18-8074**
HOSE BARB**18-8005EP-1**
PRIMER
BULB**18-8073**
HOSE BARB

*

FUEL LINE ASSEMBLY COMPONENTS

Has 1/2" NPT threaded fitting on engine end and 1/4" NPT threaded fitting on the tank end. Primer bulb is included in this 8ft. (2.44 m) assembly. Fits various applications using the older style twist type disconnects at the engine end and either a bayonet or thread-in fitting on the tank end.

MERCURY / MARINER (Cont.)

3/8"
FUEL LINE ASSEMBLY

18-8024EP-2 *SILVERADO 4000 Premium*

OE# 32-858104Q08,
32-858104K08



*

18-8074
HOSE BARB



18-8005EP-1
PRIMER
BULB

18-8076
FUEL
CONNECTOR



*

FUEL LINE ASSEMBLY COMPONENTS

Has standard quick connect type fitting on engine end and 1/4" NPT threaded fitting on the tank end. Primer bulb is included in this 8 ft. (2.44 m) assembly.
Fits Force 40 HP and larger (1993 & Newer), Force 9.9/15/25HP (1998), and all Mercury/Mariner outboards using clip on type disconnect at engine ends and a tank with threaded fuel pickup fitting.

3/8"
FUEL LINE ASSEMBLY

18-8025EP-2 *SILVERADO 4000 Premium*

OE# 32-858105Q08,
32-858105K08



*

18-8068
18-8082
TANK
CONNECTOR
(SOLD SEPARATELY)



18-8084
FUEL
CONNECTOR

18-8005EP-1
PRIMER
BULB

18-8076
FUEL
CONNECTOR



*

FUEL LINE ASSEMBLY COMPONENTS

Has standard quick connect type fitting on engine end and bayonet style fitting on the tank end. Primer bulb is included in this 8 ft. (2.44 m) assembly.
Fits Force 40 HP and larger (1993 & Newer), Force 9.9/15/25HP (1998), and all Mercury/Mariner outboards using clip-on type disconnect at the engine end and an older style tank with bayonet type connection.

3/8"
FUEL LINE ASSEMBLY

18-8016EP-2 *SILVERADO 4000 Premium*

OE# 32-858109Q12,
32-858109K12



*

18-80402
TANK
CONNECTOR
(SOLD SEPARATELY)



18-8091
FUEL
CONNECTOR

18-8005EP-1
PRIMER
BULB

18-8076
FUEL
CONNECTOR



*

FUEL LINE ASSEMBLY COMPONENTS

Has double sealed quick connect type fitting on tank end and clip-on type quick connect on engine end. Primer bulb is included in this 8ft. (2.44m) assembly.
Fits Force 40 HP and larger (1993 & Newer), Force 9.9/15/25HP (1998) and all Mercury Mariner outboards using clip-on type disconnects at both tank and engine ends



* Tanks and Engines for picture purpose only.

YAMAHA

8' LENGTH COMPLETE FUEL LINE ASSEMBLIES

3/8"
FUEL LINE ASSEMBLY

18-8017EP-2 *SILVERADO 4000 Premium*

OE# 6YL-24306-60-00



FUEL LINE ASSEMBLY COMPONENTS
Fits: F75-F250 and 115-300 HP

UNIVERSAL

8' LENGTH FUEL LINE ASSEMBLIES

5/16"
FUEL LINE ASSEMBLY

18-8013EP-2 *SILVERADO 4000 Premium*



18-8004EP-1
PRIMER
BULB



FUEL LINE ASSEMBLY COMPONENTS

3/8"
FUEL LINE ASSEMBLY

18-8015EP-2 *SILVERADO 4000 Premium*



18-8005EP-1
PRIMER
BULB



FUEL LINE ASSEMBLY COMPONENTS

12' LENGTH COMPLETE FUEL LINE ASSEMBLIES

5/16"
FUEL LINE ASSEMBLY

18-8032EP-2 *SILVERADO 4000 Premium*



18-8004EP-1
PRIMER
BULB



FUEL LINE ASSEMBLY COMPONENTS

* Tanks and Engines for picture purpose only.

HOSE BARBS	HOSE BARB APPLICATION					18-8045 REDUCING NIPPLE FITTING 1/8" x 1/4" NPT HEX	18-4256 PIPE PLUG 1/4" Threads
	Part #	Mercury O.E. #	OMC O.E. #	Barb	Conn. NPT		
18-8041	—	—	—	3/8"	3/8"	Male	
18-8042	—	—	—	1/2"	1/2"	Male	
18-8043	—	—	—	1/2"	1/4"	Male	
18-8054	22-63186	—	—	3/8"	1/8"	Male	
18-8055	22-63187	173311	—	3/8"	1/4"	Male	
18-8073	—	—	—	3/8"	1/4"	Male	
18-8074	—	173312	—	3/8"	1/4"	Male	
18-8093	—	—	—	1/4"	1/4"	Female	
18-8094	—	—	—	3/8"	1/4"	Female	
18-8095	—	—	—	3/8"	1/4"	Female	
18-8108	—	—	—	3/8"	3/4"	Male	
18-8109	—	—	—	3/8"	3/4"	Male	

18-4264 PIPE PLUG 3/8" Threads	18-8046 FUEL TANK ELBOW 1/8" NPT x 1/4" NPT 90°	18-8047 FUEL TANK ELBOW 1/4" NPT Threads 90°	18-8067 18-8110 18-8110-9① Bulk Pack of 12 (18-8067) FUEL ELBOW 3/8" Barb with 1/4" NPT Thread 90°
--------------------------------------	--	---	---

18-1650 SHUT OFF VALVE 3 way 1/4" FNPT Valve	18-1651 SHUT OFF VALVE 2 way 1/4" FNPT Male/Male Shut off Valve	18-1652 SHUT OFF VALVE 2 way 1/4" FNPT Male/ Female Shut off Valve	18-1653 SHUT OFF VALVE 2 way 1/4" FNPT Female/ Female Shut off Valve
--	--	---	---

18-1654 SHUT OFF VALVE 4 way 1/4" FNPT Valve	18-1655 SHUT OFF VALVE 3 way 1/4" FNPT Valve w/ Detent	18-1656 SHUT OFF VALVE 3 way 3/8" FNPT Valve w/ Detent
--	--	--

PKG. OF 10	SNAPPER CLAMPS						FUEL LINE ★ Universal ★ Vinyl ★ 35 psi working pressure *Not intended for diesel fuel	<table border="1"> <tr><th>10' Length</th><th>50' Roll</th><th>I.D.</th><th>O.D.</th></tr> <tr><td>18-8150-10</td><td>18-8150</td><td>1/8"</td><td>1/4"</td></tr> <tr><td>18-8151-10</td><td>18-8151</td><td>3/16"</td><td>5/16"</td></tr> <tr><td>18-8152-10</td><td>18-8152</td><td>1/4"</td><td>3/8"</td></tr> </table>	10' Length	50' Roll	I.D.	O.D.	18-8150-10	18-8150	1/8"	1/4"	18-8151-10	18-8151	3/16"	5/16"	18-8152-10	18-8152	1/4"	3/8"
	10' Length	50' Roll	I.D.	O.D.																				
18-8150-10	18-8150	1/8"	1/4"																					
18-8151-10	18-8151	3/16"	5/16"																					
18-8152-10	18-8152	1/4"	3/8"																					
Part #	O.E.	O.E. #	CLAMP RANGE	CLAMP SIZE																				
18-8020 ①	Mercury J/E	54-41582-7 322652	.538 - .608	8																				
18-8021 ①	J/E	911616	.597 - .665	10																				
18-8034 ①	J/E	329654	.670 - .780	12																				
18-8200 ①	J/E	322653	.360 - .406	2																				
18-8201 ①	J/E	124249	.410 - .468	4																				
18-8202 ①	J/E	322654	.475 - .536	6																				
18-8203 ①	J/E	329653	.750 - .875	14																				
18-8204 ①	J/E	324825	.875 - .975	19																				

<p>FUEL LINE HOSE SILVERADO 4000</p> <p>16-337-0566 5/16" I.D.</p> <p>16-337-0386 3/8" I.D.</p> <p>50' Reels ALCOHOL RESISTANT SAE J1527 Type B1-15 and ISO 8469</p>	<p>18-7598 PULL-START LOCK</p>	<p>18-7599 FUEL LOCK</p> <p>Protect your outboard from theft, disconnect fuel line and simply install fuel lock. Designed to fit clip on style fuel connectors. Fits: Johnson Evinrude, Mercury/Mariner, Yamaha and Honda.</p>
---	------------------------------------	--

① Priced per Package

FUEL LINE HOSE

MADE FROM AN ALCOHOL RESISTANT COMPOUND — 50' REELS

**18-8048****BLEEDER HOSE**.090 I.D. x .220 O.D.
Similar to Mercury
32-99130122, 32-892024122**18-8050**.0625 I.D. x .190 O.D.
Similar to Mercury 32-9938779**18-8051****FUEL LINE HOSE**

for OMC Pressurized Systems

Replaces: J/E 322656

(Double)

**18-8052****FUEL LINE HOSE**

3/16" I.D.

Non-Pressurized Systems

Replaces: J/E 122838

PRIMER BULBS

- Nitrile construction.
- Manufactured for countries that do not need EPA/CARB compliancy.
- Resistant to alcohol laden fuels.

**18-8002S****PRIMER BULB ASSEMBLY**

3/4" I.D.

**18-8004S****18-8004-10S****PRIMER BULB ASSEMBLY**

Replaces: Mercury 89396A38, 89396Q38

Johnson/Evinrude 174511

3/4" I.D.

**18-8005S****18-8005-10S****PRIMER BULB ASSEMBLY**

Replaces: Mercury 13330A3, 13330Q,

Johnson/Evinrude 174512

3/4" I.D.

SILVERADO 4000 COMPLETE FUEL LINE ASSEMBLIES

- Eight of the most popular numbers, utilizing the Silverado 4000 line and the non-domestic primer bulb.

- Updated packaging.



JOHNSON / EVINRUDE

8' LENGTH COMPLETE FUEL LINE ASSEMBLIES

3/8" High Flow
FUEL LINE ASSEMBLY

18-8009S-1 *SILVERADO 4000 Premium*

OE# 398549



18-8063
TANK
CONNECTOR
(SOLD SEPARATELY)



18-8092
FUEL
CONNECTOR

18-8005S
PRIMER
BULB

18-8092
FUEL
CONNECTOR



FUEL LINE ASSEMBLY COMPONENTS

Fits: All V8, 1984 & later V6, 1985 & later 120 HP, 140 HP outboards, 2 HP (1 cyl.) - 75 HP (3 cyl.) (1976-02)

8' LENGTH COMPLETE FUEL LINE ASSEMBLIES

3/8"
FUEL LINE ASSEMBLY

18-8014S-1 *SILVERADO 4000 Premium*

OE# 174509



18-8074
HOSE BARB
(SOLD SEPARATELY)



18-8005S
PRIMER
BULB

18-8092
FUEL
CONNECTOR



FUEL LINE ASSEMBLY COMPONENTS

Fits: All V6 & V8 (1976-02)

MERCURY / MARINER

8' LENGTH COMPLETE FUEL LINE ASSEMBLIES

8' LENGTH COMPLETE FUEL LINE ASSEMBLIES

3/8"
FUEL LINE ASSEMBLY

18-8016S-1 *SILVERADO 4000 Premium*

OE# 32-858109Q12,
32-858109K12



18-80402
TANK
CONNECTOR
(SOLD SEPARATELY)



18-8091
FUEL
CONNECTOR

18-8005S
PRIMER
BULB

18-8076
FUEL
CONNECTOR



FUEL LINE ASSEMBLY COMPONENTS

Has double sealed quick connect type fitting on tank end and clip-on type quick connect on engine end. Primer bulb is included in this 8ft. (2.44m) assembly. Fits Force 40 HP and larger (1993 & Newer), Force 9.9/15/25HP (1998) and all Mercury Mariner outboards using clip-on type disconnects at both tank and engine ends.

YAMAHA

8' LENGTH COMPLETE FUEL LINE ASSEMBLIES

3/8"
FUEL LINE ASSEMBLY

18-8017EP-2 *SILVERADO 4000 Premium*

OE# 6YL-24306-60-00



18-8077-1
TANK
CONNECTOR
(SOLD SEPARATELY)



18-8076
FUEL
CONNECTOR

18-8005EP-1
PRIMER
BULB

18-8076
FUEL
CONNECTOR



FUEL LINE ASSEMBLY COMPONENTS

Fits: F75-F250 and 115-300 HP

* Tanks and Engines for picture purpose only.

YAMAHA

8' LENGTH COMPLETE FUEL LINE ASSEMBLIES

3/8"
FUEL LINE ASSEMBLY

18-8017S-1 *SILVERADO 4000 Premium*

OE# 6YL-24306-60-00



18-8077-1

TANK
CONNECTOR
(SOLD SEPARATELY)



18-8076

FUEL
CONNECTOR

18-8005S

PRIMER
BULB

18-8076

FUEL
CONNECTOR



*

*

FUEL LINE ASSEMBLY COMPONENTS

Fits: F75-F250 and 115-300 HP

UNIVERSAL

8' LENGTH FUEL LINE ASSEMBLIES

5/16"
FUEL LINE ASSEMBLY

18-8013S-1 *SILVERADO 4000 Premium*



18-8004S

PRIMER
BULB



*

*

FUEL LINE ASSEMBLY COMPONENTS

8' LENGTH FUEL LINE ASSEMBLIES

3/8"
FUEL LINE ASSEMBLY

18-8015S-1 *SILVERADO 4000 Premium*



18-8005S

PRIMER
BULB



*

*

FUEL LINE ASSEMBLY COMPONENTS

12' LENGTH COMPLETE FUEL LINE ASSEMBLIES

5/16"
FUEL LINE ASSEMBLY

18-8032S-1 *SILVERADO 4000 Premium*



18-8004S

PRIMER
BULB





















*

*

FUEL LINE ASSEMBLY COMPONENTS

* Tanks and Engines for picture purpose only.

 <p>18-7254 Replaces: Chrysler 3745414 Inlet: 3/8" - 24 • Outlet: 1/2" - 20 Use replacement gasket 18-0889</p>	 <p>18-7255 Replaces: Chrysler 3745415 Inlet: 3/8" - 24 • Outlet: 1/2" - 20</p>	 <p>18-7256 Replaces: Mercuritor 32722, Cruisador 32722</p>
 <p>18-7260</p>	 <p>18-7264 Replaces: Chrysler 2279913, 1736073</p>	 <p>18-7265 Replaces: Chrysler-Craft 16.83-08758, F18308762</p>
 <p>18-7266 Replaces: Ford DJL 9350A</p>	 <p>18-7267 Replaces: Mercuritor 62092, 62092T, 54552 OMC 982063 Gasket included</p>	 <p>18-7268 Replaces: OMC 981650 Volvo 3855276 Dual Diaphragm requires slight glass</p>
 <p>18-7270 Replaces: Cruisador 21140 Gasket included</p>	 <p>18-7272 Replaces: Cruisador 97039</p>	 <p>18-7274 Replaces: Mercuritor 86246, 86246A1, 78485, 71646 86246T OMC 509409</p>
 <p>18-7275 Replaces: Mercuritor 86247, 86247T, 86247A2, 78820, 63196, 46860 OMC 509410 Gasket included</p>	 <p>18-7278 Replaces: Mercuritor 86234A4, 86234A05, 86234A3, 86234, 77594, 71327, 47585 OMC 985602, 985603, 982240, 509395 Use replacement gasket 18-0889 Use replacement pump filter 18-7860</p>	 <p>18-7281 Replaces: Volvo 826493, 3855276 OMC 981650 Gasket included</p>
 <p>18-7282 Replaces: Mercuritor 42725A3, 861676T09 OMC 509407 Use replacement gasket 18-0889 Use replacement pump filter 18-7784</p>	 <p>18-7283 Replaces: Mercuritor 97401A2, 97401A8, 861678A1, 8M0058164, 97401 OMC 509404 Use replacement gasket 18-0889</p>	 <p>18-7284 Replaces: Mercuritor 41141A2, 862077A1 OMC 509408 Use replacement gasket 18-0889 Use replacement pump filter 18-7784</p>

ALL SIERRA FUEL PUMPS INCLUDE MOUNTING GASKET



18-7286
Replaces: Volvo 841161



18-7288-1
Replaces: MerCruiser 812454A1, 862048A1, 812454A3, 97399A2, 97399



18-7289
Replaces: OMC 982997
Gasket Included



18-7258
Replaces: OMC 380986, GM 6414989



18-7326
ELECTRIC FUEL PUMP
• 8 psi, 25 gpm
Replaces: MerCruiser 805656A2, 805656A6, 805656A5, 805025A2, 861155A6, 861155A5
OMC/Volvo 3858261, 3850809, 3854620, 3857986



18-7330
ELECTRIC FUEL PUMP
• 120 psi
Replaces: OMC/Volvo 3857650, 3855958, 988037, 3854280



18-7331
ELECTRIC FUEL PUMP
• 8 psi, 45 gpm
Replaces: OMC/Volvo 3858714, 3850810, 3857985



18-7332
ELECTRIC FUEL PUMP
Includes bracket and mounting hardware
43 GPH - 7 PSI Max. - 1/4 NPSF for 3/8 hose
- operates with both gasoline and diesel fuel - 24 Volt only



18-7333
ELECTRIC FUEL PUMP
UNIVERSAL
12V, 72GPH at 5.75 PSI, 1/4" NPSF
for 3/8" hose, for use with gasoline and diesel fuel.
OPT72533 pressure safety switch recommended.

Year	Engine	Application	OE #	#'s Superseded from	Part #
MerCruiser					
1996	262/4.3L	Low Pressure Supply Pump For F.I. System	805656A2		18-7326
1996	262/4.3L	Carbureted w/electric pump - Low PSI	805656A2		18-7326
1992-93	262/4.3L	Carbureted w/electric pump - Low PSI	805656A2		18-7326
OMC					
1992-94	262/4.3L	Low Pressure	3858261	385,080,936,508,103,000,000	18-7326
1997-96	350/5.7L, 454/7.4L & 502/8.2L	Engines w/MPI - High Pressure	3857650		18-7330
1996	454/7.4L & 502/8.2L	Engines w/MPI - High Pressure	3857650		18-7330
1993-94	4.3L thru 5.8L	Low pressure electric fuel pump.	3858261	3850809	18-7326
1992-1994	454/7.4L & 502/8.2L	GM Mark V Eng. - Low Pressure	3858714	3850810, 3857985	18-7331
Volvo-Penta					
1994-99	262/4.3L (HU-WT)	High Pressure pump	3857650		18-7330
1994-99	262/4.3L GL/GS (All)	Carbureted - Low Pressure	3858261	3850809	18-7326
1994-99	262/4.3L GI (HU-WT)	W Elec. Pump - Low Pressure	3858261	3850809	18-7326
1994-99	454/7.4L & 502/8.2L (HU-WT)	Low pressure system	3858714	3850810, 3857985	18-7331
1993-99	350/5.7L, 454/7.4L & 502/8.2L	Engines w/MPI - High Pressure	3857650		18-7330
1996-99	454/7.4L & 502/8.2L (HU-WT)	Engines w/MPI - High Pressure	3857650		18-7330
1994-99	5.0L thru 5.8L	Low pressure electric fuel pump	3858261	3850809	18-7326
1994-99	454/7.4L & 502/8.2L (HU-WT)	GM Mark V Eng. - Low Pressure	3858714	3850810, 3857985	18-7331
1992-93	454/7.4L	GM Mark V Eng. - Low Pressure	3858714	3850810, 3857985	18-7331

ALL SIERRA FUEL PUMPS INCLUDE MOUNTING GASKET

Many fuel pumps are often used on similar engines. In order to identify the correct fuel pump for your application, it is necessary to determine the position of the inlet, outlet and separator fitting (where applicable) in relation to the rocker arm. The angle between the rocker arm and the fuel inlet is expressed in terms of clock position. Place pump with rocker arm in the 12 o'clock position. The rocker arm must be held behind the fuel pump body. (The bottom of the fuel pump body must face you.) Observe the relationship of the fuel inlet to the rocker arm. This position is the clock position of the pump. Examples of this in the outline drawing below show that if the fuel inlet is at position "A", it is considered a 6 o'clock pump, if at position "B", a 3 o'clock pump, and at position "C" an 8 o'clock pump.

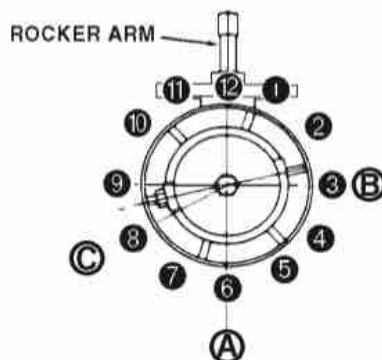

AC STYLE FUEL PUMPS

Engines Manufactured Before February 1, 1979

Engine	Application	Flange I.D. #	CLOCK POSITION			
			Inlet	Outlet	Separator	Part #
GM153, 230, 250, 292, (4&6 cyl)	Crusader, Mercruiser, OMC	6790	8	4	—	18-7256
Hercules B, D, J, JXD, Series, M Series	Chris-Craft, US Marine, Owens Yacht	7241	6	9	—	—
GM225, PB-V215 (V-6)	OMC, Palmer	40001	8	4	—	—
GM V-8, 283, 307, 327, 350, 409	Chris-Craft, Owens, Universal, Crusader	40155	9	3	10	18-7260
GM V-8 307, 350	OMC	40778	4	10	9	—
Chrysler V-8 273, 318, 340, 360	Chrysler	40781	4	8	—	18-7264

Engines Manufactured After January 31, 1979

Chrysler V-8 318, 360	Chrysler	6766	4	8	4	18-7254
Chrysler V-8 361, 400, 413, 440	Chrysler	6767	4	8	4	18-7255
GM V-8 305, 350, 400	Mercruiser, OMC, Chris-Craft	41412	9	3	9	18-7265
Ford V-8 302, 351w	Ford, Mercruiser, Commander	41413	5	4	4	18-7266
Ford V-8 302, 351w	OMC, Mercruiser, Pleasurecraft, Thermo-Electron	41414	7	5	4	18-7267
GM V-8 305, 307, 350, 400	Harman, OMC, Thermo-Electron (5.25-6.5 PSI)	41415	7	5	8	18-7268*
GM V-8 454	Mercruiser	41416	9	8	7	—
GM V-8 305, 350, 400	Thermo-Electron (5.75-7PSI)	41417	7	5	8	18-7270
GM V-8 454	Thermo-Electron	41418	3	9	8	18-7271
GM V-8 283, 305, 350, 400	Chris-Craft, Crusader, Hardin, Thermo-Electron (5.75-6.5 PSI)	41419	3	9	6	18-7272
GM V-8 305, 350, 400	Mercruiser	41421	10	9	7	18-7274
GM V-8 454	Hawk, Mercruiser	41422	9	3	7	18-7275

*18-7268 - Dual Diaphragm requires sight glass.

CARTER STYLE FUEL PUMPS

Engine	Application	Flange I.D. #	Inlet	Outlet	Sight Tube Connection	Part #
GM (4 & 6 cyl) 153, 181, 250, 225	Chris-Craft, Indmar, Marine Power, Mercruiser, OMC	60032	8	4	3	18-7278
GM V-8 305, 350	Volvo Penta	61125/6873	9	11	9	18-7281
For Inline (4 cyl) 120, 140, 3.0L, 224 CID	Mercruiser	60337	2	3	8	18-7282
GM V-6 262/4.36	OMC	60201	2	4	9	18-7289
GM V-8 305, 350	Mercruiser, Panther	60600	10	9	4	18-7283
GM V-6 231, 262	Hardin, Mercruiser	60315	8	3	8	18-7284
XP Stamped Steel Pump	Volvo Penta AQ120B (spec# 867465), AQ125A/B, AQ131A/B/C/D, AQ140A (spec# 867464), BB140A, AQ145A, BB145A, AQ151A/B/C, AQ171A/C, AQ230A/B, AQ250A/B, AQ251A	60029	3	6	11	18-7286



18-7628

INTAKE MANIFOLD

Small-block GM with vortec cylinder heads
Brass-lined water jackets for salt water applications

ALL SIERRA CARBURETORS INCLUDE BASE GASKET

- Precision remanufactured to meet or exceed OEM specifications
- Re-calibrated and re-engineered to maximize fuel efficiency and performance
- All carburetors are flow tested throughout the entire throttle range
- Fuel mixture and idle settings are pre-set to ensure that only minor idle and choke adjustments are necessary during installation
- All bases are resurfaced and throttle shaft bushings replaced

UNIVERSAL CARBURETORS



18-7635

**CARBURETOR
(REMANUFACTURED)**

300 CFM Holley 2V
Use replacement gasket **18-0360**



18-7636

**CARBURETOR
(REMANUFACTURED)**

500 CFM Holley 2V
Use replacement gasket **18-0994**



18-7637

**CARBURETOR
(REMANUFACTURED)**

600 CFM Holley 4V (Front inlet)
Gasket included • Use replacement gasket **18-0647**



18-7638

**CARBURETOR
(REMANUFACTURED)**

600 CFM Holley 4V-side inlet



18-7640

**CARBURETOR
(REMANUFACTURED)**

Universal Q-jet with electric choke
Use replacement carb kit **18-7018**
Use replacement gasket **18-0462**

MERCURUISER CARBURETORS

NEW CASTING NON-REMANUFACTURED



18-7370N

CARBURETOR

Replaces: 3310-860070A2, 3310-806077A2, 3310-806078A2, 1389-9562A1, 1389-9350A2, 1389-8490A2, 1389-815396A2, 3310-806077A2
For: MCM 120/2.5L & 140/3.0L
Gasket included • Use replacement gasket **18-0994**



18-7373N

**MERCARS 2V
CARBURETOR**

Replaces:
Mercruiser 3310-864941A01
2002-2004 4.3L engines (s/n OM615000-QW300012)
Use Replacement Carb Kit **18-7098-1**
Gasket included • Use replacement gasket **18-0994**



18-7375N

CARBURETOR

Replaces: 3310-864942A01, 3310-861448A1
For: 1998-2004 MCM 5.0L
Gasket included • Use replacement gasket **18-0994**



18-7376N

CARBURETOR

Replaces: 3310-864943A01, 3310-861245A1
For: 1998 and newer 5.7L applications
Gasket included • Use replacement gasket **18-0994**



18-7615N

Q-JET CARBURETOR

Replaces: 1347-816373A4, 1347-804624R1, 1347-804624R02
Use Replacement Carb Kit **18-7095**
Gasket included • Use replacement gasket **18-2848**

ALL SIERRA CARBURETORS INCLUDE BASE GASKET

 <p>18-7603-1 CARBURETOR (REMANUFACTURED) 2 Barrel - Rochester Replaces: <i>Mercruiser</i> 1347-818622, 1376-5659A1, 1347-818622 1, 1347-818622R02 <i>Rochester</i> 7044185 Use replacement carb kit 18-7075 Use replacement gaskets 18-0994 & 18-0434</p>	 <p>18-7604-1 CARBURETOR (REMANUFACTURED) 4 Barrel - Rochester Replaces: <i>Mercruiser</i> 3304-9354A2, 1347-804623R02 Use replacement carb kit 18-7095 Use replacement gasket 18-2848</p>	 <p>18-7605-1 CARBURETOR (REMANUFACTURED) 4 Barrel - Rochester Replaces: <i>Mercruiser</i> 1347-9661A3, 1347-804623A1, 1347-804623R02 <i>Rochester</i> 17057283, 17057285, 17059291, 17059292, 17080564, 17080565 Use replacement carb kit 18-7095 Use replacement gasket 18-2848</p>	 <p>18-7607-1 CARBURETOR (REMANUFACTURED) Replaces: <i>Rochester</i> 17082403 For: Rochester Carb: Crusader 454 Use replacement carb kit 18-7095 Use replacement gasket 18-2848</p>
 <p>18-7608-1 CARBURETOR (REMANUFACTURED) 2 Barrel - Rochester Replaces: <i>Mercruiser</i> 1347-818620, 1347-818620 1, 1347-818620R02, Rochester 7040080, 7040083, 7040089, 7042183, 7043183, 7043184, 17059057, 17059052 Use replacement carb kit 18-7070 Use replacement gasket 18-0356</p>	 <p>18-7609-1 CARBURETOR (REMANUFACTURED) 2 Barrel - Rochester Replaces: <i>Mercruiser</i> 1347-818619, 1347-818619 1, 1347-818619 1R02, Rochester 7036543, 7040082, 7041369, 7043182, 7044182, 17059054 Use replacement carb kit 18-7070 Use replacement gasket 18-0356</p>	 <p>18-7610-1 CARBURETOR (REMANUFACTURED) 2 Barrel - Rochester Replaces: <i>Mercruiser</i> 1347-818621, 1347-818621 1, 1347-818621 1R02 <i>Rochester</i> 17081060 Use replacement carb kit 18-7070 Use replacement gasket 18-0356</p>	 <p>18-7611-2 CARBURETOR (REMANUFACTURED) 2 Barrel - Rochester Replaces: <i>Mercruiser</i> 3310-807312A1, 3310-807312R02 Use replacement carb kit 18-7098-1 Use replacement gasket 18-0994</p>
 <p>18-7613-1 CARBURETOR (REMANUFACTURED) 4 Barrel - Carter (Weber) Replaces: <i>Mercruiser</i> 3310-806969A1, 3310-806969R01 Use replacement carb kit 18-7748 Use replacement gasket 18-0467</p>	 <p>18-7615-1 CARBURETOR (REMANUFACTURED) 4 Barrel - Rochester Replaces: <i>Mercruiser</i> 1347-816373A4, 1347-804624R1, 1347-804624R02 <i>Rochester</i> 17057298, 17059280, 17059288, 17080561, 17085013 Use replacement carb kit 18-7095 Use replacement gasket 18-2848</p>	 <p>18-7616-1 CARBURETOR (REMANUFACTURED) 4 Barrel - Rochester Replaces: <i>Mercruiser</i> 1347-8288A1, 1347-804626R02 <i>Rochester</i> 1708563, 17057287, 17059287, 17059290, 17080560 Use replacement carb kit 18-7072 Use replacement gasket 18-2848</p>	
 <p>18-7639 CARBURETOR (REMANUFACTURED) Replaces: 3310-864943A01, 861245A1 Mercarb-5.7L 2V 1998 and newer 5.7L (OL010337-OW300754) & 5.7L MIE (OL002003-OW090899) Use replacement carb kit 18-7098-1 Use replacement gasket 18-0994</p>	 <p>18-7617-1 CARBURETOR (REMANUFACTURED) 4 Barrel - Rochester Replaces: <i>Mercruiser</i> 1347-9863A3, 1347-804625R1, 1347-804625R02 <i>Rochester</i> 17059280 Use replacement carb kit 18-7095 Use replacement gasket 18-2848</p>	 <p>18-7618-1 CARBURETOR (REMANUFACTURED) 4 Barrel - Rochester Replaces: <i>Mercruiser</i> 13478289A1, 1347-804624R1, 1347-804624R02 <i>Rochester</i> 17059289, 7044291, 17080561, 17080562 Use replacement carb kit 18-7095 Use replacement gasket 18-2848</p>	 <p>18-7619-1 CARBURETOR (REMANUFACTURED) 4 Barrel - Rochester Replaces: <i>Mercruiser</i> 1347-9142A2, 1347-8460 A3 <i>Rochester</i> 17081299, 17083522, 17059283, 17059298 Use replacement carb kit 18-7077 Use replacement gasket 18-0462</p>

CARB APPLICATION BEGINS ON NEXT PAGE



18-8114
FUEL LINE HOSE

For fuel pump to carburetor connection. Replaces copper or steel tubing 3/8" X 31" PTFE composite hose with 5/8"-18 male inverted flare straight one end, 5/8"-18 90° one end, SAE J1527 type A1



18-8115
FUEL LINE HOSE

For fuel pump to carburetor connection. Replaces copper or steel tubing 3/8" X 25" PTFE composite hose with 5/8"-18 male inverted flare straight one end, 5/8"-18 90° one end, SAE J1527 type A1

MERCURISER CARBURETORS APPLICATION

Model	Year	# of Cyl.	Beginning Serial #	Ending Serial #	Original Carb #	Replacement Carb #	Mfg. Carb.	Carb Code & Model	Carb #
90	1970-1971	L4	2851424	3225967	1351-4253A1	1347-818619 1	7040082	R2/2GC	18-7609-1
90	1972	L4	3225868	3226957	1351-4263A2	1347-818619 1	7041369	R2/2GC	18-7609-1
110	1963-1966	L4	1357370	2044033	1336-2076	—	7036543	R2/2GC	18-7609-1
120	1972-1973	L4	3377341	3770649	1351-4263A3	1347-818619 1	7041369	R2/2GC	18-7609-1
120	1974-1975	L4	3770650	4469865	1351-5202A1	1347-818619 1	7043182	R2/2GC	18-7609-1
120	1976-1978	L4	4469866	5192048	1351-6065A2	1347-818619 1	7044182	R2/2GC	18-7609-1
120	1979-1982	L4	5192049	6229717	1351-7354A1	1347-818619 1	17059054	R2/2GC	18-7609-1
120/2.5L	1983-1989	L4	6229718	OC853255	1351-8480A2	1348-818621 1	17081060	R2/2GC	18-7610-1
140	1970	L4	2816417	2911439	1351-4032A1	1347-818620 1	7040080	R2/2GC	18-7608-1
140	1970-1973	L4	2911440	3771644	1351-4293A1	1347-818620 1	7040084	R2/2GC	18-7608-1
140	1974-1978	L4	3771645	5157668	1351-5203A1	1347-818620 1	7043184	R2/2GC	18-7608-1
140	1979-1982	L4	5157669	6229717	1351-7355A1	1347-818620 1	17059052	R2/2GC	18-7608-1
140/3.0L	1983-1989	L4	6229718	OC856556	1351-8480A2	1348-818621 1	17081060	R2/2GC	18-7610-1
165 (6 Cyl)	1970-1972	L6	2770032	3354791	1351-4282A1	1347-818620 1	7040083	R2/2GC	18-7608-1
165 (6 Cyl)	1972-1973	L6	3354702	3774864	1351-4871A1	1347-818620 1	7042183	R2/2GC	18-7608-1
165 (6 Cyl)	1974-1978	L6	3774865	5178958	1351-5204A1	1347-818620 1	7043183	R2/2GC	18-7608-1
488	—	—	6170297	1347-8460 6916778	1347-9142A2	—	17059283 17059298 17083522 17081299	R4/4ME	18-7619-1
165 (6 Cyl)	1979-1981	L6	5178959	5813433	1351-7356A1	1347-818620 1	17059050	R2/2GC	18-7608-1
180/1903.7LX	—	—	6916779	Later	1347-8460 1347-9142A2	—	17059283 17059298 17083522 17081299 17083522	R4/4ME R4/4ME	18-7619-1
205/4.3LX	1985-1991	V-6	OA331455	OD714369	3304-9354A2	3304-9354A2	N/A	R4/4MV	18-7604-1
898/200/5.0L	1987-95	V-8	OB525982	OF600999	1389-9670A2	3310-807312A1	N/A	M2/MERCARB	18-7611-2
888	1971-1977	V-8	3108723	4887829	1376-5659A1	1376-818622 1	7044185	R2/2GC	18-7603-1
228	1977-1978	V-8	4765100	5069430	1347-6427A1	1347-9661A3	17057282	R4/4MV	18-7605-1
228 TR & MIE	1977-1978	V-8	4765100	5069430	1347-6438A1	1347-9661A3	17057283	R4/4MV	18-7605-1
228	1978-1981	V-8	5069431	6021783	1347-7361A1	1347-9661A3	17059292	R4/4MV	18-7605-1
228	1982	V-8	6021784	6218461	1347-8296A4	1347-9661A3	17080565	R4/4MV	18-7605-1
223/230/5.0LX	1983-1995	V-8	6218462	OF600999	1347-9661A3	1347-9661A3	17080565	R4/4MV	18-7605-1
228 MIE	1978-1982	V-8	5069431	6040745	1347-7364A1	1347-9661A3	17059291	R4/4MV	18-7605-1
230 MIE	1982-1987	V-8	6040746	OB788151	1347-8290A1	1347-9661A3	17080564	R4/4MV	18-7605-1
255 MIE (GM)	1975-1978	V-8	4175500	4924564	1347-5732A1	1347-8289A1	7044291	R4/4MV	18-7618-1
255 MIE (GM)	1978	V-8	4924565	5195908	1347-7062A1	1347-8289A1	17059289	R4/4MV	18-7618-1
255 MIE (GM)	1979-1980	V-8	5195909	5907057	1347-7365A1	1347-8289A1	17059289	R4/4MV	18-7618-1
260 MIE	1980-1986	V-8	5907058	OB522505	1347-8289A1	1347-8289A1	17080562	R4/4MV	18-7618-1
260/5.7MIE	1987-1993	V-8	OB522506	OF024999	1347-9662A4	1347-816373A4	17080561	R4/4MV	18-7615-1
255	1975-1976	V-8	41745500	4767999	1347-5732A1	1347-8289A1	7044291	R4/4MV	18-7618-1
260	1978	V-8	4908850	5060805	1347-6492A1	1347-816373A4	17057298	R4/4MV	18-7615-1
260	1978-1982	V-8	5060806	6024393	1347-7362A1	1347-816373A4	17059288	R4/4MV	18-7615-1
260	1982-1986	V-8	6024393	OB525981	1347-8292A4	1347-816373A4	17080561	R4/4MV	18-7615-1
260/5.7L ALPHA	1987-1993	V-8	OB525982	OF000454	1347-9662A4	1347-816373A4	17080561	R4/4MV	18-7615-1
5.7L(2BBL)	1996-1997	V-8	OF601000	OK999999	3310-807312A1	3310-807312A1	—	M2/MERCARB	18-7611-1

APPLICATION CONTINUED ON NEXT PAGE

MERCUISE CARBURETORS APPLICATION

Model	Year	# of Cyl.	Beginning Serial #	Ending Serial #	Original Carb #	Replacement Carb #	Mfg. Carb.	Carb Code & Model	Carb #
5.7L (Gen II)	1998-2004	V-8	OL010037	OW300754	3310-864943101	3310-864943101	N/A	M2/MERCARB	18-7639
5.7L BRAVO (w/o High Rise Intake)	1987-1991	V-8	OB525982	OD617327	1347-9682A4	1347-816373A4	17080561	R4/4MV	18-7615-1
5.7L BRAVO (w/ High Rise Intake)	1987-1991	V-8	OB525982	OD617327	1347-8289A1	1347-8289A1	17080562	R4/4MV	18-7618-1
350 MAGNUM ALPHA	1986-1991	V-8	OA635178	OD617327	1347-8289A1	1347-8289A1	17080562	R4/4MV	18-7618-1
5.7L SKI	1985-1993	V-8	OA338533	OF025099	1347-9415T	1347-9415T	17085013	R4/4MV	18-7615-1
5.7L SKI(2BBL)	1996-1997	V-8	OF775200	OK999999	3310-807312A1	3310-807312A1	—	M2/MERCARB	18-7611-2
300MR/TRS	1985-1986	V-8	6668677	OB430367	1347-7498A7	1347-7498A7	17059280	R4/4MV	18-7615-1
330 MCM	1977-1978	V-8	4623115	5027230	1347-6493A1	1347-8291A3	17057287	R4/4MV	18-7616-1
330 MCM	1977-1981	V-8	5027231	6083144	1347-7363A1	1347-8291A3	17059290	R4/4MV	18-7616-1
330 MCM	1982-1987	V-8	6083145	OB816540	1347-8291A3	1347-8291A3	1708563	R4/4MV	18-7616-1
330 MIE	1977-1978	V-8	4623115	5226384	1347-6493A1	1347-8288A1	17057287	R4/4MV	18-7616-1
330 MIE	1979-1980	V-8	5226385	5889913	1347-7366A1	1347-8288A1	17059287	R4/4MV	18-7616-1
340/7.4L MIE	1981-1992	V-8	5889914	OD715493	1347-8288A1	1347-8288A1	17080560	R4/4MV	18-7616-1
7.4L MIE	1995-1997	V-8	OF350000	OK999999	3310-806969A1	3310-806969A1	9780	WEBER	18-7613-1
7.4L BRAVO I/II	1988-1991	V-8	OB771113	OD603117	1347-8291A3	1347-8291A3	17080563	R4/4MV	18-7616-1
7.4L BRAVO III	1995-1997	V-8	OF352000	OK999999	3310-806969A1	3310-806969A1	9780	WEBER	18-7613-1
7.4L BRAVO III	1996-1997	V-8	OF800700	OK999999	3310-806969A1	3310-806969A1	9780	WEBER	18-7613-1
370/400	1978-1987	V-8	4179554	OB714586	1347-7498A2	1347-9863A3	17059280	R4/4MV	18-7617-1
454 MAG ALPHA	1986-1988	V-8	OA631894	OB785148	1347-8291A3	1347-8291A3	17080563	R4/4MV	18-7616-1
454 MAG BRAVO	1988-1992	V-8	OB721206	OD608068	1347-7498A2	1347-9863A3	17059280	R4/4MV	18-7617-1



ALL SIERRA CARBURETORS INCLUDE BASE GASKET

**NEW CASTING
NON-REMANUFACTURED**



**18-7615N
Q-JET CARBURETOR**
Replaces: 1347-916373A4,
 1347-804624R1,
 1347-804624R02
 Use replacement carb kit **18-7095**

Heat riser choke



**18-7608-1
CARBURETOR
(REMANUFACTURED)**
 2 Barrel Rochester
Replaces: OMC 381668, 980528,
 982219, 982217
 Use replacement carb kit **18-7070**
 Use replacement gasket **18-0356**

Heat riser choke



**18-7609-1
CARBURETOR
(REMANUFACTURED)**
 2 Barrel Rochester
Replaces: OMC 382733, 980530,
 982217, 984180, 381494, 772831
 Use replacement carb kit **18-7070**
 Use replacement gasket **18-0356**



**18-7615-1
CARBURETOR
(REMANUFACTURED)**
 4 Barrel Rochester
Replaces: OMC 981705, 982223, 983855,
 981359, 981564, 985822, 981803, 981428
 Use replacement carb kit **18-7095**
 Use replacement gasket **18-2848**



**18-7605-1
CARBURETOR
(REMANUFACTURED)**
 4 Barrel Rochester
Replaces: OMC 382821, 383766, 384194
 Use replacement carb kit **18-7095**
 Use replacement gasket **18-2848**



**18-7619-1
CARBURETOR
(REMANUFACTURED)**
For: V-8, 305 & 350 CID
Models: AQ225B, C, D, E, F, 225 A.B,
 BB225 A, AV, B, C, 290 A, AQ260A, B,
 260 A, AV, B, C, 501 A/M S4A, 570 M S4A
 Use replacement carb kit **18-7095**
 Use replacement gasket **18-0462**

OMC STERN DRIVE CARBURETOR APPLICATION

HP	MODEL	YEAR	OMC CARBURETOR #	MFG CARBURETOR #	CARB. CODE & MODEL	PART #
80	80	1968-1969	382733, 772831	7028085, 17059053, 17086064, 17087311	R2, 2GC	18-7609-1
90	90	1970-1971	382733, 772831	7028085, 17059053, 17086064, 17087311	R2, 2GC	18-7609-1
120	120 (400 SERIES)	1972-1986	381668, 980528, 982219	7044186, 17059056	R2, 2GC	18-7608-1
140	140 (400 SERIES)	1973-1985	979821, 980530, 982217, 984180	17086107	R2, 2GC	18-7608-1
155	155	1967-1972	772831	7026180	R2, 2GC	18-7609-1
165	165	1972-1976	979821, 980530	17086107	R2, 2GC	18-7609-1
185	185	1989	984180	17086064	R2, 2GC	18-7609-1
200	200	1966-1968	381494	7025187	R2, 2GC	18-7609-1
210	210	1968-1972	382821, 383866	7028282, 7028280	R4, 4MV	18-7605-1
214	215	1971-1976	382821	7028280	R4, 4MV	18-7605-1
225	225	1971-1976	382821	7028280	R4, 4MV	18-7605-1
230	230	1971-1976	382821	7028280	R4, 4MV	18-7605-1
230	230 (800 SERIES)	1979-1989	981705, 982223	17057290, 17059285, 17059286, 17086117	R4, 4MV	18-7615-1
245	245	1972-1975	384194	7040284	R4, 4MV	18-7605-1
250	250	1970-1974	384194	7040284	R4, 4MV	18-7605-1
260	260 (800 SERIES)	1975-1976	384194	7040284	R4, 4MV	18-7605-1
260	260 (800 SERIES)	1979-1989	982223	17057290, 17059285, 17059286, 17086117	R4, 4MV	18-7615-1
	2.5L	1982-1986	982219, 982217	17059056, 17059053	R2, 2GC	18-7608-1
	3.0L	1982-1986	982219, 982217	17059056, 17059053	R2, 2GC	18-7608-1
	3.0L	1987-1990	984180	17086064	R2, 2GC	18-7608-1
	3.8L (4V)	1979-1985	983855	17082515, 17085010	R4, 4MV	18-7615-1
	4.3L (4V)	1979-1989	983855	17082515, 17085010	R4, 4MV	18-7615-1
	5.0L (GM / 4V)	1979-1989	982223	17057290, 17059285, 17059286, 17086117	R4, 4MV	18-7615-1
	5.7L (4V)	1979-1989	982223	17057290, 17059285, 17059286, 17086117	R4, 4MV	18-7615-1
	305 CID ①	1977-1983	981359, 982215,	17057290, 17059285, 17059286, 17086117	R4, 4MV	18-7615-1
	350 CID ②	1977-1983	981564, 982223	17057290, 17059285, 17059286, 17086117	R4, 4MV	18-7615-1
	350 (4V)	1988-1989	985822	17057290, 17059285, 17059286, 17086117	R4, 4MV	18-7615-1
	454 CID ③	1977-1978	981803, 981428	17057290, 17059285, 17059286, 17086117	R4, 4MV	18-7615-1

① In-Board

18-7039
CARB KIT
Contains adjustable needles & seats

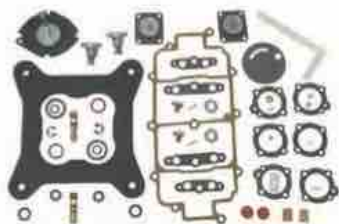

18-7095
CARB KIT



CARBURETOR TO CARBURETOR KIT INTERCHANGE

Carburetor #	Carb. Kit #	Float #	Carburetor #	Carb. Kit #	Float #	Carburetor #	Carb. Kit #	Float #
INBOARD								
CARTER/WEBER			CARTER/WEBER (CONT.)			FORD (CONT.)		
2669	18-7025	—	9665	18-7748	—	R-4608AAS	18-7096	18-7206
2853	18-7022	18-7201	9666	18-7748	—	R-6150A	18-7081	18-7206
2955	18-7022	—	9772	18-7748	—	R-6151A	18-7096	18-7206
3041	18-7022	18-7201	9773	18-7748	—	R-6151AAA	18-7096	18-7206
3116	18-7022	18-7201	9774	18-7748	—	R-6152A	18-7096	18-7206
3204	18-7022	18-7201	9776	18-7748	—	R-6152AAA	18-7096	18-7206
3212	18-7726	—	9776	18-7748	—	R-6317A	18-7081	18-7206
3213	18-7091	—	9777	18-7748	—	HOLLEY		
3214	18-7091	—	9780	18-7748	—	R-6407A	18-7096	18-7206
3285	18-7022	18-7201	9782	18-7748	—	R-6647A	18-7728	—
3314	18-7022	18-7201	9665S	18-7748	—	R-6647AAA	18-7728	—
3354	18-7022	18-7201	9772SA	18-7748	—	R-6576A	18-7096	18-7206
3392	18-7091	—	9776S	18-7748	—	R-7036A	18-7081	18-7206
3543	18-7091	—	9776SA	18-7748	—	R-7128A	18-7017	—
3660	18-7022	—	9776SB	18-7748	—	R-7159A	18-7017	—
3887	18-7022	18-7201	9779S	18-7748	—	R-7163A	18-7017	—
3951	18-7080	—	9780S	18-7748	—	R-9392A	18-7096	—
3971	18-7080	—	FORD			R-9393A	18-7729	—
3979	18-7726	—	C9FF-9510-D	18-7096	18-7206	R-9394A	18-7729	—
3980	18-7089	—	C9FF-9510-E	18-7096	18-7206	R-50399A	18-7729	—
3981	18-7726	—	D1FF-9510-LA	18-7081	18-7206	R-50399-1A	18-7729	—
4157	18-7022	18-7201	D1FF-9510-MA	18-7096	18-7206	R-50405A	18-7729	—
4207	18-7080	—	D1FF-9510-NA	18-7096	18-7206	R-50405-1A	18-7729	—
4208	18-7080	—	D1JJ-9510-B	18-7081	18-7206	R-50417A	18-7236	—
4268	18-7726	—	D2JL-9510-C	18-7096	18-7206	R-50417-1A	18-7236	—
4394	18-7080	—	D2JL-9510-E	18-7096	18-7206	R-50418A	18-7729	—
4476	18-7091	—	D3JL-9510-S	18-7081	18-7206	R-50419A	18-7729	—
4695	18-7023	—	D4JL-9510-F	18-7017	—	R-50419-1A	18-7237	—
4699	18-7089	—	D4JL-9510-G	18-7017	—	R-50419-2A	18-7237	—
6117	18-7023	—	D4JL-9510-J	18-7017	—	R-50461A	18-7236	—
6130	18-7089	—	FORD			R-50461-1A	18-7236	—
6212	18-7089	—	EBJL-9510-DA	18-7017	—	R-50462A	18-7729	—
6310	18-7022	—	E9JL-DA	18-7017	—	R-50462-1A	18-7729	—
6446	18-7092	—	F1JL-AA	18-7236	—	R-50463A	18-7237	—
9263	18-7091	—	F1JL-EA	18-7727	—	R-50463-1A	18-7237	—
9264	18-7091	—	F1JL-BA	18-7729	—	R-50464A	18-7017	—
9661	18-7749	—	F1JL-CA	18-7245	—	R-50467A	18-7236	—
9770	18-7749	—	F1JL-EA	18-7727	—	R-50467-1A	18-7236	—
9781	18-7749	—	Holley			R-50468A	18-7729	—
9770SA	18-7749	—	R-4397A	18-7096		R-50468-1A	18-7729	—
9781S	18-7749	—	R-4473A	18-7096	18-7206	R-50469A	18-7245	—
9600	18-7748	—	R-4473AAS	18-7096	18-7206	R-50469-1A	18-7245	—
9662	18-7748	—	R-4607A	18-7096	18-7206	R-50470A	18-7017	—
9663	18-7748	—	R-4608A	18-7096	18-7206	R-50483A	18-7727	—

CARBURETOR TO CARBURETOR KIT INTERCHANGE (Cont.)

Carburetor #	Carb. Kit #	Float #	Carburetor #	Carb. Kit #	Float #	Carburetor #	Carb. Kit #	Float #
HOLLEY (CONT.)			HOLLY (CONT.)			MERCURY MARINE (CONT.)		
R-80262A	18-7729	—	R-84044AA	18-7039	—	1347-8863A3	18-7095	18-7201
R-80263A	18-7236	—	R-84044-1AA	18-7039	—	1351-3635A1	18-7070	18-7200
R-80264A	18-7729	—	R-84046A	18-7727	—	1351-4032A1	18-7070	18-7200
R-80265A	18-7237	—	R-84046AA	18-7039	—	1351-4263A1	18-7070	18-7200
R-80311A	18-7241	—	Mercury Marine			1351-4263A2	18-7070	18-7200
R-80311-1A	18-7241	—	1336-2076	18-7070	18-7200	1351-4263A3	18-7070	18-7200
R-80311-2A	18-7241	—	1336-3594A1	18-7070	18-7200	1351-4282A1	18-7070	18-7200
R-80312A	18-7238	—	1337-2103	18-7078	—	1351-4293A1	18-7070	18-7200
R-80312-1A	18-7238	—	1337-2604	18-7078	—	1351-4871A1	18-7070	18-7200
R-80313A	18-7246	—	1338-2161	18-7071	—	1351-5202A1	18-7070	18-7200
R-80313-1A	18-7246	—	1338-2166	18-7071	—	1351-5203A1	18-7070	18-7200
R-80315A	18-7237	—	1338-2428	18-7071	—	1351-5204A1	18-7070	18-7200
R-80315-1A	18-7237	—	1338-2431	18-7071	—	1351-6065A2	18-7070	18-7200
R-80316A	18-7246	—	1338-2608	18-7071	—	1351-7354A1	18-7070	18-7200
R-80316-1A	18-7246	—	1338-2609	18-7071	—	1351-7355A1	18-7070	18-7200
R-80318A	18-7017	—	1338-2633	18-7070	18-7200	1351-7356A1	18-7070	18-7200
R-80318-1A	18-7017	—	1338-2891	18-7070	18-7200	1351-8480A2	18-7070	18-7200
R-80319A	18-7245	—	MERCURY MARINE			1356-4066	18-7096	18-7206
R-80319-1A	18-7245	—	1347-3237A2	18-7072	18-7201	1356-4642	18-7081	18-7206
R-80320A	18-7236	—	1347-3237A3	18-7072	18-7201	1356-5155	18-7096	18-7206
R-80320-1A	18-7236	—	1347-3237A4	18-7072	18-7201	1356-5169	18-7096	18-7206
R-80321A	18-7246	—	1347-3342	18-7072	18-7201	1376-5659A1	18-7075	18-7202
R-80321-1A	18-7246	—	1347-3353	18-7072	18-7201	1376-5659A2	18-7075	18-7202
R-80328A	18-7239	—	1347-3689A1	18-7072	18-7201	1376-5744A1	18-7075	18-7202
R-80328-1A	18-7239	—	1347-4179A1	18-7072	18-7201	1376-5990A1	18-7076	18-7202
R-80328-2A	18-7239	—	1347-4179A2	18-7072	18-7201	1376-6152A1	18-7075	18-7202
R-80330A	18-7241	—	1347-4180A1	18-7072	18-7201	1376-6491A1	—	18-7202
R-80330-1A	18-7241	—	1347-4533A1	18-7072	18-7201	1376-8295A3	—	18-7202
R-80378A	18-7242	—	1347-5326A2	18-7072	18-7201	1389-815396A2	18-7098-1	18-7202
R-80378-1A	18-7242	—	1347-5732A1	18-7072	18-7201	1389-815397A2	18-7098-1	18-7202
R-80382A	18-7244	—	1347-5981A1	18-7072	18-7201	1389-8488A2	18-7097	18-7202
R-80382-1A	18-7244	—	1347-8427A1	18-7072	18-7201	1389-8489A5	18-7097	18-7202
R-80383A	18-7245	—	1347-6438A1	18-7072	18-7201	1389-8490A2	18-7097	18-7202
R-80383-1A	18-7245	—	1347-6492A1	18-7072	18-7201	1389-9562A1	18-7098-1	18-7202
R-80385A	18-7246	—	1347-6493A1	18-7072	18-7201	1389-9563A1	18-7098-1	18-7202
R-80386A	18-7244	—	1347-7062A1	18-7072	18-7201	1389-9564A1	18-7098-1	18-7202
R-80386-1A	18-7244	—	1347-7361A1	18-7095	18-7201	1389-9670A2	18-7098-1	18-7202
R-80390A	18-7243	—	1347-7362A1	18-7095	18-7201	3300-8886A2	18-7095	18-7201
R-80364	18-7729	—	1347-7363A1	18-7095	18-7201	3304-9353A2	18-7097	18-7202
R-80434	18-7730	—	1347-7364A1	18-7095	18-7201	3304-9354A2	18-7095	18-7201
R-80444A	18-7241	—	1347-7365A1	18-7095	18-7201	3304-9565A1	18-7098-1	18-7202
R-84018AA	18-7039	—	1347-7366A1	18-7095	18-7201			
R-84022AA	18-7040	—	1347-7498A2	18-7095	18-7201	17056197	18-7075	18-7202
R-84023AA	18-7039	—	1347-7498A7	18-7095	18-7201	17056287	18-7072	18-7201
R-84024AA	18-7040	—	1347-8288A1	18-7095	18-7201	17057130	18-7086	18-7202
R-84026AA	18-7040	—	1347-8289A1	18-7095	18-7201	17057131	18-7086	18-7202
R-84026-1AA	18-7040	—	1347-8290A1	18-7095	18-7201	17057132	18-7076	18-7202
R-84026-2AA	18-7040	—	1347-8291A3	18-7095	18-7201	17057133	18-7086	18-7202
R-84028AA	18-7039	—	1347-8292A4	18-7095	18-7201	17057134	18-7086	18-7202
R-84037AA	18-7040	—	1347-8296A4	18-7095	18-7201	17057138	18-7086	18-7202
R-84038AA	18-7039	—	1347-8460A3	18-7077	18-7201	17057139	—	18-7202
R-84039AA	18-7039	—	1347-8142A2	18-7095	18-7201	17057282	18-7072	18-7201
R-84040AA	18-7040	—	1347-9415T	18-7095	18-7201	17057283	18-7072	18-7201
R-84041AA	18-7070	—	1347-9661A3	18-7095	18-7201	17057287	18-7072	18-7201
R-84042AA	18-7040	—	1347-9662A4	18-7095	18-7201	17057290	18-7095	18-7201

CARBURETOR TO CARBURETOR KIT INTERCHANGE (Cont.)

Carburetor #	Carb. Kit #	Float #	Carburetor #	Carb. Kit #	Float #	Carburetor #	Carb. Kit #	Float #
ROCHESTER			ROCHESTER (CONT.)			ROCHESTER (CONT.)		
17057295	18-7072	18-7201	17086117	18-7095	18-7201	7027083	18-7072	18-7201
17057298	18-7072	18-7201	17087311	18-7070	18-7200	7027088	18-7072	18-7201
17057299	18-7072	18-7201	17087311	18-7095	18-7201	7028085	18-7070	18-7200
17058280	18-7072	18-7201	7013071	18-7019	—	7028086	18-7070	18-7200
17059050	18-7070	18-7200	7015087	—	18-7200	7028188	18-7070	18-7200
17059051	18-7086	18-7200	7015088	—	18-7200	7028280	18-7072	18-7201
17059052	18-7070	18-7200	7015089	—	18-7200	7028282	18-7072	18-7201
17059053	18-7070	18-7200	7015090	18-7019	—	7029280	18-7072	18-7201
17059054	18-7070	18-7200	7015091	18-7019	—	7029285	18-7072	18-7201
17059055	—	18-7200	7015097	—	18-7200	7036543	18-7070	18-7200
17059056	—	18-7200	7015098	—	18-7200	7036646	18-7070	18-7200
17059057	18-7086	18-7200	7019082	18-7070	18-7200	7037082	18-7072	18-7201
17059058	18-7086	18-7200	7019084	18-7019	—	7040080	18-7070	18-7200
17059059	18-7086	18-7202	7020082	—	18-7200	7040081	18-7070	18-7200
17059060	18-7086	18-7200	7020084	18-7019	—	7040082	18-7070	18-7202
17059280	18-7095	18-7201	7020085	18-7019	—	7040083	18-7070	18-7200
17059283	18-7095	18-7201	7020087	18-7078	—	7040084	18-7070	18-7200
17059285	18-7095	18-7201	7020088	18-7070	18-7200	7040283	18-7072	18-7201
17059286	18-7095	18-7201	7020991	18-7078	—	7040284	18-7072	18-7201
17059287	18-7095	18-7201	7020992	18-7070	18-7200	7041187	—	18-7200
17059288	18-7095	18-7201	7020993	18-7070	18-7200	7041280	18-7072	18-7201
17059289	18-7095	18-7201	7020994	18-7071	—	7041285	18-7072	18-7201
17059290	18-7095	18-7201	7020995	18-7078	—	7041369	18-7070	18-7200
17059291	18-7095	18-7201	7020996	18-7071	—	7041831	18-7072	18-7201
17059292	18-7095	18-7201	7023080	—	18-7200	7042181	—	18-7200
17059293	18-7095	18-7201	7023084	18-7078	—	7042183	18-7070	18-7200
17059294	18-7095	18-7201	7023085	18-7078	—	7043182	18-7070	18-7200
17059295	18-7095	18-7201	7023088	18-7078	—	7043183	18-7070	18-7200
17059296	18-7095	18-7201	7023089	18-7078	—	7043184	18-7070	18-7200
17059298	18-7095	18-7201	7023181	18-7078	—	7043259	—	18-7201
17065977	18-7072	18-7201	7023183	18-7078	—	7043282	—	18-7201
17080050	18-7086	18-7200	7023186	—	18-7200	7044182	18-7070	18-7200
17080350	—	18-7202	7023188	—	18-7200	7044185	18-7075	18-7202
17080560	18-7095	18-7201	7024083	18-7071	—	7044186	—	18-7200
17080561	18-7095	18-7201	7024084	18-7078	—	7044187	18-7075	18-7202
17080562	18-7095	18-7201	7024086	18-7078	—	7044283	18-7072	18-7201
17080563	18-7095	18-7201	7024087	18-7071	—	7044284	18-7072	18-7201
17080564	18-7095	18-7201	7024089	18-7071	—	7044286	18-7072	18-7201
17080565	18-7095	18-7201	7024180	18-7071	—	7044287	18-7072	18-7201
17081060	18-7070	18-7200	7024181	18-7071	—	7044288	18-7072	18-7201
17081299	18-7077	18-7201	7024182	18-7078	—	7044289	18-7072	18-7201
17082403	18-7095	18-7201	7024188	—	18-7200	7044290	18-7072	18-7201
17083110	18-7086	18-7200	7025082	18-7070	18-7200	7044291	18-7072	18-7201
17083515	18-7095	18-7201	7025180	18-7078	—	7045197	18-7076	18-7202
17083522	18-7095	18-7201	7025183	18-7071	—	7045282	—	18-7201
17084001	18-7095	18-7201	7025184	18-7071	—	7045283	18-7072	18-7201
17084516	18-7095	18-7201	7025188	18-7070	18-7200	Solex		
17085008	18-7086	18-7200	7025564	18-7078	—	44PA1	18-7000	—
17085010	18-7072	18-7201	7025638	18-7071	—	44PHN-3	18-7001	—
17085013	18-7095	18-7201	7025662	18-7071	—	Volvo-Penta		
17086064	18-7070	18-7200	7025756	18-7078	—	826359-2	18-7095	18-7201
17086069	18-7095	18-7201	7026084	18-7070	—	826414-5	18-7086	18-7202
17086107	18-7086	18-7200	7026088	18-7070	18-7200	826415-2	18-7095	18-7201
17086115	18-7095	18-7201	7027080	18-7072	18-7201	826442-6	18-7095	18-7201
17086116	18-7095	18-7201	7027081	18-7072	18-7201	835556-2	18-7095	18-7201

CARBURETOR TO CARBURETOR KIT INTERCHANGE (Cont.)

Carburetor #	Carb. Kit #	Float #	Carburetor #	Carb. Kit #	Needle & Seat #	Carburetor #	Carb. Kit #	Needle & Seat #
ROCHESTER (CONT.)			TILLOTSON (CONT.)			TILLOTSON (CONT.)		
841667-9	18-7086	18-7202	CO-5A	18-7037	18-7057	KA-8AT	18-7013	18-7057
856138-3	18-7072	18-7201	CO-6A	18-7037	18-7057	KA-9A	18-7013	18-7057
856238-5	18-7040	—	CO-6B	18-7037	18-7057	KA-9AT	18-7013	18-7057
841047-4	18-7095	18-7201	CO-6C	18-7037	18-7057	KB-10A	18-7013	18-7057
SOLEX			CO-7A	18-7037	18-7057	KB-11A	18-7013	18-7057
841313-0	18-7095	18-7202	CO-7B	18-7037	18-7057	KB-12A	18-7013	18-7057
M675398-0	18-7085	—	CO-7C	18-7037	18-7057	KB-14A	18-7013	18-7057
VOLVO-PENTA			CO-8A	18-7037	18-7057	KB-3A	18-7013	18-7057
34VN	18-7008	—	CO-9A	18-7037	18-7057	KB-3AT	18-7013	18-7057
8963, A-J	18-7732	—	KA-10A	18-7013	18-7057	KB-4A	18-7013	18-7057
8983, A-H	18-7732	—	KA-10AT	18-7013	18-7057	KB-5A	18-7013	18-7057
12091, A	18-7732	—	KA-11A	18-7013	18-7057	KB-6A	18-7013	18-7057
12206	18-7732	—	KA-11AT	18-7013	18-7057	KB-6B	18-7013	18-7057
Zenith-Stromberg			KA-12A	18-7013	18-7057	KB-7A	18-7013	18-7057
C1865F	18-7085	—	KA-12AT	18-7013	18-7057	KB-7B	18-7013	18-7057
C1865R	18-7085	—	KA-13A	18-7013	18-7057	KB-8A	18-7013	18-7057
C3040F	18-7085	—	KA-13AT	18-7013	18-7057	KB-9A	18-7013	18-7057
C3040R	18-7085	—	KA-14A	18-7013	18-7057	KC-10A	18-7013	18-7057
C3098F	18-7085	—	KA-14AT	18-7013	18-7057	KC-10AT	18-7013	18-7057
C3098R	18-7085	—	KA-15A	18-7013	18-7057	KC-11A	18-7013	18-7057
ZENITH			KA-16A	18-7013	18-7057	KC-11AT	18-7013	18-7057
C3200R	18-7085	—	KA-16AT	18-7013	18-7057	KC-13A	18-7013	18-7057
C3201F	18-7085	—	KA-17A	18-7013	18-7057	KC-14A	18-7013	18-7057
C3201M	18-7085	—	KA-17AT	18-7013	18-7057	KC-14AT	18-7013	18-7057
C3201R	18-7085	—	KA-18A	18-7013	18-7057	KC-15A	18-7013	18-7057
C3231F	18-7085	—	KA-18AT	18-7013	18-7057	KC-15AT	18-7013	18-7057
ZENITH-STROMBERG			KA-19A	18-7013	18-7057	KC-1A	18-7013	18-7057
C3232F	18-7085	—	KA-19AT	18-7013	18-7057	KC-1AT	18-7013	18-7057
C3232M	18-7085	—	KA-20A	18-7013	18-7057	KC-2A	18-7013	18-7057
C3232R	18-7085	—	KA-21A	18-7013	18-7057	KC-2AT	18-7013	18-7057
OUTBOARD			KA-21AT	18-7013	18-7057	KC-3A	18-7013	18-7057
Tillotson			KA-21B	18-7013	18-7057	KC-3AT	18-7013	18-7057
			KA-21BT	18-7013	18-7057	KC-4A	18-7013	18-7057
AJ-50A	18-7013	18-7057	KA-21C	18-7013	18-7057	KC-5A	18-7013	18-7057
AJ-52A	18-7013	18-7057	KA-21CT	18-7013	18-7057	KC-5AT	18-7013	18-7057
AJ-53A	18-7013	18-7057	KA-21D	18-7013	18-7057	KC-5B	18-7013	18-7057
AJ-53AT	18-7013	18-7057	KA-21DT	18-7013	18-7057	KC-5BT	18-7013	18-7057
AJ-54A	18-7013	18-7057	KA-22A	18-7013	18-7057	KC-5BTA	18-7013	18-7057
AJ-54AT	18-7013	18-7057	KA-22B	18-7013	18-7057	KC-5C	18-7013	18-7057
AJ-55AO	18-7013	18-7057	KA-22C	18-7013	18-7057	KC-5CT	18-7013	18-7057
AJ-55AT	18-7013	18-7057	KA-23A	18-7013	18-7057	KC-5CTA	18-7013	18-7057
AJ-56A	18-7013	18-7057	KA-24A	18-7013	18-7057	KC-6A	18-7013	18-7057
AJ-56AB	18-7013	18-7057	KA-24AT	18-7013	18-7057	KC-6AT	18-7013	18-7057
OUTBOARD TILLOTSON			KA-25A	18-7013	18-7057	KC-7A	18-7013	18-7057
			KA-26A	18-7013	18-7057	KC-7AT	18-7013	18-7057
CO-10B	18-7037	18-7057	KA-26B	18-7013	18-7057	KC-7B	18-7013	18-7057
CO-11A	18-7037	18-7057	KA-27A	18-7013	18-7057	KC-7BT	18-7013	18-7057
CO-1A	18-7037	18-7057	KA-2A	18-7013	18-7057	KC-8A	18-7013	18-7057
CO-2A	18-7037	18-7057	KA-2AT	18-7013	18-7057	KC-9A	18-7013	18-7057
CO-3A	18-7037	18-7057	KA-5A	18-7013	18-7057	KC-9B	18-7013	18-7057
CO-4A	18-7037	18-7057	KA-5A	18-7013	18-7057	KC-9C	18-7013	18-7057
CO-4B	18-7037	18-7057	KA-7A	18-7013	18-7057	KD-1A	18-7013	18-7057
CO-4C	18-7037	18-7057	KA-7B	18-7013	18-7057	KD-1B	18-7013	18-7057
CO-4D	18-7037	18-7057	KA-8A	18-7013	18-7057	KD-1BR	18-7013	18-7057

CARBURETOR TO CARBURETOR KIT INTERCHANGE (Cont.)

Carburetor #	Carb. Kit #	Needle & Seat #	Carburetor #	Carb. Kit #	Needle & Seat #	Carburetor #	Carb. Kit #	Needle & Seat #
TILLOTSON (CONT.)			TILLOTSON (CONT.)			WALBRO (CONT.)		
KD-2A	18-7013	18-7057	WB-26A	18-7037	18-7057	WMK-25	18-7021	18-7061
KD-4A	18-7013	18-7057	WB-26B	18-7037	18-7057	WMK-26	18-7021	18-7061
KD-5A	18-7013	18-7057	WB-27A	18-7037	18-7057	WMK-27	18-7021	18-7061
KD-6A	18-7013	18-7057	WB-27B	18-7037	18-7057	WMK-28	18-7021	18-7061
KD-6AT	18-7013	18-7057	WB-28A	18-7037	18-7057	WMK-29	18-7021	18-7061
KD-6B	18-7013	18-7057	WB-2A	18-7037	18-7057	WMK-30	18-7021	18-7061
KD-6BT	18-7013	18-7057	WB-2B	18-7037	18-7057	WMK-31	18-7021	18-7061
KD-7A	18-7013	18-7057	WB-2C	18-7037	18-7057	WMK-32	18-7021	18-7061
KD-7B	18-7013	18-7057	WB-30A	18-7037	18-7057	WMK-35	18-7021	18-7061
RD-10A	18-7037	18-7057	WB-31A	18-7037	18-7057	WMK-36	18-7021	18-7061
TC-1A	18-7037	18-7057	WB-3A	18-7037	18-7057	WMK-38	18-7021	18-7061
TC-1B	18-7037	18-7057	WB-3B	18-7037	18-7057	WMK-39	18-7021	18-7061
WB-10A	18-7037	18-7057	WB-3C	18-7037	18-7057	WMK-40	18-7021	18-7061
WB-10B	18-7037	18-7057	WB-4A	18-7037	18-7057	WMK-41	18-7021	18-7061
WB-10C	18-7037	18-7057	WB-4B	18-7037	18-7057	WMK-41-1A	18-7021	18-7061
WB-10D	18-7037	18-7057	WB-4C	18-7037	18-7057	WMK-41-1B	18-7021	18-7061
WB-10E	18-7037	18-7057	WB-5A	18-7037	18-7057	WMK-41-3A	18-7021	18-7061
WB-11A	18-7037	18-7057	WB-5B	18-7037	18-7057	WMK-41-3B	18-7021	18-7061
WB-11B	18-7037	18-7057	WB-6A	18-7037	18-7057	WO-8A-1	—	18-7061
WB-12A	18-7037	18-7057	WB-7A	18-7037	18-7057	WO-8A-2	—	18-7061
WB-12B	18-7037	18-7057	WB-7B	18-7037	18-7057	WO-8A-3	—	18-7061
WB-13A	18-7037	18-7057	WB-8A	18-7037	18-7057	WO-8A-4	—	18-7061
WB-13B	18-7037	18-7057	WB-8B	18-7037	18-7057	WO-8A-5	—	18-7061
WB-13C	18-7037	18-7057	WB-8C	18-7037	18-7057	WO-8A-6	—	18-7061
WB-13D	18-7037	18-7057	WB-8D	18-7037	18-7057	WO-9-1	—	18-7061
WB-14A	18-7037	18-7057	WB-9A	18-7037	18-7057	WO-9-2	—	18-7061
WB-14B	18-7037	18-7057	WB-9B	18-7037	18-7057	WO-9-3	—	18-7061
WB-15A	18-7037	18-7057	WB-9C	18-7037	18-7057	WO-9-4	—	18-7061
WB-15B	18-7037	18-7057	WB-9D	18-7037	18-7057	WO-9-5	—	18-7061
WB-15C	18-7037	18-7057	WM-16	18-7021	18-7061	WO-9-6	—	18-7061
WB-15D	18-7037	18-7057	WM-17	18-7021	18-7061	WO-9A-1	—	18-7061
WB-16A	18-7037	18-7057	Walbro			WO-9A-2	—	18-7061
WB-16B	18-7037	18-7057	WM-23	18-7021	18-7061	WO-9A-3	—	18-7061
WB-16C	18-7037	18-7057	WMD-1	18-7021	18-7061	WO-9A-4	—	18-7061
WB-16D	18-7037	18-7057	WMK-1	18-7021	18-7061	WO-9A-5	—	18-7061
WB-17A	18-7037	18-7057	WMK-2	18-7021	18-7061	WO-9A-6	—	18-7061
WB-17B	18-7037	18-7057	WMK-3	18-7021	18-7061			
WB-17C	18-7037	18-7057	WMK-4	18-7021	18-7061			
WB-19A	18-7037	18-7057	WMK-5	18-7021	18-7061			
WB-19B	18-7037	18-7057	WMK-7	18-7021	18-7061			
WB-19C	18-7037	18-7057	WMK-8	18-7021	18-7061			
WB-19D	18-7037	18-7057	WMK-9	18-7021	18-7061			
WB-1A	18-7037	18-7057	WMK-10	18-7021	18-7061			
WB-1B	18-7037	18-7057	WMK-11	18-7021	18-7061			
WB-1C	18-7037	18-7057	WALBRO					
WB-20A	18-7037	18-7057	WMK-13	18-7021	18-7061			
WB-20B	18-7037	18-7057	WMK-14	18-7021	18-7061			
WB-21A	18-7037	18-7057	WMK-15	18-7021	18-7061			
WB-21B	18-7037	18-7057	WMK-18	18-7021	18-7061			
WB-21C	18-7037	18-7057	WMK-19	18-7021	18-7061			
WB-22A	18-7037	18-7057	WMK-20	18-7021	18-7061			
WB-23A	18-7037	18-7057	WMK-21	18-7021	18-7061			
WB-24A	18-7037	18-7057	WMK-22	18-7021	18-7061			
WB-25A	18-7037	18-7057	WMK-24	18-7021	18-7061			



FLAMETHROWER ELECTRONIC DISTRIBUTORS

Magnetic triggered billet distributors designed to meet or exceed SAE J1171 Standards.

Performance Features:

- Cobalt magnets and Hall Effect trigger for stable timing and precise spark distribution.
- Compensates for inherent electronic delay
- Synchronized peak current and spark timing reduces heat build-up.
- Compatible with most capacitive discharge ignition boxes
- Integrated patented Ignitor II technology with adaptive dwell control
- Non-vented distributor cap equipped with stainless steel fasteners
- Triple screen spark arrestor for added protection



Part No.	Description
18-5481	Ford 351W (Conventional Rotation)
18-5482	Ford 351C, 351M, 400, 429, 460 (Conventional Rotation)
18-5483	Small and BB Chevrolet (Standard Deck height) (Conventional Rotation)
18-5477	Ford 302 (Conventional Rotation)
18-5478	Chrysler LA series (Conventional Rotation)
18-5479	Small and BB Chevrolet (Standard Deck height) Reverse Rotation

THUNDERBOLT HEI DISTRIBUTORS



Designed as a direct replacement for Mercury Thunderbolt IV Ignition Distributors. Meets or Exceeds SAE J1171 Standards.

Performance Features:

- Battery Powered (HEI) High Energy Ignition.
- Uses a Hall-Effect type sensor to trigger ignition accurately even at extremely low RPM.

Part No.	Description
18-5470	GM V8
18-5471	GM V6



DELCO HVS DISTRIBUTORS

Aluminum housing construction replaces weaker Factory plastic housing. Designed as a direct replacement for late model GM HVS Distributor. Meets or Exceeds SAE J1171 Standards.

Performance Features:

- Includes steel gear, which is compatible with flat tappet or hydraulic roller cams.
- Reliable high signal strength trigger system.
- Ball bearing and bushing combination provide maximum timing stability and long life.

Part No.	Description
18-5350	GM Vortec V6
18-5351	GM Vortec V8



DELCO EST DISTRIBUTORS



Aluminum housing construction. Designed as a direct replacement for late model GM EST Distributor. Meets or Exceeds SAE J1171 Standards.

Performance Features:

- Includes steel gear, which is compatible with flat tappet or hydraulic roller cams.
- Reliable high signal strength trigger system.
- Ball bearing and bushing combination provide maximum timing stability and long life.

Part No.	Description
18-5475	GM 4 Cyl
18-5476	GM V6
18-5484-1	GM V8



CONVERSION KITS FOR DELCO EST DISTRIBUTORS



18-5512 V-4 DELCO EST CONVERSION KIT

Description: Converts 4 Cylinder GM Engines to Electronic.
Includes: Distributor, Coil, Ignition Wires, and Harnesses



18-5513 V-6 DELCO EST CONVERSION KIT

Description: Converts 6 Cylinder GM Engines to Electronic.
Includes: Distributor, Coil, Ignition Wires, and Harnesses



18-5514 V-8 DELCO EST CONVERSION KIT

Description: Converts 8 Cylinder GM Engines to Electronic.
Includes: Distributor, Coil, Ignition Wires, and Harnesses

YLM STYLE MAGNETIC BREAKERLESS ELECTRONIC DISTRIBUTOR

Designed for 12 Volt Negative ground systems, the Sierra YLM Series Marine distributors replace original equipment marine distributors with modern, high performance technology. This complete, self-contained ignition system combines the triggering device and amplifier into a single unit that sits inside the distributor housing. A self-contained module/pickup assembly has no moving parts to wear out. Sierra's time tested reliability you need in extreme marine conditions. A simple wiring hook up allows this system to fit a wide variety of marine applications. This ignition system drives both original equipment and high performance coils.

Performance Features:

- Improved performance and combustion efficiency.
- Improved spark plug life.
- Accurate spark timing.
- Reduced maintenance.
- Easy installation.



Part No.	Description	Replaces
18-5496-2	Ford 351C, 460 CID (Conventional Rotation)	YLM567CV
18-5497-2	Chrysler V8 273, 318 (87 & LIP) 340, 360 CID "LA" Engines (Conventional Rotation)	YLM579AV
18-26310-2	GM 4.3L262 CID Engines (EVEN Fire) (Conventional Rotation)	YLM700AV
18-26311-2	GM 327Q, 350Q Engines (Conventional Rotation)	YLM568AV
18-5486-2	GM L4, 153 & 181 CID (Conventional Rotation)	YLM673AV
18-5487-2	GM L6, 194, 230, 250, 292 CID (Conventional Rotation)	YLM676AV
18-5489-2	Ford 351W (Conventional Rotation)	YLM554CV
18-5494-2	GM V8 482, 502, 540 CID (Except 348, 409, & Tall Deck Big Block) (Conventional Rotation)	YLM624AV
18-5495-2	Ford 302 (Conventional Rotation)	YLM512CV
18-5498-2	GM V8, 482, 502, 540 CID (Except 348, 409 & Tall Deck Big Block) (Reverse Rotation)	YLM624BV

CONVERSION KITS FOR DELCO EST DISTRIBUTORS



18-5518
V-4 SIERRA ELECTRONIC DISTRIBUTOR CONVERSION KIT
 Description: Converts 4 Cylinder GM Engines to Electronic
 Includes: Distributor, Coil, Ignition Wires, and Harnesses



18-5519
V-6 SIERRA ELECTRONIC DISTRIBUTOR CONVERSION KIT
 Description: Converts 6 Cylinder GM Engines to Electronic
 Includes: Distributor, Coil, Ignition Wires, and Harnesses



18-5520
V-8 SIERRA ELECTRONIC DISTRIBUTOR CONVERSION KIT
 Description: Converts 8 Cylinder GM Engines to Electronic
 Includes: Distributor, Coil, Ignition Wires, and Harnesses

YL STYLE POINT-TYPE DISTRIBUTORS

Using new materials and technology, the Sierra YL Series Distributor delivers more performance and reliability for today's marine performance engines. This proven ignition system drives both original equipment and high performance coils.

Performance Features:

- Stabilized points eliminate point float and bounce.
- High dielectric condenser with brass case eliminates corrosion.
- Mylar insulation provides greater protection against current leaks and shorting.
- Super Duty cap and rotor.
- Self-Lubricating bushings.



Part No.	Description	Replaces
18-5309-1	Ford 302 (Conventional Rotation)	YL512CV
18-5312-1	Ford 351 (Conventional Rotation)	YL554CV
18-5313-1	Most GM V8 (Conventional Rotation)	YL624AV
18-5315-1	Most GM 4 Cylinder Engines (120 & 140HP) (Conventional Rotation)	YL673AV
18-5316-1	Most GM V8 (Reverse Rotation)	YL624BV
18-5339-1	GM V8 327	YL566AV
18-26104-1	Ford V8 351C (Conventional Rotation)	YL567EV
18-26107-1	4.3L/262 CID Engines (EVEN Fire) (Conventional Rotation)	YL700AV
18-26110-1	Chrysler V8, 273, 318 (1967 & Up), 340 and 360 "LA" Engines	YL579AV
18-26111-1	3.7L Mercuriser (Conventional Rotation)	YL548AV
18-26112-1	GM L6, 194, 230, 250, 292 CID (Conventional Rotation)	YLM676AV

DISTRIBUTOR PARTS



18-5515
DELCO EST DISTRIBUTOR COIL TO MODULE HARNESS

Fits: Engines equipped with a Delco EST Distributor



18-5516
DELCO EST DISTRIBUTOR TIMING TOOL

For: Engines equipped with Delco EST and cannot be placed in base timing mode with a diagnostic tool.



18-5517
DELCO EST SHIFT INTERRUPT HARNESS

For: Engines equipped with a Delco EST Distributor and requires a shift interrupt lead.



18-26800
MARINE CAP CLIP KIT

Replaces: Mallory 670
Fits: Mallory Tall Cap



18-26810
PIGTAIL, GM HEI 4 TERMINAL

Fits: Delco EST Distributors



18-26811
PIGTAIL, GM HEI 2 TERMINAL

Fits: Delco EST Distributors



18-26812
CONNECTOR, HEI COIL GRAY

Fits: Delco EST Ignition Coil



18-26813
CONNECTOR, HEI COIL BLACK

Fits: Delco EST Ignition Coil



18-26815
DISTRIBUTOR HARNESS

Replaces: Mallory 29349
Fits: YLM & YLU Distributors

DISTRIBUTOR PARTS (cont.)



18-61051
SCREW KIT (4 PER PKG)
 Fits: Mercruiser V6 & V8 Thunderbolt
 Distributor Caps



18-26820
DISTRIBUTOR GEAR
 Fits: Standard rotation GM SB & BB engines



18-26821
**DISTRIBUTOR
 CHEV REV GEAR**
 Fits: Mallory Distributors in Chevrolet BB & SB reverse
 rotation engines



18-28150
WIRE SEPARATOR / BLUE



18-28151
WIRE SEPARATOR / BLACK



18-28175
WIRE MARKERS

ELECTRONIC CONVERSION KIT APPLICATION

CHEVROLET MARINE

Model	Cylinders	Years	Footnotes	Distributor Make	Distributor #	Ignitor Kit	Ignitor II Kit
All Models	V8	1980-1988	ⓐ	Prestolite	IBM-7021	18-5293-1	18-5287-1
All Models	V8	1976-1988	ⓐ, ⓑ	Prestolite	IBM-7011	18-5298	18-5288
All Models	V8	1976-1988	ⓐ, ⓑ	Prestolite	IBM-7013	18-5299	18-5289

CHRIS-CRAFT

Model	Cylinders	Years	Footnotes	Distributor Make	Distributor #	Ignitor Kit	Ignitor II Kit
All Models	V8	1963-1971	ⓐ, ⓑ	Prestolite	IBM-4115	18-5298	18-5288
All Models	V8	1963-1971	ⓐ, ⓑ	Prestolite	IBM-4116	18-5298	18-5288
All Models	V8	1981-1985	ⓐ, ⓑ	Prestolite	-	18-5299	18-5289
FL153	I4	1975-1980	ⓐ, ⓑ	Delco	-	18-5297	18-5285
FL181	I4	1975-1980	ⓐ, ⓑ	Delco	-	18-5297	18-5285

CHRYSLER INBOARD

Model	Cylinders	Years	Footnotes	Distributor Make	Distributor #	Ignitor Kit	Ignitor II Kit
273	V8	1983-1988	ⓐ, ⓑ	Prestolite	IBM-7016	18-5299	18-5289
273	V8	1983-1988	ⓐ, ⓑ	Prestolite	IBM-7017	18-5299	18-5289
318	V8	1983-1988	ⓐ, ⓑ	Prestolite	IBM-7016	18-5299	18-5289
318	V8	1983-1988	ⓐ, ⓑ	Prestolite	IBM-7017	18-5299	18-5289
340	V8	1983-1988	ⓐ, ⓑ	Prestolite	IBM-7016	18-5299	18-5289
340	V8	1983-1988	ⓐ, ⓑ	Prestolite	IBM-7017	18-5299	18-5289
440	V8	1983-1988	ⓐ, ⓑ	Prestolite	IBM-7016	18-5299	18-5289
440	V8	1983-1988	ⓐ, ⓑ	Prestolite	IBM-7017	18-5299	18-5289
M318A	V8	1959-1972	ⓐ, ⓑ	Prestolite	IBM-4106	18-5298	18-5288
M318B	V8	1959-1972	ⓐ, ⓑ	Prestolite	IBM-4106	18-5298	18-5288
M318C	V8	1959-1972	ⓐ, ⓑ	Prestolite	IBM-4106	18-5298	18-5288
M318X	V8	1965-1966	ⓐ, ⓑ	Prestolite	IBM-4120	18-5298	18-5288
M413	V8	1959-1972	ⓐ, ⓑ	Prestolite	IBM-4106	18-5298	18-5288
M413D	V8	1959-1972	ⓐ, ⓑ	Prestolite	IBM-4106	18-5298	18-5288
M426X	V8	1959-1972	ⓐ, ⓑ	Prestolite	IBM-4106	18-5298	18-5288
M80	V8	1959-1972	ⓐ, ⓑ	Prestolite	IBM-4106	18-5298	18-5288
M81	V8	1959-1972	ⓐ, ⓑ	Prestolite	IBM-4106	18-5298	18-5288

- ⓐ Clockwise Rotation
- ⓑ Factory Electronic Ignition
- ⓐ Excluding distributor number YL670AV

- ⓐ Use with Screw Down Distributor Cap
- ⓑ Use with Clip Down Distributor Cap
- ⓐ Ignitor II cannot be used with solid core Ignition Wires

CRUSADER							
Model	Cylinders	Years	Footnotes	Distributor Make	Distributor #	Ignitor Kit	Ignitor II Kit
185	V8	1961-1969	ⓐ, ⓑ	Mallory	YL431A	18-5296-2	18-5290
185	V8	1961-1969	ⓐ, ⓑ	Mallory	YD431A	18-5296-2	18-5290
220	V8	1961-1969	ⓐ, ⓑ	Mallory	YL431A	18-5296-2	18-5290
220	V8	1961-1969	ⓐ, ⓑ	Mallory	YD431A	18-5296-2	18-5290
230	V8	1961-1969	ⓐ, ⓑ	Mallory	YL431A	18-5296-2	18-5290
230	V8	1961-1969	ⓐ, ⓑ	Mallory	YD431A	18-5296-2	18-5290
283	V8	1961-1969	ⓐ, ⓑ	Prestolite	IBM-4110	18-5298	18-5288
302	V8	1975-1978	ⓐ, ⓑ	Prestolite	IBM-7007	18-5298	18-5288
302	V8	1975-1978	ⓐ, ⓑ	Prestolite	IBM-7007A	18-5298	18-5288
305	V8	1977-1982	ⓐ, ⓑ	Prestolite	IBM-7011	18-5298	18-5288
305	V8	1977-1982	ⓐ, ⓑ	Prestolite	IBM-7011C	18-5298	18-5288
305	V8	1977-1982	ⓐ, ⓑ	Prestolite	IBM-7011D	18-5298	18-5288
305	V8	1983-1987	ⓐ, ⓑ	Mallory	-	18-5296-2	18-5290
305	V8	1987-1988	ⓐ, ⓑ	Prestolite	IDU-7801	18-5239	18-5240
327	V8	1961-1969	ⓐ, ⓑ	Prestolite	IBM-4110	18-5298	18-5288
350	V8	1977-1982	ⓐ, ⓑ	Prestolite	IBM-7011	18-5298	18-5288
350	V8	1977-1982	ⓐ, ⓑ	Prestolite	IBM-7011C	18-5298	18-5288
350	V8	1977-1982	ⓐ, ⓑ	Prestolite	IBM-7011D	18-5298	18-5288
350	V8	1983-1987	ⓐ, ⓑ	Mallory	-	18-5296-2	18-5290
350	V8	1987-1988	ⓐ, ⓑ	Prestolite	IDU-7801	18-5239	18-5240
409	V8	1961-1969	ⓐ, ⓑ	Prestolite	IBM-4110	18-5298	18-5288
454	V8	1977-1982	ⓐ, ⓑ	Prestolite	IBM-7011	18-5298	18-5288
454	V8	1977-1982	ⓐ, ⓑ	Prestolite	IBM-7011C	18-5298	18-5288
454	V8	1977-1982	ⓐ, ⓑ	Prestolite	IBM-7011D	18-5298	18-5288
454	V8	1983-1987	ⓐ, ⓑ	Mallory	-	18-5296-2	18-5290
454	V8	1987-1988	ⓐ, ⓑ	Prestolite	IDU-7801	18-5239	18-5240

DEARBORN MARINE							
Model	Cylinders	Years	Footnotes	Distributor Make	Distributor #	Ignitor Kit	Ignitor II Kit
221 CID	V8	1961-1969	3, 6	Mallory	YL362	18-5296-2	18-5290
221 CID	V8	1961-1969	3, 6	Mallory	YL455	18-5296-2	18-5290
221 CID	V8	1961-1969	3, 6	Mallory	YL519	18-5296-2	18-5290
260 CID	V8	1961-1969	3, 6	Mallory	YL362	18-5296-2	18-5290
260 CID	V8	1961-1969	3, 6	Mallory	YL455	18-5296-2	18-5290
260 CID	V8	1961-1969	3, 6	Mallory	YL519	18-5296-2	18-5290
262 CID	V8	1960-1969	3, 6	Mallory	YL350A	18-5296-2	18-5290
262 CID	V8	1960-1969	3, 6	Mallory	YL387A	18-5296-2	18-5290
272 CID	V8	1960-1969	3, 6	Mallory	YL350A	18-5296-2	18-5290
272 CID	V8	1960-1969	3, 6	Mallory	YL387A	18-5296-2	18-5290
289 CID	V8	1961-1969	3, 6	Mallory	YL362	18-5296-2	18-5290
289 CID	V8	1961-1969	3, 6	Mallory	YL455	18-5296-2	18-5290
289 CID	V8	1961-1969	3, 6	Mallory	YL519	18-5296-2	18-5290
292 CID	V8	1960-1969	3, 6	Mallory	YL350A	18-5296-2	18-5290
292 CID	V8	1960-1969	3, 6	Mallory	YL387A	18-5296-2	18-5290
312 CID	V8	1960-1969	3, 6	Mallory	YL350A	18-5296-2	18-5290
312 CID	V8	1960-1969	3, 6	Mallory	YL387A	18-5296-2	18-5290
352 CID	V8	1961-1969	3, 6	Mallory	YL362	18-5296-2	18-5290
352 CID	V8	1961-1969	3, 6	Mallory	YL455	18-5296-2	18-5290
352 CID	V8	1961-1969	3, 6	Mallory	YL519	18-5296-2	18-5290
390 CID	V8	1961-1969	3, 6	Mallory	YL362	18-5296-2	18-5290
390 CID	V8	1961-1969	3, 6	Mallory	YL455	18-5296-2	18-5290
390 CID	V8	1961-1969	3, 6	Mallory	YL519	18-5296-2	18-5290

APPLICATION CONTINUED ON NEXT PAGE

- ⓐ Clockwise Rotation
- ⓑ Factory Electronic Ignition
- ⓐ Excluding distributor number YL670AV
- ⓐ Use with Screw Down Distributor Cap
- ⓑ Use with Clip Down Distributor Cap
- ⓐ Ignitor II cannot be used with solid core Ignition Wires.

DEARBORN MARINE

Model	Cylinders	Years	Footnotes	Distributor Make	Distributor #	Ignitor Kit	Ignitor II Kit
427 CID	V8	1965-1969	ⓐ, ⓑ	Mallory	YL494A-2	18-5296-2	18-5290
427 CID	V8	1965-1969	ⓐ, ⓑ	Mallory	YL494B-2	18-5296-2	18-5290

FORD MARINE

Model	Cylinders	Years	Footnotes	Distributor Make	Distributor #	Ignitor Kit	Ignitor II Kit
302 CID	V8	1973-1988	ⓐ, ⓑ	Prestolite	IBM-7007	18-5298	18-5288
302 CID	V8	1973-1988	ⓐ, ⓑ	Prestolite	IBM-7008	18-5298	18-5288
302 CID	V8	1973-1988	ⓐ, ⓑ	Prestolite	IBM-7019	18-5299	18-5289
302 CID	V8	1973-1988	ⓐ, ⓑ	Prestolite	IBM-7020	18-5299	18-5289
351 CID	V8	1973-1988	ⓐ, ⓑ	Prestolite	IBM-7007	18-5298	18-5288
351 CID	V8	1973-1988	ⓐ, ⓑ	Prestolite	IBM-7008	18-5298	18-5288
351 CID	V8	1973-1988	ⓐ, ⓑ	Prestolite	IBM-7019	18-5299	18-5289
351 CID	V8	1973-1988	ⓐ, ⓑ	Prestolite	IBM-7020	18-5299	18-5289
460 CID	V8	1973-1988	ⓐ, ⓑ	Prestolite	IBM-7007	18-5298	18-5288
460 CID	V8	1973-1988	ⓐ, ⓑ	Prestolite	IBM-7008	18-5298	18-5288
460 CID	V8	1973-1988	ⓐ, ⓑ	Prestolite	IBM-7019	18-5299	18-5289
460 CID	V8	1973-1988	ⓐ, ⓑ	Prestolite	IBM-7020	18-5299	18-5289

GRAY MARINE

Model	Cylinders	Years	Footnotes	Distributor Make	Distributor #	Ignitor Kit	Ignitor II Kit
138	V8	1950-1969	ⓐ, ⓑ	Mallory	YL429	18-5296-2	18-5290
138	V8	1950-1969	ⓐ, ⓑ	Mallory	YL429C	18-5296-2	18-5290
138	V8	1950-1969	ⓐ, ⓑ	Mallory	YL429D	18-5296-2	18-5290
178	V8	1950-1969	ⓐ, ⓑ	Mallory	YL429	18-5296-2	18-5290
178	V8	1950-1969	ⓐ, ⓑ	Mallory	YL429C	18-5296-2	18-5290
178	V8	1950-1969	ⓐ, ⓑ	Mallory	YL429D	18-5296-2	18-5290
401 CID	V8	ALL	ⓐ, ⓑ	Mallory	YL455A	18-5296-2	18-5290
401 CID	V8	ALL	ⓐ, ⓑ	Mallory	YL455A	18-5296-2	18-5290
CF175	V8	1965-1968	ⓐ, ⓑ	Prestolite	IBM-4119	18-5298	18-5288
CF175	V8	1965-1968	ⓐ, ⓑ	Prestolite	IBM-4119A	18-5298	18-5288
CF195	V8	1965-1968	ⓐ, ⓑ	Prestolite	IBM-4119	18-5298	18-5288
CF195	V8	1965-1968	ⓐ, ⓑ	Prestolite	IBM-4119A	18-5298	18-5288
CH175	V8	1965-1968	ⓐ, ⓑ	Prestolite	IBM-4119	18-5298	18-5288
CH175	V8	1965-1968	ⓐ, ⓑ	Prestolite	IBM-4119A	18-5298	18-5288
CH195	V8	1965-1968	ⓐ, ⓑ	Prestolite	IBM-4119	18-5298	18-5288
CH195	V8	1965-1968	ⓐ, ⓑ	Prestolite	IBM-4119A	18-5298	18-5288

INDMAR

Model	Cylinders	Years	Footnotes	Distributor Make	Distributor #	Ignitor Kit	Ignitor II Kit
All Models	V8	1979-1979	ⓐ, ⓑ	Prestolite	IBM-7011	18-5298	18-5288

MARINE POWER

Model	Cylinders	Years	Footnotes	Distributor Make	Distributor #	Ignitor Kit	Ignitor II Kit
305 CID	V8	1978-1983	ⓐ, ⓑ	Prestolite	IBM-7011	18-5298	18-5288
305 CID	V8	1978-1983	ⓐ, ⓑ	Prestolite	IBM-7013	18-5299	18-5289
350 CID	V8	1978-1983	ⓐ, ⓑ	Prestolite	IBM-7011	18-5298	18-5288
350 CID	V8	1978-1983	ⓐ, ⓑ	Prestolite	IBM-7013	18-5299	18-5289
454 CID	V8	1978-1983	ⓐ, ⓑ	Prestolite	IBM-7011	18-5298	18-5288
454 CID	V8	1978-1983	ⓐ, ⓑ	Prestolite	IBM-7013	18-5299	18-5289

MERCURISER

Model	Cylinders	Years	Footnotes	Distributor Make	Distributor #	Ignitor Kit	Ignitor II Kit
110	I4	ALL	ⓐ, ⓑ	Delco	-	18-5297	18-5285
120	I4	ALL	ⓐ, ⓑ	Delco	-	18-5297	18-5285
140	I4	ALL	ⓐ, ⓑ	Delco	-	18-5297	18-5285

APPLICATION CONTINUED ON NEXT PAGE

- ⓐ Clockwise Rotation
- ⓑ Factory Electronic Ignition
- ⓐ Use with Screw Down Distributor Cap
- ⓑ Use with Clip Down Distributor Cap
- ⓐ Excluding distributor number YL670AV
- ⓑ Ignitor II cannot be used with solid core Ignition Wires

MERCURISER							
Model	Cylinders	Years	Footnotes	Distributor Make	Distributor #	Ignitor Kit	Ignitor II Kit
140	V6	ALL	⓪	Delco	-	18-5294	-
150	V6	ALL	⓪	Delco	-	18-5294	-
160	V6	ALL	⓪	Delco	-	18-5294	-
165	I4	ALL	⓪, Ⓢ	Delco	-	18-5297	18-5285
165	V6	ALL	⓪	Delco	-	18-5294	-
170	I4	ALL	⓪, Ⓢ	Delco	-	18-5297	18-5285
180	I4	ALL	⓪, Ⓢ	Delco	-	18-5297	18-5285
190	I4	ALL	⓪, Ⓢ	Delco	-	18-5297	18-5285
198	V8	ALL	⓪, Ⓢ	Mallory	-	18-5296-2	18-5290
200	V6	ALL	⓪	Delco	-	18-5294	-
215	V8	ALL	⓪, Ⓢ	Mallory	-	18-5296-2	18-5290
225	V8	ALL	⓪, Ⓢ	Mallory	-	18-5296-2	18-5290
228	V8	ALL	⓪, Ⓢ	Mallory	-	18-5296-2	18-5290
233	V8	ALL	⓪, Ⓢ	Prestolite	-	18-5298	18-5288
233	V8	ALL	⓪, Ⓢ	Prestolite	-	18-5299	18-5289
250	V8	ALL	⓪, Ⓢ	Mallory	-	18-5296-2	18-5290
255	V8	ALL	⓪, Ⓢ	Mallory	-	18-5296-2	18-5290
260	V8	ALL	⓪, Ⓢ	Mallory	-	18-5296-2	18-5290
280	V8	ALL	⓪, Ⓢ	Mallory	-	18-5296-2	18-5290
330	V8	ALL	⓪, Ⓢ	Mallory	-	18-5296-2	18-5290
370	V8	ALL	⓪, Ⓢ	Mallory	-	18-5296-2	18-5290
400	V8	ALL	⓪, Ⓢ	Mallory	-	18-5296-2	18-5290
440	V8	ALL	⓪, Ⓢ	Mallory	-	18-5296-2	18-5290
470	I4	ALL	⓪, Ⓢ	Delco	-	18-5297	18-5285
485	I4	ALL	⓪, Ⓢ	Delco	-	18-5297	18-5285
888	V8	ALL	⓪, Ⓢ	Prestolite	-	18-5298	18-5288
888	V8	ALL	⓪, Ⓢ	Mallory	-	18-5296-2	18-5290
898	V8	ALL	⓪, Ⓢ	Mallory	-	18-5296-2	18-5290
120 Alpha 1	V6	ALL	⓪	Delco	-	18-5294	-
140 Alpha 1	V6	ALL	⓪	Delco	-	18-5294	-
460 TRS	V8	ALL	⓪, Ⓢ	Mallory	-	18-5296-2	18-5290
470R	I4	ALL	⓪, Ⓢ	Delco	-	18-5297	18-5285
488R	I4	ALL	⓪, Ⓢ	Delco	-	18-5297	18-5285
5.7 Ski	V8	ALL	⓪, Ⓢ	Mallory	-	18-5296-2	18-5290
OMC							
Model	Cylinders	Years	Footnotes	Distributor Make	Distributor #	Ignitor Kit	Ignitor II Kit
100HP	I4	1964-1988	⓪, Ⓢ	Delco	-	18-5297	18-5285
110HP	I4	1964-1988	⓪, Ⓢ	Delco	-	18-5297	18-5285
120HP	I4	1964-1988	⓪, Ⓢ	Delco	-	18-5297	18-5285
140HP	I4	1964-1988	⓪, Ⓢ	Delco	-	18-5297	18-5285
150HP	V6	1964-1966	⓪	Delco	1110309	18-5297	18-5285
150HP	V6	1964-1966	⓪	Delco	1110322	18-5297	18-5285
165HP	V6	1972-1976	⓪	Delco	980156	18-5297	18-5285
2.5L	I4	1982-1988	⓪, Ⓢ	Delco	982351	18-5297	18-5285
3.0L	I4	1982-1988	⓪, Ⓢ	Delco	982351	18-5297	18-5285
ALL	V8	1966-1988	⓪, Ⓢ	Mallory	-	18-5296-2	18-5290
ALL	V8	1974-1988	⓪, Ⓢ	Prestolite	980902	18-5298	18-5288
ALL	V8	1974-1988	⓪, Ⓢ	Prestolite	981080	18-5298	18-5288
ALL	V8	1974-1988	⓪, Ⓢ	Prestolite	982320	18-5298	18-5288
ALL	V8	1982-1988	⓪, Ⓢ	Prestolite	IBM-7013C	18-5299	18-5289
ALL	V8	1982-1988	⓪, Ⓢ	Prestolite	IBM-7013D	18-5299	18-5289

Ⓢ Clockwise Rotation
 ⓪ Factory Electronic Ignition
 Ⓢ Excluding distributor number YL670AV

Ⓢ Use with Screw Down Distributor Cap
 ⓪ Use with Clip Down Distributor Cap
 Ⓢ Ignitor II cannot be used with solid core Ignition Wires

ONAN

Model	Cylinders	Years	Footnotes	Distributor Make	Distributor #	Ignitor Kit	Ignitor II Kit
MDJC	I4	1961-1980	ⓐ	AutoLite	IGW-4409A	18-5295	-

PLEASURECRAFT MARINE

Model	Cylinders	Years	Footnotes	Distributor Make	Distributor #	Ignitor Kit	Ignitor II Kit
302 CID	V8	1975-1978	ⓐ, ⓑ	Prestolite	IBM-7007	18-5298	18-5288
302 CID	V8	1975-1978	ⓐ, ⓑ	Prestolite	IBM-7008	18-5298	18-5288
305 CID	V8	1976-1982	ⓐ, ⓑ	Prestolite	IBM-7011	18-5298	18-5288
305 CID	V8	1983-1988	ⓐ, ⓑ	Prestolite	IBM-7013	18-5299	18-5289
350 CID	V8	1976-1982	ⓐ, ⓑ	Prestolite	IBM-7011	18-5298	18-5288
350 CID	V8	1983-1988	ⓐ, ⓑ	Prestolite	IBM-7013	18-5299	18-5289
351 CID	V8	1975-1978	ⓐ, ⓑ	Prestolite	IBM-7007	18-5298	18-5288
351 CID	V8	1975-1978	ⓐ, ⓑ	Prestolite	IBM-7008	18-5298	18-5288
454 CID	V8	1976-1982	ⓐ, ⓑ	Prestolite	IBM-7011	18-5298	18-5288
454 CID	V8	1983-1988	ⓐ, ⓑ	Prestolite	IBM-7013	18-5299	18-5289
460 CID	V8	1975-1978	ⓐ, ⓑ	Prestolite	IBM-7007	18-5298	18-5288
460 CID	V8	1975-1978	ⓐ, ⓑ	Prestolite	IBM-7008	18-5298	18-5288

THERMO-ELECTRON

Model	Cylinders	Years	Footnotes	Distributor Make	Distributor #	Ignitor Kit	Ignitor II Kit
305 CID	V8	1977-1982	ⓐ, ⓑ	Prestolite	IBM-7011D	18-5298	18-5288
305 CID	V8	1981-1982	ⓐ, ⓑ	Prestolite	IBM-7013	18-5299	18-5289
350 CID	V8	1977-1982	ⓐ, ⓑ	Prestolite	IBM-7011D	18-5298	18-5288
350 CID	V8	1981-1982	ⓐ, ⓑ	Prestolite	IBM-7013	18-5299	18-5289
454 CID	V8	1977-1982	ⓐ, ⓑ	Prestolite	IBM-7011D	18-5298	18-5288
454 CID	V8	1981-1982	ⓐ, ⓑ	Prestolite	IBM-7013	18-5299	18-5289

UNIVERSAL

Model	Cylinders	Years	Footnotes	Distributor Make	Distributor #	Ignitor Kit	Ignitor II Kit
Atomic 4	I4	1968-1970	ⓐ, ⓑ	Delco	1112448	18-5297	18-5285

VOLVO PENTA

Model	Cylinders	Years	Footnotes	Distributor Make	Distributor #	Ignitor Kit	Ignitor II Kit
All Models	I4	ALL	ⓐ	Bosch	231178017	18-5292	-
All Models	V8	1977-1982	ⓐ, ⓑ	Prestolite	IBM-7011A	18-5298	18-5288
All Models	V8	1977-1982	ⓐ, ⓑ	Prestolite	IBM-7013A	18-5299	18-5289
All Models	V8	1986-1988	ⓐ, ⓑ	Prestolite	IDU-7801	18-5239	18-5240

WAUKESHA

Model	Cylinders	Years	Footnotes	Distributor Make	Distributor #	Ignitor Kit	Ignitor II Kit
FC (12 Volt)	I4	1959-1973	ⓐ	AutoLite	IGW-4301-3	18-5295	-
FCS (12 Volt)	I4	1959-1973	ⓐ	AutoLite	IGW-4301-3	18-5295	-
FS (12 Volt)	I4	1959-1973	ⓐ	AutoLite	IGW-4301-3	18-5295	-
IC (12 Volt)	I4	1959-1973	ⓐ, ⓑ	AutoLite	IGW-4301-3	18-5295	-
VGR-155	I4	1975-1978	ⓐ, ⓑ	Delco	1112470	18-5297	18-5285

WISCONSIN

Model	Cylinders	Years	Footnotes	Distributor Make	Distributor #	Ignitor Kit	Ignitor II Kit
VE4 (12 Volt)	I4	1948-1957	ⓐ	AutoLite	IGW Series	18-5295	-
VF4 (12 Volt)	I4	1948-1957	ⓐ	AutoLite	IGW Series	18-5295	-
VL4 (12 Volt)	I4	1948-1957	ⓐ	AutoLite	IGW Series	18-5295	-
VP4 (12 Volt)	I4	1948-1957	ⓐ	AutoLite	IGW Series	18-5295	-

- ⓐ Clockwise Rotation
- ⓑ Factory Electronic Ignition
- ⓒ Excluding distributor number YL670AV

- ⓓ Use with Screw Down Distributor Cap
- ⓔ Use with Clip Down Distributor Cap
- ⓕ Ignitor II cannot be used with solid core Ignition Wires

IGNITION WIRE IDENTIFICATION CHART



IGNITION WIRE LEAD TYPES

Sierra #	No. of Wires	Coil Wires	Dist. End	Spark Plug End	Coil End	Dist. End
OUTBOARD IGNITION WIRES						
18-28083	1	-	1	1	-	-
18-8815-1	1	-	4	4	-	-
18-8816-1	1	-	4	4	-	-
18-8818-1	1	-	4	4	-	-
18-8819-1	1	-	11	6	-	-
18-5227-1	1	-	11	6	-	-
18-5228-1	1	-	11	6	-	-
18-5231-1	1	-	4	4	-	-
18-5229-9-1	5	-	18	4	-	-
18-5230-9-1	5	-	18	4	-	-

Sierra #	No. of Wires	Coil Wires	Dist. End	Spark Plug End	Coil End	Dist. End
OUTBOARD IGNITION WIRES						
18-28084	3	-	1	1	-	-
18-28082	4	-	9	1	-	-
18-28085	4	-	1	1	-	-
18-8839-1	4	-	4	6	-	-
18-28090	6	-	9	1	-	-
18-28081	6	-	11	1	-	-
18-28086	6	-	1	1	-	-
18-28090	6	-	4	6	-	-
18-8840-1	6	-	4	6	-	-
18-8846-1	4	-	19	20	-	-

IGNITION WIRE LEAD TYPES (Continued)

Sierra #	No. of Cylinders	Coil Wire	Dist. End	Spark Plug End	Coil End	Coil Dist. End
STERNDRIVE/INBOARD IGNITION WIRES						
18-28100*	1	12	-	-	1	5
18-28101*	1	12	-	-	1	4
18-28102*	1	14	-	-	9	5
18-28042	4	12	5	1	5	5
18-28050	4	12	4	2	9	9
18-8800-1	4	13	5	2	9	5
18-8807-1	4	13	5	2	9	5
18-8808-2	4	13	5	3	9	5
18-8811-1	4	12	7	3	7	7
18-8813-1	4	20	9	14	13	13
18-8814-1	4	11/11	2	2	2	4
18-8833-1	4	9	4	1	4	4
18-8841-1	4	11	15	15/16	4	15
18-8801-1	6	13	5	2	9	5
18-8809-1	6	13	5	1	9	5
18-8810-1	6	13	6	1	10	6
18-8829-1	6	21	17	1	8	8
18-8835-1	6	15.5	4	1	4	4
18-28019	8	12/15	4	1	-	-
18-28033	8	14	4	2	5	4
18-28043	8	14	9	2	9	9
18-28044	8	12	5	3	9	9
18-28046	8	12/24	9	1	9	5
18-8802-1	8	13	5	1	9	5

Sierra #	No. of Cylinders	Coil Wire	Dist. End	Spark Plug End	Coil End	Coil Dist. End
STERNDRIVE/INBOARD IGNITION WIRES						
18-8803-1	8	13	5	1	9	5
18-8804-1	8	12	6	1	10	6
18-8805-1	8	13	5	1	9	5
18-8806-1	8	13	5	1	9	5
18-8817-1	8	12	5	2	2	2
18-8820-1	8	14	4	1	6	4
18-8821-1	8	12	6	1	5	6
18-8822-1	8	15.5	4	1	4	4
18-8823-1	8	12/17	9	1	11	5
18-8824-1	8	14	4	1	6	4
18-8825-1	8	14	5	3	11	5
18-8826-1	8	14	9	2	11	9
18-8827-1	8	9	9	1	11	9
18-8828-1	8	21	17	1	8	8
18-8830-1	8	16	4	1	10	4
18-8832-1	8	9	4	1	4	4
18-8834-1	8	12	6	1	10	6
18-8836-1	8	16	4	1	4	4
18-8837-1	8	8	1	1	10	1
18-8838-2	8	-	8	12	-	-
18-8842-1	8	9	5	3	5	5
18-8843-1	8	16	5	3	5	5
18-8844-1	8	14	4	2	6	4

Sierra #	No. of Cylinders	Coil Wire	Dist. End	Spark Plug End	Coil End	Coil Dist. End
GENERATOR IGNITION WIRES						
23-4500	3	10	5	2	5	5
23-4501	4	-	5	12	-	-



Sierra
Marine Engine and Drive Parts

PREMIUM MARINE SPARK PLUG WIRE LEADS



Sierra's MAGFORCE Ignition Wires are "Electronics Friendly" protecting all of your electronic devices and electronic engine controls from RFI and EMI while delivering the maximum amount of voltage. Exact fit design ensures easy installation and years of trouble - free service.



See application below.

PLUG WIRE SET APPLICATION CHARTS

CHRIS-CRAFT

Engine	Cyl.	Distributor	Year Start	Year Stop	Plug Wire Set
181 CID (3.0L)	4	Conventional	ALL	ALL	18-8800-1
302	8	Conventional	ALL	ALL	18-28044
351	8	Conventional	ALL	ALL	18-28044
460	8	Conventional	ALL	ALL	18-28044
350	8	Conventional	1970	1990	18-8803-2
350	8	Conventional	1970	1990	18-8823-1
454	8	Conventional	ALL	ALL	18-8817-1
502	8	Conventional	ALL	ALL	18-8817-1

Ⓢ Models designed with Mallory side terminals

CHRYSLER

Engine	Cyl.	Distributor	Year Start	Year Stop	Plug Wire Set
M273	8	Conventional & Electronic	1968	1974	18-8826-1
LM318	8	Conventional & Electronic	1968	1985	18-8826-1
M328	8	Conventional & Electronic	1960	1995	18-8826-1
M340	8	Conventional & Electronic	1968	1985	18-8826-1
M360	8	Conventional & Electronic	1975	1985	18-8826-1
361	8	Conventional & Electronic	1968	1985	18-8827-1
383	8	Conventional & Electronic	1960	1988	18-8827-1
400	8	Conventional & Electronic	1968	1985	18-8827-1
440	8	Conventional & Electronic	1968	1985	18-8827-1

CRUSADER-PCM

Engine	Cyl.	Distributor	Year Start	Year Stop	Plug Wire Set
262 CID 4.3L	6	Prestolite	ALL	ALL	18-8801-1
262 CID 4.3L	6	Delco EST	ALL	ALL	18-8810-1
262 CID 4.3L	6	Delco HVS	ALL	ALL	18-8828-1
220 (305 CID 5.0L)	8	Mallory/Prestolite Ⓢ	Up to	1987	18-8803-2
220 (305 CID 5.0L)	8	Mallory/Prestolite Ⓢ	1987	1992	18-8803-2
270 (350 CID 5.7L)	8	Mallory/Prestolite Ⓢ	Up to	1987	18-8803-2
270 (350 CID 5.7L)	8	Mallory/Prestolite Ⓢ	1987	1992	18-8803-2
TB350	8	Delco EST Ⓢ	1992	& Up	18-8824-1
5.7L Classic	8	Mallory	1999	& Up	18-8803-2
5.7L MPI Classic	8	Delco HVS	2007	& Up	18-8828-1
MP5.0L Captain's Choice	8	Delco HVS	2002	2005	18-8828-1
MP5.7L Captain's Choice	8	Delco HVS	2002	2005	18-8828-1
MP6.0L	8	Distributorless	2002	& Up	18-8838-1
350 (454 CID 7.4L)	8	Mallory Ⓢ	Up to	1991	18-8803-2
454XL (454 CID 7.4L)	8	Delco EST Ⓢ	1991	& Up	18-8824-1
CM454HO (454 CID 7.4L)	8	Delco EST Ⓢ	1991	& Up	18-8824-1
454XL (454 CID 7.4L)	8	Delco EST Ⓢ	1993	& Up	18-8824-1
MP8.1L	8	Distributorless	ALL	ALL	18-8838-1
502 (502 CID 8.2L)	8	Prestolite Ⓢ	Up to	1991	18-8803-2
502 (502 CID 8.2L)	8	Delco EST Ⓢ	Up to	1991	18-8824-1
502XL (502 CID 8.2L)	8	Delco EST Ⓢ	1991	& Up	18-8824-1
TB502XL (502 CID 8.2L)	8	Delco EST Ⓢ	1994	& Up	18-8824-1

Ⓢ Serial Number up to 68702 Ⓢ Serial Number 68703-90232 Ⓢ Serial Number 90232 & UP Ⓢ Serial Number up to 88710
 Ⓢ Serial Number 88710 & UP Ⓢ Serial Number 92682 & UP Ⓢ Serial Number 94288 & UP

PLUG WIRE SET APPLICATION CHARTS (Cont.)

INDMAR

Engine	Cyl.	Distributor	Year Start	Year Stop	Plug Wire Set
1140	8	Prestolite	Up to	1993	18-8803-2
200	8	Prestolite	Up to	1993	18-8803-2
225	8	Prestolite	Up to	1993	18-8803-2
250	8	Prestolite	Up to	1993	18-8803-2
275	8	Prestolite/Mallory	Up to	1993	18-8803-2
300	8	Prestolite/Mallory	Up to	1993	18-8803-2
350	8	Prestolite/Mallory	Up to	1993	18-8803-2
400	8	Prestolite/Mallory	Up to	1993	18-8803-2
5.7L EFI	8	Delco EST	1994	2009	18-8836-1
5.7L EFI	8	Delco HVS	2007	& Up	18-8828-1
6.0L EFI	8	Distributorless	2003	& Up	18-8838-1
6.2L EFI	8	Distributorless	2010	& Up	18-8838-1
454 Carbureted (7.4L)	8	Delco EST	1994	2011	18-8824-1
8.1L Vortec	8	Distributorless	2003	2011	18-8838-1
502 Carbureted (8.2L)	8	Delco EST	1994	2011	18-8824-1

MARINE POWER

Engine	Cyl.	Distributor	Year Start	Year Stop	Plug Wire Set
181	4	Delco	1986	1992	18-8800-1
262	6	Prestolite Ⓢ	1986	1992	18-8801-1
350	8	Prestolite Ⓢ	1986	1992	18-8802-1
350	8	Mallory	1986	1992	18-8802-1
3.0L	4	Delco EST	1993	& Up	18-8833-1
4.3L	6	Delco EST	1993	& Up	18-8835-1
5.0L	8	Delco EST	1993	2005	18-8822-1
5.0L	8	Delco HVS	2005	& Up	18-8828-1
5.7L	8	Delco EST	1993	2005	18-8822-1
5.7L	8	Delco HVS	2005	& Up	18-8828-1
7.4L	8	Delco EST	1993	2000	18-8832-1
8.2L	8	Delco EST	1993	2000	18-8832-1

Ⓢ Screw down cap.

MERCURISER

Model	Cyl.	Distributor	Year Start	Year Stop	Serial # Start	Serial # End	Plug Wire Set
110	4	Delco	1963	1966	1537370	2044033	18-8800-1
120	4	Delco	1964	1986	1666601	0B531853	18-8800-1
2.5L	4	Delco	1967	1989	0B531854	0C853255	18-8800-1
140	4	Delco	1968	1986	2508261	0B450800	18-8800-1
3.0L	4	Delco	1967	1989	0B450801	0C856558	18-8800-1
3.0L, LX	4	Prestolite	1990	1991	0C856559	0D504541	18-8800-1
3.0L, LX	4	Delco Digital	1990	1991	0C856559	0D504541	18-8811-1
3.0L	4	Delco EST	1991	& Up	0D504542	& Up	18-8833-1
3.0LX	4	Delco EST	1991	1997	0D504542	0K999999	18-8833-1
3.0L MPI	4	Delco EST	2012	& Up	1A072812	& Up	18-8833-1
165	4	Delco	1987	1987	0B434940	0B774251	18-8808-2
170	4	Delco	1985	1986	6916779	0B434940	18-8808-2
180	4	Prestolite	1987	1987	0B436391	0B775248	18-8800-1
190	4	Delco	1985	1986	6916779	0B436390	18-8808-2
3.7L	4	Delco	1988	1989	0B774252	& Up	18-8808-2
3.7LX	4	Delco	1988	1989	0B775249	& Up	18-8808-2
3.7LX	4	Prestolite	1988	1989	0B775249	& Up	18-8800-1
470	4	Delco	1976	1984	4208370	6916778	18-8808-2
485	4	Delco	1980	1982	5685394	6218036	18-8808-2

MERCURISER CONTINUED ON NEXT PAGE

PLUG WIRE SET APPLICATION CHARTS (Cont.)

MERCURISER							
Model	Cyl.	Distributor	Year Start	Year Stop	Serial # Start	Serial # End	Plug Wire Set
488	4	Delco	1981	1984	6170297	6916778	18-8808-2
140	L6	Delco	1963	1963	1538930	1725960	18-8809-1
150	L6	Delco	1964	1966	1666495	2048046	18-8809-1
160	L6	Delco	1967	1969	2048022	2770031	18-8809-1
165	L6	Delco	1970	1981	2770032	5813433	18-8809-1
200	L6	Delco	1969	1969	2453769	2712072	18-8809-1
185	6	Prestolite	1983	1984	6330183	6919655	18-8801-1
175	6	Thunderbolt IV	1987	1987	0B527955	0B773242	18-8810-1
185	6	Thunderbolt IV	1985	1987	6919656	0B527954	18-8810-1
205	6	Thunderbolt IV	1985	1987	0A331445	0B775129	18-8810-1
262 Mag	6	Delco EST	1996	1997	0F803800	0K999999	18-8835-1
4.3L	6	Thunderbolt IV	1988	1996	0B773243	0F802999	18-8810-1
4.3L Alpha	6	Thunderbolt V	1998	& Up	0L010044	& Up	18-8810-1
4.3L Bravo	6	Thunderbolt V	1998	& Up	0L010044	& Up	18-8810-1
4.3L EFI	6	Delco EST	1998	1998	0L012009	0L359999	18-8835-1
4.3L EFI	6	Thunderbolt V	1999	2004	0L360000	& Up	18-8810-1
4.3L MPI	6	Delco HVS	2001	& Up	0M300000	& Up	18-8829-1
4.3LH Alpha	6	Thunderbolt V	1998	2004	0L010044	& Up	18-8810-1
4.3LH Bravo	6	Thunderbolt V	1998	2004	0L010044	& Up	18-8810-1
4.3LX, LXH	6	Thunderbolt IV	1988	1997	0B775130	0K999999	18-8810-1
215 MCM & MIE (Ford)	8	Autolite/Mallory	1970	1972	2781153	3563181	18-8803-2
225 MCM & MIE (Ford)	8	Autolite/Mallory/Mercury	1973	1974	3385721	4166999	18-8803-2
888 (Ford)	8	Autolite/Mallory	1971	1977	3108723	4887829	18-8803-2
190 (GM)	8	Delco	1963	1964	1564539	1730903	18-8803-2
198 MIE	8	Mallory	1977	1977	4776402	4931099	18-8803-2
200	8	Thunderbolt IV	1985	1987	6899058	8774444	18-8821-1
228	8	Mallory	1977	1982	4765100	6218461	18-8803-2
228	8	Thunderbolt IV	1983	1984	6218462	6899268	18-8821-1
228 MIE	8	Mallory	1977	1980	4765100	5907057	18-8803-2
230	8	Thunderbolt IV	1985	1987	6899269	0B773739	18-8821-1
230 MIE (LH)	8	Thunderbolt IV	1981	1987	5907058	0B788151	18-8821-1
230 MIE (RH)	8	Thunderbolt IV	1981	1987	5907058	0B788151	18-8821-1
5.0L	8	Thunderbolt IV	1988	1995	0B774445	0F800999	18-8821-1
5.0L Alpha	8	Thunderbolt V	1998	& Up	0L015751	& Up	18-8821-1
5.0L Bravo	8	Thunderbolt V	1998	& Up	0L015751	& Up	18-8821-1
5.0L EFI	8	Delco EST	1998	1998	0L012052	0L339999	18-8822-1
5.0L MIE (LH)	8	Thunderbolt IV	1988	1988	0B788152	0C396832	18-8821-1
5.0L MIE (RH)	8	Thunderbolt IV	1988	1988	0B788152	0C396832	18-8821-1
5.0L MPI Alpha	8	Delco HVS	2001	& Up	0M300000	& Up	18-8828-1
5.0LX	8	Thunderbolt IV	1988	1995	0B773740	0F800999	18-8821-1
898	8	Mallory	1977	1982	4762210	6218461	18-8803-2
898	8	Thunderbolt IV	1983	1984	6218462	6899057	18-8821-1
225 (GM)	8	Delco	1963	1969	1539620	2694014	18-8803-2
225 MIE (GM)	8	Thunderbolt	1968	1968	2278647	2694014	18-8803-2
250 MCM & MIE	8	Thunderbolt	1968	1969	2314301	2639854	18-8803-2
250	8	Mallory	1977	1977	4768000	4908849	18-8803-2
255 MCM & MIE	8	Mallory	1975	1976	3258728	4501254	18-8803-2
255 MCM & MIE	8	Mercury	1976	1976	4498701	4767999	18-8803-2
255 MIE	8	Mercury	1977	1980	4768000	5907057	18-8803-2
260	8	Mallory	1978	1982	4908850	6218461	18-8803-2
260	8	Thunderbolt IV	1982	1987	6218462	0B773304	18-8821-1
260 MIE (LH)	8	Thunderbolt IV	1981	1986	5907058	0B788151	18-8821-1
260 MIE (RH)	8	Thunderbolt IV	1981	1986	5907058	0B788151	18-8821-1

MERCURISER CONTINUED ON NEXT PAGE

PLUG WIRE SET APPLICATION CHARTS (Cont.)

MERCURISER

Model	Cyl.	Distributor	Year Start	Year Stop	Serial # Start	Serial # End	Plug Wire Set
270 MCM & MIE	8	Thunderbolt	1969	1972	2851074	3385720	18-8803-2
280 TRS	8	Mercury/Mallory	1975	1975	4178250	4499390	18-8803-2
300	8	Thunderbolt IV	1985	1986	6668677	0B430367	18-8821-1
320 EFI	8	Thunderbolt IV	1987	1989	0A543604	0C622418	18-8821-1
350 Mag Alpha	8	Thunderbolt IV	1986	1994	0A635178	0F353690	18-8821-1
350 Mag Alpha	8	Thunderbolt V	1995	1997	0F353691	0K999999	18-8821-1
350 Mag Alpha EFI	8	Delco EST	1996	1997	0F800300	0K999999	18-8822-1
350 Mag Bravo MPI	8	Delco EST	1995	1996	0F415189	0K999999	18-8822-1
350 Mag EFI Ski	8	Delco EST	1994	1997	0F215561	0K999999	18-8822-1
350 Mag MPI	8	Delco EST	1998	1998	0L010019	0L325952	18-8822-1
350 Mag MPI Alpha	8	Delco HVS	2001	& Up	0M300000	& Up	18-8828-1
350 Mag MPI Bravo	8	Delco HVS	2001	& Up	0M300000	& Up	18-8828-1
350 Mag MPI Horizon	8	Delco HVS	2001	& Up	0M300000	& Up	18-8828-1
350 Mag MPI Horizon MIE	8	Delco HVS	2001	& Up	0M300000	& Up	18-8828-1
350 Mag MPI MIE	8	Delco HVS	2001	& Up	0M300000	& Up	18-8828-1
350 Mag MPI Ski	8	Thunderbolt IV	1991	1996	0D505450	0K40399	18-8821-1
350 Mag MPI Ski	8	Thunderbolt V	1991	1997	0D505450	0K999999	18-8821-1
5.7L Alpha	8	Thunderbolt IV	1988	1995	0B773305	0F600999	18-8821-1
5.7L Alpha	8	Thunderbolt V	1996	1997	0F601000	& Up	18-8821-1
5.7L Bravo	8	Thunderbolt IV	1988	1993	0B773305	0F353524	18-8821-1
5.7L Bravo	8	Thunderbolt V	1994	& Up	0F353525	& Up	18-8821-1
5.7L EFI	8	Delco EST	1995	1998	0F225560	0L339999	18-8822-1
5.7L EFI MIE	8	Delco EST	1997	1997	0K040300	0K999999	18-8822-1
5.7L MIE	8	Thunderbolt IV	1988	1995	0B788152	0F746099	18-8821-1
5.7L MIE	8	Thunderbolt V	1996	1997	0F622100	0K999999	18-8821-1
5.7L MIE	8	Thunderbolt V	1998	& Up	0L002003	& Up	18-8821-1
5.7L Ski	8	Mallory/Prestolite	1985	1995	0A338553	0F775199	18-8802-1
5.7L Ski	8	Thunderbolt IV	1987	1995	0B514627	0F775199	18-8821-1
5.7L Ski	8	Thunderbolt V	1996	1997	0F775200	0K999999	18-8821-1
5.7L Ski	8	Thunderbolt V	1998	& Up	0L002005	& Up	18-8821-1
5.7LX Alpha & Bravo	8	Thunderbolt V	1996	1997	0F601000	0K999999	18-8821-1
5.7LX Bravo & EFI	8	Delco EST	1996	1997	0F752400	0K999999	18-8822-1
233 MCM & MIE (Ford)	8	Mercury/Prestolite	1975	1977	4173000	4902304	18-8803-2
255 MCM & MIE (Ford)	8	Mercury/Mallory	1973	1980	3258728	5907057	18-8803-2
MX 6.2L MPI	8	Delco HVS	2001	& Up	0M300000	& Up	18-8828-1
MX 6.2L MPI Horizon	8	Delco HVS	2001	& Up	0M300000	& Up	18-8828-1
MX 6.2L MPI Horizon MIE	8	Delco HVS	2001	& Up	0M300000	& Up	18-8828-1
MX 6.2L MPI MIE	8	Delco HVS	2001	& Up	0M300000	& Up	18-8828-1
377 MAG MPI BRAVO	8	Delco HVS	ALL	ALL	1A300000	& Up	18-8828-1
325 MCM & MIE	8	Thunderbolt	1969	1974	2278747	& Up	18-8803-2
325 MCM & MIE	8	Mallory	1969	1972	2278747	& Up	18-8803-2
390	8	Mallory	1968	1970	ALL		18-8803-2
330	8	Mallory	1977	1981	4623115	6083144	18-8803-2
330	8	Thunderbolt	1977	1981	4623115	6083144	18-8803-2
330	8	Thunderbolt IV	1982	1987	6083145	0B816540	18-8821-1
340 MIE	8	Thunderbolt IV	1981	1987	5889914	0B788365	18-8821-1
350 MIE	8	Thunderbolt	1974	1976	3780450	4623109	18-8803-2
370 TRS	8	Mallory/Holley	1978	1985	4179554	6721527	18-8803-2
370 TRS	8	Thunderbolt IV	1985	1987	6721528	0B714586	18-8821-1
400 TRS	8	Mallory/Holley	1980	1986	5668232	0B457644	18-8803-2
440 TRS	8	Mallory/Holley	1983	1986	6181070	0B485220	18-8803-2
450	8	Thunderbolt IV	1995	1996	0F347100	0F347277	18-8821-1
454 Mag Alpha	8	Thunderbolt IV	1986	1988	0A631894	0B785148	18-8821-1

MERCURISER CONTINUED ON NEXT PAGE

PLUG WIRE SET APPLICATION CHARTS (Cont.)

MERCURISER							
Model	Cyl.	Distributor	Year Start	Year Stop	Serial # Start	Serial # End	Plug Wire Set
454 Mag Bravo	8	Thunderbolt IV	1988	1997	0B721206	0K999999	18-8821-1
454 Mag EFI	8	Delco EST	1994	1996	0F115700	0F802349	18-8822-1
454 Mag MPI	8	Delco EST	1996	2001	0F802350	M024999	18-8822-1
454 Mag MPI Horizon MIE	8	Delco EST	1999	2001	0L002200	0L674000	18-8822-1
454 Mag MPI Ski	8	Delco EST	1995	1997	0F215800	0K999999	18-8822-1
7.4L Bravo I, II, III	8	Thunderbolt IV	1988	1997	0B771113	0K999999	18-8821-1
7.4L Bravo III	8	Thunderbolt V	1992	1997	603118	0K999999	18-8821-1
7.4L EFI MIE	8	Thunderbolt IV	1988	1996	0B788366	0F820141	18-8821-1
7.4L MIE	8	Thunderbolt IV	1988	1996	0B788366	0F820141	18-8821-1
7.4L MIE	8	Thunderbolt V	1992	1997	0D715494	0K999999	18-8821-1
7.4L MPI (L29)	8	Delco EST	1998	2001	0L010003	0M024330	18-8822-1
7.4L MPI MIE	8	Delco EST	1995	2001	0F563052	0M025999	18-8822-1
7.4LX Bravo EFI & MPI	8	Delco EST	1996	1997	0F602010	0K999999	18-8822-1
390	8	Thunderbolt	1969	1970	2781129	2825059	18-8803-2
460 TRS	8	Mallory/Holley	1983	1986	6180970	6181046	18-8803-2
460 Cyclone	8	ALL	1983	1985	ALL		18-8803-2
496 Mag & Mag HO	8	Delco (coil over plug)	2000	& Up	0M025000	& Up	18-8838-1
8.1 MIE & HO MIE	8	Delco (coil over plug)	2000	& Up	0M025000	& Up	18-8838-1
502 Mag Bravo	8	Thunderbolt IV	1990	1993	0G878221	0F114528	18-8821-1
502 Mag EFI	8	Delco EST	1993	1996	0B40650	0F802599	18-8822-1
502 Mag MPI	8	Delco EST	1996	2001	0F802600	0M024999	18-8822-1
525 SC	8	Thunderbolt IV	1991	1995	0D456000	0F877734	18-8821-1
8.2L MIE	8	Thunderbolt IV	1990	1996	0C878221	0F819619	18-8821-1
8.2L MPI MIE	8	Delco EST	1996	2001	0F819620	0L674200	18-8822-1

OMC						
Engine	Cyl.	Distributor	Year Start	Year Stop	Plug Wire Set	
2.3L	4	Mallory	1987	1990	18-8807-1	
2.3L	4	Prestolite	1990	1990	18-8807-1	
2.5L	4	Delco	1981	1986	18-8800-1	
3.0L	4	Delco	1982	1990	18-8800-1	
3.0L	4	Delco EST	1990	1998	18-8833-1	
3.8L	6	Prestolite	1981	1985	18-8801-1	
4.3L	6	Prestolite ②	1985	1990	18-8801-1	
4.3L	6	Prestolite	1991	1993	18-8801-1	
4.3L	6	Delco EST	1994	1998	18-8835-1	
5.0L (GM)	8	Prestolite ①	1979	1982	18-8802-1	
5.0L (GM)	8	Mallory	1981	1988	18-8802-1	
5.0L (GM)	8	Prestolite ②	1983	1988	18-8802-1	
5.0L (Ford)	8	Prestolite ②	1989	1990	18-8806-1	
5.0L (Ford)	8	Prestolite	1991	1996	18-8806-1	
5.0L (Ford)	8	Ford HEI	1993	1996	18-8820-1	
5.0L (GM)	8	Prestolite	1996	1998	18-8801-1	
5.0L (GM)	8	Delco EST	1998	1998	18-8822-1	
5.7L	8	Mallory	1982	1990	18-8802-1	
5.7L	8	Prestolite ②	1982	1990	18-8802-1	
5.7L	8	Prestolite ②	1991	1998	18-8802-1	
5.7L	8	Delco EST	1996	1998	18-8822-1	
5.8L	8	Prestolite ②	1989	1990	18-8842-1	
5.8L	8	Prestolite ②	1991	1996	18-8842-1	
5.8L	8	Ford HEI	1993	1996	18-8820-1	
7.4L	8	Mallory	1988	1988	18-8802-1	

OMC CONTINUED ON NEXT PAGE

PLUG WIRE SET APPLICATION CHARTS (Cont.)

OMC

Engine	Cyl.	Distributor	Year Start	Year Stop	Plug Wire Set
7.4L	8	Prestolite Ⓢ	1988	1988	18-8802-1
7.4L	8	Distributorless	1990	1991	18-8843-1
7.4L	8	Delco EST	1995	1998	18-8832-1
7.5L	8	Prestolite Ⓢ	1987	1987	18-8803-2
7.5L	8	Prestolite Ⓢ	1987	1989	18-8803-2
8.2L	8	Mallory	1984	1985	18-8802-1
8.2L	8	Prestolite Ⓢ	1984	1985	18-8802-1
8.2L	8	Delco EST	1998	1998	18-8832-1
80	4	ALL	1962	1968	18-8800-1
90	4	ALL	1962	1968	18-8800-1
100	4	Delco	1972	1973	18-8800-1
110	4	Delco	1964	1964	18-8800-1
120	4	Delco	1965	1981	18-8800-1
140	4	Delco	1973	1981	18-8800-1
170	8	Prestolite Ⓢ	1974	1974	18-8802-1
175	8	Prestolite Ⓢ	1975	1977	18-8802-1
185	8	Mallory	1967	1968	18-8802-1
185	8	Mallory	1978	1980	18-8802-1
185	8	Prestolite Ⓢ	1978	1980	18-8802-1
190	8	Prestolite Ⓢ	1974	1977	18-8802-1
200	8	Mallory	1979	1988	18-8802-1
200	8	Prestolite Ⓢ	1979	1981	18-8802-1
210	8	Mallory	1968	1970	18-8802-1
215	8	Mallory	1971	1971	18-8802-1
225	8	Mallory	1972	1976	18-8802-1
225	8	Mallory	1978	1978	18-8802-1
230	8	Mallory	1979	1981	18-8802-1
230	8	Prestolite Ⓢ	1979	1981	18-8802-1
230	8	Mallory	1975	1976	18-8802-1
235	8	Mallory	1971	1971	18-8802-1
235	8	Prestolite Ⓢ	1975	1977	18-8802-1
240	8	Prestolite Ⓢ	1978	1978	18-8802-1
245	8	Mallory	1975	1975	18-8802-1
250	8	Mallory	1970	1974	18-8802-1
250	8	Prestolite Ⓢ	1979	1979	18-8802-1
260	8	Mallory	1975	1976	18-8802-1
260	8	Mallory	1979	1981	18-8802-1
260	8	Prestolite Ⓢ	1979	1981	18-8802-1
290 JET	8	Mallory	1974	1975	18-8802-1
305	8	Mallory	1977	1979	18-8802-1
305	8	Mallory	1980	1981	18-8802-1
305	8	Prestolite Ⓢ	1981	1981	18-8802-1
350	8	Mallory	1977	1979	18-8802-1
350	8	Mallory	1980	1981	18-8802-1
350	8	Prestolite Ⓢ	1981	1981	18-8802-1
454	8	Mallory	1977	1979	18-8803-2
454	8	Mallory	1980	1981	18-8803-2
454	8	Prestolite Ⓢ	1981	1981	18-8803-2

Ⓢ Clip down cap Ⓢ Snap down cap

VOLVO

Model	Cyl.	Distributor	Year Start	Year End	Plug Wire Set
AQ115A, B	4	Volvo	1969	1975	18-28050

VOLVO CONTINUED ON NEXT PAGE

PLUG WIRE SET APPLICATION CHARTS (Cont.)

VOLVO					
Model	Cyl.	Distributor	Year Start	Year End	Plug Wire Set
AQ120B	4	Volvo	1977	1980	18-8813-1
AQ125A, B	4	Volvo	1981	1985	18-8813-1
AQ130A, B, C, D	4	Volvo	1968	1977	18-28050
AQ131A, B, C, D	4	Volvo	1985	1989	18-8813-1
AQ140A	4	Volvo	1975	1979	18-8813-1
AQ145A, B	4	Volvo	1979	1985	18-8813-1
AQ151A, B, C	4	Volvo	1985	1989	18-8813-1
AQ175A	6	Volvo	1981	1985	18-8801-1
AQ190A	8	Volvo	1976	1977	18-8802-1
AQ200B	8	Mallory (Tail Cap)	1974	1976	18-8802-1
AQ200B	8	Mallory (Flat Cap)	1974	1976	18-8823-1
AQ200C	8	Mallory (Tail Cap)	1976	1977	18-8802-1
AQ200C	8	Mallory (Flat Cap)	1976	1977	18-8823-1
AQ205A	6	Volvo	1988	1989	18-8801-1
AQ211A	8	Volvo	1986	1989	18-8802-1
AQ225B	8	Mallory (Tail Cap)	1974	1976	18-8802-1
AQ225B	8	Mallory (Flat Cap)	1974	1976	18-8823-1
AQ231A, B	8	Volvo	1986	1989	18-8802-1
AQ240A	8	Volvo	1976	1977	18-8802-1
AQ255A	8	Mallory (Flat Cap)	1977	1978	18-8823-1
AQ255B	8	Mallory (Tail Cap)	1978	1978	18-8802-1
AQ255B	8	Mallory (Flat Cap)	1978	1978	18-8823-1
AQ260A	8	Mallory (Tail Cap)	1979	1985	18-8802-1
AQ260A	8	Mallory (Flat Cap)	1979	1985	18-8823-1
AQ260B	8	Mallory (Tail Cap)	1985	1986	18-8802-1
AQ271A, B, C, D	8	Volvo	1986	1989	18-8802-1
AQ280A	8	Mallory (Tail Cap)	1978	1979	18-8802-1
AQ280A	8	Mallory (Flat Cap)	1978	1979	18-8823-1
AQ290A	8	Mallory (Tail Cap)	1979	1985	18-8802-1
AQ290A	8	Mallory (Flat Cap)	1979	1985	18-8823-1
AQ311A, B	8	Volvo	1986	1989	18-8802-1
BB140A	4	Volvo	1975	1979	18-8813-1
BB145A	4	Volvo	1979	1985	18-8813-1
BB225A, AV, B, C	8	Volvo	1979	1977	18-8802-1
BB231A	8	Volvo	1987	1987	18-8802-1
BB260A, AV, B, C	8	Volvo	1978	1985	18-8802-1
BB261A	8	Volvo	1988	1989	18-8802-1
230A, B	4	Volvo	1989	1992	18-8813-1
250A, B	4	Volvo	1989	1992	18-8813-1
432A	6	Delco EST	1992	1993	18-8835-1
434A	6	Delco EST	1992	1993	18-8835-1
3.0GLM	4	Delco EST	1993	1994	18-8833-1
3.0GLM	4	Delco EST	2002	2004	18-8833-1
3.0GLP	4	Delco EST	2002	2010	18-8833-1
3.0GSM	4	Delco EST	1994	2002	18-8833-1
3.0GSP	4	Delco EST	1993	2002	18-8833-1
3.0GXI	4	Delco EST	2008	2009	18-8833-1
4.3GI	6	Delco EST	1994	2000	18-8835-1
4.3GL	6	Delco EST	1993	2010	18-8835-1
4.3GS	6	Delco EST	1993	1999	18-8835-1
4.3GXI	6	Delco HVS	2001	2015	18-8829-1
4.3GXI	6	Delco EST	2001	2002	18-8835-1
4.3GXIE	6	Delco HVS	2009	2015	18-8829-1

VOLVO CONTINUED ON NEXT PAGE

PLUG WIRE SET APPLICATION CHARTS (Cont.)

VOLVO

Model	Cyl.	Distributor	Year Start	Year End	Plug Wire Set
4.3SI	6	Delco HVS	2001	2009	18-8829-1
4.3SI-BF	6	Delco HVS	2001	2002	18-8829-1
5.0FI	8	Ford	1994	1996	18-8820-1
5.0FL	8	Prestolite	1994	1996	18-8802-1
5.0GI	8	Delco EST	1997	2000	18-8836-1
5.0GL	8	Prestolite	1997	2001	18-8802-1
5.0GL	8	Delco EST	2001	2006	18-8836-1
5.0GXI	8	Delco HVS	2001	2015	18-8828-1
5.0GXIA	8	Delco EST	2001	2002	18-8836-1
5.0GXIC	8	Delco HVS	2007	2009	18-8828-1
5.0GXIE	8	Delco HVS	2007	2015	18-8828-1
5.0OSI	8	Delco HVS	2001	2009	18-8828-1
5.0OSIE	8	Delco HVS	2008	2009	18-8828-1
5.7GI	8	Delco EST	1993	1997	18-8836-1
5.7Gi	8	Delco HVS	2001	2015	18-8828-1
5.7GI	8	Delco EST	2004	2005	18-8836-1
5.7GIC	8	Delco HVS	2008	2009	18-8828-1
5.7GICE	8	Delco HVS	2008	2009	18-8828-1
5.7GIE	8	Delco HVS	2007	2015	18-8828-1
5.7GIL	8	Delco HVS	2002	2009	18-8828-1
5.7GIL-A	8	Delco EST	2001	2001	18-8836-1
5.7GL	8	Prestolite	1993	1997	18-8802-1
5.7GL	8	Delco EST	1993	1997	18-8836-1
5.7GL	8	Delco EST	2001	2004	18-8836-1
5.7GL-A	8	Mallory	2001	2001	18-8802-1
5.7GSI	8	Delco EST	1996	2001	18-8836-1
5.7GSP	8	Prestolite	1996	2000	18-8802-1
5.7GXI	8	Delco HVS	2001	2015	18-8828-1
5.7GXIA, B	8	Delco EST	2000	2002	18-8836-1
5.7GXIC	8	Delco HVS	2007	2008	18-8828-1
5.7GXICE	8	Delco HVS	2007	2010	18-8828-1
5.7GXIE	8	Delco HVS	2007	2015	18-8828-1
5.7GXIL	8	Delco HVS	2001	2008	18-8828-1
5.7GXIL-A, B	8	Delco EST	2000	2002	18-8836-1
5.7OSI	8	Delco HVS	2001	2009	18-8828-1
5.7OSIE	8	Delco HVS	2008	2009	18-8828-1
5.7OSXI	8	Delco HVS	2001	2009	18-8828-1
5.7OSXIE	8	Delco HVS	2008	2009	18-8828-1
5.8FI	8	Ford	1994	1996	18-8820-1
5.8FL	8	Prestolite	1994	1996	18-8803-1
5.8FSI	8	Prestolite	1994	1996	18-8803-1
7.4GI	8	Delco EST	1994	2000	18-8836-1
7.4GL	8	Prestolite	1993	1997	18-8802-1
7.4GLI	8	Prestolite	1993	1996	18-8802-1
7.4GLP	8	Prestolite	1993	1997	18-8802-1
7.4GLP	8	Prestolite	1994	1997	18-28051
7.4GLP	8	Delco EST	1995	1996	18-8836-1
7.4GSI	8	Delco EST	1994	2000	18-8836-1
8.1GI-A	8	Distributorless	1998	2015	18-8838-1
8.1GIC	8	Distributorless	2007	2015	18-8838-1
8.1GICE	8	Distributorless	2007	2015	18-8838-1
8.1GIE	8	Distributorless	2007	2015	18-8838-1
8.1GIL	8	Distributorless	2000	2008	18-8838-1

VOLVO CONTINUED ON NEXT PAGE

PLUG WIRE SET APPLICATION CHARTS (Cont.)

VOLVO					
Model	Cyl.	Distributor	Year Start	Year End	Plug Wire Set
8.1GSI	8	Distributorless	2000	2001	18-8838-1
8.1GXi	8	Distributorless	2001	2015	18-8838-1
8.1GXIE	8	Distributorless	2007	2015	18-8838-1
8.1GXil	8	Distributorless	2001	2008	18-8838-1
8.1IPSC-E	8	Distributorless	2008	2015	18-8838-1
8.1OSI	8	Distributorless	2003	2009	18-8838-1
8.1OSIE	8	Distributorless	2008	2009	18-8838-1
8.2GLJ	8	Prestolite	1993	1994	18-8803-1
8.2GLP	8	Prestolite	1993	1994	18-8803-1
8.2GSI	8	Delco EST	1995	2000	18-8836-1
DPX375	8	Distributorless	2000	2002	18-8838-1
DPX385	8	Delco EST	1996	2000	18-8836-1
DPX415	8	Delco EST	1996	2000	18-8836-1
DPX420	8	Distributorless	2000	2002	18-8838-1
V6-200	6	Delco HVS	2012	2015	18-8829-1
V6-225	6	Delco HVS	2012	2015	18-8829-1
V6-270	8	Delco HVS	2012	2015	18-8828-1
V8-300	8	Delco HVS	2012	2015	18-8828-1
V8-320	8	Delco HVS	2012	2015	18-8828-1

YAMAHA STERNDRIVE					
Model	Cyl.	Distributor	Year Start	Year End	Plug Wire Set
3.0L	4	Delco EST	1990	1993	18-8835-1
4.3L	6	YEMS	1989	1989	18-8835-1
4.3L	6	Delco EST	1990	1990	18-8835-1
5.0L	8	YEMS	1989	1989	18-8836-1
5.7L	8	Delco EST	1989	1990	18-8836-1
7.4L	8	Delco EST	1992	1992	18-8836-1



OIL FILTERS

Sierra oil filters are engineered with premium grade materials that will not only withstand but excel in the extreme environment of the Marine world. Sierra ensures the excellent performance of their filters by:

- Epoxy coating all canisters for corrosion resistance.
- Using a heavy-wall steel canister for further corrosion protection.
- Using high-efficiency filter media that meets or exceeds the OE's filtration.
- Backed by Sierra's industry leading warranty.

DIESEL OIL FILTERS



18-0032
Replaces:
Volvo 847741



18-0033
Replaces:
Volvo 21707133



18-0034
Replaces:
Volvo 477556



18-0035
Replaces:
Volvo 3582732
Full Flow



18-0036
Replaces:
Volvo 3582733
Bypass



18-7871
Replaces:
Mercurator 35-805809



18-7880
Replaces:
Caterpillar 1R-0658
Volvo-Perita 466634



***18-7884**
Replaces:
Jivvaxal 299381
Volvo-Perita 834337
Thread Spec: 3/4" x 16NPT



***18-7886**
Replaces:
Perkins 2654403
Thread Spec: 3/4" x 16NPT



***18-7910-1**
Replaces:
Westerbeke 30220
Yanmar 124450-35100, 119350-35151,
119350-35150
Thread Spec: 20mm x 1.5



***18-7917**
Replaces:
Yanmar 124450-35110, 124550-35110,
171056-35110, 171056-35111, 124085-35113
Thread Spec: 20mm x 1.5



***18-7925**
Replaces:
Westerbeke 21235
Thread Spec: 3/4" x 16NPT



***18-7926**
Replaces:
Volvo 423135, 4785974
Thread Spec: 1" x 12NPT











18-7927
Replaces:
Caterpillar 1R-0714
Thread Spec: 1 1/8" x 16NPT







* Anti-Drain-Back Valve

Valve eliminates dry starts, prevents oil from draining back into crankcase during engine shutdown.

STERNDRIVE & INBOARD OIL FILTERS

 <p>*18-7824-2 Short GM Replaces: Chris-Craft 16.81-08746 Cruisair 201104 Indmar 50-1001 Mercruiser 35-802885Q, 32716, 866340Q02, Q03, 866340K01, Mercruiser Vazer, 35-866340Q02, 35-866340K01, 35-866340Q, 52731A1, 52731, 52022, 32717, 14957 OMC 173232, 778864 Pleasurecraft R077002 Valve-Penta 835440 Yamaha YSC-10231-20-0C Thread Spec: 13/16" x 16NPT</p>	 <p>*18-7875 Long Ford Replaces: Chris-Craft 16.81-06536 Chrysler 1851658, 56874, F724002 Cruisair 9002514 Mercruiser 60565, 35-802886Q OMC 173231, 502900 Pleasurecraft R077001 Yamaha YSC-16231-20-0C Thread Spec: 3/4" x 16NPT</p>	 <p>*18-7876-1 Long GM Replaces: Mercruiser 35-866340Q03, 35-866340Q02, 52731, 52731A1, 54111, 35-802885Q, 14957, 52022, 32717, 32716 OMC 173233, 502901 Volvo 3860559 Yamaha YSC-14231-20-0C Thread Spec: 13/16" x 16NPT</p>	 <p>*18-7878-1 Short Ford Replaces: Chrysler 3549957, L-19, L-1008 Mercruiser 803470, 46692, 38463 OMC 502904 Volvo 430143, 1266286, 3517857 Thread Spec: 3/4" x 16NPT</p>
 <p>*18-7879-1 V-6 GM Replaces: Chrysler L-319 Mercruiser 35-802884Q, 41815, 35-883702Q, K OMC 173834, 502903 Volvo 841750 Thread Spec: 18mm x 1.5</p>	 <p>18-57824 Replaces: Ibmor MV8V1021 Fits: Mastercraft and Ibmor V8 GM New LS Series SB engines (Remote Mount)</p>	 <p>18-8779 Replaces: Ibmor 872025 Fits: 6.2L Ford Engines 2015-2016</p>	 <p>18-57702 CRANKCASE FILTER Replaces: 876069 Fits: Volvo MD30A, TMD30A, TAMD30A, MD31A, TMD31A, TAMD31A, MD40A, TMD40A, TMD40B, TAMD40A, TAMD40B, TMD41A, TAMD41A</p>

4-CYCLE OUTBOARD OIL FILTERS

 <p>18-7758 Replaces: Mercury 35-877761K01, 35-877761Q01 Thread Spec: 22mm x 1.5</p>	 <p>*18-7895 Replaces: Johnson/Evinrude 778888, 5035703 Suzuki 16510-93J00 Thread Spec: 3/4" x 16NPT</p>	 <p>*18-7896 Replaces: Johnson/Evinrude 778888, 5033539 Suzuki 16510-61A20-MHL Thread Spec: 3/4" x 16NPT</p>
 <p>*18-7897 Replaces: Johnson/Evinrude 778887, 5033919 Suzuki 16510-82703 Thread Spec: 3/4" x 16NPT</p>	 <p>18-7901 Replaces: Mercury 825467A1, 825467T1 Yamaha 6G8-13440-00-00</p>	 <p>*18-7902 Replaces: Yamaha 3FV-13440-20-00, 3FV-13440-00-00 Thread Spec: 20mm x 1.5</p>

* Anti-Drain-Back Valve
Valve eliminates dry starts, prevents oil from draining back into crankcase during engine shutdown.



18-7903

Replaces:

Johnson/Evinrude 5033102, 763364
Suzuki 16510-05240



***18-7905-1**

Replaces:

Suzuki 16510-96J00
Thread Spec: 20mm x 1.5



***18-7906-1**

Replaces:

Yamaha 69J-13440-00-00, 69J-13440-01-00
Mercury 35-822626T7, 35-822626Q15, 35-822626T
Thread Spec: 3/4" x 16NPT



***18-7909**

Replaces:

Honda 15400-POH-305PE,
15400-POH-305, 15400-ZJI-004,
15400-PLM-A01PE

Thread Spec: 20mm x 1.5



***18-7911-1**

Replaces:

Honda 15400-PFB-007
Nissan 3R0-07615-0
Yamaha 5GH-13440-00-00
Thread Spec: 20mm x 1.5



***18-7913**

Replaces:

Honda 15400-PFB-014
Mercury 35-822626Q1, Q03
Thread Spec: 20mm x 1.5



***18-7914**

Replaces:

Mercury 35-822626Q2, 35-822626Q04,
35-877768K01, 35-822626K04, 35-822626T2,
35-8M0064104, 35-8M0008397

Thread Spec: 20mm x 1.5



***18-7915-1**

Replaces:

Johnson/Evinrude 778885, 5031411
Suzuki 16510-87J00

Thread Spec: 3/4" x 16NPT



***18-7916**

Replaces:

Johnson/Evinrude 434839
Thread Spec: 3/4" x 16NPT



***18-7918**

Replaces:

Mercury 35-883701K01, 35-877769K01

Thread Spec: 24mm x 1.5



***18-7921**

Replaces:

Mercury 35-896546T, 35-877767K01

Thread Spec: 24mm x 1.5



***18-7954**

Replaces: Yamaha N26-13440-02-00,
N26-13440-00-00

Fits: F350
Thread Spec: 3/4" x 16NPT



18-7974

Replaces:

Volvo 3827069
Thread Spec: 18mm x 1.5



18-8003-1

Replaces:

Volvo 8692305



18-8700

OIL FILTER

Replaces: 5GH-13440-50-00,
5GH-13440-20, 5JW-13400-00-00,
2MB-E3440-00-00, 1WD-E3440-00-00
Fits: F15(2006-12), F20(2006-12),
F25(2009-12), F40(2008-12), F50(2005-12),
F60(2005-12), F70(2010-12), T25(2009-12),
T50(2005-12), T60(2005-12)



18-8870

OIL FILTER

Replaces: Suzuki 16510-45H10
Fits: F9.9 Type T/TH(SN 110001 & Newer),
F15(SN 110001 & Newer)

* Anti-Drain-Back Valve

Valve eliminates dry starts, prevents oil from draining back into crankcase during engine shutdown.

OIL & LUBRICANT DISPLAY RACK

Generate incremental sales by selling high-margin oil and lubricant products from Sierra. Create exciting displays and rotate products frequently, using this quality fixture that helps sell the products for you.

This gleaming, black metal display with heavy-duty casters and high impact graphics works to make a powerful impression. Comes complete with 4 high-tech metal shelves, heavy-duty casters and custom graphics.

DIMENSIONS:

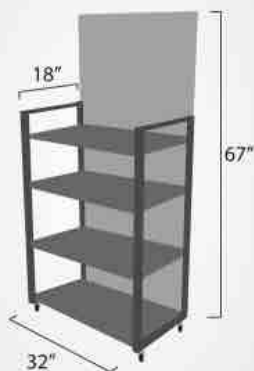

PART NO. 18-9490-1

(RACK ONLY • DOES NOT INCLUDE PRODUCT)



OIL

TC-W3



Sierra TC-W3 is a high performance lubricant that has been manufactured and designed to meet and exceed all (Domestic & Import) engine manufacturers warranties. Exceeds JASO, ISO, API and NMMA, for advanced generation 2-cycle lubricants.

- Ideal for oil injection systems or pre-mix applications.
- Significantly reduced aquatic toxicity to fish compared to other outboard oils on the market today.
- Reduces ring sticking, deposit formation and exhaust port blockage. Less friction allowing for easier starting.
- Formulated to improve performance and extend engine life by reducing wear on critical engine components.
- Ideal for today's high horsepower outboards that demand maximum performance.
- Excellent performance with lower quality fuels.
- Exceeds the industry standards established in 1997.
- Guaranteed and backed by our famous Sierra comprehensive warranty. (Will not void your engine manufacturer's warranty)



OUTBOARD 4-CYCLE OIL DISPLAY

18-9495
Display Only



2-STROKE OIL MIXING BOTTLE

Re-usable bottle for precise measuring of oil to fuel ratio for your engine.

18-9798
32 FL. OZ bottle

PREMIUM BLEND TC-W3	
Part No.	Description
18-9500-1	Pint (12 per case) (473ml)
18-9500-1P	84 case pallet (Pt.) 12 per case
18-9500-2	Quart (12 per case) (946ml)
18-9500-2P	84 case pallet (Qt.)
18-9500-3	Gallon (6 per case) (3.78L)
18-9500-3P	36 case pallet (Ga.)
18-9500-4	2.5 Gallon (2 per case) (9.46L)
18-9500-4P	42 case pallet (2.5 Ga.)
18-9500-6	18 Gallons (50.57L)
18-9500-7	55 Gallons (208L)
18-9500-7P	4 - 55 Gallon drum pallet

TC-W3 DISPLAY	
Part No.	Description
18-9499	Corrugated display with graphics. One case of quart bottles (18-9500-2), one case of gallon bottles (18-9500-3).
18-9494	Display Only

DIRECT INJECTION, TC-W3			
Part No.	Description	OE	OE No.
18-9530-3	Gallon (3.78L)	Mercury Optimax Yamaha HPDI BRP Ficht, DI E-TEC XD-50	92-858037K01 LUB-2STRK-M1-4 784354
18-9530-3P	36 Case Pallet (Gal)		
18-9530-4	2.5 Gallon (2 per case) (9.46L)	Mercury Optimax Yamaha HPDI BRP Ficht, DI E-TEC XD-50	
18-9530-4P	36 Case Pallet (2.5 Gal)	Mercury Optimax Yamaha HPDI BRP Ficht, DI E-TEC XD-50	
18-9530-6	18 Gallon (61L)		
18-9530-7	55 Gallon Drum	Mercury Optimax Yamaha HPDI BRP Ficht, DI E-TEC XD-50	92-858039K01 LUB-2STRK-M1-55 777228
18-9530-7P	4 - 55 Gal. Drum Pallet		

FULL SYNTHETIC TC-W3 2-STROKE OUTBOARD			
Part No.	Description	OE	OE No.
18-9540-2	Quart (964ml)	BRP E-Tec/Universal E-TEC XD-100	—
18-9540-3	Gallon (3.78L)	BRP E-Tec/Universal E-TEC XD-100	784357
18-9540-3P	36 Case Pallet (Gal)		
18-9540-7	55 Gal. Drum	BRP E-Tec/Universal E-TEC XD-100	777120

20W-40 FC-W 4-STROKE MINERAL OUTBOARD ENGINE OIL

20W-40 FC-W 4-STROKE MINERAL OUTBOARD ENGINE OIL

- Formulated to protect your engine in the most demanding marine conditions.
- Developed to replace the 10W-30 in warmer climates.
- Meets or exceeds OE specifications for Outboard Oil.
- Advanced additive package to prevent rust and corrosion, breakdown under high RPM and maximum load conditions.



20W40 FC-W 4-STROKE MINERAL OUTBOARD ENGINE OIL			
Part No.	Yamaha No.	Description	Case Qty.
18-9450-2	LUB-20W40-FC-12	Quart (946ml)	12

25W-50 FC-W SEMI-SYNTHETIC MARINE ENGINE OIL**25W-50 FC-W MARINE ENGINE OIL**

- For use in supercharged Mercury Verado.
- Offered in liter, 4 liter and 16 gallon containers.
- Semi-Synthetic formulation for superior protection under high loads and operating stress.
- NMMA FC-W@ Certified/API-SL.

25W-50 FC-W SEMI-SYNTHETIC OIL			
Part No.	Mercury No.	Description	Case Qty.
18-9552-3	92-858084K01	4 Liter (4.2224 qt.)	6
18-9552-8	—	1 Liter (1.0556 qt.)	12

**10W-40 FC-W SEMI-SYNTHETIC MARINE ENGINE OIL****10W-40 FC-W SEMI-SYNTHETIC ENGINE OIL**

- Direct Suzuki replacement oil.
- Semi-Synthetic formulation for superior protection under high loads and operating stress.
- Offered in quart, gallon, 16 gallon and 55 gallon drums.
- NMMA FC-W@ Certified/API-SL.

10W-40 FC-W SEMI-SYNTHETIC OIL			
Part No.	Suzuki No.	Description	Case Qty.
18-9551-2	990C0-10W40-1QT	Quart (948ml)	12
18-9551-3	990C0-10W40-1GL	Gallon (3.785L)	6
18-9551-6	—	16 Gallon (61L)	—
18-9551-7	—	55 Gallon (208L)	—

**15W-40 DIESEL ENGINE OIL****15W-40 DIESEL ENGINE OIL**

- Meets the following manufactures specifications: Volvo VDS-3; Cummins CES20078, CES20077, CES20076; Detroit Diesel DDC93D214; CAT ECF-2, ECF-1; Global DHD-1.
- Increased detergency to fight soot and carbon deposits.
- Certified to API CI-4+ Rating. Meets the highest standards of diesel oil in the marine industry.

15W-40 DIESEL ENGINE OIL				
Part No.	Mercury No.	Volvo No.	Description	Case Qty.
18-9553-2	—	40005011	Quart (948ml)	12
18-9553-3	—	40005012	Gallon (3.785L)	6
18-9553-5	—	40005013	5 Gallon (18.95L)	—
18-9553-6	—	—	16 Gallon (61L)	—
18-9553-7	—	40005014	55 Gallon (208L)	—



10W-30 FC-W 4-STROKE MARINE OUTBOARD ENGINE OIL

10W-30 4-STROKE MARINE OUTBOARD ENGINE OIL is a highly refined petroleum product formulated with premium base stock and highly refined additives. Specifically formulated to meet or exceed the tough requirements of the Marine 4-Stroke motor manufacturers, Mercury, Yamaha, Johnson-Evinrude, Suzuki and Honda.

- Excellent anti-wear characteristics
- Reduces friction
- Formulated to offer maximum corrosion protection
- Reduces sludge keeps engine cleaner for better efficiency
- Low temperature viscosity offers better cold starting
- Meets and exceeds quality performance API SJ, CF-2, CH-4, NMMA FC-W® Certified

10W30 FC-W MARINE OUTBOARD ENGINE OIL

Part No.	Mercury No.	Description	Case Qty.
18-9420-2	92-802833Q1	Quart (946ml)	12
18-9420-2P	92-802833Q1	84 Case Pallet (Qt.)	12
18-9420-3	92-802835Q1	Gallon (3.785L)	6
18-9420-3P	92-802835Q1	36 Case Pallet (Gal.)	6
18-9420-30	92-802835Q1	30 Gallon (113.6L)	
18-9420-30P	92-802835Q1	30 Gallon (Pallet)	5 / Pallet
18-9420-7	92-802836A1	55 Gallon (208L)	
18-9420-7P	92-802836A1	55 Gallon (Pallet)	4 / Pallet



25W-40 FC-W 4-STROKE MARINE STERN DRIVE ENGINE OIL

25W-40 4-STROKE MARINE STERN DRIVE ENGINE OIL has been formulated to provide excellent lubrication and corrosion protection. Stern drive and inboard engines operate under high load and running stresses. This product is developed for the marine environment and will out perform standard 4-cycle automotive engine oils. Sierra's 25W-40 oil offers excellent detergency, anti-oxidants, antiwear, and corrosion protection. The benefits to your engine are reduced wear to the internal components, protection of internal parts from corrosion, cleaner pistons, and prevention of ring sticking. Excellent low temperature operating properties. Meets or exceeds quality performance API SJ, CF-4, CH-4. **Recommended for use in Mercruiser and OMC.**

- NMMA FC-W® Certified

25W40 FC-W 4-STROKE STERN DRIVE ENGINE OIL

Part No.	Mercruiser No.	Description	Case Qty.
18-9400-2	92-802837Q1	Quart (946ml)	12
18-9400-2P	92-802837Q1	84 Case Pallet (Qt.)	12
18-9400-30		30 Gallon (113.6L)	
18-9400-30P		30 Gallon (Pallet)	5 / Pallet
18-9400-4	92-857389A1	5 Quart (4.7 L)	4
18-9400-4P	92-857389A1	36 Case Pallet (5 Qt.)	4
18-9400-7	92-802841A1	55 Gallon (208L)	
18-9400-7P	92-802841A1	55 Gallon (Pallet)	4 / Pallet



25W40 FC-W SYNTHETIC BLEND ENGINE OIL

This 4-cycle oil is blended with premium grade synthetic and mineral based stock combined with superior designed additives formulated for the stress endured by sterndrive and inboard engines.

- Superior corrosion protection
- Advanced lubrication for reduction of wear to internal engine components.
- Outstanding friction reduction and wear protection.
- Removes thermal breakdown under high RPM's, extreme temperatures and loads.
- Extensively tested for outstanding performance.
- NMMA FC-W® Certified/API-SL.

25W40 FC-W SYNTHETIC BLEND MERCURUISER STERNDRIVE ENGINE OIL

Part No.	Mercruiser No.	Description	Case Qty.
18-9440-2	92-883724KD1	Quart (946ml)	12
18-9440-2P	92-883724KD1	84 Case Pallet (Qt.)	12
18-9440-4	92-883725K01	5 Quart (4.7 L)	4
18-9440-4P	92-883725K01	36 Case Pallet (5 Qt.)	4
18-9440-7	92-858057KD1	55 Gallon (208L)	
18-9440-7P	92-858057KD1	55 Gallon (Pallet)	4 / Pallet



25W40 FC-W SYNTHETIC BLEND 4-STROKE OUTBOARD OIL

This oil is blended with premium grade synthetic and mineral based stock combined with superior designed additives formulated for the extreme rigors of the marine environment.

- Superior corrosion protection.
- Advanced lubrication for reduction of wear to internal engine components.
- Minimized piston ring deposits.
- Extensively tested for outstanding performance.
- NMMA FC-W® Certified/API-SL.



SYNTHETIC BLEND 4-STROKE OUTBOARD OIL 25W40

Part No.	Mercury No.	Description	Case Qty.
18-9440-3	92-983723K01	4 Liter (4.2224 qt.)	6
18-9440-8	92-983722K01	1 Liter (1.0556 qt.)	12

SAE 30 FULL SYNTHETIC MARINE ENGINE OIL

A special blend of synthetic base oil and a balanced additive system that exceeds the FC-W requirements for marine engine oil.

- Recommended for gasoline and diesel inboard and sterndrive engines.
- Superior engine protection during startups, operation and storage.
- Reduces friction and wear for extended engine life.
- Longer lubrication effectiveness than mineral oils.
- Reduces oil consumption and improves fuel economy.
- API-CF/SL.



FULL SYNTHETIC ENGINE OIL SAE 30

Part No.	Volvo No.	Description	Case Qty.
18-9410-2	3842343	1 Quart (946ml)	12
18-9410-4	3842344*	5 Quarts (4.7L)	4
18-9410-7	3858061	55 Gallon (208L)	

* Convenient 5 qt Container

SYNTHETIC OIL 10W30 FC-W

Formulated specifically for 4-stroke outboard and sterndrive engine technology. A special blend of synthetic base oil and a balanced additive system that exceeds the FC-W requirements for marine engine oils. Recommended for use in both outboard and sterndrive applications. Offers faster lubrication at start up in low temperatures, excellent protection at high temperatures, and greater resistance to oxidation for lower oil consumption.

- NMMA FC-W® Certified/API-SL.



10W30 SYNTHETIC MARINE ENGINE LUBRICANT

Part No.	Volvo No.	Description	Case Qty.
18-9690-2	—	1 Quart (946ml)	12
18-9690-3	—	1 Gallon	6

NMMA FC-W Certified for use in 4 stroke OB and stern drive applications

15W-40 HEAVY DUTY ENGINE OIL

This oil is specifically formulated for the heavy duty inboard marine market, including cruisers and towboats calling for a 15W-40.

- Meets API Service classification up to CK-4.
- Meets the performance specifications for API service classification SM.
- Premium base stocks and additive package ingredients places Sierra Heavy Duty at the leading edge of lubrication technology.
- Suitable for fuels on any sulfur level
- Not for use in gasoline engines equipped with catalytic converters.
- Replaces: Shell Rotella T4, Delo 400, MerCruiser, Indmar, Pleasurecraft, Crusader, Volvo Penta, MasterCraft



15W40 MULTI-VEHICLE ENGINE OIL

Part No.	Indmar No.	Description	Case Qty.
18-9554-2	872005	Quart (946ml)	12
18-9554-4	872006 (7QT)	5 Quart (4.7L)	4
18-9554-5	-	5 Gallon (18.95L)	
18-9554-7	-	55 Gallon (208L)	

5W-30 SEMI-SYNTHETIC ENGINE OIL

Our 5W-30 Semi-Synthetic is an ultra-high performance engine oil that utilizes premium base stocks and industry leading additives.

- Meets and or exceeds FC-W Catalyst and FC-W specifications
- Proprietary additive package
 - Enhanced detergent package to suspend and prevent sludge.
 - Reduces friction to maintain high performance
 - Prevents thermal and oxidation break down under extreme temperatures
 - High shear stability maintains viscosity to prevent excessive thinning in high performance applications
 - Advanced ZDDP additive technology prevents phosphorus depletion extending catalyst life while maintaining anti-wear protections.
- Meets or exceeds API SM category requirements
- Replaces: Honda, Indmar, Ilmor, PCM



5W-30 SEMI-SYNTHETIC FC-WCAT

Part No.	Indmar No.	Description	Case Qty.
18-9555-2	872003	Quart (946ml)	12
18-9555-4	872004 (7QT)	5 Quart (4.7L)	4
18-9555-7	-	55 Gallon (208L)	

5W-30 FULL SYNTHETIC ENGINE OIL

A full synthetic 5W-30 is an ultra-high engine performance oil that utilizes premium base stocks and industry leading additives.

- Meets and or exceeds FC-W Catalyst and FC-W specifications
- Proprietary additive package
 - Enhanced detergent package to suspend and prevent sludge.
 - Reduces friction to maintain high performance
 - Prevents thermal and oxidation break down under extreme temperatures
 - High shear stability maintains viscosity to prevent excessive thinning in high performance applications
 - Advanced ZDDP additive technology prevents phosphorus depletion extending catalyst life while maintaining anti-wear protections.
- Meets or exceeds API SM category requirements
- Replaces: Yamalube, MerCruiser, Indmar, Mobile 1, Ilmor, Indmar, PCM, MasterCraft



5W-30 FULL SYNTHETIC FC-WCAT

Part No.	Ilmor/MasterCraft	Description	Case Qty.
18-9558-2	550022889	Quart (946ml)	12
18-9558-4	550046126	5 Quart (4.7L)	4
18-9558-7	-	55 Gallon (208L)	

25W-40 CATALYST ENGINE OIL

These oils have been specifically designed to meet the unique requirements of modern 4-stroke recreational engines with or without emission catalyst systems.

- Approved for all 4-Stroke applications including Outboard, Sterndrive and Inboard. Exceeds all 4-Stroke requirements including FC-W and FC-W Cat Compatible.
- Formulated to offer maximum corrosion protection.
- Advanced lubrication for extended engine life and wear protection.
- Capitalizing "ZDDP" anti-wear additive technology to prevent phosphorus depletion and extend the emission catalyst life.
- NMMA FC-W® Certified.

25W40 CATALYST OIL			
Part No.	Mercury No.	Description	Case Qty.
18-9400CAT-2	92-8M0078627	1 Quart (946ml)	12
18-9400CAT-2P	92-8M0078627	84 Case Pallet (Qt.)	12
18-9400CAT-4	—	5 Quart (4.7 L)	4
18-9400CAT-4P	—	36 Case Pallet (5 Qt.)	4
18-9400CAT-7	92-8M0078621	55 Gallon (208L)	
18-9400CAT-7P	92-8M0078621	55 Gallon (Pallet)	4 / Pallet



10W-30 CATALYST ENGINE OIL

Our NMMA FC-W Catalyst Compatible Engine Oils have been specifically designed to meet the unique requirements of modern 4-stroke recreational engines with or without emission catalyst systems.

- Approved for all 4-Stroke applications including Outboard, Sterndrive and Inboard and exceeds all 4-Stroke requirements including FC-W and FC-W Cat Compatible.
- Provides superior corrosion protection under extreme conditions.
- Industry leading wear protection and deposit control.
- Capitalizing on "ZDDP" anti-wear additive technology to prevent phosphorus depletion and extend the emission catalyst life.
- NMMA FC-W® Certified

10W30 CATALYST OIL			
Part No.	Mercury No.	Description	Case Qty.
18-9420CAT-2	92-8M0078625	Quart (946ml)	12
18-9420CAT-2P	92-8M0078625	84 Case Pallet (Qt.)	12
18-9420CAT-3	92-8M0078626	Gallon	6
18-9420CAT-3P	92-8M0078626	36 Case Pallet (Gal.)	6
18-9420CAT-7	92-8M0078618	55 Gallon (208L)	
18-9420CAT-7P	92-8M0078618	55 Gallon (Pallet)	4 / Pallet



25W-40 SYNTHETIC CATALYST ENGINE OIL

A special blend specifically designed to meet the unique requirements of modern 4-stroke recreational engines with or without emission catalyst systems.

- Minimizes corrosion that is formed inside the engine.
- Displays enhanced detergent and dispersants properties to suspend and prevent engine sludge formation.
- Industry leading wear protection and deposit control.
- Prevents excessive thinning under extreme performance operations.
- Capitalizing on "ZDDP" anti-wear additive technology to prevent phosphorus depletion and extend the emission catalyst life.
- NMMA FC-W® Certified/API-SL.

25W40 SYNTHETIC CATALYST OIL			
Part No.	Mercury No.	Description	Case Qty.
18-9440CAT-2	92-8M0078629	Quart (946ml)	12
18-9440CAT-2P	92-8M0078629	84 Case Pallet (Qt.)	12
18-9440CAT-4	—	5 Quart (4.7 L)	4
18-9440CAT-4P	—	36 Case Pallet (5 Qt.)	4
18-9440CAT-7	92-8M0078624	55 Gallon (208L)	
18-9440CAT-7P	92-8M0078624	55 Gallon (Pallet)	4 / Pallet



See OE Cross Reference Chart on Page 210

SIERRA OIL CROSS-REFERENCE CHARTS

PREMIUM BLEND TC-W3

Part No.	Description
18-9500-1	Pint (12 per case) (473ml)
18-9500-1P	84 case pallet (Pt.) 12 per case
18-9500-2	Quart (12 per case) (946ml)
18-9500-2P	84 case pallet (Qt.)
18-9500-3	Gallon (6 per case) (3.78L)
18-9500-3P	36 case pallet (Ga.)
18-9500-4	2.5 Gallon (2 per case) (9.46L)
18-9500-4P	42 case pallet (2.5 Ga.)
18-9500-6	16 Gallons (60.57L)
18-9500-7	55 Gallons (208L)
18-9500-7P	4 - 55 Gallon drum pallet

DIRECT INJECTION, TC-W3

Part No.	Description	OE	OE No.
18-9530-3	Gallon (3.78L)	Mercury Optimax Yamaha HPDI BRP Ficht, DI E-TEC XD-50	92-858037K01 LUB-2STRK-M1-4 764354
18-9530-3P	36 Case Pallet (Gal)		
18-9530-4	2.5 Gallon (2 per case) (9.46L)	Mercury Optimax Yamaha HPDI BRP Ficht, DI E-TEC XD-50	
18-9530-6	16 Gallon (61L)		
18-9530-7	55 Gallon Drum	Mercury Optimax Yamaha HPDI BRP Ficht, DI E-TEC XD-50	92-858039K01 LUB-2STRK-M1-55 777228
18-9530-7P	4 - 55 Gallon Drum Pallet		

FULL SYNTHETIC TC-W3 2-STROKE OUTBOARD

Part No.	Description	OE	OE No.
18-9540-2	Quart (946ml)	BRP E-Teo/Universal E-TEC XD-100	—
18-9540-3	Gallon (3.78L)	BRP E-Teo/Universal E-TEC XD-100	764357
18-9540-3P	36 Case Pallet (Gal)		
18-9540-7	55 Gal. Drum	BRP E-Teo/Universal E-TEC XD-100	777120

20W40 FC-W 4-STROKE MINERAL OUTBOARD OIL

Part No.	Yamaha No.	Description	Case Qty.
18-9450-2	LUB-20W40-FC-12	Quart (946ml)	12

25W-50 FC-W SEMI-SYNTHETIC OIL

Part No.	Mercury No.	Description	Case Qty.
18-9552-3	92-858084K01	4 Liter (4.2224 qt.)	6
18-9552-8	—	1 Liter (1.0556 qt.)	12

10W-40 FC-W SEMI-SYNTHETIC OIL

Part No.	Suzuki No.	Description	Case Qty.
18-9551-2	990C0-10W40-1QT	Quart (946ml)	12
18-9551-3	990C0-10W40-1GL	Gallon (3.785L)	6
18-9551-6	—	16 Gallon (61L)	
18-9551-7	—	55 Gallon (208L)	

15W-40 DIESEL ENGINE OIL

Part No.	Mercury No.	Volvo No.	Description	Case Qty.
18-9553-2	—	40005011	Quart (946ml)	12
18-9553-3	—	40005012	Gallon (3.785L)	6
18-9553-5	—	40005013	5 Gallon (18.95L)	
18-9553-6	—	—	16 Gallon (61L)	
18-9553-7	—	40005014	55 Gallon (208L)	

10W30 SYNTHETIC MARINE ENGINE LUBRICANT

Part No.	Volvo No.	Description	Case Qty.
18-9690-2	—	1 Quart (946ml)	12
18-9690-3	—	1 Gallon	6

NMMA FC-W Certified for use in 4 stroke OB and stern drive applications.

10W30 FC-W 4-STROKE OUTBOARD ENGINE OIL

Part No.	Mercury No.	Description	Case Qty.
18-9420-2	92-802833Q1	Quart (946ml)	12
18-9420-2P	92-802833Q1	84 Case Pallet (Qt.)	12
18-9420-3	92-802835Q1	Gallon (3.785L)	6
18-9420-3P	92-802835Q1	36 Case Pallet (Gal.)	6
18-9420-7	92-802836A1	55 Gallon (208L)	
18-9420-7P	92-802836A1	55 Gallon (Pallet)	4 / Pallet

25W40 FC-W 4-STROKE STERN DRIVE ENGINE OIL

Part No.	Mercuriser No.	Description	Case Qty.
18-9400-2	92-802837Q1	Quart (946ml)	12
18-9400-2P	92-802837Q1	84 Case Pallet (Qt.)	12
18-9400-30	—	30 Gallon (113.6L)	
18-9400-30P	—	30 Gallon (Pallet)	5 / Pallet
18-9400-4	92-857389A1	5 Quart (4.7 L)	4
18-9400-4P	92-857389A1	36 Case Pallet (5 Qt.)	4
18-9400-7	92-802841A1	55 Gallon (208L)	
18-9400-7P	92-802841A1	55 Gallon (Pallet)	4 / Pallet

25W40 FC-W SYNTHETIC BLEND MERCURISER STERNDRIVE OIL

Part No.	Mercuriser No.	Description	Case Qty.
18-9440-2	92-883724K01	Quart (946ml)	12
18-9440-2P	92-883724K01	84 Case Pallet (Qt.)	12
18-9440-4	92-883725K01	5 Quart (4.7 L)	4
18-9440-4P	92-883725K01	36 Case Pallet (5 Qt.)	4
18-9440-7	92-858057K01	55 Gallon (208L)	
18-9440-7P	92-858057K01	55 Gallon (Pallet)	4 / Pallet

FULL SYNTHETIC ENGINE OIL SAE 30

Part No.	Volvo No.	Description	Case Qty.
18-9410-2	3842343	1 Quart (946ml)	12
18-9410-4	3842344*	5 Quarts (4.7L)	4
18-9410-7	3858061	55 Gallon (208L)	

* Convenient 5 qt Container

25W40 FC-W SYNTHETIC BLEND 4-STROKE OUTBOARD OIL

Part No.	Mercury No.	Description	Case Qty.
18-9440-3	92-883723K01	4 Liter (4.2224 qt.)	6
18-9440-8	92-883722K01	1 Liter (1.0556 qt.)	12

25W40 CATALYST OIL

Part No.	Mercury No.	Description	Case Qty.
18-9400CAT-2	92-8M0078627	1 Quart (946ml)	12
18-9400CAT-2P	92-8M0078627	84 Case Pallet (Qt.)	12
18-9400CAT-4	—	5 Quart (4.7 L)	4
18-9400CAT-4P	—	36 Case Pallet (5 Qt.)	4
18-9400CAT-7	92-8M0078621	55 Gallon (208L)	
18-9400CAT-7P	92-8M0078621	55 Gallon (Pallet)	4 / Pallet

10W30 CATALYST OIL

Part No.	Mercury No.	Description	Case Qty.
18-9420CAT-2	92-8M0078625	Quart (946ml)	12
18-9420CAT-2P	92-8M0078625	84 Case Pallet (Qt.)	12
18-9420CAT-3	92-8M0078626	Gallon	6
18-9420CAT-3P	92-8M0078626	36 Case Pallet (Gal.)	6
18-9420CAT-7	92-8M0078618	55 Gallon (208L)	
18-9420CAT-7P	92-8M0078618	55 Gallon (Pallet)	4 / Pallet

25W40 SYNTHETIC CATALYST OIL

Part No.	Mercury No.	Description	Case Qty.
18-9440CAT-2	92-8M0078629	Quart (946ml)	12
18-9440CAT-2P	92-8M0078629	84 Case Pallet (Qt.)	12
18-9440CAT-4	—	5 Quart (4.7 L)	4
18-9440CAT-4P	—	36 Case Pallet (5 Qt.)	4
18-9440CAT-7	92-8M0078624	55 Gallon (208L)	
18-9440CAT-7P	92-8M0078624	55 Gallon (Pallet)	4 / Pallet

10W-40 FULL SYNTHETIC ATV/UTV ENGINE OIL

- Off Road Formulation- Suitable for ATV, UTV, & Dirt Bike Applications
- Meets API SM & JASO MA Specifications
- Designed for use in wet clutch applications
- Designed for use in liquid & air cooled engines
- Formulated with premium performance additives to prevent rusting prevalent in recreation due to their seasonal use
- Provides exceptional wear protection and deposit control for engine longevity

10W40 FULL SYNTHETIC ATV/UTV ENGINE OIL			
Part No.	OE CROSS	Description	Case Qty.
72-5100-2	Arctic Cat 0436-880 Honda HP4 Yamaha Yamalube Performance All Purpose 10W40	1 Quart (946ml)	12
72-5100-3	Arctic Cat 0436-879	1 Gallon (3.785L)	6
72-5100-7	—	55 Gallon drum (208L)	



0W-40 FULL SYNTHETIC ATV/UTV ENGINE OIL

- Off Road Formulation- Suitable for ATV, UTV, & Dirt Bike Applications
- To be used in extreme cold environments
- Meets API SM & JASO MA Specifications
- Designed for use in wet clutch applications
- Designed for use in liquid & air cooled engines
- Formulated with premium performance additives to prevent rusting prevalent in recreation vehicles due to their seasonal use
- Exceptional wear protection and deposit control for engine longevity

0W40 FULL SYNTHETIC ATV/UTV ENGINE OIL			
Part No.	OE CROSS	Description	Case Qty.
72-5101-2	Arctic Cat 1436-434 Can-Am XPS 779139	1 Quart (946ml)	12
72-5101-3	Arctic Cat 1436-435 Can-Am #779140	1 Gallon (3.785L)	6
72-5101-7	—	55 Gallon drum (208L)	



2-STROKE FULL SYNTHETIC ENGINE OIL MULTI-PURPOSE

- 2-Stroke Full Synthetic Oil with Ester Technology
- Designed for use in direct inject & pre-mix applications
- Multi-Use for many markets: ATV, UTV, PWC, Snowmobile, & Small Engines
- Meets JASO FD, ISO-L-EGD, & API TC 2-stroke performance standards

2-STROKE FULL SYNTHETIC MULTI-PURPOSE ENGINE OIL			
Part No.	OE CROSS	Description	Case Qty.
72-5103-2	Arctic Cat 4639-349 Honda HP2 Yamaha Yamalube All Performance Two Stroke Ski-Doo XPS 779126 Polaris VES Kawasaki K61021-208A	1 Quart (946ml)	12
72-5103-3	Arctic Cat 5639-469 Honda HP2 Yamaha Yamalube All Performance Two Stroke Ski-Doo 779127 Polaris VES	1 Gallon (3.785L)	6
72-5103-4	Honda HP2 Yamaha Yamalube All Performance Two Stroke Polaris VES	5 Gallon (18.95L)	
72-5103-5	Honda HP2, Polaris VES	16 Gallon (61L)	
72-5103-7	Honda HP2, Polaris VES	55 Gallon drum (208L)	



80W-90 SEMI-SYNTHETIC HYPOID GEAR OIL

- To be used in front/rear differentials
- Suitable for use in applications calling for an API GL-5 gear oil
- Formulated with premium performance additives that provide extreme pressure protection, anti-weld, anti-scuff and anti-wear properties

80W90 SEMI-SYNTHETIC HYPOID GEAR OIL			
Part No.	OE CROSS	Description	Case Qty.
72-5102-2	Arctic Cat 1438-159 Honda 08208-0080 Polaris Angle Drive Fluid	1 Quart (946ml)	12
72-5102-4	Arctic Cat 0436-901 Polaris Angle Drive Fluid	5 Gallon (18.95L)	
72-5102-5	Polaris Angle Drive Fluid	16 Gallon (61L)	
72-5102-7	Polaris Angle Drive Fluid	55 Gallon drum (208L)	



5W-50 FULL SYNTHETIC ENGINE OIL

- 5W-50 Full Synthetic Engine Oil
- Off Road Formulation- Suitable for ATV, UTV, & Dirt Bike Applications
- To be used in extreme cold environments
- Meets API SM & JASO MA Specifications
- Designed for use in wet clutch applications
- Designed for use in liquid & air cooled engines
- Formulated with premium performance additives to prevent rusting prevalent in recreation vehicles due to their seasonal use
- Exceptional wear protection and deposit control for engine longevity

5W50 FULL SYNTHETIC ENGINE OIL			
Part No.	OE CROSS	Description	Case Qty.
72-5104-2	Polaris PS-4	1 Quart (946ml)	12
72-5104-3	Polaris PS-4	1 Gallon (3.785L)	6
72-5104-7	Polaris PS-4	55 Gallon drum (208L)	



FOAM FILTER OIL

- Foam Filter Oil
- Dyed red for easy detecting during application
- Increases surface area of foam filter to trap small particles extending engine life
- Waterproof formula

FOAM FILTER OIL			
Part No.	OE CROSS	Description	Case Qty.
72-5105-2	—	1 Quart (946ml)	12
72-5105-3	—	1 gallon (3.785L)	6
72-5105-7	—	55 gallon drum (208L)	



POWERSPORTS OIL FULL PRODUCT LISTING

P/N	Description
72-5100-2	10W-40 Full Synthetic High Performance Engine Oil - QT
72-5100-3	10W-40 Full Synthetic High Performance Engine Oil - GAL
72-5100-7	10W-40 Full Synthetic High Performance Engine Oil - 55 - GAL
72-5101-2	0W-40 Full Synthetic High Performance Engine Oil - QT
72-5101-3	0W-40 Full Synthetic High Performance Engine Oil - GAL
72-5101-7	0W-40 Full Synthetic High Performance Engine Oil - 55 GAL
72-5102-2	80W-90 Semi-Synthetic High Performance Hypoid Gear Oil - QT
72-5102-4	80W-90 Semi-Synthetic High Performance Hypoid Gear Oil - 5 GAL
72-5102-5	80W-90 Semi-Synthetic High Performance Hypoid Gear Oil - 16 GAL
72-5102-7	80W-90 Semi-Synthetic High Performance Hypoid Gear Oil - 55 GAL
72-5103-2	2 Stroke Full Synthetic High Performance Engine Oil - QT

P/N	Description
72-5103-3	2 Stroke Full Synthetic High Performance Engine Oil - GAL
72-5103-4	2 Stroke Full Synthetic High Performance Engine Oil - 5 GAL
72-5103-5	2 Stroke Full Synthetic High Performance Engine Oil - 16 GAL
72-5103-7	2 Stroke Full Synthetic High Performance Engine Oil - 55 GAL
72-5104-2	5W-50 Full Synthetic High Performance Engine Oil - QT
72-5104-3	5W-50 Full Synthetic High Performance Engine Oil - GAL
72-5104-7	5W-50 Full Synthetic High Performance Engine Oil - 55 GAL
72-5105-2	Foam Filter Oil - QT
72-5105-3	Foam Filter Oil - GAL
72-5105-7	Foam Filter Oil - 55 GAL

EXTENDED LIFE COOLANT / ANTIFREEZE

Our Premium Blend Extended Life formula provides year-round protection against freezing and boil-over in all water-cooled engines. Protects for 2,500 hours or 5 years. Hybrid, nitrated HOAT/NOAT formula with ethylene glycol base is compatible with all other coolants.

The 50/50 is pre-mixed with deionized water; not intended to be diluted. This formula provides excellent metal protection and cavitation protection capabilities. Product color is clear red/orange.

EXTENDED LIFE COOLANT / ANTIFREEZE

Part No.	Mercury No.	Description
18-9320	—	1 Gallon (3.78L), Full Strength
18-9305	92-877770K1	55 Gallon (208L), 50/50 Pre-mixed



HEAVY DUTY EXTENDED LIFE COOLANT / ANTIFREEZE

The Heavy Duty Extended Life formula provides year-round protection against freezing and boil-over in all diesel engines. Protects for 15,000 hours or 7 years. Poly organic POAT formula with ethylene glycol base is compatible with all other coolants.

The 50/50 is pre-mixed with deionized water; not intended to be diluted. Provides excellent metal protection and cavitation protection capabilities. Product color is yellow.

HEAVY DUTY EXTENDED LIFE COOLANT / ANTIFREEZE

Part No.	Mercury No.	Description
18-9350	—	1 Gallon (3.78L), Full Strength



GEAR LUBE



SYNTHETIC GEAR LUBE

Specifically formulated to optimize gear life by reducing friction and providing superior wear protection in severe operating conditions. The unique synthetic formulation is shear stable and resists oxidation to ensure high performance over a wide range of ambient operating temperatures.

- API GL-5/MIL-L-210E • Weight: 75W-90 • Color: Gold

Part No.	Volvo No.	Description	Case Qty.
18-9680-2	1141679	1 Quart (946ml)	12
18-9680-5	1141681	5 Gallon	
18-9680-7	1141682	55 Gallon	

SIERRA HI-PERFORMANCE "SYNTHETIC BLEND" LOWER UNIT GEAR LUBE



- Synthetic blended marine formulation reduces operating friction for increased performance and protection of gears, bearings and other gear case components.
- Recommended for use in high performance and high load operating conditions in both outboard and I/O lower units.
- Sierra Hi-Performance gear lube has been designed to surpass the performance of the O.E. Hi-Performance gear lubricants . . . for the finest product available demand Sierra Hi-Performance gear lube.
- Recommended for engines 75 HP and above.
- GL-5 Rated
- Color: Blue-Green
- Weight: 80W-90

Replaces: **Mercury** (Quicksilver) Hi-Performance Blend
OMC (System Matched) Ultra-HPF Blend
Yamaha (Yamalube) LUB-GEARL-11-00

Part No.	Description
18-9650-0	10 Oz. Tube (12 per case) (283.5g)
18-9650-2	Quart (12 per case) (946ml) • Replaces: Mercury 92-858064Q01
18-9650-2P	84 case pallet (Qt.)
18-9650-5	5 Gallons (18.95L) • Replaces: Mercury 92-858008Q01
18-9650-5P	36 - 5 Gallon container pallet
18-9650-6	16 Gallon (61L) • Replaces: Mercury 92-858067Q01
18-9650-6P	9 - 16 Gallon container pallet
18-9650-7	55 Gallons (208L) • Replaces: Mercury 92-858068Q01
18-9650-7P	4-55 Gallon drum pallet



SIERRA PREMIUM LOWER UNIT GEAR LUBE

- Recommended for all general marine applications requiring a GL-5 class lubricant.
- Ideal for replacing all old hypoid 90 application needs.
- Formulated for use in freshwater or saltwater conditions and all standard marine applications.
- Reduces friction and protects gears, bearings and other gearcase components.
- Recommended for engines under 75 HP.
- Color: Amber • Weight: 80W-90

Replaces: **Mercury** (Quicksilver) Premium Blend
OMC (System Matched) Hi-Vis Lubricant
Yamaha (Yamalube) LUB-GEARL-11-04

Part No.	Description
18-9600-0	10 Oz. Tube (12 per case) (283.5g) • Replaces: Mercury 92-802844Q02
18-9600-9	Kit Contains: (1) 18-9786 & (2) 18-9600-0
18-9600-2	Quart (12 per case) (946ml) • Replaces: Mercury 92-858058Q01
18-9600-2P	84 case pallet (Qt.)
18-9600-5	5 Gallons (18.95L) • Replaces: Mercury 92-858007Q01
18-9600-5P	36 - 5 Gallon container pallet
18-9600-6	16 Gallon (61L) • Replaces: Mercury 92-858061Q01
18-9600-7	55 Gallons (208L) • Replaces: Mercury 92-858062Q01
18-9600-7P	4 - 55 Gallon drum pallet



18-9600-9 GEAR LUBE KIT

Contains:

Part No.	Description	Qty.
18-9786	Lower Unit Fill Tube	1
18-9600-0	10 oz. Tube Lower Unit Gear Lube	2

- Color: Amber • Weight: 80W-90

SIERRA TYPE "C" GEAR LUBE

- Formulated for older model outboards and I/O's equipped with electric shift.
- Reduces friction and protects gears, bearings and other gearcase components.
- Weight: 75W

Replaces: **OMC** (System Matched) Premium Blend

Part No.	Description
18-9620-2	Quart (12 per case) (946ml)
18-9620-5	5 Gallons (18.95L)

ENGINE CARE PRODUCTS

SIERRA PRO PERFORMANCE GREASE

- Specifically formulated for marine applications
- Premium lithium formulation for optimum corrosion protection in freshwater and saltwater applications
- Ideal for marine trailer wheel bearing, universal joints, outdrive pivot joints, gimbal bearings and shaft splines
- Operating Temp: -40°F - 350°F

Part No.	Mercury No.	Description
18-9200-0	92-8M0071838	8 Oz. Tube (226.8g) (Case of 12)
18-9200-1	92-8M0071841	15 Oz. Cartridge (425.2g) (Case of 10)
18-9200-2*	92-8M0071837	3 Oz. (85.05g) Cartridge (Pkg. of 2)
18-9200-4*	92-8M0071837	3 Oz. (85.05g) Cartridge (Pkg. of 4)

*Display Packaged



SIERRA HYDRO DEFENSE MARINE GREASE

18-9240-0
(8 oz Tube)

Replaces:
Mercury 92-802859A1

18-9240-1
(14oz Cartridge)

Replaces:
Mercury 92-802863A1

- Prohibits rust and corrosion.
- Prevents wear against the most extreme friction in marine applications.
- Will not break down in marine conditions.
- Contains PTFE for minimum wear and added friction protection.
- For use on prop shafts, trailer bearings, throttle and shift cables and linkage, swivel pins and more!



OIL DRAIN KITS



For easy installation this kit includes:

- 42" hose with hose hanger
- Universal oil pan replacement plug
- End cap

Note: Does not fit late model oil pan utilizing metric threads M12-1.75

- Makes changing your oil a snap and without the mess!
- Permanently mounts to bottom of oil pan to make changing oil more convenient.
- Drains 4 quarts of oil in less than 15 minutes without a pump.
- Fittings on hose machined from corrosion resistant brass.
- Assembly sized to pass through most common hull drains.



18-7894 OIL DRAIN ADAPTER

Machined from corrosion resistant brass.

For: Mercuriser 224 CID (3.7L) Engines
1/4" - 18 NPT Threads
Remove adapter from 18-7891 & replace

Part No.	Description	Application
18-7891	For: GM, Chrysler & Most Ford	Oil Pans 1/2" — 20 Threads



18-2446 FILL/DRAIN KIT - OUTBOARD

• 3/8" - 16 thread
Fits: Johnson/Elvinrude & Mercury Gearcase



18-2447 FILL/DRAIN KIT - STERN DRIVE

• 3/8" - 16 thread
Fits: Stern Drive Gearcase, Mercuriser, OMC & Volvo Penta SX & DP



18-2448 LOWER UNIT FILL/DRAIN KIT

• M8 - 1.25 thread
Fits: Yamaha, Nissan/Tohatsu, & Honda Lower Units

OIL CHANGE KITS



18-9390 OIL CHANGE KIT

Replaces:
Yamaha LUB-MFNSM-KT-10
Fits: F30(2001-05), F40(1999-08), F40A(2009 & Up),
F50(1995 & Up), T50(1996 & Up), F60(2002 & Up),
T60(2003 & Up), F70(2010 & Up)



18-9391 OIL CHANGE KIT

Replaces:
Yamaha LUB-MFNM-D-KT-10
Fits: F75(2003 & Up), F80(1999-02), F90(2003 & Up),
F100(1999-02), F115(2000 & Up)

18-8600

E-GO! FUEL INJECTION CLEANING KIT

For: Mercury, Honda, Yamaha

- Cleans away layers of fuel deposits when the engine is running.
- Helps maintain injector's cleanliness and performance throughout the life of your engine.
- For best results, use E-GO! Blast Fuel Injector Cleaner (18-8606).

Contains:

- Cleaning System Container **18-8601**
- Hose **18-8602**
- Small Fitting **18-8603**
- Large Fitting **18-8604**
- Carrying Case **18-8605**



18-8608

E-GO FLEXIBLE NOZZLE SUPPORT
Support for Throttle Body Adaptor



18-8609

E-GO! THROTTLE BODY ADAPTER

Fits: All engines with Throttle body fuel supply



18-8610

E-GO! ADAPTER

Fits: All Yamaha EFI

18-8606

E-GO! BLAST FUEL INJECTOR CLEANER

Replaces: Mercury 92-8M0062765

For: Mercury, Yamaha, Honda

- Cleans all fuel injector types
- Prevents rough idling and stalling
- Reduces intake and port deposits
- Maximizes fuel economy

Use with 18-8600 Fuel Injector Cleaning Kit

* Labeled for US/Canada sales ONLY



18-8607

E-GO! BOOST FUEL SYSTEM BOOSTER

For: Mercury, Yamaha, Honda

- Cleans entire fuel system
- Cleans all fuel injector types
- Prevents rough idling and stalling
- Stabilizes fuel during storage
- Maximizes fuel economy
- Easy! Just pour and go

* Labeled for US domestic sales ONLY



SANITATION SYSTEM CLEANER

18-9093 (1 Gal.) (Ready-To-Use)

18-9095 (1 Gal.) (Concentrate)

- Removes uric scale, calcium carbonate and other solids
- Safe for all sanitation system components
- USDA certified bio based product
 - Non-toxic, Biodegradable, Non-hazardous



18-9730-1

LITHIUM SPRAY GREASE (WHITE)
12 Oz. (340g)

- Multi-purpose spray lubricant for Marine applications
- Ideal for lubricating shift components and miscellaneous applications where a light grease lubricant is required
- Water and heat resistant
- Prevents corrosion



LQ-5 FILTERED LUBRICANT

18-9182 8.5 FL. OZ. 18-9183 16 FL. OZ.



2-STROKE OIL MIXING BOTTLE

18-9798

32 FL. OZ bottle

Re-usable bottle for precise measuring of oil to fuel ratio for your engine.



18-9884

BOWL WRENCH

Replaces: Racor RK22628

Fits: Sierra, Racor and other aftermarket filter bowls



18-52207

TUBE KIT

Replacement tubes for oil extractors
18-52204 and 18-52104.



18-9780

FLEX FILL SPOUT

Pouring device for quart bottles

18-52205

FLUID DISPENSER

For easily dispensing fluids for any application.

- Large 1.2 gallon capacity
- Sealed internal pump components
- Flow control valve equipped
- Quick connect fittings
- 20PSI Max Pressure
- Includes pressure gauge
- Integrated pressure relief valve



18-52206

FLUID DISPENSER/EXTRACTOR

For removing/dispensing fluid in difficult to reach areas.

- No-drip cap
- 7 oz. capacity
- 7 1/2" flexible tube



18-52204

OIL EXTRACTOR

For Quick, Easy & Clean Oil Changes

- Large 8.8 Liter (2.3 Gallon) capacity not only can extract fluids, but is capable of dispensing too! Simply move the bi-directional valve and this unit will create a vacuum or move the valve the other direction and it creates pressure to dispense the fluid.
- Built-in shut-off valve to prevent overfilling
- Comes complete with 5 feet of flexible hose and two rigid dipstick tubes.



18-52104

OIL EXTRACTOR

For Quick, Easy & Clean Oil Changes

- This 8.8 Liter (2.3 Gallon) capacity air operated extractor can be used to remove a wide range of fluids, such as engine oil, brake fluid, antifreeze and more
- Built-in shut-off valve to prevent overfilling
- This unit can be used away from the air source by creating a vacuum, closing off both shut-off valves, then take to where it's needed
- Comes complete with 5 feet of flexible hose, two rigid dipstick tubes, and a brake bleeding kit



OIL FILTER WRENCHES



18-9778

Size: 2-7/16" thru 3"

Fits small outboard filters

18-9789

Size: 2-9/16" thru 3-1/4"

18-9790

Size: 3-5/16" thru 3-3/4"



OIL ABSORBENT PADS

Oil Zap II Absorbent & Disposable

18-81103 (150 pad Shop Pack)



18-9779

GEAR LUBE PUMP

Universal Gear Lube Pump for use with standard or wide mouth bottles.

Includes adapters for all major outboard engine manufacturers.

Premium construction with aluminum fittings for long life.



18-9781

OIL PUMP

Replaces: Mercury 91-850730Q01,

91-8M0072133

- Ideal for "do-it-yourself" owners
- Quart size application is perfect for most marine drives
- Includes lube fitting for domestic lower units with flexible fill line



LOWER UNIT FILL TUBE

18-9786 (Standard) 18-9787 (Import)

- Flush & fill tool for small gearcases requiring the 10 ounce tube package
- Ideal for "do-it-yourself" in home maintenance
- Includes appropriate lower unit fitting for specific applications



18-9898

HOSE PINCH-OFF PLIERS

Use to pinch off rubber hoses up to 1 1/2" OD



18-9794

GEAR LUBE ADAPTER

Replaces: Mercury 91-883704Q03

For: Nissan, Yamaha, Honda, Tohatsu

For use with Sierra quart pumps or lower unit fill tubes.

Metric 8-1.25 thread



18-9795

GEAR LUBE ADAPTER

For: Suzuki lower unit

For use with Sierra quart pumps or lower unit fill tubes.

Metric 10-1.25 thread



18-81006

GREASE FILLER ADAPTER

Fits: CMC and Volvo Dual Prop



18-9788

LUBE PUMP

5 Gallon (18.95L)

For filling lower units on outboards and stern drives.

Tapered/unthreaded hose end. Designed for use with our 18-9600-5, 18-9620-5 and 18-9650-5



GREASE GUNS

18-9782 (14 Oz.) 18-9783* (3 Oz.)

Replaces: Mercury 91-7405706

Heavy duty all steel construction for dependable, long service life.

* Display Packaged



18-9784
BARREL PUMP
For: 16 thru 55 gallon drum



Display Package

18-9804
GREASE GUN
FLEX HOSE

- Designed for hand operated or pneumatic grease guns
- Ideal for hard to reach grease fittings
- 12 inch length
- Heavy duty with flex hose



18-9785
EASY LUBER
Replaces:
Machinery 91-30500

- Ideal for quick and easy lube jobs using squeeze tubes
- Compact size, perfect for under seat and tackle box storage
- Use with all 10 oz. grease tubes



18-9066
LOCTITE® THREADLOCKER
Medium Strength
Color: Blue Gel



18-9067
LOCTITE® THREADLOCKER
Medium Strength
Color: Red Gel



37701
THREADLOCKER
High Strength



37479
LOCTITE® THREADLOCKER
Permanent
High Strength -36 ml.
Replaces: OMC 500423
Machinery 92-809820
Color: Red
APPLICATION:
High strength, permanent threadlocker for heavy duty applications. (MASTER PACK 10)



37467
LOCTITE® ULTRA BLACK SILICONE
80 ml. Tube
Color: Black
APPLICATION:
Seal, caulk and insulate electrical connections. Best general purpose sealant for sealing flanges, valve covers and flexible joints. Operating temperature to 400°F (204°C).



37566
LOCTITE® ANTI-SEIZE™
1 lb. can w/brush
Color: Gray
APPLICATION: Use on mechanical joints and external moving parts such as starter bushings, prop shaft splines and battery terminals. Drasses exhaust gaskets. Coats and protects metal parts. Lubricates threads, gears, chains, cables, pulleys, rollers and pivots to temperatures up to 1600°F. (871°C) Heavy-duty, temperature resistant compound fortified with graphite and metallic flake. Will not evaporate or harden.



22355
ODC FREE CLEANER
12 oz.
Replaces: OMC 390905
Color: Clear
APPLICATION:
Clean parts before reassembly. Removes dirt, oil and solvent. Leaves no residue. Solvent is non-flammable and low-toxicity. Cold degreaser.



79040
LOCTITE® CHISEL™ GASKET REMOVER
18 oz.
Replaces: OMC Gasket Remover 390928
Color: Milky White/Clear
APPLICATION:
Remove old gaskets, paint and grime with Gasket Remover. Strips off hard carbon deposits. Eliminates harsh scraping that may damage a flange surface.



18-0116
GASKET MATERIAL
Synthaseal non-asbestos;
Excellent oil resistance: Designed to seal rough surfaces: Will withstand 350° F.



18-9125

OETIKER CLAMP KIT

Replaces: Johnson/Evinrude 787133, 787145

Part #	Qty	Johnson/Evinrude #	Oetiker #	Description	
18-9141	1	787145	14100082	Oetiker Jaw Pincers	
Nominal ID					
Part #	Qty	Johnson/Evinrude #	Oetiker #	Inches	mm
18-9126-9	10	346930	16700004	3/8"	9.5
18-9127-9	10	348838	16700006	13/32"	10.5
18-9128-9	10	349516	16700007	7/16"	11.3
18-9129-9	10	347107	16700010	1/2"	13.3
18-9130-9	10	347108	16700011	17/32"	13.8
18-9131-9	10	346931	16700012	35/64"	14
18-9132-9	10	346785	16700013	9/16"	14.5
18-9133-9	10	346786	16700016	5/8"	15.7
18-9134-9	10	348839	16700017	11/16"	17
18-9135-9	10	346151	16700024	13/16"	21
18-9136-9	10	346152	16700031	1"	25.6
18-9137-9	10	346153	16700037	1 3/16"	30.1
18-9138-9	10	349759	16700040	1 1/4"	31.6
18-9139-9	10	349729	16700053	1 5/8"	41
18-9140-9	10	346150	16700020	23/32"	18.5

All clamps are standard package of 10. Each package of 10 is available individually.

18-9145 OETIKER CLAMP KIT

Replaces: Yamaha YB-6AW04-A, Mercury 91-803146A2



Part #	Qty	Yamaha #	Oetiker #	Description	
18-9141	1	YB-6AW04-4	14100082	Oetiker Jaw Pincers	
Nominal ID					
Part #	Qty	Yamaha #	Oetiker #	Inches	mm
18-9133-9	50	YB-6AW04-1	16700016	5/8"	15.7
18-9146-9	50	YB-6AW04-3	16702498	25/32"	19.8

All clamps are standard package of 10. Each Package of 10 is available individually.



18-2455 DRAIN PLUG GASKET ASSORTMENT

Fits: Multiple Manufacturers & Most Drives
Contains 50 each of 18-4698, 18-4253, 18-2945, 18-4246, 18-8331, 18-60103

18-8997

DUAL FEED FLUSH - ROUND CUPS

Universal

Fits most engines up to 115 H.P.



18-8998-1

ENGINE FLUSHER - RECTANGULAR CUPS

Universal

Fits most engines 120 H.P. and UP



18-8999

DUAL FEED FLUSH - RECTANGULAR CUPS

Universal

Fits most engines 120 H.P. and UP



18-9009

INBOARD FLUSHER

Universal

Fits most inboard engines



18-9010 MOTOR FLUSHER (Heavy Duty)

- High quality EPDM rubber cups
- Corrosion resistant dicromate finish
- Installs in seconds
- Use with a standard garden hose
- Hose connector complete with rubber washer
- No tools required

Flushes cooling system of salts and sediments and allows engine to idle for tuning and engine adjustment in your own driveway. Simply slip attachment over the engine's side water intakes. Coated spring steel arms clamp suction cup securely over the engine's side water intakes.



18-9895

DUAL WATER PICKUP SEAL

Replaces:

Mercury/Evinrude 881150K1

Fits: Mercury and E-Tec Engine with Nose Cone Dual Water Pickup.



18-79987

TRANSOM PLATE (SMALL)

Size: 2" x 15"

Universal fit plate designed to add transom support.



18-79988

TRANSOM PLATE (LARGE)

Size: 4" x 17"

Oversized universal fit plate designed to add transom support.

MARINE GRADE GAS FILLED SUPPORTS



Features:

- Annealed steel rods, nitride coated for corrosion resistance
- Engineered polymer rod ends
- Composite bushings
- Internal lip seal
- Exact fit OEM replacement
- Updated Packaging

Part No.	OE No.	Extended Lgth. (in.)	Compressed Lgth. (in.)	Rated (lbs.)	Part No.	OE No.	Extended Lgth. (in.)	Compressed Lgth. (in.)	Rated (lbs.)
GS62600	GSNI-4900-20	7.5	5.5	20	GS62720	GSNI-5200-20	17	11	20
GS62610	GSNI-4900-40	7.5	5.5	40	GS62730	GSNI-5200-30	17	11	30
GS62620	GSNI-4900-80	7.5	5.5	80	GS62740	GSNI-5200-40	17	11	40
GS62630	GSNI-5000-20	10	7	20	GS62750	GSNI-5200-60	17	11	60
GS62640	GSNI-5000-40	10	7	40	GS62760	GSNI-5200-90	17	11	90
GS62650	GSNI-5000-60	10	7	60	GS62770	GSNI-5300-20	20	12	20
GS62660	GSNI-5100-20	12	8.5	20	GS62780	GSNI-5300-30	20	12	30
GS62670	GSNI-5100-30	12	8.5	30	GS62790	GSNI-5300-40	20	12	40
GS62680	GSNI-5150-20	15	9.5	20	GS62800	GSNI-5300-60	20	12	60
GS62690	GSNI-5150-30	15	9.5	30	GS62810	GSNI-2300-60	20	12	60
GS62700	GSNI-5150-40	15	9.5	40	GS62820	GSNI-2300-90	20	12	90
GS62710	GSNI-5150-60	15	9.5	60	GS62830	GSNI-2300-120	20	12	120



NAUTALIFT™ STAINLESS STEEL GAS LIFT SUPPORTS

MARINE GRADE GAS FILLED SUPPORTS



Features:

- Designed for demanding saltwater applications
- 316L Stainless Steel Rod and Cylinder
- Engineered polymer rod ends
- Composite bushings
- Internal lip seal
- Updated Packaging



Part No.	OE No.	Extended Lgth. (in.)	Compressed Lgth. (in.)	Rated (lbs.)	Part No.	OE No.	Extended Lgth. (in.)	Compressed Lgth. (in.)	Rated (lbs.)
GSS62600	GSSX-4900-20	7.5	5.5	20	GSS62740	GSSX-5200-40	17	11	40
GSS62610	GSSX-4900-40	7.5	5.5	40	GSS62750	GSSX-5200-50	17	11	50
GSS62630	GSSX-5000-20	10	7	20	GSS62760	GSSX-5200-90	17	11	90
GSS62640	GSSX-5000-40	10	7	40	GSS62770	GSSX-5300-20	20	12	20
GSS62670	GSSX-5100-30	12	8.5	30	GSS62780	GSSX-5300-30	20	12	30
GSS62680	GSSX-5150-20	15	9.5	20	GSS62790	GSSX-5300-40	20	12	40
GSS62700	GSSX-5150-40	15	9.5	40	GSS62800	GSSX-5300-60	20	12	60
GSS62710	GSSX-5150-60	15	9.5	60	GSS62820	GSSX-2300-90	20	12	90
GSS62720	GSSX-5200-20	17	11	20	GSS62830	GSSX-2300-120	20	12	120



GS62840
Black zinc plated steel flat bracket with 10mm ball stud. 2.25" wide



GS62850
Stainless steel flat bracket with 10mm ball stud. 2.25" wide



GS62860
Black zinc plated steel 90° angle bracket with 10mm ball stud. 2" wide • .65" base



GS62870
Stainless steel 90° angle bracket with 10mm ball stud. 2" wide • .65" base



GS62880
Black zinc plated steel 90° angle bracket with 10mm ball stud. 2" x 1.2" base



GS62900
Stainless steel 90° angle bracket with 10mm ball stud. 2" x 1.2" base



GS62910
Zinc plated steel 10mm ball stud with threaded shaft. 5/16" - 18



GS62920
Stainless steel 10mm ball stud with threaded shaft. 5/16" - 18



GS62890
Rod end with internal threads for either end of Nautalift gas filled lift supports. Unique construction makes installation easy and safe.



18-95560
ENGINE OIL PRIMER



18-79834
LIFTING EYE TOOL
For: Johnson/Evinrude V4 & V6



18-79817
UNIVERSAL ENGINE PULLER
Fits: 2 and 4 bbl manifolds



Part #	O.E. #	Description
18-9885	328360	Collar
18-9886	328361	Collar
18-9887	328363	Collar
18-9892	341440	Collar
18-9888	328364	Gauge Bar
18-9889	328365	Gauge Bar
18-9890	328366	Gauge Bar
18-9891	328367	Gauge Bar
18-9894	393279	Screw



18-79825
GIMBAL BEARING INSTALLER TOOL
For: Mercruiser, OMC and Volvo
Use with 18-4442 Alignment tool



18-79820-1
GIMBAL PULLER TOOL
For: Mercruiser, OMC and Volvo



18-79833-1
FLYWHEEL PULLER TOOL
For: Mercury



18-79823
STEPLESS CLAMP 90 DEGREE TOOL
Fits: Crimp type stepless clamps



18-9896
LIFTING EYE TOOL
Replaces: Mercury 91-904551, 91-90455T1, 91-90455T, 91-878232, 91-75132, 91-47448A1



18-9897
VERADO FLYWHEEL PULLER/LIFTING EYE
Replaces: Mercury 91-895343T02, 91-895343T01, 91-895343A02
Fits: All verado engines as a lifting eye and flywheel puller.



18-9879
INTERMEDIATE SHIFT CABLE SNAKE
Description: Use to easily remove and install intermediate shift cables in Mercury drives.



18-79815
FUEL FILTER TOOL
Replaces: Yamaha YB-ACC04
For: Yamaha F150-F350, 2.6L & 3.3LHPDI (2006 & Up)



18-79814
FUEL FILTER TOOL
Replaces: Mercury 91-896661



18-79813
BEARING CARRIER PULLER TOOL
For: Mercruiser, Mercury and Yamaha



18-9876
SHIM GAUGE BAR
Replaces: 349957
For: 40 HP, V-8 with thru hub exhaust



18-9806E
SHIFT CABLE TOOL
Replaces: Mercury Marine 91-12037
Description: Installs and removes shift cables on MC-1, R-MR, Alpha One, Alpha One/Gen II drive units. Use with 18-2190 and 18-2190E cables.



18-9807
SHIFT CABLE ADJUSTMENT TOOL
Replaces: Mercury Marine 91-12427, 91-12427T
 Description: Attaches over the shift cable, used for proper Bravo drive unit shift cable adjustment at the shift plate.



18-9874
DRIVE SHAFT PRELOAD TOOL
Replaces: Mercury Marine 91-14311A2, 91-44307A1, 91-14311A04, 91-14311A1
 Description: Preloads drive shaft bearing when checking pinion height and backlash on MC-I, R-MR, Alpha One, Alpha One/Gen II drive units and outboards.



18-9808
NEEDLE BEARING DRIVER
Replaces: Mercury Marine 91-15755T, 91-15755, 91-37263, 91-31109
 Description: Installs needle bearings in MC-I, R-MR, Alpha One, and Alpha One/Gen II bearing carriers.



18-9803
SPANNER NUT WRENCH
Replaces: Mercury Marine 91-17256
 Description: Removes and installs driveshaft bearing retainer on MC-I, R-MR, Blackhawk, all Bravo and all Alpha drive units.



18-9809
BEARING CARRIER RETAINER TOOL
Replaces: Mercury Marine 91-17257
 Description: Loosens and tightens bearing carrier retainer on Bravo Two drives.



18-9810
SHIFT CABLE ANCHOR ADJUSTMENT TOOL
Replaces: Mercury Marine 91-17262A1
 Description: Used to install shift cable core wire on all Bravo drive units.



18-9812
BEARING & SEAL INSTALLATION TOOL
Replaces: Mercury Marine 91-17275A1
 Description: Installs shifter shaft bushings on all Bravo drive units.



18-9814
PLATE/PULLER BAR
Replaces: Mercury Marine 91-29310
 Description: Used as a guide to remove and install gimbal bearing on MC-I, R-MR, Alpha One, Blackhawk and all Bravo drives.



18-9817
SHIFT SHAFT BUSHING TOOL
Replaces: Mercury Marine 91-31107T, 91-31107, 91-24150, 91-23033T, 91-23033
 Description: Removes and installs the shift shaft bushing in the gear case of MC-I, R-MR and Alpha One drive units and outboards.



18-9821
DRIVER HEAD
Replaces: Mercury Marine 91-32325, 91-32325T
 Description: Installs gimbal bearing in MC-I, R-MR, Alpha One, Alpha One/Gen II, Blackhawk and all Bravo drive units.



18-9823
DRIVER HEAD
Replaces: Mercury Marine 91-33489
 Description: Installs the small roller bearing in the gimbal housing of MC-I, R-MR and Alpha One drive units.



18-9824
DRIVER HEAD
Replaces: Mercury Marine 91-33491
 Description: Installs needle bearing in forward gear and removes and installs seals and bearing in gimbal housing of MC-I, R-MR and Alpha One drive units.



18-9825
DRIVER HEAD
Replaces: Mercury Marine 91-33492T, 91-33492
 Description: Removes and installs lower swivel pin needle bearing in gimbal ring on MC-I, R-MR and Alpha One drive units.



18-9826
BEARING CUP DRIVER
Replaces: Mercury Marine 91-33493, 91-33493T
 Description: Installs upper drive shaft bearing cup in drive shaft housing of MC-I, R-MR and Alpha One drive units.



18-9827
BEARING CUP DRIVER
Replaces: Mercury Marine 91-34379T
 Description: Installs drive shaft bearing cup in gear housing of MC-I, R-MR, Alpha One drive units and outboards.

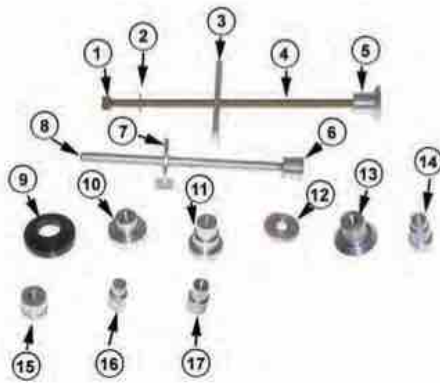
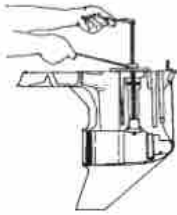

**18-9820-1
INSTALLATION TOOL KIT**

Replaces:
Mercury Marine 91-31229A7
Description: removes and installs bearings in MC-I, R-MR, Alpha One, Alpha One Gen II and all Bravo gear cases.

— CONTAINS —

Part #	O.E. #	Description	Part #	O.E. #	Description
1	NSS 11-24156	Puller Nut	11	18-9808 91-15755T	Needle Bearing Driver Washer
2	18-9805 12-34961	Puller Washer	12	18-9836 91-37350	Bearing Puller
3	18-9814 91-29310	Puller Plate	13	18-9849 91-52394	Bearing Puller
4	18-9819 91-31229	Puller Shaft	14	18-9832 91-37292	Bearing Puller
5	18-9821 91-32325T	Driver Head	15	18-9822 91-32336	Driver Head
6	18-9848 91-52393	Driver	16	18-9833 91-37311	Driver Head
7	18-9815 91-37324	Pilot Plate	17	18-9834 91-37312	Driver Head
8	18-9835 91-37323	Driver Rod			
9	18-9816 91-30366T1	Mandrel			
10	18-9828 91-36379	Driver Head			



**18-9835
DRIVER ROD**

Replaces: Mercury Marine 91-37323
Description: Used with various drivers to install bearings on Alpha One, Gen II and Bravo One and Two gear cases.



**18-9831
BEARING CUP DRIVER**

Replaces: Mercury Marine 91-36577, 91-36577T
Description: Installs forward gear bearing cup in gear housing of MC-I, R-MR and Alpha One drive units.



**18-9838
U-JOINT ADAPTER**

Replaces: Mercury Marine 91-38756
Description: Supports yoke when disassembling u-joint on all drive units.



**18-9839
BEARING CUP DRIVER**

Replaces: Mercury Marine 91-38918T
Description: Installs bearing cup in top cover of drive shaft housing of MC-I, R-MR, Alpha One drive units and outboards.



**18-9841
DRIVE SHAFT SHIMMING TOOL**

Replaces: Mercury Marine 91-42840T
Description: Shims pinion gear on Bravo One drives.



**18-9842
DRIVE SHAFT
RETAINER WRENCH**

Replaces: Mercury Marine 91-43506T
Description: Removes and installs threaded bearing retainer on Alpha stern drives and outboards.



**18-9844
TAPERED INSERT TOOL**

Replaces: Mercury Marine 91-43579
Description: Installs tapered insert retainer into water inlet hose on all Bravo drive units.



**18-9845
SEAL DRIVER**

Replaces: Mercury Marine 91-43591T
Description: Installs upper drive shaft oil seal on Alpha One and Alpha One/Gen II drive units.



**18-9847
BELLOWS EXPANDER TOOL**

Replaces: Mercury Marine 91-45497A1
Description: Installs exhaust bellows on MC-I, R-MR, Alpha One, Bravo One and Two and Blackhawk drive units.



**18-9850
BACKLASH INDICATOR**

Replaces: Mercury Marine 91-53459
Description: Checks gear backlash on TR, TRS, MC-I, R-MR, Alpha One, Alpha One/Gen II and Bravo One and Two drive units.



**18-9851
OIL SEAL DRIVER**

Replaces: Mercury Marine 91-55916
Description: Installs oil seals in TR and Bravo One and Two drive unit bearing carrier.



18-9852

BEARING DRIVER

Replaces: Mercury Marine 91-55918

Description: Installs needle bearings in Bravo One and Two and TR drive unit bearing carrier.



18-9853

PINION GEAR SHIMMING TOOL

Replaces:

Mercury Marine 91-56048T, 91-56048001

Description: Measures pinion height of MC-I, R-MR, Alpha One and Alpha One/Gen II drive units.



18-9854

DRIVE SHAFT ADAPTER

Replaces: Mercury Marine 91-56775T

Description: Provides a wrench surface to turn the drive shaft on MC-I, R-MR, Alpha One, Alpha One/Gen II drive units and outboards.



18-9855

DRIVEN GEAR SHIMMING TOOL

Replaces: Mercury Marine 91-60523

Description: Measures upper drive gear clearance on MC-I, R-MR, Alpha One and Alpha One/Gen II drive units.



18-9856

DRIVE GEAR SHIMMING TOOL

Replaces: Mercury Marine 91-60526T

Description: Measures upper drive gear clearance on MC-I, R-MR, Alpha One, Alpha One/Gen II drive units.



18-9857

PINION NUT ADAPTER

Replaces: Mercury Marine 91-61067A3

Description: Holds pinion nut when removing pinion gear and drive shaft on MC-I, R-MR, Alpha One drive units and outboards.



18-9858

BEARING CARRIER RETAINER WRENCH

Replaces: Mercury Marine 91-61069T

Description: Removes and installs bearing carrier retainer nuts on Bravo One and Two, MC-I, R-MR, Alpha One, Alpha One/Gen II, TRS drive units and outboards.



18-9868

DRIVE SHAFT ADAPTER

Replaces: Mercury Marine 91-61077

Description: Provides a wrench surface to turn the propeller shaft on MC-I, R-MR, Alpha One, Alpha One/Gen II, Bravo One and TRS drive units.



18-9859

PULLER

Replaces: Mercury Marine 91-63616

Description: Removes upper swivel shaft on MC-I, R-MR, Alpha One, Alpha One/Gen II, Bravo One, Two and Three and Blackhawk gimbal rings.



18-9860

BEARING DRIVER

Replaces: Mercury Marine 91-63638T

Description: Removes and installs lower drive shaft pinion bearing on TR and Bravo One and Two drive units.



18-9861

HINGE PIN TOOL

Replaces: Mercury Marine 91-78310

Description: Removes and installs hinge pins from all Mercury Marine drive units.



18-9869

UPPER DRIVE SHAFT HOUSING SEAL DRIVER

Replaces: Mercury Marine 91-817570T

Description: Installs seals in Alpha One/Gen II upper drive shaft housing.



18-9870

SLEEVE INSTALLATION TOOL

Replaces: Mercury Marine 91-818162

Description: Installs the aluminum sleeve in the u-joint bellows of all Bravo, Alpha One/Gen II, Blackhawk drive units and outboards.



18-9871

SLEEVE REMOVAL TOOL

Replaces: Mercury Marine 91-818169T

Description: Removes the aluminum sleeve from the u-joint bellows of all Bravo, Alpha One/Gen II and Blackhawk drive units.



18-9872

PUMP ALIGNMENT TOOLS

Replaces: Mercury Marine 91-821571A1

Description: Aligns Alpha One/Gen II water pump during installation.



18-9863
BEARING DRIVER

Replaces: Mercury Marine 91-89865
Description: Installs bearing carrier seals on Bravo One and Two drive units.



18-9865
DRIVE SHAFT BEARING TOOL

Replaces: Mercury Marine 91-90774
Description: Presses bearing cone onto Alpha One/Gen II drive shaft housing pinion gear.



18-9866
DIAL INDICATOR HOLDING TOOL

Replaces: Mercury Marine 91-89897
Description: Secures dial indicator to gear housing when checking backlash on MC-I, R-MR, Alpha One, TR, TRS drive units and outboards.



18-8611
O2 SENSOR SOCKET

- Universal
- 7/8" (22mm) w/ 25/32" wire opening
- 3/8" Drive



18-8612
O2 SENSOR SOCKET

- Universal
- 7/8" or 22mm w/ 9/32" wire opening
- 3/8" Drive



18-8613
O2 SENSOR WRENCH

- Universal
- 7/8" or 22mm
- 3/8" drive
- 6 point



18-8614
O2 SENSOR WRENCH

- Universal
- 7/8" or 22mm
- 1/2" drive, 2" overall depth



18-8615
O2 SENSOR WRENCH

- Universal
- Includes 6 and 12 point socket
- 3/8" Drive



18-8616
O2 SENSOR WRENCH

- Universal
- Includes 6 and 12 point socket
- 3/8" Drive, 2 1/8" offset



18-8617
O2 SENSOR WRENCH

- Universal
- 6 point
- 3/8" Drive, 1.2" overall depth



18-9800
COMPRESSION TESTER

Description: Perfect for hard to reach bottom spark plug holes on older Mercury models.



18-9902
DEEP WELL COMPRESSION TEST ADAPTER

For deep well spark plug holes to perform compression testing. Works with 18-9900 compression tester.

- 14mm and 18mm threads
- Reaches 8" beyond the installation surface



18-9801
MULTI METER/DVA TESTER

Replaces: Mercury Marine 91-99750A1
Description: Tests electrical and ignition systems. Consists of a VOA meter with built-in direct voltage adapter.

18-9900
DIGITAL COMPRESSION TESTER

For Testing Compression on Gasoline powered engines.

- Stores max compression value for up to 12 cylinders
- Backlit LCD Display
- Auto Shutoff
- Sealed and Vibration protected
- Displays values in PSI, Bar, and kPa
- Fits many Outboard, Inboard, PWC, ATV, Recreational gasoline engines



18-9903
ENGINE IGNITION ANALYZER

Description: For the diagnosis and performance measurement of all types of spark ignition systems, from conventional to the newest Coil on Plug in use.

- Displays everything on a 3.5" color screen.
- Rechargeable battery provides 6+ hours of use.
- Durable design (MIL-STD-810) drop test approved.
- Comes with hard shell carrying case.
- Includes 18-9914 Plug Wire Sensor Clip and Extension Lead.



18-9914
PLUG WIRE SENSOR CLIP EXTENSION

Description: Extension Lead with Plug wire sensor clip for 18-9903:

- 2 m (78") long shielded cable with BNC connector.
- Sensor accepts wires of up to 9 mm (3/8") diameter.
- Cable can also be used with coil on plug sensor supplied with the 18-9903.



EC09090
DIGITAL MINI MULTIMETER

Compact design and the functions you need for overall convenience

- 3 1/2 digit LCD display
- 16 test ranges, 6 functions
- Battery & protective holster included
- Fuse protected, removable safety leads and jacks

18-9904
FAULT FINDER

Description: For locating electrical short and open circuits.

- Includes 18-9906 & 18-9907.
- Operates on 6 to 42 VDC systems.
- 8 in. flexible probe reaches in congested places.
- Adjustable sensitivity.
- Transmitter and receiver LEDs signal open or short circuit conditions.
- Auto polarity transmitter that leads with 5 amp alligator clips.
- Includes hard shell carrying case.



18-9905
AC/DC LOW CURRENT CLAMP METER

Description: Designed to accurately measure current, current leaks (parasitic draws down to 1mA) and electrical loads from 1mA to 100 amp AC/DC and voltages from 0 to 600 AC/DC.

- Current measurement: 1 mA up to 100 A.
- Voltage measurement up to 600 V.
- Clamp opens up to 1/2" (12.5 mm).
- Operates with one rotary switch.
- Includes soft shell carrying case.



18-9908
AC/DC 600A CLAMP METER

Description: Allows the measurement of AC/DC currents with a resolution down to 0.1 A, and up to a maximum of 600A, making it ideal for testing all kinds of loads such as found in: electric motors, fuel pumps, charging systems, starter currents, alternators, etc.

- Current measurement: up to 600A.
- Voltage measurement: up to 600 V.
- Clamp opens up to 1" (25.4 mm).
- Operates with one rotary switch.
- Includes soft shell carrying case.



Front View

18-9906
CORDLESS CIRCUIT TESTER

Description: Specifically designed for use on autos, trucks, trailers, RV's & boats.

- No ground or clip necessary.
- Range of operation: 3 to 28 VDC.
- Powered by one AA alkaline battery.
- Wireless design eliminates tangles.



18-9907
FUSE SOCKET TEST CONNECTORS

Description: Covers the most common fuse socket adapters requirements in the automotive and vehicular electrical repair field.

- Fits all Maxi, ATO and Mini type fuses.
- Maximum conductivity and durability.
- Molded for easy insertion and removal.



18-9911
REFLECTIVE TAPE

Description: A package of specially formulated self adhesive reflective tape strips, for use as a target for optical tachometers. Its highly reflective surface is designed to scatter the light (infrared, laser or visible) emitted by the optical tachometer, improving the detection of the rotating or moving object from a wide range of angles and distances.

- 6 strips - 8" (L) x 0.2" (W) / 20 cm (L) x 0.5 cm (W)



18-9912
LASER TACHOMETER & COUNTER

Description: Used to measure and test the number of rotations per minute (RPM) or total number of rotations or events on any spinning shaft, pulley, wheel, drive belt, fan, or other rotating objects in general, safely, accurately and easily.

- Measures from 2.5 to 99999 RPM.
- 0.05% accuracy.
- 2 to 20" measuring range.
- Laser-powered optical system.
- Memory recall functions (minimum & maximum).
- Uses 18-9911 Reflective Tape.



18-9910
OXYGEN SENSOR TESTER/SIMULATOR

Description: For testing and diagnostics on any Oxygen Sensor, to quickly determine whether the sensor is defective and needs replacement.

- Signal output shown in real time on LED bar graph.
- Auto detection of common wire misconnections.
- Works with zirconium, titanium & air/fuel ratio sensors.
- Comes with hard shell carrying case.



18-9913
SMARTACH (DIESEL AND GASOLINE ENGINE TACHOMETER)

Description: A tachometer designed for use on any engine equipped with an alternator, and only requires a simple connection to the electrical system (e.g. battery, alternator, cigarette lighter connector) to measure engine RPM.

- Measures from 200 to 9,999 RPM
- 0.05% accuracy.
- Large 4 1/2" digit LCD display.
- Comes with hard shell carrying case.



18-9915
FUEL INJECTOR ANALYZER

Checking the operation of any gasoline or diesel fuel injector. Works on Solenoid, Piezo (Direct Injectors), and Mechanical Injectors for gasoline and diesel engines. Compares readings between injectors with a "candlestick" graph that displays maximum, minimum, and average readings for each injector. This is drop impact resistant and comes with a rechargeable Li-ion battery that provides 6+ hours of working time.

- Display injector waveforms in real time
- Detect and display ECM control signals
- Monitor Pintle Valve Motion and Response
- Detect and display engine speed
- 3.5" color TFT LCD display



18-9909
PROFESSIONAL DVOM

Description: Offers full auto range features and functionality. Equipped with a 4 digit LCD display with analog bar graph. It is capable of measuring AC/DC voltage up to 600 Volt and AC/DC current up to 10 A. Other functions includes tachometer for RPM measurement, dwell, temperature, resistance, frequency, fuel injection test, diode test, continuity check and overload protection.

- State of the art design and styling.
- 4 digit LCD display with analog bar graph.
- AC/DC voltage measurement: up to 600 V.
- AC/DC current measurement: up to 10 A.
- Tachometer function measures 30 to 20000 RPM
- Comes with hard shell carrying case.



EC01350
TERMINALS & CONNECTORS W/CRIMP TOOL

30 pc. terminal assortment packed with crimp tool/wire cutter. Attractive 5 compartment clamshell fits neatly in tool box or glove compartment. Handy for emergencies. Perfect for the do-it-yourselfers.



EC09040
DUAL VOLTAGE CIRCUIT TESTER

Dual bulb tester for testing both 6 and 12 volt circuits. Also can be used to check spark plug wires. This is the most commonly used tester for troubleshooting auto, truck, van and boat wiring. Supplied with ground wire and clip. Packed one per card.



18-8960
IGNITION SPARK TESTER

Description: Use to check for ignition spark in up to 4 ignition wires at a time.



18-9802
TIMING LIGHT

Replaces: Mercury Marine 91-99379
Description: Checks ignition timing. Powered by two "D" cell batteries, portable.



18-4442
ENGINE ALIGNMENT TOOL

Replaces: Mercury Marine 91-57797A3, 91-57797A2, 91-57797A1, 91-8M0067546, 91-48347, 91-37384
Description: Used to verify engine alignment on all MC-I, R-MR, Alpha One and Alpha One/Gen II.



18-9849
BEARING PULLER

Replaces: Mercury Marine 91-52394
Description: Removes and installs bearings in MC-I, R-MR, Alpha One, Alpha One/Gen II, all Bravo and outboard gear cases.



18-9862
BEARING DRIVER

Replaces: Mercury Marine 91-87119
Description: Installs driveshaft bearing onto driveshaft.



18-9873
BEARING DRIVER

Replaces: Mercury Marine 91-813653
Description: Installs u-joint oil seal into bearing carrier, also used to pilot the puller rod for gear housing needle bearing installation on Bravo One and Two drive units.



**18-9815
PILOT PLATE**

Replaces:
Mercury Marine 91-37324
Description: Removes and installs bearings in MC-I, R-MR, Alpha One, Alpha One/Gen II, all Bravo and outboard gear cases.



**18-9816
MANDREL**

Replaces:
Mercury Marine 91-30366T1
Description: Removes and installs bearings in MC-I, R-MR, Alpha One, Alpha One/Gen II, all Bravo and outboard gear cases.



**18-9819
PULLER SHAFT**

Replaces:
Mercury Marine 91-31229
Description: Removes and installs bearings in MC-I, R-MR, Alpha One, Alpha One/Gen II, all Bravo and outboard gear cases.



**18-9822
DRIVER HEAD**

Replaces: Mercury Marine 91-32336
Description: Removes and installs bearings in MC-I, R-MR, Alpha One, Alpha One/Gen II, all Bravo and outboard gear cases.



**18-9828
DRIVER HEAD**

Replaces:
Mercury Marine 91-36379
Description: Removes and installs bearings in MC-I, R-MR, Alpha One, Alpha One/Gen II, all Bravo and outboard gear cases.



**18-9832
BEARING PULLER**

Replaces:
Mercury Marine 91-37292
Description: Removes and installs bearings in MC-I, R-MR, Alpha One, Alpha One/Gen II, all Bravo and outboard gear cases.



**18-9833
DRIVER HEAD**

Replaces:
Mercury Marine 91-37311
Description: Removes and installs bearings in MC-I, R-MR, Alpha One, Alpha One/Gen II, all Bravo and outboard gear cases.



**18-9834
DRIVER HEAD**

Replaces:
Mercury Marine 91-37312
Description: Removes and installs bearings in MC-I, R-MR, Alpha One, Alpha One/Gen II, all Bravo and outboard gear cases.



**18-9848
DRIVER**

Replaces:
Mercury Marine 91-52393
Description: Removes and installs bearings in MC-I, R-MR, Alpha One, Alpha One/Gen II, all Bravo and outboard gear cases.



STARTER ROPE
(200' Spools)

Part #	Desc.	Replaces:
18-4911	5/32" X 200'	OMC 322236
18-4913	3/16" X 200'	OMC 316705
18-4914	1/8" X 200'	OMC 316706



**18-4904
STARTER
HANDLE & ROPE**

#4.5 (5/16") Rope
Handle Only: 18-4901



CABLE BOOT

18-4454 For 3" Hole
18-4455 For 4 1/2" Hole

Safe-Skeg

Whether you are looking to protect your new skeg, repair your damaged one, or even just add some shine. Safe-Skeg is made of 316 Marine Grade Stainless Steel Construction and installation takes minutes.

- Material Thickness: 1.5mm, 50% thicker than the competition.
- Drain Hole to protect against corrosion and freeze-up.
- Brilliantly polished with seamless design.
- Skid Plate not necessary due to extra thickness in material.



Motor	Horsepower	Stroke	Year Range	Part No.
Evinrude/Johnson	150-175-185-200-225	2	1986-2003	35-SS630
Force Outboard	70 - 90 HP (by Mercury)	2	1998-2002	35-SS625
Force Outboard	70-75	2	1991-1997	35-SS650
Mercuriser	Alpha 1 Drives		1985-1990	35-SS605
Mercuriser	Alpha 1 Generation II Drives		1991-Present	35-SS610
Mercuriser	Bravo 1 & 3 Drives		1990-Present	35-SS615
Mercury/Mariner	135-150-175-200	2 & 4	1978-2005	35-SS620
Mercury	150	4	2012 & Up	35-SS715
Suzuki Outboard	150-175-200-225	2	1986-2002	35-SS645
Yamaha Outboard	200-225-250-300	2 & 4	2003-Present	35-SS695
Replacement Hardware Kit				35-SSKIT1



18-01101*
CHRYSLER/FORCE
ALL ENGINES
1962-1999
3-150 HP, 1 - 5 cyl.,
including L-Drive.



18-01200*
HONDA
ALL ENGINES
1978-2001
2-130 HP, 1 - 4 cyl.,
including Jet Drives.



18-01202*
HONDA
2002-2014
2-225 HP, 1 - 4 cyl.
& V6, including Jet
Drives.



18-01301*
JOHNSON/EVINRUDE
1958-1972
1.5-125 HP, 1 - 4 cyl.



18-01302*
JOHNSON/EVINRUDE
1973-1989
1.25-60 HP, 1 - 2 cyl.



18-01308*
JOHNSON/EVINRUDE
1973-1991
60-235 HP, 3 - 6 cyl.



18-01311*
JOHNSON/EVINRUDE
1992-2001
65-300 HP, V4, V6 &
V8, including jet drives.



18-01312*
JOHNSON/EVINRUDE
1990-2001
1.25-70 HP, 2 & 4-Stroke
in Line engines.



18-01313*
EVINRUDE
2002-2014
15-300 HP, All engines.



18-01314*
JOHNSON
2002-2007
3.5-250 HP, All
engines.



18-01400
MARINER
1977-1989
2-60 HP, 1 - 2 cyl.



18-01402
MARINER
1977-1989
45-220 HP, 3 - 6 cyl.



18-01404*
MERCURY
1965-1989
2-40 HP, 1 & 2-cyl.



18-01406*
MERCURY
1965-1989
40-115 HP, 3 & 4-cyl.



18-01408*
MERCURY
1965-1989
90-300 HP, 6 - cyl.



18-01416*
MERCURY/MARINER
1990-2000
2.5-275 HP, All
2-Stroke models.



18-01418*
MERCURY
2001-2014
2.5-300 HP, All
2-Stroke Engines.



18-01422*
MERCURY
2005-2011
2.5-300 HP, All
4-Stroke Engines.



18-01500*
NISSAN/TOHATSU
1992-2013
2.5-140 HP, All
Engines.



18-01600*
SUZUKI
1988-2003
2-225 HP, All 2-Stroke
Engines.



18-01602*
SUZUKI
1996-2007
2.5-300 hp, All 4-Stroke
Engines.



18-01701*
YAMAHA
1984-1996
2-250 HP, All 2 & 4-Stroke
Engines.



18-01703*
YAMAHA
1997-2014
2-300 HP, All 2-Stroke
Engines.



18-01705*
YAMAHA
1995-2004
2.5-225 HP, All
4-Stroke Engines.

SELOC MANUALS

STERN DRIVES & INBOARDS

Available on SelocOnline



18-01707*
YAMAHA
2005-2010
2.5-350 HP, All 4-Stroke
Engines.

SUZUKI
1975-1998
OM, GM/HM, JH,
JH2 Diesel Engines.
Web Only

YANMAR
2008-2014
2.5-300 hp All 4
Stroke Engines.
Web Only



18-03200*
MERCUISEUR
1964-1991
All gas engines and stern drives.



18-03206*
MERCUISEUR
1992-2000
Covers all engines and drive
units, including transmissions.



18-03208*
MERCUISEUR
2001-2013
All gas engines & drives,
includes inboards & transmissions.



18-03400*
OMC
1964-1986
All gas engines and
drives.



18-03404*
OMC COBRA
1986-1998
Covers all gas engines &
Cobra/King Cobra drives.



18-03600*
VOLVO/PENTA
1968-1991
Covers all gas engines
& drives.



18-03602*
VOLVO/PENTA
1992-1993
Covers all stern drive units
powered by Volvo 4-cylinder
engines.



18-03606*
VOLVO/PENTA
1992-2002
Covers all gas engines
& drives.



18-03608*
VOLVO/PENTA
2003-2012
Covers all gas engines
& drives.

PERSONAL WATERCRAFT

Available on SelocOnline

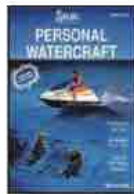

18-09000
SEA-DOO
1988-1991
All Sea-Doo &
Bombardier models.



18-09006*
SEA-DOO/
BOMBARDIER
2002-2011
All 4-Stroke Models.



18-09200
KAWASAKI
1973-1991
300-650 Series.



18-09202
KAWASAKI
1992-1997
550-1100 Series.



18-09400
POLARIS
1992-1997
650-1050 Series, inc.
Fuji-powered models.

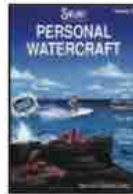

18-09600
YAMAHA
1987-1991
All Yamaha, Jet-N-Cat &
Cayuna models.



18-09602
YAMAHA
1992-1997
650-1200 Series.



18-09606*
YAMAHA
2002-2011
All 4-Stroke Models.



18-00535
PEGBOARD DISPLAY RACK

Face-out display of 9 SKUs, 18 books, 9 pockets, 2 books deep. Signage included.
14 x 27 x 9. Gray



18-00534
REVOLVING FLOOR DISPLAY RACK

Face-out display of 20 SKUs, 40 books, 4 sides with 5 pockets, 2 books deep. Signage included. 66" x 18" x 18". Gray

SELOC PRO

Seloc Pro is the most comprehensive database tool available to marine technicians! Unlimited access to our database of boat and mechanical repair - a completely automated repair and refinishing system with hull and mechanical labor times, service procedures, wiring diagrams, specifications and an estimating module with parts and pricing.

18-05500
SELOC PRO ONLINE (1 YEAR SUBSCRIPTION)



18-05002
SELOC ONLINE.COM CD DISPLAY

Attractive countertop POP display holds six SelocOnline.com cd's. Must purchase 6 cd's to receive free display.

SELOC ONLINE

18-05004
SELOC ONLINE (DIY INTERNET ACCESS)
3 YEAR, SINGLE ENGINE SUBSCRIPTION

SelocOnline is an internet based repair product allowing the boater unlimited internet access for three years to a single manufacturer/ model/year engine. SelocOnline can be accessed from any computer that has an internet connection and can be viewed from multiple devices on any web-based browser.

The main features of SelocOnline are unit repair sections that contain detailed step-by-step instructions with photos and illustrations (color in newer models). In addition, there are quick access buttons to Maintenance Schedules, Parts Database, Wiring Diagrams, Specification Charts, Dealer Finder and a searchable hyperlinked Index.



STATS

SIERRA TOUCH AND TEST SYSTEM

STATS is the perfect solution for performing diagnostics on your marine engine. This self contained system requires no additional computer hardware to operate and works with most popular engine brands. The console integrates an easy to use touch screen with a left/right tactile user interface to create an efficient user experience.



FEATURES & BENEFITS

- Plug and Play Design
- ECU Identification
- Fault Code Reading
- Possible Causes of Faults to aid in diagnosis
- Displays/Records Live Data
- Performs Engine System Functions
- Component Actuation
- PWC Key and Remote Programming
- Splash/Vibration Resistant
- Free Internet Software Updates
- Print & Save Service Results
- USB, PC Interface
- Diagnostic & Sierra Parts Catalog Software

Sierra STATS® is available in two convenient packages. You can choose between a yearly subscription, or a one-time purchase.

OPTION 1: SUBSCRIPTION (COMPLETE KIT)

Part No. 18-SD500

- Includes: 1st year unlimited use subscription for all software platforms offered on STATS®, core hardware and accessory bags, specific cables for Mercury®/MerCruiser®, Mercury® G3, MEFI® 1-4, Johnson®/Evinrude®, Suzuki® O/B, Yamaha® O/B, and Honda® O/B.
- Tester can be topped off to a maximum of 50 tokens every loader update free of charge.
- As new software is launched, it is automatically released to subscription testers for use.
- All other cables will be available as a hardware kit:

Part No.	Cable	Part No.	Cable
18-SD115SUB	Yamaha® PWC	18-SD116SUB	Kawasaki®
18-SD117SUB	Sea-Doo®	18-SD413SUB	MEFI 5-6®
18-SD406SUB	Volvo® Diesel	18-SD407SUB	Yanmar®

STATS SUBSCRIPTION RENEWAL (1 YEAR) • Part No. 18-SD501

Unlimited use of all software offered by STATS for a 12 mo. period. Late renewal fees may apply.

OPTION 2: ONE-TIME PURCHASE (COMPLETE SYSTEM)

Part No. 18-SD410

- Includes: All software and hardware for Mercury®/MerCruiser®, Mercury® G3, MEFI® 1-4, Johnson®/Evinrude®, Suzuki® O/B, Yamaha® O/B, & Honda O/B.
- One-time purchase with no subscription fees. New lower cost and free updates.



18-ADA500
STATS TESTER (CONSOLE)



18-ADA501HC
STATS ACCESSORY HARD CASE



18-ADA502
STATS TESTER (CONSOLE)
NEOPRENE CASE



18-ADA503
STATS DONGLE CASE



18-ADA504
STATS YAMAHA NEOPRENE
CARRY CASE



18-ADA505
STATS MERCURY/
MERCURUISER/MEFI
CARRY CASE



18-ADA506
STATS BRP/SEADOO
NEOPRENE CARRY CASE



18-ADA507
STATS KAWASAKI NEOPRENE
CARRY CASE



18-ADA508
STATS SUZUKI NEOPRENE
CARRY CASE



18-ADA509
STATS VOLVO
NEOPRENE BAG



18-ADA510
STATS MEFI NEOPRENE
CARRY CASE



18-ADA511
STATS HONDA
NEOPRENE BAG



18-ADA512
STATS GENERIC
NEOPRENE BAG



18-ADC400
STATS DONGLE A UNIVERSAL



18-ADC401
**STATS DONGLE B SEADOO
 4 TECH ENGINES**



18-ADC409
STATS DONGLE C SEADOO DI ENGINES



18-ADC412
**STATS DONGLE D BRP DESS
 (2 STROKE)**



18-ADC152
STATS POWER CABLE (AC)
 Includes adapters to work with North American, European, Australian, and United Kingdom electrical plugs.



18-ADC450
STATS POWER CABLE (12V)



18-ADC199
JACK SCREWS FOR STATS CONSOLE
 Enables the Master Cable to be secured to the 25-way connector on the STATS tester.



18-ADC153
STATS USB CABLE



18-ADC300E
STATS MASTER CABLE (20')



18-ADC402
**STATS BRP SAFETY KEY
 PROGRAMMING CABLE**



18-ADC403
STATS YAMAHA
DIAGNOSTIC CABLE



18-ADC404
STATS BRP
DIAGNOSTICS CABLE



18-ADC406
STATS KAWASAKI
T-IN POWER CABLE



18-ADC407
STATS MERCURY
DIAGNOSTIC CABLE



18-ADC408
STATS BRP
T-IN POWER CABLE



18-ADC410
STATS MERCURY
OUTBOARD CABLE



18-ADC411
STATS HYDROSPACE/BENELLI/WEBER
DIAGNOSTIC CABLE



18-ADC414
STATS KAWASAKI
POWER CABLE (4-STROKE)



18-ADC415
STATS VOLVO DIESEL
DIAGNOSTIC CABLE



18-ADC416
STATS KAWASAKI
FITCH DI CABLE



18-ADC417
STATS YANMAR
DIESEL DIAGNOSTIC
CABLE



18-ADC418
STATS YAMAHA
REMOTE PROGRAMMING CABLE



18-ADC419
STATS KAWASAKI
KEY PROGRAMMING CABLE



18-ADC420
STATS SUZUKI
4 PIN DIAGNOSTIC CABLE



18-ADC421
STATS SUZUKI
8 PIN DIAGNOSTIC CABLE



18-ADC422
STATS BRP
DESS DIAGNOSTIC CABLE



18-ADC423
STATS JOHNSON EVINRUDE
DIAGNOSTIC CABLE



18-ADC424
STATS MEFI 1-4 DIAGNOSTIC CABLE



18-ADC425
STATS MEFI 5-6 DIAGNOSTIC CABLE



18-ADC427
STATS HONDA DIAGNOSTIC CABLE



18-ADC428
STATS MERCURY G3
DIAGNOSTIC CABLE

ENGINE ADD ON UPGRADE KITS

Upgrade your STATS console to perfectly suit your needs.

With our Engine Add On Software Kits you can purchase only the software that you require.

18-SD111	MERCURY/MERCUISER/MEFI 1-4
18-SD112	JOHNSON/EVINRUDE
18-SD113	YAMAHA OUTBOARD
18-SD114	SUZUKI
18-SD115	YAMAHA PWC
18-SD116	KAWASAKI
18-SD117	SEA DOO
18-SD405	HYDROSPACE/BENELLI/WEBER
18-SD406	VOLVO D3, D4, D6
18-SD407	YANMAR DIESEL
18-SD413	MEFI 5-6 UPGRADE KIT
18-SD414	HONDA
18-SD415	MERCURY G3 (DROP SHIP ONLY)

 <p>18-5013 TUNE-UP KIT</p> <p>Part # 18-5149 18-5189</p> <p>— CONTAINS — Desc. Contact Set Condenser</p> <p>O.E.# F12044 F12042-1</p>	 <p>18-5149 CONTACT SET</p> <p>Replaces: F12044, FP2437A</p>	 <p>18-5169 CONDENSER</p> <p>Replaces: F12042-1</p>	 <p>18-5241 CONDENSER</p> <p>Replaces: F12181-1</p>
---	---	---	---

 <p>18-5803 SOLENOID</p> <p>Replaces: F177917</p>	 <p>18-5835 SOLENOID</p> <p>Replaces: 89-803822T, 89-F460917-1, F460917-1, 89-817109A3</p> <p>For: Early model 35-150 HP</p>	 <p>18-5834 SOLENOID</p> <p>Replaces: 89-817109A2</p> <p>For: 75 HP (3 cyl.) S/N G127500 & UP</p>
---	--	---

 <p>18-5775 SWITCH BOX</p> <p>Replaces: 332-7778A12</p>	 <p>18-5881 SWITCH BOX</p> <p>Replaces: 332-5772A7, 332-5772A5</p>	 <p>18-5790 SWITCH BOX ASSEMBLY</p> <p>Replaces: 18495A26</p>
---	--	---

 <p>18-5870 STATOR</p> <p>Replaces: 398-832075A4</p>	 <p>18-5873 STATOR & KIT</p> <p>Replaces: 398-832075A6</p> <p>For: 100, 115, 125 HP</p>	 <p>18-5186 IGNITION COIL</p> <p>Replaces: 339-7370A13, 339-7370B13, 339-832757B4</p> <p style="text-align: right;">① 18-5186D Display Package</p>
---	--	---

COIL & STATOR APPLICATION

Year	HP	S/N	Coil	Stator	Year	HP	S/N	Coil	Stator
1992-95	40/50	E000001-E138599	18-5186	—	1990-95	120	ALL	18-5186	—
1996-99	40/50	E138600-E369299	—	18-5870	1994-95	120	E065487-E138599	18-5186	18-5873
1991-95	70	E000001-E138599	18-5186	—	1994-95	SPORT JET 120	E095088-E141088	18-5186	18-5873
1996-99	75	E138600-UP	—	18-5870	1996-99	120	E138600-UP	—	18-5870
1991-95	90	E000001-E138599	18-5186	—	1989-94	150	ALL	18-5186	—
1996-99	90	E138600-UP	—	18-5870					

CHRYSLER IGNITION

HP	Model	Contact Set	Condenser	Tune-Up Kit	Starter Solenoid	HP	Model	Contact Set	Condenser	Tune-Up Kit	Starter Solenoid
4.5	42HA	—	18-5241	—	N/A	9.9	92H1R,H1J,H2J,H3K	—	18-5241	—	N/A
4.9	44HA,44/45HB, HC, HD	—	18-5241	—	N/A	9.9 ²	92/93H9F,98/99H9A	—	18-5241	—	N/A
5	52/53HA	—	18-5241	—	N/A	9.9	92/93HA-HE,H0G,94H1F	—	18-5241	—	N/A
5	54/55HA, HB, HC, HD	—	18-5241	—	N/A	9.9 ⁴	94/95HA	—	18-5241	—	18-5803
6	60HA,62/63HA-HH, H9M	—	18-5241	—	N/A	9.9 ⁶	94/95HA-HE	—	18-5241	—	N/A
6	64HA-HC, H0F, H1G, H2H, H8D, H8E	—	18-5241	—	N/A	10 ¹	102/103HD, H8B, 108/109HA, H8B	—	18-5241	—	—
7	72/73HA	—	18-5241	—	N/A	10	102/103/104/105HA, HB, HC	—	18-5241	—	N/A
8	82/83HA-HH,H9K	—	18-5241	—	N/A	12.9	122/123H9E, 128/129H9A	—	18-5241	—	—

① Items ending in "D" are Display Packaged - Regular number is Non-Display

APPLICATION CONTINUED ON NEXT PAGE

CHRYSLER IGNITION (Cont.)

HP	Model	Contact Set	Condenser	Tune-Up Kit	Starter Solenoid	HP	Model	Contact Set	Condenser	Tune-Up Kit	Starter Solenoid
12.9	122/123/124/125HA, HC, HD	—	18-5241	—	N/A	35②	356/357HA-HF	18-5162	—	—	18-5803
15	152H1G, H1H, H2H, H3J	—	18-5241	—	N/A	35	360/361HA, HB	18-5149	18-5169	18-5013	—
15	152/153HA, HB, HD①	—	18-5241	—	N/A	45③	450 THRU 457HA, HC-HH	18-5162	—	—	18-5803
15①	152/153HC, H8D, H9E	—	18-5241	—	—	45②	450 THRU 457HA, HC-HH	18-5149	18-5169	18-5013	18-5803
15	154/155HA, 154HB	—	18-5241	—	N/A	45③	450 THRU 457HC-HH	18-5162	N/A	N/A	18-5803
15	158/159HA, H8B, H9C	—	18-5241	—	—	45	450/451HK, 452/453HC-HJ, H8K	18-5149	18-5169	18-5013	—
20	202H②N, 202/203HA-HG, HDL	—	18-5241	—	N/A	45	456/7HD, HJ, H1M, H9K, 457HHP, H2N	18-5162	—	—	18-5803
20①	202/203H1M, H9K	—	18-5241	—	—	45	458/459HA, HG	18-5162	N/A	N/A	18-5803
20	204/205HA-HG	—	18-5241	—	N/A	45②	458/459HA-HF	18-5162	—	—	18-5803
20③	206/207H9B	—	18-5241	—	—	45③	458/459HA-HF	18-5162	N/A	N/A	18-5803
25	252H1F, H2F, H3G, 252/253H8C	—	18-5241	—	N/A	45②	458/459HA-HF	18-5149	18-5169	18-5013	18-5803
25②	252/253HB, H8D, 254/255HB	—	18-5241	—	N/A	45	459HJJ, H9H	18-5162	—	—	18-5803
25	252/253/254/255HA	—	18-5241	—	N/A	45	464HA	18-5149	18-5169	18-5013	18-5803
25③	252/253/254/255HB, 256/257HA	18-5162	—	—	—	50	503H3A, 507H1A, H2B, H2C, H3D, H3E	18-5162	—	—	18-5803
25④	256/257HA, H8C	—	18-5241	—	N/A	55	551HA	18-5162	—	—	18-5803
30①	302/303H9C, HB	—	18-5241	—	N/A	55②	554 THRU 559HA, HC-HG	18-5149	18-5169	18-5013	18-5803
30	302/303/304/305HA	—	18-5241	—	N/A	55③	554 THRU 559HA, HC-HG	18-5162	—	—	18-5803
30	302/303/304/305HB, 306/607HA	18-5162	—	—	—	55④	554 THRU 559HA, HC-HG	18-5162	N/A	N/A	18-5803
30③	304/305HB, 306/607HA	—	18-5241	—	N/A	70	706/707HA, HC-HF	N/A	N/A	N/A	18-5803
30④	350/351HK, H8L, 356/357HK, H8M	—	18-5241	—	N/A	75	756/757HA	N/A	N/A	N/A	18-5803
35①	350/351/354/355HC-HH	18-5162	—	—	18-5803	85	856/857HA, HC, HD, HE	N/A	N/A	N/A	18-5803
35②	350/351/354/355HC-HH	18-5149	18-5169	18-5013	18-5803	90	906/907HA	N/A	N/A	N/A	18-5803
35④	350/351/354/355HH, 356/357HF	18-5162	N/A	N/A	18-5803	105	1058/1057HA-HF, 1058HA, HB, HC	N/A	N/A	N/A	18-5803
35⑤	350/351/356/357HK	18-5162	—	—	—	105	1058HD, 1059HD	N/A	N/A	N/A	18-5803
35	350/352/353/354/355HA, 352/353HF	18-5149	18-5169	18-5013	18-5803	120	1206/1207HA-HF, 1208HA, HB, HC	N/A	N/A	N/A	18-5803
35	352/353HC-HE, HC-HJ, H2P, H8K, H9L	18-5149	18-5169	18-5013	—	120	1208HD, 1209HD	N/A	N/A	N/A	18-5803
35	353HOM, H1N	18-5149	18-5169	18-5013	—	130	1306/1307HA	N/A	N/A	N/A	18-5803
35②	356/357HA-HF	18-5149	18-5169	18-5013	18-5803	135	1356/1357HA, 1358HA, HB, HC	N/A	N/A	N/A	18-5803
						135	1358HD, 1359HD	N/A	N/A	N/A	18-5803
						150	1508HA	N/A	N/A	N/A	18-5803

① Magnapower ignition (w/alternator & C-D Unit) ② Standard ignition (w/alternator) ③ 95HA S/N 3300 & up, 95HA S/N 3125 & up
 ④ Magneto ignition (no alternator) ⑤ 94 HA S/N 3299 & below, 95HA S/N 3124

FORCE IGNITION

Year	Model	Serial #	Contact Set	Condenser	Solenoid	Switch Box
1984-87	B.9/15	N/A	—	18-5241	—	—
1996-99	40/50	E138600-E369299	—	—	18-5834②	—
1984-87	50	N/A	18-5162	—	18-5803	—
1988	50	N/A	—	—	18-5803①	—
1991B, 1992C	70	E000001-E039023	18-5162	—	18-5803	18-5790
1991-95	70	E000001-E138599	—	—	—	18-5790
1996-99	75	E138600-UP	—	—	18-5834②	—
1991D-1992C	90	E000001-E039023	N/A	N/A	—	18-5775
1991	90 L-DRIVE	N/A	N/A	N/A	—	18-5775
1991-95	90	E000001-E138599	—	—	—	18-5790
1996-99	90	E138600-UP	—	—	18-5834②	—
1993-94	SPORT JET 90	E025150-E033710	N/A	N/A	—	18-5775
1991D-1992CA, 1993, 1994	120	E000001-E093699	N/A	N/A	—	18-5881
1995	120	E093700-E138599	N/A	N/A	—	18-5881
1996-99	120	E138600-UP	—	—	18-5834②	18-5790
1991-92	120 L-DRIVE	N/A	N/A	N/A	—	18-5881

① Except "D" Models ② Style II

PREMIUM MARINE SPARK PLUG WIRE LEADS

Sierra's MAGFORCE Ignition Wires are "Electronics Friendly" protecting all of your electronic devices and electronic engine controls from RFI and EMI while delivering the maximum amount of voltage. Exact fit design ensures easy installation and years of trouble - free service.

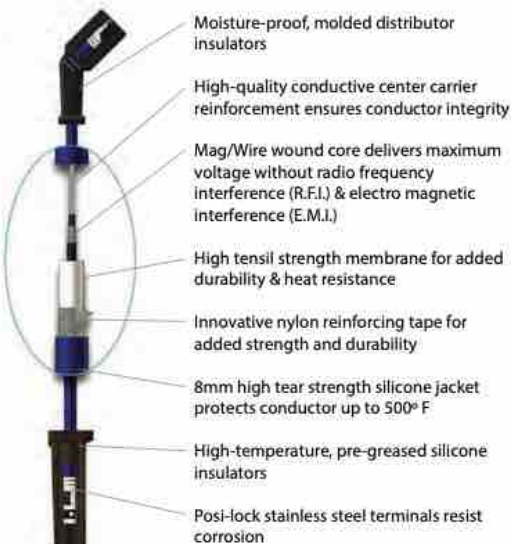

Part No.	Description
18-8819-1	7' Spark Plug Wire
18-5228-1	8' Spark Plug Wire
① 18-5228-1D	8' Spark Plug Wire
②③ 18-5229-9-1	22' Spark Plug Wire (pkg of 5)
②③ 18-5230-9-1	10' Spark Plug Wire (pkg of 5)



18-9802 TIMING LIGHT

Self-powered accurate up to 10,000 RPM's



BATTERY CABLES

Gauge cable with soldered lug terminals on each end to accept a 3/8" stud.



Part No.	Size	Color	Gauge
BC88523	2'	Red	4
BC88533	2'	Black	4
BC88543	4'	Red	2
BC88553	4'	Black	2
BC88563	6'	Red	2
BC88573	6'	Black	2
BC88583	8'	Red	1
BC88593	8'	Black	1

18-5225 SPARK PLUG WIRE KIT

Replaces:

Mercury 84-99215A26, 84-813706A26
Kit includes 25 ft. roll of 7mm hypalon ignition wire with a metallic core and a large assortment of three different end fittings to fit outboard motors.



18-5222
IGNITION WIRE
Silicone Core
(100' Spool)
8mm



18-5226
IGNITION WIRE
Metallic Core
(100' Spool)
7mm Hypalon



PKG. OF 10



18-5224
18-5224-9②
IGNITION WIRE TERMINAL

PKG. OF 10



18-5750
18-5750-9②
UNIVERSAL SPARK
PLUG BOOTS
Supplied complete w/ Terminal Connector



18-5752
UNIVERSAL
SPARK PLUG BOOTS
(8mm)



18-5206
CONDENSER
Replaces: 398-176

① Items ending in "D" are Display Packaged - Regular number is Non-Display
② Priced per Package
③ Uses 7mm wire copper core



18-5742
VOLTAGE REGULATOR

Replaces: 8152792, 815279T3, 815279T2, 830179A2, 817411, F746470, F718470

Force engines with 16 amp - 20 amp charging system model years 1991-92

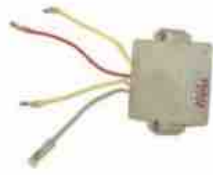

18-5744
VOLTAGE REGULATOR

Replaces: 8152794, 883071A1, 856747T1, 854514A1, 830179A1, 8174111, 815279T5, 815279T4

Force engines with 16 amp - 20 amp charging system model years 1993-present

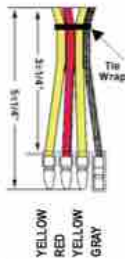

18-6762
TILT/TRIM MOTOR

Replaces: 449541-3, 455541



If you have this 3-wire single ram system, use **18-6775**

18-6775
TILT/TRIM MOTOR

Replaces: 824051, 830250A6

For: 90 HP (1995-97) and 120 HP (1995-97)

Contains: All parts necessary, a new 3-wire motor/reservoir, drive shaft coupler, oil seal, o-ring and hardware.



18-6286
TILT/TRIM MOTOR

Heavy Duty Late Model Mercury/Force 25-50HP Outboards w/2-wire connection and flat blade shaft. 4 bolt mount.

Replaces: 827675A1



18-6279
TILT/TRIM MOTOR

Replaces: 820545, F694541-1
Late model Force outboards w/2 wire connection

18-6777
TILT/TRIM MOTOR

Replaces: 818903A1, 819762A4-A7, 819479A1, 819480A1, 81977A8-A9, 822870A1, 830250A3-T3, 832021A1-T4-A2-T2, 855654A1-T2, 19217A1-A5
Contains: All parts necessary, a new 2-wire motor/reservoir, drive shaft coupler, oil seal, O-ring and hardware.

For:

HP	Years	HP	Years
40	1992-94	90	1991-94
50	1991-94	120	1990-94
70	1991-95	150	1989-94
75	1996-99		

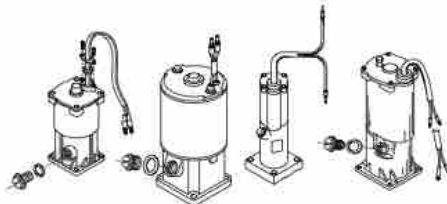

If you have any of the 2-wire single ram systems, use **18-6777**



18-6439
STARTER

Replaces: 50-803903T, 50-F575955
Fits: 50HP (1984-92)



18-6441
STARTER

Replaces: 50-803900T, 50-F514955
Fits: 25 HP (1983-84, 1989), 30 hp (1979), 35 HP (1976-78, 1996-91)



18-5613
OUTBOARD STARTER

Replaces: Mercury/Force
FK616955, F616955, F490955, F480955, FS438955, F438955-1, F85955-1, FA85955, FS438955, FS480955, FS489955, FS490955



18-5618
OUTBOARD STARTER

Replaces: Mercury/Force
50-819968-2, 50-8199684, 50-8199683, 50-8199681, 50-819968, 50-898265003



18-5622
OUTBOARD STARTER

Replaces: Mercury/Force
50-820193, 50-820193T1



18-5697
DRIVE BRUSH KIT

Replaces: 75384, F15164

CHRYSLER/FORCE							
Years	Starter	OEM #	Drive Assembly	O.E. #	Tooth Count	Drive Brush Kit	O.E. #
1983-84	18-6441	50-F514955/514955	18-5655	F15150	10	18-5697	F15157
1989	18-6441	50-F514955/514955	18-5655	F15150	10	18-5697	F15157
1979	18-6441	50-F514955/514955	18-5655	F15150	10	18-5697	F15157
1978-78	18-6441	50-F514955/514955	18-5655	F15150	10	18-5697	F15157
1986-91	18-6441	50-F514955/514955	18-5655	F15150	10	18-5697	F15157
1966-89	①	201955/FK575955	-	F15150	9	18-5697	F15164
1966-92	18-6439	50-F575955	18-5655	F15150	10	18-5697	F15164
1966-92	①	50-F514955/514955	-	-	10	18-5697	F15164
1992-99	18-5622	50-820193/50-820193T1	18-5677	811902	13	18-5697	F15164
1992-94	①	50-819271/50-820193A1	18-5677	811902	13	18-5697	F15164
1966-89	18-5613	50-819085/F616955-1/F616955	-	819222	9	18-5697	F15164
1966-89	18-5613*	480955/FK616955	-	F15100, F15110	9	18-5697	F15164
1991-95	18-5613	50-819085/F616955-1/F616955	-	819222	9	-	F15190
1996-98	18-5613	50-819085/F616955-1/F616955	-	819222	9	-	F15190
1989	18-5613	50-819085/F616955-1/F616955	-	819222	9	18-5697	F15164
1992-97	18-5616	50-819968-2	-	820583	9	-	F15190
1991-98	18-5613	50-819085/F616955-1/F616955	-	819222	9	-	F15190
1990-91	18-5613	50-819085/F616955-1/F616955	-	819222	9	18-5697	F15164
1990-91	18-5613	50-819085/F616955-1/F616955	-	819222	9	18-5697	F15164
1990-94	18-5613	50-819085/F616955-1/F616955	-	819222	9	18-5697	F15164
1989A-1992C	18-5613	50-819085/F616955-1/F616955	-	819222	9	-	F15190
1989-1994	18-5613	50-819085/F616955-1/F616955	-	819222	9	-	F15190

① No replacement starter available, drive parts only

* Only fits 140 HP (1983-1984)

 <p>18-7033 CARB KIT Replaces: FK10003, FK10026, FK10053, FK10102-1</p>	 <p>18-7037 CARB KIT Replaces: FK10004, FK10005, FK10007, FK10008, FK10027, FK10057, FK10108, FRK739</p>	 <p>18-7041 NEEDLE & SEAT Replaces: FO16311, FO10790</p>	
 <p>18-7057 NEEDLE & SEAT Replaces: FO10790 .078 Bore</p>	 <p>18-7805 FUEL PUMP KIT Replaces: F24747-1</p>	 <p>18-7806-1 FUEL PUMP KIT</p>	 <p>18-7817 DIAPHRAGM KIT Replaces: 21-42990A7, A8, A9, A10, 21-857005A1</p>

CHRYSLER

HP	Model	Carb Kit	Needle & Seat	Fuel Pump Kit
3.6	32/33HA,HB,HC	18-7037	18-7057	N/A
4.5	42HA	18-7037	18-7057	18-7805
5	52/53HA	-	-	18-7805
6	60HA	18-7037	18-7057	18-7805
6	60HQD,H8B,H9C	-	-	18-7805
6	61H0C,H8B,H9B	-	-	18-7805
6	62H8J,H9K,H9L	-	-	18-7805
6	67H9B,H9C	-	-	18-7805
6	62/63H9M	18-7037	18-7057	18-7805
6	62/63HA ①	18-7037	18-7057	18-7805

① S/N 3001 & up

APPLICATION CONTINUED ON NEXT PAGE

CHRYSLER (Cont.)

HP	Model	Carb Kit	Needle & Seat	Fuel Pump Kit
6	62/63HA ②	—	—	18-7805
6	62/63H9M,HC,HD,HE,HF,HG,HH	18-7037	18-7057	18-7805
6	64HA,HB,HC	18-7037	18-7057	18-7805
6	64H0F,H1G,H2H,H9E,65H0A	—	—	18-7805
6	64H8D	18-7037	18-7057	18-7805
7	72/73HA	—	—	18-7805
7.5	70H9A	—	—	18-7805
7.5	71H1B,H2C,H3D,H9A	—	—	18-7805
7.5	72H1D,H2E,H3F,H0C,H9B	—	—	18-7805
7.5	75H9A,77H0B,H1C,H9B	—	—	18-7805
8	82/83HA,HC,HD,HE,HF,HG,HH,H9K	18-7037	18-7057	18-7805
8	82/87H8J	—	—	18-7805
8.9	81H0B,H9A	18-7037	18-7057	18-7805
9.9	91H3C,95H3J	—	—	18-7805
9.9	92H1H,98H1B	18-7037	18-7057	18-7805
9.9	92H1J,H2J,H3K	—	—	18-7805
9.9	92/93H0G,H9F,HD,HE	18-7037	18-7057	18-7805
9.9	92/93HA	—	—	18-7805
9.9	92/93HB ①	18-7037	18-7057	18-7805
9.9	92/93HB ②	—	—	18-7805
9.9	94H1F,94/95HA,95H2H	—	—	18-7805
9.9	94/95HB,HD,HE, 95H0F,H1G	18-7037	18-7057	18-7805
9.9	98H2C,98/99H9A	—	—	18-7805
10	100HA,101H8B	18-7037	18-7057	18-7805
10	102/103HA,HB,HC,HD,H8B	18-7037	18-7057	18-7805
10	104/105HA,HB,HC	18-7037	18-7057	18-7805
10	108/109HA,H8B	18-7037	18-7057	18-7805
12	121H9A,125H9E	18-7037	18-7057	18-7805
12.9	122/123HA,HC,HD,H9E	18-7037	18-7057	18-7805
12.9	124/125HA,HC,HD	18-7037	18-7057	18-7805
12.9	128/129 H9A	18-7037	18-7057	18-7805
15	152H1G	18-7037	18-7057	18-7805
15	152H1H,H2H,H3J	—	—	18-7805
15	158H3D	—	—	18-7805
15	152/153HA,HC,HB,H0F,H8D,H9E	18-7037	18-7057	18-7805
15	154HB,154/155HA	18-7037	18-7057	18-7805
15	158/159,HA,H8B,H9C	18-7037	18-7057	18-7805
20	202/203HA,HB,HD,HE,HF,HG	—	—	18-7805
20	202/3H0L,H1M,H9K,202H2N	18-7037	18-7057	—
20	204/205HA,HB,HD,HE,HF,HG	—	—	18-7805
20	206/207H9B	18-7037	18-7057	—
25	252H3G,257H3D ④	18-7037	18-7057	—
25	252/253HA,HB,H8C,H8D,252H1F,H2F	18-7037	18-7057	—
25	254/255HA,HB 256/257HA,HB	18-7037	18-7057	—
30	302/303HA,HB	18-7037	18-7057	—
30	302/303H9C	—	18-7057	—
30	304/305HA,HB	18-7037	18-7057	—
30	306/307H0C,H9B	—	18-7057	—
30	306/307HA,307H1D,H2E	18-7037	18-7057	—
35	350 THRU 355HA,HC,HD	18-7037	18-7057	18-7806-1
35	350/351,HE,HF,HG,HH,HK,H8L	18-7037	18-7057	—
35	352/353H8K,H9L,353H0M,H1N	18-7037	18-7057	—

- ① S/N 3001 & up ② S/N 3000 & under
 ③ 554HF S/N 11072 & up 555HF 14439 & up, 557HF 14581 & up 558HF 11108 & up, 559HF 14309 & up
 ④ Tillotson carb CO-3A ⑤ Tillotson carb MD-144A ⑥ Tillotson carb WB-19D

APPLICATION CONTINUED ON NEXT PAGE

CHRYSLER (Cont.)				
HP	Model	Carb Kit	Needle & Seat	Fuel Pump Kit
35	352/353HE, HF, HG, HH, HJ, H2P	18-7037	18-7057	—
35	354/355HE, HF, HG, HH	18-7037	18-7057	—
35	356/357HC, HD, HC, HE, HF, HK, H8M	18-7037	18-7057	—
35	357H3N, R3P, 360/361HA, HB	18-7037	18-7057	—
35	358/357HA, HB	18-7037	18-7057	18-7806-1
45	450/451HK	18-7037	18-7057	—
45	450 THRU 457HA, HC, HD	18-7037	18-7057	18-7806-1
45	450 THRU 457HE, HF, HG, HH	18-7037	18-7057	—
45	452/453HJ, H8K	18-7037	18-7057	—
45	456/457HOL, HJ, H1M, H9K, 457H2N	18-7037	18-7057	—
45	458/459HA, HB	18-7037	18-7057	18-7806-1
45	458/459HD, HC, HE, HF, HG	18-7037	18-7057	—
45	459H0J, H9H	18-7037	18-7057	—
45	468/469HA	18-7037	18-7057	—
50	503H3A, 507H1A, H2B, H2C, H3D, R3E	18-7037	18-7057	—
55	551HA, 554 THRU 559HA, HD, HF ☉	18-7037	18-7057	18-7806-1
55	554 THRU 559HE, HG	18-7037	18-7057	—
55	558/559HH, HJ, HK, H9L	18-7033	18-7057	—
55	559H0M, H0N, H1N, H2P, H3R, V3S	18-7033	18-7057	—
60	608/609HA	18-7033	18-7057	—
65	659HA, HB	—	18-7057	—
70	706/707HA, HC, HD, HE	18-7033	18-7057	18-7806-1
70	706/707HF, 709H0AN, H9A	18-7037	18-7041	—
70	T700H9A	18-7037	18-7057	—
75	754H0B, 458H0F, H2H, 757HD, H9E	18-7033	18-7057	—
75	756/757HA, HB, HC, 756H1G	18-7037	18-7041	—
75	758H0B, H1C, P/S759H9A	18-7037	18-7041	—
75	758H2D, T750H9A	18-7037	18-7057	—
85	850H0A, H1C, 851H9A, P/S855H9A	18-7033	18-7057	—
85	856H0H, H1J, H2K	18-7033	18-7057	—
85	856/7HA, HC, HD	18-7033	18-7057	18-7806-1
85	856/7HE	18-7037	18-7041	—
85	857HF, H9G	18-7033	18-7057	—
85	858H0C, H1D, H2E	18-7033	18-7057	—
85	859HA, H8A, H9B, T850H9A	18-7033	18-7057	—
90	906/907HA, HB, HC	18-7033	18-7057	—
100	T1000H9A, 1002H0AN, 1004H0B, H9A	—	18-7057	—
100	1006H0B, H1C, 1007H9A, 1008H0A, H1B	—	18-7057	—
105	1055HA	18-7037	18-7057	—
105	1055HB	—	18-7057	—
105	1056/1057HA, HB, HC, HD	18-7037	18-7057	18-7806-1
105	1056/1057HE, HF	18-7037	18-7057	—
105	1057HH, 1058H2G	—	18-7057	—
105	1058 HA, HB, HC	18-7037	18-7057	18-7806-1
105	1058/9HD, HE	18-7037	18-7057	—
105	1058/1059HF, 1059HG	—	18-7057	—
115	1159HA	—	18-7057	—
120	1206/1207HA, HB, HC, HD	18-7037	18-7057	18-7806-1
120	1206/1207HE, HF	18-7037	18-7057	—
120	1208HA, HB, HC	18-7037	18-7057	18-7806-1
120	1208/1209HD, HE	18-7037	18-7057	—
120	1208/1209HF, 1209HG	—	18-7057	—
130	1306/1307HA	18-7037	—	18-7806-1
135	1358HA, HB, HC	18-7037	18-7057	18-7806-1
150	1508HA	18-7037	—	18-7806-1

☉ 554HF S/N 11072 & up 555HF 14439 & up, 557HF 14581 & up 558HF 11108 & up, 559HF 14309 & up

FORCE

HP	MODEL	YEAR	BEGINNING SERIAL #	ENDING SERIAL #	FUEL PUMP KIT
5	5	1988-1996	N/A	N/A	18-7805
7.5	7.5	1985	N/A	N/A	18-7805
9.9 / 15	9.9 / 15	1984-1998	N/A	N/A	18-7805
25	25	1989	N/A	N/A	18-7806-1
35	35	1986-1987	N/A	N/A	18-7806-1
35A	35A	1988-1991	N/A	N/A	18-7806-1
35B	35B	1988-1991	N/A	N/A	18-7806-1
35C	35C	1989-1991	N/A	N/A	18-7806-1
40 / 50	40 / 50	1992	E000001	E065371	18-7806-1
40 / 50	40 / 50	1992-1994	E065372	E093669	18-7817
40 / 50	40 / 50	1995	E093700	E138599	18-7817
40 / 50	40 / 50	1997-1999	E138600	& UP	18-7817
50	50	1984-1992	N/A	N/A	18-7806-1
60	60	1985	N/A	N/A	18-7806-1
70	70	1991B / 1992C	E000001	E039023	18-7806-1 ①
70	70	1992-1995	E039024	E138599	18-7817 ①
75	75	1996-1999	E138600	& UP	18-7817
85	85	1983-1988 / 1989A, 1989B	N/A	N/A	18-7806-1
85	85	1989C-H / L-DRIVE	N/A	N/A	18-7806-1
90	90	1991A / 1991B / 1991C	N/A	N/A	18-7806-1
90	90	1991D-1992C	E000001	E039023	18-7806-1 ①
90	90	1992-1994	E039024	E093699	18-7817 ①
90	90	1995-1999	E093700	& UP	18-7817
90	90 L-Drive	1991	N/A	N/A	18-7806-1
90	90	1990	N/A	N/A	18-7806-1
90	90 L-DRIVE	1990	N/A	N/A	18-7806-1
90	SPORT JET 90	1993-1994	E023150	E066619	18-7806-1
90	SPORT JET 90	1995-1996	E138325	E138599	18-7806-1
90	SPORT JET 90XR	1996-1997	E141089	& UP	18-7806-1
120	120	1990A-1991C	N/A	N/A	18-7806-1
120	120	1991D-1992C	E000001	E093699	18-7817 ①
120	120	1993-1994	E000001	E093699	18-7817
120	120	1995	E093700	E138599	18-7817
120	120	1996-1999	E0138600	& UP	18-7817
120	120 L-DRIVE	1990-1992	N/A	N/A	18-7806-1
120	120 SPORT JET	1995-1997	E095088	E138599	18-7806-1
125	125	1984-1989	N/A	N/A	18-7806-1
125	125 L-DRIVE	1989	N/A	N/A	18-7806-1
150	150	1989-1992	UP TO	E065371	18-7806-1
150	150	1993-1994	E000001	E093699	18-7817

① Serial # E000001-E065371 use 18-7806-1

FUEL WATER SEPARATORS



Sierra offers a complete line of 10 and 21 micron fuel water separating filters including drainable bowl filters to protect your carbureted and fuel injected engine.

Refer to pages 153-158 for a complete listing of OEM and universal applications.

Sierra fuel water separators remove over 99.8% of emulsified water from your gasoline. Sierra's 10 micron filters are over 90% efficient at removing particles as small as 10 micron. All filters flow @ 90 GPH to feed even the hungriest motor. Sierra 10 micron filters are recommended to prevent damage to sensitive inboard and outboard fuel injection systems.

8' LENGTH COMPLETE FUEL LINE ASSEMBLIES

3/8"
FUEL LINE ASSEMBLY

18-8011EP-2 SILVERADO 4000 Premium

OE# FS409752



18-8071
TANK
CONNECTOR
(SOLD SEPARATELY)

18-8005EP-1
PRIMER
BULB

18-8062
FUEL
CONNECTOR

*

FUEL LINE ASSEMBLY COMPONENTS

*

CHRYSLER FUEL APPLICATION

Engine	Year	Engine	Year	Engine	Year
6 HP	1976-82	35 HP	1974-89	90 HP	1975-77, 1983-84, 1991-94
7.5 HP	1979-85	40 HP	1992-94	100 HP	1979-84
8 HP	1976-79	45 HP	1974-84	105 HP	1978-78, 1982
9.9 HP	1979-95	50 HP	1981-94	115 HP	1977-84
10 HP	1976-78	55 HP	1974-83	120 HP	1978-77, 1980-94
12 HP	1979	60 HP	1984-85	125 HP	1981-88
15 HP	1976-95	65 HP	1978	135 HP	1976-77
20 HP	1978-82	70 HP	1979-80, 1991-95	140 HP	1978-84
25 HP	1975-78, 1981-84, 1989	75 HP	1975-84	150 HP	1989-94
30 HP	1979-82	85 HP	1977-88		

<p>18-8002EP-1 18-8002EP-1-10Ⓛ PRIMER BULB 1/4"</p>	<p>18-8004EP-1 18-8004EP-1-10Ⓛ PRIMER BULB 5/16" Large capacity bulb</p>	<p>18-8005EP-1 18-8005EP-1-10Ⓛ PRIMER BULB 3/8" Large capacity bulb</p>
<p>Ⓛ Discount shop pack of 10 - Priced per package</p>		
	<p>18-8062 FUEL CONNECTOR 3/8" barb Replaces: 197787-3 Mates with 18-8071</p>	<p>18-8071 TANK CONNECTOR 1/4" NPT .432 O.D. Mates with 18-8062 (Male)</p>

<p>18-3550 THERMOSTAT Replaces: F85068-2, F84068-2, F85068-1, F85068 140"</p>	<p>18-3556 THERMOSTAT Replaces: F97068-2 3/4" - 130"</p>	<p>18-3557 THERMOSTAT Replaces: F335058 1" - 143"</p>	<p>18-3559 THERMOSTAT Replaces: F528068 1" - 110"</p>
--	---	--	--

<p>18-3030 IMPELLER Replaces: 47-803630T, F523065, F523065-1 For: Force outboard, 85 HP HP A,B.&C (1981-88)</p>	<p>18-3017 18-3017-10Ⓛ IMPELLER Replaces: 47-89984T4, 47-F694065, 47-803631T</p>	<p>18-3056 18-3056-10Ⓛ IMPELLER Replaces: 47-430262</p>	<p>18-3057 IMPELLER Replaces: 47-85089-3</p>
--	--	---	---

APPLICATION ON NEXT PAGE

- Ⓛ Items ending in "D" are Display Packaged - Regular number is Non-Display
- Ⓛ Discount shop pack of 10 - Priced per package



18-3062
IMPELLER
Replaces: 47-42038-2, 002



18-3084
IMPELLER
Replaces: 47-F40065-2



18-3085
IMPELLER
Replaces: 47-F84065



18-8900
IMPELLER
Replaces: 47-19453



18-8901
IMPELLER
Replaces: 47-F462065



18-8903
IMPELLER
Replaces: 47-F436065-2



18-45003
IMPELLER
Replaces: 47-F433065
Fits: Force 35/45/55 hp (1974-80)



18-3240
WATER PUMP KIT
For: 9.9HP (1979-97) 10HP (1974-78)
12HP (1979) 15HP (1974-97)
20HP (1973-78) 25HP (1973-78)



18-3251
WATER PUMP KIT
For: 85HP (1989 D, F, G, H) 90HP (all except 1995-97 & Sport Jet) 120HP (all except 1995-97 & Sport Jet) 125HP (1988-89) 150HP (1989-up)

— CONTAINS —

Part #	Desc.	O.E. #	Qty.
18-0416	Gasket, Wear Plate	27-F694830	1
18-3017	Impeller	47-8998474	1



18-3214
IMPELLER REPAIR KIT
Replaces: 46-43024A7

— CONTAINS —

Part #	Desc.	O.E. #	Qty.
18-2564	Water Pump Base to Face Plate Gasket	27-43033-1	1
18-2565	Water Pump Base to Gear Hsg. Gasket	27-49047-1	1
18-2566	Face Plate to Water Pump Cover Gasket	27-817277	1
18-2044	Seal Ring	26-45577	1
18-3056	Impeller	47-43026-1	1
18-3122	Impeller Plate	817276	1
18-7420	O-Ring	25-21836	1



18-3215
IMPELLER REPAIR KIT

— CONTAINS —

Part #	Desc.	O.E. #	Qty.
18-2560	Impeller Washer Gasket	12-86645	2
18-2561	Gear Hsg. to Face Plate Gasket	27-85087	1
18-2562	Gear Hsg. to Face Plate Gasket	27-99326-1	1
18-3057	Impeller	47-85089-3	1
18-7419	O-Ring	25-89202	1

- ① Items ending in "D" are Display Packaged - Regular number is Non-Display
- ② Discount shop pack of 10 - Priced per package

CHRYSLER/FORCE

HP	Year	Serial No.	Impeller	Impeller Kit	Thermostat
9.9	1979-97	ALL	18-8903	18-3240	—
9.9/15	1998	E288600-E344999 ①	18-3062	—	—
10	1974-78	ALL	18-8903	18-3240	—
12	1979	ALL	18-8903	18-3240	—
15	1974-97	ALL	18-8903	18-3240	—
20	1973-78	ALL	18-8903	18-3240	—
20	1979-82	ALL	18-8901	18-3240	—
25	1973-78	ALL	18-8903	18-3240	—
25	1996-98	E127700-E344999	18-3057	18-3215	18-3556
30	1980-82	ALL	18-8901	—	—
35	1976-78, 83-84 & 86-88	ALL	18-8901	—	18-3556
35	1979-82	ALL	18-3084	—	18-3556
40/50	1992-94	E065372-E093669	—	—	18-3556
40/50	1995-99	E093700-E369299	18-3057	—	18-3556

- ① Except model "C" for 1988
- ② 1989 "D" & "E" models
- ③ Mercury Lower Unit

APPLICATION CONTINUED ON NEXT PAGE

CHRYSLER/FORCE (Cont.)

HP	Year	Serial No.	Impeller	Impeller Kit	Thermostat
50	1984-91, 1992A	N/A	—	—	18-3556
70	1979-80	ALL	18-3085		18-3559
70	1991-95	E138600-E345999	18-8900	—	—
75	1979	ALL	18-3085		18-3559
75	1980	ALL	18-3030		18-3559
75	1996-98	E138600-E345999	18-8900	—	—
75	1999	E345000-UP	18-3057	—	—
85	1977-88	ALL	18-3030		18-3559
85	1989	A, B	18-3030		18-3559
85	1989	C, E	18-3030		—
85	1989	D, F, G, H	18-3017		—
85	L-DRIVES 1989	A, B, C	18-3017	—	—
90	1991A, B, C, D-1992C	E000001-E039023	18-3017	18-3251	—
90	1992-94	E039024-E093699	18-3017	18-3251	—
90	1995-97	E093700-UP	18-3056	18-3214	—
90 L-DRIVE	1991	N/A	18-3017	18-3251	—
90 & L-DRIVE	1990	N/A	18-3017	18-3251	—
SPORT JET 90	1993-94	E023150-E066619	—	—	—
SPORT JET 90	1995-96	E138325-E138599	—	—	—
SPORT JET 95XR	1996-97	E141089-UP	—	—	—
100	1979-80	ALL	18-3030		18-3559
105	1977-78	ALL	18-3030		18-3559
115	1977-80	ALL	18-3030		18-3559
120/135	1977	ALL	18-3030		18-3559
120	1990A-91C	N/A	18-3017	18-3251	—
120	1991D-92C & 1993, 1994	E000001-E093699	18-3017	18-3251	—
120	1995-97	E093700-UP	18-3056	18-3214	—
120 L-DRIVE	1990-92	N/A	18-3017	18-3251	—
120 SPORT JET	1995-97	E095088-E138599	—	—	—
125	1981-89	ALL	18-3030	—	18-3559 00
125	1988	C	18-3030	—	—
125 L-DRIVE	1989	N/A	18-3017	18-3251	18-3559
140	1978-80	ALL	18-3030		18-3559
150	1989-92	UP TO E065371	18-3017	18-3251	—
150	1993-UP	E000001-E093699	18-3017	18-3251	—

① Except model "C" for 1988 ② 1989 "D" & "E" models ③ Mercury Lower Unit

CHRYSLER IMPELLER APPLICATION

HP	Model	Year	Serial #	Impeller	Impeller Kit	Thermostat
9.9	9.9	1979-1997	All	18-8903	18-3240	N/A
9.9 / 15	9.9 / 15	1998	E268600 - E344999 ①	18-3062	N/A	N/A
10	10	1974-1978	All	18-8903	18-3240	N/A
12	12	1979	All	18-8903	18-3240	N/A
15	15	1974-1997	All	18-8903	18-3240	N/A
20	20	1973-1978	All	18-8903	18-3240	N/A
20	20	1979-1982	All	18-8901	18-3240	N/A
25	25	1973-1978	All	18-8903	18-3240	N/A
25	25	1996-1998	E127700 - E344999	18-3057	18-3215	18-3556
30	30	1980-1982	All	18-8901	N/A	N/A
35	35	1976-1978	All	18-8901	N/A	18-3556
35	35	1983-1984	All	18-8901	N/A	18-3556
35	35	1986-1988	All	18-8901	N/A	18-3556

① Mercury lower unit ② Except model "c" for 1988 ③ 1989 "D" & "E" models

APPLICATION CONTINUED ON NEXT PAGE

CHRYSLER IMPELLER APPLICATION

HP	Model	Year	Serial #	Impeller	Impeller Kit	Thermostat
35	35	1979-1982	All	18-3084	N/A	18-3556
40 / 50	40 / 50	1992-1994	E065372 - E093669	N/A	N/A	18-3556
40 / 50	40 / 50	1995-1999	E093700 - E369299	18-3057	N/A	18-3556
50	50	1984-1991	N/A	N/A	N/A	18-3556
50	50	1992A	N/A	N/A	N/A	18-3556
70	70	1979-1980	All	18-3085	N/A	18-3559
70	70	1991-1995	E138600 - E345999	18-8900	N/A	N/A
75	75	1979	All	18-3085	N/A	18-3559
75	75	1980	All	18-3030	N/A	18-3559
75	75	1996-1998	E138600 - E345999	18-8900	N/A	N/A
75	75	1999	E345000 & UP	18-3057	N/A	N/A
85	85	1977-1988	All	18-3030	N/A	18-3559
85	85	1989	A, B	18-3030	N/A	18-3559
85	85	1989	C, E	18-3030	N/A	N/A
85	85	1989	D, F, G, H	18-3017	N/A	N/A
85	L-DRIVES	1985	A, B, C	18-3017	N/A	N/A
90	A, B, C, D	1991	E000001 - E039023	18-3017	18-3251	N/A
90	C	1992	E000001 - E039023	18-3017	18-3251	N/A
90	90	1983-1984	ALL	18-3030	N/A	N/A
90	90	1992-1994	E039024 - E093699	18-3017	18-3251	N/A
90	90	1995-1997	E093700 & UP	18-3056	18-3214	N/A
90	90 L-DRIVE	1991	N/A	18-3017	18-3251	N/A
90	90 / 90 L-DRIVE	1990	N/A	18-3017	18-3251	N/A
90	SPORT JET 90	1993-1994	E023150 - E066819	N/A	N/A	N/A
90	SPORT JET 90	1995-1996	E138325 - E138599	N/A	N/A	N/A
95	SPORT JET 95XR	1996-1997	E141089 & UP	N/A	N/A	N/A
100	100	1979-1981	ALL	18-3030	N/A	18-3559
100	100	1983-1984	ALL	18-3030	N/A	N/A
105	105	1977-1978	ALL	18-3030	N/A	18-3559
105	105	1982	ALL	18-3030	N/A	N/A
115	115	1977-1982	ALL	18-3030	N/A	18-3559
120 / 135	120 / 135	1977	ALL	18-3030	N/A	18-3559
120	1990A	1990	N/A	18-3017	18-3251	N/A
120	1991C	1991	N/A	18-3017	18-3251	N/A
120	1991D	1991	E000001 - E093699	18-3017	18-3251	N/A
120	1992C	1992	E000001 - E093699	18-3017	18-3251	N/A
120	1993-1994	1993-1994	E000001 - E093699	18-3017	18-3251	N/A
120	120	1995-1997	E093700 & UP	18-3056	18-3214	N/A
120	120 L-DRIVE	1990-1992	N/A	18-3017	18-3251	N/A
120	120 SPORT JET	1995-1997	E095088 - E138599	N/A	N/A	N/A
125	125	1981-1989	ALL	18-3030	N/A	18-3559 ②③
125	125	1988	C	18-3030	N/A	N/A
125	125 L-DRIVE	1989	N/A	18-3017	18-3251	18-3559
140	140	1978-1982	ALL	18-3030	N/A	18-3559
150	150	1989-1992	UP TO E065371	18-3017	18-3251	N/A
150	150	1993 & UP	E000001 - E093699	18-3017	18-3251	N/A

① Mercury lower unit

② Except model "c" for 1988

③ 1989 "D" & "E" models



FORCE PISTON APPLICATION

HP/Model	Cyl.	Bore Size	Piston	OEM Part #	Rings	OEM Part #
40-50	2	3.312 / STD.	18-4629	700-834794T3, FA691015, 700-F694015	18-39010 ①	39-817869A1, FA663260
40-50	2	3.322 / .010	18-4630	700-834794A4, 700-FSA694015	—	39-817869A2, FSA335260
40-50	2	3.342 / .030	18-4631	700-834794A5, 700-818134A1	—	39-817869A3, 39-818110A1
40-50	2	3.375 / STD	18-4632	700-834800A4, 700-819005A8	18-3998 ①	39-8204757A2, FA528269, FA528260, 39-820457A1, 39-820457A2
40-50	2	3.385 / .010	18-4633	700-834800A5, 700-819005A12, 700-834800A2	18-3999	39-820641A1
40-50	2	3.405 / .030	18-4634	700-834800A6	—	39-818129A2
85-90 & L-DRIVES	3	3.312 / STD.	18-4629	700-834794T3, FA691015	18-39010 ①	39-817869A1, FA663260
85-90 & L-DRIVES	3	3.322 / .010	18-4630	700-834794A4, 700-FSA694015	—	39-817869A2, FSA335260
85-90 & L-DRIVES	3	3.342 / .030	18-4631	700-834794A5, 700-818134A1	—	39-817869A3, 39-818110A1
90 L-DRIVE, SPORT JET	3	3.375 / STD.	18-4632	700-834800A4, 700-819005A8	18-3998 ①	39-8204757A2, FA528269, FA528260, 39-820457A1, 39-820457A2
90 L-DRIVE, SPORT JET	3	3.385 / .010	18-4633	700-834800A5, 700-819005A12, 700-834800A2	18-3999	39-820641A1
90 L-DRIVE, SPORT JET	3	3.405 / .030	18-4634	700-834800A6	—	39-818129A2
120-150	4	3.312 / STD.	18-4629	700-834794T3, FA691015, 700-F694015	18-39010 ①	39-817869A1, FA663260
120-150	4	3.322 / .010	18-4630	700-834794A4, 700-FSA694015	—	39-817869A2, FSA335260
120-150	4	3.342 / .030	18-4631	700-834794A5, 700-818134A1	—	39-817869A3, 39-818110A1
120 L-DRIVE, SPORT JET	4	3.375 / STD.	18-4632	700-834800A4, 700-819005A8	18-3998 ①	39-8204757A2, FA528269, FA528260, 39-820457A1, 39-820457A2
120 L-DRIVE, SPORT JET	4	3.385 / .010	18-4633	700-834800A5, 700-819005A12, 700-834800A2	18-3999	39-820641A1
120 L-DRIVE, SPORT JET	4	3.405 / .030	18-4634	700-834800A6	—	39-818129A2

① Keystone Rings

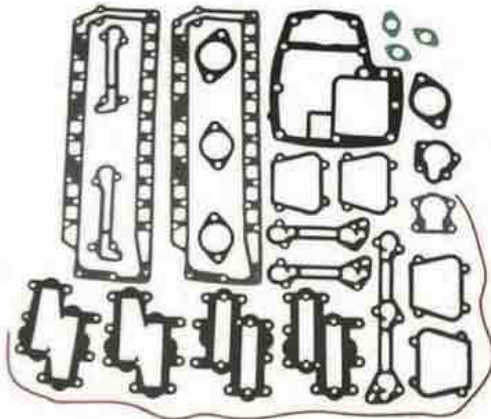

18-4312 POWERHEAD GASKET SET

Powerhead Gasket Sets Do Not Include Head Gaskets

— CONTAINS —

PART #	GASKET DESC.	O.E. #	QTY.
18-0968	Cyl. Drain Reed Plate	27-FB4748-3	2
18-0861	Cyl. Drain Reed Plate	27-F65748-2	1
18-0869	Port. Cover Gasket	27-F40223	4
18-0915	Deflector Plate	27-F408406	2
18-0854	Thermostat Cover	27-F476067	1
18-0958	Exhaust Plate	27F-372154	2
18-0960	Carburetor	27-F85906	2
18-0141	By-Pass	27-F85762	2
18-0915	Carburetor	27-F440906	2

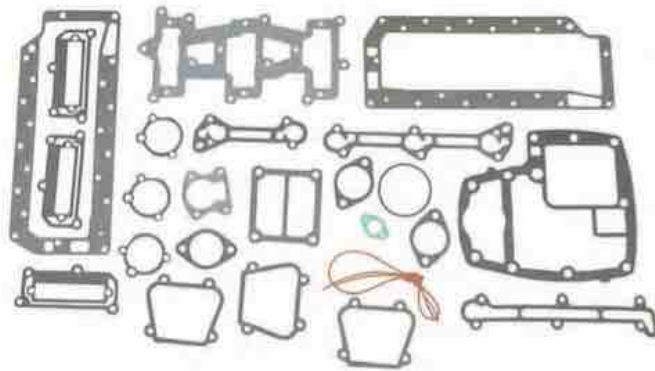

**18-4313
POWERHEAD GASKET SET**

Powerhead Gasket Sets Do Not Include Head Gaskets

— CONTAINS —

PART #	GASKET DESC.	O.E. #	QTY.
18-0968	Cyl. Drain Reed Plate	27-F84748-3	1
18-0853	Manifold	27-F85159-1	1
18-0855	Carburetor Adapter Flange	27-F85168-1	3
18-0857	Cyl. Drain Cover	27-F85472-2	1
18-0861	Cyl. Drain Reed Plate	27-F85748-2	1
18-0869	Port Cover	27-F40223	2
18-0854	Thermostat Cover	27-F476067	1
NSS	Intake	27F-481836	3
18-0119	Exhaust Port Plate	27-F85154	2
18-0114-1	Manifold End Cap	907761	1
18-7108	O-Ring	—	1
18-0960	Carburetor	27-F85906	3
18-0141	By-Pass	27-F85762	2
18-2534	Seal	184122-1	1

CHRYSLER POWERHEAD GASKET SET APPLICATION

HP	Years	Part #	HP	Years	Part #	HP	Years	Part #
45	1972-83 ①	—	85	1970-73, 1977-88	18-4313	120	1971-77	18-4312
50	1981-87	—	90	1974-77	18-4313	125	1983-88 ②	18-4312
55	1972-76 ①	—	100	1979-81, 1983	18-4312	130	1972	18-4312
70	1970-73, 1979-80	18-4313	105	1972-76, 1982	18-4312	135	1974-77	18-4312
75	1974-83	18-4313	115	1977-83	18-4312	140	1978-83	18-4312

① Beginning mid year 1972 All BC, BE, HC & HE Models

② For 1988 A & B Models

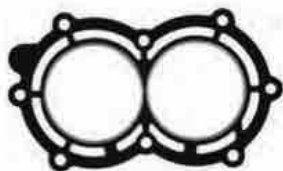

**18-3851
HEAD GASKET**

Replaces: 27-F286529-3
For: 9.9 and 15 HP

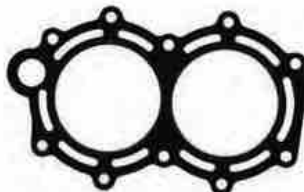

**18-3852
HEAD GASKET**

Replaces: 27-F513529
For: 25 and 35 HP

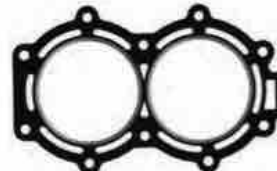

**18-3853
HEAD GASKET**

Replaces: 27-F691529-1
For: 45 and 50 HP

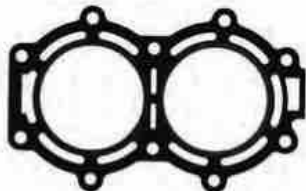

**18-3854
HEAD GASKET**

Replaces: 27-F658529
For: 50 HP

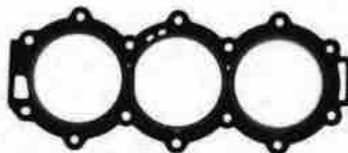

**18-3855
HEAD GASKET**

Replaces: 27-820438
For: 70, 75, 85 and 90 HP

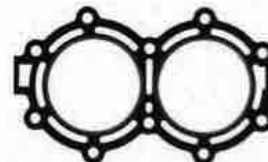

**18-3856
HEAD GASKET**

Replaces: 27-F201529-1
For: 1984-1987 "A" models 50 HP



**18-3857
HEAD GASKET**

Replaces: 27-824615/27-824615-2, F476529, F476529-1, F476529-2, 27-F476529-4
For: 100 thru 140 H.P.

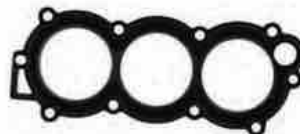

**18-3859
HEAD GASKET**

Replaces: 27-819138-2
For: 25 HP (E127700-E344999)

HEAD GASKET APPLICATION

HP	Model/Year	Serial #	Part No.	HP	Model/Year	Serial #	Part No.
9.9/15	1984-92,A,B	N/A	18-3851	90	1990-92,C,E	N/A	18-3855
9.9/15	1992-98	E000001 & UP	18-3851	90	1991-99	E000001 & UP	18-3855
25	1989A,B	N/A	18-3852	90	1990-91 L-DRIVE,A,B,C,D	N/A	18-3855
35	1986-91,A,B,C	N/A	18-3852	90	1993-95 SPORT JET	E023150-E138599	18-3855
40	1992C & 1992-99	E000001 & UP	18-3853	95	1996-97 SPORT JET XR	E141089 & UP	18-3855
50	1990A,1989-92,B,C,D,Z	N/A	18-3853	120	1990-92,A,C	N/A	18-3857
50	1984-87,A	N/A	18-3856	120	1990-99	E000001 & UP	18-3857
50	1988-89,A/1987-88,B,C,D	N/A	18-3854	120	1990-92,A,B,C,D L-DRIVE	N/A	18-3857
70	1991-92,B,C	N/A	18-3855	120	1995-99 SPORT JET,XR,XR2	N/A	18-3857
70	1992-95	E000001 & UP	18-3855	125	1983-89, A	N/A	18-3857
75	1996-99	E138600 & UP	18-3855	125	1986-89, B	N/A	18-3857
85	1984-88,A,L/1986-89,B,C,	N/A	18-3855	125	1988-89, C	N/A	18-3857
85	1986,M,N	N/A	18-3855	125	1989, D, E	N/A	18-3857
85	1985 L-DRIVE A,B,C	N/A	18-3855	150	1989A-1992C		N/A
85	1989,D,E,F,G,H	N/A	18-3855	150	1989-1994	E000001-E093699	N/A
90	1990-91,A,B,D	N/A	18-3855				

PKG. OF 2



**18-0141
18-0141-9①
BYPASS GASKET**
Replaces: 27-F85762

PKG. OF 2



**18-0315
18-0315-9①
CARBURETOR GASKET**
Replaces: 27-F440906

PKG. OF 2



**18-0960
18-0960-9①
CARBURETOR
MOUNTING GASKET**
Replaces: 27-F85906



**18-0314
CARBURETOR ADAPTER
GASKET**
Replaces: 27-828316, 27-F178168,
27-F178168-1, F178168

PKG. OF 2



**18-0855
18-0855-9①
CARBURETOR ADAPTER
FLANGE GASKET**
Replaces: 27-F85168-2

PKG. OF 2



**18-0915
DEFLECTOR
PLATE GASKET**
Replaces: 27-F406406



**18-0861
CYLINDER DRAIN
REED PLATE GASKET**
Replaces: 27-F85748-2

PKG. OF 2



**18-0119
18-0119-9①
EXHAUST
PLATE GASKET**
Replaces: 27-F85154-1



**18-0958
EXHAUST
PLATE GASKET**
Replaces: 27-F372154-1

PKG. OF 2



**18-0869
18-0869-9①
PORT COVER
GASKET**
Replaces: 27-F40223, 27-820500A3

PKG. OF 2



**18-0115
18-0115-9①
POWERHEAD
BASE GASKET**
Replaces: 27-F307279-2

SEE PAGES 219 FOR OUR COMPLETE LINE OF GASKET SEALANTS

① Priced per Package



18-0154
LOWER EXHAUST
CYLINDER GASKET
 Replaces: 27-F40279-1

PKG. OF 2



18-0854
18-0854-9①
THERMOSTAT
COVER GASKET
 Replaces: 27-F476067

PKG. OF 2



18-0873
18-0873-9①
THERMOSTAT GASKET
 Replaces: 27-F97067, 27-818377



18-0622
LOWER WEAR
PLATE GASKET
 Replaces: 27-19701

PKG. OF 2



18-0415
18-0415-9①
WATER PUMP GASKET
 Replaces: 27-F523031

PKG. OF 2



18-0416
WEAR PLATE GASKET
 Replaces: 27-F694830

PKG. OF 2



18-2534
SEAL
 (40")
 Replaces: F184122-1



18-2370
BEARING CARRIER
 Replaces: 19291A3
 For: Force 40/50 HP (1995-99), 70 HP (1991-95), 75 HP (1996-98), Mercury/Mariner 30/40 HP 2 cyl (9854537-OPD16999), 30/40 4-stroke (OG760300-up), 40/50 HP/30Jet 3 cyl (9973100-up), 60 HP 3 cyl (OD000750-up), 60 HP 4-stroke 9973100-up)

① 18-2375D



18-2375
DRAIN PLUG (MAGNET)
18-23751-9①
 (Package of 50 without gasket)



18-2624
LOWER UNIT SEAL KIT
 Replaces: 26-85090A2

— CONTAINS —



18-2626
LOWER UNIT SEAL KIT
 Replaces: 26-43035A4

— CONTAINS —

PART #	DESC.	O.E. #	QTY.
18-0579	Oil Seal	26-41131	1
18-0580	Oil Seal	26-41132	1
18-0586	Seal	26-99325	2
18-7419	O-Ring	25-69202	1
18-2562	Gear Hsg to Face Plate Gasket	27-99326-1	1
18-2945	Drain Screw Gasket	12-19183	2
18-2742	Boot	85552	1
18-2560	Washer	12-86645	2
18-7135	O-Ring	25-35276	1
18-7956	O-Ring	25-85549	1
18-7100	O-Ring	25-85594	1
18-7959	O-Ring	25-99691	1

PART #	DESC.	O.E. #	QTY.
18-0522	Oil Seal	26-43036	1
18-0583	Oil Seal	26-43035	1
18-2002	Oil Seal	26-76868	1
18-2053	Oil Seal	26-70081	1
18-2054	Oil Seal	26-816464	1
18-2563	Face Plate to Water Pump Cover Gasket	27-43034-1	1
18-2564	Water Pump Base to Face Plate Gasket	27-43033-1	1
18-2565	Water Pump Base to Gear Hsg Gasket	27-43047-2	1
18-2566	Face Plate to Water Pump Cover Gasket	27-817277	1
18-2945	Drain Screw Gasket	12-19183	3
18-4261	Washer	19643	1
18-7198	O-Ring	25-45710	1

SEE PAGES 219 FOR OUR COMPLETE LINE OF GASKET SEALANTS

① Priced per Package

APPLICATION FOR SEAL KITS ON PAGE 256



18-2629
LOWER UNIT SEAL KIT
Replaces: 26-85090A1



18-2630
LOWER UNIT SEAL KIT
Replaces: FK1060



18-2631
LOWER UNIT SEAL KIT
Replaces: FK1061



18-2632
LOWER UNIT SEAL KIT
Replaces: FK1063-2, FK1063-1

- CONTAINS -

PART #	DESC.	O.E. #	QTY.
18-2945	Drain Screw Gasket	10-79953A2	3
18-7127	O-Ring	25-F84305	1
18-0500	Seal	26-817472	1
18-0512	Seal	26-F84307-1	1
18-7169	O-Ring	25-F24278	1
18-7176	O-Ring	25-90011	1
18-7467	O-Ring	25-54030	1
18-7141	O-Ring	802047	1



18-2633
LOWER UNIT SEAL KIT
Replaces: FK1127



18-2635
LOWER UNIT SEAL KIT
Replaces: 26-814669A2, 26-814669A1, FK1234

- CONTAINS -

PART #	DESC.	O.E. #	QTY.
18-0500	Seal	26-817472	1
18-0822	Lower Wear Plate Gasket	27-19701	1
18-2051	Seal	26-69188	1
18-2052	Seal	26-69189	1
18-2945	Drain Screw Gasket	12-19183	3
18-7168	O-Ring	25-48171	2
18-7173	O-Ring	25-30224	1
18-7950	O-Ring	25-45258	1



18-2636
LOWER UNIT SEAL KIT
Replaces: 26-820645A, FK1074

- CONTAINS -

PART #	DESC.	O.E. #	QTY.
18-0500	Seal	26-817472	1
18-0502	Seal	26-819396	1
18-0503	Seal	26-F40307-2	1
18-2945	Drain Screw Gasket	12-19183	2
18-7116	O-Ring	25-62704	1
18-7134	O-Ring	25-F40342	1
18-7141	O-Ring	25-25007	1
18-7952	O-Ring	25-88657	1



18-2637-1
LOWER UNIT SEAL KIT
Replaces: FK1064

- CONTAINS -

PART #	DESC.	O.E. #	QTY.
18-0500	Seal	26-817472	1
18-0592	Seal	26-F318307	1
18-2945	Drain Screw Gasket	12-19183	2
18-7149	O-Ring	25-525555	1
18-7171	O-Ring	25-F52305	1
18-7191	O-Ring	25-F474342	1



18-2638
LOWER UNIT SEAL KIT
Replaces: FK1065

- CONTAINS -

PART #	DESC.	O.E. #	QTY.
18-0500	Seal	26-817472	1
18-0584	Seal	26-68022, 26-F346118	1
18-0593	Seal	26-F901307-2	2
18-0623	Lower Unit Gasket	27-F286555	1
18-2945	Drain Screw Gasket	12-19183	3
18-7138	O-Ring	25-F455305	1



18-2639
LOWER UNIT SEAL KIT
Replaces: FK1068

- CONTAINS -

PART #	DESC.	O.E. #	QTY.
18-0584	Seal	26-66022	1
18-2945	Drain Screw Gasket	12-19183	2
18-7134	O-Ring	25-F498618	1
18-7141	O-Ring	25-25007	1
18-7176	O-Ring	25-90011	1



18-2640
LOWER UNIT SEAL KIT
Replaces: FK1203-1, FK1203

- CONTAINS -

PART #	DESC.	O.E. #	QTY.
18-0500	Seal	26-817472	1
18-2014	Seal	26-F694305	1
18-2076	Seal	26-12224	1
18-2077	Seal	26-14077	1
18-2945	Drain Screw Gasket	12-19183	3
18-7426	Grommet	25-30271	1
18-7127	O-Ring	25-F84305	1
18-7134	O-Ring	25-F498618	1
18-7169	O-Ring	25-F24278	1
18-7176	O-Ring	25-F4305	1
18-7413	O-Ring	25-62702	4



18-2697-1
LOWER UNIT SEAL KIT
Replaces: 26-41365A3

- CONTAINS -

PART #	DESC.	O.E. #	QTY.
18-0581	Oil Seal	26-413651	2
18-0584	Oil Seal	26-66022	1
18-0585	Oil Seal	26-821928	1
18-0586	Oil Seal	26-99325	1
18-2728	Water Tube Seal	26-42102-1	1
18-2945	Drain Screw Gasket	12-19183	2
18-3149-2	Water Pump Base	46-42040A5	1
18-4261	Washer	19643	1
18-7162	O-Ring	25-33145	1

APPLICATION ON NEXT PAGE

CHRYSLER/FORCE LOWER UNIT SEAL KIT APPLICATION

Model / HP	Year	Seal Kit	Model / HP	Year	Seal Kit	Model / HP	Year	Seal Kit
6/7.5	1978-Up	18-2637	55	1972 1/2-1974	18-2636	85 L Drive	1989	18-2640
9.9/15	1997 & prior	18-2638	55 ②	1978-82	18-2630	90	1974-77	18-2631
9.9/15	1998	18-2697-1	55 ①	1983	18-2633	90	1983	18-2632
20/25	1972-78	18-2639	60 ②	1984 & Prior	18-2630	90	1990-94	18-2640
25	1989	18-2636	60 ①	1985	18-2633	90	1995-99	18-2626
25	1996-97	18-2624	65 ③	All	18-2633	90 L Drive	1990-91	18-2640
25	1998	18-2629	70	1970-73	18-2631	105	1970-76	18-2631
35	1970-72	18-2630	70	1979	18-2631	105	1979-83	18-2632
35	1972 1/2	18-2636	70	1991-95	18-2635	120	1990-94	18-2640
35	1973	18-2630	75	1975-79	18-2631	120	1995-99	18-2626
35	1974-75	18-2636	75	1980-83	18-2632	125 ③	1983-89	18-2632
35	1986-91	18-2639	75	1996-98	18-2635	125 D & E	1989	18-2640
35 B	1989-91	18-2636	75	1999	18-2626	125 L Drive	1989	18-2640
40	1992-94	18-2636	85	1980-89	18-2632	150	1989-94	18-2640
50	1984-94	18-2636	① With one piece lower units ② With two piece lower units ③ 1989 A,B,C Models Only					

① 18-3701D



**18-3701
PROP NUT KIT**

— CONTAINS —

Part #	O.E. #	Description	QTY.
18-3200	F697140	Tab Washer	2
18-3700	F7000	Prop Nut	1



**18-4446
PROP WRENCH KIT
(18-4444 Wrench Only)**

— CONTAINS —

Part #	Desc.	QTY.
18-3200	Tab Washer	2
18-3700	Prop Nut	1
18-4444	Prop Wrench	1

PROP NUT & TAB WASHER APPLICATION

HP	Year	Model Type	Tab Washer	Prop Nut	Prop Nut Kit
90 ④	1990	A	—	18-3700	—
90	1990	B, C	18-3200	18-3700	18-3701
90	1991	ALL	18-3200	18-3700	18-3701
90 L-Drive	1990	C	18-3200	18-3700	18-3701
90 L-Drive	1991	ALL	18-3200	18-3700	18-3701
120	1990	A	—	18-3700	—
120	1990	B,C	18-3200	18-3700	18-3701
120	1991	ALL	18-3200	18-3700	18-3701
120 L-Drive	1990	ALL	18-3200	18-3700	18-3701
120 L-Drive	1991	B,D	18-3200	18-3700	18-3701
125 L-Drive	1989	ALL	—	18-3700	—
150	1989	ALL	—	18-3700	—
150	1990	A	—	18-3700	—
150	1990	B, C, D	18-3200	18-3700	18-3701
150	1991	ALL	18-3200	18-3700	18-3701

④ 903F90A, X90A, 908F90A, X90A Models only.



**18-2254
PROP SHAFT**
Replaces: 44-850308



**18-3719
PINION NUT**
Replaces: 11-35921, 11-47411,
11-826375, 11-F694188
5/8" - 18 thread • 1 1/16" wrench



18-1112
REVERSE GEAR
THRUST BEARING
Replaces: 31-F523901



18-1113
REVERSE GEAR BEARING
Replaces: 31-F523143

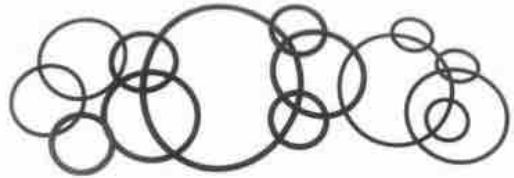

O-RINGS

Part No.	O.E. No.	Dimensions	
		I.D.	Width
18-7120	25-F498618	0.215	0.085
18-7127	25-F84305, 25-32507, F83404	3.315	0.135
18-7134 ●(7)	25-20195, 25-201951	0.5	0.1
18-7169 ●(7)	25-F24278	3.5	0.135
18-7176 ●(7)	25-F74305	2.16	0.1
18-7457	25-F455305	1.799	0.103
18-7950	25-45258	9.843	0.984
18-7952 ●(7)	25-88657	2.4803	0.1378
18-7956 ●(7)	25-85549	2.4803	0.1969
18-7100 ●(7)	25-85594	0.2362	0.1575

● PKG OF 5



18-79989
TRAILERING STICKS
Fits: Most outboards over 150hp with three ram
intrigrel tilt/trim.



OIL SEALS

Part No.	O.E. No.	Part No.	O.E. No.	Part No.	O.E. No.
18-0500	26-817472	18-0580	26-41132	18-0593	26-F901307-2
18-0502	26-819396	18-0583	26-43035	18-8347	26-8164641, 26-816464, 26-76384
18-0503	26-F40307-2	18-0584	26-66022, 26-F346118	18-8354	26-828627
18-0512	26-F84307-1	18-0586	26-99325		
18-0579	26-41131	18-0592	26-F318307		

THE VERY BEST PARTS OF BOATING

Sierra
Marine Engine and Drive Parts



Honda Model Number Identification

	Manufacturer	Horse-power	Model Year	Shaft Length	Steering System	Market
BF2	BF = Honda	EX: 2	DX = 1999 DY = 2000 D1 = 2001 D2 = 2002 D3 = 2003 D4 = 2004 D5 = 2005 D6 = 2006 DK0 = 2007-up	S = 15" L = 20"	H = Throttle Grip C = Centrifugal Clutch	A = American

EXAMPLE: BF2D1SCHA = Honda, 2 HP, 2001 Model, 15", Centrifugal Clutch w/Throttle Grip, American

	Manufacturer	Special Features	Horse-power	Model Year	Shaft Length	Steering System	Starter	Market
BF5- BF20	BF = Honda	P = High Thrust Propeller = Standard Propeller	EX: 5 20	D1 = 2001 D2 = 2002 D3 = 2003 D4 = 2004 D5 = 2005 D6 = 2006 DK0 = 2007-up	S = 15" L = 20" XL = 25"	H = Throttle Grip C = Centrifugal Clutch	S = Electric T = Electric w/ Power Tilt	A = American

EXAMPLE: BFP5D1LHSA = Honda, High Thrust Prop., 5 HP, 2001 Model, 20", Throttle Grip, Elec. Start, American

	Manufacturer	Horse-power	Model Year	Shaft Length	Steering System	Tilt & Trim	Market
BF25- BF225	BF = Honda	EX: 25 115 225	AX = 1999 AY = 2000 A1 = 2001 A2 = 2002 A3 = 2003 A4 = 2004 A5 = 2005 A6 = 2006 K0 = 2007-up	S = 15" L = 20" X = 25" XX = 30"	R = Remote Control H = Tiller Handle	T = Tilt & Trim = Manual Tilt J = Jet Drive	A = American

EXAMPLE: BF25A1LRTA = Honda, 25 HP, 2001 Model, 20", Remote Control, Tilt & Trim, American

NOTE: After the 2006 model year Honda Marine dropped specific year designations.

		
<p>18-7494 COIL Replaces: 30520-PNA-007 Fits: 130/ 135/ 150/ 105 jet/ & 150 HP VTEC 1998-2007.</p>	<p>18-23251 IGNITION COIL Replaces: 30520-PWC-003 Fits: BF75(2007 & Up), BF90(2007 & Up)</p>	<p>18-5224 18-5224-9Ⓢ SPARK PLUG WIRE TERMINAL</p>
		
<p>18-5225 SPARK PLUG WIRE KIT Kit includes 25 ft. Roll of 7 MM Hypalon Ignition Wire With a Metallic Core and a Large Assortment of Three Different End Fittings to Fit Outboard Motors.</p>	<p>18-5226 IGNITION WIRE Metallic Core 100' Spool 7mm Hypalon</p>	<p>18-5750 18-5750-9Ⓢ UNIVERSAL SPARK PLUG BOOTS Supplied complete with Terminal Connector</p>
		
<p>18-6475 ALTERNATOR Replaces: 31630-ZW5-003 Fits: BF115 (1999 & Up), BF130 (1999-2004)</p>	<p>18-6476 ALTERNATOR Replaces: 31630-ZY6-003 Fits: BF135 & BF150 (2004 & Up)</p>	<p>18-6409 ALTERNATOR Replaces: 31630-ZY3-003 Fits: BF200 2002-14, BF225 02-14</p>

Ⓢ Priced per Package



18-6445
STARTER
 Replaces: Honda 31200-ZW9-802
 Fits: 8 & 9.9HP (2001 & Up)



18-6959
STARTER
 Replaces: 31200-ZY6-003, 31200-ZY9-003,
 31200-ZY9A-0031
 Fits: 75-150HP 2004-2010



18-15061
OUTBOARD STARTER
 Replaces: 31200-ZW1-004
 Fits: BF75-90(1997-06)



18-6433
OUTBOARD STARTER
 Replaces: 31200-ZV5-013
 Fits: 40 H.P. (1999-UP)



18-6258
TILT/TRIM MOTOR
 Replaces: 36120-ZV5-821
 Fits: BF35,BF40,BF45,BF50 (1992-2002)



18-6742
TRIM MOTOR
 Replaces: 36120-ZY3-023
 Fits: 200-225 HP (02-Up), 175 HP (07-Up)



18-6743
TRIM MOTOR
 Replaces: 36120-ZY9-003
 Fits: 75-90 HP (07-Up)



18-6745
TRIM MOTOR
 Replaces: 36120-ZY6-013
 Fits: 135-150 HP (04-Up), 115 HP (07-Up)



18-6793
TRIM MOTOR
 Replaces: 36120-ZV5-822
 Fits: 40,50 H.P. (2002-03)



18-6823
WIRING HARNESS
 Replaces: Universal
 Converts 3-wire Tilt and Trim motors to
 2-Wire design.

FUEL WATER SEPARATORS

Sierra offers a complete line of 10 and 21 micron fuel water separating filters including drainable bowl filters to protect your carbureted and fuel injected engine.

Refer to pages 153-158 for a complete listing of OEM and universal applications.

Sierra fuel water separators remove over 99.8% of emulsified water from your gasoline. Sierra's 10 micron filters are over 90% efficient at removing particles as small as 10 micron. All filters flow @ 90 GPH to feed even the hungriest motor. Sierra 10 micron filters are recommended to prevent damage to sensitive inboard and outboard fuel injection systems.

Sierra #	Honda #	Description
18-7947	17670-ZW1-030GH	Spin on Replacement Filter
18-7948	17670-ZW1-801AH	Spin on Replacement Filter
18-7521	16910-ZVL-003	Fuel Filter
18-7720	16900-SR3-004	Fuel Filter
18-7786	16900-SA5-004	Fuel Filter Kit
18-7785	16010-ST5-993	Fuel Filter Kit

9' LENGTH COMPLETE FUEL LINE ASSEMBLIES

3/8"
FUEL LINE ASSEMBLY

18-81042EP-2 *SILVERADO 4000 Premium* OE# 17700-ZW9-010
17700-ZW9-020



*



18-80400
TANK
CONNECTOR
(SOLD SEPARATELY)



18-80401
FUEL
CONNECTOR

18-8005EP-1
PRIMER
BULB

18-80403
FUEL
CONNECTOR



*

FUEL LINE ASSEMBLY COMPONENTS

Honda Fuel Application: 8, 9.9, 15, 25, 30, 40, 50, 75, 90, 115, 130 HP (2001-02)

* Tanks and Engines for picture purpose only.



18-8002EP-1
18-8002EP-1-10Ⓜ
PRIMER BULB
1/4"

18-8004EP-1
18-8004EP-1-10Ⓜ
PRIMER BULB
3/16"
Large capacity bulb

18-8005EP-1
18-8005EP-1-10Ⓜ
PRIMER BULB
3/8"
Replaces: 174512
Large capacity bulb



18-38008
FUEL CONNECTOR
Replaces: 17660-ZV5-902
Fits: 3/8" hose barb, Use with 18-80406



18-80401
FUEL CONNECTOR
Female hose connector, new style, 3/8" hose, Will not interchange with OE's 5/16" hose assemblies.
Mates with **18-80400**, tank outlet



18-80403
FUEL CONNECTOR
Female 3/8 hose connector with rectangular locking post, Will not interchange with OE's 5/16" hose assemblies. For late model engine: For use with our 18-81042 fuel hose assembly, motor end.
Mates with **18-80407**



18-80400
TANK CONNECTOR
Replaces: 16977-ZV5-A00
Male tank outlet, new style, 1/4"NPT, nickel plated brass, Male connector, for fuel tank.
Mates with **18-80401**



18-80406
FUEL CONNECTOR
Replaces: 16977-ZV5-900
Male tank outlet, old style, 1/4" NPT.



18-80407
FUEL CONNECTOR
Replaces: 17710-ZW9-033
5/16" with interlocking post
Fits: BF8-BF130 (2003)
Mates with **18-80403**, **18-80406**



18-80408
FUEL CONNECTOR
Replaces: 17650-ZW9-003
Female 5/16" connector with rectangular locking post. Fits late model engine
Mates with **18-80407**



18-80420
FUEL CONNECTOR
Replaces: 17650-921-003ZB
Fits: BF5/BF8A 2001 and earlier
Mates with 17710-881-00ZA

FUEL FILTERS



Part No.	OE No.
18-7712	16910-GB2-005
18-8226 *	16910-ZV4-015

* Retail Packaged Item



**18-79908
FUEL FILTER**

Replaces: 16911-ZY3-010
Fits: BF90(2007 & Up), BF115(1997 & Below, 2002 & Up), BF130(2002-04), BF135(2004 & Up), BF150(2004 & Up), BF175(2007 & Up), BF200(2002 & Up), BF225(2002 & Up), BF250(1997 & Below)



**18-79909
FUEL FILTER**

Replaces: 16901-ZY3-003
Fits: BF115D LA, BF115D XA, BF115D XCA, BF115DK1 LA, BF115DK1 XA, BF115DK1 XCA, BF135A4 LA, BF135A4 XA, BF135A4 XCA, BF135A5 LA, BF135A5 XA, BF135A5 XCA, BF135A6 LA, BF135A6 XA, BF135A6 XCA, BF135AK0 XA, BF135AK0 XCA, BF135AK2 LA, BF135AK2 XA, BF135AK2 XCA, BF150A4 LA, BF150A4 XA, BF150A4 XCA, BF150A5 LA, BF150A5 XA, BF150A5 XCA, BF150A6 LA, BF150A6 XA, BF150A6 XCA, BF150AK0 LA, BF150AK0 XA, BF150AK0 XCA, BF175AK1 LA, BF175AK1 XA, BF175AK1 XCA, BF175AK2 LA, BF175AK2 XA, BF175AK2 XCA, BF200A2 LA, BF200A2 XA, BF200A2 XCA, BF200A3 XA, BF200A3 XCA, BF200A3 XXA, BF200A3 XXCA, BF200A4 LA, BF200A4 XA, BF200A4 XCA, BF200A4 XXA, BF200A4 XXCA, BF200A5 LA, BF200A5 XA, BF200A5 XCA, BF200A5 XXA, BF200A6 LA, BF200A6 XA, BF200A6 XCA, BF200A6 XXA, BF200AK0 LA, BF200AK0 XA, BF200AK0 XCA, BF200AK1 LA, BF200AK1 XA, BF200AK1 XCA, BF200AK2 LA, BF200AK2 XA, BF200AK2 XCA



**18-7599
FUEL LOCK**

Protect your outboard from theft, disconnect fuel line and simply install fuel lock. Designed to fit clip on style fuel connectors. **Fits:** Johnson Evinrude, Mercury/Mariner, Yamaha and Honda.



**18-7658
OXYGEN SENSOR**

Replaces: 35655-ZY9-003



**18-7659
OXYGEN SENSOR**

Replaces: 35668-ZY6-003



**18-32153
OXYGEN SENSOR**

Replaces: 35655-ZY3-C01, 35655-ZZ5-004
Fits: BF40D, BF50D, BF250A (1997 & Prior), BF40DK2, BF50DK2, BF225AK1, BF225AK2 (2007 & Up)



**18-25200
CAMSHAFT SENSOR**

Replaces: 37500-PNB-003
Fits: 75 hp MPI



**18-25201
CAMSHAFT SENSOR**

Replaces: 37510-PNB-003
Fits: BF5 (2007 & Up), BF135 (2004 & Up), BF150 (2004 & Up)



**18-7552
SENSOR, MAP**

Replaces: 37830-PGK-A01
Fits: BF135A 2004-2006, BF135AK0, BF150A 2004-2006, BF150AK0, BF200A 2002-2006, BF200AK0, BF225A 2002-2006, BF225AK0



**18-7558
SENSOR, KNOCK**

Replaces: 30530-PPL-A01
Fits: BF135A 2004-2006, BF150 2004-2006



**18-7559
SENSOR, KNOCK**

Replaces: 30530-P8F-A01
Fits: BF200A 2002-2006, BF200AK0, BF225 2002-2006, BF225AK0



**18-7050
CARB KIT**

Fits: BF9.9(2000 & below), BF15(2002 & below)



**18-7051
CARB KIT**

Fits: BF9.9(2001 & Up), BF15(2003 & Up)



**18-7052
CARB KIT**

Fits: BF75(1997 & Up), BF90(1997 & Up)



**18-7053
CARB KIT**

Fits: BF8(1996 & below)BF75(1996 & below), BF100(1996 & below)



**18-7047
NEEDLE VALVE**

Replaces: 16011-ZV4-005
Fits: BF8(2001 & Up), BF9.9(All), BF15(All), BF20(2003 & Up), BF25(All), BF30(All), BF35(1997), BF40(All), BF45(1997), BF50(All), BF75(1997 & Up), BF90(1997 & Up)



**18-7048
NEEDLE VALVE**

Replaces: 16011-881-741
Fits: BF5(2003 & below), BF8(All), BF75(1997 & below), BF100(1997 & below)



18-3627
THERMOSTAT

Replaces: 19300-881-761
For: BF5A1, BF5A2, BF5A3, BF5A4, BF5A5, BF5A6, BF5A8, BF5AK, BF5AK0, BF5AM, BF5AW, BF5AX, BF5AY, BF8A3, BF8A4, BF8A5, BF8A6, BF8AH, BF8AK, BF8AK0, BF8AM, BF8AW, BF8AX, BF8AY, BF9.9AH, BF9.9AK, BF9.9AM, BF9.9AW, BF9.9AX, BF9.9AY, BF15A1, BF15A2, BF15AH, BF15AK, BF15AM, BF15AW, BF15AX, BF15AY, BF50F, BF75E, BF75F, BF100E, BF100F
52°C



18-3628-1
THERMOSTAT

Replaces: 19300-ZW9-003
For: BF8D1, BF8D2, BF8D3/BF15D3, BF15D4, BF15D5, BF15D6, BF15DK0, BF20D3, BF20D4, BF20D5, BF20D6, BF20DK0, BF25D4, BF25D5, BF25D6, BF25DK0, BF30D4, BF30D5, BF30D6, BF30DK0, BF40A4, BF40A5, BF40A6, BF40AK0, BF40D, BF50A4, BF50A5, BF50A6, BF50AK0, BF50D, BF60A, BFP60A, BF75DK0, BF90DK0, BF200A2, BF225A2
60°C



18-3630
THERMOSTAT

Replaces: 19300-ZV5-043
For: BF25A, BF25A1, BF25A2, BF25A3, BF25AW, BF25AX, BF25AY, BF30A, BF30A1, BF30A2, BF30A3, BF30AW, BF30AX, BF30AY, BF35AM, BF40A, BF40A1, BF40A2, BF40A3, BF40AW, BF40AX, BF40AY, BF45AM, BF50A, BF50A1, BF50A2, BF50A3, BF50AW, BF50AX, BF50AY, BF75A1, BF75A2, BF75A3, BF75A4, BF75A6, BF75AT, BF75AW, BF75AX, BF75AY, BF90A1, BF115A1, BF115A2, BF115AX, BF115AY, BF130A1, BF130A2, BF130AX, BF130AY
72°C



18-3122
IMPELLER PLATE

Replaces:
19231-ZW1-003
For: 75-90 HP



18-3031
IMPELLER

Replaces: 19210-ZY3-003
Fits: BF200 & BF225 (2002 & Up)



18-3100
IMPELLER

Replaces: 19210-ZW9-013,
19210-ZW9-003
Fits: BF8D/9.9D short, long shaft



18-3056
18-3056-10®
IMPELLER

Replaces: 19210-ZW1-003
For: 75-90 HP



18-3245
IMPELLER

Replaces: 19210-881-A01,
19210-881-A02, 19210-ZW9-A02
For: 7, 7.5, 8, 10 HP



18-32455
IMPELLER

Replaces: 19210-ZW9-A32,
19210-ZW9-A31
For: Honda 8 & 9.9 (2001 & Up);
Honda 15 & 20 (2003 & Up)



18-3246
IMPELLER

Replaces: 19210-ZV4-013,
19210-ZV4-651
For: BF9.9, BF15, AH, AK, AM, AW
Series # 14ZV40M



18-3247
IMPELLER

Replaces: 19210-ZV4-651
For: 8, 9.9, 15 HP



18-3248
IMPELLER

Replaces: 19210-ZV5-003
For: 35, 40, 45, 50 HP



18-3249
IMPELLER

Replaces: 19210-ZV7-003
For: 25, 30 HP



18-3250
IMPELLER

Replaces: 19210-ZW1-B04
For: 75, 90, 115, 130 HP



18-3268
IMPELLER KEY

Replaces: 90752-ZV4-650
Fits: BF9.9A, BF15A



18-3269
IMPELLER KEY

Replaces: 90752-ZV7-000
Fits: BF25, BF30



18-3270
IMPELLER KEY

Replaces: 90752-ZV5-003
Fits: BF35, BF40, BF45, BF50



18-3271
IMPELLER KEY

Replaces: 90752-ZW1-B02
Fits: BF75-BF90 AX & Up, BF115, BF130



18-3187
IMPELLER REPAIR KIT

Replaces: 06192-ZW1-305
Fits: (BF75-90, (1996-98)
Includes impeller 18-3056















18-3214D

18-3214
WATER PUMP KIT

Replaces: 19021-ZW1-003
For: BF 70/BF 90 1996-98
Includes impeller 18-3056



 <p>18-3278 WATER PUMP SERVICE KIT Replaces: 06192-ZV1-C00 Fits: BF5 Includes impeller 18-3245</p>	 <p>18-3279 WATER PUMP SERVICE KIT Replaces: 06192-881-C00 Fits: BF8A (USA) Includes impeller 18-3245</p>	 <p>18-3280 WATER PUMP SERVICE KIT Replaces: 06192-ZV4-000 Fits: BF9.9A/BF15A Includes impeller 18-3247</p>																																															
 <p>18-3281 WATER PUMP SERVICE KIT Replaces: 06192-ZV7-000 Fits: BF25/30 Includes impeller 18-3249</p>	 <p>18-3282 WATER PUMP SERVICE KIT Replaces: 06192-ZV5-003 Fits: BF35/45, BF40/50 Includes impeller 18-3248</p>	 <p>18-3283 WATER PUMP SERVICE KIT Replaces: 06192-ZW1-000 Fits: BF115/130, BF75/90 AX & Later Includes impeller 18-3250</p>																																															
 <p>18-3284 WATER PUMP SERVICE KIT Replaces: 06192-ZY6-000 Fits: BF135 / BF150 Includes impeller 18-3250</p>	 <p>18-3285 WATER PUMP SERVICE KIT Replaces: 06192-ZY3-000 Fits: BF200/225 Includes impeller 18-3031</p>	 <p>18-3478 WATER PUMP REPAIR KIT Without Housing Replaces: 06192-ZW9-A30 Fits: BFP8D/BFP9.9D (2003-06), BF15D/BF20D (2003-06), BFP20D (2004-06), BFP8D/BFP9.9D/BF15D/BFP15D/BF20D (K0, K2, K3), BFP20D (K0)</p> <table border="1"> <thead> <tr> <th colspan="4">-- CONTAINS --</th> </tr> <tr> <th>Part #</th> <th>Desc.</th> <th>O.E.#</th> <th>Qty.</th> </tr> </thead> <tbody> <tr> <td>18-32455</td> <td>Impeller</td> <td>19210-ZW9-A32</td> <td>1</td> </tr> <tr> <td>18-99153</td> <td>Gasket, Water Pump</td> <td>19232-ZW9-000</td> <td>1</td> </tr> <tr> <td>18-71335</td> <td>O-Ring</td> <td>91301-ZG3-000</td> <td>1</td> </tr> <tr> <td>18-3025</td> <td>Key, Impeller</td> <td>90752-ZW9-A30</td> <td>1</td> </tr> </tbody> </table>	-- CONTAINS --				Part #	Desc.	O.E.#	Qty.	18-32455	Impeller	19210-ZW9-A32	1	18-99153	Gasket, Water Pump	19232-ZW9-000	1	18-71335	O-Ring	91301-ZG3-000	1	18-3025	Key, Impeller	90752-ZW9-A30	1																							
-- CONTAINS --																																																	
Part #	Desc.	O.E.#	Qty.																																														
18-32455	Impeller	19210-ZW9-A32	1																																														
18-99153	Gasket, Water Pump	19232-ZW9-000	1																																														
18-71335	O-Ring	91301-ZG3-000	1																																														
18-3025	Key, Impeller	90752-ZW9-A30	1																																														
 <p>18-3489 WATER PUMP REPAIR KIT Without Housing Replaces: 06192-ZX2-C00 Fits: BF250A (ALL)</p> <table border="1"> <thead> <tr> <th colspan="4">-- CONTAINS --</th> </tr> <tr> <th>Part #</th> <th>Desc.</th> <th>O.E.#</th> <th>Qty.</th> </tr> </thead> <tbody> <tr> <td>18-3031</td> <td>Impeller</td> <td>19210-ZY3-003</td> <td>1</td> </tr> <tr> <td>18-99154</td> <td>Gasket, Water Pump</td> <td>19234-ZX2-C00</td> <td>1</td> </tr> <tr> <td>18-8299</td> <td>O-Ring</td> <td>91356-ZY3-003</td> <td>1</td> </tr> <tr> <td>NSS</td> <td>Key, Impeller</td> <td>90752-ZY3-003</td> <td>1</td> </tr> </tbody> </table>	-- CONTAINS --				Part #	Desc.	O.E.#	Qty.	18-3031	Impeller	19210-ZY3-003	1	18-99154	Gasket, Water Pump	19234-ZX2-C00	1	18-8299	O-Ring	91356-ZY3-003	1	NSS	Key, Impeller	90752-ZY3-003	1	 <p>18-3492 WATER PUMP REPAIR KIT Without Housing Replaces: 06192-ZW1-B04 Fits: BF75A/BF90A/BF115A/BF130A (1999-02)</p> <table border="1"> <thead> <tr> <th colspan="4">-- CONTAINS --</th> </tr> <tr> <th>Part #</th> <th>Desc.</th> <th>O.E.#</th> <th>Qty.</th> </tr> </thead> <tbody> <tr> <td>18-3250</td> <td>Impeller</td> <td>19210-ZW1-B04</td> <td>1</td> </tr> <tr> <td>18-0481</td> <td>Gasket, Water Pump</td> <td>19234-ZW1-600</td> <td>1</td> </tr> <tr> <td>18-0482</td> <td>Gasket, Water Pump</td> <td>19242-ZW1-800</td> <td>1</td> </tr> <tr> <td>18-1820</td> <td>Seal, Water Pump</td> <td>91251-ZW1-B04</td> <td>2</td> </tr> </tbody> </table>	-- CONTAINS --				Part #	Desc.	O.E.#	Qty.	18-3250	Impeller	19210-ZW1-B04	1	18-0481	Gasket, Water Pump	19234-ZW1-600	1	18-0482	Gasket, Water Pump	19242-ZW1-800	1	18-1820	Seal, Water Pump	91251-ZW1-B04	2
-- CONTAINS --																																																	
Part #	Desc.	O.E.#	Qty.																																														
18-3031	Impeller	19210-ZY3-003	1																																														
18-99154	Gasket, Water Pump	19234-ZX2-C00	1																																														
18-8299	O-Ring	91356-ZY3-003	1																																														
NSS	Key, Impeller	90752-ZY3-003	1																																														
-- CONTAINS --																																																	
Part #	Desc.	O.E.#	Qty.																																														
18-3250	Impeller	19210-ZW1-B04	1																																														
18-0481	Gasket, Water Pump	19234-ZW1-600	1																																														
18-0482	Gasket, Water Pump	19242-ZW1-800	1																																														
18-1820	Seal, Water Pump	91251-ZW1-B04	2																																														
 <p>18-3493 WATER PUMP REPAIR KIT Without Housing Replaces: 06192-ZW9-000 Fits: BF8D/BFP8D/BF9.9D/BFP9.9D (2002-06), BF8D, BFP8D/BF9.9D/BFP9.9D (K0, K2, K3)</p> <table border="1"> <thead> <tr> <th colspan="4">-- CONTAINS --</th> </tr> <tr> <th>Part #</th> <th>Desc.</th> <th>O.E.#</th> <th>Qty.</th> </tr> </thead> <tbody> <tr> <td>18-3100</td> <td>Impeller</td> <td>19210-ZW9-013</td> <td>1</td> </tr> <tr> <td>18-99153</td> <td>Gasket, Water Pump</td> <td>19232-ZW9-000</td> <td>1</td> </tr> <tr> <td>18-71335</td> <td>O-Ring</td> <td>91301-ZG3-000</td> <td>1</td> </tr> <tr> <td>18-3022</td> <td>Key, Impeller</td> <td>90752-ZW9-000</td> <td>1</td> </tr> </tbody> </table>	-- CONTAINS --				Part #	Desc.	O.E.#	Qty.	18-3100	Impeller	19210-ZW9-013	1	18-99153	Gasket, Water Pump	19232-ZW9-000	1	18-71335	O-Ring	91301-ZG3-000	1	18-3022	Key, Impeller	90752-ZW9-000	1	 <p>18-4536 WATER PUMP REPAIR KIT Without Housing Replaces: 06192-ZV4-A00 Fits: BF9.9A/15A (1998-01)</p> <table border="1"> <thead> <tr> <th colspan="4">-- CONTAINS --</th> </tr> <tr> <th>Part #</th> <th>Desc.</th> <th>O.E.#</th> <th>Qty.</th> </tr> </thead> <tbody> <tr> <td>18-3247</td> <td>Impeller</td> <td>19210-ZV4-651</td> <td>1</td> </tr> <tr> <td>18-2495</td> <td>Gasket, Water Pump</td> <td>19232-ZV4-610</td> <td>2</td> </tr> <tr> <td>18-8298</td> <td>Seal, Water Pump</td> <td>91252-935-004</td> <td>1</td> </tr> </tbody> </table>	-- CONTAINS --				Part #	Desc.	O.E.#	Qty.	18-3247	Impeller	19210-ZV4-651	1	18-2495	Gasket, Water Pump	19232-ZV4-610	2	18-8298	Seal, Water Pump	91252-935-004	1				
-- CONTAINS --																																																	
Part #	Desc.	O.E.#	Qty.																																														
18-3100	Impeller	19210-ZW9-013	1																																														
18-99153	Gasket, Water Pump	19232-ZW9-000	1																																														
18-71335	O-Ring	91301-ZG3-000	1																																														
18-3022	Key, Impeller	90752-ZW9-000	1																																														
-- CONTAINS --																																																	
Part #	Desc.	O.E.#	Qty.																																														
18-3247	Impeller	19210-ZV4-651	1																																														
18-2495	Gasket, Water Pump	19232-ZV4-610	2																																														
18-8298	Seal, Water Pump	91252-935-004	1																																														

Ⓛ Items ending in "D" are Display Packaged - Regular number is Non-Display • Ⓜ Discount shop pack of 10 - Priced per package











HONDA 4-STROKE WATER PUMP REPAIR KIT APPLICATION

Model	HP	Year	Honda Code	Impeller	Gasket	Kit without Housing
BF5A	5	1998-06	6315899	18-3245	18-2524	18-3276
BF5A	5	K0, K2, K3	6315899	18-3245	18-2524	18-3278
BF8A	8	1998-00	6315386	18-3245	18-2608 18-2609	18-3279
BF8A	8	2003-06	6315386	18-3245	18-2608 18-2609	18-3279
BF8A	8	K0	6315386	18-3245	18-2608 18-2609	18-3279
BF8D	8	2002-06	7452345	18-3100	18-99153	18-3493
BF8D	8	K0, K2, K3	7452345	18-3100	18-99153	18-3493
BFP8D	8	2002-06	7452345	18-3100	18-99153	18-3493
BFP8D	8	2002-06	7452352	18-32455	18-99153	18-3478
BFP8D	8	K0, K2, K3	7452345	18-3100	18-99153	18-3493
BFP8D	8	K0, K2, K3	7452352	18-32455	18-99153	18-3478
BF9.9A	9.9	1998-01	6310494	18-3247	18-2495	18-4536
BF9.9A	9.9	1999-02	7452360	18-3247	18-2495	18-3280
BF9.9D	9.9	2002-06	7452345	18-3100	18-99153	18-3493
BF9.9D	9.9	K0, K2, K3	7452345	18-3100	18-99153	18-3493
BFP9.9D	9.9	2002-06	7452345	18-3100	18-99153	18-3493
BFP9.9D	9.9	2002-06	7452352	18-32455	18-99153	18-3478
BFP9.9D	9.9	K0, K2, K3	7452345	18-3100	18-99153	18-3493
BFP9.9D	9.9	K0, K2, K3	7452352	18-32455	18-99153	18-3478
BF15A	15	1998-01	6310494	18-3247	18-2495	18-4536
BF15A	15	1999-02	7452360	18-3247	18-2495	18-3280
BF15D	15	2003-06	7452352	18-32455	18-99153	18-3478
BF15D	15	K0, K2, K3	7452352	18-32455	18-99153	18-3478
BFP15D	15	K0, K2, K3	7452352	18-32455	18-99153	18-3478
BF20D	20	2003-06	7452352	18-32455	18-99153	18-3478
BF20D	20	K0, K2, K3	7452352	18-32455	18-99153	18-3478
BFP20D	20	2004-06	7452352	18-32455	18-99153	18-3478
BFP20D	20	K0	7452352	18-32455	18-99153	18-3478
BF25A	25	2001-03	7452378	18-3249	18-2496	18-3281
BF25D	25	2004-06	7452378	18-3249	18-2496	18-3281
BF25D	25	K0, K2, K3	7452378	18-3249	18-2496	18-3281
BF30A	30	2001-03	7452378	18-3249	18-2496	18-3281
BF30D	30	2004-06	7452378	18-3249	18-2496	18-3281
BF30D	30	K0, K2, K3	7452378	18-3249	18-2496	18-3281
BF40A	40	2000-06	7452386	18-3248	18-2496 18-0176	18-3282
BF40A	40	K0	7452386	18-3248	18-2496 18-0176	18-3282
BF40D	40	K2	7452386	18-3248	18-2496 18-0176	18-3282
BF40D	40	Pre-1997	7452386	18-3248	18-2496 18-0176	18-3282
BF50A	50	2000-06	7452386	18-3248	18-2496 18-0176	18-3282
BF50A	50	K0	7452386	18-3248	18-2496 18-0176	18-3282
BF50D	50	K2	7452386	18-3248	18-2496 18-0176	18-3282
BF50D	50	Pre-1997	7452386	18-3248	18-2496 18-0176	18-3282
BF75A	75	1997-98	4921441	18-3056	18-2565	18-3214
BF75A	75	1999-02	6706634	-	-	18-3492
BF75A	75	2003-06	7452394	18-3250	NSS	18-3283
BF75D	75	K0, K2	7452394	18-3250	NSS	18-3283
BF90A	90	1997-98	4921441	18-3056	18-2565	18-3214

APPLICATION CONTINUED ON NEXT PAGE

HONDA 4-STROKE WATER PUMP REPAIR KIT APPLICATION (CONT.)

Model	HP	Year	Honda Code	Impeller	Gasket	Kit without Housing
BF90A	90	1999-02	6706634	-	-	18-3492
BF90A	90	2003-06	7452394	18-3250	NSS	18-3283
BF90D	90	K0, K2	7452394	18-3250	NSS	18-3283
BF115A	115	1999-02	6706634	-	-	18-3492
BF115A	115	2003-06	7452394	18-3250	NSS	18-3283
BF115A	115	K0	7452394	18-3250	NSS	18-3283
BF115D	115	K1	7632797	18-3250	18-2497	18-3284
BF115D	115	Pre-1997	7632797	18-3250	18-2497	18-3284
BF130A	130	1999-02	6706634	-	-	18-3492
BF130A	130	2003-04	7452394	18-3250	NSS	18-3283
BF135A	135	2004-06	7632797	18-3250	18-2497	18-3284
BF135A	135	K0, K2	7632797	18-3250	18-2497	18-3284
BF150A	150	2004-06	7632797	18-3250	18-2497	18-3284
BF150A	150	K0, K2	7632797	18-3250	18-2497	18-3284
BF175A	175	K1	7452402	18-3031	18-2499 18-8299	18-3285
B175A	175	K2	7452402	18-3031	18-2499 18-8299	18-3285
BF200A	200	2002-06	7452402	18-3031	18-2499 18-8299	18-3285
BF200A	200	K0, K1, K2	7452402	18-3031	18-2499 18-8299	18-3285
BF225A	225	2002-06	7452402	18-3031	18-2499 18-8299	18-3285
BF225A	225	K0, K1, K2	7452402	18-3031	18-2499 18-8299	18-3285
BF250A	250	ALL		18-3031	18-99154	18-3489

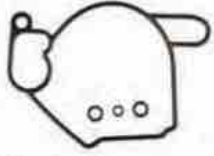
 <p>18-2499 WATER PUMP GASKET Replaces: 19234-ZY3-000 Fits: BF200, BF225</p>	 <p>18-2524 WATER PUMP GASKET Replaces: 19232-ZV1-A10 Fits: BF5</p>	 <p>18-2608 WATER PUMP GASKET Replaces: 19232-881-850 Fits: BF8A</p>	 <p>18-2609 WATER PUMP GASKET Replaces: 19234-881-850 Fits: BF8A</p>
 <p>18-0176 WATER PUMP GASKET Replaces: 19242-ZV5-000</p>	 <p>18-2495 WATER PUMP GASKET Replaces: 19232-ZV4-610 Fits: BF9.9A, BF15A</p>	 <p>18-2496 WATER PUMP GASKET Replaces: 19233-ZV5-000 Fits: BF25, BF30</p>	<p>PKG. OF 2</p>  <p>18-2563 18-2563-9① IMPELLER GASKET Replaces: 19232-ZW1-003</p>
<p>PKG. OF 2</p>  <p>18-2564 18-2564-9① IMPELLER GASKET Replaces: 19234-ZW1-003</p>	<p>PKG. OF 2</p>  <p>18-2565 18-2565-9① IMPELLER GASKET Replaces: 19242-ZW1-003</p>	 <p>18-2480 GASKET SET Replaces: 16010-ZV4-005 Fits: BF8(2001), BF9.8(2001 & below), BF15(2002 & below), BF25(All), BF30(All), BF35(1997), BF40(All), BF45(1997), BF50(All), BF75(1997-06), BF90(1997-06)</p>	 <p>18-2481 GASKET SET Replaces: 16010-ZW9-003 Fits: BF8(2002 & Up), BF9.9(2002 & Up), BF15(2003 & Up), BF20(2003 & Up)</p>

SEE PAGE 219 FOR OUR COMPLETE LINE OF GASKET SEALANTS

① Priced Per Package

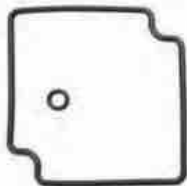

18-2482
GASKET SET

Replaces: 16010-881-003
Fits: BF5(2003 & below), BF8(2000 & below, 2003 & Up), BF50(1996 & below), BF75(1996 & below), BF100(1996 & below)



18-2470
CARB MOUNTING GASKET

Replaces: 16221-ZV4-610
Fits: BF9.9 (2000 & below), BF15 (2002 & below)



18-2471
CARB MOUNTING GASKET

Replaces: 16221-ZW9-000
Fits: BF8(2001 & Up), BF9.9(2001 & Up)



18-2472
CARB MOUNTING GASKET

Replaces: 16221-ZW1-000
Fits: BF75(1997-06), BF90(1997-06)



18-2473
CARB MOUNTING GASKET

Replaces: 16201-881-850
Fits: BF8(2000 & below, 2003 & Up), BF75(1996 & below), BF100(1996 & below)

PKG. OF 2



18-2945
18-2945-9①
18-29451-9①

(PKG. OF 50)
DRAIN SCREW GASKET
Used with **18-2244** Drain Screw



18-0300
INTAKE MANIFOLD GASKET

Replaces: 17105-ZY6-000
Fits: BF135-BF150

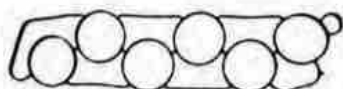

18-0390
INTAKE MANIFOLD GASKET

Replaces: 17105-ZY3-004
Fits: BF200-BF225 (2002 and UP)



18-0248
INTAKE MANIFOLD GASKET

Replaces: 17151-ZW5-000



18-0382
THROTTLE BODY GASKET

Replaces: 17109-ZY6-000
Fits: BF75-BF150



18-0396
THROTTLE BODY GASKET

Replaces: 17109-ZY3-004
Fits: BF200-BF225 (2002 & UP)



18-0737
THROTTLE BODY GASKET

Replaces: 16176-POA-004



18-3288
SEAL

Replaces: 91252-ZV1-003
Fits: BF5



18-8298
SEAL

Replaces: 91252-935-004
Fits: BF8A

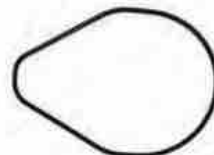

18-8299
MOLDED RUBBER SEAL (O-RING MATERIAL)

Replaces: 91356-ZY3-003
Fits: BF200, BF225

SEE PAGE 219 FOR OUR COMPLETE LINE OF GASKET SEALANTS

① Priced per Package



18-1156
FORWARD GEAR BEARING
Replaces: 91051-ZW1-003



18-1157
FORWARD GEAR INNER BEARING
Replaces: 91057-ZW1-003



18-1158
CARRIER BEARING
Replaces: 91053-ZW1-003



18-7909
OIL FILTER
Replaces: 15400-POH-305PE,
15400-POH-305, 15400-ZJ1-004,
15400-PLM-A01PE
(Application on next page)



18-7913
OIL FILTER
Replaces: 15400-PFB-014
(Application on next page)



18-7911-1
OIL FILTER
Replaces: 15400-PFB-007
(Application on next page)

Models	Years	SS Number	Replace	Part No.	Models	Years	SS Number	Replace	Part No.
BF8D, BFP8D	2001-Current	15400-PFB-004	15400-PFB-014	18-7913	BF50A	1998-Earlier	15400-PJ7-005	15400-PFB-014	18-7913
BF9D, BFP9D	2001-Current	15400-PM3-004	15400-PFB-014	18-7913	BF25	1999-2005	15400-ZW4-003	15400-PFB-007	18-7911-1
BF15D, BFP15D	2003-Current	15400-PM3-405	15400-PFB-014	18-7913	BF30	1999-2005	15400-ZW4-003	15400-PFB-007	18-7911-1
BF20D	2003-Current	15400-PJ7-015	15400-PFB-014	18-7913	BF40	1999-2005	15400-ZW4-003	15400-PFB-007	18-7911-1
BF25A	1998-Earlier	15400-PJ7-005	15400-PFB-014	18-7913	BF50	1999-2005	15400-ZW4-003	15400-PFB-007	18-7911-1
BF30A	1998-Earlier	15400-PJ7-005	15400-PFB-014	18-7913	BF75, BF90	1997-Current	15400-POH-305PE	15400-PLM-A01PE	18-7909
BF35AM	1998-Earlier	15400-PJ7-005	15400-PFB-014	18-7913	BF115, BF130	1998-Current	15400-POH-305	15400-PLM-A01PE	18-7909
BF40A	1998-Earlier	15400-PJ7-005	15400-PFB-014	18-7913	BF135, BF150	2004-Current	15400-ZJ1-004	15400-PLM-A01PE	18-7909
BF45AM	1998-Earlier	15400-PJ7-005	15400-PFB-014	18-7913	BF200, BF225	2002-Current	15400-ZJ1-999AH	15400-PLM-A01PE	18-7909

Zinc is for saltwater only applications.
Magnesium is for fresh water only applications.
Aluminum is for brackish water, or if boat is used in both fresh and salt environments.



18-2448
LOWER UNIT
FILL/DRAIN KIT
• M8 - 1.25 thread
Fits: Yamaha, Nissan/Tohatsu, & Honda Lower Units



③ **18-6068**
ANODE
Replaces: 41109-ZW1-003
BF75-BF90 (1997-98)

SEE PAGES 200-202 & 1165-1193 FOR ADDITIONAL OIL FILTER INFORMATION

- ① Aluminum
 - ② Magnesium
 - ③ Zinc
 - ④ Priced per Package
- ⑤ Items ending in "D" are Display Packaged - Regular number is Non-Display



② 18-6241
 ③ 18-6011
 ① 18-6011A

ANODE
 Replaces: 41107-ZW1-003ZA
 BF75-BF90 (1997-98)



① 18-6165A
ANODE, TRIM TAB

Replaces: 41107-ZV5-00-00
 Fits: BF25, BF30, BF35, BF45, BF50 (1997-Up)



① 18-6163A
 ② 18-6163M
ANODE KIT

Fits: Honda BF90-115 Engines

PKG. OF 10



18-3200
 18-3200-9③
TAB WASHER

Replaces: 90508-ZW1-003
 For: 75-90 HP

① 18-3701D



18-3701
PROP NUT KIT
 — CONTAINS —

Part #	O.E. #	Description
18-3200	90508-ZW1-003	Tab Washer
18-3700	90301-ZW1-003	Prop Nut



18-79989
TRAILERING STICKS

Fits: Most outboards over 150hp with three ram integral till/trim.

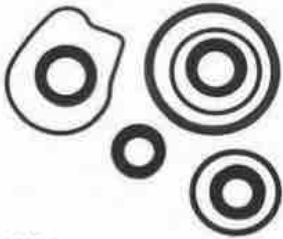

18-8362-1
LOWER UNIT SEAL KIT
 For: Series 14ZV50M



18-8363
LOWER UNIT SEAL KIT

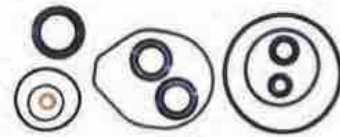

18-8365
LOWER UNIT SEAL KIT

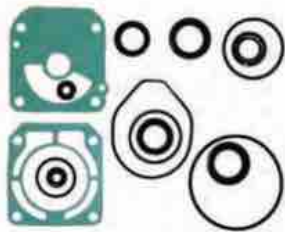

18-8366
LOWER UNIT SEAL KIT



OIL SEALS

Part No.	Description	O.E. No.
18-0522	Drive Shaft	91254-ZW1-003
18-0583	Drive Shaft	91251-ZW1-003
18-2002	Prop Shaft	91252-ZW1-003
18-2053	Prop Shaft	91255-ZW1-003
18-2054	Shift Shaft	91253-ZW1-003

PKG. OF 5



18-7198
 18-7198-9③
O-RING
 Replaces: 91353-ZW1-003

LOWER UNIT SEAL KIT APPLICATION

HP/Model	Part #
BF9.9, BF15	18-8363
BF35AM, BF45AM, BF40A, BF40AW, BF40AX, BF50A, BF50AW, BF50AX	18-8362-1
BF75, BF90	18-8366
BF115, BF130	18-8365

Johnson/Evinrude Model Identification

Outboards 1980-1998

Model Variation	Style	Horse-power	Design Feature	Shaft Year Length	Built
A = Australia B = Belgium C = Canada H = Hong Kong S = South Africa T = Tracker V = Boat Builder	J = Johnson E = Evinrude C = Commercial V = Quiet Rider	Example: 20 40 200	AE = Elec. Start - Alaska AR = Rope Start - Alaska BA = AC Lighting - Rope Start BE = Belgium Derated - Elec. Start BF = Belgium Derated - Rope Start BG = Belgium Derated - Rope Start BI = Belgium Derated - Rope Start BR = Euro Rope Start C = Counter Rotation CE = Canada Derated - Elec. Start CR = Canada Derated - Rope Start D = Remote Electric DE = Derated - Elec. Start DR = Derated - Rope Start DT = Derated - Elec. Start/Trim & Tilt E = Elec. Start ER = Elec. Start - Sport Styling ES = Elec. Start - Special FA = 4-stroke - Rope Start FE = 4-stroke - Elec. Start/Remote FP = Commercial w/Program Tilt FR = 4-stroke - Rope Start FRE = 4-stroke - Elec. Start/Remote FS = FICHT - Trim & Tilt FT = FICHT - Trim & Tilt/Special Styling G = Special Styling H = Less Integral Tank/Hydraulic Steering I = FICHT Fuel Injection IE = Italy Elec. Start IK = Italy Elec. Start J = Jet Drive K = 3-CYL 25/35 KC = Kerosene Rope Start KG = Kerosene/Gasoline KS = Kerosene Rope Start M = Manual Tilt - Elec. Start MS = Manual Tilt - Elec. Start/Special N = Counter Rotation P = Power Steering Q = 3-CYL 25/35 Trim & Tilt R = Rope Start RA = Australia Rope Start RC = Rope Start - Commercial/CD Ignition RD = Rope Start - Deluxe RE = Remote Elec. RP = Commercial w/Program Tilt RS = Rope Start - Commercial RW = Commercial w/Program Tilt S = Sail - Special Styling SC = Special Styling/Counter Rotation SE = Elec. Start Non-Tilt Sail SI = Italy Special Derated SL = 60 Degree V - Trim & Tilt SP = Special Styling SR = Rope Start - Sail - Non-Tilt ST = Special Styling - Trim & Tilt T = Trim & Tilt - Elec. Start TE = Tiller Elec. TR = Trim & Tilt - Sport styling TT = Tiller - Trim & Tilt U = Manual Tilt V = Special Gearcase W = 110 Degree Angle Drive - Rope Start WM = Elec. Commercial - Manual Tilt WMP = Same as "WM" w/Chrome Pump WT = Elec. Commercial - Trim & Tilt WTP = Same as "WT" w/Chrome Pump	= 15" L = 20" Y = 22.5" X = 25" Z = 30"	I = 1 N = 2 T = 3 R = 4 O = 5 D = 6 U = 7 C = 8 E = 9 S = 0 EX: CS = 1980 ES = 1990 EU = 1997 SC = 2008

EXAMPLE: VE70TLEDA - Boat Builder Model, Evinrude, 70 HP, Trim & Tilt w/Elec. Start, 1996 Model











MODEL IDENTIFICATION CHART CONTINUED ON NEXT PAGE

Johnson/Evinrude Model Identification

Outboards 1999 and Newer

Style	Horse-power	Design Feature	Shaft Length	Year Built
J = Johnson E = Evinrude	Example: 20 40 200	3 = 3-CYL (25 or 35 HP) 4 = Four Stroke Engine B = Blue Paint C = Counter-Rotation w/Trim & Tilt D = E-TEC E = Electric Start w/Remote Steering F = FICHT Fuel Injection G = Graphite Paint J = Jet M = Military Model P = Power Trim & Tilt R = Rope Start w/Tiller Steering S = Special Styling (White Evinrude) T = Tiller Steering TE = Tiller Electric W = Commercial Model	= 15" L = 20" Y = 22.5" X = 25" Z = 30"	I = 1 N = 2 T = 3 R = 4 O = 5 D = 6 U = 7 C = 8 E = 9 S = 0 EX: EE = 1999 SC = 2008

EXAMPLE: E70PLEEA - Evinrude model, 70 HP, Power Trim&Tilt, 20", 1999 model

<p>Ⓛ18-5001D Display Package</p>  <p>18-5001 TUNE-UP KIT Replaces: 172525</p> <table border="1"> <thead> <tr> <th>Part #</th> <th>Desc.</th> <th>O.E.#</th> <th>Qty.</th> </tr> </thead> <tbody> <tr> <td>18-5200</td> <td>Condenser</td> <td>580256</td> <td>1</td> </tr> <tr> <td>18-5157</td> <td>Contact set</td> <td>580290</td> <td>2</td> </tr> </tbody> </table>	Part #	Desc.	O.E.#	Qty.	18-5200	Condenser	580256	1	18-5157	Contact set	580290	2	<p>Ⓛ18-5002D Display Package</p>  <p>18-5002 TUNE-UP KIT Replaces: 172523</p> <table border="1"> <thead> <tr> <th>Part #</th> <th>Desc.</th> <th>O.E.#</th> <th>Qty.</th> </tr> </thead> <tbody> <tr> <td>18-5205</td> <td>Condenser</td> <td>581419</td> <td>2</td> </tr> <tr> <td>18-5156</td> <td>Contact Set</td> <td>580148</td> <td>2</td> </tr> </tbody> </table>	Part #	Desc.	O.E.#	Qty.	18-5205	Condenser	581419	2	18-5156	Contact Set	580148	2	<p>Ⓛ18-5003D Display Package</p>  <p>18-5003 TUNE-UP KIT Replaces: 172806</p> <table border="1"> <thead> <tr> <th>Part #</th> <th>Desc.</th> <th>O.E.#</th> <th>Qty.</th> </tr> </thead> <tbody> <tr> <td>18-5205</td> <td>Condenser</td> <td>581419</td> <td>2</td> </tr> <tr> <td>18-5141</td> <td>Contact Set</td> <td>581207</td> <td>2</td> </tr> </tbody> </table>	Part #	Desc.	O.E.#	Qty.	18-5205	Condenser	581419	2	18-5141	Contact Set	581207	2
Part #	Desc.	O.E.#	Qty.																																			
18-5200	Condenser	580256	1																																			
18-5157	Contact set	580290	2																																			
Part #	Desc.	O.E.#	Qty.																																			
18-5205	Condenser	581419	2																																			
18-5156	Contact Set	580148	2																																			
Part #	Desc.	O.E.#	Qty.																																			
18-5205	Condenser	581419	2																																			
18-5141	Contact Set	581207	2																																			
<p>Ⓛ18-5006D Display Package</p>  <p>18-5006 TUNE-UP KIT Replaces: 172522</p> <table border="1"> <thead> <tr> <th>Part #</th> <th>Desc.</th> <th>O.E.#</th> <th>Qty.</th> </tr> </thead> <tbody> <tr> <td>18-5199</td> <td>Condenser</td> <td>580321</td> <td>2</td> </tr> <tr> <td>18-5156</td> <td>Contact Set</td> <td>580148</td> <td>2</td> </tr> </tbody> </table>	Part #	Desc.	O.E.#	Qty.	18-5199	Condenser	580321	2	18-5156	Contact Set	580148	2	<p>Ⓛ18-5011 Display Package</p>  <p>18-5011 TUNE-UP KIT Replaces: 172521</p> <table border="1"> <thead> <tr> <th>Part #</th> <th>Desc.</th> <th>O.E.#</th> <th>Qty.</th> </tr> </thead> <tbody> <tr> <td>18-5199</td> <td>Condenser</td> <td>580321</td> <td>1</td> </tr> <tr> <td>18-5156</td> <td>Contact Set</td> <td>580148</td> <td>1</td> </tr> </tbody> </table>	Part #	Desc.	O.E.#	Qty.	18-5199	Condenser	580321	1	18-5156	Contact Set	580148	1	 <p>18-5141 CONTACT SET Replaces: 581207</p>												
Part #	Desc.	O.E.#	Qty.																																			
18-5199	Condenser	580321	2																																			
18-5156	Contact Set	580148	2																																			
Part #	Desc.	O.E.#	Qty.																																			
18-5199	Condenser	580321	1																																			
18-5156	Contact Set	580148	1																																			
 <p>18-5156 CONTACT SET Replaces: 580148</p>	 <p>18-5157 CONTACT SET Replaces: 580290</p>	 <p>CONDENSERS 18-5199 Replaces: 580321 18-5205 Replaces: 581419</p>	 <p>18-5200 CONDENSER Replaces: 580256</p>																																			

APPLICATION BEGINS ON NEXT PAGE

Ⓛ Items ending in "D" are Display Packaged - Regular number is Non-Display

JOHNSON/EVINRUDE TUNE-UP KIT APPLICATION

HP	Year Start	Year Stop	Contact Set	Condenser	Tune-Up Kit	HP	Year Start	Year Stop	Contact Set	Condenser	Tune-Up Kit
1.2	1986	1990	18-5156	18-5199	18-5011	25	1955	1955	18-5156	18-5199	18-5006
1.5	1968	1970	18-5156	18-5199	18-5011	25	1969	1976	18-5156	18-5205	18-5002
2	1971	1985	18-5156	18-5199	18-5011	28	1962	1964	18-5156	18-5205	18-5002
3	1952	1968	18-5156	18-5199	18-5006	30	1956	1956	18-5156	18-5199	18-5006
3	1989	1990	18-5156	18-5199	18-5006	33	1965	1970	18-5156	18-5205	18-5002
4	1969	1976	18-5156	18-5199	18-5006	35	1956	1959	18-5156	18-5199	18-5006
4	1981	1988	18-5156	18-5199	18-5006	35	1976	1976	18-5141	18-5205	18-5003
5	1965	1968	18-5156	18-5199	18-5006	38	1968	1968	18-5156	18-5199	18-5006
5.5	1954	1964	18-5156	18-5199	18-5006	40	1960	1961	18-5156	18-5199	18-5006
6	1965	1976	18-5156	18-5199	18-5006	40	1962	1973	18-5156	18-5205	18-5002
7.5	1956	1958	18-5156	18-5199	18-5006	40	1974	1976	18-5141	18-5205	18-5003
9.5	1964	1973	18-5156	18-5199	18-5006	40 Comm	1981	1983	18-5141	18-5205	18-5003
10	1950	1963	18-5156	18-5199	18-5006	50	1958	1959	18-5157	18-5200	18-5001
9.9	1970	1970	18-5156	18-5199	18-5006	60	1964	1967	18-5157	18-5200	18-5001
9.9	1974	1976	18-5141	18-5205	18-5003	75	1961	1967	18-5157	18-5200	18-5001
15	1956	1956	18-5156	18-5199	18-5006	80	1966	1967	18-5157	18-5200	18-5001
15	1974	1976	18-5141	18-5205	18-5003	90	1964	1965	18-5157	18-5200	18-5001
18	1956	1961	18-5156	18-5199	18-5006	90	1968	1968	18-5157	18-5200	18-5001
18	1962	1973	18-5156	18-5205	18-5002	100	1966	1966	18-5157	18-5200	18-5001
20	1968	1973	18-5156	18-5205	18-5002						

 <p>18-5163 IGNITION COIL Replaces: 581130, 763809</p>	 <p>18-5170 IGNITION COIL Replaces: 583740, 583298</p>	 <p>18-5172 IGNITION COIL Replaces: 581786, 502881</p>
 <p>18-5176 IGNITION COIL KIT Replaces: 582106, 582330 582366, 583737, 584561</p>	 <p>18-5179D IGNITION COIL Replaces: 582508</p>	 <p>18-5181D IGNITION COIL Replaces: 582995, 584477</p>
 <p>18-5192 IGNITION COIL Replaces: 581610, 582091, 502888</p>	 <p>18-5194 IGNITION COIL Replaces: 582160, 584632, 502890, 581032</p>	 <p>18-5196 IGNITION COIL Replaces: 581407, 502880</p>

APPLICATION BEGINS ON NEXT PAGE

Ⓛ Items ending in "D" are Display Packaged - Regular number is Non-Display

JOHNSON/EVINRUDE IGNITION COIL APPLICATION

HP	Year Start	Year Stop	Coil	Qty.	HP	Year Start	Year Stop	Coil	Qty.	HP	Year Start	Year Stop	Coil	Qty.
2	1971	1973	18-5181	1	20	1966	1972	18-5181	2	60	1980	1984	18-5176	2
2	1975	1985	18-5181	1	20	1973	1973	18-5163	1	60	1985	1987	18-5179	3
2	1995	2001	18-5179	1	20	1985	1987	18-5179	2	60	1988	1988	18-5176	3
2.5	1987	1988	18-5170	1	20	1988	1988	18-5176	2	60	1989	2001	18-5179	3
3	1955	1968	18-5181	2	20	1989	1998	18-5179	2	65	1972	1973	18-5194	3
3	1989	1990	18-5181	2	25	1951	1953	18-5181	2	65	1984	1984	18-5176	3
3	1991	1997	18-5170	1	25	1955	1955	18-5181	2	65	1985	1988	18-5179	3
3	1998	2001	18-5179	1	25	1969	1972	18-5181	2	65	1989	1990	18-5176	3
3	2003	2005	18-5179	1	25	1973	1976	18-5163	1	65	1991	2001	18-5179	3
3.3	1995	1997	18-5179	1	25	1973	1976	18-5172	2	70	1974	1975	18-5194	3
4	1969	1976	18-5181	2	25	1977	1984	18-5176	2	70	1979	1984	18-5176	3
4	1977	1980	18-5176	2	25	1985	1987	18-5179	2	70	1985	1987	18-5179	3
4	1981	1988	18-5181	2	25	1988	1988	18-5176	2	70	1988	1988	18-5176	3
4	1986	1987	18-5179	2	25	1989	2005	18-5179	2	70	1989	2001	18-5179	3
4	1987	2001	18-5170	1	28	1962	1964	18-5181	2	75	1975	1975	18-5194	3
4	1988	1988	18-5176	2	28	1986	1996	18-5179	2	75	1979	1984	18-5176	3
4	1989	1996	18-5179	2	28	1995	1998	18-5170	1	75	1985	1987	18-5179	3
4.5	1980	1983	18-5176	2	30	1956	1956	18-5181	2	75	1988	1988	18-5176	3
5	1965	1968	18-5181	2	30	1984	1984	18-5176	2	75	2000	2001	18-5170	2
5	1996	1998	18-5170	1	30	1985	1987	18-5179	2	85	1973	1975	18-5194	3
5	1997	2001	18-5179	2	30	1988	1988	18-5176	2	85	1976	1977	18-5192	4
5.5	1954	1964	18-5181	2	30	1989	2005	18-5179	2	85	1978	1980	18-5176	4
6	1965	1976	18-5181	2	30	1999	2001	18-5170	1	85	1991	1995	18-5179	4
6	1977	1979	18-5176	2	33	1965	1970	18-5181	2	88	1987	1987	18-5179	4
6	1984	1984	18-5176	2	35	1957	1959	18-5181	2	88	1988	1988	18-5176	4
6	1985	1990	18-5179	2	35	1976	1976	18-5172	2	88	1989	1996	18-5179	4
6	1991	2005	18-5170	1	35	1977	1984	18-5176	2	90	1981	1984	18-5176	4
6	1997	2001	18-5179	2	35	1986	1987	18-5179	2	90	1985	1987	18-5179	4
6	2003	2004	18-5179	2	35	1988	1988	18-5176	2	90	1988	1988	18-5176	4
7.5	1954	1958	18-5181	2	35	1989	1994	18-5179	2	90	1989	1998	18-5179	4
7.5	1980	1983	18-5176	2	35	1996	1996	18-5179	2	90	1995	2006	18-5170	2
8	1984	1984	18-5176	2	40	1960	1973	18-5181	2	100	1979	1980	18-5176	4
8	1985	1990	18-5179	2	40	1974	1974	18-5196	2	100	1984	1984	18-5176	4
8	1991	2005	18-5170	1	40	1975	1979	18-5172	2	100	1985	1997	18-5179	4
9.5	1964	1973	18-5181	2	40	1983	1983	18-5172	2	100	1988	1988	18-5176	4
9.9	1974	1976	18-5196	2	40	1984	1984	18-5176	2	100	1998	2001	18-5170	2
9.9	1977	1984	18-5176	2	40	1985	1987	18-5179	2	105	1997	2001	18-5170	2
9.9	1985	1992	18-5179	2	40	1988	1988	18-5176	2	105	2003	2003	18-5170	2
9.9	1993	2001	18-5170	1	40	1989	2005	18-5170	1	110	1986	1987	18-5179	4
10	1949	1952	18-5181	2	40	1999	2001	18-5179	2	110	1988	1988	18-5176	4
10	1953	1953	18-5181	2	45	1986	1992	18-5179	2	110	1989	1989	18-5179	4
10	1954	1963	18-5181	2	45	1992	1997	18-5170	1	112	1994	1996	18-5179	4
10	2003	2007	18-5170	1	48	1987	1987	18-5179	2	115	1973	1975	18-5194	4
14	1988	1988	18-5179	2	48	1988	1988	18-5176	2	115	1976	1977	18-5192	4
14	1989	1989	18-5176	2	48	1989	1996	18-5170	1	115	1978	1984	18-5176	4
15	1953	1953	18-5181	2	50	1971	1975	18-5194	2	115	1985	1985	18-5179	4
15	1955	1956	18-5181	2	50	1979	1984	18-5176	2	115	1990	1998	18-5179	4
15	1965	1968	18-5181	2	50	1985	1987	18-5179	2	115	1995	2006	18-5170	2
15	1974	1976	18-5196	2	50	1988	1988	18-5176	2	120	1985	1987	18-5179	4
15	1977	1984	18-5176	2	50	1989	2005	18-5170	1	120	1988	1988	18-5176	4
15	1985	1992	18-5179	2	50	1995	1998	18-5179	2	120	1989	1994	18-5179	4
15	1993	2007	18-5170	1	55	1978	1984	18-5176	2	125	1989	1990	18-5179	4
18	1957	1972	18-5181	2	55	1985	1992	18-5179	2	125	1992	1998	18-5179	4
18	1973	1973	18-5163	1	55	1992	2005	18-5170	1	130	1995	2001	18-5179	4

APPLICATION CONTINUED ON NEXT PAGE

JOHNSON/EVINRUDE IGNITION COIL APPLICATION (Cont.)

HP	Year Start	Year Stop	Coil	Qty.	HP	Year Start	Year Stop	Coil	Qty.	HP	Year Start	Year Stop	Coil	Qty.
135	1973	1975	18-5194	4	155	1985	1985	18-5179	6	200	1986	2001	18-5179	6
135	1976	1976	18-5192	4	155	1987	1987	18-5179	6	200	1999	1999	18-5170	3
135	2000	2001	18-5170	2	155	1988	1988	18-5176	6	225	1986	2001	18-5179	6
140	1977	1977	18-5192	4	155	1989	1992	18-5179	6	225	1999	1999	18-5170	3
140	1978	1984	18-5176	4	175	1977	1978	18-5192	6	235	1978	1978	18-5192	6
140	1985	1987	18-5179	4	175	1979	1983	18-5176	6	235	1979	1984	18-5176	6
140	1988	1988	18-5176	4	175	1985	1991	18-5179	6	235	1985	1985	18-5179	6
140	1989	1994	18-5179	4	175	1991	2006	18-5170	3	250	1991	2001	18-5179	6
150	1978	1978	18-5192	6	185	1984	1984	18-5176	6	275	1985	1988	18-5179	6
150	1979	1984	18-5176	6	185	1985	1985	18-5179	6	300	1985	1995	18-5179	6
150	1985	1991	18-5179	6	185	1989	1990	18-5179	6					
150	1988	1988	18-5176	6	185	1992	1994	18-5179	6					
150	1991	2006	18-5170	3	200	1976	1978	18-5192	6					
155	1984	1984	18-5176	6	200	1979	1983	18-5176	6					



18-5755
POWER PACK
Replaces: 581397, 764708
(pack 2)



18-5758
POWER PACK
Replaces: 582453, 583380, 582452



18-5759
POWER PACK
Replaces: 582125, 581805



18-5760
POWER PACK
Replaces: 582138, 582400, 582642, 582556



18-5761
POWER PACK
Replaces: 583114



18-5763
POWER PACK
Replaces: 582285, 583170



18-5764
POWER PACK
Replaces: 582261, 586696



18-5766
POWER PACK
Replaces: 583748



18-5767
POWER PACK
Replaces: 584783



18-5768
POWER PACK
Replaces: 584908, 5001344



18-5770-1
POWER PACK
Replaces: 584028



18-5771
POWER PACK
Replaces: 584032



18-5772-1
POWER PACK
Replaces: 584041



18-5773
POWER PACK
Replaces: 584642, 763803



18-5774-1
POWER PACK
Replaces: 585145, 5004532, 585189,
5004533



18-5781-1
POWER PACK
Replaces: 586661, 584636, 586212,
585114



18-5782
POWER PACK
Replaces: 582705, 763793



18-5784-1
POWER PACK
Replaces: 583110, 582811, 763794



18-5785
POWER PACK
Replaces: 585261



18-5885
POWER PACK
Replaces: 583865
For: V-6 5800 rpm limit



18-5886
POWER PACK & SENSOR
Replaces: 436367, 584122
For: V6 engines with optical sensor and BLUE sleeve
on power pack. Do not use with gray sleeved stator.



18-5887
POWER PACK
Replaces: 584985
For: V6 engines with optical sensor and GRAY sleeve
on power pack. Do not use with black sleeved stator.



18-5891
POWER PACK
Replaces: 583605
For: 3 & 6 cyl. 6700 rpm limit



18-5893
POWER PACK
Replaces: 586667, 584037,
586217, 583476
For: V-4 & V-6 6700 rpm limit



18-5884
OPTICAL SENSOR
Replaces: 586343
For: V-4 & V-6 engines



18-9802
TIMING LIGHT
Self-powered accurate up to 10,000 RPM's



18-5794-1
IGNITION MODULE
Replaces: 584489, 584329,
583896, 584331

APPLICATION BEGINS ON NEXT PAGE

Model	Years	Power Pack	Model	Years	Power Pack	Model	Years	Power Pack
4	1977-80, 1984	18-5758	40	1985	—	90	1988	—
4	1993	—	40	1986-88	18-5763	100	1971	—
4 DLX	1986-88, 1994-99	18-5763	40	1991-93	18-5794-1	100	19,681, 972	—
4.5	1980-84	18-5758	40 Rope Start	1993-01	18-5768	100	1979-80	18-5759 ①
4.5	1986-87	18-5763	40 Electric Start	1993-01	18-5785	100	1988	—
5	1984	18-5758	40 COM.	1986-88	18-5764	100, 115	1989-99 Crossflow	18-5770-1
5	1985	—	45	1991-92	18-5794-1	110 (TCLDF only)	1986	18-5783
5	1986-88, 1993-98	18-5763	48	1987-88	18-5763	110	1986-87	18-5784-1
6	1977-79, 1984	18-5758	48	1991-93	18-5794-1	110	1988	—
6	1985	—	50	1971-75	18-5755	115	1969-70	—
6	1986-88, 1993-01	18-5763	50	1979, 1981-84	18-5758	115	1973-77	—
6.5COM.	1992-99	18-5763	50	1985	—	115	1978-84	18-5759 ①
7.5	1980-83	18-5758	50	1986-88	18-5763	115	1985	18-5783
8	1993-95	18-5763	50	1991-93	18-5794-1	120	1986	—
9.9, 15	1977-84	18-5758	50 Rope Start	1993-01	18-5768	120	1988-89	18-5772-1
9.9, 15	1985	—	50 Electric Start	1993-01	18-5785	125	1971-72	—
9.9, 15	1986-88	18-5763	50 (3 cyl)	1996-99	18-5774-1 ②	130	1988-99	18-5772-1
9.9, 15	1993-99	18-5767	55	1976-77	18-5755	135	1973-76	—
14	1987	18-5763	55	1978-82	18-5758	140	1977	—
10/15COM.	1992	18-5763	55	1991-92	18-5794-1	140	1978-83	18-5759 ①
10, 15COM.	1993-99	18-5767	60	1970-71	—	140	1986	—
20	1981-84	18-5758	60	1980-84	18-5758	140	1988-99	18-5772-1
20	1985	—	60	1985	—	150	197-78	—
20	1986-88	18-5763	60	1986-88	—	175	1979-83	18-5760 ①
20	1989-92	18-5794-1	60	1989-92	18-5766	175	1986-88	18-5761
20	1993-95	18-5768	60	1993-95	18-5774-1 ②	175	1989-91	18-5885
20	1996-01	18-5768 ③	60	1996-99	18-5774-1 ②	175	1991-92	18-5886 ④
25	1977-84	18-5758 ④	65	1972-73	—	175	1993-03	18-5887
25	1985	—	65	1989-92	18-5766	185	1984	18-5760 ①
25	1986-88	18-5763	65	1993-95	18-5774-1 ②	185	1990, 1992	18-5893
25	1989-92	18-5794-1	70	1974-78	—	185	1993-99	18-5781-1
25	1993-95	18-5768	70	1979-84	18-5760	200	1976-78	—
25	1996-01	18-5768 ③	70	1985	18-5782 ②	200	1979-83	18-5760 ①
25 COM.	1986-88	18-5764 ⑤	70	1986-88	—	200	1987	18-5891
28	1986-88	18-5763	70	1989-92	18-5766	200, 225	1988-92	18-5893
28	1989-92	18-5794-1	70	1993-95	18-5774-1 ②	200, 225	1993-99	18-5781-1
28	1996-01	18-5768	70	1996-99	18-5774-1 ②	225	1987	18-5891
30	1984	18-5758	75	1975-78	—	235	1978	—
30	1985	—	75	1979-84	18-5760	235	1979-84	18-5760 ①, ②, ③, ④
30	1986-88	18-5763	75	1985	18-5782 ②	250	1991	18-5893
30	1989-92	18-5794-1	75	1986-88	—	275	1986-87	—
30	1993-95	18-5768	85	1969-72	—	300	1987	—
30	1996-01	18-5768 ③	85	1973-77	—	300	1991	18-5893
35	1977-84	18-5758	85	1978-80	18-5759 ①	V-8	1993-89	18-5773
35	1985	—	88, 90	1986-87	18-5784-1	1.6L	1984 & prior	18-5759 ⑤
35	1986-88	18-5763	88	1988	—	1.6L	1985	18-5782
35	1989-92	18-5794-1	88, 90	1989-99 Crossflow	18-5770-1	1.6L	1986-87	18-5784-1
35	1993-95	18-5768	90	1981-83	18-5759 ①	2.0L	1988-99	18-5772-1
40	1982	18-5758	90	1985	18-5783	2.5, 2.6L	1986-88	18-5761 ⑥

- ① 2 Power Packs required per engine
- ② All Models except Worktwin, Workhorse and Commercial Model for 1983
- ③ Port side only for 1983 model STLCT
- ④ Port side only for 1984 models with suffix beginning with

- "S"
- ⑤ 2 cyl. only
- ⑥ 3 cyl. only
- ⑦ Sea Drive Series
- ⑧ Except remote models













- ⑨ Refer to picture
- ⑩ For 2 stroke models only

PREMIUM MARINE SPARK PLUG WIRE LEADS

Sierra's MAGFORCE Ignition Wires are "Electronics Friendly" protecting all of your electronic devices and electronic engine controls from RFI and EMI while delivering the maximum amount of voltage. Exact fit design ensures easy installation and years of trouble - free service.



Part #	OEM #	Description	Part #	OEM #	Description
18-8815-1	OMC 582365	4" Spark Plug Wire	18-5230-9-1	Universal	10" Spark Plug Wire (pkg of 5)
18-8816-1	OMC 582365	6" Spark Plug Wire	18-8839-1	—	90 & 115 hp Outboard Wire Set Two - 14" • Two - 16"
18-5231-1	OMC 582365	8" Spark Plug Wire	18-8840-1	—	150 & 175 hp Outboard Wire Set Two - 14" • Two - 16"
18-5231-1D	OMC 582365	9" Spark Plug Wire	18-28090	—	V6 Outboard Plug Wire Set
18-8818-1	OMC 582365	12" Spark Plug Wire	18-28092	—	V4 Outboard Plug Wire Set
18-5229-9-1	Universal	22" Spark Plug Wire (pkg of 5)			

<p>PKG. OF 10</p>  <p>18-5224 18-5224-9Ⓛ SPARK PLUG WIRE TERMINAL Replaces: 510364</p>	 <p>18-5225 SPARK PLUG WIRE KIT Includes 25 Ft Roll of Hypalon Ignition Wire with a copper conductor and a large assortment of three different end fittings to fit Johnson/Evinrude motors.</p>	 <p>18-5226 IGNITION WIRE (100' Spool) Hypalon Replaces: 510883, 772584</p>
<p>PKG. OF 10</p>  <p>18-5750 18-5750-9Ⓛ UNIVERSAL SPARK PLUG BOOTS Supplied complete w/ Terminal Connector Replaces: 581027, 580339</p>	 <p>18-5752 UNIVERSAL SPARK PLUG BOOT 8mm</p>	 <p>MP39100 IGNITION SWITCH Replaces: 386545 (5 Terminals - 3 Position)</p>
 <p>MP39760 IGNITION SWITCH Replaces: 393301, 508180 (6 Terminals - Push to Choke - 3 Position)</p>	 <p>MP39830 IGNITION SWITCH Replaces: 386545 (6 Terminals - Pistol Shaped Key - 3 Position) Pollak</p>	 <p>MP28890 IGNITION LANYARD Replaces: 176288 1996-Newer</p>
 <p>18-1282 LANYARD & CLIP Replaces: 398602 Tiller Steer Models - ALL</p>	 <p>MP28870 MP28872-1 (Bulk - 100 pc/carton) SWITCH & LANYARD Replaces: 585134</p>	 <p>MP28880 LANYARD Replaces: 432230 1995-older</p>

Ⓛ Priced per package
 Ⓛ Items ending in "D" are Display Packaged - Regular number is Non-Display
 Ⓛ Uses 7mm copper core



MP28900
MP28902-1 "Bulk" - 100 pieces per carton
LANYARD
 Replaces: 432230
 1995-Older



18-5877
STATOR
 Replaces: 584643, 763779
 For: 185-300 HP Loopers (1993-2001)



18-5878
STATOR
 Replaces: 584981, 763759
 For: 150-175 HP (1993-2006)
 Gray Sleeve

JOHNSON/EVINRUDE STATOR APPLICATION			
HP	Year Start	Year Stop	Stator
185	1993	1994	18-5877
200	1993	2001	18-5877
225	1993	2001	18-5877
250	1993	2001	18-5877
300	1993	1995	18-5877
150	1993	2006	18-5878
175	1993	2006	18-5878



18-6277
TILT/TRIM ASSEMBLY
 Replaces: 435548
 Heavy Duty, 2 Wire Connection,
 Flat Blade Shaft
 (O-ring included)
 Fits: OMC V6(1993), Commercial V8
 (1993-Up).



18-6823
WIRING HARNESS
 Replaces: Universal
 Converts 3-wire Tilt and Trim motors to
 2-Wire design



18-6280
TILT/TRIM ASSEMBLY
 Replaces: 437801
 Heavy Duty, OMC J Suffix
 40,48,50HP(1992-Up)/w/ 2 Wire
 Connection and Hollow Hex
 Shaft
 (O-ring included)



18-6281
TILT/TRIM MOTOR
 Replaces: 438786, 439937,
 5005254
 (O-ring included)
 Plastic housing
 Heavy Duty for OMC Outboards
 75HP-250HP EF(1998-Up)



18-6285
TILT/TRIM ASSEMBLY
 Replaces: 433226
 (O-ring included)
 Heavy Duty OMC (1989-92) M Suffix 40,48,50HP w/ 2 Wire
 Connection and
 Hollow Hex Shaft



18-6756
TILT/TRIM MOTOR
 Replaces: 172588, 173944
 Fits: (1982-98) 2 cylinder 2 stroke engines that
 have been fitted with tilt kit 173946.



18-6759
TILT/TRIM MOTOR
 Replaces: 394176,
 391264, 393988, 985237
 Newer 2 wire design for most 3, 4, 6 and 8 cyl.
 applications 1982 to present. 3 bolt.
(MOTOR ONLY)
 Use 18-7510 O-ring (O-ring included)
 Replaces: 321163



18-6761
TILT/TRIM MOTOR
 Replaces: 387277, 582048,
 582155, 584107
 (O-ring included)
 Older 3 wire design for most 3, 4, 6
 cylinder outboards up to 1981
 (Motor Only)



18-6762
TILT/TRIM MOTOR
 Replaces: 172543
 For most 85, 115 & 135 hp V-4 applications.
 (Motor and Reservoir)



18-6767-1
TILT/TRIM MOTOR
 Replaces:
 172850, 173564, 173596
 For: 1974 (115 & 135 HP)
 For most 45 hp commercial models 1989-90,
 2 cylinder applications (1984-88),
 3 cylinder applications (1977-83) and
 4 cylinder applications (1974-77)
 (Motor and Reservoir)
 For Repair Kit use 18-6252



18-6780
TILT/TRIM MOTOR
 Replaces: 438529, 438531, 434496
 For: 90, 115, 200, 225 HP (1991-Up);
 120, 140 HP (1991-94); 130 HP (1995-Up)



18-6815
TRIM MOTOR
 Replaces: Johnson/Evinrude
 Fits: 2004-09 40-50HP 2006-09 60HP,
 2009 25-30HP Evinrude



18-6744
TRIM MOTOR
 Replaces: 5006319
 Fits: 75-90 HP (04-Up), 115 HP (07-Up),
 130 HP (10-Up)



18-6816
TRIM MOTOR
 Replaces: 172588, 173944
 Fits: 40, 50, 70, and 75HP with short shaft



18-6252
TILT & TRIM
MOTOR REPAIR KIT
 For use with 18-6767-1
 * Includes Brushes



POWER TRIM ASSEMBLIES

PART NO.	OE NO.	APPLICATION
18-6801	5005114	115-130HP, V4 (2000-09)
18-6802	5005113	135-200HP, V6, 60° (2000-09)
18-6803	5005115/5007662	200-250HP, V6, 90° (2000-09)



**18-5705
POWER TRIM RELAY**

Replaces:
582472, 584416, 586224
**5 Terminal • Single Pull
Double Throw • 12 Volt**

Contact	Resistive	Conductive
Open	40 Amps	30 Amps
Closed	20 Amps	15 Amps

18-5801D

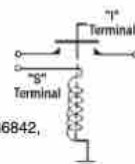

**18-5801
SOLENOID**

Replaces: 985064, 586842, 586730
Grounded Base

18-5823D



**18-5823
SOLENOID**

Replaces: 584580
Fits: 9.9 4-stroke(1995-01), 9.9 (1993 & Up), 15 4-stroke(1995-01), 15 (1993 & Up), 8 (1996-98).

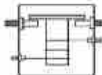

18-5833D



**18-5833
SOLENOID**

Replaces: 586774
Fits: E40 (2004-07), E50 (2004-06), E60 (2006-07), E75 (2004-07), E90 (2004-07), E115 (2007), E150 (2007), E175 (2007), E200 (2005-07), E225 (2005-07), E250 (2005-07)

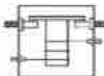

**18-5807
SOLENOID**

Replaces: 378444, Prestolite SAW4206

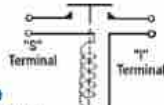

18-5808D



**18-5808
SOLENOID**

Replaces: 395419, 582708

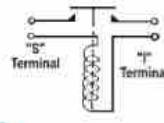

**18-5813
SOLENOID**

Replaces: 584128

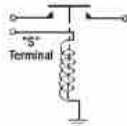

18-5814D



**18-5814
SOLENOID**

Replaces: 581528, 172869

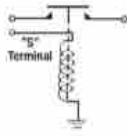

BATTERY CABLES

Gauge cable with soldered lug terminals on each end to accept 3/8" stud.

Part No.	Size	Color	Gauge	Part No.	Size	Color	Gauge
BC88523	2'	red	4	BC88563	6'	red	2
BC88533	2'	black	4	BC88573	6'	black	2
BC88543	4'	red	2	BC88583	8'	red	1
BC88553	4'	black	2	BC88593	8'	black	1

JOHNSON/EVINRUDE STARTER SOLENOID APPLICATION

HP	Year Start	Year Stop	Starter Solenoid	HP	Year Start	Year Stop	Starter Solenoid
9.9	1990	1992	18-5813	33	1968	1970	18-5806
15	1990	1992	18-5813	35	1957	1959	18-5807
18	1957	1958	18-5807	35	1976	1988	18-5808
20	1985	1998	18-5808	35	1991	2001	18-5808
25	1972	2005	18-5808	40	1960	1966	18-5807
25	2009	2009	18-5833	40	1967	1976	18-5806
28	1986	1996	18-5808	40	1984	2005	18-5808
30	1984	2005	18-5808	40	2004	2009	18-5833
30	2009	2009	18-5833	45	1989	1992	18-5808
33	1965	1967	18-5807	48	1987	1996	18-5806

ⓘ Without Electric Shift Ⓢ With Electric Shift
APPLICATION CONTINUED ON NEXT PAGE

JOHNSON/VEINRUDE STARTER SOLENOID APPLICATION (CONT.)

HP	Year Start	Year Stop	Starter Solenoid	HP	Year Start	Year Stop	Starter Solenoid
50	1958	1959	18-5807	100	1984	2001	18-5808
50	1971	1975	18-5808	105	1996	2003	18-5808
50	1979	2005	18-5808	110	1986	1989	18-5808
50	2004	2009	18-5833	112	1994	1996	18-5808
55	1968	1969	18-5808	115	1969	1970	18-5808
55	1976	1981	18-5808	115	1973	1985	18-5808
55	1989	1992	18-5808	115	1990	2006	18-5808
55	1996	1997	18-5808	115	2007	2009	18-5833
55	2008	2009	18-5833	120	1985	1994	18-5808
60	1964	1966	18-5807	125	1971	1972	18-5808
60	1967	1971	18-5808	125	1989	1990	18-5808
60	1980	2001	18-5808	125	1992	1998	18-5808
60	2006	2009	18-5833	130	1995	2000	18-5808
65	1968	1968	18-5808	130	2009	2009	18-5833
65	1972	1973	18-5808	135	1973	1976	18-5808
65	1984	2001	18-5808	135	2001	2001	18-5808
65	2008	2009	18-5833	140	1977	1994	18-5808
70	1970	2001	18-5808	150	1976	2006	18-5808
75	1960	1964	18-5807	150	2007	2009	18-5833
75	1965	1965	18-5807 ⓐ	155	1984	1992	18-5808
75	1965	1965	18-5808 ⓑ	175	1977	2006	18-5808
75	1975	1988	18-5808	175	2007	2009	18-5833
75	2004	2009	18-5833	185	1984	1985	18-5808
80	1966	1966	18-5807 ⓐ	185	1989	1994	18-5808
80	1966	1967	18-5808 ⓑ	200	1976	2001	18-5808
85	1968	1980	18-5808	200	2005	2009	18-5833
85	1991	1995	18-5808	225	1986	2001	18-5808
88	1987	1996	18-5808	225	2005	2009	18-5833
90	1964	1964	18-5807	235	1978	1985	18-5808
90	1965	1965	18-5808	250	1991	2001	18-5808
90	1981	2006	18-5808	250	2005	2009	18-5833
90	2004	2009	18-5833	275	1985	1988	18-5808
100	1966	1968	18-5808	300	1985	1995	18-5808
100	1971	1972	18-5808	300	2008	2009	18-5833
100	1979	1980	18-5808				

ⓐ Without Electric Shift ⓑ With Electric Shift

JOHNSON/VEINRUDE TRIM RELAY/SOLENOID APPLICATION

HP	Year Start	Year Stop	Trim Relay / Solenoid	HP	Year Start	Year Stop	Trim Relay / Solenoid
60	1985	2001	18-5705	125	1989	1998	18-5705
65	1991	1995	18-5705	135	1976	1976	18-5814
70	1980	1981	18-5814	140	1977	1981	18-5814
70	1981	2001	18-5705	140	1981	1994	18-5705
75	1980	1981	18-5814	150	1978	1981	18-5814
75	1982	1987	18-5705	150	1981	2006	18-5705
75	2000	2003	18-5705	175	1977	1981	18-5814
85	1976	1980	18-5814	175	1981	2006	18-5705
85	1991	1995	18-5705	185	1984	1985	18-5705
88	1986	1996	18-5705	185	1990	1994	18-5705
90	1981	1981	18-5814	200	1976	1981	18-5814
90	1981	2006	18-5705	200	1981	1983	18-5705
100	1979	1980	18-5814	200	1986	2005	18-5705
100	1984	2005	18-5705	225	1986	2005	18-5705
110	1986	1989	18-5705	235	1978	1981	18-5814
115	1976	1981	18-5814	235	1981	1985	18-5705
115	1981	1985	18-5705	250	1991	2005	18-5705
115	1990	2006	18-5705	275	1985	1988	18-5705
120	1985	1994	18-5705	300	1985	1995	18-5705



18-5708
RECTIFIER
 Replaces: 582399, 583408
 6-10 AMP

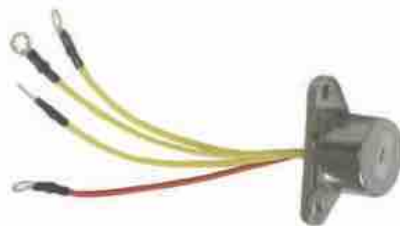

18-5709
RECTIFIER
 Replaces: 581778
 4-5 AMP



18-5825
REGULATOR/RECTIFIER
 Replaces: 395204



18-5826
REGULATOR/RECTIFIER
 Replaces: 584890



18-5827
REGULATOR/RECTIFIER
 Replaces: 585001, 584476



18-5828
REGULATOR/RECTIFIER
 Replaces: 585219, 439561



18-5829
REGULATOR/RECTIFIER
 Replaces: 586048



18-5830
REGULATOR/RECTIFIER
 Replaces: 586075



18-5831
REGULATOR/RECTIFIER
 Replaces: 586271, 584641, 585995



18-5832
REGULATOR/RECTIFIER
 Replaces: 583266, 583689,
 586000, 584424

REGULATOR/RECTIFIER APPLICATION ON NEXT PAGE

Model	Year	Part #	Model	Year	Part #
9.9,15	1974-92	18-5709	90	1981-92	18-5708
20	1989-98 ①	18-5709	90-115 60 DEGREE-V4	1996-UP	18-5830
25	1977-03 (2 CYL) ①	18-5709	100	1971, 1979-80, 1984-92 ②	18-5708
25/40/50TL/ J ELEC TR	1992	18-5827	115	1973-92	18-5708
25SIK/ SIL/ SIT	1994-1995	18-5827	120/140	1985	18-5832
25/35 3 CYL	1995-UP	18-5826	125	1971-72	18-5708
26	1989-96	18-5709	135	1974 ②	18-5708
30	1989-03 (2 CYL) ①	18-5709	135	1973, 1975-76	18-5708
35	1976-93 (2 CYL) ①	18-5709	140	1977-88	18-5708
35JET/ TL/ J ELEC.	1992-1993	18-5827	150	1979-88	18-5708
35JET/ M-TE/ TTL	1993-1995	18-5827	150/175 60 DEGREE-V6	1991-1995	18-5828
35JET/ EL/ TL/ TTL	1996	18-5827	150/175 60 DEGREE-V6	1996-UP	18-5829
35JET ELEC.	1997	18-5827	155	1984-88	18-5708
40	1974-76, 1988-92	18-5709	175	1977-83	18-5708
40/50TE/ EL/ TL/ TTL	1993-1996	18-5827	185	1984-88	18-5708
40/ 50 ELEC. 2 CYCLE.	1993-03 (2 CYCLE.)	18-5827	185/200/225	1993-1994	18-5831
45	1989-92 COMM	18-5709	185/200/225/200COMM	1990-1992	18-5832
45SS	1989-90	18-5709	200	1976-83	18-5708
48	1989-92	18-5709	200/225	1986-1989	18-5832
50	1971-75	18-5708	200/225/200COMM	1994-1997	18-5831
50	1979-92	18-5709	235	1978-88	18-5708
55	1976-77	18-5708	250/300	1991-1995	18-5831
55	1978-81, 1980-92 ①	18-5709	250	1997	18-5831
60	1970 ①, 1971	18-5708	275	1985-1986	18-5832
60	1980-88	18-5709	275/300 (3.6L)	1987	18-5832
60	1989-91 ①	18-5708	275/300	1988	18-5832
SST60	1989-90	18-5708	300 (3.6L) — PORT & STBD.	1985-1986	18-5832
60	1992-01	18-5827	300	1989-1990	18-5832
65	1972-73, 1988-91	18-5708	1.8/2.0L V4 'S'	1987-1990	18-5832
65 ELEC.	1992	18-5827	2.7L V6	1986-1987	18-5832
70	1974-91 ②	18-5827	3.0L V6	1988-1990	18-5832
70	1992-01	18-5708	3.0L V6	1993-1998	18-5832
75	1975-88	18-5708	3.6L V8	1987	18-5832
85	1970-80	18-5708	4.0L V8	1989-1990	18-5832
88	1989-92	18-5708	V-4 & V-6 Crossflow with 35 AMP	ALL	18-5825

- ① Also Commercial Models
- ② 1991 EL & TL Models only
- ③ Except 1992 Models WTLNE & WTXENE

- ④ Electric Start only
- ⑤ D Models only

- ⑥ EL & TL Models only
- ⑦ 135443, 135483 Models only



18-5434
OUTBOARD STARTER
Replaces: 386430, 763454
Fits: 9.9,15 HP (1974-92), 8 HP 4 Stroke (1996-98)



18-5640
OUTBOARD STARTER
Replaces: 395207, 387094, 585062, 586288, 778992
Fits: 150-235 HP, V6 models



18-5909
OUTBOARD STARTER
Replaces: 587078, 587291
Fits: Evinrude G2 Engines: C150 (AA-AB), C175 (AA-AB), A200 (AF-AG), C200 (AA-AB), E200 (AB-AG), H200 (AG-AH), E225 (AB-AG), H225 (AG-AH), A250 (AF-AG), E250 (AB-AG), H250 (AG-AH), A300 (AF-AG), E300 (AB-AG), H300 (AG-AH)

**ALL STARTERS ARE COUNTER CLOCKWISE ROTATION
 STARTER APPLICATION ON PAGE 284**



18-5612
OUTBOARD STARTER
 Replaces: 432925, 586287, 586286
 Fits: 175 HP models (1992)



18-5617
OUTBOARD STARTER
 Replaces: 586274, 778995
 Fits: 9.9, 15 HP models



18-5619
OUTBOARD STARTER
 Replaces: 584799, 396235, 391511, 397023,
 586731, 586890
 Fits: V6/V8 Looper models



18-5624
OUTBOARD STARTER
 Replaces: 583482, 585056, 586279
 Fits: 20-35 HP models (1989 & up)



18-5627
OUTBOARD STARTER
 Replaces: 583473, 585059, 585459, 778991
 Fits: 20-35 HP models (1987-93)



18-5628
OUTBOARD STARTER
 Replaces: 393570, 585060, 586285, 778994
 Fits: 140 HP models (1993)



18-5629
OUTBOARD STARTER
 Replaces: 392133, 585061, 386591, 586278
 Fits: 18-40 HP models



18-5630
OUTBOARD STARTER
 Replaces: 387684, 585063, 389275, 384163,
 586280, 778993
 Fits: 50-60 HP, 2 cyl. models



18-5631
OUTBOARD STARTER
 Replaces: 584818, 586277, 778996
 Fits: V-4, 60° models (1997 & up)



18-5632
OUTBOARD STARTER
 Replaces: 584980, 586284
 Fits: V-4, 60° models (1997 & up)



18-5634
OUTBOARD STARTER
 Replaces: 585057, 585051, 385529, 389954,
 586283
 Fits: 140 HP models (1977)



18-5648
OUTBOARD STARTER
 Replaces: 585058, 586281, 386657, 391735,
 585050, 384777
 Fits: 70 HP models

ALL STARTERS ARE COUNTER CLOCKWISE ROTATION
 STARTER APPLICATION ON NEXT PAGE



18-6826
STARTER

Replaces: 586768, 587045
Fits: 40-90HP E-Tec Engines



18-6863
STARTER

Replaces: 584608, 586275
Fits: Johnson/Evinrude 9.9-15HP 4-Stroke Engines



18-6945
STARTER

Replaces: 5036972
Fits: Johnson, Suzuki 25HP 2006-11



18-6250
OUTBOARD STARTER REPAIR KIT

Prestolite
2 Brush



18-6251
OUTBOARD STARTER REPAIR KIT

Prestolite
4 Brush



18-5655
DRIVE ASSEMBLY

Replaces: 321648
See next page for additional application



18-5671
DRIVE ASSEMBLY

Replaces: 384781
See next page for additional application



18-5674
DRIVE ASSEMBLY

Replaces: 387683
See chart below for additional application



18-5678
DRIVE ASSEMBLY

Replaces: 585269, 586101
See chart below for additional application



18-5679
DRIVE ASSEMBLY

Replaces: 585267, 586100
See chart below for additional application



18-5697
DRIVE BRUSH KIT

Replaces: 385952
See chart below for additional application

HP	Years	Starter #	O.E. Part #	O.E. #	Drive Assembly ☐	O.E. #	Tooth Count	Drive Brush Kit ☐	O.E. #
9.9/ 15	1974-92	—	386430	395264	—	319977	10	NA	NA
9.9/ 15	1993 & UP	18-5617	586274	395264	—	319977	10	NA	NA
9.9/ 15	1997 & Up 4 stroke	—	584613	NSS	18-5678 ☐	585267	10	18-5697	385952
20 ☐	1985-88	18-5629	586278	393354	18-5655	321648	11	18-5697	385952
20 thru 30 ☐	1993-98	18-5629	586278	393354	18-5655	321648	11	18-5697	385952
25 thru 35 ☐	1977-88	18-5629	586278	NSS	18-5655	321648	11	18-5697	385952
20 thru 30 ☐	1989-92	18-5627	585059	393354	18-5671 ☐	384781	9	18-5697	385952
25 thru 35	1997-99 3 cylinders	18-5631	586277	586100	NSS ☐	NSS	10	18-5697	385952
40-50	1984-88	18-5630	586280	NSS	18-5671 ☐	384781	9	18-5697	385952
50	1972	18-5630	586280	NSS	18-5671 ☐	585269	9	18-5697	385952
40-50 ☐	1989-99	18-5624	586279	NSS	18-5678 ☐	585269	9	18-5697	385952
55	1978	18-5630	586280	NSS	18-5678 ☐	585269	9	18-5697	385952
60	1985 2 cylinders	18-5630	586280	NSS	18-5678 ☐	585269	9	18-5697	385952
50	1985-99 3 cylinders	18-5648	586281	NSS	18-5678 ☐	585269	9	18-5697	385952
55	1969	18-5648	586281	NSS	18-5678 ☐	585269	9	18-5697	385952
60	1971	18-5648	586281	NSS	18-5671*	384781	9	18-5697	385952
60	1986-01 3 cylinders	18-5648	586281	NSS	18-5678 ☐	585269	9	18-5697	385952
65	1985-01 3 cylinders	18-5648	586281	NSS	18-5678 ☐	585269	9	18-5697	385952
70, 75	1980-01	18-5648	586281	NSS	18-5678 ☐	585269	9	18-5697	385952
85 thru 115	1973-99 crossflows	18-5634	586283	NSS	18-5679 ☐	586100	10	18-5697	385952

**ALL STARTERS ARE COUNTER CLOCKWISE ROTATION
STARTER APPLICATION CONTINUED ON NEXT PAGE**

HP	Years	Starter #	O.E. Part #	O.E. #	Drive Assembly ②	O.E. #	Tooth Count	Drive Brush Kit ③	O.E. #
90, 115	1995-99 loopers	18-5632	586284	NA	NA	NA	NA	18-5697	385952
120 thru 140	1985-94	18-5628	586285	NSS	18-5679 ①	586100	10	18-5697	385952
130	1995-99	18-5628	586285	NSS	18-5679 ①	586100	10	18-5697	385952
V-6 Crossflow	1976-92	18-5640	586288	393285	18-5674	387683	8	18-5697	385952
150, 175 60"	1991-99 loopers	18-5612	586286	NA	NA	NA	NA	18-5697	385952
150 thru 175 V-6	1997-03	18-5612	586287	NSS	NSS	NA	NA	NA	433850
200 thru 300	1986-Up: std. rotation	18-5619	586411	397375	NA	NA	10	18-5697	385952

Note: Some starters will replace Prestolite versions however replacement parts are for Bosch versions only.

* Starter drive retained with nut

NSS Not sold separately

① Drive kit includes drive assembly with clip style retainer

② Drive kits, drive assemblies, and brush sets offered are for "Bosch Style" starters only.

③ With 9 tooth pinion

④ For Bosch models

4-STROKE FUEL SYSTEM KITS



18-7761
CARBURETOR REBUILD KIT
Fits: Johnson/Evinrude Four-Stroke 4-6 hp. (2007)



18-7773
CARBURETOR REBUILD KIT
Replaces: 5032424
Fits: 25, 30 HP (2000-01) (2004 & Up)

2-STROKE FUEL SYSTEM KITS



18-7010
CARB KIT
Replaces: 382050, 382051, 382054



18-7219
CARB KIT
Replaces: 439073, 431897



18-7221
CARB KIT
Replaces: 435442



18-7222
CARB KIT
(with float)
Replaces: 392061, 398729, 396701



18-7223
CARB KIT w/ Needle & Seat
Replaces: 398452, 391305, 398453, 439072, 391937



18-7024
CARB KIT
Replaces: 382053, 382052, 385356, 439075



18-7042
CARB KIT
(without float)
Replaces: 392061, 398729, 396701



18-7043
CARB KIT
Replaces: 382045, 382046, 382047, 382049, 383052, 383067, 398532, 439071, 398514



18-7046
CARB KIT
Replaces: 390055, 392550, 398526, 435443, 434888, 439076, 433519
Contains 18-7038 Needle/Seat

2-STROKE FUEL SYSTEM KITS

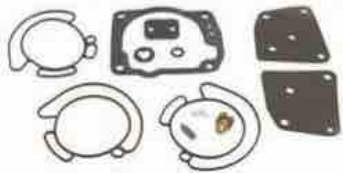

**18-7247
CARB KIT**

Replaces:
438996, 436852
For: V4 & V6 (60°) 1988-2001

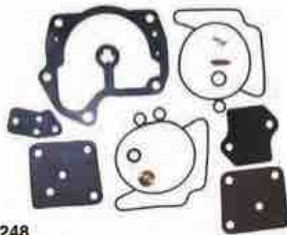

**18-7248
CARB KIT**

Replaces:
437327, 439079, 439078, 435676,
435677, 435678, 435752



**18-0871-1
SERVICE VALVE
WITH O-RING**

Replaces: 175158
Fits: All Johnson/Evinrude with primer
valve (except 1993 9.9 & 15hp.)



**18-7044-1
SERVICE VALVE KIT**

Replaces: 175158+437228
Fits: All Johnson/Evinrude with primer valve (except 1993
9.9 & 15 H.P.)



**18-0993
COVER & GASKET
ASSEMBLY**

Replaces: 437228
Fits: All Johnson/Evinrude with primer
valve (except 1993 9.9 & 15hp.)



NEEDLE & SEAT

Part #	Replaces
18-7093	396521, 678882, 378895
18-7094	379313, 396522
18-7093	396520, 379312, 387262

PKG. OF 10



**18-7106
18-7106-9^①
NEEDLE PACKING**

Replaces: 307583



**18-7210
FLOAT**

Replaces: 382363

PKG. OF 5



**18-7296
18-7296-9^①
ADJUSTING NEEDLE
RETAINER**

Replaces: 315232

① Priced per Package

HP	YEAR	CARB. KIT W/O FLOAT	CARB. KIT W/ FLOAT	NEEDLE & SEAT	CARB. FLOAT
1.5	1970-90	18-7043	—	18-7094	—
2	1970-90	18-7043	—	18-7094	—
3	1952-67	18-7043	—	18-7038	—
3	1968	18-7043	—	18-7094	—
4	1983-89	18-7223	—	18-7094	—
4	1991-93	18-7223	—	18-7094	—
4.5	1982-84, 1987	18-7223	—	18-7094	—
5	1965-67	18-7043	—	18-7094	—
5	1968	18-7024	—	18-7093	—
5	1984-85	18-7223	—	18-7094	—
5.5	1954-67	18-7043	—	18-7094	—
6	1954-79	18-7043	—	18-7094	—
6	1968	18-7024	—	18-7093	—
6	1984-85	18-7223	—	18-7094	—
6, 8	1986-96	18-7219	—	—	—
7.5	1955-58	18-7043	—	18-7094	—
7.5	1982-83	18-7223	—	18-7094	—
8	1984-85	18-7223	—	18-7094	—
9.9	1974-88	18-7223	—	18-7094	—

① Commercial ② Also Commercial ③ Early Production ④ Cross Flow ⑤ Except 1995-Up 3 Cylinder Models

HP	YEAR	CARB. KIT W/O FLOAT	CARB. KIT W/ FLOAT	NEEDLE & SEAT	CARB. FLOAT
9.9/15	1989-96	18-7219	—	—	—
10	1954-63	18-7043	—	18-7084	—
14	1968 ①	18-7223	—	18-7094	—
15	1955-56	18-7043	—	18-7094	—
15	1974-88	18-7223	—	18-7094	—
18	1957-68	18-7043	—	18-7094	—
18	1969-73	18-7042	18-7222	18-7093	18-7210
20	1957-68	18-7043	—	18-7094	—
20	1969-90	18-7042	18-7222	18-7093	18-7210
20	1991-96	18-7219	—	18-7094	—
25	1954-55	18-7024	—	18-7093	—
SAIL DR	1978-UP	18-7042	18-7222	18-7093	18-7210
25	1969-85 ⑤	18-7042	18-7222	18-7093	18-7210
28	1962-64	18-7010	—	18-7093	—
28	1976-95	18-7042	18-7222	18-7093	18-7210
30	1956	18-7024	—	18-7093	—
30	1976-UP	18-7042	18-7222	18-7093	18-7210
33	1965-70	18-7010	—	18-7093	—
35	1957-59	18-7024	—	18-7093	—
35	1959	18-7010	—	18-7093	—
35	1976-95 ⑤	18-7042	18-7222	18-7093	18-7210
40	1960-63, 1971	18-7010	—	18-7093	—
40	1965-70, 1972-78	18-7024	—	18-7093	—
40	1971-90, 1979-92 ①	18-7042	18-7222	18-7093	18-7210
45	1971-97 ②	18-7042	18-7222	18-7093	18-7210
48	1992-97	18-7042	18-7222	18-7093	18-7210
50	1958-59	—	—	18-7093	—
50	1971-97	18-7042	18-7222	18-7093	18-7210
55	1968-69, 1971-97 ①	18-7042	18-7222	18-7093	18-7210
60	1964-67	—	—	18-7093	—
60	1970-97	18-7042	18-7222	18-7093	18-7210
65	1972-97	18-7042	18-7222	18-7093	18-7210
70	1972-97 (3 CYL)	18-7042	18-7222	18-7093	18-7210
75	1960-63	—	—	18-7093	—
75	1975-88	18-7042	18-7222	18-7093	18-7210
80	1966-67	—	—	18-7093	—
85	1968	—	—	18-7093	—
85	1971-79	18-7046	—	18-7093	—
85	1969-70, 1991-93	18-7046	—	18-7038	—
V-4	1969-79	18-7046	—	18-7038	—
V-4	1983-84	18-7046	—	18-7038	—
88,90	1985-95	18-7046	—	18-7038	—
90	1981-82, 1983 ③	18-7046	—	18-7038	—
90	1995-02	18-7247	—	—	—
100	1971, 1980	18-7046	—	18-7038	—
100	1972, 1979	18-7046	—	18-7093	—
100	1998-01	18-7247	—	—	—
105	1999-01	18-7247	—	—	—
115	1969, 1980-95	18-7046	—	18-7038	—
115	1995-02	18-7046	—	18-7093	—
115	1995-02	18-7247	—	—	—
V-6	1976-90 ④	18-7046	—	18-7038	—
115	1983	18-7046	—	18-7038	—
120	1985-90	18-7248	—	18-7094	—
120	1985-90, 1993	18-7248	—	18-7094	—

① Commercial ② Also Commercial ③ Early Production ④ Cross Flow ⑤ Except 1995-Up 3 Cylinder Models

HP	YEAR	CARB. KIT W/D FLOAT	CARB. KIT W/ FLOAT	NEEDLE & SEAT	CARB. FLOAT
125	1971-72	18-7046	—	18-7093	—
125	1993	18-7248	—	18-7094	—
125C	1989-95	18-7248	—	18-7094	—
135	1973-76	18-7046	—	18-7093	—
140	1977, 1980-83	18-7046	—	18-7038	—
140	1978-79	18-7046	—	18-7093	—
140	1985-90	18-7248	—	18-7094	—
140	1993	18-7248	—	18-7094	—
150	1979-90	18-7046	—	18-7038	—
150	1992-96, 1998-02	18-7247	—	—	—
155	1984-93 ①	18-7046	—	18-7038	—
175	1977-91	18-7046	—	18-7038	—
175	1992-96, 1998-02	18-7247	—	—	—
185	1984	18-7046	—	18-7038	—
185	1989-93	18-7221	—	18-7094	—
200	1976-83	18-7046	—	18-7038	—
200	1986-90	18-7248	—	18-7094	—
200	1992-93	18-7221	—	18-7094	—
225	1986-90, 1992-93	18-7221	—	18-7094	—
235	1978-84	18-7046	—	18-7038	—
250	1991-93	18-7221	—	18-7094	—
275/3.6L	1985-88	18-7221	—	18-7094	—
300	1988, 1991-93	18-7221	—	18-7094	—

① Commercial ② Also Commercial ③ Early Production ④ Cross Flow ⑤ Except 1995-Up 3 Cylinder Models



**18-7350
FUEL PUMP**
Replaces: 397839, 391638, 395091,
397274
For: 6/8/9, 9/15 HP 1981-92
Uses kit **18-7823**



**18-7351
FUEL PUMP**
Replaces: 434728, 438562
For: 9.9/15 HP 1993-2006
Uses kit **18-7800**



**18-7352
FUEL PUMP**
Replaces: 438556, 388268, 385781,
394543, 382354, 395713, 398338,
432451, 398387, 433387
For: 25-55 HP 1978-89 (non-VRO)
Uses kit **18-7821**



**18-7353
FUEL PUMP**
Replaces: 438555, 433386
For: 20-30 HP 1990-2000
Uses kit **18-7800**



**18-7800
FUEL PUMP KIT**
Replaces: 438616, 433519



**18-7801
FUEL PUMP KIT**
Replaces: 379777



**18-7820
FUEL PUMP KIT**
Replaces: 393103



**18-7821
FUEL PUMP KIT**
Replaces: 398514, 395867



**18-7822
FUEL PUMP KIT**
Replaces: 432962

 <p>18-7823 FUEL PUMP KIT Replaces: 393088</p>	<p>PKG. OF 2</p>  <p>18-7796 CHECK VALVE Replaces: 335334 (Enlarged to show detail)</p>	 <p>18-3497 DIAPHRAGM KIT Replaces: 5033372 4-5 HP (2003-06), 6 HP (2005-06) 4-Stroke</p>
---	---	---

 <p>18-3498 DIAPHRAGM KIT Replaces: 5036216, 5037584 10-15 HP (2005-07) 4-Stroke</p>	 <p>18-3499 DIAPHRAGM KIT Replaces: 5030699 9.9, 15 HP (2002-04), 25HP (2004-06), 30HP (2004-07), 40-70 HP (2002-06) 4-Stroke</p>
--	--

FUEL PUMP REPAIR KIT APPLICATION

ALL KITS ARE FOR NON-VRO (VARIABLE RATIO OILING) PUMPS

HP	Year Start	Year Stop	Fuel Pump Repair Kit	HP	Year Start	Year Stop	Fuel Pump Repair Kit	HP	Year Start	Year Stop	Fuel Pump Repair Kit
2.5	1987	1988	18-7823	25	2001	2001	18-3497	50	1990	2012	18-7800
3	1989	1997	18-7823	25	2004	2005	18-3497	50	AA	AG	18-7800
4	1982	2001	18-7823	28	1962	1963	18-7801	50	1999	2006	18-3497
4	2003	2007	18-3497	28	1966	1987	18-7821	55	1983	1984	18-7820
4.5	1982	1987	18-7823	28	1988	1990	18-7822	55	1985	1990	18-7821
5	1982	1983	18-7823	28	1990	1998	18-7800	55	1991	2005	18-7800
5	1985	1993	18-7823	30	1984	1984	18-7820	55	2008	2012	18-7800
5	1996	1998	18-7823	30	1985	1987	18-7821	55	AA	AG	18-7800
5	2003	2007	18-3497	30	1988	1990	18-7822	60	1964	1967	18-7801
6	1984	2005	18-7823	30	1990	2005	18-7800	60	1982	1984	18-7820
6	1987	1987	18-7821	30	2001	2001	18-3497	60	1985	1985	18-7821
6	2003	2007	18-3497	30	2004	2007	18-3497	60	1988	1988	18-7821
7.5	1980	1983	18-7823	35	1958	1959	18-7801	60	2002	2006	18-3497
8	1982	2005	18-7823	35	1976	1984	18-7820	60	2005	2012	18-7800
8	1987	1987	18-7821	35	1986	1987	18-7821	60	AA	AG	18-7800
9.9	1974	1992	18-7823	35	1988	1990	18-7822	65	1984	1984	18-7820
9.9	1987	1990	18-7821	35	1990	2001	18-7800	65	1985	1985	18-7800
9.9	1990	1999	18-7800	40	1960	1964	18-7801	65	1985	1986	18-7821
10	1996	2007	18-7800	40	1971	1976	18-7820	65	1989	1989	18-7821
10	2002	2004	18-3497	40	1983	1984	18-7820	65	1991	2001	18-7800
10	2005	2007	18-3497	40	1985	1987	18-7821	65	2008	2012	18-7800
14	1988	1988	18-7823	40	1988	1990	18-7822	65	AA	AF	18-7800
15	1974	1988	18-7823	40	1990	2012	18-7800	70	1982	1984	18-7820
15	1987	1990	18-7821	40	AA	AG	18-7800	70	1998	2006	18-3497
15	1990	2007	18-7800	40	1999	2006	18-3497	75	1960	1965	18-7801
15	2002	2004	18-3497	45	1958	1959	18-7801	75	1982	1984	18-7820
15	2005	2007	18-3497	45	1986	1990	18-7821	75	2004	2012	18-7800
20	1985	1987	18-7821	45	1991	1997	18-7800	75	AA	AF	18-7800
20	1988	1990	18-7822	48	1987	1987	18-7821	80	1966	1967	18-7801
20	1990	1998	18-7800	48	1988	1990	18-7822	85	1977	1983	18-7820
25	1971	1976	18-7823	48	1990	1996	18-7800	88	1987	1990	18-7821
25	1977	1984	18-7820	50	1958	1959	18-7801	88	1990	1996	18-7800
25	1985	1987	18-7821	50	1982	1984	18-7820	90	1964	1965	18-7801
25	1988	1990	18-7822	50	1985	1987	18-7821	90	1981	1983	18-7820
25	1990	2005	18-7800	50	1988	1990	18-7822	90	1997	1998	18-7800

© Priced per Package

APPLICATION CONTINUED ON NEXT PAGE

FUEL PUMP REPAIR KIT APPLICATION

ALL KITS ARE FOR NON-VRO (VARIABLE RATIO OILING) PUMPS

HP	Year Start	Year Stop	Fuel Pump Repair Kit	HP	Year Start	Year Stop	Fuel Pump Repair Kit	HP	Year Start	Year Stop	Fuel Pump Repair Kit
90	2004	2012	18-7800	112	1994	1996	18-7800	150	1978	1984	18-7820
90	AA	AF	18-7800	115	1982	1983	18-7820	175	1977	1983	18-7820
100	1966	1966	18-7801	115	1997	1998	18-7800	200	1977	1983	18-7820
100	1989	1990	18-7821	115	2004	2005	18-7800	235	1978	1984	18-7820
100	1996	1997	18-7800	125	1995	1998	18-7800				
105	1997	2003	18-7800	140	1977	1983	18-7820				

Ⓢ Priced per Package

APPLICATION CONTINUED ON NEXT PAGE

FUEL PUMP APPLICATION

HP	Year Start	Year Stop	Fuel Pump	HP	Year Start	Year Stop	Fuel Pump
6	1988	1991	18-7350	35	1990	1994	18-7353
8	1988	1991	18-7350	35	1996	1996	18-7353
9.9	1981	1992	18-7350	40	1968	1976	18-7352
9.9	1993	1999	18-7351	40	1983	1984	18-7352
10	1997	1998	18-7351	50	1974	1975	18-7352
10	2000	2001	18-7351	50	1979	1984	18-7352
10	2003	2007	18-7351	55	1976	1981	18-7352
15	1981	1998	18-7350	55	1983	1984	18-7352
15	1993	2007	18-7351	60	1980	1984	18-7352
20	1990	1998	18-7353	85	1977	1980	18-7352
25	1977	1984	18-7352	90	1981	1983	18-7352
25	1990	2005	18-7353	90	1997	1998	18-7352
28	1990	1996	18-7353	100	1979	1980	18-7352
30	1984	1984	18-7352	100	1997	1997	18-7352
30	1990	2005	18-7353	115	1977	1983	18-7352
33	1968	1970	18-7352	115	1997	1998	18-7352
35	1976	1984	18-7352	140	1977	1983	18-7352

FUEL WATER SEPARATOR KITS



**21 MICRON
FILTER KITS FOR
CARBURETED ENGINES**



KIT TYPE	PART #	MICRON RATING	CONTENTS
1/4" ALUMINUM (SHORT FILTER)	18-7848-1	21	1 - 18-7844 filter & 1 18-7853-1 bracket 2 - 18-4256 1/4" PIPE PLUGS
1/4" ALUMINUM BONUS PACK CONTAINS SPARE FILTER	18-7848-2	21	2 - 18-7844 FILTER & 1 18-7853-1 BRACKET 2 - 18-4256 1/4" PIPE PLUGS
1/4" ALUMINUM (TALL FILTER) CONTAINS SPARE FILTER	18-7852-1	21	1 - 18-7845 FILTER & 1 18-7853-1 BRACKET 2 - 18-4256 1/4" PIPE PLUGS
3/8" ALUMINUM (TALL FILTER)	18-7775-1	21	1 - 18-7845 FILTER & 1 18-7775 BRACKET 2 - 18-4264 3/8" PIPE PLUGS
1/4" STAINLESS STEEL (TALL FILTER)	18-7777-1	21	1 - 18-7845 FILTER & 1 18-7777 BRACKET 2 - 18-4256 1/4" PIPE PLUGS
3/8" STAINLESS STEEL (TALL FILTER)	18-7776-1	21	1 - 18-7845 FILTER & 1 18-7776 BRACKET 2 - 18-4264 3/8" PIPE PLUGS

• Display Packaged

**- UNIVERSAL DESIGN -
DIRECT REPLACEMENT FOR MERCURY AND YAMAHA
FUEL WATER SEPARATOR BRACKETS**



Bracket Type	Part #
1/4" Stainless Steel	18-7777
3/8" Stainless Steel	18-7776



Bracket Type	Part #
1/4" Aluminum	18-7853-1
3/8" Aluminum	18-7775

**10 MICRON FILTER KITS
FOR FUEL INJECTED ENGINES**

- Display Packaged

Kit Type	Part #	Micron Rating	Contents
1/4" Aluminum (Short Filter)	18-7983-1	10	1 - 18-7944 filter & 1 18-7853-1 bracket 2 - 18-4256 1/4" pipe plugs
1/4" Aluminum Bonus Pack Contains spare filter	18-7983-2	10	2 - 18-7944 filter & 1 18-7853-1 bracket 2 - 18-4256 1/4" pipe plugs
1/4" Aluminum (Tall Filter)	18-7982-1	10	1 - 18-7945 filter & 1 18-7853-1 bracket 2 - 18-4256 1/4" pipe plugs
1/4" Aluminum Bonus Pack Contains spare filter	18-7982-2	10	2 - 18-7945 filter & 1 18-7853-1 bracket 2 - 18-4256 1/4" pipe plugs
1/4" Aluminum (High Capacity Filter)	18-7966-1	10	1 - 18-7866 filter & 1 18-7853-1 bracket 2 - 18-4256 1/4" pipe plugs
3/8" Aluminum (Tall Filter)	18-7986-1	10	1 - 18-7945 filter & 1 18-7775 bracket 2 - 18-4264 3/8" pipe plugs
1/4" Stainless Steel (Tall Filter)	18-7984-1	10	1 - 18-7945 filter & 1 18-7777 bracket 2 - 18-4256 1/4" pipe plugs
3/8" Stainless Steel (Tall Filter)	18-7985-1	10	1 - 18-7945 filter & 1 18-7776 bracket 2 - 18-4264 3/8" pipe plugs



10 MICRON FILTER KITS WITH DRAIN BOWLS

Sierra AquaVue™ and metal bowl separator filters allow water to be drained from the filter to extend service life. Use the AquaVue™ bowl for outboard, above deck installations. USCG regulations require the use of the flame resistant metal bowl below deck.

Kit Type	Part #	Micron Rating	Contents
1/4" Aluminum w/ AquaVue™ bowl	18-7932-1	10	1 - 18-7919 filter & 1 18-7853-1 bracket 1 - 18-7922-1 AquaVue™ bowl 2 - 18-4256 1/4" pipe plugs
1/4" Aluminum w/ metal drain bowl	18-7951	10	1 - 18-7919 filter & 1 18-7853-1 bracket 1 - 18-7924 metal bowl 2 - 18-4256 1/4" pipe plugs
1/4" Stainless Steel w/ AquaVue™ bowl	18-7937-1	10	1 - 18-7919 filter & 1 18-7777 bracket 1 - 18-7922-1 AquaVue™ bowl 2 - 18-4256 1/4" pipe plugs
1/4" Stainless Steel w/ metal drain bowl	18-7938	10	1 - 18-7919 filter & 1 18-7777 bracket 1 - 18-7924 metal bowl 2 - 18-4256 1/4" pipe plugs

COMPACT BRACKET AND SEPARATOR KIT - FOR SMALL OUTBOARDS AND FRESH WATER APPLICATIONS

**18-7774
COMPACT ALUMINUM BRACKET**



**18-7965-1
10 MICRON COMPACT
SEPARATOR KIT**
Contains:
1 - 18-7774 bracket
1 - 18-7865 filter



- Display Packaged

REPLACEMENT FILTERS



UNIVERSAL DESIGN

10 MICRON REPLACEMENT FILTERS

21 MICRON REPLACEMENT FILTERS

Part No.	Description	Part No.	Description
18-7944	Short - 3.875"	18-7844	Short - 3.875"
18-7945	Long - 4.35"	18-7845	Long - 4.35"
18-7886	High Capacity - 6"		
18-7865	Compact 10 Micron		

REPLACEMENT FILTERS FOR OMC

10 MICRON REPLACEMENT FILTERS

21 MICRON REPLACEMENT FILTERS

Part No.	Description	Replaces	Part No.	Description	Replaces
18-7946	OMC thread	OMC 502905	18-7846	OMC thread	OMC 502905
18-7989	Cobra EFI	OMC 502906	18-7789	Cobra EFI	OMC 502906



• Display Packaged

10 MICRON REPLACEMENT FILTERS AND KITS WITH DRAIN BOWLS

REPLACEMENT ELEMENTS

ELEMENT & BOWL KITS

Part No.	Description	Replaces	Part No.	Description
18-7919	Spin on replacement	Racor S3213	18-7928-1	Filter & AquaVue™ Bowl Contains: 18-7919 filter, 18-7922-1 bowl
18-7920	Spin on replacement OMC style	OMC 502906 Racor S3214	18-7929	Filter & Metal Bowl Contains: 18-7919 filter, 18-7924 bowl

REPLACEMENT BOWLS

Part No.	Description	Part No.	Description
18-7922-1	AquaVue™ Collection Bowl	18-7941-1	Filter & AquaVue™ Bowl Contains: 18-7920 filter, 18-7922-1 bowl
18-7924	Metal Collection Bowl	18-7943	Filter & Metal Bowl Contains: 18-7920 filter, 18-7924 bowl



**18-79781
FUEL FILTER**
Replaces: 433190
60° V4 and V6



**18-7953
FUEL FILTER**
Replaces: 5035974
Fits: 25HP (2006-07) / 90,115,140
4 stroke (2005-06)



**18-7716
FUEL FILTER**
Replaces: 5032323
Fits: Johnson 25 4-Stroke (2004-06), 30
4-Stroke (2004-07), 40/60/70 4-Stroke
(2002-06), 90/115/140 4-Stroke (2003-04,
2006), Evinrude 25/30/40/50/70 4-Stroke
(2000-01)



**18-7719
FUEL FILTER**
Replaces: 5032238
Fits: Johnson 4/5 (2003-07), 6 4-Stroke
(2005-07), 10/15 4-Stroke (2002-07),
40/50/60/70 4-Stroke (2002-06), Evin-
rude 40/50 4-Stroke (2000-01)



**18-7722
FUEL FILTER**
• 3/8" barbs
Replaces: 5005266
For: E-Tec 40, 50, 60, 75, 90,115, 150, 175 & 200DPL



**18-7826
FUEL FILTER**
Replaces: 305185



INLINE FUEL FILTERS

Part No.	Application
18-7828-1	1/4" Small Capacity (For 1/4" Fuel Line)
18-7829	1/4" Large Capacity (For 1/4" Fuel Line)
18-7830	5/16" Replaces: OMC 398327
18-7831	3/8" Replaces: OMC 398319

8' LENGTH COMPLETE FUEL LINE ASSEMBLIES

3/8"
FUEL LINE ASSEMBLY

18-8009EP-2 *SILVERADO 4000 Premium*

OE# 398549



18-8063
TANK CONNECTOR
(SOLD SEPARATELY)



18-8092
FUEL CONNECTOR



18-8005EP-1
PRIMER BULB

18-8092
FUEL CONNECTOR



*

*

FUEL LINE ASSEMBLY COMPONENTS
Fits: 2 HP (1 cyl.) - 75 HP (3 cyl.) (1976-02)

8' LENGTH COMPLETE FUEL LINE ASSEMBLIES

3/8"
FUEL LINE ASSEMBLY

18-8014EP-2 *SILVERADO 4000 Premium*

OE# 174509



18-8074
HOSE BARB
(SOLD SEPARATELY)



18-8005EP-1
PRIMER BULB

18-8092
FUEL CONNECTOR



*

*

FUEL LINE ASSEMBLY COMPONENTS
Fits: All V6 & V8 (1976-02)



18-8004EP-1
18-8004-10EP-1
PRIMER BULB
3/8"
Replaces: 174511, 775638
Large capacity bulb



18-8005EP-1
18-8005-10EP-1
PRIMER BULB
3/8"
Replaces: 174512
Large capacity bulb



HOSE BARB APPLICATION

INLINE FUEL FILTERS

Part No.	OMC No.	Barb	NPT	Conn. Type
18-8055	173311	5/16"	1/4"	Male
18-8074	173312	3/8"	1/4"	Male



18-8056
18-8056-10
FUEL CONNECTOR
3/8"
Replaces: 174508, 775640
Mates with 18-8063



18-8063
18-8063-10
TANK CONNECTOR
Replaces: 502867, 772681, 0772681
(1/4" NPT)
Mates with 18-8056 & 18-8092



18-8072
FUEL ELBOW
3/8" Barb w/ 3/8" NPT Thread
Replaces: 174177
90°



18-8092
FUEL CONNECTOR
3/8"
Replaces: 176445, 775641
Mates with 18-8063



18-3290
INDICATOR ELBOW
Replaces: 321886
Pipe threaded to hose



BLEEDER HOSE
18-8048 **18-8050**
.090 I.D. x 220 O.D. .0625 I.D. x .190 O.D.



18-8051
FUEL LINE HOSE
1/8" I.D.
Replaces: 322656
For OMC Pressurized Systems



18-8052
FUEL LINE HOSE
3/16" I.D.
Replaces: 122638
Non-Pressurized Systems

SAE J1527 USCG Type B1-15
SILVERADO 4000



16-337-0560
5/16" I.D.
16-337-0380
3/8" I.D.

Also available in 50' reels.

* Tanks and Engines for picture purpose only.

Ⓜ Discount shop pack of 10 - Priced per package.



18-9125
OETIKER CLAMP KIT
Replaces: 787133, 787145

Part #	Qty	Johnson/Evinrude #	Oetiker #	Description
18-9141	1	787145	14100082	Oetiker Jaw Pincers
Nominal ID				
Part #	Qty	Johnson/Evinrude #	Oetiker #	Inches mm
18-9126-9	10	346930	16700004	3/8" 9.5
18-9127-9	10	348838	16700006	13/32" 10.5
18-9128-9	10	349516	16700007	7/16" 11.3
18-9129-9	10	347107	16700010	1/2" 13.3
18-9130-9	10	347108	16700011	17/32" 13.8
18-9131-9	10	346931	16700012	35/64" 14
18-9132-9	10	346785	16700013	9/16" 14.5
18-9133-9	10	346786	16700016	5/8" 15.7
18-9134-9	10	348839	16700017	11/16" 17
18-9135-9	10	346151	16700024	13/16" 21
18-9136-9	10	346152	16700031	1" 25.6
18-9137-9	10	346153	16700037	1 3/16" 30.1
18-9138-9	10	349759	16700040	1 1/4" 31.6
18-9139-9	10	349729	16700053	1 5/8" 41
18-9140-9	10	346150	16700020	23/32" 18.5

All clamps are standard package of 10. Each package of 10 is available individually.

PKG. OF 10



SNAPPER CLAMPS

Part No.	Clamp O.E. No.	Range	Size
18-8020	322652	538 - 608	6
18-8021	911616	597 - 665	10
18-8034	329654	670 - 780	12
18-8200	322653	360 - 406	2
18-8201	124249	410 - 468	4
18-8202	322654	475 - 536	6
18-8203*	329653	750 - 875	14
18-8204*	324825	875 - 975	19



18-8905
IMPELLER REPAIR KIT

Replaces: 5008968
For: 15 (AA-AF), 25 (AA-AF), 30 (AA-AF)

— 18-8905 CONTAINS —

Part No.	Description	OE #	Qty
18-3295	Key	344470	1
18-4539	Impeller	5008967	1
18-5701	Spring, Pressure Relief	355169	1
18-5703	Spring, Thermostat	355209	1



18-3001
IMPELLER
Replaces: 277181, 434424



18-3002
IMPELLER
Replaces: 375638, 775518



18-3006
IMPELLER
Replaces: 378891, 775521



18-3015
IMPELLER
Replaces: 396852, 433935, 797407
With Key
For: 2.5, 3, 4 Ultra, Excel



18-3043
IMPELLER
Replaces: 389642



18-3044
IMPELLER
Replaces: 385072



18-3050
18-3050-10
IMPELLER
Replaces: 386084



18-3051
IMPELLER
Replaces: 395289

① This product is priced per piece. To order price per package, please add -9 to the part number.

IMPELLER APPLICATION BEGINS ON PAGE 303

 <p>18-3096 IMPELLER Replaces: 5031417 Fits: 25-30HP (2000-01, 2004-07), 40-50HP (1999-06)</p>	 <p>18-8906 IMPELLER Replaces: 436137 Fits: 5-HP (1996-98), 6-8HP (1991-2005)</p>	 <p>18-8907 IMPELLER Replaces: 5033542 Fits: 90, 115, 140 (2003-06)</p>	
 <p>18-3053-1 IMPELLER Replaces: 396725 Wedge Key</p>	 <p>18-3055 IMPELLER Replaces: 389589</p>	 <p>18-3059 18-3059-10 ① IMPELLER Replaces: 381538, 389289, 394534, 395864, 397131, 435821, 435748, 439948, 5001593 Includes 18-3299 Impeller Key</p>	 <p>18-3082 IMPELLER Replaces: 382547 Slotted Key</p>
 <p>18-3083 IMPELLER Replaces: 377230, 777213</p>	 <p>18-3090 IMPELLER Replaces: 387361, 763735</p>	 <p>18-3091 IMPELLER Replaces: 389576</p>	 <p>18-3099 IMPELLER Replaces: 5033112 For: 4 Stroke 9.9 and 15 HP (2002-up)</p>
 <p>18-3104-1 IMPELLER Replaces: 432941, 437059, 765350</p>	 <p>18-3366 IMPELLER Replaces: 390286</p>	 <p>18-3368 IMPELLER Replaces: 396809</p>	 <p>18-45312 IMPELLER Replaces: 114812 Fits: J/E 2(1993-99), 3(1991-99)</p>
 <p>18-4539 IMPELLER Replaces: 5008967 Fits: 15 (AA-AF), 25 (AA-AF), 30 (AA-AF)</p>	 <p>18-45221 IMPELLER Replaces: 382221 Fits: Johnson Evinrude 1.5/2 hp (1967-84)</p>	 <p>18-3102 IMPELLER PLATE Replaces: 305303</p>	 <p>18-3103 IMPELLER PLATE Replaces: 303069</p>
<p align="center">APPLICATION BEGINS ON PAGE 303 ① Discount shop pack of 10 - Priced per package</p>			



18-3127
IMPELLER PLATE
Replaces: 319275



18-3182
IMPELLER PLATE
Replaces: 317841



18-3346
CUP & PLATE ASSEMBLY
Replaces: 435027



18-3126
WEAR PLATE
Replaces: 321940



18-3343
WEAR PLATE
Replaces: 320981



18-3178
WEAR PLATE
Replaces: 318995



18-3455
INSERT CUP
Replaces: 340619
For: 40, 50, 25 Jet, 30 Jet 1995-Up,
E-Tec 40/50/60 HP All



18-3358
INSERT CUP
Replaces: 328751



18-3179
WATER PUMP CUP
Replaces: 324097



18-3501
DIAPHRAGM & CUP ASSEMBLY
Replaces: 435957
For: 8 (1996-97), 10 (1996-97), 15 (1996-97),
40 (1995-97), 50 (1995-97), 55 (1995-97),
60 (1993-96), 65 (1993-96), 70 (1993-96),
120 (1993-94), 125 (1993-95), 130 (1993-96),
140 (1993-94), 250 (1994-95), 300 (1994-95)

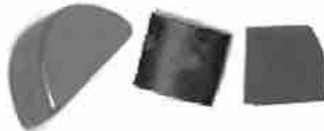

IMPELLER KEYS

Part No.	Replaces	Std. Pkg
18-3295 ②	330619, 344470	3
18-3138 ① ②	334897	2
18-3108	308928	1
18-3299 ③	331107	5
18-3326	300611	1

① Pkg of 2 ② Pkg of 3

APPLICATION BEGINS ON PAGE 303

Ⓜ This product is priced per piece. To order priced per package, please add -9 to the part number.

 <p>18-3180 WATER PUMP HOUSING Replaces: 435390</p>	 <p>18-3129 WATER PUMP HOUSING Replaces: 435673, 438591, 436954, 432955</p>	 <p>18-3336 WATER PUMP HOUSING Replaces: 384087</p>																															
 <p>18-3363 WATER PUMP HOUSING Replaces: 330560</p>	 <p>18-3367 WATER PUMP HOUSING Replaces: 393632</p>	 <p>18-3405 WATER PUMP HOUSING Replaces: 435959</p>																															
 <p>18-4568 IMPELLER HOUSING Replaces: 5007554 Fits: 90 (2013 & Up), 115/130 (2009 & Up)</p>	 <p>18-4569 IMPELLER HOUSING Replaces: 339720</p>	 <p>18-4571 IMPELLER HOUSING Replaces: 360347 Fits: 200-300HP (2009 & Up)</p>																															
 <p>18-3201 IMPELLER REPAIR KIT Replaces: 379763</p> <p>— CONTAINS —</p> <table border="1"> <thead> <tr> <th>Part #</th> <th>Desc.</th> <th>O.E. #</th> <th>Qty.</th> </tr> </thead> <tbody> <tr> <td>18-3001</td> <td>Impeller</td> <td>277181, 434424</td> <td>1</td> </tr> <tr> <td>NSS</td> <td>Plate</td> <td>203132</td> <td>1</td> </tr> </tbody> </table>	Part #	Desc.	O.E. #	Qty.	18-3001	Impeller	277181, 434424	1	NSS	Plate	203132	1	 <p>18-3202 IMPELLER REPAIR KIT</p> <p>— CONTAINS —</p> <table border="1"> <thead> <tr> <th>Part #</th> <th>Desc.</th> <th>O.E. #</th> <th>Qty.</th> </tr> </thead> <tbody> <tr> <td>18-3001</td> <td>Impeller</td> <td>277181, 434424</td> <td>1</td> </tr> <tr> <td>18-3102</td> <td>Impeller Plate</td> <td>305303</td> <td>1</td> </tr> </tbody> </table>	Part #	Desc.	O.E. #	Qty.	18-3001	Impeller	277181, 434424	1	18-3102	Impeller Plate	305303	1								
Part #	Desc.	O.E. #	Qty.																														
18-3001	Impeller	277181, 434424	1																														
NSS	Plate	203132	1																														
Part #	Desc.	O.E. #	Qty.																														
18-3001	Impeller	277181, 434424	1																														
18-3102	Impeller Plate	305303	1																														
 <p>18-3203 IMPELLER REPAIR KIT Replaces: 379766, 379766</p> <p>— CONTAINS —</p> <table border="1"> <thead> <tr> <th>Part #</th> <th>Desc.</th> <th>O.E. #</th> <th>Qty.</th> </tr> </thead> <tbody> <tr> <td>18-3002</td> <td>Impeller</td> <td>375638</td> <td>1</td> </tr> <tr> <td>18-3103</td> <td>Impeller Plate</td> <td>303069</td> <td>1</td> </tr> </tbody> </table>	Part #	Desc.	O.E. #	Qty.	18-3002	Impeller	375638	1	18-3103	Impeller Plate	303069	1	 <p>18-3210 IMPELLER REPAIR KIT</p> <p>— CONTAINS —</p> <table border="1"> <thead> <tr> <th>Part #</th> <th>Desc.</th> <th>O.E. #</th> <th>Qty.</th> </tr> </thead> <tbody> <tr> <td>18-3043</td> <td>Impeller</td> <td>389642</td> <td>1</td> </tr> <tr> <td>18-2536</td> <td>Rubber Seal</td> <td>321120</td> <td>1</td> </tr> <tr> <td>18-2557</td> <td>Impeller Gasket</td> <td>324701, 338484</td> <td>1</td> </tr> <tr> <td>18-7158</td> <td>O-Ring</td> <td>310967, 310585</td> <td>1</td> </tr> </tbody> </table>	Part #	Desc.	O.E. #	Qty.	18-3043	Impeller	389642	1	18-2536	Rubber Seal	321120	1	18-2557	Impeller Gasket	324701, 338484	1	18-7158	O-Ring	310967, 310585	1
Part #	Desc.	O.E. #	Qty.																														
18-3002	Impeller	375638	1																														
18-3103	Impeller Plate	303069	1																														
Part #	Desc.	O.E. #	Qty.																														
18-3043	Impeller	389642	1																														
18-2536	Rubber Seal	321120	1																														
18-2557	Impeller Gasket	324701, 338484	1																														
18-7158	O-Ring	310967, 310585	1																														

APPLICATION BEGINS ON PAGE 303

Ⓢ This product is priced per piece. To order priced per package, please add -9 to the part number.

©18-3211D



**18-3211
IMPELLER REPAIR KIT**

— CONTAINS —

Part #	Desc.	O.E. #	Qty.
18-3059	Impeller	395864, 397131, 435821	1
18-2536	Rubber Seal	321120	1
18-2557	Impeller Gasket	324701, 338484	1
18-3299	Impeller Key	331107	1
18-7158	O-Ring	310967, 310585	1
18-3138	Impeller Key	334897	1



**18-3453
WATER PUMP KIT**

With Housing

Replaces: 5006511
For: E-Tec 40/50/60 HP All



**18-3454
WATER PUMP KIT**

With Housing

Replaces: 438592
For: 40, 50, 25 Jet, 30 Jet 1995-Up
Includes impeller 18-3104-1



**18-3325
WATER PUMP KIT**

Replaces: 387326

— CONTAINS —

Part #	Desc.	O.E. #	Qty.
18-7134	O-Ring	339543	1
18-3108	Flywheel Key	308928	1
18-3337	Grommet	315837	1
18-3083	Impeller	377230	1
18-3343	Impeller Plate	320981	1
18-2705	Grommet	315748	1



**18-3327
WATER PUMP KIT**

With Housing

Replaces: 394711, 386697, 391698, 389112, 387610

— CONTAINS —

Part #	Desc.	O.E. #	Qty.
18-3050	Impeller	386084	1
18-3180	Housing	435390	1
18-3178	Wear Plate	318995	1
18-3179	Water Pump Cup	324097	1
18-3329	Grommet	302497	1
18-2392	Grommet	327035	1
18-2025	Oil Seal	318972	1
18-7116	O-Ring	303007	1
18-7139	O-Ring	318085	1
18-3326	Pin	300771	1
18-3369	Stainless Steel Bolt	319126	4



**18-3376
WATER PUMP KIT**

Without Housing

Replaces: 384956

— CONTAINS —

Part #	Desc.	O.E. #	Qty.
18-3083	Impeller	377230	1
18-3343	Impeller Plate	320981	1
18-3108	Flywheel Key	308928	1
18-3337	Grommet	315837	1
18-7134	O-Ring	339543	1
18-2705	Grommet	315748	1
18-3136	Screw (Long)	324430	2
18-3369	Stainless Steel Bolt	319126	2



**18-3377
WATER PUMP KIT**

Without Housing

Replaces: 382468

— CONTAINS —

Part #	Desc.	O.E. #	Qty.
18-3002	Impeller	375638	1
18-3103	Impeller Plate	303069	1
18-3329	Water Tube Grommet	302497	1
18-3326	Pin	300771	1

APPLICATION BEGINS ON PAGE 303

① Items ending in "D" are Display Packaged - Regular number is Non-Display



**18-3378
WATER PUMP KIT**

With Housing
Replaces: 391635, 439077

— CONTAINS —

Part #	Desc.	O.E. #	Qty.
18-3055	Impeller	389589	1
18-3343	Impeller Plate	320981	1
18-3336	Housing	384087	1
18-2709	Wear Plate Gasket	336530	1
18-3365	Stainless Steel Bolt	909533	2
18-3369	Stainless Steel Bolt	319126	2
18-2705	Seal	315748	1
18-3337	Water Tube Grommet	315837	1
18-7134	O-Ring	303059	1



**18-3379
WATER PUMP KIT**

Without Housing
Replaces: 390381

— CONTAINS —

Part #	Desc.	O.E. #	Qty.
18-3366	Impeller	390286	1
18-3352	Impeller Plate	325398	1
18-3354	Water Pump Gasket	325399	2
18-3332	Grommet	304056	1



**18-3380
WATER PUMP KIT**

Without Housing
Replaces: 390770

— CONTAINS —

Part #	Desc.	O.E. #	Qty.
18-3055	Impeller	389589	1
18-3343	Impeller Plate	320981	1
18-2709	Wear Plate Gasket	336530	1
18-3365	Stainless Steel Bolt	909533	2
18-3136	Stainless Steel Bolt	319126	2
18-2705	Seal	315748	1
18-3337	Water Tube Grommet	315837	1
18-7134	O-Ring	303059	1



**18-3381
WATER PUMP KIT**

Without Housing
Replaces: 393509

— CONTAINS —

Part #	Desc.	O.E. #	Qty.
18-3051	Impeller	395289	1
NSS	Impeller Plate	328755	1
18-0124	Impeller Plate Gasket	325537	1
18-3358	Water Pump Cup	328751	1
18-2539	Rubber Seal	328753	1
18-3329	Grommet	302497	1
18-7100	O-Ring	301877	1
18-7105	O-Ring	311338	2
18-7146	O-Ring	554545	1
18-3133	Stainless Steel Bolt	331979	6



**18-3382
WATER PUMP KIT**

With Housing
Replaces: 393630

— CONTAINS —

Part #	Desc.	O.E. #	Qty.
18-3051	Impeller	395289	1
NSS	Impeller Plate	328755	1
18-3367	Housing	393632	1
18-3358	Water Pump Cup	328751	1
18-0124	Impeller Plate Gasket	325537	1
18-3329	Grommet	302497	1
18-7100	O-Ring	301877	1
18-7105	O-Ring	311338	2
18-7146	O-Ring	554545	1
18-3133	Stainless Steel Bolt	331979	6



**18-3383
WATER PUMP KIT**

With Housing
Replaces: 395270

— CONTAINS —

Part #	Desc.	O.E. #	Qty.
18-3051	Impeller	395289	1
18-3363	Housing	390560	1
18-3358	Water Pump Cup	328751	1
18-3360	Impeller Housing Gasket	329390	1
18-3329	Grommet	302497	1
18-3133	Stainless Steel Bolt	331979	4



18-3384
WATER PUMP KIT

Without Housing
Replaces: 386124

— CONTAINS —

Part #	Desc.	O.E.#	Qty.
18-7158	O-Ring	310585	1
18-3108	Flywheel Key	308928	1
18-3043	Impeller	389642	1
18-3182	Impeller Plate	317841	1
18-2026	Oil Seal	321453	1
18-3135	Screw	306643	2
18-3136	Screw	323626	4
18-2389	Grommet	314832	2



18-3385
WATER PUMP KIT

Without Housing
Replaces: 396932

— CONTAINS —

Part #	Desc.	O.E.#	Qty.
18-3368	Impeller	396809	1
18-3343	Impeller Plate	320981	1
18-2705	Seal	315748	1
18-7481	Rubber Seal	324981	1
18-7134	O-Ring	303059	1
18-3337	Water Tube Grommet	315837	1
18-3365	Stainless Steel Bolt	909533	2
18-3369	Stainless Steel Bolt	319126	2



18-3387
WATER PUMP KIT

Without Housing
Replaces: 432956

— CONTAINS —

Part #	Desc.	O.E.#	Qty.
18-2703	Grommet	314008	1
18-3053-1	Impeller	396725	1
18-2705	Seal	315748	1
18-3133	SS Bolt	331979	4
18-7174	O-Ring	326649	1
18-7481	O-Ring	324981	1
18-2709	Wear Plate Gasket	336530	1
18-3126	Wear Plate	321940	1
18-3127	Impeller Plate	319275	1
18-3138	Impeller Key	334897	1
18-3299	Flywheel Key	331107	1
18-3153	Stainless Steel Bolt	908158	1



18-3388
WATER PUMP KIT

Without Housing
Replaces: 386533, 389143

— CONTAINS —

Part #	Desc.	O.E.#	Qty.
18-0969	Impeller Housing Gasket	319586	1
18-3108	Stainless Steel Key	323950	1
18-2703	Grommet	314008	1
18-3127	Impeller Plate	319275	1
18-2705	Seal	315748	1
18-3082	Impeller	382547	1
18-3153	Stainless Steel Bolt	334597	1
18-2709	Wear Plate Gasket	336530	1
18-3133	Stainless Steel Bolt	331979	4
18-3126	Wear Plate	321940	1



18-3389
WATER PUMP KIT

With Housing
Replaces: 436957, 0438591, 0432955

— CONTAINS —

Part #	Desc.	O.E.#	Qty.
18-7481	O-Ring	324981	1
18-2703	Grommet	314008	1
18-3053-1	Impeller	396725	1
18-3127	Impeller Plate	319275	1
18-2705	Seal	315748	1
18-3133	Stainless Steel Bolt	908158	1
18-3299	Flywheel Key	331107	1
18-7174	O-Ring	326649	1
18-2709	Wear Plate Gasket	336530	1
18-3129	Housing	435673	1
18-3138	Impeller Key	334897	1
18-3126	Wear Plate	321940	1



18-3390
WATER PUMP KIT

Without Housing
Replaces: 395060, 0435447, 0434421, 5001594

— CONTAINS —

Part #	Desc.	O.E.#	Qty.
18-3059	Impeller	397131, 435821	1
18-2557	Impeller Gasket	324701, 338484	1
18-3299	Impeller Key	331107	1
18-7158	O-Ring	310987, 310585	1
18-3135	Stainless Steel Screw	306643	2
18-2703	Grommet	314008	1
18-2704	Grommet	320943	1
18-2706	Grommet	321008	1
18-3136	Stainless Steel Bolt	323626	4
18-2769	Rubber Seal	332000	1
18-3133	Stainless Steel Bolt	331979	4
18-3346	Cup Plate Assy.	435027	1
18-3138	Impeller Key	334897	1



18-3391
WATER PUMP KIT
With Housing
Replaces: 395072

— CONTAINS —

Part #	Desc.	O.E. #	Qty.
18-3346	Cup & Plate Assy.	435027	1
18-2769	O-Ring	332000	1
18-2557	Impeller Plate Gasket	338484, 324701	1
18-2704	Grommet	320943	1
18-3136	Stainless Steel Bolt	323626	4
18-3299	Flywheel Key	331107	1
18-3153	Stainless Steel Bolt	908158	1



18-3392
WATER PUMP KIT
With Housing
Replaces: 434421, 5001594

— CONTAINS —

Part #	Desc.	O.E. #	Qty.
18-3059	Impeller	395864, 397131, 435821	1
18-3346	Cup & Plate Assy.	435027	1
18-3299	Impeller Key	331107	1
18-7158	O-Ring	310967, 310585	1
18-3135	Stainless Steel Screw	306643	2
18-2703	Grommet	314008	1
18-2704	Grommet	320943	1
18-2706	Grommet	321008	1
18-3136	Stainless Steel Bolt	323626	4
18-2769	Rubber Seal	332000	1
18-2557	Impeller Gasket	324701, 338484	1
18-3133	Stainless Steel Bolt	331979	4



18-3393
WATER PUMP KIT
With Housing
Replaces: 395073, 388644

— CONTAINS —

Part #	Desc.	O.E. #	Qty.
18-3043	Impeller	389642	1
18-2557	Impeller Gasket	324701, 338484	1
18-3346	Cup & Plate Assy.	435027	1
18-3108	Water Pump Key	323950	1
18-0110	Shift Housing Gasket	324670	1
18-7158	O-Ring	310967, 310585	1
18-3135	Stainless Steel Screw	306643	2
18-2703	Grommet	314008	1
18-2704	Grommet	320943	1
18-2706	Grommet	321008	1
18-3136	Stainless Steel Bolt	323626	4
18-2769	O-Ring	332000	1
18-7143	O-Ring	322501	1
18-3133	Stainless Steel Bolt	331979	4



18-3394
WATER PUMP KIT
Without Housing
Replaces: 433548, 0433549, 0438592

— CONTAINS —

Part #	Desc.	O.E. #	Qty.
18-7481	O-Ring	324981	1
18-2708	Grommet	333758	1
18-2709	Wear Plate Gasket	336530	1
18-3104-1	Impeller	432941	1
18-3138	Impeller Key	334897	1
18-2705	Seal	315748	1
18-3133	Stainless Steel Bolt	331979	4
18-3126	Wear Plate	321940	1



18-3399
WATER PUMP KIT
With Housing
Replaces: 396933, 0439077

— CONTAINS —

Part #	Desc.	O.E. #	Qty.
18-7134	O-Ring	303059	1
18-3337	Grommet	315837	1
18-3368	Impeller	396809	1
18-2709	Wear Plate Gasket	336530	1
18-3369	Screw (Short)	319126	2
18-2705	Seal	315748	1
18-3336	Housing	384087	1
18-3365	Screw (Long)	909533	2
18-3343	Wear Plate	320981	1



18-3400
WATER PUMP KIT
Without Housing
Replaces: 391698, 0394711

— CONTAINS —

Part #	Desc.	O.E. #	Qty.
18-3050	Impeller	386084	1
18-3178	Impeller Plate	318995	1
18-3179	Water Pump Cup	324097	1
18-3329	Grommet	302497	1
18-2392	Grommet	327035	1
18-2025	Oil Seal	318972	1
18-7116	O-Ring	303097	1
18-3369	Screw	319126	4
18-3326	Pin	300771	1
18-7139	O-Ring	319085	1



18-3401
WATER PUMP KIT

Without Housing

Replaces: 395271, 394394, 0395270

— CONTAINS —

Part #	Desc.	O.E. #	Qty.
18-3051	Impeller	395289	1
18-3360	Gasket	329398	1
18-3358	Cup	328773	1
18-7440-1	O-Ring	301967	2
18-2013	Oil Seal	321786	1
18-3329	Grommet	302497	1
18-0108	Gasket	324449	1
18-3133	Stainless Steel Bolt	331979	4



18-3402
WATER PUMP KIT

Without Housing

Replaces: 382296

— CONTAINS —

Part #	Desc.	O.E. #	Qty.
NSS	Impeller	377178	1
18-3102	Impeller Plate	305303	1
18-2891	Gasket	303339	1
18-3328	Pin	300771	1
18-3329	Grommet	302497	1
18-2023	Oil Seal	313282	1



18-3403
WATER PUMP KIT

Without Housing

Replaces: 388644

— CONTAINS —

Part #	Desc.	O.E. #	Qty.
18-7158	O-Ring	310585	1
18-3108	Key	308928	1
18-2703	Grommet	314008	1
18-3135	Screw	308643	4
18-2026	Seal	321453	1
18-3136	Housing Screw	323626	1
18-3043	Impeller	389642	1
18-3346	Cup & Plate Assembly	435027	1
18-2536	Gasket	321120	1
18-2704	Grommet	320943	1



18-3315-2
WATER PUMP KIT

With Housing

Replaces: 435929, 5001595

For: 90/115SL (1995-UP), 120/125ESX (1993-94), 120/130/140/150/175/V-6/V-8(1993-UP)

— CONTAINS —

Part #	Desc.	O.E. #	Qty.
18-2557	Gasket	324701	1
18-3405	Housing, WP	435485	1



18-4537
WATER PUMP KIT

Without Housing

Replaces: 5008972

Fits: 15 (AA-AF), 25 (AA-AF), 30 (AA-AF)

— CONTAINS —

Part #	Desc.	O.E. #	Qty.
18-0124	Gasket	325537	1
NSS	Plate	328755	1
18-2539	Seal	328753	1
18-3295	Key	344470	1
18-4539	Impeller	5008967	1
18-5701	Spring, Pressure Relief	355169	1
18-5703	Spring, Thermostat	355209	1
18-3358	Cup	328751	1
18-7146	O-Ring	554545	1
18-1595	Screw M6X25	353590	6
18-3367	Housing, Impeller	393632	1
18-2147	Bushing	328754	1
18-3329	Grommet	302497	1
18-7100	O-Ring	301877	1
18-1823	Seal and Pin Assembly	5007770	1



18-3472
WATER PUMP KIT

Without Housing

Replaces: 5007972

Fits: 200-300HP (2009 & Up)

— CONTAINS —

Part #	Desc.	O.E. #	Qty.
18-2557	Gasket, Water Pump	338484	1
18-4579	Plate, Outer Wear	338485	1
18-7963	Seal, Impeller Plate	331353	1
18-3059	Impeller	5001593	1
18-71336	O-Ring, Impeller to Plate	302035	1
18-3299	Key, Impeller	331107	1
18-4549	Cup, Insert	338486	1
18-7143	O-Ring, Cup to Housing	331188	1
18-4571	Housing, Impeller	360347	1
18-71338	O-Ring, Water Tube	346865	4
18-9084	Cover, Impeller Housing	354578	1
18-1597	Screw, Housing	302325	4
18-3135	Screw, Cover to Housing	306643	2
18-2704	Grommet, Pump to Exhaust Housing	320943	1
18-1824	Grommet, Sleeve, 20" Models	349354	1
18-1826	Grommet, Sleeve, 25" and 30"	338601	1
18-1822	Sleeve, Extension 25" Models	354580	1

APPLICATION BEGINS ON NEXT PAGE

③ This product is priced per piece. To order priced per package, please add -9 to the part number.



18-3476
WATER PUMP KIT
Without Housing
Replaces: 5007556
Fits: 90 (2013 & Up), 115/130 (2009 & Up)

-- CONTAINS --

Part #	Desc.	O.E. #	Qty.
18-2557	Gasket, Plate	338484	1
18-4579	Plate, Outer Wear	338485	1
18-7963	Seal, Housing Plate	331353	1
18-3059	Impeller	5001593	1
18-71336	O-ring, Impeller to Plate	302035	1
18-3299	Key, Impeller	331107	1
18-4549	Cup, Insert	338486	1
18-7143	O-Ring, Cup to Housing	331188	1
18-4568	Housing, Impeller	5007554	1
18-1597	Screw, Housing	302325	4
18-1821	Grommet, Pump to Exhaust Housing	353690	1



18-3491
WATER PUMP KIT
Without Housing
Replaces: 437907
Fits: 25/35 (1996-01)

-- CONTAINS --

Part #	Desc.	O.E. #	Qty.
18-7100	O-Ring	301877	1
18-0124	Gasket	325537	1
18-1596	Screw	328725	6
18-3358	Cup, Impeller	328751	1
18-2539	Seal	328753	1
18-2147	Bushing, Shift Rod	328754	1
NSS	Plate, Impeller	328755	1
18-4569	Housing, Impeller	339720	1
18-1825	Grommet	340811	1
18-71340	Seal	342370	1
18-3051	Impeller w/ Key	395289	1
18-7146	O-Ring	554545	1



18-4529
WATER PUMP KIT
Without Housing
Replaces: 396644
Fits: 4HP (1986-92), 5HP (1980-83, 1996-01), 6HP (1984-01, 2003-05), 8HP (1980-01, 2003-05)

-- CONTAINS --

Part #	Desc.	O.E. #	Qty.
18-3026	Drive Key	331130	1
18-1827	Grommet	321129	1
18-3329	Grommet	302497	1
18-4277	Screws	324430	4
18-4578	Impeller Hsg Plate	324640	1
18-4551	Impeller Hsg Cup	324641	1
18-99156	Impeller Hsg Gasket	325040	2
18-3091	Impeller Assembly	389576	1
18-7413	O-Ring	903191	1



STAINLESS STEEL BOLTS

Part No.	O.E. #	Size
18-3133	330619, 344470	1/4 x 20 x 11/16"
18-3135 ①③	306643	1/8 x 20 x 1/2"
18-3136 ①③	323626	1/4 x 20 x 13/4"
18-3153	908158	1/4 x 20 x 1/2"
18-3365	909533	1/4 x 20 x 1"
18-3369	319126	1/4 x 20 x 1"
18-4276 ②③	324334	1/4 x 20 x 1-1/32"
18-4277 ②③	324430	1/4 x 20 x 2"

① Std. Pkg of 2 ② Std. Pkg of 5

JOHNSON/VEINRUDE WATER PUMP KIT APPLICATION

HP	Year	Impeller	Impeller Plate	Plate & Cup	Cup	Repair Kit	Pump Kit w/o Hsg.	Pump Kit w/Hsg.	Housing Kit
2 Jr, Colt	1985-90	18-3090	—	—	—	—	—	—	—
2.5	1987-06	18-3015	—	—	—	—	—	—	—
3	1952-78	18-3001	—	—	—	18-3201	—	—	—
3.5	1987-06	18-3015	—	—	—	—	—	—	—
4	1969-72	18-3001	—	—	—	18-3201	—	—	—
4 ⑦	1973-83	18-3001	—	—	—	18-3201	—	—	—
4 ④	1976-80	18-3090	—	—	—	—	—	—	—
4	1986-92	18-3091	18-4578	—	18-4551	—	18-4529	—	—
4 Deluxe	1980-97	18-3091	—	—	—	—	—	—	—
4 Ultra Excel	1987-06	18-3015	—	—	—	—	—	—	—
4.5	1980-97	18-3091	—	—	—	—	—	—	—
5	1965-68	18-3001	—	—	—	—	—	—	—
5	1980-01	18-3091	18-4578	—	18-4551	—	18-4529	—	—
5 (4-Stroke)	1998-Up	18-3091	—	—	—	—	—	—	—
5.5	1954-64	18-3001	18-3102	—	—	18-3202	—	—	—
6	1952-78	18-3001	18-3102	—	—	18-3202	—	—	—

① Except chrome pumps

② Except SL models 1995 & Up/FFI models

③ "S" Suffix

④ "F" Suffix

⑤ Except 1993-94 25" & 30" V6 & V8

⑦ For water pumps using 1 water tube

⑧ 90 degree gearcase

JOHNSON/EVINRUDE WATER PUMP KIT APPLICATION (CONT.)

HP	Year	Impeller	Impeller Plate	Plate & Cup	Cup	Repair Kit	Pump Kit w/o Hsg.	Pump Kit w/Hsg.	Housing Kit
6	1979	18-3090	—	—	—	—	—	—	—
6	1984-05	18-3091	18-4578	—	18-4551	—	18-4529	—	—
6 (4-Stroke)	1998-Up	18-3091	—	—	—	—	—	—	—
7.5	1954-58	18-3001	18-3102	—	—	18-3202	—	—	—
8	1980-05	18-3091	18-4578	—	18-4551	—	18-4529	—	—
8 (2-Stroke)	1986-97	18-3091	—	—	—	—	—	—	—
9.5	1964-73	—	18-3102	—	—	—	18-3402	—	—
10	1958-63	—	18-3102	—	—	—	18-3402	—	—
10	1949-57	18-3002	18-3103	—	—	18-3203	18-3377	—	—
9.9/15	1974-Up	18-3050	18-3178	—	18-3179	—	18-3400	18-3327	18-3180
9.9/15 (4-Stroke)	1995-Up	18-3050	18-3178	—	18-3179	—	18-3400	18-3327	18-3180
15,18	1953-65	18-3002	—	—	—	18-3203	18-3377	—	—
15	2011 & Up	18-4539	—	—	18-3358	—	—	18-4537	—
15	AA-AF	18-4539	—	—	18-3358	—	—	18-4537	—
20	1966-73	18-3002	—	—	—	18-3203	18-3377	—	—
20	1982-84	18-3051	—	—	18-3358	—	18-3401	18-3383	18-3363
20	1985-Up	18-3051	—	—	18-3358	—	18-3381	18-3382	18-3367
25	1951-55	18-3006	—	—	—	—	—	—	—
25	1969-78	18-3002	18-3103	—	—	18-3203	18-3377	—	—
25	1979-84	18-3051	—	—	18-3358	—	18-3401	18-3383	18-3363
25	1985-Up	18-3051	—	—	18-3358	—	18-3381	18-3382	18-3367
25	1996-01	18-3051	—	—	18-3358	—	18-3491	—	18-4569
25	2011 & Up	18-4539	—	—	18-3358	—	—	18-4537	—
25	AA-AF	18-4539	—	—	18-3358	—	—	18-4537	—
28	1962-64	18-3006	—	—	—	—	—	—	—
28	1978-Up	18-3051	—	—	18-3358	—	18-3401	18-3383	18-3363
30	1951-57	18-3006	—	—	—	—	—	—	—
30	1984-Up	18-3051	—	—	18-3358	—	18-3381	18-3382	18-3367
30	2011 & Up	18-4539	—	—	18-3358	—	—	18-4537	—
30	AA-AF	18-4539	—	—	18-3358	—	—	18-4537	—
33	1962-71	18-3006	—	—	—	—	—	—	—
35	1951-57	18-3006	—	—	—	—	—	—	—
35	1958-59	18-3083	—	—	—	—	—	—	—
35	1976-77	18-3006	—	—	—	—	—	—	—
35	1978-79	18-3051	—	—	—	—	—	—	—
35	1980-82	18-3051	N/A	—	18-3358	—	—	18-3382	18-3367
35	1983-Up	18-3051	—	—	18-3358	—	—	—	—
35	1996-01	18-3051	—	—	18-3358	—	18-3491	—	18-4569
35 Jet	1992-93	18-3104-1	—	—	—	—	18-3394	—	—
40	1960-70	18-3083	—	—	—	—	—	—	—
40	1971-73	18-3006	—	—	—	—	—	—	—
40 Comm.	1981-90	18-3366	18-3352	—	—	—	18-3379	—	—
40	1984-85	18-3055	18-3343	—	—	—	18-3380	18-3378	18-3336
40	1986-88	18-3368	18-3343	—	—	—	18-3385	18-3399	18-3336
40	1989-98	18-3104-1	—	—	—	—	18-3394	—	—
40	1999-Up	18-3053-1	—	—	—	—	18-3394	—	—
45/55 Comm.	1985	18-3055	—	—	—	—	18-3380	—	18-3336
45/55	1989	18-3368	18-3343	—	—	—	18-3385	18-3399	18-3336
45/55 Comm.	1986-88,	18-3368	—	—	—	—	18-3385	18-3399	18-3336
48	1987-88	18-3368	18-3343	—	—	—	18-3385	18-3399	18-3336
48	1989-96	18-3104-1	18-3127	—	—	—	18-3394	—	—
50	1971-78	18-3083	18-3343	—	—	—	18-3376	—	—

① Except chrome pumps
 ② Except SL models 1995 & Up/FFI models

③ "S" Suffix
 ④ "F" Suffix

⑤ Except 1993-94 25" & 30" V6 & V8
 ⑥ For water pumps using 1 water tube

⑦ 90 degree gearcase

JOHNSON/VEINRUDE WATER PUMP KIT APPLICATION

HP	Year	Impeller	Impeller Plate	Plate & Cup	Cup	Repair Kit	Pump Kit w/o Hsg.	Pump Kit w/Hsg.	Housing Kit
50	1979-85	18-3055	18-3343	—	—	—	18-3380	18-3378	18-3336
50	1986-88	18-3368	18-3343	—	—	—	18-3385	18-3399	18-3336
50	1989-98	18-3104-1	—	—	—	—	18-3394	—	—
55	1968-69	18-3082	—	—	—	—	—	—	—
55	1976-78	18-3083	—	—	—	—	—	—	18-3336
55	1979-85	18-3055	18-3343	—	—	—	18-3380	18-3378	18-3336
60	1964-67	—	—	—	—	—	—	—	—
60	1970-71	18-3082	—	—	—	—	—	—	—
60	1980-85	18-3055	—	—	—	—	18-3360	18-3378	18-3336
60	1986-94	18-3053-1	18-3127	—	—	—	18-3387	18-3389	—
60	1995-Up	18-3053-1	18-3127	—	—	—	18-3387	—	—
65	1968	—	—	—	—	—	—	—	—
65	1972-73	18-3082	—	—	—	—	—	—	—
65 Comm.	1984-94	18-3053-1	18-3127	—	—	—	18-3387	18-3389	—
65 Comm.	1995-Up	18-3053-1	18-3127	—	—	—	18-3387	—	—
70	1974-78	18-3082	18-3127	—	—	—	18-3388	—	—
70	1979-94	18-3053-1	18-3127	—	—	—	18-3387	18-3389	—
70	1995-Up	18-3053-1	18-3127	—	—	—	18-3387	—	—
75	1960-65	—	—	—	—	—	—	—	—
75	1974-78	18-3082	18-3127	—	—	—	18-3388	—	—
75	1979-88	18-3053-1	18-3127	—	—	—	18-3387	18-3389	18-3129
80	1966-67	—	—	—	—	—	—	—	—
85	1968	—	—	—	—	—	—	—	—
85	1969-72	18-3044	18-3182	—	—	—	—	—	—
85	1973-77	18-3043	18-3182	—	—	—	18-3384	—	—
85	1978	18-3043	—	18-3346	—	—	—	18-3393⑦	18-3391
85	1979-95	18-3059	—	18-3346	—	18-3211	18-3390	18-3392	18-3391
90	1964-68	—	—	—	—	—	—	—	—
90	1979-Up	18-3059	—	18-3346	—	18-3211	18-3390	18-3392②	18-3391
90	2013 & Up	18-3059	18-4579	—	18-4549	—	18-3476	—	18-4568
90 SL/DL	1995 & UP	18-3059	—	18-3346	—	18-3211	18-3390	18-3315-2	18-3405
100	1969-72	18-3044	—	—	—	—	—	—	—
100	1979-Up	18-3059	—	18-3346	—	18-3211	18-3390	18-3392	18-3391
100 Comm. ①	1984-Up	18-3059	—	18-3346	—	18-3211	18-3390	18-3392	18-3391
105 Comm.	1998-2001	18-3059	—	18-3346	—	18-3211	18-3390	18-3315-2	18-3405
115	1969-70	18-3044	—	—	—	—	—	—	—
115	1973-76	18-3043	—	—	—	—	18-3384	—	—
115	1977-78	18-3043	—	18-3346	—	—	—	18-3393⑦	18-3391
115	1979-Up	18-3059	—	18-3346	—	18-3211	18-3390	18-3392②	18-3391
115	2013 & Up	18-3059	18-4579	—	18-4549	—	18-3476	—	18-4568
115 SL/DL	1995 & UP	18-3059	—	18-3346	—	18-3211	18-3390	18-3315-2	18-3405
120 25" ④	1993-2000	18-3059	—	18-3346	—	18-3211	18-3390	18-3315-2	18-3405
125	1971-72	18-3044	—	—	—	—	—	—	—
125 ESX 25" ③	1993-94	18-3059	—	18-3346	—	18-3211	18-3390	18-3392	18-3391
125 ESX 25"	1994-95	18-3059	—	18-3346	—	18-3211	18-3390	18-3392	18-3391
125 ESX 25" ⑥	1993-94	18-3059	—	18-3346	—	18-3211	18-3390	—	—
130	1987 & UP	18-3059	—	18-3346	—	18-3211	18-3390	18-3315-2	18-3405
130	2013 & Up	18-3059	18-4579	—	18-4549	—	18-3476	—	18-4568
130 25"	1984-2000	18-3059	—	18-3346	—	18-3211	18-3390	18-3315-1	18-3405
135	1973-75	18-3043	18-3182	—	—	—	18-3210	18-3384	—
135	1976	18-3043	18-3182	—	—	—	—	—	—
135 25"	2001	18-3059	—	18-3346	—	18-3211	18-3390	18-3315-2	18-3405

① Except chrome pumps

② Except SL models 1995 & Up/FFI models

③ "S" Suffix

④ "F" Suffix

⑤ Except 1993-94 25" & 30" V6 & V8

⑥ For water pumps using 1 water tube

⑦ 90 degree gearcase

JOHNSON/EVINRUDE WATER PUMP KIT APPLICATION (CONT.)

HP	Year	Impeller	Impeller Plate	Plate & Cup	Cup	Repair Kit	Pump Kit w/o Hsg.	Pump Kit w/Hsg.	Housing Kit
140	1977-78	18-3043	—	18-3346	—	—	—	18-3393⑦	18-3391
140	1979-Up	18-3059	—	18-3346	—	18-3211	18-3390	18-3392	18-3391
140 25" ①	1993	18-3059	—	18-3346	—	18-3211	18-3390	18-3315-2	18-3405
140 25"	1994-2000	18-3059	—	18-3346	—	18-3211	18-3390	18-3315-2	18-3405
150	1976-78	18-3043	—	18-3346	—	18-3210	—	18-3393⑦	18-3391
150	1979-Up	18-3059	—	18-3346	—	18-3211	18-3390	18-3392	18-3391
150 20"	1993 & UP	18-3059	—	18-3346	—	18-3211	18-3390	18-3392	18-3391
150 SL 20"	1994-98	18-3059	—	18-3346	—	18-3211	18-3390	18-3315-2	18-3405
150 EL 20"	1996-98	18-3059	—	18-3346	—	18-3211	18-3390	18-3315-2	18-3405
150 25"	1993 & UP	18-3059	—	18-3346	—	18-3211	18-3390	18-3315-2	18-3405
150 DI	1997 & UP	18-3059	—	18-3346	—	18-3211	18-3390	18-3315-2	18-3405
150	2000 & UP	18-3059	—	18-3346	—	18-3211	18-3390	18-3315-2	18-3405
175	1976-78	18-3043	—	18-3346	—	18-3210	—	18-3393⑦	18-3391
175 SL 20"	1994-98	18-3059	—	18-3346	—	18-3211	18-3390	18-3315-2	18-3405
175 EL 20"	1996-98	18-3059	—	18-3346	—	18-3211	18-3390	18-3315-2	18-3405
175 25"	1993 & UP	18-3059	—	18-3346	—	18-3211	18-3390	18-3315-2	18-3405
175 DI	1997 & UP	18-3059	—	18-3346	—	18-3211	18-3390	18-3315-2	18-3405
175	2000 & UP	18-3059	—	18-3346	—	18-3211	18-3390	18-3315-2	18-3405
200	1976-78	18-3043	—	18-3346	—	—	—	18-3393⑦	18-3391
200	2009 & Up	18-3059	18-4579	—	18-4549	—	18-3472	—	18-4571
200 Comm.	1990	18-3059	—	18-3346	—	18-3211	18-3390	18-3392	18-3391
200 25" & 30"	1993-97	18-3059	—	18-3346	—	18-3211	18-3390	18-3315-2	18-3405
225	2009 & Up	18-3059	18-4579	—	18-4549	—	18-3472	—	18-4571
225 20"	1993 & UP	18-3059	—	18-3346	—	18-3211	18-3390	18-3392	18-3391
225 25" & 30"	1993-97	18-3059	—	18-3346	—	18-3211	18-3390	18-3315-2	18-3405
235	1978	18-3043	—	18-3346	—	—	—	18-3393⑦	18-3391
235	1979-Up	18-3059	—	18-3346	—	18-3211	18-3390	18-3392	18-3391
250	2009 & Up	18-3059	18-4579	—	18-4549	—	18-3472	—	18-4571
275	2009 & Up	18-3059	18-4579	—	18-4549	—	18-3472	—	18-4571
300	2009 & Up	18-3059	18-4579	—	18-4549	—	18-3472	—	18-4571
V4 Cross 20" & 25"	1993 & UP	18-3059	—	18-3346	—	18-3211	18-3390	18-3392	18-3391
V4 Loop 20"	1993 & UP	18-3059	—	18-3346	—	18-3211	18-3390	18-3392	18-3391
V4,V6,V8 ②	1982-94	18-3059	—	18-3346	—	18-3211	18-3390	18-3392	18-3391
V6,V8 20"	1993 & UP	18-3059	—	18-3346	—	18-3211	18-3390	18-3392	18-3391
V6 & V8 25" & 30"	1993 & UP	18-3059	—	18-3346	—	18-3211	18-3390	18-3315-2	18-3405
Sea Drives	1979-Up	18-3059	—	18-3346	—	18-3211	18-3390	18-3392⑧	18-3391

① Except chrome pumps

② Except SL models 1995 & Up/FFI models

③ "S" Suffix

④ "F" Suffix

⑤ Except 1993-94 25" & 30" V6 & V8

⑦ For water pumps using 1 water tube

⑧ 90 degree gearcase

18-3563
POPPET
RELIEF VALVE
V-6 Crossflow
Replaces: 321027



18-3564
POPPET
RELIEF VALVE
V-4 Crossflow
Replaces: 318395



18-1219
GROMMET
V-6 Crossflow
Replaces: 320880



PKG. OF 2

18-1221
18-1221-9①
RETAINER GASKET
V-4 / V-6 Loop Charge
Replaces: 330273



18-3562
VALVE CUP
V-6 Crossflow
Replaces: 321222



18-1243
VALVE SPRING
V-4 / V-6 Crossflow
Replaces: 317245



① Priced per Package

 <p>18-1222 THERMOSTAT GASKET V-4 / V-6 Loop Charge Replaces: 394408</p>	 <p>18-3567 RUBBER VALVE V-6 Crossflow Replaces: 321221</p>	 <p>18-3565 RETAINER V-6 Crossflow Replaces: 321220</p>	 <p>18-2391 GROMMET V-4 Crossflow Replaces: 321692</p>												
 <p>18-3500 THERMOSTAT Replaces: 394409, 434137 For: 3 cyl. (1992 & UP), 90° Looper (1990-1992) 140°</p>	 <p>18-3544 THERMOSTAT Replaces: 435491 Fits: E108 (2004-06), E110 (04-06), E115 (2002-06), E75 (2002-03), E90 (2002-03), E150 (1991-94), E175 (1991-94), J165 (2003), J115 (2002-06), J150 (1991-92, 1993-94, 2002-06), J175 (1991-92, 1994, 2002-06), J90 (2004-06)</p>	 <p>18-3545 THERMOSTAT 130° Replaces: 437090 Fits: E115 (1997), E135, E150, E175 (2000-06)</p>	 <p>18-3546 THERMOSTAT 130° Replaces: 5001036 Fits: E200, E225, E250 (2000-05), J200, J225, J250 (2000-01)</p>												
 <p>18-3543 THERMOSTAT 143° Replaces: 393659, 434841, 378065, 508626, 5005440 Fits: 40-250hp E-tech, 6-55hp, Cross V4 & V6, 9.9 4-Stroke (1994-01), 15 4-Stroke (1994-01)</p>	 <p>18-3643 THERMOSTAT Replaces: 433379 Fits: 6-8HP (1990), 9.9/15HP (1990-92), 40/48/50HP (1990-94), 45/55 (1992-94)</p>	 <p>18-3557 THERMOSTAT 143° Replaces: 396987, 382385</p>	 <p>18-3561 THERMOSTAT Replaces: 436195 143°</p>												
 <p>18-1506 VERNATHERM 143° Replaces: 394411 For: 10/15 (1993-95), 60/125/185 (1989-90), 65 (1987-89), 70/200/225 (1986-90), 120/140/300 (1985-90), 275 (1985-88)</p>	 <p>18-3560 VERNATHERM Replaces: 384719 105° Fits most 3 & 4 cyl., 1985-90</p>	<p>① 18-3669D Display Package</p>  <p>18-3669 THERMOSTAT KIT — CONTENTS —</p> <table border="1"> <thead> <tr> <th>Part #</th> <th>Description</th> <th>O.E. #</th> </tr> </thead> <tbody> <tr> <td>18-3567</td> <td>Thermostat</td> <td>396987</td> </tr> <tr> <td>18-2548</td> <td>Thermostat Cover Gasket</td> <td>332108</td> </tr> <tr> <td>18-0929</td> <td>Thermostat Gasket</td> <td>313416</td> </tr> </tbody> </table>	Part #	Description	O.E. #	18-3567	Thermostat	396987	18-2548	Thermostat Cover Gasket	332108	18-0929	Thermostat Gasket	313416	<p>① 18-3673D Display Package</p>  <p>18-3673 THERMOSTAT KIT V-4 Crossflow Uses thermostat 18-3543</p>
Part #	Description	O.E. #													
18-3567	Thermostat	396987													
18-2548	Thermostat Cover Gasket	332108													
18-0929	Thermostat Gasket	313416													
<p>① 18-3674D Display Package</p>  <p>18-3674 THERMOSTAT KIT V-6 Crossflow Uses thermostat 18-3543</p>	 <p>18-3566 TELL TALE HOSE ELBOW Replaces: 331894</p>	 <p>18-1507 THERMOSTAT SEAL Replaces: 335981 For: 60° V-4 & V-6</p>	 <p>18-1734 THERMOSTAT SEAL Replaces: 334742 For: OMC thermostat application 6, 8, 10, 15, 40, 48, 50 HP (1989-94)</p>												

APPLICATION ON NEXT PAGE

① Items ending in "D" are Display Packaged - Regular number is Non-Display

Crossflow V-4 Engine

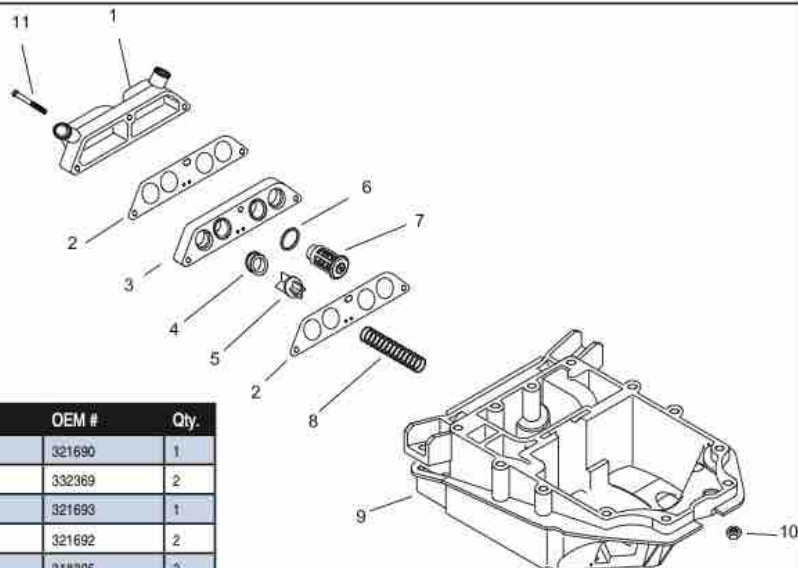

Fig. #	Description	Part #	OEM #	Qty.
1	Cover	-	321690	1
2	Gasket	18-0977	332369	2
3	Valve Body	-	321693	1
4	Grommet	18-2391	321692	2
5	Valve	18-3564	318395	2
6	Thermostat Gasket	18-0675	321932	2
7	Thermostat	18-3543	434841, 393659	2
8	Spring	18-1243	317245	2
9	Adapter	-	331039	1
10	Nut	-	306422	4
11	Screw Cover	-	305652	3

Crossflow V-6 Engine

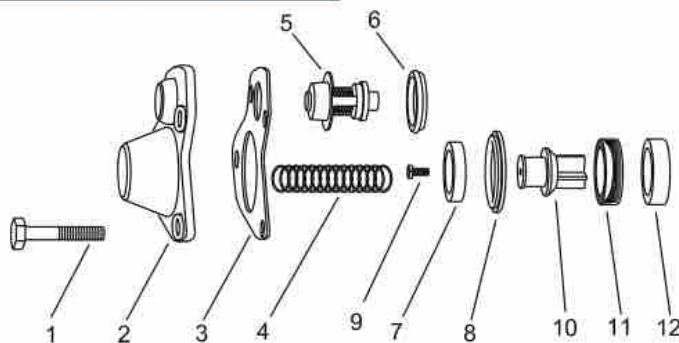

Fig. #	Description	Part #	OEM #	Qty.	Fig. #	Description	Part #	OEM #	Qty.
1	Screw	-	306778	4	7	Retainer	18-3565	321220	1
2	Cover	-	321013	1	8	Seal	18-3567	321221	1
3	Gasket	18-2546	321184	1	9	Stainless Steel Bolt	18-3135	306643	1
4	Spring	18-1243	317245	1	10	Valve	18-3563	321027	1
5	Thermostat	18-3543	393659	1	11	Grommet	18-1219	320880	1
6	Thermostat Gasket	18-0182	310058	1	12	Valve Cap	18-3562	321222	1

JOHNSON/EVINRUDE THERMOSTAT APPLICATION

HP	Years	Thermostat Kit	Thermostat	Valve	Valve Seat	Valve Diaphragm	Valve Retainer	Valve Cup	Valve Spring	Grommet
5	1965-68, 1986	18-3672 ⑩	18-3543	-	-	-	-	-	-	-
5.5	1959-64	18-3672 ⑩	18-3543	-	-	-	-	-	-	-
6	1965-79, 1986	18-3672 ⑩	18-3543	-	-	-	-	-	-	-
6	1990	18-3643	-	-	-	-	-	-	-	-
7.5	1980-86	18-3672 ⑩	18-3543	-	-	-	-	-	-	-
8	1986	18-3672 ⑩	18-3543	-	-	-	-	-	-	-
8	1990	18-3643	-	-	-	-	-	-	-	-
9.5	1964-73	18-3672 ⑩	18-3543	-	-	-	-	-	-	-

⑩ All 1989-91 models except DR & DT
 ⑪ Commercial

⑫ Commercial also
 ⑬ Except 60 degree models

⑭ For complete Thermostat Kit including gaskets & spring use 18-3674

APPLICATION CONTINUED ON NEXT PAGE

JOHNSONEVINRUDE THERMOSTAT APPLICATION

HP	Years	Thermostat Kit	Thermostat	Valve	Valve Seat	Valve Diaphragm	Valve Retainer	Valve Cup	Valve Spring	Grommet
9.9	1974-86	18-3672 ①	18-3543	—	—	—	—	—	—	—
9.9	1990-92	18-3643	—	—	—	—	—	—	—	—
10	1959-63	18-3672 ①	18-3543	—	—	—	—	—	—	—
15	1974-86	18-3672 ⑤	18-3543	—	—	—	—	—	—	—
15	1990-92	18-3643	—	—	—	—	—	—	—	—
18	1959-73	18-3672 ⑤	18-3543	—	—	—	—	—	—	—
20	1961-94	18-3672 ⑤	18-3543	—	—	—	—	—	—	—
25 ①	1969-94	18-3672 ⑤	18-3543	—	—	—	—	—	—	—
28	1989-94	18-3672 ⑤	18-3543	—	—	—	—	—	—	—
30	1986-94	18-3672 ⑤	18-3543	—	—	—	—	—	—	—
35	1959, 1978-94	18-3672 ①	18-3543	—	—	—	—	—	—	—
40	1960-69	18-3672 ①	18-3543	—	—	—	—	—	—	—
40	1990-94	18-3643	—	—	—	—	—	—	—	—
45	1989-92 ②	18-3672 ⑤	18-3543	—	—	—	—	—	—	—
45	1992-94	18-3643	—	—	—	—	—	—	—	—
48	1990-94	18-3643	—	—	—	—	—	—	—	—
50	1971-75, 1979, 1981-86	18-3672 ⑤	18-3543	—	—	—	—	—	—	—
50	1990-94	18-3643	—	—	—	—	—	—	—	—
55	1976-92 ③	18-3672 ①	18-3543	—	—	—	—	—	—	—
55	1992-94	18-3643	—	—	—	—	—	—	—	—
60	1969-70	18-3669 ⑤	18-3557	—	—	—	—	—	—	—
60	1980-86	18-3672 ⑤	18-3543	—	—	—	—	—	—	—
60, 60TTL	1993	—	18-3561	—	—	—	—	—	—	—
65	1971-73	18-3669	18-3557	—	—	—	—	—	—	—
65	1993	—	18-3561	—	—	—	—	—	—	—
65C	1984-86	18-3669	18-3557	—	—	—	—	—	—	—
65 Jet	1994-95	18-3673	18-3543	18-3564	—	—	—	—	18-1243	18-2391
70	1974-86	18-3669	18-3557	—	—	—	—	—	—	—
70, 70TTL	1993	—	18-3561	—	—	—	—	—	—	—
75	1978-88	18-3669	18-3557	—	—	—	—	—	—	—
80 Jet	1994-95	18-3673	18-3543	18-3564	—	—	—	—	18-1243	18-2391
85	1978-80	18-3673	18-3543	18-3564	—	—	—	—	18-1243	18-2391
85	1993-95	18-3673	18-3543	18-3564	—	—	—	—	18-1243	18-2391
88	1987-95	18-3673	18-3543	18-3564	—	—	—	—	18-1243	18-2391
90 ④	1983-95	18-3673	18-3543	18-3564	—	—	—	—	18-1243	18-2391
90 Jet	1994	18-3673	18-3543	18-3564	—	—	—	—	18-1243	18-2391
100	1979-80	18-3673	18-3543	18-3564	—	—	—	—	18-1243	18-2391
100	1990-95	18-3673	18-3543	18-3564	—	—	—	—	18-1243	18-2391
100 Comm	1984-95	18-3673	18-3543	18-3564	—	—	—	—	—	—
110	1965-89	18-3673	18-3543	18-3564	—	—	—	—	18-1243	18-2391
112	1994-95	18-3673	18-3543	18-3564	—	—	—	—	18-1243	18-2391
115 ④	1978-95	18-3673	18-3543	18-3564	—	—	—	—	18-1243	18-2391
120	1988-91	—	—	—	—	18-1222	—	18-1221	—	—
140	1978-85	18-3673	18-3543	18-3564	—	—	—	—	18-1243	18-2391
140	1988-91	—	—	—	—	18-1222	—	18-1221	—	—
150	1978-91	18-3672 ①	18-3543	18-3563	18-1219	18-3567	18-3565	18-3562	18-1243	18-0182
155	1984-91	18-3672 ①	18-3543	18-3563	18-1219	18-3567	18-3565	18-3562	18-1243	18-0182
175	1977-91	18-3672 ⑤	18-3543	18-3563	18-1219	18-3567	18-3565	18-3562	18-1243	18-0182
185	1984-85	18-3672 ⑤	18-3543	18-3563	18-1219	18-3567	18-3565	18-3562	18-1243	18-0182
200	1977-83	18-3672 ⑤	18-3543	18-3563	18-1219	18-3567	18-3565	18-3562	18-1243	18-0182
200	1988-93	—	—	—	—	18-1222	18-3565	18-1221	—	—
225	1988-93	—	—	—	—	18-1222	18-3565	18-1221	—	—
235	1978-85	18-3672 ①	18-3543	18-3563	18-1219	18-3567	18-3565	18-3562	18-1243	18-0182

① All 1989-91 models except DR & DT
 ② Commercial

③ Commercial also
 ④ Except 60 degree models

⑤ For complete Thermostat Kit including gaskets & spring use 18-3674



Piston Rings are available individually

SIERRA PISTON KIT CONTENTS
(SEE APPLICATION CHARTS FOR SPECIFIC APPLICATIONS)

HP	Cyl.	Bore Size	Piston	OEM Part No.	Piston Ring	OEM Part No.	OEM Part No.	Circlips	OEM Part No.
9.9/15	2	2.188 / std.	—	397487	—	386279	N/A	—	325262
9.9/15	2	2.218 / .030	—	396574	18-3933	386280	N/A	—	325262
9.9/15	2	2.188 / std.	—	387660	—	386279	N/A	—	325262
9.9/15	2	2.218 / .030	18-4062	367661	18-3933	386280	N/A	—	325262
25-35	2	3.000 / std.	18-4107	392621	18-3910	396377	320954	18-4290 ①	317831
25-35	2	3.020 / .020	—	N/A	18-3911	396378	320954	18-4290 ①	317831
25-35	2	3.030 / .030	—	396576	18-3912	396379	320954	18-4290 ①	317831
35-60	2 & 3	3.167 / std.	—	391798	18-3913	391170, 434107	322188	18-4290 ①	317831
35-60	2 & 3	3.207 / .020	—	N/A	18-3914	N/A	322188	18-4290 ①	317831
35-60	2 & 3	3.217 / .030	—	396581	18-3915	391416, 434109	322188	18-4290 ①	317831
60-75	3	3.000 / std.	18-4124	387284	18-3910	396377	320954	18-4290 ①	317831
60-75	3	3.020 / .020	18-4114	387285	18-3911	396378	320954	18-4290 ①	317831
60-75	3	3.030 / .030	18-4104	396583	18-3912	396379	320954	18-4290 ①	317831
50-70	3	3.167 / std.	18-4063	394461	18-3913	391170, 434107	322188	18-4290 ①	317831
50-70	3	3.217 / .030	18-4064	398483	18-3915	391416, 434109	322188	18-4290 ①	317831

SIERRA V-4/V-6 PISTON KIT CONTENTS
(SEE APPLICATION CHARTS FOR SPECIFIC APPLICATIONS)

Model/HP	Cyl.	Bore Size	Piston	OEM Part #	Piston Ring	OEM Part #	Wrist Pin	OEM Part #	Circlips	OEM Part #
85-300	4 & 6	3.5	18-4120	393271, 393924	18-3904	394930	18-4280	327861	18-4290 ①	317831
85-300	4 & 6	3.52	18-4110	—	18-3906	396503, 385662	18-4280	327861	18-4290 ①	317831
85-300	4 & 6	3.53	18-4100	396585, 396588	18-3905	396504	18-4280	327861	18-4290 ①	317831
150-235	4 & 6	3.625	18-4123	392455	18-3907	390509	18-4280	327861	18-4290 ①	317831
150-235	4 & 6	3.645	18-4113	N/A	—	N/A	18-4280	327861	18-4290 ①	317831
150-235	4 & 6	3.655	18-4103	396587	18-3908	390510	18-4280	327861	18-4290 ①	317831
Loopers										
120-300	4 & 6	3.685 (port)	18-4085	432072, 432969	18-3975	431870	N.S.S.	—	18-4292	326765
120-300	4 & 6	3.685 (starboard)	18-4066	432073, 432970	18-3975	431870	N.S.S.	—	18-4292	326765
120-300	4 & 6	3.715 (port)	18-4067	432077, 433003	18-3974	431844	N.S.S.	—	18-4292	326765
120-300	4 & 6	3.715 (starboard)	18-4068	432078, 433004	18-3974	431844	N.S.S.	—	18-4292	326765
120-300	4 & 6	3.500 (port)	18-4122	393566	18-3904	394930	18-4280	327861	18-4290 ①	317831
120-300	4 & 6	3.500 (starboard)	—	391481	18-3904	394930	18-4280	327861	18-4290 ①	317831
120-300	4 & 6	3.520 (port)	—	N/A	18-3906	396503, 385662	18-4280	327861	18-4290 ①	317831
120-300	4 & 6	3.520 (starboard)	18-4111	N/A	18-3906	396503, 385662	18-4280	327861	18-4290 ①	317831
120-300	4 & 6	3.530 (port)	18-4102	393612	18-3905	396504	18-4280	327861	18-4290 ①	317831
120-300	4 & 6	3.530 (starboard)	18-4101	391653	18-3905	396504	18-4280	327861	18-4290 ①	317831
185, 200-225	6	3.5995 (port)	standard 18-4190	436880	18-3901	436254	—	—	—	—
185, 200-225	6	3.5995 (starboard)	standard 18-4079	436859	18-3901	436254	—	—	—	—
185, 200-225	6	3.5995 (port)	0.02 18-4195	439015	18-3947	439538	—	—	—	—
185, 200-225	6	3.5995 (starboard)	0.02 18-4085	439516	18-3947	439538	—	—	—	—
185, 200-225	6	3.5995 (port)	0.03 18-4165	439515	—	439538	—	—	—	—
185, 200-225	6	3.5995 (starboard)	0.03 18-4087	439515	—	439538	—	—	—	—

① This product is priced per piece. To order priced per package, please add -9 to the part number.

INLINE PISTON & RINGS APPLICATION

HP	Year	Cyl	Std. Bore	Std. Piston	.020 OS Piston	.030 OS Piston	Std. Rings	.020 OS Rings	.030 OS Rings
5/6/7.5	1986-95	2	1.937	18-4069	—	—	18-3972	—	—
9.9/15	1974-80	2	2.188	—	—	18-4062	—	—	18-3933
9.9/15	1981-93	2	2.188	—	—	—	—	—	18-3933
10	1988-90	2	2.188	—	—	—	—	—	18-3933
14	1988-90	2	2.188	—	—	—	—	—	18-3933
15 4-Stroke	1995-UP	2	2.188	—	—	—	—	—	18-3933
18 Jet	1995-98	2	3	18-4107	—	—	18-3910	18-3911	18-3912
20	1981-89	2	3	18-4107	—	—	18-3910	18-3911	18-3912
25	1977-80	2	3	—	—	—	18-3910	18-3911	18-3912
25	1981-96	2	3	18-4107	—	—	18-3910	18-3911	18-3912
25	1983-93	2	3.187	—	—	—	18-3913	18-3914	18-3915
28	1986-96	2	3	18-4107	—	—	18-3910	18-3911	18-3912
28 Jet	1995-96	2	3.187	—	—	—	18-3913	18-3914	18-3915
30	1984-98	2	3	18-4107	—	—	18-3910	18-3911	18-3912
35	1976-80	2	3	—	—	—	18-3910	18-3911	18-3912
35	1981-92	2	3	18-4107	—	—	18-3910	18-3911	18-3912
35	1986-87	2	3.187	—	—	—	18-3913	18-3914	18-3915
35 Jet	1990-98	2	3.187	—	—	—	18-3913	18-3914	18-3915
40	1975-83	2	3.187	—	—	—	18-3913	18-3914	18-3915
40	1984-98	2	3.187	—	—	—	18-3913	18-3914	18-3915
40 Comm.	1981-97	2	3.187	—	—	—	18-3913	18-3914	18-3915
45 Comm.	1985-92	2	3.187	—	—	—	18-3913	18-3914	18-3915
45SS	1987-90	2	3.187	—	—	—	18-3913	18-3914	18-3915
48	1987-97	2	3.187	—	—	—	18-3913	18-3914	18-3915
50	1981-95	2	3.187	—	—	—	18-3913	18-3914	18-3915
50	1995-98	3	3.187	18-4063	—	18-4064	18-3913	18-3914	18-3915
55	1976-79	2	3.187	—	—	—	18-3913	18-3914	18-3915
55 Comm.	1980-95	2	3.187	—	—	—	18-3913	18-3914	18-3915
60	1980-85	2	3.187	—	—	—	18-3913	18-3914	18-3915
60 (49 CID Model)	1986-88	3	3	18-4124	18-4114	18-4104	18-3910	18-3911	18-3912
60	1986-98	3	3.187	18-4063	—	18-4064	18-3913	18-3914	18-3915
65, 65 Comm.	1972-73	3	3	—	—	—	18-3910	18-3911	18-3912
49 CID Model	1984-86	3	3	18-4124	18-4114	18-4104	18-3910	18-3911	18-3912
65	1987-95	3	3.187	18-4063	—	18-4064	18-3913	18-3914	18-3915
65 Jet	1991-95	4	3.5	18-4120	18-4110	18-4100	18-3904	18-3906	18-3905
70	1974-75	3	3	—	—	—	18-3910	18-3911	18-3912
70	1976-85	3	3	18-4124	18-4114	18-4104	18-3910	18-3911	18-3912
70	1986-94	3	3.187	18-4063	—	18-4064	18-3913	18-3914	18-3915
75	1975	3	3	—	—	—	18-3910	18-3911	18-3912
75	1978-88	3	3	18-4124	18-4114	18-4104	18-3910	18-3911	18-3912

JOHNSON/EVINRUDE PISTONS (for V-4, V-6 and V-8 Applications)

HP	Cyl	Year	Std. Bore	STANDARD		.020" OS		.030" OS		Piston Rings	.020 OS Rings	.030 OS Rings	Powerhead Bearing Set
				Port	STBD	Port	STBD	Port	STBD				
65 Jet	4	1991-95	3.5	18-4120	18-4120	18-4110	18-4110	18-4100	18-4100	18-3904	18-3906	18-3905	18-1386
80 Jet	4	1991-96	3.5	18-4120	18-4120	18-4110	18-4110	18-4100	18-4100	18-3904	18-3906	18-3905	—
85	4	1979-80, 1991-95	3.5	18-4120	18-4120	18-4110	18-4110	18-4100	18-4100	18-3904	18-3906	18-3905	18-1386
88	4	1987-95	3.5	18-4120	18-4120	18-4110	18-4110	18-4100	18-4100	18-3904	18-3906	18-3905	18-1386
90	4	1981-98	3.5	18-4120	18-4120	18-4110	18-4110	18-4100	18-4100	18-3904	18-3906	18-3905	18-1386
100 ①	4	1979-97	3.5	18-4120	18-4120	18-4110	18-4110	18-4100	18-4100	18-3904	18-3906	18-3905	18-1386
110	4	1986-90	3.5	18-4120	18-4120	18-4110	18-4110	18-4100	18-4100	18-3904	18-3906	18-3905	18-1386
115	4	1974-77	3.5	18-4120	18-4120	18-4110	18-4110	18-4100	18-4100	18-3904	18-3906	18-3905	—
115	4	1978-98	3.5	18-4120	18-4120	18-4110	18-4110	18-4100	18-4100	18-3904	18-3906	18-3905	18-1386

① Except 1991 60" V Models

JOHNSON/EVINRUDE PISTONS (for V-4, V-6 and V-8 Applications) (Cont.)

HP	Cyl	Year	Std. Bore	STANDARD		.020" OS		.030" OS		Piston Rings	.020" OS Rings	.030" OS Rings	Powerhead Bearing Set
				Port	STBD	Port	STBD	Port	STBD				
120	4	1985-87	3.5	—	—	—	18-4111	18-4102	18-4101	18-3904	18-3906	18-3905	—
120	4	1985-94	3.685	18-4065	18-4066	—	—	18-4067	18-4068	18-3975	—	—	—
125 Comm.	4	1992-95	3.685	18-4065	18-4066	—	—	18-4067	18-4068	18-3975	—	—	—
130	4	1995-98	3.685	18-4065	18-4066	—	—	18-4067	18-4068	18-3975	—	—	—
135	4	1974-76	3.5	18-4120	18-4120	18-4110	18-4110	18-4100	18-4100	18-3904	18-3906	18-3905	—
140	4	1977	3.5	18-4120	18-4120	18-4110	18-4110	18-4100	18-4100	18-3904	18-3906	18-3905	—
140	4	1978-84	3.5	18-4120	18-4120	18-4110	18-4110	18-4100	18-4100	18-3904	18-3906	18-3905	18-1386
140	4	1985-87	3.5	—	—	—	18-4111	18-4102	18-4101	18-3904	18-3906	18-3905	—
140	4	1988-94	3.685	18-4065	18-4066	—	—	18-4067	18-4068	18-3975	—	—	—
1600CC	4	1988	3.5	18-4120	18-4120	18-4110	18-4110	18-4100	18-4100	18-3904	18-3906	18-3905	18-1386
150	6	1973-77	3.5	18-4120	18-4120	18-4110	18-4110	18-4100	18-4100	18-3904	18-3906	18-3905	—
150	6	1978-91	3.5	18-4120	18-4120	18-4110	18-4110	18-4100	18-4100	18-3904	18-3906	18-3905	—
155 Comm.	6	1984-92	3.5	18-4120	18-4120	18-4110	18-4110	18-4100	18-4100	18-3904	18-3906	18-3905	—
175	6	1977-83	3.5	18-4120	18-4120	18-4110	18-4110	18-4100	18-4100	18-3904	18-3906	18-3905	—
175	6	1986-91	3.625	18-4123	18-4123	18-4113	18-4113	—	—	18-3907	—	18-3908	—
185	6	1984-85	3.5	18-4120	18-4120	18-4110	18-4110	18-4100	18-4100	18-3904	18-3906	18-3905	—
185	6	1990-93	—	—	—	—	—	—	—	—	—	—	18-1389
185 Looper	6	1993-94	3.5995	18-4190	18-4079	18-4195	18-4086	18-4165	—	—	—	—	—
200	6	1978-83	3.5	18-4120	18-4120	18-4110	18-4110	18-4100	18-4100	18-3904	18-3906	18-3905	18-1389
200	6	1985-87	3.5	—	—	—	18-4111	18-4102	18-4101	18-3904	18-3906	18-3905	—
200 Ⓚ	6	1988-93	3.685	18-4065	18-4066	—	—	18-4067	18-4068	18-3975	—	—	18-1389
200-225 Looper	6	1993-01	3.5995	18-4190	18-4079	18-4195	18-4086	18-4165	18-4087	—	—	—	—
225	6	1985-87	3.5	—	—	—	18-4111	18-4102	18-4101	18-3904	18-3906	18-3905	18-1389
225	6	1988-93	3.685	18-4065	18-4066	—	—	18-4067	18-4068	18-3975	—	—	18-1389
235	6	1980-85	3.625	18-4123	18-4123	18-4113	18-4113	18-4103	18-4103	18-3907	—	18-3908	—
250/300	6	1990-93	3.685	18-4065	18-4066	—	—	18-4067	18-4068	18-3975	—	—	—
2500CC	6	1988	3.5	18-4120	18-4120	18-4110	18-4110	18-4100	18-4100	18-3904	18-3906	18-3905	—
250	6	1988-92	3.685	18-4065	18-4066	—	—	18-4067	18-4068	18-3975	—	—	—
275	6	1988-92	3.685	18-4065	18-4066	—	—	18-4067	18-4068	18-3975	—	—	—
275	8	1985-87	3.5	—	—	—	18-4111	18-4102	18-4101	18-3904	18-3906	18-3905	—
300	8	1988-92	3.685	18-4065	18-4066	—	—	18-4067	18-4068	18-3975	—	—	—
300/3.6L	8	1985-87	3.5	—	—	—	18-4111	18-4102	18-4101	18-3904	18-3906	18-3905	—

60° Eagle Series

HP	Cyl.	Bore Size	Piston	OE No.	Piston Ring	OE No.
90-175	4 & 6	3.600 (port)	—	436242	18-4088	436353
90-175	4 & 6	3.600 (starboard)	—	436243	18-4088	436353
90-175	4 & 6	3.620 (port)	—	N/A	18-4089	N/A
90-175	4 & 6	3.620 (starboard)	—	N/A	18-4089	N/A
90-175	4 & 6	3.630 (port)	—	439519	18-4090	436354

OMC V-4/V-6 60° Eagle Series Pistons

H.P.	YEAR	CYL.	STD. BORE	STANDARD		.020" O.S.		.030" O.S.		STD. RINGS	.030" O.S. Rings
				(PORT)	(STBD)	(PORT)	(STBD)	(PORT)	(STBD)		
90-175	1991-2000	4 & 6	3.600	—	—	—	—	18-4058	—	18-4088	18-4090

OMC SEA DRIVE PISTONS

H.P.	YEAR	CYL.	STD. BORE	STANDARD		.020" O.S.		.030" O.S.		STD. RINGS	.020" O.S. RINGS	.030" O.S. RINGS
				(PORT)	(STBD)	(PORT)	(STBD)	(PORT)	(STBD)			
1.6L	1983-89	4	3.500	18-4120	18-4120	18-4110	18-4110	18-4100	18-4100	18-3904	18-3906	18-3905
1.8L	1987	4	3.500	—	—	—	18-4111	18-4102	18-4101	18-3904	18-3906	18-3905
2.5L	1982, 1984-85	6	3.500	18-4120	18-4120	18-4110	18-4110	18-4100	18-4100	18-3904	18-3906	18-3905
2.6L	1982-86	6	3.625	18-4123	18-4123	18-4113	18-4113	—	—	18-3907	—	18-3908
2.7L	1987	6	3.500	—	—	—	18-4111	18-4102	18-4101	18-3904	18-3906	18-3905
3.6L	1987	8	3.500	—	—	—	18-4111	18-4102	18-4101	18-3904	—	18-3905

ORIGINAL EQUIPMENT MANUFACTURER RECOMMENDS THE REPLACEMENT OF ROD BOLTS WITH EVERY POWER HEAD REBUILD.

 <p style="text-align: center;">ROD BOLTS</p> <table border="1"> <thead> <tr> <th>Part #</th> <th>OE#</th> <th>Application</th> </tr> </thead> <tbody> <tr> <td>18-4075</td> <td>308186</td> <td>For V-4 & V-6 Crossflow engines</td> </tr> <tr> <td>18-4075-9①②</td> <td>308186</td> <td>For V-4 & V-6 Crossflow engines</td> </tr> <tr> <td>18-4076</td> <td>330081</td> <td>For V-4 Looper engines</td> </tr> </tbody> </table>			Part #	OE#	Application	18-4075	308186	For V-4 & V-6 Crossflow engines	18-4075-9①②	308186	For V-4 & V-6 Crossflow engines	18-4076	330081	For V-4 Looper engines	 <p>18-1752 CONNECTING ROD Replaces: 394462 For: 40HP (1999-01), 50HP (1995-98), 60HP (1999-01), 70HP (1986-01)</p>	 <p>18-1753 CONNECTING ROD Replaces: 395861 For: 30HP (1999-01), 40 HP (1985-02), 45HP (1986-87, 1990-97), 48HP (1987-96), 50HP (1985-02), 55HP (1985-93, 1999-01), 60 HP (1985)</p>
Part #	OE#	Application														
18-4075	308186	For V-4 & V-6 Crossflow engines														
18-4075-9①②	308186	For V-4 & V-6 Crossflow engines														
18-4076	330081	For V-4 Looper engines														
 <p>18-4148-1 CONNECTING ROD Replaces: 394488, 5004705 For V-4 Looper engines and some V-6 applications</p>	 <p>18-4197 CRANKSHAFT Replaces: 334665 3 Cylinder Looper Year HP 1989-92 60 1989-92 65 Comm 1989-95 70</p>	 <p>18-1352 CENTER MAIN BEARING Replaces: 378252</p>														
 <p>18-1353 CENTER MAIN BEARING Replaces: 387041</p>	 <p>18-1360 ROD BEARING Replaces: 396041</p>	 <p>18-1361 ROD CRANK END BEARING Replaces: 387787</p>														
 <p>18-1378 ROD BEARING Replaces: 388344</p>	 <p>18-1374 WRIST PIN BEARING Replaces: 395627</p>	 <p>18-1376 WRIST PIN BEARING Replaces: 434844</p>														
 <p>18-1377 CENTER MAIN BEARING Replaces: 320499</p>	 <p>18-4712 SLEEVE I.D. 3.1875 • O.D. 3.453 • Wall 0.126 • Length 5.556 Replacement straight sleeve with ports cut in</p>															

APPLICATION BEGINS ON NEXT PAGE

① Priced per Package

② Package of 12



18-4040
NEEDLE BEARINGS
 (18 Needles)
 Replaces: 387142, 387139
 (Crank End)
 (Must re-use cage)



POWERHEAD BEARINGS

Part #	Replaces:	Description
18-1391	330854	Lower Crankshaft Bearing
18-1395	385503	Lower Crankshaft Bearing

POWERHEAD BEARING KITS

18-1386

Contains

Part No.	Bearing Type	OE No.	Qty.
18-1353	Ctr. Main	387041	1
18-1377	Ctr. Main	320499	1
18-1374	Wrist Pin	395827	4
18-1395	Lower Crankshaft	385503	1
18-1361	Rod Crank End	387782	4



18-1389

Contains

Part No.	Bearing Type	OE No.	Qty.
18-1353	Ctr. Main	387041	2
18-1377	Ctr. Main	320499	2
18-1376	Wrist Pin	434844	6
18-1360	Rod	396041	4



HP	Year	Sleeve	Connecting Rod	Rod Bolt	Wrist Pin Brg.	Rod Brg. Complete	Rod Brgs.	Center Main Brg.	Split Brg. (sleeve)	Upper Crank Brg.	Lower Crank Brg.	Powerhead Brg. Kit
2 CYLINDER												
9.9	1974-83	-	-	-	-	-	-	-	-	-	-	-
9.9	1974-83	-	-	-	-	-	-	-	-	-	-	-
9.9	1974-80	-	-	-	-	-	-	-	-	-	-	-
9.9	1981-83	-	-	-	-	-	-	-	-	-	-	-
9.9	1986-92	-	-	-	-	-	-	-	-	-	-	-
9.9	1984-97	-	-	-	-	-	-	-	-	-	-	-
9.9	1998	-	-	-	-	-	-	-	-	-	-	-
14 Comm	1988-89	-	-	-	-	-	-	-	-	-	-	-
15	1974-83	-	-	-	-	-	-	-	-	-	-	-
15	1984-97	-	-	-	-	-	-	-	-	-	-	-
15 Comm	1994	-	-	-	18-1296	-	-	-	-	-	-	-
18	1960-68	-	-	-	-	-	18-4040	-	-	-	-	-
18	1970-73	-	-	-	-	-	18-4040	-	-	-	-	-
18 Jet	1996-97	-	-	-	18-1374	18-1378	-	-	-	-	18-1391	-
20	1981-84	-	-	-	18-1374	18-1378	18-4040	-	-	-	18-1391	-
20	1985-97	-	-	-	18-1374	18-1378	-	-	-	-	18-1391	-
25	1970-76	-	-	-	-	-	18-4040	-	-	-	-	-
25	1977	-	-	-	-	18-1378	18-4040	-	-	-	18-1391	-
25	1978-80	-	-	18-4075	-	18-1378	18-4040	-	-	-	18-1391	-
25	1981-84	-	-	-	18-1374	18-1378	18-4040	-	-	18-1391	18-1391	-
25 ①	1985-97	-	-	-	-	-	-	-	-	-	18-1391	-
25	1985-97	-	-	18-4075	18-1374	18-1378	-	-	-	-	-	-
25 Comm	1982-84	-	-	-	18-1374	18-1378	18-4040	-	-	-	18-1391	-
25 Comm	1985-97	-	-	-	18-1374	18-1378	-	-	-	-	18-1391	-
28	1987-97	-	-	-	18-1374	18-1378	-	-	-	-	18-1391	-
30	1981-93	-	-	18-4075	18-1374	18-1378	18-4040	-	-	-	-	-
30	1984-1992	-	-	18-4075	-	18-1378	18-4040	-	-	-	-	-
30	1985-97	-	-	-	18-1374	18-1378	18-4040	-	-	-	18-1391	-
30	1984	-	-	-	-	18-1378	18-4040	-	-	-	18-1391	-
33	1965-68	-	-	-	-	18-1378	18-4040	-	-	-	-	-
33	1970	-	-	-	-	18-1378	18-4040	-	-	-	-	-

① Except "D" Models ② Three Cylinder Models ③ 60 Degree Models
 ④ Two Cylinder Models ⑤ 90 Degree Models ⑥ V-4, V-6 & V-8 Model engines do not include upper bearings in kits

APPLICATION CONTINUED ON NEXT PAGE

HP	Year	Sleeve	Connecting Rod	Rod Bolt	Wrist Pin Brg.	Rod Brg. Complete	Rod Brgs.	Center Main Brg.	Split Brg. (sleeve)	Upper Crank Brg.	Lower Crank Brg.	Powerhead Brg. Kit
35	1976-80	-	-	-	-	18-1378	18-4040	-	-	-	18-1391	-
35	1981-84	-	-	18-4075	18-1374	-	18-4040	-	-	-	18-1391	-
35	1985-97	-	-	-	18-1374	18-1378	-	-	-	-	18-1391	-
35	1976-1993	-	-	18-4075	18-1374	18-1378	-	-	-	-	-	-
35	1977	-	-	18-4075	-	-	-	-	-	-	-	-
35	1978-1980	-	-	18-4075	-	18-1378	18-4040	-	-	-	18-1391	-
35	1981-1993	-	-	18-4075	18-1374	18-1378	-	-	-	-	18-1391	-
40	1984-92	18-4712	-	18-4075	18-1374	18-1378	-	18-1352	-	-	18-1391	-
40	1961-70	-	-	-	-	-	18-4040	-	-	-	-	-
40	1971-73	-	-	-	-	18-1378	18-4040	-	-	-	-	-
40	1974-76	-	-	-	-	18-1378	18-4040	18-1352	-	-	18-1154	-
40	1984-86	-	-	-	18-1374	18-1378	-	18-1352	-	18-1372	18-1154	-
40	1987-97	-	-	-	18-1374	18-1378	-	18-1352	-	-	18-1154	18-1389
40	1983	-	-	18-4075	-	-	-	18-1352	-	-	18-1154	-
40 Comm	1982-83	-	-	-	-	18-1378	-	18-1352	-	-	-	-
40 Comm	1984-85	-	-	-	-	18-1378	-	18-1352	-	18-1372	-	-
40 Comm	1989-90	-	-	-	-	18-1378	-	18-1352	-	-	-	-
40 Comm	1994	-	-	-	18-1374	18-1378	-	18-1352	-	-	-	-
40 Comm	1995-97	-	-	-	18-1374	-	-	18-1352	-	-	-	-
45 Comm	1985-86	-	-	-	18-1374	18-1378	-	18-1352	-	18-1372	-	-
45 Comm	1987-94	-	-	-	18-1374	18-1378	-	18-1352	-	18-1372	-	-
45 Comm	1995-97	-	-	-	18-1374	-	-	18-1352	-	-	-	-
45 Comm	1987	-	-	-	18-1374	18-1378	-	18-1352	-	-	18-1154	-
45ss	1987-90	-	-	-	18-1374	18-1378	-	18-1352	-	18-1372	-	-
48	1987	18-4712	-	-	18-1374	18-1378	-	18-1352	-	18-1372	-	-
48	1987-92	18-4712	-	18-4075	18-1374	18-1378	-	18-1352	-	-	-	-
48	1988-96	-	-	-	18-1374	18-1378	-	18-1352	-	-	-	-
50	1979-83	18-4712	-	18-4075	18-1374	18-1378	18-4040	18-1352	-	18-1372	-	-
50	1979-86	-	-	-	18-1374	18-1378	-	18-1352	-	18-1372	-	-
50	1981-93	18-4712	-	18-4075	18-1374	18-1378	-	18-1352	-	-	-	-
50i	1987-97	-	-	-	18-1374	18-1378	-	18-1352	-	-	-	-
50i	1995-97	-	-	-	18-1374	18-1378	-	18-1352	-	-	-	-
55	1968-89	-	-	-	-	18-1378	18-4040	18-1352	-	-	-	-
55	1976-81	-	-	-	18-1374	18-1378	18-4040	18-1352	-	18-1372	-	-
55 Comm	1982	-	-	-	18-1374	18-1378	18-4040	18-1352	-	18-1372	-	-
55 Comm	1983-86	-	-	-	18-1374	18-1378	-	18-1352	-	18-1372	-	-
55 Comm	1987-94	-	-	-	18-1374	18-1378	-	18-1352	-	-	-	-
55 Comm	1995-97	-	-	-	18-1374	18-1378	-	18-1352	-	-	-	-
55	1978-93	18-4712	-	18-4075	-	-	-	-	-	-	-	-
60	1980-85	18-4712	-	18-4075	18-1374	18-1378	-	18-1352	-	18-1372	-	-
60	1964-67,70-71	-	-	-	-	18-1378	18-4040	18-1352	-	-	-	-
60	86-90	-	-	-	18-1374	18-1378	-	18-1352	-	18-1372	-	-
60	1991-93	-	-	-	18-1374	18-1378	-	18-1352	-	-	-	-
60	1994-97	-	-	-	18-1374	-	-	18-1352	-	-	-	-
SST-60	1989-90	-	-	-	18-1374	18-1378	-	18-1352	-	18-1372	-	-
3 Cylinder												
60	1985	-	-	18-4075	18-1374	18-1378	18-4040	18-1352	-	18-1372	-	-
60	1986-90	-	-	-	18-1374	18-1378	18-4040	18-1352	-	18-1372	-	-
60	1986-88	-	-	18-4075	18-1374	18-1378	18-4040	18-1352	-	18-1372	-	-
60	1989-92	-	-	18-4075	18-1374	18-1378	18-4040	18-1352	-	-	-	-
65	1988	-	-	-	-	18-1378	18-4040	18-1352	-	-	-	-
65	1972-73	-	-	-	-	18-1378	18-4040	18-1352	-	18-1372	-	-

Ⓐ Except "D" Models
 Ⓑ Two Cylinder Models

Ⓒ Three Cylinder Models
 Ⓓ 90 Degree Models

Ⓔ 60 Degree Models
 Ⓕ V-4, V-6 & V-8 Model engines do not include upper bearings in kits

APPLICATION CONTINUED ON NEXT PAGE

HP	Year	Sleeve	Connecting Rod	Rod Bolt	Wrist Pin Brg.	Rod Brg. Complete	Rod Brgs.	Center Main Brg.	Split Brg. (sleeve)	Upper Crank Brg.	Lower Crank Brg.	Powerhead Brg. Kit
65 Comm	1984	-	-	-	18-1374	18-1378	18-4040	18-1352	-	18-1372	-	-
65 Comm	1985-90	-	-	-	18-1374	18-1378	18-4040	18-1352	-	18-1372	-	-
65 Comm	1991-93	-	-	-	18-1374	18-1378	18-4040	18-1352	-	-	-	-
65 Comm.	1994-97	-	-	-	18-1374	18-1378	18-4040	18-1352	-	-	-	-
65	1984-86	-	-	18-4075	18-1374	18-1378	18-4040	18-1352	-	18-1372	18-1154	-
70	1976-85	-	-	18-4075	18-1374	18-1378	18-4040	18-1352	-	18-1372	18-1154	-
70	1974-75	-	-	-	-	18-1378	18-4040	18-1352	-	18-1372	-	-
70	1976-90	-	-	-	18-1374	18-1378	18-4040	18-1352	-	18-1372	18-1154	-
70	1976-84	-	-	18-4075	18-1374	18-1378	18-4040	18-1352	-	18-1372	18-1154	-
70	1985-90	-	-	-	18-1374	18-1378	18-4040	18-1352	-	18-1372	18-1154	-
70	1991-93	-	-	-	18-1374	18-1378	18-4040	18-1352	-	-	-	-
70	1994-97	-	-	-	18-1374	-	-	18-1352	-	-	-	-
75	1960-65	-	-	-	-	18-1378	18-4040	18-1352	-	-	-	-
75	1975	-	-	-	-	18-1378	18-4040	18-1352	-	18-1372	18-1154	-
75	1976-84	-	-	18-4075	18-1374	18-1378	18-4040	18-1352	-	18-1372	18-1154	-
75	1982-88	-	-	18-4075	18-1374	18-1378	18-4040	18-1352	-	18-1372	18-1154	-
75	1985-88	-	-	-	18-1374	18-1378	18-4040	18-1352	-	18-1372	18-1154	-
75 ①	1976-88	-	-	18-4075	18-1374	18-1378	18-4040	18-1352	-	18-1372	18-1154	-
V-4 CROSSFLOW												
65JET	1992-95	-	-	18-4075	18-1374	18-1361	18-4040	18-1353	18-1377	-	18-1395	18-1386
80	1966-67	-	-	-	-	18-1378	18-4040	18-1352	-	-	-	-
80JET	1993-97	-	-	18-4075	18-1374	18-1361	18-4040	18-1353	18-1377	-	18-1395	18-1386
80JET	1992-97	-	-	-	18-1374	18-1361	18-4040	18-1353	18-1377	-	18-1395	18-1386
85	1968-72	-	-	-	-	18-1378	18-4040	18-1352	-	-	18-1154	-
85	1973	-	-	-	18-1374	18-1378	18-4040	18-1352	-	-	18-1395	-
85	1974-78	-	-	-	18-1374	18-1361	18-4040	18-1352	-	-	18-1395	-
85 ①	1979-80	-	-	18-4075	18-1374	18-1361	18-4040	18-1353	18-1377	-	18-1395	18-1386
85 ①	1991-95	-	-	-	18-1374	18-1361	18-4040	18-1353	18-1377	-	18-1395	18-1386
85	1979-80,92	-	-	18-4075	18-1374	18-1361	18-4040	18-1353	18-1377	-	18-1395	18-1386
85TTL	1992-95	-	-	18-4075	18-1374	18-1361	18-4040	18-1353	18-1377	-	18-1395	18-1386
88	1987-91	-	-	18-4075	18-1374	18-1361	18-4040	18-1353	18-1377	-	18-1395	18-1386
88 ①	1987-96	-	-	18-4075	18-1374	18-1361	18-4040	18-1353	18-1377	-	18-1395	18-1386
88	1987-92	-	-	18-4075	18-1374	18-1361	18-4040	18-1353	18-1377	-	18-1395	18-1386
88	1993	-	-	18-4075	18-1374	18-1361	18-4040	18-1353	18-1377	-	18-1395	18-1386
88	1992-96	-	-	18-4075	18-1374	18-1361	18-4040	18-1353	18-1377	-	18-1395	18-1386
90	1981-86	-	-	18-4075	18-1374	18-1361	18-4040	18-1353	18-1377	-	18-1395	18-1386
90	1986-91	-	-	18-4075	18-1374	18-1361	18-4040	18-1353	18-1377	-	18-1395	18-1386
90	1992-94	-	-	18-4075	18-1374	18-1361	18-4040	18-1353	18-1377	-	18-1395	18-1386
90 ① ④	1981-97	-	-	18-4075	18-1374	18-1361	18-4040	18-1353	18-1377	-	18-1395	18-1386
90 ④	1981-97	-	-	18-4075	18-1374	18-1361	18-4040	18-1353	18-1377	-	18-1395	18-1386
90 ⑤	1995-97	-	-	18-4075	18-1374	18-1361	18-4040	18-1353	18-1377	-	18-1395	18-1386
90JET ⑥	1994-95	-	-	18-4075	18-1374	18-1361	18-4040	18-1353	18-1377	-	18-1395	18-1386
90	1981-92	-	-	18-4075	18-1374	18-1361	18-4040	18-1353	18-1377	-	18-1395	18-1386
90	1993	-	-	18-4075	18-1374	18-1361	18-4040	18-1353	18-1377	-	18-1395	18-1386
100	1966-68	-	-	-	-	18-1378	18-4040	18-1352	-	-	18-1154	-
100	1971-72	-	-	-	-	18-1378	18-4040	18-1352	-	-	18-1154	-
100 ③	1979-80	-	-	18-4075	18-1374	18-1361	18-4040	18-1353	18-1377	-	18-1395	18-1386
100	1984-85	-	-	18-4075	18-1374	18-1361	18-4040	18-1353	18-1377	-	18-1395	18-1386
100	1986-91	-	-	18-4075	18-1374	18-1361	18-4040	18-1353	18-1377	-	18-1395	18-1386
100 ③	1990-94	-	-	18-4075	18-1374	18-1361	18-4040	18-1353	18-1377	-	18-1395	18-1386
100 Comm ①	1984-97	-	-	18-4075	18-1374	18-1361	18-4040	18-1353	18-1377	-	18-1395	18-1386
100	1979-81,92	-	-	18-4075	18-1374	18-1361	18-4040	18-1353	18-1377	-	18-1395	18-1386
100	1992-97	-	-	18-4075	18-1374	18-1361	18-4040	18-1353	18-1377	-	18-1395	18-1386

① Except "D" Models ③ Three Cylinder Models ⑤ 60 Degree Models
 ② Two Cylinder Models ④ 90 Degree Models ⑥ V-4, V-6 & V-8 Model engines do not include upper bearings in kits

APPLICATION CONTINUED ON NEXT PAGE

HP	Year	Sleeve	Connecting Rod	Rod Bolt	Wrist Pin Brg.	Rod Brg. Complete	Rod Brgs.	Center Main Brg.	Split Brg. (sleeve)	Upper Crank Brg.	Lower Crank Brg.	Powerhead Brg. Kit
100	1993	-	-	18-4075	18-1374	18-1361	18-4040	18-1353	18-1377	-	18-1395	18-1386
100 Comm	1984-87,89-92	-	-	18-4075	18-1374	18-1361	18-4040	18-1353	18-1377	-	18-1395	18-1386
100 Comm.	1993	-	-	18-4075	18-1374	18-1361	18-4040	18-1353	18-1377	-	18-1395	18-1386
110 ①	1986-89	-	-	18-4075	18-1374	18-1361	18-4040	18-1353	18-1377	-	18-1395	18-1386
112 ①	1994-96	-	-	-	18-1374	18-1361	18-4040	18-1353	18-1377	-	18-1395	18-1386
115	1969-70	-	-	-	-	18-1378	18-4040	18-1352	-	-	18-1154	-
115	1973	-	-	18-4075	18-1374	18-1378	18-4040	18-1352	-	-	18-1395	-
115	1974-78	-	-	18-4075	18-1374	18-1361	18-4040	18-1352	-	-	18-1395	-
115 ① ②	1990-97	-	-	-	18-1374	18-1361	18-4040	18-1353	18-1377	-	18-1395	18-1386
115 ①	1979-85	-	-	18-4075	18-1374	18-1361	18-4040	18-1353	18-1377	-	18-1395	18-1386
115	1991-92	-	-	18-4075	18-1374	18-1361	18-4040	18-1353	18-1377	-	18-1395	18-1386
115	1990-91	-	-	18-4075	18-1374	18-1361	18-4040	18-1353	18-1377	-	18-1395	18-1386
115	1993	-	-	18-4075	18-1374	18-1361	18-4040	18-1353	18-1377	-	18-1395	18-1386
115	1992-94	-	-	18-4075	18-1374	18-1361	18-4040	18-1353	18-1377	-	18-1395	18-1386
115 ①	1990-97	-	-	-	18-1374	18-1361	18-4040	18-1353	18-1377	-	-	-
115 ②	1995-97	-	-	-	-	18-1361	18-4040	18-1353	18-1377	-	-	-
115JET ③	1984-97	-	-	-	18-1374	18-1361	18-4040	18-1353	18-1377	-	18-1395	18-1386
115C	1984	-	-	18-4075	18-1374	18-1361	18-4040	18-1353	18-1377	-	18-1395	18-1386
120 ①	1985-94	-	-	-	18-1378	18-1360	-	18-1353	18-1377	-	-	-
125	1971-72	-	-	-	-	18-1378	18-4040	18-1352	-	-	-	-
125 Comm ④	1989-95	-	-	-	18-1376	18-1360	-	18-1353	18-1377	-	-	-
125Eax ①	1991-94	-	-	-	18-1376	18-1360	-	18-1353	18-1377	-	-	-
130 ①	1994-97	-	-	-	18-1376	18-1360	-	18-1353	18-1377	-	-	-
135	1973	-	-	-	18-1374	18-1378	18-4040	18-1352	-	-	18-1395	-
135	1974-76	-	-	18-4075	18-1374	18-1361	18-4040	18-1352	-	-	18-1395	-
140	1977-78	-	-	18-4075	18-1374	18-1361	18-4040	18-1352	-	-	18-1395	-
140	1979	-	-	18-4075	-	-	-	-	-	-	-	-
140 ①	1979-84	-	-	-	18-1374	18-1361	18-4040	18-1353	18-1377	-	18-1395	18-1386
140 ①	1985-94	-	-	-	18-1376	18-1360	-	18-1353	18-1377	-	-	-
140	1977-84	-	-	18-4075	18-1374	18-1361	18-4040	18-1353	18-1377	-	18-1395	18-1386
1600CC	1988	-	-	18-4075	-	-	-	-	-	-	-	-
1.6L	-	-	-	18-4075	-	-	-	-	-	-	-	-
V-6 CROSSFLOW												
150 ①	1978-91	-	-	-	18-1374	18-1361	18-4040	18-1353	18-1377	-	18-1395	-
150 ②	1991-97	-	-	-	-	18-1361	18-4040	18-1353	-	-	-	-
150 Comm ⑤	1993-95	-	-	-	-	18-1361	18-4040	18-1353	-	-	-	-
150	1978-85	-	-	18-4075	18-1374	18-1361	18-4040	18-1353	18-1377	-	18-1395	-
150	1978-88	-	-	18-4075	18-1374	18-1361	18-4040	18-1353	18-1377	-	18-1395	-
150	1986-91	-	-	18-4075	18-1374	18-1361	18-4040	18-1353	18-1377	-	-	-
150	1989-91	-	-	18-4075	18-1374	18-1361	18-4040	18-1353	18-1377	-	-	-
155 Comm	1984-85	-	-	18-4075	18-1374	18-1361	18-4040	18-1353	18-1377	-	18-1395	-
155 Comm ⑥	1984-92	-	-	-	18-1374	18-1361	18-4040	18-1353	18-1377	-	18-1395	-
155 Comm	1986-91	-	-	18-4075	-	-	-	-	-	-	-	-
175 ①	1977-91	-	-	-	18-1374	18-1361	18-4040	18-1353	18-1377	-	18-1395	-
175 ②	1991-97	-	-	-	-	18-1361	18-4040	18-1353	-	-	-	-
175	1977-83	-	-	18-4075	18-1374	18-1361	18-4040	18-1353	18-1377	-	-	-
175	1986-90	-	-	18-4075	18-1374	18-1361	18-4040	18-1353	18-1377	-	-	-
175	1977-83,85	-	-	18-4075	18-1374	18-1361	18-4040	18-1353	18-1377	-	-	-
185 ①	1984-85	-	-	18-4075	18-1374	18-1361	18-4040	18-1353	18-1377	-	18-1395	18-1389
185	1990	-	18-4148-1	18-4076	-	-	-	-	-	-	-	-
185 ①	1990-94	-	-	-	18-1376	18-1360	-	18-1353	18-1377	-	-	18-1389
185	1990-93	-	18-4148-1	18-4076	-	-	-	-	-	-	-	-

① Except "D" Models
② Two Cylinder Models

③ Three Cylinder Models
④ 90 Degree Models

⑤ 60 Degree Models
⑥ V-4, V-6 & V-8 Model engines do not include upper bearings in kits

APPLICATION CONTINUED ON NEXT PAGE

HP	Year	Sleeve	Connecting Rod	Rod Bolt	Wrist Pin Brg.	Rod Brg. Complete	Rod Brgs.	Center Main Brg.	Split Brg. (sleeve)	Upper Crank Brg.	Lower Crank Brg.	Powerhead Brg. Kit
185	1992-94	-	18-4148-1	18-4076	-	-	-	-	-	-	-	-
200	1976-83	-	-	18-4075	18-1374	18-1361	18-4040	18-1353	18-1377	-	18-1395	18-1389
200	1986-97	-	-	-	18-1376	18-1360	-	18-1353	18-1377	-	-	-
200 Comm	1990	-	18-4148-1	18-4076	-	-	-	-	-	-	-	-
200 Comm	1990-94	-	-	-	18-1376	18-1360	-	18-1353	18-1377	-	-	-
200	1976-83	-	-	18-4075	18-1374	18-1361	18-4040	18-1353	18-1377	-	18-1395	-
200C	1990	-	-	18-4076	18-1376	18-1360	-	18-1353	18-1377	-	-	-
200	1986-91	-	-	18-4076	-	-	-	-	-	-	-	-
200	1986-93	-	-	18-4076	-	-	-	-	-	-	-	-
225	1986-97	-	-	-	18-1376	18-1360	-	18-1353	18-1377	-	-	18-1389
235	1976-85	-	-	18-4075	18-1374	18-1361	18-4040	18-1353	18-1377	-	18-1395	-
235	1976-79	-	-	18-4075	18-1374	18-1361	18-4040	18-1353	18-1377	-	-	-
235	1980-85	18-4718	-	18-4075	18-1374	18-1361	18-4040	18-1353	18-1377	-	-	-
250	1991-95	-	-	-	18-1376	18-1360	-	18-1353	18-1377	-	-	-
250	1997	-	-	-	18-1376	18-1360	-	18-1353	18-1377	-	-	-
275	1985-88	-	-	-	18-1376	18-1360	-	18-1353	18-1377	-	-	-
3.6L	1985-87	-	-	-	18-1376	18-1360	-	18-1353	18-1377	-	-	-
300	1986-95	-	-	-	18-1376	18-1360	-	18-1353	18-1377	-	-	-
2500CC	1988	-	-	-	-	-	-	-	-	-	-	-
2.5L	1982,84-85	-	-	-	-	-	-	-	-	-	-	-
2.6L	1982-86	18-4718	-	-	-	-	-	-	-	-	-	-
V-4 LOOPER												
120	1985	-	-	18-4076	18-1376	18-1360	-	18-1353	18-1377	-	-	-
120	1985-94	-	-	18-4076	18-1376	18-1360	-	18-1353	18-1377	-	-	-
125	1985-94	-	-	18-4076	18-1376	18-1360	-	18-1353	18-1377	-	-	-
140	1985-94	-	-	18-4076	18-1376	18-1360	-	18-1353	18-1377	-	-	-
1.6L	ALL	-	-	18-4076	-	-	-	-	-	-	-	-
V-6 LOOPER												
225	1986-91	-	-	18-4076	18-1376	18-1360	-	18-1353	18-1377	-	-	-
225	1986-93	-	-	18-4076	18-1376	18-1360	-	18-1353	18-1377	-	-	-
2.7L	1987	-	-	18-4076	-	-	-	-	-	-	-	-
275	1985-88	-	-	18-4076	18-1376	18-1360	-	18-1353	18-1377	-	-	-
300	1985-95	-	-	18-4076	18-1376	18-1360	-	18-1353	18-1377	-	-	-

① Except "D" Models
② Two Cylinder Models

③ Three Cylinder Models
④ 90 Degree Models

⑤ 60 Degree Models
⑥ V-4, V-6 & V-8 Model engines do not include upper bearings in kits

**18-4329
CRANKSHAFT
SEAL KIT**

For: 20-35 HP



HP	Years	HP	Years
20	1981-89	30	1984-89
25	1977-89	35	1976-89
28	1986-88		

**18-4330
CRANKSHAFT
SEAL KIT**

For: 40-75 HP



**18-4331
CRANKSHAFT
SEAL KIT**

For: Crossflow V-4 - V-6

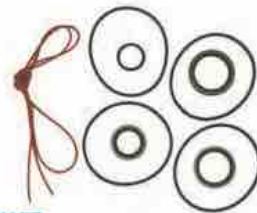

**18-4332
CRANKSHAFT SEAL KIT**

For: 9.9 - 15 HP



**18-8355
CRANKSHAFT SEAL KIT**

For:

Year	Model/HP
1993-96	20-35R/25/30TE/ 20-30E
1990	20-30AC, TE, E/ 20-35R/25COMM.
1991-92	25/28/32R, TE, RE
Year	Model/HP
1994-96	20-30AC, E/ 25COMM./28

**18-1286
UPPER CRANKSHAFT SEAL**

Replaces: 336232
For: 60" & EFT 90-115HP & 150-175HP





***18-7895
OIL FILTER**
Replaces: 778888, 5035703
200/225 (2004-05)



***18-7896
OIL FILTER**
Replaces: 778886, 5033539
90-115 EFI (2003-05)



***18-7897
OIL FILTER**
Replaces: 778887, 5033919
140 EFI (2003-05)



**18-7903
OIL FILTER**
Replaces: 5033102, 763364
9.9-15HP (2002-07)



***18-7915-1
OIL FILTER**
Replaces: 778885, 5031411
25-70 HP (1999-2005)



***18-7916
OIL FILTER**
Replaces: 434839
9.9 & 15 HP models from (1995-2001)
OMC Bull



**18-70936
HOSE (CYLINDER HEAD, STARBOARD)**
Replaces: 340975, 321724
Fits: 90 (1994-95), 100 (1996-97), 115 (1994-97), E88 (1996), E90 (1996-98), E100 (1996-97), E112 (1996), E115 (1996-98), J88 (1996), J90 (1996-98), J100 (1997-98), J112 (1996), J115 (1996-98)



**18-70937
HOSE (CYLINDER HEAD, PORT)**
Replaces: 340976
Fits: 90 (1994-95), 100 (1996-97), 115 (1994-97), E88 (1996), E90 (1996-98), E100 (1996-97), E112 (1996), E115 (1996-98), J88 (1996), J90 (1996-98), J100 (1997-98), J112 (1996), J115 (1996-98)

SEE PAGE 219 FOR OUR COMPLETE LINE OF GASKET SEALANTS

— CONTAINS —

Part #	Desc.	O.E. #	Qty.
18-0933	Air Silencer Gasket	314115	1
18-0935	Base To Cover Gasket	314322	1
NSS	Carburetor to Manifold Gasket	317305	1
18-2543	Water Jacket Gasket	318609	1
18-0118	Carburetor Gasket	325092	3
18-2913	Exhaust Cover Gasket	318609	2
18-2938	Exhaust Cover Gasket	331917	1
18-2548	Thermostat Gasket	332108	1
18-2865	Adapter to Powerhead Gasket	313763	1
18-0929	Thermostat Gasket	313416	1



**18-4300
POWERHEAD GASKET SET**
Replaces: 385416, 439084

— CONTAINS —

Part #	Desc.	O.E. #	Qty.
18-2876	By-Pass Cover Gasket	307133	4
18-2966	Exhaust Cover Gasket	317914	2
18-0953	Water Pass. Gasket	317951	1
18-0117	Exhaust Plate Gasket	317995	1
18-0955	Exhaust Cover Gasket	318156	1
18-2873	Cyl. Cover Starboard Gasket	318335	2
18-0957	Adapter To Powerhead Gasket	318373	1
18-2867	Manifold to Crankcase Gasket	319174	1
18-2964	Adapter to Powerhead Gasket	321727	1
18-0991	Leaf Plate Gasket	321907	4
18-0134	Carburetor to Manifold Gasket	327707	2
18-2857	Air Silencer	386573,	
	To Carburetor Gasket	319771	2

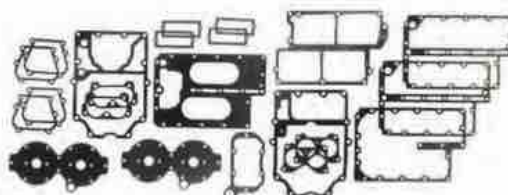

**18-4301
POWERHEAD GASKET SET**
Replaces: 388602

APPLICATIONS BEGIN ON PAGE 326

* Anti-Drain-Back Valve

Valve eliminates dry starts, prevents oil from draining back into crankcase during engine shutdown.

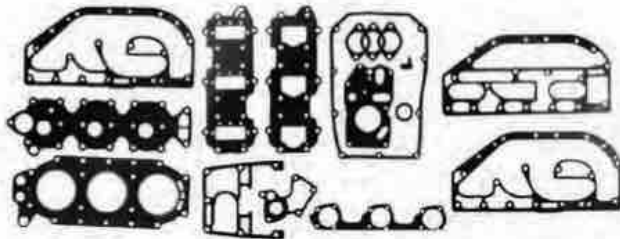

18-4302
POWERHEAD GASKET SET
Replaces: 390078

-- CONTAINS --

Part #	Desc.	O.E. #	Qty.
18-2960	Head Gasket	313413	1
18-2865	Adapter to Powerhead Gasket	313763	1
NSS	Carb to Manifold Gasket	317305	1
18-2543	Water Jacket Gasket	318609	1
18-0989	Air Silencer Gasket	321794	1
18-0118	Carburetor Gasket	325092	3
18-0102	Exhaust Manifold Gasket	323469	1
18-2913	Exhaust Cover Gasket	331916	2
18-2938	Exhaust Cover Gasket	331917	1
18-2548	Thermostat Cover Gasket	332108	1
18-0975	Carb to Silencer Gasket	333008	1

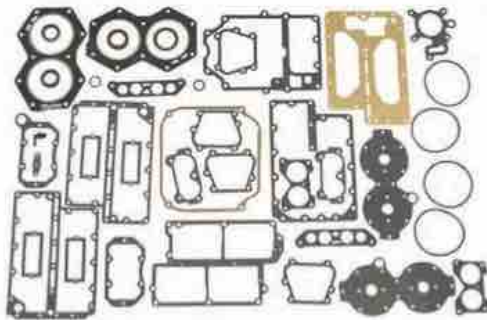

18-4303-1
POWERHEAD GASKET SET
Replaces: 389556, 391300, 439085

-- CONTAINS --

Part #	Desc.	O.E. #	Qty.
18-0850	Fuel Pump Mtg Gasket	303615	1
18-2876	By-Pass Cover Gasket	307133	4
18-2866	Exhaust Cover Gasket	317914	2
18-0953	Water Passage Gasket	317951	1
18-0117	Exhaust Plate Gasket	317995	1
18-2873	Gasket	318335	2
18-2074	Seal	0339620	1
18-2956	Water Jacket Head Gasket	318358	2
18-2867	Manifold to Crankcase Gasket	319174	1
18-2857	Air Silencer to Carb. Gasket	386573,	
		319771	2
18-0985	Air Silencer Gasket	321722	1
18-2864	Adapter to Powerhead Gasket	321727	1
18-0991	Leaf Plate Gasket	321907	4
18-2547	Water Pass. Cover Gasket	322858	1
18-0102	Exhaust Manifold Gasket	323469	1
18-0134	Intake Plate Gasket	326926	1
18-0977	Thermostat Gasket	332369	2

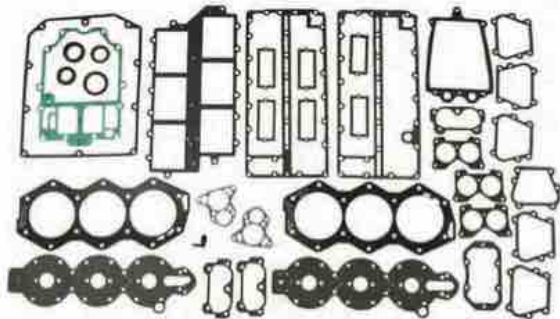

18-4304-1
POWERHEAD GASKET SET
Replaces: 391988

-- CONTAINS --

Part #	Desc.	O.E. #	Qty.
18-2549	Exhaust Plate Gasket	321543	1
18-2876	By-Pass Cover Gasket	307133	6
18-2544	Water Jacket Cover Gasket	321028	2
18-2545	Exhaust Plate Gasket	321182	1
18-0979	Air Silencer Gasket	321183	1
18-2546	Thermostat Gasket	321184	2
18-0991	Leaf Plate Gasket	321907	6
18-2547	Water Passage Cover Gasket	322858	1
18-0995	Adapter to Powerhead Gasket	323222	1
18-0134	Carburetor To Manifold Gasket	327707	3
18-0148	Intake Manifold Gasket	329718	1
18-2964	Head Gasket	320745, 335360, 766779	2
18-2550	Powerhead Gasket	323214	1
18-2857	Air Silencer To Carburetor Gasket	386573, 319771	1
18-2001	Oil Seal	330137	1
18-2074	Oil Seal	0339620	2
18-8307	Oil Seal	331103	1



18-4305
POWERHEAD GASKET SET
Replaces: 393433, 437806, 439083
For: 2 cylinder models only

-- CONTAINS --

Part #	Desc.	O.E. #	Qty.
18-0851	Relief Port Twin Gasket	329826	1
18-0850	Fuel Pump Mtg. Gasket	303615	1
18-0941	Water Jacket Cover Gasket	315538	1
18-0118	Carburetor Gasket	325092	2
18-0120	Exhaust Cover Gasket	325211	1
18-0128	Powerhead Mtg. Twin Gasket	326468, 351018	1
18-3802	Head Gasket	327795, 335359	1
18-0136	Powerhead Mounting Gasket	328283	1
18-0157	Airbox Split Twin Gasket	330898	1
18-0154	Airbox Split Twin Gasket	—	1
18-0159	Airbox Split Twin Gasket	330909	1
18-0983	Carb. to Air Box Twin Gasket	321497	1
18-0182	Thermostat Gasket	310058	1
18-0963	Intake Manifold Twin Gasket	335633	1

— CONTAINS —

Part #	Desc.	O.E. #	Qty.
18-0850	Fuel Pump Mtg. Gasket	303615	1
18-0122	Outer Leaf Plate Gasket	325260	1
18-0961	Carburetor to Intake Manifold Gasket	318932	1
18-0967	By-Pass Cover Gasket	319332	1
18-0112	Powerhead Mtg. Gasket	324717	1
18-0959	Inner Leaf Plate Gasket	318924	1
18-2907	Adapter Housing Gasket	325721	1
18-2905	Water Cover Gasket	329920	1
18-2853	Exhaust Cover Gasket	318925	2
18-2963	Head Gasket	330818	1
18-2879	Filler Cap to Pump Gasket	331363, 338876	1

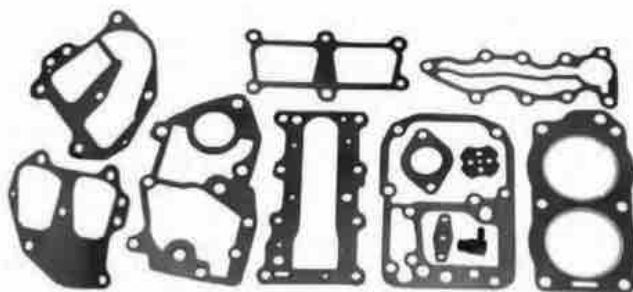

**18-4306
POWERHEAD GASKET SET**
Replaces: 394546

— CONTAINS —

Part #	Desc.	O.E. #	Qty.
18-0850	Fuel Pump Mounting Gasket	303615	1
18-0971	By-Pass Gasket	319661	1
18-0981	Leaf Plate Gasket	321479	1
18-0106	Exhaust Manifold Gasket	324323	2
18-0118	Carburetor Gasket	325092	1
18-2862	Manifold to Leaf Plate Gasket	321573, 326260	1
18-0126	Inner Exhaust Cover Gasket	326264	1
18-2852	Powerhead to Lower Unit Gasket	330621	1
18-3803	Head Gasket	329419, 765012	1

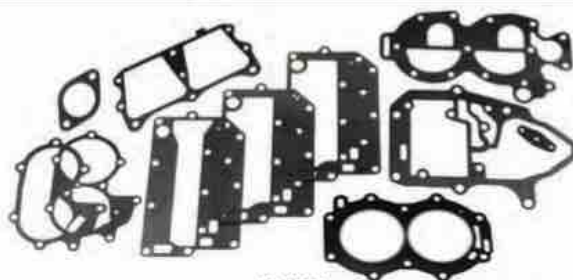

**18-4307
POWERHEAD GASKET SET**
Replaces: 433941, 392567, 392615, 389206

— CONTAINS —

Part #	Desc.	O.E. #	Qty.
18-0991	Leaf Plate	321907	6
18-0995	Adapter to Powerhead Gasket	323222	1
18-0134	Carburetor to Manifold Gasket	327707	3
18-0146	Intake Manifold Gasket	329718	1
18-0979	Air Silencer Gasket	321183	1
18-0945	Outer Exhaust Gasket	336430	1
18-0927	Inner Exhaust Cover Gasket	393561	1
18-2544	Water Jack. Cover Gasket	321028	2
18-2546	Thermostat Gasket	321184	2
18-2547	Water Passage Cover Gasket	322858	1
18-2550	Powerhead Gasket	323214	1
18-2857	Air Silencer Carburetor Gasket	386573, 319771	1
18-2876	By-Pass Cover Gasket	307133	6
18-7416	O-Ring	329380	1
18-7417	O-Ring	329381	1
18-3801	Head Gasket	325647, 335361	2

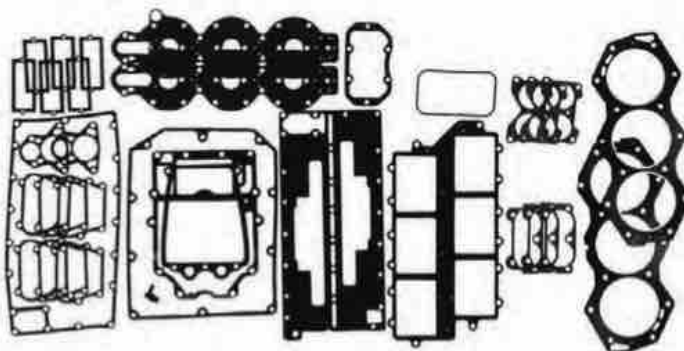

**18-4309
POWERHEAD GASKET SET**
Replaces: 394885, 434381

— CONTAINS —

Part #	Desc.	O.E. #	Qty.
18-0142	Intake Manifold Gasket	326622	1
18-0155	Rectifier Mtg. Gasket	330412	2
18-0138	Adapter to Powerhead Gasket	328590	1
18-0140	AirBox Gasket	328604	2
18-2074	Oil Seal	0339620	1
18-2075	Oil Seal	0353078	1
18-7418	O-Ring	326741	4
18-3837	Head Gasket	328623	2
18-0978	Cover to Base Gasket	331598	2

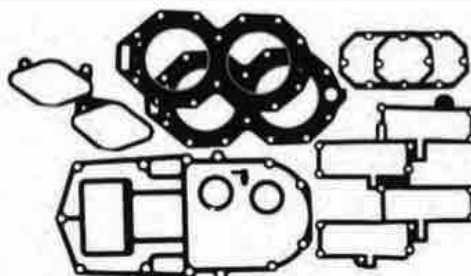

**18-4310
POWERHEAD GASKET SET**
Replaces: 396750

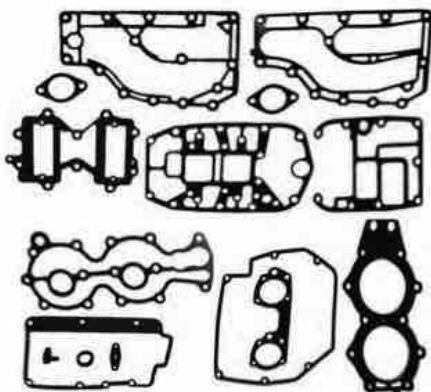

18-4318
POWERHEAD GASKET SET
 Replaces: 390076

— CONTAINS —

Part #	Desc.	O.E. #	Qty.
18-0963	Intake Manifold Gasket/Twin	335633	1
18-0850	Fuel Pump Mtg. Gasket	303615	1
18-0118	Carburetor Gasket	325092	2
18-0983	Carburetor to Airbox	321497	1
18-3802	Head Gasket	327795, 335359	1
18-0941	Water Jacket Cover Gasket	315538	1
18-0157	Air Box Split Gasket	330698	1
18-0128	Powerhead Mounting Gasket	325468, 351018	1
18-0136	Powerhead Mounting Gasket	328283	1
18-1224	Exhaust Cover Gasket	315869	1
18-1218	Exhaust Cover Gasket	315868	1
18-0182	Seal	310058	1

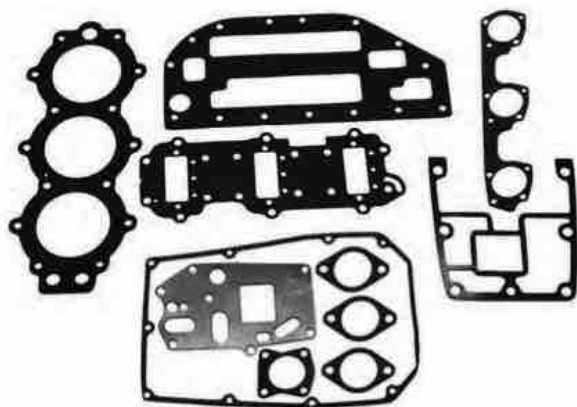

18-4321
POWERHEAD GASKET SET
 Replaces: 398047, 438904

— CONTAINS —

Part #	Desc.	O.E. #	Qty.
18-0118	Carburetor Gasket	325092	3
18-0989	Air Silencer Gasket	321794	1
18-0975	Carb to Silencer Gasket	333008	1
18-3836	Head Gasket	329836	1
18-1202	Thermostat Cover Gasket	329830	1
18-1205	Adapter Gasket	329829	1
18-1207	Exhaust Manifold Gasket	329833, 343863	1
18-1212	Intake Manifold Gasket	326926	1
18-1219	Grommet	320880	1
18-1221	Retainer	330273	1

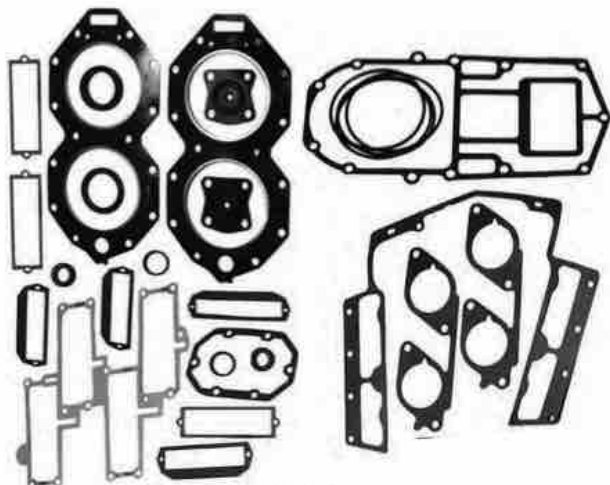

18-4322
POWERHEAD GASKET SET
 Replaces: 432570

— CONTAINS —

Part #	Desc.	O.E. #	Qty.
18-0987	Throttle Body to Manifold Gasket	332319	2
18-0142	Intake Manifold Gasket	328622	1
18-2074	Seal	0339620	1
18-2075	Seal	0353076	1
18-0130	Reed Box Gasket	332266	4
18-7418	O-Ring	325741	4
18-0155	Rectifier Mtg. Gasket	330412	1
18-3866	Head Gasket	328623, 340115	2
18-0138	Adapter to Powerhead Gasket	328590	1
18-0144	Reed Box Gasket	328626	4
18-1221	Retainer	330273	2
18-1219	Grommet	320880	2
18-1222	Thermostat Gasket	394408	2

— CONTAINS —

Part #	Desc.	O.E. #	Qty.
18-0130	Reed Box Gasket	332266	6
18-3839	Head Gasket	334726, 333670	2
18-0161	Lower Manifold Gasket	331532	1
18-0155	Rectifier Mtg. Gasket	330412	1
18-0142	Intake Manifold Gasket	328622	1
18-0987	Throttle Body to Manifold Gasket	332319	3
18-0978	Cover to Base Gasket	331598	1
18-0965	Adapter to Powerhead Gasket	333879	1
18-7416	O-Ring	326741	4
18-2074	Seal	0339620	1
18-2075	Seal	0353076	2
18-1222	Thermostat Gasket	394408	2
18-1221	Retainer	330273	2
18-1219	Grommet	320880	2
18-0412	Thermostat Gasket	337068	2

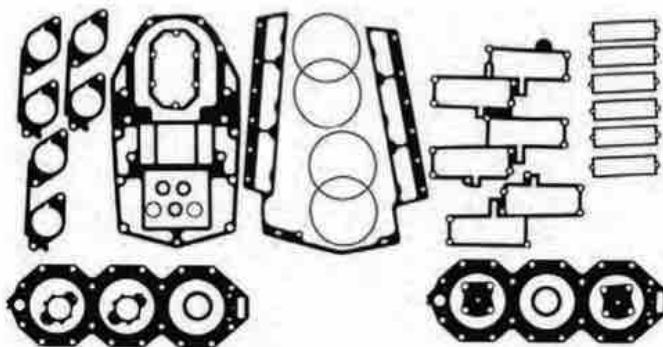

18-4323
POWERHEAD GASKET SET
Replaces: 436891

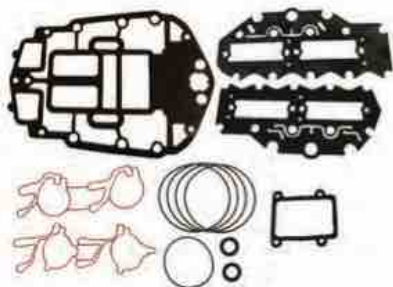

18-4402
POWERHEAD GASKET SET
Replaces: 437779; 439559
Fits: 90 V4 60 degree (1995-00), 115 V4 60 degree (1995-00)

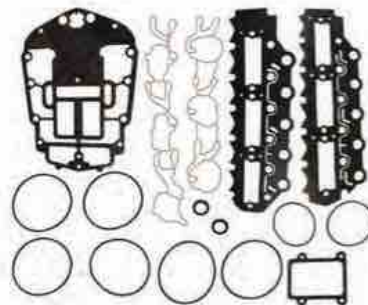

18-4406
POWERHEAD GASKET SET
Replaces: 437155
Fits: 150 60 degree (1991-00), 175 60 degree (1991-00)

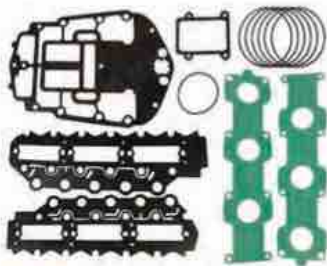

18-4420
POWERHEAD GASKET SET
Replaces: 439202
Fits: 150 Ficht FFI, 175 Ficht FFI

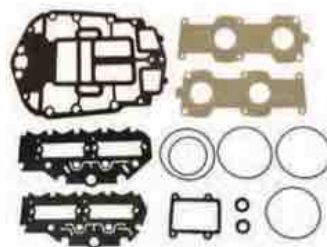

18-4421
POWERHEAD GASKET SET
Replaces: 5000400
Fits: 90 Ficht FFI, 115 Ficht FFI, 135 Ficht FFI



18-4428
POWERHEAD GASKET SET
Replaces: 437725
Fits: 200 BB (1993 & Up), 225 BB (1993 & Up), 225 Ficht FFI (1999 & Up), 250 Carb only (2000)

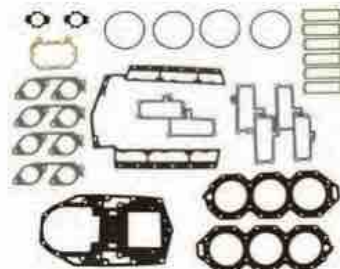

18-4429
POWERHEAD GASKET SET
Fits: 200 Ficht FFI (1999-01), 225 (2000-04), 250 (2000-04), 3.3L (2000-04)

PKG. OF 2



18-2884
18-2884-9^①
HEAD GASKET
Replaces: 313782

PKG. OF 2



18-2885
18-2885-9^①
HEAD GASKET
Replaces: 303438

PKG. OF 2



18-2888
18-2888-9^①
HEAD GASKET
Replaces: 332010, 326953



18-2950
HEAD GASKET
Replaces: 309612, 766870



18-2951
HEAD GASKET
Replaces: 304720



18-2952
HEAD GASKET
Replaces: 203034



18-2954
HEAD GASKET
Replaces: 319633



18-2956
HEAD GASKET
Replaces: 318358



18-2957
HEAD GASKET
Replaces: 307069



18-2958
HEAD GASKET
Replaces: 315539



18-2959
HEAD GASKET
Replaces: 306048



18-2960
HEAD GASKET
Replaces: 313413



18-2961
HEAD GASKET
Replaces: 329103



















18-2962
HEAD GASKET
Replaces: 322332



18-2963
HEAD GASKET
Replaces: 330818, 320533, 318914

① Priced per Package

 <p>18-2964 HEAD GASKET Replaces: 320745, 335360, 766779</p>	 <p>18-3800 HEAD GASKET Replaces: 325273</p>	 <p>18-3801 HEAD GASKET Replaces: 325647, 335361</p>
 <p>18-3802 HEAD GASKET Replaces: 320658, 327795, 335359</p>	 <p>18-3803 HEAD GASKET Replaces: 324324, 329419, 765012 For: 2 cylinder models only</p>	 <p>18-3836 HEAD GASKET Replaces: 329836</p>
 <p>18-3837 HEAD GASKET Replaces: 329623</p>	 <p>18-3838 HEAD GASKET Replaces: 331211</p>	 <p>18-3839 HEAD GASKET Replaces: 333670, 334726</p>
 <p>18-3841-2 HEAD GASKET Replaces: 203130</p>	 <p>18-3898 HEAD GASKET Replaces: 332819</p>	 <p>18-3866 HEAD GASKET Replaces: 340115, 333549 For: V-4 Loop Charge</p>
 <p>18-3895 HEAD GASKET Replaces: 332816</p>	 <p>18-3896 HEAD GASKET Replaces: 332817</p>	 <p>18-0491 HEAD GASKET Replaces: 346007 Fits: 200 Ficht FFI (1999-01), 225 (2000-04), 250 (2000-04), 3.3L (2000-04)</p>
 <p>18-0492 HEAD GASKET Replaces: 340919, 345257 Fits: 200 BB (1993 & Up), 225 BB (1993 & Up), 225 Ficht FFI (1999 & Up) 250 Carb only (2000)</p>	<p>PKG. OF 12</p>  <p>18-7110 18-7110-9 CYLINDER HEAD O-RING Replaces: 335523 3.960 O.D. x 0.103 H Fits: 90/115 HP (1995-98), 100 HP (1998), 105 HP (1997-98), 150/175 HP (1991-97) 90 Ficht FFI, 115 Ficht FFI, 135 Ficht FFI, 150 Ficht FFI, 175 Ficht FFI, 90 V4 60 degree(1995-00), 115 V4 60 degree (1995-00), 150 60 degree(1991-00), 175 60 degree(1991-00)</p>	

① Priced per Package

APPLICATION BEGINS ON NEXT PAGE

HEAD GASKET/GASKET SET APPLICATION

HP	Year	Head Gasket	Low Comp. Head Gasket	Gasket Set	HP	Year	Head Gasket	Low Comp. Head Gasket	Gasket Set
1.5	1968-70	18-2884	—	—	85 Comm.	1987-95	18-3836	—	18-4321
2, Colt, Jr.	1971-90	18-2884	—	—	65 Jet	1991-95	18-2956 ①	18-3898 ①	18-4303-1
2.5,3,4,4.5, Ultra, Excel 4	1981-93	18-2888	—	—	70	1974-76	18-2960	18-3895	18-4300 ②
3	1957-68	18-3841-2	—	—	70	1977-85	18-2960	18-3895	18-4302
4	1969-80	18-3841-2	—	—	75	1986-97	18-3836	—	18-4321
4.5	1980	18-3841-2	—	—	75	1960-65	18-2959 ①	—	—
5	1965-68	18-2961	—	—	75	1975	18-2960	18-3895	18-4300 ②
5	1984-95	18-3800	—	—	75	1977-88	18-2960	18-3895	18-4302
5.5	1957-58	18-2885	—	—	80	1966-67	18-2959 ①	—	—
5.5	1959-64	18-2961	—	—	80 Jet	1991-96	18-2956 ①	18-2956 ①	18-4303-1
6	1965-79	18-2961	—	—	85	1968-72	18-2959 ①	—	—
6	1984-95	18-3800	—	—	85	1979-80,91-95	18-2958 ①	18-3898 ①	18-4303-1
6.5 Comm.	1989-90	18-3800	—	—	88	1987-95	18-2956 ①	18-3898 ①	18-4303-1
7.5	1957-58	18-2952	—	—	90	1964-65	18-2959 ①	—	—
7.5	1980-93	18-3800	—	—	90	1981-95	18-2956 ①	18-3898 ①	18-4303-1
8	1984-95	18-3800	—	—	100	1966-72	18-2959 ①	—	—
9.5	1964-73	18-2950	—	—	100 ③	1979-95	18-2956 ①	18-3898 ①	18-4303-1
9.9	1974-92	18-2963	—	18-4306 ②	1600CC	1988	18-2956 ①	18-3898 ①	18-4303-1
10 Comm.	1989-90	18-2963	—	18-4306	110	1986-89	18-2956 ①	18-3898 ①	18-4303-1
14	1988-90	18-2963	—	18-4306	115	1969-70	18-2959 ①	—	—
15	1974-92	18-2963	—	18-4306 ④	115	1973-77	18-2956 ①	18-3898 ①	—
18	1959-73	18-2962	—	—	115	1978-95	18-2956 ①	18-3898 ①	18-4303-1
18 Jet	1995-98	18-3803	—	18-4307	120	1985-87	18-3837 ①	—	18-4310
20	1981-99	18-3803	—	18-4307	120	1988-94	18-3866 ①	—	18-4322
25	1969-76	18-2962	—	—	125 Comm.	1992-95	18-3866 ①	—	18-4322
25	1977-78	18-2954	—	—	130	1995-98	18-3866 ①	—	18-4322
25 ⑤	1979-03	18-3803	—	18-4307	135	1973-76	18-2956 ①	18-3898 ①	18-4301
28	1986-96	18-3803	—	18-4307	140	1977	18-2956 ①	18-3898 ①	18-4301
30 ⑤	1984-03	18-3803	—	18-4307	140	1978-84	18-2956 ①	18-3898 ①	18-4303-1
33	1965-70	18-2951	—	—	140	1985-87	18-3837 ①	—	18-4310
35	1957-58	18-2951	—	—	140	1988-94	18-3866 ①	—	18-4322
35	1976-78	18-2954	—	—	150	1973-91	18-2964 ①	18-3896 ①	18-4304-1
35	1979-88	18-3803	—	18-4307	155 Comm.	1984-92	18-2964 ①	18-3896 ①	18-4304-1
35 ⑥	1987	18-3802	—	18-4305	2500CC	1988	18-2964 ①	18-3896 ①	18-4304-1
40	1960-80	18-2957	—	—	175	1977-83	18-2964 ①	18-3896 ①	18-4304-1
40 Comm.	1981-90	18-2957	—	18-4324	175	1986-91	18-3801 ①	18-3897 ①	18-4309
40	1984-97	18-3802	—	18-4305	185	1984-85	18-2964 ①	18-3896 ①	18-4304-1
40 Comm.	1994-97	18-3802	—	18-4305	185	1990-93	18-3839 ①	—	18-4323
45 Comm.	1985-97	18-3802	—	18-4305	200	1976-83	18-2964 ①	18-3896 ①	18-4304-1
45SS	1987-90	18-3802	—	—	200	1986-87	18-3838 ①	—	—
48	1987-97	18-3802	—	18-4305	200 ③	1988-93	18-3839 ①	—	18-4323
50	1958-59	—	—	—	225	1986-87	18-3838 ①	—	—
50	1971-75	18-2958	—	18-4305 ⑦	225	1988-93	18-3839 ①	—	18-4323
50	1979-80	18-3802	—	18-4318	235	1978-79	18-2964 ①	18-3896 ①	—
50	1981-97	18-3802	—	18-4305	235	1980-85	18-3801 ①	18-3897 ①	18-4309
55	1968-69	18-2960	18-3895	—	275/3.6L	1985-87	18-3840 ①	—	—
55	1977-79	18-3802	—	18-4318	OMC SEA DRIVE				
55	1980-97	18-3802	—	18-4305	HP	Year	Head Gasket	Low Comp. Head Gasket	Gasket Set
55	1995	18-3802	—	—	1.6L	1983-90	18-2956	18-3898 ①	18-4303-1
60	1970-71	18-2960	18-3895	—	1.8L	1987	18-3837	-	-
60	1980-85	18-3802	—	18-4305	2.0L	1988-90	18-3866 ①	-	18-4322
60	1986-88	18-2960	18-3895	18-4302	2.5L	1982,84-85	18-2964	18-3896 ①	18-4304-1
60	1989-97	18-3836	—	18-4321	2.6L	1982-86	18-3801 ①	18-3897 ①	-
SST60	1989-90	18-3836	—	—	2.7L	1987	18-3838	-	-
65	1968	—	—	—	3.0L	1988-90	18-3839	-	-
65	1972-73	18-2960	18-3895	18-4300 ⑧	3.6L	1987	18-3840	-	-
65 Comm.	1984-86	18-2960	—	18-4302					

① Two head gaskets required per engine
 ② 1976 G & H Suffix models only
 ③ Commercial models also

④ 1976 A Suffix models only
 ⑤ For 2 cylinder models only
 ⑥ D Suffix models only

⑦ 18-2958 Head Gasket required to complete set
 ⑧ Head Gasket Not Available in Gasket Set

STAINLESS STEEL BOLTS



HEX WASHER



HEX







HEAD STYLES



PAN



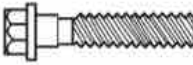

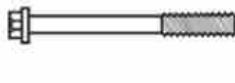

















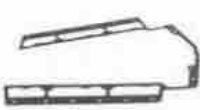
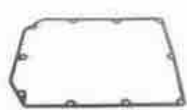

FILLISTER

 18-3133 Replaces: 331979 1/4" x 20 x 1 1/16" HEX For: Rewind starters, water pump housings, mid-sections and jet drive units	PKG. OF 2  18-3135 18-3135-9 Ⓢ Replaces: 306643 1/4" x 20 x 1/4" PAN HEAD For: Lower unit anodes, ignition covers and water pump housings	PKG. OF 2  18-3136 18-3136-9 Ⓢ Replaces: 323626 1/4" x 20 x 1 1/4" HEX WASHER For: Water pump housings, exhaust covers, intake manifolds, ignition coils and more	 18-3153 Replaces: 908158 1/4" x 20 x 1/4" HEX For: Lower unit anodes, bearing carriers, 45 HP and up and Cobra, 5 HP lower engine covers
 18-3365 Replaces: 909533 1/4" x 20 x 1" HEX WASHER For: Flywheel covers, intake covers and more	 18-3369 Replaces: 302325 1/4" x 20 x 1" HEX For: Impeller housings, ignition coils, exhaust covers, shift covers and starter brackets	PKG. OF 5  18-4276 18-4276-9 Ⓢ Replaces: 324334 1/4" x 20 x 1 1/2" HEX WASHER For: Water pump housings, exhaust covers, intake manifolds, ignition coils and more	PKG. OF 5  18-4277 Replaces: 324430 1/4" x 20 x 2" HEX For: Water pump housings, exhaust covers, intake manifolds, ignition coils and more

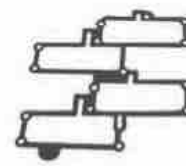
SEE PAGES 219 FOR OUR COMPLETE LINE OF GASKET SEALANTS























PKG. OF 2  18-0118 18-0118-9 Ⓢ CARB GASKET Replaces: 325092	PKG. OF 2  18-0134 18-0134-9 Ⓢ V-4 & V-6 CARB TO MANIFOLD GASKET Replaces: 327707	PKG. OF 2  18-0961 18-0961-9 Ⓢ CARB MOUNTING GASKET Replaces: 318932	 18-0437 COVER GASKET Replaces: 334353	 18-0628 COVER GASKET Replaces: 341501
 18-1241 FLOAT BOWL AND NOZZLE GASKET	 18-2579 FLOAT BOWL GASKET Replaces: 338882	 18-2582 CARB BOWL GASKET Replaces: 338813	 18-8352 CARBURETOR MOUNTING GASKET Replaces: 332253	PKG. OF 2  18-2890 18-2890-9 Ⓢ FLOAT BOWL GASKET Replaces: 331203, 338886, 302994
PKG. OF 2  18-2893 18-2893-9 Ⓢ FLOAT BOWL GASKET Replaces: 303750	PKG. OF 2  18-2903 18-2903-9 Ⓢ FLOAT BOWL GASKET Replaces: 332696, 338880	PKG. OF 2  18-2906 18-2906-9 Ⓢ FLOAT BOWL GASKET Replaces: 333418, 333884, 338884 V-4, V-6	PKG. OF 2  18-2908 18-2908-9 Ⓢ FLOAT BOWL GASKET Replaces: 331499, 338878	PKG. OF 2  18-0850 18-0850-9 Ⓢ FUEL PUMP GASKET Replaces: 303615

Ⓢ Priced per package

<p>PKG. OF 2</p>  <p>18-2879 18-2879-9① FILTER CAP TO PUMP GASKET Replaces: 331363, 336876, 312634</p>	<p>PKG. OF 2</p>  <p>18-2900 18-2900-9① CAP TO FUEL PUMP GASKET Replaces: 332694, 338879, 312679</p>	<p>PKG. OF 2</p>  <p>18-2889 18-2889-9① FILTER BOWL GASKET Replaces: 302675</p>	<p>PKG. OF 2</p>  <p>18-2892 18-2892-9① FILTER BOWL GASKET Replaces: 303355</p>	 <p>18-0140 AIR BOX GASKET Replaces: 328604</p>
 <p>18-0157 AIR BOX GASKET Replaces: 330698</p>	 <p>18-0159 AIR BOX GASKET Replaces: 330909</p>	 <p>18-0933 AIR SILENCER GASKET Replaces: 314115 70/75 HP</p>	 <p>18-0935 BASE TO COVER GASKET Replaces: 314322 70/75 HP</p>	<p>PKG. OF 2</p>  <p>18-0975 18-0975-9① CARB TO SILENCER GASKET Replaces: 333008 3 Cyl.</p>
 <p>18-0978 COVER TO BASE GASKET Replaces: 331598 For: 185, 200 & 225 H.P., V-6</p>	 <p>18-0979 AIR SILENCER GASKET Replaces: 321183 V-6</p>	<p>PKG. OF 2</p>  <p>18-0983 18-0983-9① CARB TO AIR BOX TWIN GASKET Replaces: 321497</p>	 <p>18-0985 AIR SILENCER GASKET Replaces: 321722 V-4</p>	 <p>18-0989 AIR SILENCER GASKET Replaces: 321794 3 Cyl.</p>
<p>PKG. OF 2</p>  <p>18-2857 18-2857-9① AIR SILENCER GASKET Replaces: 386573, 319771</p>	<p>PKG. OF 2</p>  <p>18-0122 18-0122-9① 9.9 & 15 HP OUTER LEAFPLATE GASKET Replaces: 325260</p>	<p>PKG. OF 2</p>  <p>18-0130 18-0130-9① REED BLOCK GASKET Replaces: 332266 For: V-4, V-6 & V-8</p>	 <p>18-0142 INTAKE MANIFOLD GASKET Replaces: 328622</p>	<p>PKG. OF 2</p>  <p>18-0144 18-0144-9① REED BLOCK GASKET Replaces: 328626 For: 120-140 H.P. V-4</p>
 <p>18-0148 INTAKE MANIFOLD GASKET Replaces: 329718 V-6</p>	 <p>18-0161 LOWER MANIFOLD GASKET Replaces: 331532 For: V-6</p>	<p>PKG. OF 2</p>  <p>18-0959 18-0959-9① INNER LEAF PLATE GASKET Replaces: 318924 9.9 & 15 HP</p>	<p>PKG. OF 2</p>  <p>18-0963 18-0963-9① INTAKE MANIFOLD TWIN GASKET Replaces: 335633</p>	

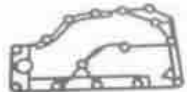
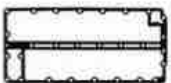

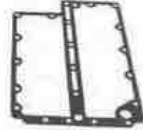









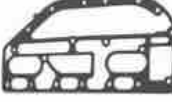

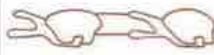



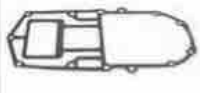





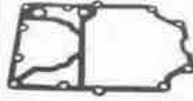

SEE PAGE 219 FOR OUR COMPLETE LINE OF GASKET SEALANTS

① Priced per package

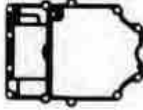
<p>PKG. OF 2</p>  <p>18-0981 18-0981-9① LEAF PLATE GASKET Replaces: 321479 25 & 35 HP</p>	<p>PKG. OF 2</p>  <p>18-0987 18-0987-9① THROTTLE BODY TO MANIFOLD GASKET Replaces: 332319</p>	<p>PKG. OF 2</p>  <p>18-0991 18-0991-9① LEAF PLATE GASKET Replaces: 321907 V-4/V-6</p>	<p>PKG. OF 2</p>  <p>18-0973 18-0973-9① CARB GASKET Replaces: 315052 V-4 Carburetor mounting includes: 100, 115, 125, 135, 140, 150, 175, 200, 235(1977-79), 85 (1989-79)</p>	 <p>18-1212 INTAKE MANIFOLD GASKET Replaces: 326926 For: 3 cyl.</p>
<p>PKG. OF 2</p>  <p>18-2862 18-2862-9① LEAF PLATE GASKET Replaces: 321573, 326260 25/35 HP</p>	<p>PKG. OF 2</p>  <p>18-2867 18-2867-9① MANIFOLD TO CRANKCASE GASKET Replaces: 319174 For: V-4</p>	 <p>18-0102 EXHAUST MANIFOLD GASKET Replaces: 323469 V-4</p>	<p>PKG. OF 2</p>  <p>18-0106 18-0106-9① EXHAUST MANIFOLD GASKET Replaces: 324323 25/35</p>	 <p>18-0117 EXHAUST PLATE GASKET Replaces: 317955 V-4</p>
 <p>18-0120 EXHAUST PLATE GASKET Replaces: 325211</p>	<p>PKG. OF 2</p>  <p>18-0126 18-0126-9① INNER EXHAUST COVER GASKET Replaces: 326264</p>	 <p>18-0927 INNER EXHAUST COVER GASKET 235 HP Replaces: 393561</p>	<p>PKG. OF 2</p>  <p>18-0999-9① INNER EXHAUST GASKET Replaces: 323459 V-4</p>	 <p>18-0945 OUTER EXHAUST GASKET Replaces: 336430, 323217</p>
 <p>18-0955 EXHAUST COVER GASKET Replaces: 318156 V-4</p>	 <p>18-1207 EXHAUST MANIFOLD GASKET Replaces: 329833, 343863</p>	 <p>18-1218 EXHAUST COVER GASKET Replaces: 315868</p>	 <p>18-1224 EXHAUST COVER GASKET Replaces: 315869</p>	<p>PKG. OF 2</p>  <p>18-2545 18-2545-9① EXHAUST PLATE GASKET Replaces: 321182 V-6</p>
<p>PKG. OF 2</p>  <p>18-2549 18-2549-9① EXHAUST COVER GASKET Replaces: 321435 V-6</p>	<p>PKG. OF 2</p>  <p>18-2853 18-2853-9① EXHAUST COVER GASKET Replaces: 318925 9,9/15 HP</p>	<p>PKG. OF 2</p>  <p>18-2866 18-2866-9① EXHAUST COVER GASKET Replaces: 317914 V-4</p>	<p>PKG. OF 2</p>  <p>18-2871 18-2871-9① EXHAUST COVER GASKET Replaces: 304762</p>	



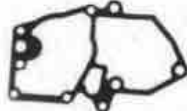

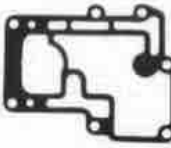
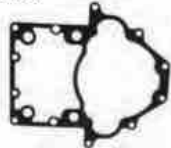



















SEE PAGE 219 FOR OUR COMPLETE LINE OF GASKET SEALANTS

① Priced per package

<p>PKG. OF 2</p>  <p>18-2886 18-2886-9① COVER PLATE GASKET Replaces: 203171</p>	<p>PKG. OF 2</p>  <p>18-2913 18-2913-9① EXHAUST COVER GASKET Replaces: 331916, 319097 3 Cyl.</p>	<p>PKG. OF 2</p>  <p>18-2938 18-2938-9① EXHAUST COVER GASKET Replaces: 331917 3 Cyl.</p>	 <p>18-1283 MOLDED INTAKE PORT GASKET Replaces: 335818 For: V6 60° Eagle series 90-115HP (1995-00)</p>	 <p>18-1284 MOLDED INTAKE PORT GASKET Replaces: 335819 For: V6 60° Eagle series 90-115HP (1995-00)</p>
 <p>18-1285 MOLDED INTAKE PORT GASKET Replaces: 335403 For: V6 60° Eagle series 150-175HP (1991-00)</p>	 <p>18-0112 POWERHEAD BASE GASKET Replaces: 324717 9.9 & 15 HP</p>	 <p>18-0128 POWERHEAD BASE GASKET Replaces: 326468, 351018</p>	 <p>18-0136 POWERHEAD BASE GASKET Replaces: 328283</p>	 <p>18-0138 POWERHEAD BASE GASKET Replaces: 328590</p>
 <p>18-0690 BASE GASKET Replaces: 347205 Fits: 200 BB (1993 & Up), 200 Ficht FFI (1999-01), 225 BB (1993 & Up), 225 Ficht FFI (1999 & Up), 225 (2000-04), 250 Carb only (2000), 250 (2000-04), 3.3L (2000-04)</p>	 <p>18-0691 BASE GASKET Fits: 150 Ficht FFI, 175 Ficht FFI</p>	 <p>18-0692 BASE GASKET Replaces: 339601 Fits: 90 V4 60 degree (1995-00), 90 Ficht FFI, 1150V4 60 degree (1995-00), 115 Ficht FFI, 135 Ficht FFI, 150 60 degree (1991-00), 175 60 degree (1991-00)</p>	 <p>18-0693 INTAKE GASKET Replaces: 336226 Fits: 135(2005-06), 150(1991-98), 150(1991-06), 175(1991-06)</p>	 <p>18-0694 INTAKE GASKET Replaces: 336227 Fits: 135(2005-06), 150(1991-05), 175(1991-05)</p>
 <p>18-0695 INTAKE GASKET Replaces: 336389 Fits: 90(1995-06), 115(1995-06), 100(1998-01, 2005)</p>	 <p>18-0696 INTAKE GASKET Replaces: 336388 Fits: 90(1995-06), 100(1998-01, 2005), 115(1995-06)</p>	 <p>18-0957 POWERHEAD BASE GASKET Replaces: 318373</p>	 <p>18-0965 ADAPTER OUTER POWERHEAD GASKET Replaces: 333879</p>	 <p>18-0995 POWERHEAD BASE GASKET Replaces: 323222 V-6</p>
<p>PKG. OF 2</p>  <p>18-1205 18-1205-9① ADAPTER COVER GASKET Replaces: 329828</p>	<p>PKG. OF 2</p>  <p>18-2550 18-2550-9① POWERHEAD BASE GASKET Replaces: 323214 V-6</p>	<p>PKG. OF 2</p>  <p>18-2852 18-2852-9① POWERHEAD BASE GASKET Replaces: 330621 25/35 HP</p>	<p>PKG. OF 2</p>  <p>18-2864 18-2864-9① POWERHEAD BASE GASKET Replaces: 321727 V-4</p>	<p>PKG. OF 2</p>  <p>18-2865 18-2865-9① POWERHEAD BASE GASKET Replaces: 313763 3 Cyl.</p>
<p>PKG. OF 2</p>  <p>18-2868 18-2868-9① POWERHEAD BASE GASKET Replaces: 310137 35/40 HP</p>	<p>PKG. OF 2</p>  <p>18-2877 18-2877-9① BAFFLE GASKET Replaces: 314421 18/25 HP</p>	<p>PKG. OF 2</p>  <p>18-2878 18-2878-9① BAFFLE GASKET Replaces: 319710 25/35</p>	<p>PKG. OF 2</p>  <p>18-2894 18-2894-9① EXHAUST HOUSING GASKET Replaces: 304314</p>	<p>PKG. OF 2</p>  <p>18-2898 18-2898-9① POWERHEAD BASE GASKET Replaces: 309956 V-4</p>

SEE PAGE 219 FOR OUR COMPLETE LINE OF GASKET SEALANTS

① Priced per package

<p>PKG. OF 2</p>  <p>18-2901 18-2901-9^① EXHAUST HOUSING GASKET Replaces: 313065, 306205 5, 5.5, 6 HP</p>	<p>PKG. OF 2</p>  <p>18-2904 18-2904-9^① EXHAUST PLATE GASKET Replaces: 319348 28, 33, 40 HP</p>	<p>PKG. OF 2</p>  <p>18-2907 18-2907-9^① EXHAUST HOUSING GASKET Replaces: 325721</p>	<p>PKG. OF 2</p>  <p>18-0967 18-0967-9^① BYPASS COVER GASKET Replaces: 319332 9.9 & 15 HP.</p>	<p>18-0971 BYPASS GASKET Replaces: 319661 25 & 35 HP</p>
<p>PKG. OF 2</p>  <p>18-2876 18-2876-9^① BYPASS COVER GASKET Replaces: 307133</p>	<p>PKG. OF 2</p>  <p>18-0941 WATER JACKET GASKET Replaces: 315538 50/55 HP</p>	<p>PKG. OF 2</p>  <p>18-2543 18-2543-9^① WATER JACKET GASKET Replaces: 318609 3 Cyl.</p>	<p>PKG. OF 2</p>  <p>18-0892 DEFLECTOR HOSE Replaces: 322411</p>	<p>PKG. OF 2</p>  <p>18-2544 18-2544-9^① WATER JACKET GASKET Replaces: 321028 V-6</p>
<p>PKG. OF 2</p>  <p>18-2856 18-2856-9^① WATER JACKET GASKET Replaces: 319665 25/35 HP</p>	<p>PKG. OF 2</p>  <p>18-3899 WATER COVER GASKET Replaces: 327674 For: 20, 25, 25C, 30, 35</p>	<p>PKG. OF 2</p>  <p>18-2872 18-2872-9^① WATER JACKET GASKET Replaces: 307257, 318334 V-4</p>	<p>PKG. OF 2</p>  <p>18-2873 18-2873-9^① WATER JACKET GASKET Replaces: 318335 V-4</p>	<p>PKG. OF 2</p>  <p>18-2905 18-2905-9^① WATER COVER GASKET Replaces: 329920 9.9, 15 HP</p>
<p>PKG. OF 2</p>  <p>18-3360 IMPELLER HOUSING GASKET Replaces: 329390 20-25 HP</p>	<p>PKG. OF 2</p>  <p>18-0182 18-0182-9^① THERMOSTAT GASKET Replaces: 310058</p>	<p>PKG. OF 2</p>  <p>18-0397 THERMOSTAT GASKET Replaces: 318917</p>	<p>PKG. OF 2</p>  <p>18-0412 18-0412-9^① THERMOSTAT GASKET Replaces: 337068</p>	<p>PKG. OF 2</p>  <p>18-0441 18-0441-9^① THERMOSTAT GASKET Replaces: 329076</p>
<p>PKG. OF 2</p>  <p>18-0929 18-0929-9^① THERMOSTAT GASKET Replaces: 313416 3 Cyl.</p>	<p>PKG. OF 2</p>  <p>18-0675 THERMOSTAT GASKET Replaces: 321932 V-4</p>	<p>PKG. OF 2</p>  <p>18-0977 18-0977-9^① THERMOSTAT GASKET Replaces: 332369 V-4</p>	<p>PKG. OF 2</p>  <p>18-1202 18-1202-9^① THERMOSTAT GASKET Replaces: 329830</p>	<p>PKG. OF 2</p>  <p>18-1222 THERMOSTAT GASKET Replaces: 394408</p>

























SEE PAGE 219 FOR OUR COMPLETE LINE OF GASKET SEALANTS

① Priced per package

<p>PKG. OF 2</p>  <p>18-2547 18-2547-9① WATER PASSAGE GASKET Replaces: 322858 V-4/V-6</p>	<p>PKG. OF 2</p>  <p>18-2548 18-2548-9① THERMOSTAT GASKET Replaces: 332108 3 Cyl.</p>	<p>PKG. OF 2</p>  <p>18-2546 18-2546-9① THERMOSTAT GASKET Replaces: 321184 V-6</p>	<p>PKG. OF 2</p>  <p>18-0124 18-0124-9① IMPELLER PLATE GASKET Replaces: 325537</p>	
<p>PKG. OF 2</p>  <p>18-0445 18-0445-9① WATER PUMP GASKET Replaces: 323312 35HP</p>	<p>PKG. OF 2</p>  <p>18-0969 18-0969-9① IMPELLER HOUSING GASKET Replaces: 319586</p>	<p>PKG. OF 5</p>  <p>18-2536 IMPELLER HOUSING SEAL Replaces: 321120 V-4, V-6</p>	<p>PKG. OF 5</p>  <p>18-2539 18-2539-9① RUBBER SEAL Replaces: 328753</p>	<p>PKG. OF 2</p>  <p>18-2557 18-2557-9① IMPELLER GASKET Replaces: 324701, 338484 V-4, V-6, V-8</p>
<p>PKG. OF 2</p>  <p>18-2709 18-2709-9① WEAR PLATE GASKET Replaces: 336530</p>	<p>PKG. OF 2</p>  <p>18-0679 THERMOSTAT GASKET Replaces: 311145</p>	<p>PKG. OF 2</p>  <p>18-7428 18-7428-9① O-RING Replaces: 307103</p>	<p>PKG. OF 2</p>  <p>18-7481 18-7481-9① O-RING Replaces: 324981</p>	<p>PKG. OF 2</p>  <p>18-0155 18-0155-9① RECTIFIER MOUNTING GASKET Replaces: 330412</p>
<p>PKG. OF 2</p>  <p>18-0851 18-0851-9① RELIEF GASKET Replaces: 329826</p>	<p>PKG. OF 2</p>  <p>18-0953 18-0953-9① WATER PASSAGE GASKET Replaces: 317951 V-4/V-6</p>	<p>PKG. OF 2</p>  <p>18-0110 18-0110-9① SHIFT HOUSING GASKET Replaces: 324670</p>	<p>PKG. OF 2</p>  <p>18-0313 SHIFT ROD GASKET Replaces: 352165 For: E-Tec 75/90/115/150/175/200/225/250 HP</p>	<p>PKG. OF 2</p>  <p>18-0882 18-0882-9① SHIFT ROD GASKET Replaces: 304764</p>
<p>PKG. OF 2</p>  <p>18-2855 18-2855-9① SHIFT HOUSING GASKET Replaces: 314082</p>	<p>PKG. OF 2</p>  <p>18-2874 18-2874-9① SOLENOID COVER GASKET Replaces: 314876 V-4</p>	<p>PKG. OF 2</p>  <p>18-2880 18-2880-9① COVER PLATE GASKET Replaces: 304023</p>	<p>PKG. OF 2</p>  <p>18-0108 18-0108-9① LOWER GEAR CASE GASKET Replaces: 324449</p>	

SEE PAGE 219 FOR OUR COMPLETE LINE OF GASKET SEALANTS

① Priced per package

 <p>18-0540 EXHAUST LEG RUBBER SEAL Replaces: 320936</p>	<p>PKG. OF 2</p>  <p>18-0949 TRUNION CAP GASKET Replaces: 316499</p>	 <p>18-2537 EXHAUST SEAL LEG Replaces: 324937</p>	<p>PKG. OF 2</p>  <p>18-2869 18-2869-9① EXHAUST HOUSING GASKET Replaces: 305312</p>	<p>PKG. OF 2</p>  <p>18-2891 18-2891-9① BEARING HOUSING GASKET Replaces: 303339 6HP</p>
 <p>18-8353 OIL SEAL Replaces: 320961</p>	 <p>18-1219 GROMMET Replaces: 320880</p>	 <p>18-2389 GROMMET Replaces: 314832</p>	 <p>18-2391 GROMMET Replaces: 321692</p>	 <p>18-2392 GROMMET Replaces: 327035</p>
<p>PKG. OF 2</p>  <p>18-2703 18-2703-9① GROMMET Replaces: 314008</p>	 <p>18-2704 GROMMET Replaces: 320943</p>	<p>PKG. OF 2</p>  <p>18-2706 18-2706-9① GROMMET Replaces: 321008</p>	<p>PKG. OF 2</p>  <p>18-2708 GROMMET Replaces: 333758</p>	 <p>18-3329 GROMMET Replaces: 302497 9.9-35 HP</p>
 <p>18-3332 GROMMET Replaces: 304026</p>	 <p>18-3337 GROMMET Replaces: 315837 40-50 HP</p>	<p>PKG. OF 2</p>  <p>18-1221 18-1221-9① RETAINER GASKET Replaces: 330273</p>	 <p>18-2532 GEARCASE COVER SEAL Replaces: 305762 2 Cyl.</p>	 <p>18-2534 SEAL 40" Replaces: 309044 Material equivalent to that of O.E. spool # 309044 0.1005 O.D.</p>
 <p>18-7963 O-RING Replaces: 331353</p>	<p>PKG. OF 2</p>  <p>18-2705 18-2705-9① OIL SEAL Replaces: 315748</p>	<p>PKG. OF 2</p>  <p>18-2769 18-2769-9① RUBBER SEAL Replaces: 332000</p>	<p>PKG. OF 2</p>  <p>18-0917 TILT MOTOR GASKET Replaces: 311508</p>	 <p>18-8372 MOLDED SEAL Replaces: 323582 For: 5 & 7.5 HP (1978-83) Outboards</p>

SEE PAGE 219 FOR OUR COMPLETE LINE OF GASKET SEALANTS

① Priced per package

PKG. OF 2



18-2881
18-2881-9④
HOUSING TO TANK GASKET
 Replaces: 332403, 125530
 For: 6 Gallon Fuel Tank

PKG. OF 2



18-2887
18-2887-9④
FUEL TANK GASKET
 Replaces: 302557



18-1704
SCREW
 Replaces: 331980
 For: Waterpumps, power packs (1985-96)



18-4904
STARTER HANDLE & ROPE
 (Uses 9/64" Rope)
 Handle Only: **18-4901**

STARTER ROPE

18-4911
 5/32" x 200'
 Replaces: 322236, 772577

18-4913
 3/16" x 200'
 Replaces: 316705, 772578

18-4914
 1/8" x 200'
 Replaces: 316706, 772579



18-1505
STARTER GEAR
 Replaces: 318940
 For: 9.9 - 15HP
 (1974-1992)



18-6501
REWIND SPRING
 Replaces: 395460, 307573



18-6503
REWIND SPRING
 Replaces: 318944



18-6509
REWIND SPRING
 Replaces: 326877



18-6511
REWIND SPRING
 Replaces: 312932



18-6522
REWIND SPRING
 Replaces: 323653, 338534

H.P.	YEARS	REWIND SPRING
2	1969-80	18-6511
3	1954-68	18-6501
4 ①	1969-92	18-6511
4 ②	1969-80	18-6511
4 ③	1981-92	18-6509
① 1992 4D Models only ② Except 4D		

H.P.	YEARS	REWIND SPRING
4.5	1980-90	18-6511
5.5	1954-68	18-6501
7.5	1954-68	18-6501
9.9	1980-92	18-6522
9.9	1974-78	18-6503
10	1980-92	18-6522
③ All 4D		

H.P.	YEARS	REWIND SPRING
10	1950-63	18-6501
12	1980-92	18-6522
12	1956-68	18-6501
15	1979-92	18-6522
15	1956-68	18-6501
15	1974-78	18-6503

H.P.	YEARS	REWIND SPRING
18	1968-73	18-6501
20	1956-73, 85-97	18-6501
28	1969-92	18-6501
25	1969-05	18-6501
30	1984-05	18-6501
35	1976-94	18-6501

PKG. OF 3



18-6513
18-6513-9④
STARTER PAWL
 Replaces: 203698

PKG. OF 2



18-6512
18-6512-9④
STARTER PAWL
 Replaces: 330525

HP	Years	Pawl	HP	Years	Pawl	HP	Years	Pawl
2	1971-88	18-6513	18	1957-73	18-6513	30	1984-90	18-6512
Jr/Colt	1990	18-6513	20	1981-90	18-6512	35	1976-77	18-6513
3	1957-67	18-6513	25	1969-76	18-6513	35	1978-90	18-6512
4	1978-90	18-6513	25	1977	18-6513	45	1958-59	18-6513
5.5	1957-64	18-6513	25	1978-90	18-6512	50	1958-89	18-6513
7.5	1957-76	18-6513	25C	1982-90	18-6512	60	1964-66	18-6513
10	1957-62	18-6513	30	1957-61	18-6512	75	1960-65	18-6513
						80	1966	18-6513

SEE PAGE 219 FOR OUR COMPLETE LINE OF GASKET SEALANTS

④ Priced per package

SIERRA OFFERS MORE!



ALL SIERRA MANIFOLDS:

Sierra offers an extensive selection of over 400 Rotating Electrical products, all backed by an industry leading warranty.

Protect your customer and your reputation. Use only a certified marine product from Sierra.

- Alternators
- Starters
- Trim Motors
- Solenoids
- Rectifiers
- Accessories

The Very Best Parts of Boating

Sierra
Marine Engine and Drive Parts

- 78 — Gear Housing Seal Kit 18-2658
- 77 — Water Pump Repair Kit W/ HOUSING 18-3382

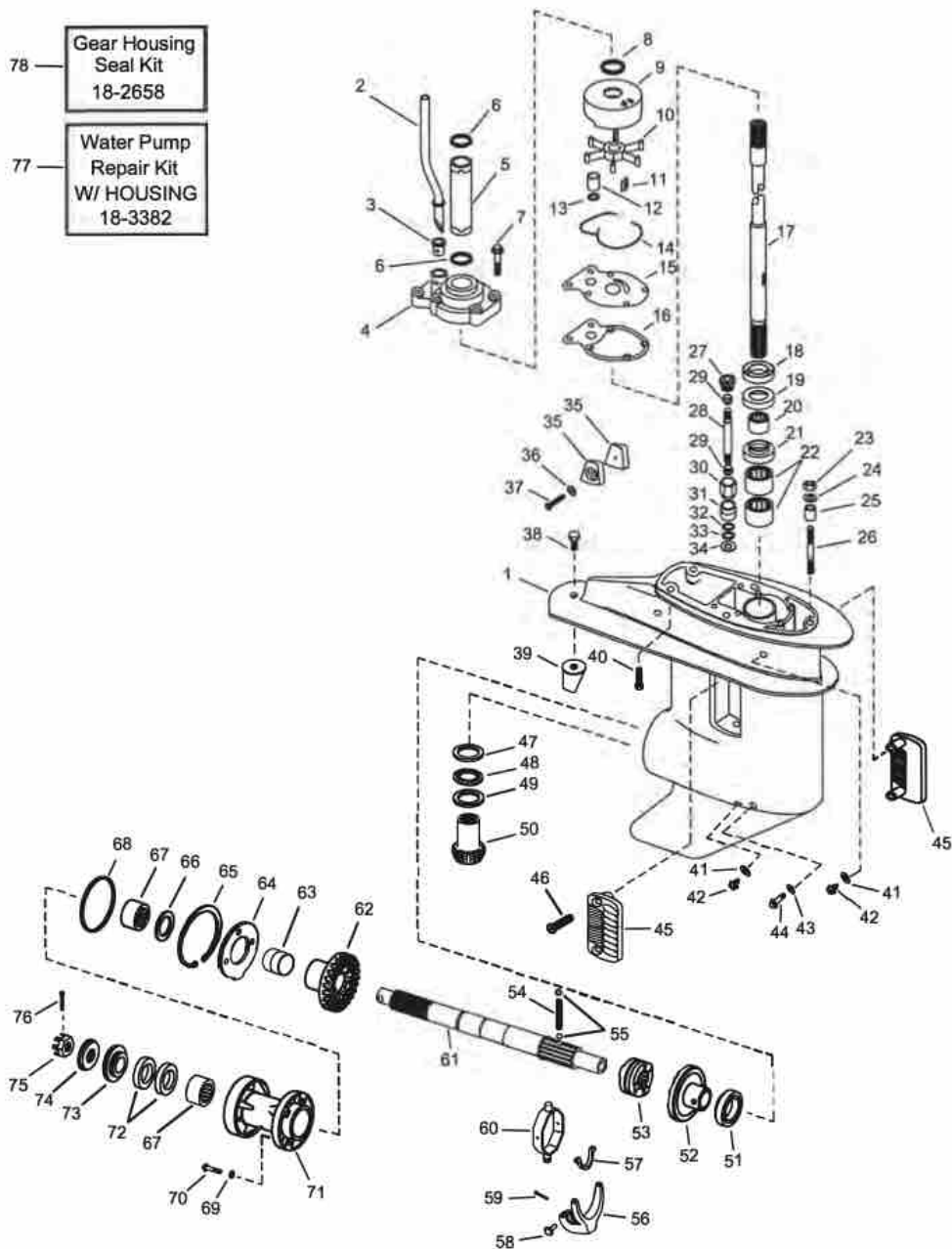

Complete Gear Housings Listed on Page 364

Figure #	Description	Part #	O.E.M. #	Qty.	Figure #	Description	Part #	O.E.M. #	Qty.
1	Gear Housing	—	434030	1	46	Screw, Screen Retaining	—	325539	2
2	Tube Water	—	395339	1	47	Washer, Thrust	—	327716	1
3	Grommet	18-3329	302497	1	48	Bearing, Thrust	—	388027	1
4	Housing, Water Pump	18-3367	393632	1	49	Washer, Thrust	—	330441	1
5	Tube, Extension	—	326692	1	50	Gear, Pinion	18-1288	328313	1
6	O-Ring	18-7105	311338	2	51	Bearing, Forward Gear	—	386186	1
7	Bolt, Water Pump Housing	—	328725	6	52	Gear, Forward	18-1287	392475	1
8	O-Ring	18-7146	554545	1	53	Clutch Sliding	18-1290	337020	1
9	Insert, Water Pump Housing	18-3358	328751	1	54	Spring, Detent	—	327070	1
10	Impeller	18-3051	395289	1	55	Ball, Detent	18-2243	316506	2
11	Key, Water Pump	18-3295	344470	1	56	Lever Shifter	—	337019	1
12	Bushing	—	328754	1	57	Cradle, Sliding Clutch	—	438311	1
13	O-Ring	18-7100	301877	1	58	Pin, Shift	—	302504	1
14	Seal, Rubber	18-2539	328753	1	59	Cotterpin, Shift Lever	—	303049	1
15	Plate, Wear	—	328753	1	60	Yoke & Connector Assy.	—	390023	1
16	Gasket, Water Pump	18-0124	325537	1	61	Shaft, Propeller	—	439143	1
17	Drive Shaft (15")	—	341635	1	62	Gear, Reverse	18-1289	327655	1
	Drive Shaft (20")	—	341636	1	63	Bushing, Reverse Gear	—	319635	1
18	Seal Drive Shaft (upper)	18-2065	332261	1	64	Plate, Retainer	—	319746	1
19	Seal Drive Shaft (lower)	18-2033	321938	1	65	Ring, Retaining	—	319747	1
20	Bearing, Driveshaft	—	386473	1	66	Washer, Forward Gear Thrust	—	319684	1
21	Collar, Housing	—	322018	1	67	Bearing, Propshaft	—	437288	2
22	Bearing, Pinion	—	437288	2	68	O-Ring	18-7108	338518	1
23	Nut, Housing	—	306422	1	69	Seal	18-7475	332584	2
24	Washer, Locking	—	301250	1	70	Bolt, Carrier Retaining	—	319743	2
25	Bushing, Housing Alignment	—	319785	1	71	Carrier, Bearing	—	433428	1
26	Stud	—	320173	1	72	Seal, Propshaft	18-2026	321453	2
27	Connector, Shift	—	325624	1	73	Spacer, Prop	18-4229	319890	1
28	Shift Rod	—	331479	1	74	Spacer, Prop	18-4232	323943	1
29	Keeper, Nylon Shift	—	325625	2	75	Prop Nut	18-3707	319891	1
30	Nut, Shiftshaft Retaining	—	331465	1	76	Cotter Pin, Prop Nut	18-3743	320785	1
31	Bushing	—	326361	1	77	Water Pump Kit	18-3382	393639	1
32	O-Ring	18-7180	303347	1	78	Gear Housing Seal Kit	18-2658	396351	1
33	O-Ring	18-7100	301877	1					
34	Washer, Expanding	18-0189	321738	1					
35	Anode Kit	—	434029	1					
36	Lockwasher	—	304454	1					
37	Bolt, Anode Retaining	—	333677	1					
38	Bolt, Trim Tab Retaining	—	329217	1					
39	Trim Tab	—	336203	1					
40	Bolt, Housing Retaining	—	328333	4					
41	Gasket, Drain Plug	18-4248	311598	2					
42	Plug, Drain	18-2387	307551	2					
43	Seal	18-7475	332584	1					
44	Pin, Shift Lever Pivot	—	308376	1					
45	Screen, Water Inlet	—	336202, 336206	2					

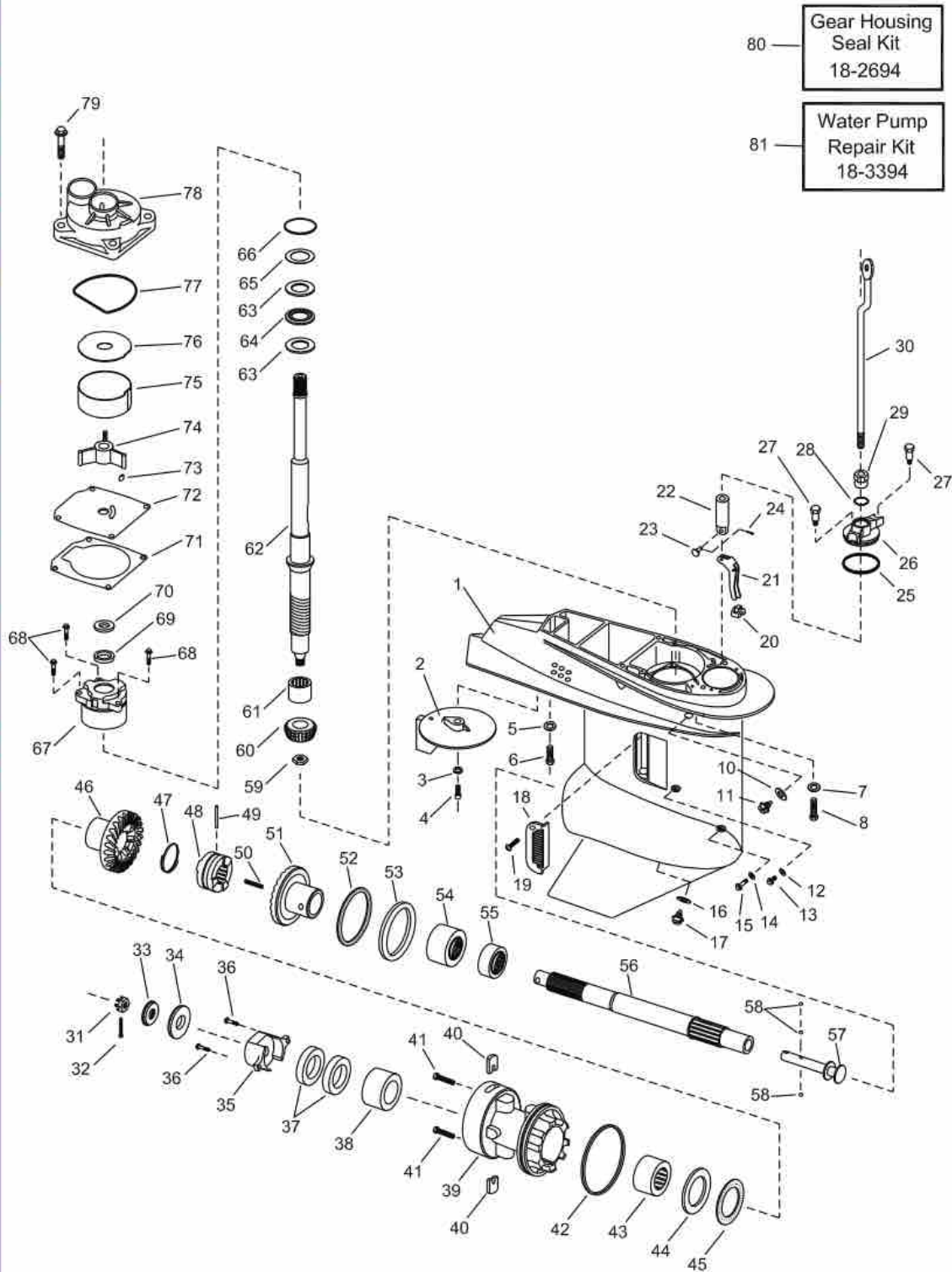

Complete Gear Housings Listed on Page 364

Figure #	Description	Part #	O.E.M. #	Qty.	Figure #	Description	Part #	O.E.M. #	Qty.
1	Housing, Gearcase	—	435275	1	47	Spring Clutch	18-2398	320311	1
2	Trim Tab	—	340539	1	48	Clutch Sliding	18-2308	332491	1
3	Washer, Anode	—	330266	1	49	Pin, Clutch Cross	—	320310	1
4	Bolt, Anode Retaining	—	330930	1	50	Spring Shifter	—	332484	1
5	Washer	—	330265	1	51	Gear Set, Forward & Pinion	18-2310	397627	1
6	Bolt	—	313697	1	52	Thrust Bearing, Forward Gear	18-1364	397538	1
7	Washer	—	330266	4	53	Thrust Washer, Forward Gear	18-0197	333725	1
8	Bolt	—	305282	4	54	Bearing Forward, Outer	18-1351	382407	1
10	O-Ring	18-4253-9	336982	1	55	Thrust Bearing, Forward Gear	18-1369	432264	1
11	Drain Plug, Upper	18-1236	309243	1	56	Propeller Shaft	18-2288	439138	1
12	Seal	18-7475	332584	1	57	Shaft, Shift Dog	—	332503	1
13	Retaining Screw	—	324852	1	58	Ball, Detent	18-2243	316506	3
14	O-Ring Screw	18-7109	317178	1	59	Nut, Pinion	—	313339	1
15	Screw, Shift Lever	—	333770	1	60	Gear Set, Forward & Pinion	18-2310	397627	1
16	Gasket, Drain Plug	18-4248	311598	1	61	Bearing Pinion	18-1356	382343	1
17	Drain Fill Plug, Lower	18-2378	318544	1	62	Driveshaft (std)	—	433066	1
18	Screen, Water Intake	—	332494	2		Driveshaft (long)	18-1721	433067	1
19	Bolt, Inlet Screen Retainer	—	325539	2	63	Washer, Thrust	18-0201	333771	2
20	Cradle, Shifter	—	332507	1	64	Thrust Bearing, Driveshaft	18-1368	398901	1
21	Lever, Shift	—	332492	1	65	Shim (.003)	—	313273	AR
22	Connector, Shift Rod	—	332508	1		Shim (.004)	—	313274	AR
23	Pin, Connector	—	302504	1		Shim (.005)	—	313275	AR
24	Cotter Pin	—	306376	1		Shim (.006)	—	313276	AR
25	O-Ring, Shift Rod Cover	—	338522	1		Shim (.007)	—	313277	AR
26	Cover, Shift Rod	—	434588	1	66	O-Ring, Gear Housing	18-7173	310327	1
27	Bolt, Shift Rod Cover	—	316037	2	67	Cap, Upper Driveshaft, Retaining	—	435274	1
28	O-Ring, Shift Rod	18-7137	318372	1	68	Bolt, Driveshaft Retaining	—	317624	3
29	Bushing, Shift Rod	—	333780	1	69	Seal Lower	18-2059	321466	1
30	Shift Rod (std.)	—	332509	1	70	Seal Upper	18-2064	332205	1
	Shift Rod (long)	—	332510	1	71	Gasket, Impeller	18-2709	336530	1
31	Nut, Prop	18-3705	314503	1	72	Plate, Impeller	NSS	341038	1
32	Pin, Cotter	18-3742	314502	1	73	Key, Impeller	18-3138	334897	1
33	Spacer, Prop	18-4228	315810	1	74	Impeller	18-3104-1	432941	1
34	Washer, Prop Thrust	18-4230	320305	1	75	Skirting, Insert	NSS	324980	1
35	Anode, Bearing Housing	—	398873	1	76	Plate, Insert Top	18-3126	321940	1
36	Bolt, Anode Retaining	—	328694	2	77	Seal, Rubber	18-7481	324981	1
37	Oil Seals, Prop Shaft	18-2060	321467	2	78	Housing, W/P	18-3129	438544	1
38	Bearing, Needle	18-1355	386765	1	79	Bolt, Water Pump Housing	18-3369	302325	4
39	Bearing Carrier Assembly	18-1708	432276	1	80	Gear Housing Seal Kit	18-2694	433550	1
40	Tabs, Retaining	18-1343	332495	2	81	Water Pump Repair Kit	18-3394	433548	1
41	Bolt, Carrier Retaining	—	328744	2					
42	O-Ring, Bearing Housing	18-7172	553126	1					
43	Bearing, Needle	18-1354	386764	1					
44	Thrust Washer, Reverse Gear	18-0196	332514	1					
45	Thrust Bearing, Reverse Gear	18-1363	397537	1					
46	Gear, Reverse	18-2309	332489	1					

AR As required

NSS Not Sold Separate

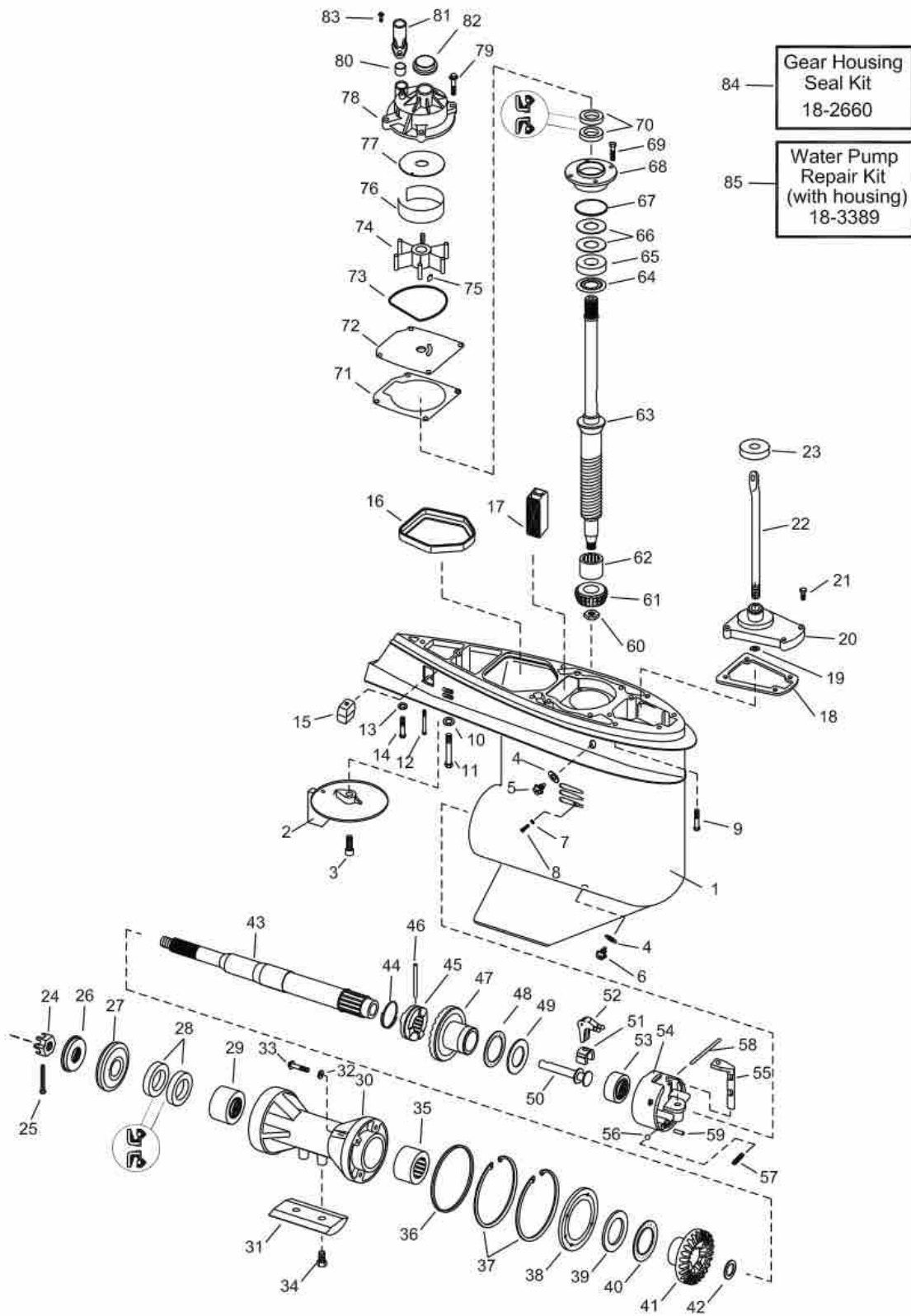

Complete Gear Housings Listed on Page 364

Figure #	Description	Part #	O.E.M. #	Qty.	Figure #	Description	Part #	O.E.M. #	Qty.
1	Housing Gearcase	—	392478	1	43	Propshaft	18-2250	439185, 439131	1
2	Trim Tab	—	318544	1	44	Retaining Spring	18-2399	324369	1
3	Bolt, Trim Tab	—	313715	1	45	Clutch Sliding	18-2209	318303	1
4	O-Rings, Drain Plugs	18-7145	333572	2	46	Pin, Clutch Dog	18-1714	313448	1
5	Drain Fill Plug, Upper	18-2387	307551	1	47	Gear Set, Forward & Pinion	—	397338	1
6	Magnetic Drain Screw	18-2378	318544	1	48	Thrust Bearing, Forward Gear	18-1371	385043	1
7	Seal	18-7475	332584	1	49	Thrust Washer, Forward Gear	18-0198	324766	1
8	Bolt, Pinion Retaining	—	324852	1	50	Shaft, Shifter	—	326668	1
9	Bolt, Housing	—	308843	4	51	Cradle, Shifter	18-3766	334163	1
10	Lockwasher	—	306314	1	52	Lever, Shift	—	324037	1
11	Bolt, Long Gearcase	—	313697	1	53	Bearing, Housing	NSS	NSS	
12	Bolt, Anode	—	328096	1	54	Bearing Housing Assy.	—	391365	1
13	Lockwasher	—	306470	1	55	Detent Shift	—	326670	1
14	Bolt, Short Gearcase	—	306503	1	56	Detent Ball	—	327345	1
15	Anode, Cavitation	18-6024	436745	1	57	Detent Spring	—	911961	1
16	Seal, Exhaust	18-2537	324937	1	58	Pin, Shifter Housing	—	320145	1
17	Screen, Water Inlet	—	314175	1	59	Pin, Housing	18-3765	331880	1
18	Gasket, Shiftshaft Housing	18-2855	314082	1	60	Nut, Pinion	—	313339	1
19	O-Rings, Shiftshaft	18-7137	318372	1	61	Gear, Pinion	NSS	NSS	
20	Shiftshaft Housing	—	388651	1	62	Bearing, Pinion	18-1356	382343	1
21	Bolt, Shiftshaft Housing	18-3133	302325	4	63	Driveshaft(std)	—	437376	1
22	Shiftshaft	—	327337	1	64	Bearing, Thrust	—	317230	1
23	Slinger, Shift Arm	18-2706	321008	1	65	Washer, Thrust	18-1367	385068	1
24	Nut, Propeller	18-3705	314503	1	66	Shim (.003)	18-2232	323889	AR
25	Cotter Pin, Prop Nut	18-3742	314502	1	66	Shim (.004)	18-2233	323890	AR
26	Spacer, Prop Nut	18-4228	315810	1	66	Shim (.005)	18-2234	317232	AR
27	Thrust Washer	18-4222	127084, 318841	1	67	O-Ring Bearing Housing	18-7128	313754	1
28	Outer Seal, Carrier	18-8326	330137	1	68	Driveshaft Retaining Housing	—	385087	1
28	Inner Seal, Carrier	18-2001	342787	1	69	Bolt, Driveshaft Retaining	—	909386	4
29	Carrier Bearing (Aft)	18-1350	379504	1	70	Seal	18-8325	342786	1
30	Carrier Assembly	—	434391	1	71	Gasket, Water Pump	18-2709	336530	1
31	Anode, Carrier	—	306470	1	72	Plate, Impeller	18-3127	341038	1
32	Seal	18-7475	332584	4	73	Seal, Water Pump Housing	18-7481	324981	1
33	Bolt, Carrier to Retainer	18-2379	320041	4	74	Impeller	18-3053-1	396725	1
34	Bolt, Carrier Anode	—	127466	2	75	Key, Impeller	18-3138	334897	1
35	Carrier Bearing (Fore)	18-1351	382407	1	76	Liner, Water Pump Housing	—	321940	1
36	O-Ring, Bearing Housing	18-7127	313446	1	77	Liner, Top Plate	18-3126	324980	1
37	Retaining Rings	—	313445	2	78	Housing, Water Pump	18-3129	435673	1
38	Retaining Plate, Carrier	—	313453	1	79	Bolt, Water Pump Housing	18-3133	302325	1
39	Large Thrust Washer, Reverse Gear	18-0193	313447	1	80	Seal, Guide tube	18-2703	314008	1
40	Thrust Bearing, Reverse Gear	18-1366	382408	1	81	Guide, Water Tube	—	319276	1
41	Gear, Reverse	18-2208	318304	1	82	Grommet	18-2705	342786	1
42	Small Thrust Washer, Reverse Gear	—	316484	1	83	Screw, Guide Tube	18-3153	908158	1
					84	Gear Housing Seal Kit	18-2660	396349	1
					85	Water Pump Repair Kit, Complete	18-3389	432955	1

AR As required

NSS Not Sold Separate

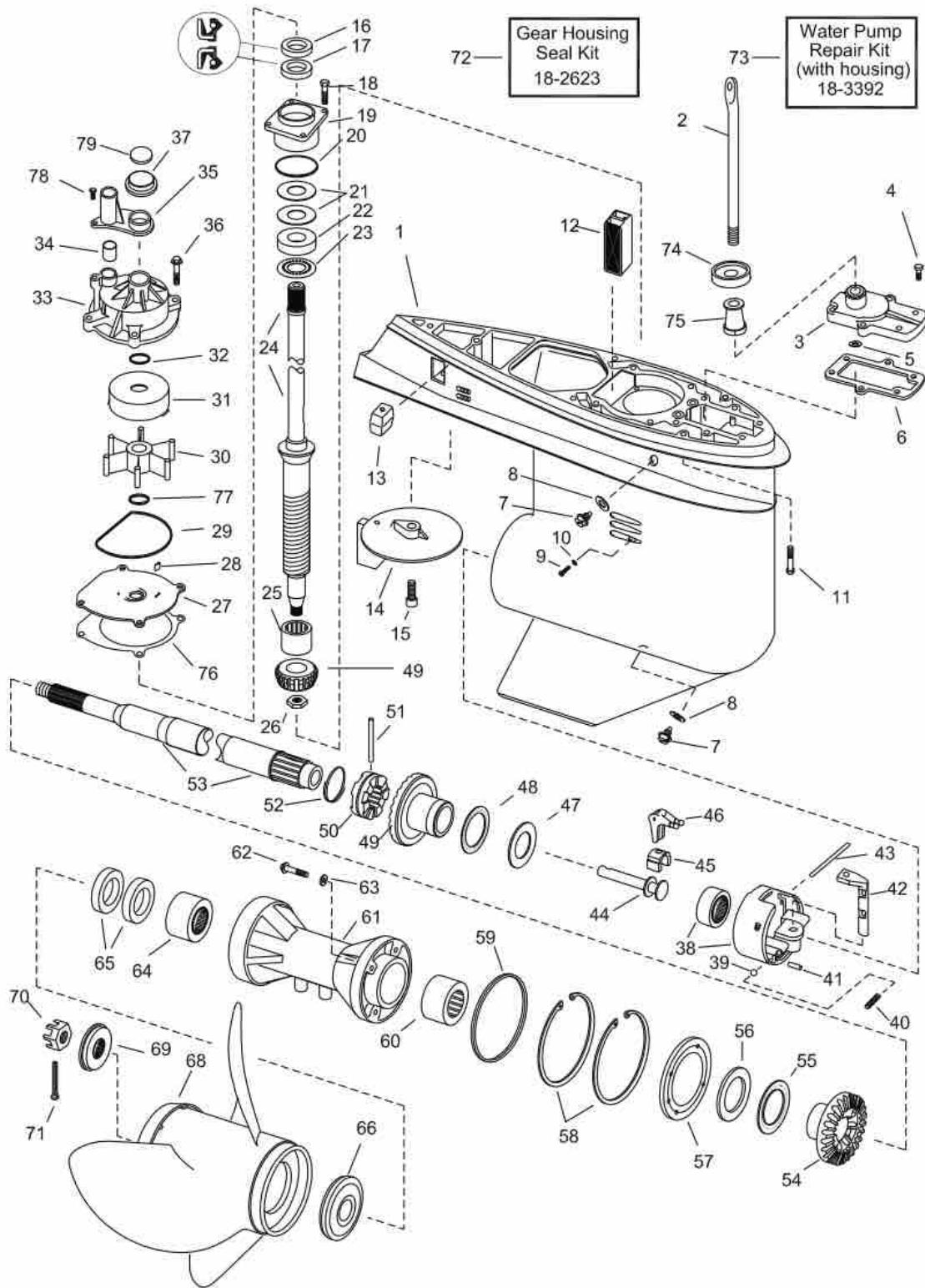

Complete Gear Housings Listed on Page 364

Figure #	Description	Part #	O.E.M. #	Qty.	Figure #	Description	Part #	O.E.M. #	Qty.
1	Housing Gearcase	—	431642	1	43	Pin, Shift Lever	—	320145	1
2	Shift Rod (long)	—	332120	1	44	Shift Shaft	18-3763	322941	1
	Shift Rod (x-long)	—	332121	1	45	Cradler, Shifter	18-3766	334163	1
3	Cover, Shift Rod	—	388618	1	46	Shift Lever	—	324037	1
4	Screw, Cover	18-3369	302325	6	47	Thrust Washer, Forward Gear	18-0198	324766	1
5	O-Ring, Shift Rod	18-7137	318372	1	48	Thrust Bearing, Forward Gear	18-1371	385043	1
6	Gasket, Shift Housing	18-0110	324670	1	49	Gear Set, Forward & Pinion	18-2218	398035	1
7	Magnetic Drain Screw	18-2378	318544	1	50	Sliding Clutch	18-2220	323664	1
8	O-Rings, Plugs	18-7145	333572	1	51	Pin, Clutch Dog	18-1714	313448	1
9	Screw	—	324852	1	52	Retaining Spring	18-2399	324369	1
10	O-Ring	18-7475	332584	1	53	Propeller Shaft	18-2252	387818	1
11	Screw, Gearcase to housing	—	331999	5	54	Gear, Reverse	18-2219	333077	1
12	Screen, Water intake	—	323466	1	55	Thrust Bearing, Reverse Gear	18-1366	382408	1
13	Anode	18-6024	393023	1	56	Thrust Washer, Reverse Gear	18-0195	314731	1
14	Trim Tab	—	327640	1	57	Retainer Plate/Bearing Housing	—	314732	1
15	Screw, Trim tab	—	313715	1	58	Retaining Rings	—	313445	2
16	Oil Seal, Upper	18-2061	329922	1	59	O-Ring, Bearing Housing	18-7127	313446	1
17	Oil Seal, Lower	18-2062	329923	1	60	Carrier Bearing (Fore)	18-1351	382407	1
18	Screw, Housing to gearcase	—	317624	4	61	Bearing Housing	—	397087	1
19	Bearing Housing	—	397493	1	62	Screw, Retainer	18-2377	316563	4
20	O-Ring Bearing Housing	18-7130	314728	1	63	O-Ring	18-7475	332583	1
21	Shim .003	18-2229	323362	AR	64	Roller Bearing (Aft)	18-1350	379504	1
	Shim .004	18-2230	323361	AR	65	Oil Seals, Prop Shaft	18-2001	330137	2
	Shim .005	18-2231	314745	AR	66	Thrust Washer	18-4222	318841	1
22	Thrust Washer, Pinion	18-0200	327656	1	68	Propeller	—	Various	1
23	Thrust Bearing, Pinion	18-1365	387656	1	69	Spacer, Prop Nut	18-4228	315810	1
24	Drive Shaft (long)	—	394613	1	70	Nut, Propeller	18-3705	314503	1
	Drive Shaft (x-long)	—	394614	1	71	Cotter Pin, Prop Nut	18-3742	314502	1
25	Bearing, Pinion	18-1357	384195	1	72	Gear Housing Seal Kit	18-2623	396354	1
26	Nut, Pinion	18-3719	314730	1	73	Water Pump Repair Kit (w/housing)	18-3392	395062	1
27	Wear Plate	18-3346	330380	1	74	Grommet	18-2706	321008	1
28	Key, Impeller	18-3299	331107	1	75	Spacer, Shift rod	—	321122	1
29	Seal, Impeller Housing	18-7963	331353	1	76	Gasket, Impeller housing plate	18-2557	324701	1
30	Impeller	18-3059	395864	1	77	O-Ring, Drive Shaft	—	302035	1
31	Cup, Impeller	18-3346	330379	1	78	Screw, Cover to impeller	18-3135	306643	2
32	O-Ring, Drive Shaft	18-2769	332000	1	79	O-Ring, Driveshaft to crankcase	18-7158	310585	1
33	Housing, Water Pump	18-3130	395040	1					
34	Grommet, Water Tube	18-2703	314008	1					
35	Pump cover	—	321159	1					
36	Screw, Impeller housing	—	328715	4					
37	Grommet	18-2704	320943	1					
38	Bearing Housing Assembly	—	391365	1					
39	Ball, Detent	—	327345	1					
40	Spring, Detent	—	326666	1					
41	Pin, Housing	18-3765	331880	1					
42	Detent, Shifter	—	323946	1					

AR As required

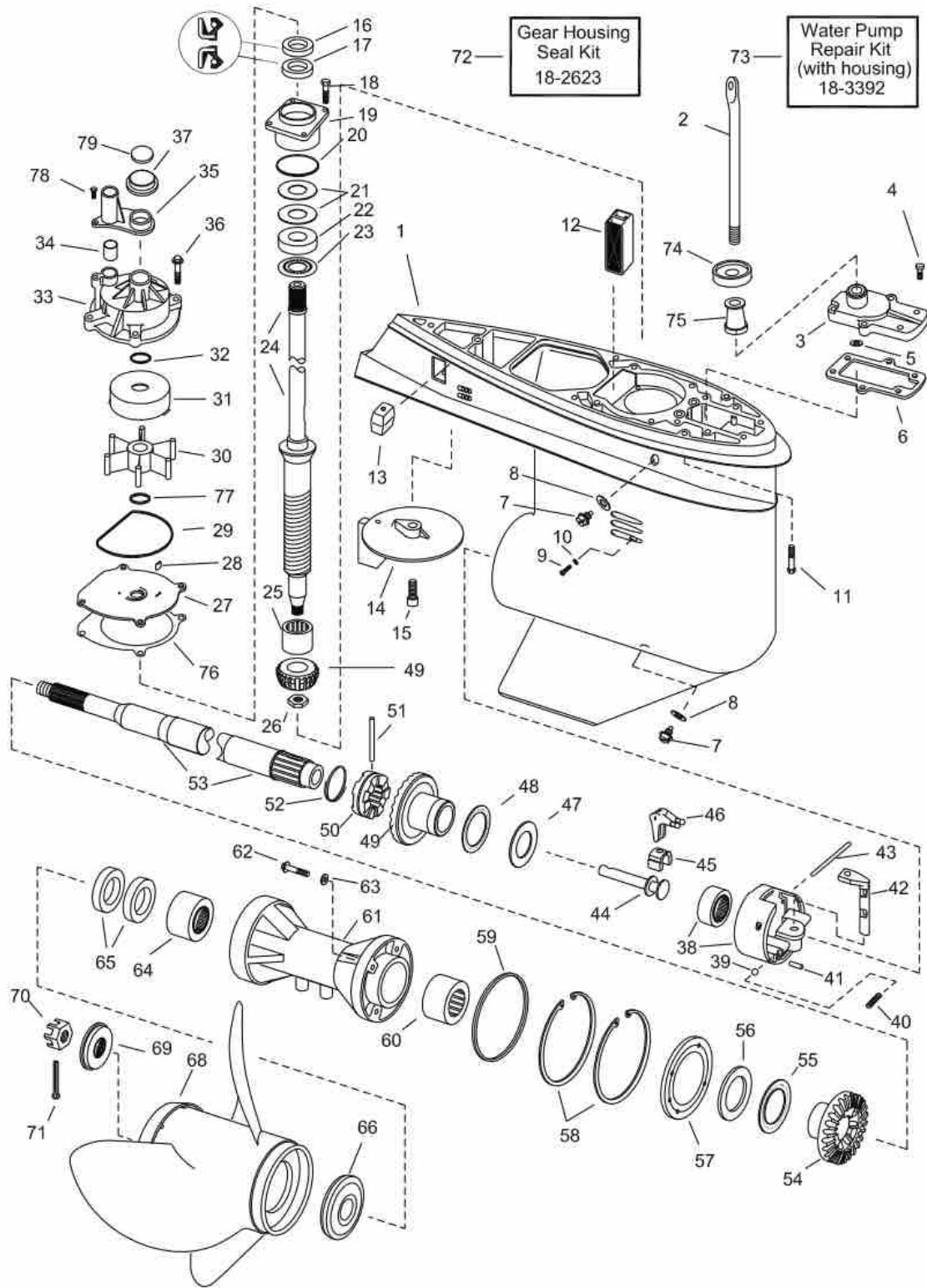

Complete Gear Housings Listed on Page 364

Figure #	Description	Part #	O.E.M. #	Qty.	Figure #	Description	Part #	O.E.M. #	Qty.
1	Housing Gearcase	—	438050	1	43	Pin, Shift Lever	—	328825	1
2	Shift Rod (long)	—	324407	1	44	Shift Shaft	18-3763	322941	1
2	Shift Rod (x-long)	—	324408	1	45	Cradler, Shifter	18-3766	334163	1
3	Cover & Shift Rod	—	435482	1	46	Shift Lever	18-3762	322938	1
4	Screw, Cover	18-3369	302325	6	47	Thrust Washer, Forward Gear	18-0199	327669	1
5	O-Ring, Shift Rod	18-7137	318372	1	48	Thrust Bearing, Forward Gear	18-1370	389042	1
6	Gasket, Shift Housing	18-0110	324670	1	49	Gear Set, Forward & Pinion	NSS	435020	1
7	Magnetic Drain Screw	18-2378	318544	2	50	Sliding Clutch	18-2216	337774	1
8	O-Rings, Plugs	18-7145	333572	2	51	Pin, Clutch Dog	18-1714	313448	1
9	Screw	—	324852	1	52	Retaining Spring	18-2399	324369	1
10	O-Ring	18-7120	307853	1	53	Propeller Shaft	18-2187	395209	1
11	Screw, Gearcase to housing	—	320741	5	54	Gear, Reverse	NSS	910994	1
12	Screen, Water intake	—	321123	1	55	Thrust Bearing, Reverse Gear	18-1366	382408	1
13	Anode	18-6024	393023	1	56	Thrust Washer, Reverse Gear	18-0195	314731	1
14	Trim Tab	—	327640	1	57	Retainer Plate/Bearing Housing	—	321174	1
15	Screw, Trim tab	—	313715	1	58	Retaining Rings	—	321171	2
16	Oil Seal, Upper	18-2061	329922	1	59	O-Ring, Bearing Housing	18-7133	305123	1
17	Oil Seal, Lower	18-2062	329923	1	60	Carrier Bearing (Fore)	18-1351	382407	1
18	Screw, Housing to gearcase	—	316534	4	61	Bearing Housing	—	397094	1
19	Bearing Housing	—	438963	1	62	Screw, Retainer	18-2377	316563	4
20	O-Ring Bearing Housing	18-7130	314728	1	63	O-Ring	18-7109	317178	1
21	Shim .003	18-2229	323362	AR	64	Roller Bearing (Alt)	18-1158	387247	1
21	Shim .004	18-2230	323361	AR	65	Oil Seals, Prop Shaft	18-2002	320862	2
21	Shim .005	18-2231	314745	AR	66	Thrust Washer	18-4223	333592	1
22	Thrust Washer, Pinion	18-0200	327656	1	68	Propeller	—	various	1
23	Thrust Bearing, Pinion	18-1365	387665	1	69	Spacer, Prop Nut	18-4231	320570	1
24	Drive Shaft (long)	see app chart	435755	1	70	Nut, Propeller	18-3708-1	398042	1
24	Drive Shaft (x-long)	see app chart	435756	1	71	Cotter Pin, Prop Nut	18-3741	306394	1
25	Bearing, Pinion	18-1117	387817	1	72	Gear Housing Seal Kit	18-2623	396353	1
26	Nut, Pinion	18-3719	314730	1	73	Water Pump Repair Kit (w/housing)	18-3392	434421	1
27	Cup & Plate Assembly	18-3346	330380	1	74	Grommet	18-2706	321008	1
28	Key, Impeller	18-3299	331107	1	75	Spacer, Shift rod	—	321122	1
29	Seal, Impeller Housing	18-7963	331353	1	76	Gasket, Impeller housing plate	18-2557	324701	1
30	Impeller	18-3059	397131	1	77	O-Ring, Drive Shaft	18-7158	310585	1
31	Cup & Plate Assembly	18-3346	330379	1	78	Screw, Cover to impeller	18-3135	306643	2
32	O-Ring, Drive Shaft	18-7158	310585	1	79	O-Ring, Driveshaft to crankcase	18-7158	310585	1
33	Housing, Water Pump	18-3130	395040	1					
34	Grommet, Water Tube	18-2703	314008	1					
35	Pump cover	—	321159	1					
36	Screw, Impeller housing	18-3136	323626	4					
37	Grommet	18-2704	320943	1					
38	Bearing Housing Assembly	—	389455	1					
39	Ball, Detent	18-1501	160084	1					
40	Spring, Detent	18-1502	911962	1					
41	Pin, Housing	18-3765	331880	1					
42	Detent, Shifter	—	323946	1					

AR As required



18-4840 ②
**COMPLETE LOWER
 GEARCASE ASSEMBLIES**
 Replaces: 435277
 Fits: 40/48/50hp w/20" Shaft (1989-92)



18-4841 ②
**COMPLETE LOWER
 GEARCASE ASSEMBLIES**
 Replaces: 435276
 Fits: 40/48/50hp w/15" Shaft (1989-92)



18-4843 ②
**COMPLETE LOWER
 GEARCASE ASSEMBLIES**
 Replaces: 435279
 Fits: 40/48/50hp w/15" Shaft (1983 and Up)

PKG. OF 5



18-2377
18-2377-9 ①
**RETAINER
 SCREW**
 Replaces: 316563

PKG. OF 4



18-2379
18-2379-9 ①
**LOWER UNIT
 CARRIER SCREW**
 Replaces: 320041



18-4826
**GEARCASE TO
 HOUSING SCREW**
 Replaces: 331999

PKG. OF 5



18-4253-9 ①
18-42531-9 ①
 (PKG. OF 50)
**DRAIN SCREW
 O-RING**
 Replaces: 336982
 Used w/ 18-1236 Drain Screw

PKG. OF 5



18-4248
18-4248-9 ①
18-42481-9 ②
 (PKG. OF 50)
**DRAIN/FILL PLUG
 WASHER
 (Plastic)**
 Replaces: 311598
 Used with 18-2387 Drain Screw

PKG. OF 2



18-2945
18-2945-9 ①
18-29451-9 ①
 (PKG. OF 50)
**DRAIN SCREW
 GASKET**
 Replaces: 307552



18-1236
DRAIN SCREW
 Replaces: 309243
 For: 40-50 HP (1989-97)
 Cobra Drives



18-2387
18-23871-9 ①
 (PKG. OF 50)
**LOWER UNIT
 DRAIN/FILL SCREW
 Slot Head**



18-4255
E-TEC DRAIN SCREW
 Replaces: 307551
 Allan Head



18-2378
18-23781-9 ①
 (PKG. OF 50)
**MAGNETIC
 DRAIN SCREW
 Slot Head**

① Priced per package

② All gearcase assemblies pictured above are primed only. Be prepared to paint the gearcase to match your customer's engine.

 <p>18-4249 E-TEC DRAIN SCREW WITH MAGNET Replaces: 318544 Allan Head</p>	 <p>18-3708-1 PROP NUT & KEEPER Replaces: 398042</p>	<p>PKG. OF 5</p>  <p>PROP NUTS</p> <table border="1"> <thead> <tr> <th>PART #</th> <th>O.E.#</th> </tr> </thead> <tbody> <tr> <td>18-3705</td> <td>314503</td> </tr> <tr> <td>18-3706</td> <td>318971</td> </tr> <tr> <td>18-3707</td> <td>319891</td> </tr> </tbody> </table>	PART #	O.E.#	18-3705	314503	18-3706	318971	18-3707	319891	<p>PKG. OF 10</p>  <p>COTTER PINS</p> <table border="1"> <thead> <tr> <th>PART #</th> <th>O.E.#</th> <th>DIMEN.</th> </tr> </thead> <tbody> <tr> <td>18-3735</td> <td>5030087</td> <td>3/32" X 1 1/8"</td> </tr> <tr> <td>18-3740</td> <td>302804</td> <td>3/32" X 1"</td> </tr> <tr> <td>18-3741</td> <td>309955</td> <td>1/8" X 1 1/4"</td> </tr> <tr> <td>18-3742</td> <td>314502</td> <td>1/8" X 1 1/4"</td> </tr> <tr> <td>18-3743</td> <td>320785</td> <td>1/8" X 7/4"</td> </tr> <tr> <td>18-3744</td> <td>552906</td> <td>3/32" X 7/4"</td> </tr> </tbody> </table>	PART #	O.E.#	DIMEN.	18-3735	5030087	3/32" X 1 1/8"	18-3740	302804	3/32" X 1"	18-3741	309955	1/8" X 1 1/4"	18-3742	314502	1/8" X 1 1/4"	18-3743	320785	1/8" X 7/4"	18-3744	552906	3/32" X 7/4"							
PART #	O.E.#																																						
18-3705	314503																																						
18-3706	318971																																						
18-3707	319891																																						
PART #	O.E.#	DIMEN.																																					
18-3735	5030087	3/32" X 1 1/8"																																					
18-3740	302804	3/32" X 1"																																					
18-3741	309955	1/8" X 1 1/4"																																					
18-3742	314502	1/8" X 1 1/4"																																					
18-3743	320785	1/8" X 7/4"																																					
18-3744	552906	3/32" X 7/4"																																					
<p>③ 18-3715D Display Package</p>  <p>18-3715 PROP NUT KIT Replaces: 175266</p> <p>— CONTAINS —</p> <table border="1"> <thead> <tr> <th>Part #</th> <th>O.E.#</th> <th>Description</th> </tr> </thead> <tbody> <tr> <td>18-3708-1</td> <td>398042</td> <td>Prop Nut/Keeper</td> </tr> <tr> <td>18-3741</td> <td>309955</td> <td>Cotter Pin</td> </tr> <tr> <td>18-4231</td> <td>320570</td> <td>Prop Spacer</td> </tr> </tbody> </table>	Part #	O.E.#	Description	18-3708-1	398042	Prop Nut/Keeper	18-3741	309955	Cotter Pin	18-4231	320570	Prop Spacer	<p>③ 18-3716D Display Package</p>  <p>18-3716 PROP NUT KIT Replaces: 175267</p> <p>— CONTAINS —</p> <table border="1"> <thead> <tr> <th>Part #</th> <th>O.E.#</th> <th>Description</th> </tr> </thead> <tbody> <tr> <td>18-3705</td> <td>314503</td> <td>Prop Nut</td> </tr> <tr> <td>18-3742</td> <td>314502</td> <td>Cotter Pin</td> </tr> <tr> <td>18-4228</td> <td>315810</td> <td>Prop Spacer</td> </tr> </tbody> </table>	Part #	O.E.#	Description	18-3705	314503	Prop Nut	18-3742	314502	Cotter Pin	18-4228	315810	Prop Spacer	<p>③ 18-3717D Display Package</p>  <p>18-3717 PROP NUT KIT Replaces: 175268</p> <p>— CONTAINS —</p> <table border="1"> <thead> <tr> <th>Part #</th> <th>O.E.#</th> <th>Description</th> </tr> </thead> <tbody> <tr> <td>18-3707</td> <td>319891</td> <td>Prop Nut</td> </tr> <tr> <td>18-3743</td> <td>320785</td> <td>Cotter Pin</td> </tr> <tr> <td>18-4232</td> <td>323943</td> <td>Prop Spacer</td> </tr> </tbody> </table>	Part #	O.E.#	Description	18-3707	319891	Prop Nut	18-3743	320785	Cotter Pin	18-4232	323943	Prop Spacer	 <p>18-3753 PROP NUT KIT Replaces: 5005034 Fits: 40-130 (2001 & Up)</p>
Part #	O.E.#	Description																																					
18-3708-1	398042	Prop Nut/Keeper																																					
18-3741	309955	Cotter Pin																																					
18-4231	320570	Prop Spacer																																					
Part #	O.E.#	Description																																					
18-3705	314503	Prop Nut																																					
18-3742	314502	Cotter Pin																																					
18-4228	315810	Prop Spacer																																					
Part #	O.E.#	Description																																					
18-3707	319891	Prop Nut																																					
18-3743	320785	Cotter Pin																																					
18-4232	323943	Prop Spacer																																					
 <p>18-3768 COVER NUT Replaces: 911751 For: Cobra drives: 115 (1994-97), 232 (1987-90), 252 (1986), 262 (1989), 302 (1987)</p>	 <p>18-4222 THRUST WASHER Replaces: 318841, 127084</p>	 <p>18-4223 THRUST WASHER Replaces: 333592</p>	 <p>18-4228 PROP SPACER Replaces: 315810</p>																																				
 <p>18-4229 THRUST WASHER Replaces: 319890</p>	 <p>18-4230 THRUST WASHER Replaces: 320305</p>	 <p>18-4231 PROP SPACER Replaces: 320570</p>	 <p>18-4232 PROP SPACER Replaces: 323943</p>																																				

APPLICATION ON NEXT PAGE

① Priced per package ② This product is priced per piece. To order priced per package, please add -9 to the part number.
③ Items ending in "D" are Display Packaged - Regular number is Non-Display

JOHNSON/EVINRUDE

HP	Year	Spacer Before Prop	Washer After Prop	Prop Nut	Cotter Pin	Prop Nut Kit
9.9/15	1974-75	—	—	18-3706	18-3740	—
9.9/15	1976-99	—	—	18-3706	18-3744	—
20	1984-90	18-4229	18-4232	18-3707	18-3743	18-3717
20/30/35	1991-99	—	18-4232	18-3707	18-3743	18-3717
25 ⑤	1991	—	18-4232	18-3707	18-3743	18-3717
25 ⑦	1991	18-4232	18-4228	18-3705	18-3742	18-3716
25 ⑧	1992	—	18-4232	18-3707	18-3743	18-3717
25/30	1984-90	18-4229	18-4232	18-3707	18-3743	18-3717
35	1976-90	18-4229	18-4232	18-3707	18-3743	18-3717
40 ① ④	1984-99	18-4230	18-4228	18-3705	18-3742	18-3716
40 Comm	1996-97	18-4222	18-4228	18-3705	18-3742	18-3716
40 Comm	1998-99	—	18-4228	18-3705	18-3742	18-3716
45 Comm ②	1986-97	—	18-4228	18-3705	18-3742	18-3716
48 ①	1987-96	18-4230	18-4228	18-3705	18-3742	18-3716
50/60 TTL	1996-98	18-4222	18-4228	18-3705	18-3742	18-3716
50 ②	1971-74	18-4222	18-4228	18-3705	18-3742	18-3716
50 ① ④	1975-99	18-4230	18-4228	18-3705	18-3742	18-3716
50 EL&DT	1996-98	—	18-4228	18-3705	18-3742	18-3716
50 Comm ②	1977-79	18-4222	18-4228	18-3705	18-3742	18-3716
55	1968-69	18-4222	18-4228	18-3705	18-3742	18-3716
55 ①	1976-79	18-4230	18-4228	18-3705	18-3742	18-3716
55 Comm ②	1980-97	18-4222	18-4228	18-3705	18-3742	18-3716
55 Comm	1998-99	—	18-4228	18-3705	18-3742	18-3716
60/70 ④	1996-99	—	18-4228	18-3705	18-3742	18-3716
60	1970-71,					
	1986-95	18-4222	18-4228	18-3705	18-3742	18-3716
60 ①	1980-85	18-4230	18-4228	18-3705	18-3742	18-3716
65	1972-73	18-4222	18-4228	18-3705	18-3742	18-3716
65 Comm	1984-95	18-4222	18-4228	18-3705	18-3742	18-3716
65 Comm	1996-99	—	18-4228	18-3705	18-3742	18-3716
70	1974-95	18-4222	18-4228	18-3705	18-3742	18-3716
75 ②	1975-84	18-4222	18-4228	18-3705	18-3742	18-3716
75 ①	1975-85	18-4230	18-4228	18-3705	18-3742	18-3716
Formula E	1986-90	18-4230	18-4228	18-3705	18-3742	18-3716
Sprint	1986-90	18-4230	18-4228	18-3705	18-3742	18-3716
85	1969-80,					
	1995	18-4222	18-4228	18-3705	18-3742	18-3716
88/90	1981-95	18-4222	18-4228	18-3705	18-3742	18-3716
88	1996	—	18-4228	18-3705	18-3742	18-3716
90 ① ④	1996-99	—	18-4228	18-3705	18-3742	18-3716
90 ②	1996	—	18-4231	18-3708-1	—	—
90 V-4 ④	1997-99	—	18-4228	18-3705	18-3742	18-3716
90 V-4 ② ④	1997	18-4223	18-4231	18-3708-1	—	—
90 FSX/ FPX ④	1998-99	18-4223	18-4231	18-3708-1	—	—
100	1979-80	18-4222	18-4228	18-3705	18-3742	18-3716
100 ⑨	1988-94	18-4222	18-4228	18-3705	18-3742	18-3716
100 ⑩	1992	—	18-4231	18-3708-1	—	—
100 Comm ④	1996,					
	1998	—	18-4228	18-3705	18-3742	18-3716
100 Comm	1995-97,					
	1999	18-4223	18-4231	18-3708-1	—	—
100 Comm ③	1984-90	18-4223	18-4231	18-3708-1	18-3741	18-3715
110	1986-89	18-4222	18-4228	18-3705	18-3742	18-3716
112	1996	—	18-4228	18-3705	18-3742	18-3716
115	1973-94	18-4222	18-4228	18-3705	18-3742	18-3716
115 ① ④	1996-99	—	18-4228	18-3705	18-3742	18-3716
115 ②	1996	—	18-4231	18-3708-1	—	—
115 V-4 ④	1997-99	—	18-4228	18-3705	18-3742	18-3716
115 V-4 ② ④	1997	18-4223	18-4231	18-3708-1	—	—
115 FSX/ FPX ④	1998-99	18-4223	18-4231	18-3708-1	—	—
120 ③	1985	18-4223	18-4231	18-3708-1	18-3741	18-3715

APPLICATION CONTINUED ON NEXT PAGE

- ① Models equipped with small gearcase
- ② Models equipped with large gearcase
- ③ Models equipped with V-6 gearcase
- ④ For 3-Blade propeller only
- ⑤ Use 18-4222 for 4-Blade propeller

- ⑥ All models except DR, DE & DT
- ⑦ Models DR, DE & DT only
- ⑧ Except models RSU, RSLU, RWENB, RWLENB
- ⑨ Except 1992 models WTLNE, WTXNENE
- ⑩ Models WTLNE, WTXNENE

- ⑪ 1992 ES models only
- ⑫ Except 1992 ESX models
- ⑬ 1992 TL models only
- ⑭ 1992 CX, TX models only

JOHNSON/EVINRUDE

HP	Year	Spacer Before Prop	Washer After Prop	Prop Nut	Cotter Pin	Prop Nut Kit
120	1986-94	18-4222	18-4228	18-3705	18-3742	18-3716
125	1971-94	18-4222	18-4228	18-3705	18-3742	18-3716
125	1992	—	18-4231	18-3708-1	—	—
125 Comm	1991	—	18-4231	18-3708-1	18-3741	18-3715
125 Comm	1992-96	18-4223	18-4231	18-3708-1	—	—
130	1995-99	18-4223	18-4231	18-3708-1	—	—
135	1973-76	18-4222	18-4228	18-3705	18-3742	18-3716
140	1977-84	18-4222	18-4228	18-3705	18-3742	18-3716
140	1985	18-4223	18-4231	18-3708-1	18-3741	18-3715
140	1986-94	18-4222	18-4228	18-3705	18-3742	18-3716
140	1990	18-4223	18-4231	18-3708-1	18-3741	18-3715
140	1992	—	18-4231	18-3708-1	—	—
150	1978-90	18-4223	18-4231	18-3708-1	18-3741	18-3715
150	1991-95	—	18-4231	18-3708-1	18-3741	18-3715
150	1996-99	18-4223	18-4231	18-3708-1	—	—
155 Comm	1984-90	18-4223	18-4231	18-3708-1	18-3741	18-3715
155 Comm	1991-95	—	18-4231	18-3708-1	18-3741	18-3715
175	1977-90	18-4223	18-4231	18-3708-1	18-3741	18-3715
175	1992	—	18-4231	18-3708-1	—	—
175	1993-99	18-4223	18-4231	18-3708-1	—	—
185	1984-85	18-4223	18-4231	18-3708-1	18-3741	18-3715
185 Comm	1991-95	—	18-4231	18-3708-1	18-3741	18-3715
200	1976-90	18-4223	18-4231	18-3708-1	18-3741	18-3715
200/225	1991-95	—	18-4231	18-3708-1	18-3741	18-3715
200/225	1996-99	18-4223	18-4231	18-3708-1	—	—
225	1986-90	18-4223	18-4231	18-3708-1	18-3741	18-3715
235	1978-85	18-4223	18-4231	18-3708-1	18-3741	18-3715
250/300	1991	18-4223	18-4231	18-3708-1	18-3741	18-3715
250/300	1992	—	18-4231	18-3708-1	—	—
250/300	1993-95	18-4223	18-4231	18-3708-1	—	—
250	1996-99	18-4223	18-4231	18-3708-1	—	—
2.6L	1984-85	18-4223	18-4231	18-3708-1	18-3741	18-3715
275	1986	18-4223	18-4231	18-3708-1	18-3741	18-3715
3.6L	1986-90	18-4223	18-4231	18-3708-1	18-3741	18-3715

OMC SEA DRIVE

V4	1982-90	18-4222	18-4228	18-3708-1	18-3742	18-3715
V6	1982-90	18-4223	18-4231	18-3708-1	18-3741	18-3715
V8	1987, 1989-90	18-4223	18-4231	—	—	—

- ① Models equipped with small gearcase
- ② Models equipped with large gearcase
- ③ Models equipped with V-6 gearcase
- ④ For 3-Blade propeller only
- ⑤ Use 18-4222 for 4-Blade propeller

- ⑥ All models except DR, DE & DT
- ⑦ Models DR, DE & DT only
- ⑧ Except models RSU, RSLU, RWENB, RWLENB
- ⑨ Except 1992 models WTLNE, WTXNENE
- ⑩ Models WTLNE, WTXNENE

- Ⓛ 1992 ES models only
- Ⓜ Except 1992 ESX models
- Ⓨ 1992 TL models only
- Ⓩ 1992 CX, TX models only

 <p>18-8304 OIL SEAL Replaces: 321830</p>	 <p>18-0195 THRUST WASHER Reverse & Forward Gear Replaces: 314731 For: 45-60 HP - 2 Cyl, 3 Cyl, V-4 & V-6</p>	 <p>18-0197 THRUST WASHER Forward Gear Replaces: 333725 For: 40-55 HP - 1989-1995</p>	 <p>18-0198 THRUST WASHER Forward Gear Replaces: 324766 For: 3 Cyl, V-4 & V-6</p>
 <p>18-0200 THRUST WASHER Drive Shaft Replaces: 327656 For: V-4 & V-6</p>	 <p>18-0201 THRUST WASHER Drive Shaft Replaces: 333771 For: 40-60 HP - 1990-1995</p>	 <p>18-1117 PINION BEARING Replaces: 387817</p>	 <p>18-1154 BALL BEARING Replaces: 377139</p>



18-1158
CARRIER BEARING
Replaces: 387247



18-1750
COMPLETE BEARING HOUSING
For: Cobra Drives & V6



18-1161
TAPERED ROLLER BEARING
Replaces: 983891



18-1299
LOWER MAIN BEARING
Replaces: 433503
For: V4 & V6 60° engines



18-1344
NEEDLE BEARING
Ref. # J-1812
Fits: Driveshaft bearing cup 18-4807
(OE# 439476)



18-1350
NEEDLE BEARING (CARRIER)
Replaces: 379504



18-1351
NEEDLE BEARING (CARRIER)
Replaces: 382407



18-1354
NEEDLE BEARING
Replaces: 386764



18-1355
NEEDLE BEARING
Replaces: 386765



18-1356
NEEDLE BEARING (PINION)
Replaces: 382343



18-1357
NEEDLE BEARING (PINION)
Replaces: 384195



18-1363
THRUST BEARING
Replaces: 397537



18-1364
THRUST BEARING
Replaces: 397538



18-1365
THRUST BEARING
Replaces: 387656



18-1366
THRUST BEARING
Replaces: 382408



18-1367
THRUST BEARING
Replaces: 385068



18-1368
THRUST BEARING
Replaces: 398901



18-1369
THRUST BEARING
Replaces: 432264



18-1370
THRUST FORWARD BEARING
Replaces: 389042



18-1371
THRUST FORWARD BEARING
Replaces: 385043

HP	Year	Drive Shaft Bearing	Pinion Gear Bearing	Fore Carrier Bearing	Aft Carrier Bearing	Fwd. Gear Thrust Bearing	Rev Gear Thrust Bearing	Fore Propshaft Bearing	Aft. Propshaft Bearing
25D	1989-95	18-1368	18-1356	18-1354	18-1355	18-1364	18-1363	18-1369	18-1351
35	1987	—	—	18-1354	18-1355	—	—	—	—
40	1984-88	—	—	18-1354	18-1355	—	—	—	—
40	1989-Up	18-1368	18-1356	18-1354	18-1355	18-1364	18-1363	18-1369	18-1351
45 Comm	1985-Up	—	18-1367	18-1356	18-1351	18-1350	18-1371	18-1366	—
48	1987-88	—	—	18-1354	18-1355	—	—	—	—
48	1989-96	18-1368	18-1356	18-1354	18-1355	18-1364	18-1363	18-1369	18-1351
50	1973-74	18-1367	18-1356	18-1351	18-1350	18-1366	18-1366	—	—
50	1975	—	—	18-1354	18-1355	—	—	—	—
50	1979-88	—	—	18-1354	18-1355	—	—	—	—
50	1989-Up	18-1368	18-1356	18-1354	18-1355	18-1364	18-1363	18-1369	18-1351
50 ①	1995-Up	18-1367	18-1356	18-1351	18-1350	18-1371	18-1366	—	—
55	1976-81	—	—	18-1354	18-1355	—	—	—	—
55 ②	1980-82	18-1367	18-1356	18-1351	18-1350	18-1366	18-1366	—	—
55 Comm	1983-Up	—	18-1367	18-1356	18-1351	18-1350	18-1371	18-1366	—
60 ②	1980-81	18-1367	18-1356	18-1351	18-1350	18-1366	18-1366	—	—
60	1980-85	—	—	18-1354	18-1355	—	—	—	—
60 ③	1986-87	—	—	18-1354	18-1355	—	—	—	—
60 ④	1986-97	18-1367	18-1356	18-1351	18-1350	18-1371	18-1366	—	—
65	1973	18-1367	18-1356	18-1351	18-1350	18-1371	18-1366	—	—
65 Comm	1984-97	—	18-1367	18-1356	18-1351	18-1350	18-1371	18-1366	—
70 ④	1974-97	18-1367	18-1356	18-1351	18-1350	18-1371	18-1366	—	—
70 ③	1979-85	—	—	18-1354	18-1355	—	—	—	—
75 ④	1975-88	18-1367	18-1356	18-1351	18-1350	18-1371	18-1366	—	—
75 ③	1979-87	—	—	18-1354	18-1355	—	—	—	—
85	1973-80	18-1365	18-1357	18-1351	18-1350	18-1371	18-1366	—	—
85	1991-95	18-1365	18-1357	18-1351	18-1350	18-1371	18-1366	—	—
88	1987-96	18-1365	18-1357	18-1351	18-1350	18-1371	18-1366	—	—
90	1981-97	18-1365	18-1357	18-1351	18-1350	18-1371	18-1366	—	—
100	1979-80	18-1365	18-1357	18-1351	18-1350	18-1371	18-1366	—	—
100	1990-94	18-1365	18-1357	18-1351	18-1350	18-1371	18-1366	—	—
100 Comm	1984-90	—	18-1365	18-1117	18-1351	18-1158	18-1370	18-1366	—
100 Comm ⑤	1989-90	—	18-1365	18-1357	18-1351	18-1350	18-1371	18-1366	—
100 Comm	1991-93	—	18-1365	18-1117	18-1351	—	18-1370	18-1366	—
110	1986-89	18-1365	18-1357	18-1351	18-1350	18-1371	18-1366	—	—
112	1994-95	18-1365	18-1357	18-1351	18-1350	18-1371	18-1366	—	—
115	1973-85	18-1365	18-1357	18-1351	18-1350	18-1371	18-1366	—	—
115	1990-95	18-1365	18-1357	18-1351	18-1350	18-1371	18-1366	—	—
120	1985	18-1365	18-1117	18-1351	18-1158	18-1370	18-1366	—	—
120	1986-92	18-1365	18-1357	18-1351	18-1350	18-1371	18-1366	—	—
125 Comm ⑤	1989-90	—	18-1365	18-1117	18-1351	18-1158	18-1370	18-1366	—
125 Comm ⑥	1989-90	—	18-1365	18-1357	18-1351	18-1350	18-1371	18-1366	—
125 Comm	1991-94	—	18-1365	18-1117	18-1351	—	18-1370	18-1366	—
125	1992	18-1365	18-1357	18-1351	18-1350	18-1371	18-1366	—	—
135	1973-76	18-1365	18-1357	18-1351	18-1350	18-1371	18-1366	—	—
140	1977-84	18-1365	18-1357	18-1351	18-1350	18-1371	18-1366	—	—
140	1985	18-1365	18-1117	18-1351	18-1158	18-1370	18-1366	—	—
140	1986-92	18-1365	18-1357	18-1351	18-1350	18-1371	18-1366	—	—
140 TX	1988-90	18-1365	18-1117	18-1351	18-1158	18-1370	18-1366	—	—
140 TX	1991-92	18-1365	18-1117	18-1351	—	18-1370	18-1366	—	—
150	1978-90	18-1365	18-1117	18-1351	18-1158	18-1370	18-1366	—	—
150	1991-95	18-1365	18-1117	18-1351	—	18-1370	18-1366	—	—
150 Comm	1993-95	—	18-1365	18-1117	18-1351	—	18-1370	18-1366	—
155 Comm	1984-90	—	18-1365	—	18-1351	18-1158	—	18-1366	—
155 Comm ⑤	1989-90	18-1365	18-1117	18-1351	18-1158	18-1370	18-1366	—	—
155 Comm ⑦	1989-90	18-1365	18-1117	18-1351	18-1158	18-1370	18-1366	—	—
175	1977	18-1365	18-1117	18-1351	18-1158	—	18-1366	—	—
175	1978-90	18-1365	18-1117	18-1351	18-1158	18-1370	18-1366	—	—
175	1991-97	18-1365	18-1117	18-1351	—	18-1370	18-1366	—	—
185	1984-85	18-1365	18-1117	18-1351	18-1158	18-1370	18-1366	—	—
185	1990	18-1365	18-1117	18-1351	18-1158	18-1370	18-1366	—	—
185	1992-94	18-1365	18-1117	18-1351	—	18-1370	18-1366	—	—
200	1976-77	18-1365	18-1117	18-1351	18-1158	—	18-1366	—	—
200	1978-90	18-1365	18-1117	18-1351	18-1158	18-1370	18-1366	—	—
200	1991-97	18-1365	18-1117	18-1351	—	18-1370	18-1366	—	—
200 Comm	1990-91	—	18-1365	18-1117	18-1351	18-1158	18-1370	18-1366	—
225	1986-90	18-1365	18-1117	18-1351	18-1158	18-1370	18-1366	—	—
225	1991-97	18-1365	18-1117	18-1351	—	18-1370	18-1366	—	—
235	1978-85	18-1365	18-1117	18-1351	18-1158	18-1370	18-1366	—	—

① 3 Cyl. Models ③ 15" Transom Models ⑤ WTP Models ⑦ WTA Models Only
 ② Rope Start Models ④ 20" Transom Models ⑥ ESX Models ⑧ Models with "S" Prefix Only

OUTBOARD SHAFTS



18-1723
LOWER DRIVE SHAFT

Replaces: 346004
For: V4 60" includes: E100, E115, E75, E 90, J115 & J90



18-2277
LOWER DRIVE SHAFT

Replaces: 335722



18-2279
LOWER DRIVE SHAFT

Replaces: 335679



18-9219
LOWER DRIVE SHAFT

Replaces: 335677



18-1722
DRIVE SHAFT

Replaces: 438399
For: 20" Models, 40-50HP (1997-99)



18-1721
DRIVE SHAFT

Replaces: 433067
For: 20" Models, 40-50(1989-92)



18-2325
UPPER DRIVE SHAFT ASSEMBLY

Replaces: 435760



18-2326
UPPER DRIVE SHAFT ASSEMBLY

Replaces: 436232



18-2327
UPPER DRIVE SHAFT ASSEMBLY

Replaces: 436234



18-2328
UPPER DRIVE SHAFT ASSEMBLY

Replaces: 435761



18-2330
UPPER DRIVE SHAFT ASSEMBLY
(Extra Long)

Replaces: 436235



18-2093
SEAL

Replaces: 319664, 333096, 398051
For: 20 - 35 HP(1977-95) seal for prop-shaft 18-2026, driveshaft 18-2033, upper crankcase 18-8351

HP	Year	Lower Drive Shaft	Upper Drive Shaft	Upper Drive Shaft (Extra Long)	HP	Year	Lower Drive Shaft	Upper Drive Shaft	Upper Drive Shaft (Extra Long)
85 TTL	1991	18-2277	—	—	140 TX	1990-91	18-9219	—	—
85 TTL	1992-95	18-2277	18-2326	—	140 TL	1991-94	18-2277	18-2326	—
88	1991	18-2277	—	—	140 TX	1992-94	18-9219	—	—
88	1992-96	18-2277	18-2326	—	150	1990	18-9219	—	—
90	1991	18-2277	—	—	150	1991	18-9219	—	—
90	1992-97	18-2277	18-2326	—	150	1992-97	18-9219	18-2327	18-2330
90 ① ②	1995-96	—	18-2327	—	150 Comm	1993-95	18-9219	18-2327	18-2330
90 ② ③	1995-96	18-9219	—	18-2330	155 Comm	1990	18-2279③	—	—
90 ②	1997	18-2277	18-2326	—	155 Comm ⑤	1990	18-9219	—	—
100	1991	18-2277	—	—	155 Comm	1991	18-9219	—	—
100	1992-94	18-2277	18-2326	—	155 Comm	1992	18-9219	18-2326	—
100 Comm	1991	18-9219	—	—	175	1990	18-9219	—	—
100 Comm	1992-97	18-9219	18-2326	—	175	1991	18-9219	—	—
112	1994-96	18-2277	18-2326	—	175	1992-97	18-9219	18-2327	18-2330
115	1991	18-2277	—	—	185	1990	18-9219	—	—
115	1992-97	18-2277	18-2326	—	185	1991	18-9219	—	—
115 ① ②	1995-96	—	18-2327	—	185	1992-94	18-9219	18-2326	—
115 ② ③	1995-96	18-9219	—	18-2330	200	1990	18-9219	—	—
115 ②	1997	18-2277	18-2326	—	200	1991	18-9219	—	—
120	1991-93	18-2277	—	—	200	1992-97	18-9219	18-2326	—
120 ④	1993	18-9219	—	—	200 Comm	1990	18-9219	—	—
120 TL	1994	18-2277	18-2326	—	225	1990	18-9219	—	—
120 TX	1994	18-9219	—	—	225	1991	18-9219	—	—
125 Comm	1991-95	18-9219	18-2326	—	225	1992-97	18-9219	18-2326	—
125	1992-93	18-2277	—	—	250	1991-95	18-2279	—	—
125 ④	1993	18-9219	—	—	250	1997	18-2279	—	—
125	1994	18-2277	18-2326	—	300	1990	18-2279	—	—
130	1995-97	18-9219	18-2326	—	300	1991-95	18-2279	—	—

① 20° Models ② 60 Degree V Models ③ 25° Models ④ F Suffix Only ⑤ WTP Models Only

**18-1725
PROP SHAFT**

Replaces: 436834
For: V4 60HP



**18-2187
PROP SHAFT**

Replaces: 395209, 391472



**18-2250
PROP SHAFT**

Replaces: 387879



**18-2251
PROP SHAFT**

Replaces: 435022, 433017, 436740



**18-2252
PROP SHAFT**

Replaces: 387818, 436888



**18-2355
PROP SHAFT**

Replaces: 386659
For: 35, 40, 48, 50, 55, 60, 70, 75 HP 2 & 3 cyl. outboards (1975-1987)



**18-2288
PROP SHAFT**

Replaces: 397541, 439138



PROP SHAFT APPLICATION BEGINS ON PAGE 356



**18-1287
FORWARD GEAR & BUSHING**

Replaces: 392475
For: 25-35HP (1975-88)



**18-1291
GEAR SET**

For: Commercial V4 gearcases

— CONTAINS —

Part #	Desc.	O.E.#
NSS	Forward Gear	435123
NSS	Reverse Gear	336574
18-2216	Clutch	337774



**18-1292
GEAR SET**

For: Late model V-6 150-225 H.P. with large reverse gear

— CONTAINS —

Part #	Desc.	O.E.#
NSS	Forward Gear	5004216
NSS	Reverse Gear	336561



**18-1293
GEAR SET**

For: 20HP (1984-98), 25HP(1985-02),
30HP (1984-02) 35HP (1984-01)

— CONTAINS —

Part #	Desc.	O.E.#
18-1287	Forward Gear	392475
18-1289	Reverse Gear	327655
18-1288	Pinion	328313
18-1290	Clutch	337020



**18-1288
PINION GEAR**

Replaces: 328313
For: 25-35HP (1984-96)



**18-2208
REVERSE GEAR**

Replaces: 318304



**18-2209
SLIDING CLUTCH**

Replaces: 318303



**18-2216
SLIDING CLUTCH**

Replaces: 337772, 337774, 334516,
336562, 910995



**18-2217
GEAR SET**

— CONTAINS —

Part #	Desc.	O.E.#
NSS	Forward Gear	435020
NSS	Reverse Gear	910994
18-2215	Sliding Clutch	337772



**18-2218
FORWARD GEAR SET**

Replaces: 434063, 989966,
985050, 436746
Includes: Forward & Pinion Gears



**18-2219
REVERSE GEAR**

Replaces: 333077, 317838, 340490



**18-2220
SLIDING CLUTCH**

Replaces: 323664, 320630



**18-2221
GEAR SET**

— CONTAINS —

Part #	Desc.	O.E.#
18-2218	Forward Gear	434063
18-2219	Reverse Gear	333077
18-2220	Sliding Clutch	323664



**18-2287
CLUTCH DOG**

Replaces: 319895



**18-2308
SLIDING CLUTCH**

Replaces: 332491



18-1289
REVERSE GEAR
Replaces: 327655
For: 25-35HP (1984-96)



18-2309
REVERSE GEAR
Replaces: 332489



18-2290
GEAR SET
— CONTAINS —

Part #	Desc.	O.E.#
NSS	Forward Gear Set	435020, 434026, 983141, 391289
NSS	Reverse Gear	336561
18-2216	Sliding Clutch	337774, 334516, 336562, 910795, 337772



18-1290
CLUTCH DOG
Replaces: 337020
For: 25-35HP (1992-98)



18-2310
FORWARD GEAR SET
Replaces: 397627
Includes: Forward & Pinion Gears



18-2315
GEAR SET
— CONTAINS —

Part #	Desc.	O.E.#
18-2310	Forward Gear Set	397627
18-2309	Reverse Gear	332489
18-2308	Sliding Clutch	332491



18-1500
INTAKE WATER SCREEN
Replaces: 337778
For: 100, 120, 125, 140, 150, 175, 200, 225 (1993) (OMC Cobra & V-6)



18-79989
TRAILERING STICKS
Fits: Most outboards over 150hp with three ram intrinsic tilt/trim.



18-1343
BEARING CARRIER RETAINING TAB
Replaces: 333957
For: 100, 120, 125, 140, 150, 175, 200, 225, (1998-92) (Cobra Drives)



18-1712
BEARING RETAINER
Replaces: 980014
For: 100, 120, 140, 165, 175, 190, 225, 235 (1968-77)



18-4807
DRIVESHAFT BEARING RETAINER CAP
Replaces: 439476
To replace bearing use **18-1344**



18-3766
SHIFT CRADLE
Replaces: 334163
For: V-4/V-6, Cobra, Stringer



18-3765
HOUSING PIN
Replaces: 331880
For: 18-3767 bearing housing



18-71102
CONTROL BOX REPAIR KIT
For: OMC 397272 + 390610



18-2243
18-2243-9[Ⓢ]
DETENT BALL
Replaces: 316506
9.9 - 35 HP



18-2398
RETAINING SPRING
Replaces: 320311
For: 2 & 3 CYL.



18-2399
RETAINING SPRING
Replaces: 324369
For: V-4 & V-6

ALL FORWARD GEARS INCLUDE PINION GEARS

HP	Year	Model	Prop Shaft	Gear Set	Fwd. Gear	Rev. Gear	Clutch
20	1985-95	ALL		18-1293	18-1287 Ⓓ	18-1289	18-1290
25	1985-95	ALL		18-1293	18-1287 Ⓓ	18-1289	18-1290
25D	1989-95	ALL	18-2288	18-2315	18-2310	18-2309	18-2308
30	1984-96	ALL		18-1293	18-1287 Ⓓ	18-1289	18-1290
35	1984-94	ALL Ⓓ		18-1293	18-1287 Ⓓ	18-1289	18-1290
35	1987	AE, AR, AT	—	—	—	—	18-2287
40	1984-88	ALL	—	—	—	—	18-2287
40	1989-97	ALL	18-2288	18-2315	18-2310	18-2309	18-2308
48	1987-88	ALL	—	—	—	—	18-2287
48	1989-96	ALL	18-2288	18-2315	18-2310	18-2309	18-2308
50	1975	ALL	—	—	—	—	18-2287
50	1979-88	ALL	—	—	—	—	18-2287
50	1989-97	2 Cyl.	18-2288	18-2315	18-2310	18-2309	18-2308
50	1997	3 Cyl.	18-2250	—	—	18-2208	18-2209
55	1976-78	ALL	—	—	—	—	18-2287
60	1980-85	Electric Start	—	—	—	—	18-2287
60	1986-87	Ⓓ	18-2250	—	—	18-2208	18-2209
60 Ⓓ	1986-87	3 Cyl.	—	—	—	—	18-2287
60	1988-97	ALL	18-2250	—	—	18-2208	18-2209
65	1984	ALL	18-2250	—	—	18-2208	18-2209
65	1987	ALL	18-2250	—	—	18-2208	18-2209
65	1990-91	ALL	18-2250	—	—	18-2208	18-2209
65 COMM	1985-97	ALL	18-2250	—	—	18-2208	18-2209
65 COMM Remote	1992-95	ALL	18-2250	—	—	18-2208	18-2209
65 COMM Rope	1992-95	ALL	18-2250	—	—	18-2208	18-2209
70	1975	Ⓓ	N/A	—	—	18-2208	18-2209
70	1976	ALL	N/A	—	—	18-2208	18-2209
70	1977-85	Ⓓ	18-2250	—	—	18-2208	18-2209
70 Ⓓ	1979-85	ALL	—	—	—	—	18-2287
70	1986-97	ALL	18-2250	—	—	18-2208	18-2209
70TTL	1982-95	ALL	18-2250	—	—	18-2208	18-2209
75 Ⓓ	1975-87	ALL	—	—	—	—	18-2287
75	1976	Ⓓ	N/A	—	—	18-2208	18-2209
75	1977	Ⓓ	18-2250	—	—	18-2208	18-2209
75	1978-80	Ⓓ	18-2250	—	—	18-2208	18-2209
75	1982-87	Ⓓ	18-2250	—	—	18-2208	18-2209
75	2000-01	FPX & FX	18-2251	18-1291	—	—	18-2216
85	1973-77	ALL	—	—	—	18-2219	—
85	1978-80	ALL	18-2252	18-2221	18-2218	18-2219	18-2220
85	1991-95	ALL	18-2252	18-2221	18-2218	18-2219	18-2220
88	1987-96	ALL	18-2252	18-2221	18-2218	18-2219	18-2220
90	1981-98 Ⓓ	ALL	18-2252	18-2221	18-2218	18-2219	18-2220
90	1995-01	25" Transoms	18-2251	18-1291	—	—	18-2216
90	1999	ALL	18-1725	18-2221	18-2218	18-2219	18-2220
100	1979-80,90-95	ALL	18-2252	18-2221	18-2218	18-2219	18-2220
100 COMM	1984-90	ALL	18-2187	—	—	—	18-2216
100 COMM	1989-90,1998	Ⓓ	18-2252	18-2221	18-2218	18-2219	18-2220
100 COMM	1993-01	ALL	18-2251	18-1291	—	—	18-2216
105 JET	1992	ALL	18-2251	18-2217	—	—	18-2216
105	1997-99	ALL	18-2251	18-1291	—	—	18-2216
105 COMM	2000-01	ALL	18-2251	18-1291	—	—	18-2216
110	1986-89	ALL	18-2252	18-2221	18-2218	18-2219	18-2220

Ⓓ Models with "E" suffix only
 Ⓔ Models with "WTP" only
 Ⓕ Models with "S" prefix only
 Ⓖ Models "ESX" only

Ⓗ All models except "ESX"
 Ⓖ 20" Transom only
 Ⓗ All models except 140TX
 Ⓗ 15" Models

Ⓗ 1993 Models "ESX" "F" suffix only
 Ⓗ Except 1999 "FCX" Models
 Ⓗ Except 1998 "FSX" Models
 Ⓗ Models with "F" suffix only

Ⓗ Models with "S" suffix only
 Ⓗ Fits new style reverse gear with 6 clutch ears only
 Ⓗ Except AE, AR & AT models
 Ⓗ Pinion 18-1288 sold separately

ALL FORWARD GEARS INCLUDE PINION GEARS

HP	Year	Model	Prop Shaft	Gear Set	Fwd. Gear	Rev. Gear	Clutch
112	1994-96	ALL	18-2252	18-2221	18-2218	18-2219	18-2220
115	1973-76	ALL	—	—	—	18-2219	—
115	1977	ALL	18-2252	—	—	18-2219	18-2220
115	1978-85, 1990-98	ALL	18-2252	18-2221	18-2218	18-2219	18-2220
115	1995-01	25° Transoms	18-2251	18-1291	—	—	18-2216
115	1999	20° 60 degree V4	18-2252	18-2221	18-2218	18-2219	18-2216
115	1999	25° 60 degree V4	18-2251	—	—	—	18-2216
120	1985	ALL	—	—	—	—	18-2216
120	1986-92	ALL	18-2252	18-2221	18-2218	18-2219	18-2220
120	1993-94	TL & TX ⓐ	18-2252	18-2221	18-2218	18-2219	18-2220
120	1993-94	TX ⓐ	18-2251	18-1291	—	—	18-2216
125 COMM	1989-90	ⓐ	18-2252	18-2221	18-2218	18-2219	18-2200
125 COMM	1989-90	ⓑ	18-2187	—	—	—	18-2216
125 COMM	1992-94, 1996	ⓒ	18-2251	—	—	—	18-2216
125	1991	ⓓ	18-2251	—	—	—	18-2216
125	1991-95	ⓔ ⓕ	18-2252	18-2221	18-2218	18-2219	18-2220
125	1993-95	ⓖ	18-2251	18-1291	—	—	18-2216
125	1996-98	ALL	18-2251	18-1291	—	—	18-2216
130	1995-01	TL & TX & 25°	18-2251	18-1291	—	—	18-2216
135	2001	ALL	18-2251	18-1291	—	—	18-2216
140	1977	ALL	18-2252	—	—	—	18-2220
140	1978-84, 1986-87	ALL	18-2252	18-2221	18-2218	18-2219	18-2220
140	1985	ALL	18-2187	—	—	—	18-2216
140	1986-94	ⓗ	18-2252	18-2221	18-2218	18-2219	18-2220
140	1988-90	TX	18-2187	—	—	—	18-2216
140	1993-94	TX ⓐ	18-2251	18-1291	N/A	N/A	18-2216
150	1978-79	ALL	—	—	—	—	18-2216 ⓑ
150	1980-87	CHECK O.E.	18-2187	18-2217	—	—	18-2216
150	1988-89, 90	ALL	18-2187	18-2217	—	—	18-2216
150	1991-99 ⓑ	ALL	18-2251	18-2290	—	—	18-2216
150	2004	ALL	18-2251	18-1292	N/A	N/A	18-2216
150 COMM	1993-96	ALL	18-2251	18-2290	—	—	18-2216
155 COMM	1984-88	ALL	18-2187	—	—	—	18-2216
155 COMM WTP	1986-88	ALL	18-2187	—	—	—	18-2216
155 COMM							
WTL & WTX	1989-90	ALL	18-2187	—	—	—	18-2216
155 COMM	1989-90	ⓓ	18-2187	18-2217	—	—	18-2216
155 COMM	1991-92	ALL	18-2251	18-2290	—	—	18-2216
175	1977	ALL	—	N/A	N/A	N/A	18-2220
175	1978-83	ALL	—	—	—	—	18-2216 ⓑ
175	1986-90	ALL	18-2187	18-2217	—	—	18-2216
175/185	1991-99 ⓑ	ALL	18-2251	18-2290	—	—	18-2216
185	1984-85	ALL	18-2187	18-2217	—	—	18-2216
200	1979-86	ALL	—	18-2217	—	—	18-2216
200	1988-90	ALL	18-2187	18-2217	—	—	18-2216
200	1991-99	ALL	18-2251	18-2290	—	—	18-2216
200	2002-03	ALL	18-2251	18-1292	N/A	N/A	18-2216
220	1987	ALL	18-2187	18-2217	—	—	18-2216
225	1986-87	ALL	—	18-2217	—	—	18-2216
225	1988-89	ALL	18-2187	18-2217	—	—	18-2216
225	1991-99	ALL	18-2251	18-2290	—	—	18-2216
225	2002-04	ALL	18-2251	18-1292	N/A	N/A	18-2216

ⓐ Models with "WTP" only
 ⓑ Models with "S" prefix only
 ⓒ Models "ESX" only
 ⓓ All models except "ESX"

ⓔ 20° Transom only
 ⓕ All models except 140TX
 ⓖ 15° Models
 ⓗ 1993 Models "ESX" "F" suffix only

ⓓ Except 1999 "FCX" Models
 ⓔ Except 1998 "FSX" Models
 ⓕ Models with "F" suffix only
 ⓖ Models with "S" suffix only

ⓗ Fits new style reverse gear with 6 clutch ears only
 ⓘ Except AE, AR & AT models
 ⓙ Pinion 18-1288 sold separately

ALL FORWARD GEARS INCLUDE PINION GEARS

HP	Year	Model	Prop Shaft	Gear Set	Fwd. Gear	Rev. Gear	Clutch
235	1979-85	ALL	—	18-2217	—	—	18-2216
250	1991-99	ALL	18-2251	—	—	—	18-2216
250	2002-03	ALL	18-2251	18-1292	N/A	N/A	18-2216
275	1985-88	ALL	18-2251	—	—	—	18-2216
3.8L	1985-87	ALL	18-2251	—	—	—	18-2216
300	1988-95	ALL	18-2251	—	—	—	18-2216

- ① Models with "E" suffix only
- ② Models with "WTP" only
- ③ Models with "S" prefix only
- ④ Models "ESX" only

- ⑤ All models except "ESX"
- ⑥ 20" Transom only
- ⑦ All models except 140TX
- ⑧ 15" Models

- ⑨ 1993 Models "ESX" "F" suffix only
- ⑩ Except 1999 "FCX" Models
- ⑪ Except 1998 "FSX" Models
- ⑫ Models with "F" suffix only

- ⑬ Models with "S" suffix only
- ⑭ Fits new style reverse gear with 6 clutch ears only
- ⑮ Except AE, AR & AT models
- ⑯ Pinion 18-1288 sold separately

SEA DRIVE SHAFTS AND GEARS

HP	Year	Model	Prop Shaft	Gear Set	Fwd. Gear	Rev. Gear	Clutch
1.6	1990 ①	ALL	18-2252	18-2221	18-2218	18-2219	18-2220
2	1990 ②	ALL	18-2187	—	—	—	18-2216
2	1990 ①	ALL	18-2187	—	—	—	18-2216
3	1990 ①	ALL	18-2187	18-2217	—	—	18-2216
3	1990	ALL	18-2187	18-2217	—	—	18-2216
4	1990	ALL	18-2187	—	—	—	18-2216
1.6	1989	ALL	18-2252	18-2221	18-2218	18-2219	18-2220
2	1989	ALL	18-2187	—	—	—	18-2216
3	1989	ALL	18-2187	18-2217	—	—	18-2216
4	1989	ALL	18-2187	—	—	—	18-2216
1.6	1988	ALL	18-2252	18-2221	18-2218	18-2219	18-2220
2	1988	ALL	18-2187	—	—	—	18-2216
3	1988	ALL	18-2187	18-2217	—	—	18-2216
1.6	1987	ALL	18-2252	18-2221	18-2218	18-2219	18-2220
1.8	1987	ALL	18-2252	18-2221	18-2218	18-2219	18-2220
2.7	1987	ALL	18-2187	18-2217	—	—	18-2216
3.6	1987	ALL	18-2187	—	—	—	18-2216
1.6	1986	ALL	18-2252	18-2221	18-2218	18-2219	18-2220
2.6	1986	ALL	18-2187	18-2217	—	—	18-2216
1.6 V-4	1985 ③	ALL	18-2252	18-2221	18-2218	18-2219	18-2220
2.6 V-6	1985 ④	ALL	18-2187	—	—	—	18-2216
2.5/2.6	1985 ①	ALL	18-2187	—	—	—	18-2216
1.6 V-4	1984 ⑤	ALL	18-2252	18-2221	18-2218	18-2219	18-2220
2.6 V-6	1984 ⑥	ALL	18-2187	—	—	—	18-2216
2.5/2.6	1984 ③	ALL	18-2187	—	—	—	18-2216
1.6	1983	ALL	18-2252	18-2221	18-2218	18-2219	18-2220
2.6	1983	ALL	N/A	—	—	—	18-2216
2.5/2.6	1982	ALL	—	—	—	—	18-2216

① Models with "E" suffix only

② Models with "WTP" only

③ Models with "S" prefix only

④ Models "ESX" only





18-6526
THROTTLE CABLE (38")
Replaces: 397004
For: 6 & 8 HP models from 1988 - 1990

THROTTLE CABLE APPLICATION

HP	Year Start	Year Stop	Throttle Cable	HP	Year Start	Year Stop	Throttle Cable
6	1985	1990	18-6526	14	1988	1989	18-6526
8	1985	1990	18-6526				

SHIMS

	Part #	Desc.	O.E. #	I.D.	Part #	Desc.	O.E. #	I.D.
	18-2224 ^①	.003 Shim	320166	1.58	18-2229 ^{① ②}	.003 Shim	323362	1.24
	18-2225 ^①	.004 Shim	320167	1.56	18-2230	.004 Shim	323361	1.24
	18-2226 ^①	.005 Shim	320168	1.53	18-2231	.005 Shim	314745	1.24
	18-2227 ^①	.006 Shim	320169	1.53	18-2232	.003 Shim	323889	1.22
	18-2228	.007 Shim	320170	1.53	18-2233	.004 Shim	323890	1.22
					18-2234 ^{① ②}	.005 Shim	317232	.22

HP	Year	0.003 Shim	0.004 Shim	0.005 Shim	0.006 Shim	0.007 Shim
60	1980-1987	18-2224	18-2225	18-2226	18-2227	18-2228
60	1988-95	18-2232	18-2233	18-2234	—	—
60SST	1989-1990	18-2224	18-2225	18-2226	18-2227	18-2228
60TTL	1992	18-2232	18-2233	18-2234	—	—
65C	1984-91,93-95	18-2232	18-2233	18-2234	—	—
65C	1992	18-2232	18-2233	18-2234	—	—
70	1975-76	18-2232	18-2233	18-2234	—	—
70	1977-85	18-2224	18-2225	18-2226	18-2227	18-2228
70	1986-95	18-2232	18-2233	18-2234	—	—
70TTL	1992	18-2232	18-2233	18-2234	—	—
75	1975-1988	18-2224	18-2225	18-2226	18-2227	18-2228
85	1975-79	18-2229	18-2230	18-2231	—	—
85	1980,91	18-2229	18-2230	18-2231	—	—
85TTL	1992-95	18-2229	18-2230	18-2231	—	—
88	1987-95	18-2229	18-2230	18-2231	—	—
90	1981-95	18-2229	18-2230	18-2231	—	—

① STD. PKG OF 2 ② Includes 1 each of 18-2229, 18-2230 & 18-2231
 ③ This product is priced per piece. To order priced per package, please add -9 to the part number
APPLICATION CONTINUED ON NEXT PAGE

HP	Year	0.003 Shim	0.004 Shim	0.005 Shim	0.006 Shim	0.007 Shim
100	1979	18-2229	18-2230	18-2231	—	—
100	1980,90-95	18-2229	18-2230	18-2231	—	—
100C	1984-87,89-95	18-2229	18-2230	18-2231	—	—
100PLY	1989	18-2229	18-2230	18-2231	—	—
105JET	1992-93	18-2229	18-2230	18-2231	—	—
110	1986-89	18-2229	18-2230	18-2231	—	—
115	1980-85,90-95	18-2229	18-2230	18-2231	—	—
115	1975-79	18-2229	18-2230	18-2231	—	—
120	1985-95	18-2229	18-2230	18-2231	—	—
125, 125C	1989-95	18-2229	18-2230	18-2231	—	—
125ESX	1989-90	18-2229	18-2230	18-2231	—	—
125WTPL	1990	18-2229	18-2230	18-2231	—	—
135	1975-76	18-2229	18-2230	18-2231	—	—
140	1977-79	18-2229	18-2230	18-2231	—	—
140	1980-95	18-2229	18-2230	18-2231	—	—
150	1979-95	18-2229	18-2230	18-2231	—	—
150C	1986-91,95	18-2229	18-2230	18-2231	—	—
155C	1984-87,89-95	18-2229	18-2230	18-2231	—	—
175	1977	18-2229	18-2230	18-2231	—	—
175	1978-88,90-95	18-2229	18-2230	18-2231	—	—
185	1984-85,90-95	18-2229	18-2230	18-2231	—	—
200	1976-77	18-2229	18-2230	18-2231	—	—
200	1978-83,86-95	18-2229	18-2230	18-2231	—	—
200C	1990	18-2229	18-2230	18-2231	—	—
225	1986-93	18-2229	18-2230	18-2231	—	—
235	1978-85	18-2229	18-2230	18-2231	—	—
1600cc	1988	18-2229	18-2230	18-2231	—	—
2500cc	1988	18-2229	18-2230	18-2231	—	—

① STD PKG OF 2 ② Includes 1 each of 18-2229, 18-2230 & 18-2231

③ This product is priced per piece. To order priced per package, please add -9 to the part number

Zinc is for saltwater only applications.
Magnesium is for fresh water only applications.
Aluminum is for brackish water, or if boat is used in both fresh and salt environments.

 <p>③ 18-6115 ANODE TRANSOM BRACKET Replaces: 433580 For: 60-225 (1991-93) For use on Stern Bracket</p>	 <p>③ 18-6017 ① 18-6017A ② 18-6100 ANODE Replaces: 173029, 123009 (1981-91) 9.9-115 HP For use on gearcase and transom bracket assembly</p>	 <p>18-6018 ANODE Replaces: 327606 1983-89 2HP, For Motor Leg</p>
 <p>③ 18-6024 ① 18-6024A ANODE Replaces: 393023, 436745 (1982-87) 60-300 HP For use on gearcases</p>	 <p>③ 18-6025 ANODE Replaces: 433458, 398331 (1987-92) 60-300HP For use on Stern Bracket</p>	 <p>② 18-6026 ANODE Replaces: 392462 For exhaust housing, 2 & 3 Cyl. (1984-99)</p>
 <p>③ 18-6095 ① 18-6095A ANODE Replaces: 431708 (1988-90) 45-300 HP For use on Prop Shaft Bearing Carrier</p>	 <p>③ 18-6020 ANODE Replaces: 976669 (1969-89) Kit for V4 & V6</p>	 <p>③ 18-6027 ANODE Replaces: 392123 (1982-98) 40-300 HP Front Lower Leg Extension</p>

① Aluminum ② Magnesium ③ Zinc

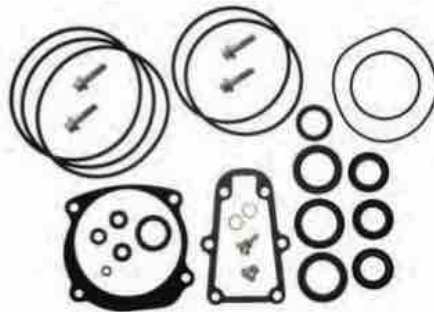

18-2623
LOWER UNIT SEAL KIT
Replaces: 439141

-- CONTAINS --			
Part #	Desc.	O.E. #	Qty.
18-0110	Shift Housing Gasket	314082	1
18-2001	Seal	330137	2
18-2002	Seal	320862	2
18-2026	Seal	321453	2
18-2061	Seal	329922	1
18-2062	Seal	329923	1
18-2377	Screw	316563	4
18-2378	Magnetic Drain Screw	318544	1
18-2536	O-Ring	315788	1
18-2557	Impeller Gasket	338484	1
18-4248	Washer	311598	2
18-7109	O-Ring	317178	1
18-7120	O-Ring	307853	1
18-7127	O-Ring	313446	1
18-7130	O-Ring	314728	1
18-7133	O-Ring	305123	2
18-7137	O-Ring	318372	2
18-7142	O-Ring	322119	1
18-7144	O-Ring	333572	3
18-7145	O-Ring	332584	1
18-7475	Washer	328743	4
18-8300	Seal	341280	1
18-8301	Seal	341281	1



18-2656
LOWER UNIT SEAL KIT
Replaces: 396350

-- CONTAINS --			
Part #	Desc.	O.E. #	Qty.
18-2025	Oil Seal	318971	1
18-2028	Oil Seal	321480	2
18-2029	Oil Seal	321481	2
18-4248	Washer	311598	2
18-7100	O-Ring	301877	1
18-7104	O-Ring	308627	1
18-7120	O-Ring	307853, 322598	1
18-7139	O-Ring	319085	1
18-7145	O-Ring	333572	2

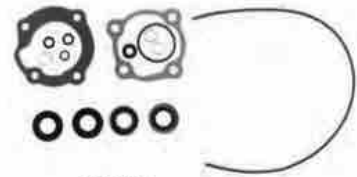

18-2657
LOWER UNIT SEAL KIT
Replaces: 396352

-- CONTAINS --			
Part #	Desc.	O.E. #	Qty.
18-0882	Shift Rod Gasket	304764	1
18-0108	Lower Gearcase Gasket	324449	1
18-3360	Impeller Housing Gasket	320390	1
18-7411	O-Ring	321459	2
18-2027	Oil Seal	321459	2
18-2031	Oil Seal	321787	1
18-2063	Oil Seal	330327	1
18-4248	Washer	311598	2
18-7100	O-Ring	301877	1
18-7145	O-Ring	333572	2
18-7475	Quad Ring	332583	1



18-2658
LOWER UNIT SEAL KIT
Replaces: 396351

— CONTAINS —

Part #	Desc.	O.E. #	Qty.
18-0124	Impeller Plate Gasket	325537	1
18-2026	Oil Seal	321453	2
18-2033	Oil Seal	321928	1
18-2065	Oil Seal	332261	1
18-2539	Rubber Seal	328753	1
18-4248	Washer	311598	2
18-7100	O-Ring	301877	1
18-7105	O-Ring	311338	2
18-7108	O-Ring	313893	1
18-7109	O-Ring	311718	3
18-7145	O-Ring	333572	2
18-7146	O-Ring	554545	1
18-7180	O-Ring	303347	1
18-2030	Oil Seal	321786	1
18-2027	Oil Seal	321469	1



18-2659
LOWER UNIT SEAL KIT
Replaces: 396355

— CONTAINS —

Part #	Desc.	O.E. #	Qty.
18-0989	Impeller Housing Gasket	319586	1
18-2059	Oil Seal	321466	1
18-2060	Oil Seal	321467	2
18-2064	Oil Seal	332205	1
18-2532	Foam Seal	305782	1
18-2537	Rubber Seal	324937	1
18-2855	Shift Housing Cover to Gear Case Gasket	314082	1
18-4248	Washer	311598	2
18-7115	O-Ring	302588	1
18-7120	O-Ring	307853	1
18-7137	O-Ring	318372	1
18-7140	O-Ring	320303	1
18-7145	O-Ring	333572	2
18-7475	Quad Ring	332584	3

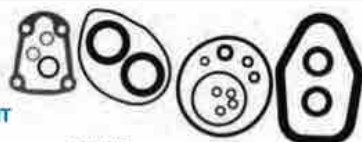

18-2660
LOWER UNIT SEAL KIT
Replaces: 396349

— CONTAINS —

Part #	Desc.	O.E. #	Qty.
18-2059	Oil Seal	321466	1
18-2064	Oil Seal	332205	1
18-2537	Rubber Seal	324937	1
18-2855	Shift Housing Cover to Gearcase Gasket	314082	1
18-4248	Washer	311598	2
18-7120	O-Ring	307853	1
18-7127	O-Ring	313446	1
18-7128	O-Ring	313754	1
18-7137	O-Ring	318372	1
18-7145	O-Ring	333572	2
18-7475	Quad Ring	332584	4
18-7174	O-Ring	910582, 326649	1
18-2001	Oil Seal	330137	2



18-2679
LOWER UNIT SEAL KIT

— CONTAINS —

Part #	Desc.	O.E. #	Qty.
18-2022	Oil Seal	303345	1
18-2035	Oil Seal	327031	1
18-2891	Bearing Housing Gasket	303339	1
18-4248	Washer	311598	2
18-7100	O-Ring	301877	1
18-7117	O-Ring	303360	1
18-7120	O-Ring	307853	1
18-2534	Spaghetti Seal	309044	1

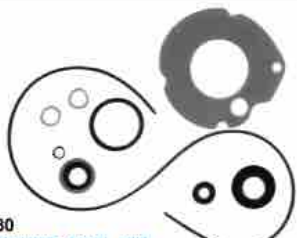

18-2680
LOWER UNIT SEAL KIT

— CONTAINS —

Part #	Desc.	O.E. #	Qty.
18-2023	Oil Seal	313282	1
18-2035	Oil Seal	327031	1
18-2891	Bearing Housing Gasket	303339	1
18-4248	Washer	311598	2
18-7100	O-Ring	301877	1
18-7117	O-Ring	303360	1
18-7120	O-Ring	307853	1
18-2534	Spaghetti Seal	309044	1

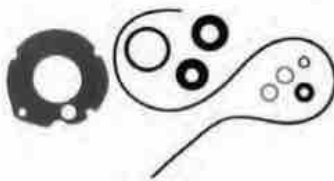

18-2681
LOWER UNIT SEAL KIT

— CONTAINS —

Part #	Desc.	O.E. #	Qty.
18-2023	Oil Seal	313282	1
18-2024	Oil Seal	314167	1
18-2891	Bearing Housing Gasket	303339	1
18-4248	Washer	311598	2
18-7100	O-Ring	301877	1
18-7117	O-Ring	303360	1
18-7120	O-Ring	307853	1
18-2534	Spaghetti Seal	309044	1

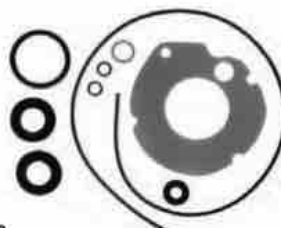

18-2682
LOWER UNIT SEAL KIT

— CONTAINS —

Part #	Desc.	O.E. #	Qty.
18-2022	Oil Seal	303345	2
18-2891	Bearing Housing Gasket	303339	1
18-4248	Washer	311598	2
18-7100	O-Ring	301877	1
18-7117	O-Ring	303360	1
18-7120	O-Ring	307853	1
18-2534	Spaghetti Seal	309044	1



18-2683
LOWER UNIT SEAL KIT

— CONTAINS —

Part #	Desc.	O.E. #	Qty.
18-2023	Oil Seal	313282	2
18-2891	Bearing Housing Gasket	303339	1
18-4248	Washer	311598	2
18-7100	O-Ring	301877	1
18-7117	O-Ring	303360	1
18-7120	O-Ring	307853	1
18-2534	Spaghetti Seal	309044	1

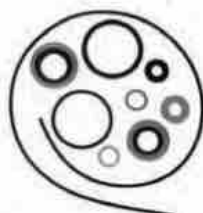

18-2684
LOWER UNIT SEAL KIT

— CONTAINS —

Part #	Desc.	O.E. #	Qty.
18-0882	Shift Rod Gasket	304764	1
18-2032	Oil Seal	321788	1
18-4248	Washer	311598	2
18-7100	O-Ring	301877	1
18-7120	O-Ring	307853	1
18-2031	Oil Seal	321787	1
18-2534	Spaghetti Seal	309044	1



18-2685
LOWER UNIT SEAL KIT

— CONTAINS —

Part #	Desc.	O.E. #	Qty.
18-2030	Oil Seal	321786	3
18-2031	Oil Seal	321787	1
18-4248	Washer	311598	2
18-7100	O-Ring	301877	1
18-7112	O-Ring	302493	1
18-7120	O-Ring	307853	1
18-2534	Spaghetti Seal	309044	1
18-0882	Shift Rod Gasket	304764	1



18-2686
LOWER UNIT SEAL KIT

-- CONTAINS --

Part #	Desc.	O.E. #	Qty.
18-0992	Shift Rod Gasket	304764	1
18-2005	Oil Seal	313284	1
18-2021	Oil Seal	302584	1
18-4248	Washer	311598	2
18-7100	O-Ring	301877	1
18-7115	O-Ring	302588	1
18-7120	O-Ring	307853, 322598	1



18-2687
LOWER UNIT SEAL KIT

-- CONTAINS --

Part #	Desc.	O.E. #	Qty.
18-2005	Oil Seal	313284	1
18-4248	Washer	311598	2
18-7120	O-Ring	307853, 322598	1
18-7152	O-Ring	307082	1
18-2027	Oil Seal	321459	1
18-7143	O-Ring	322601	1
18-0173	Oil Seal	313283	1
18-7428	Rubber Seal	307103	1



18-2688
LOWER UNIT SEAL KIT

-- CONTAINS --

Part #	Desc.	O.E. #	Qty.
18-2027	Oil Seal	321459	2
18-2855	Shift Housing Cover to Gearcase Gasket	314082	1
18-4248	Washer	311598	2
18-7100	O-Ring	301877	1
18-7109	O-Ring	317178	4
18-7127	O-Ring	313446	1
18-7128	O-Ring	313754	1
18-2001	Oil Seal	330137	2
18-7129	O-Ring	314491	1

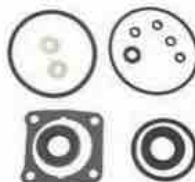

18-2689
LOWER UNIT SEAL KIT

-- CONTAINS --

Part #	Desc.	O.E. #	Qty.
18-0173	Oil Seal	313283	1
18-0174	Oil Seal	326716	1
18-0886	Lower Gearcase Gasket	307099	1
18-4248	Washer	311598	2
18-7115	O-Ring	302588	1
18-7118	O-Ring	305242	1
18-7120	O-Ring	307853, 322598	4
18-7152	O-Ring	307082	1
18-7428	O-Ring	307103	1

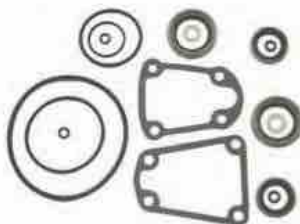

18-2690
LOWER UNIT SEAL KIT

-- CONTAINS --

Part #	Desc.	O.E. #	Qty.
18-2855	Shift Housing Cover to Gearcase Gasket	314082	1
18-2874	Solenoid Cover Gasket	314876	1
18-4248	Washer	311598	2
18-7120	O-Ring	307853, 322598	4
18-7127	O-Ring	313446	1
18-7129	O-Ring	314491	1
18-7130	O-Ring	314728	1
18-7126	O-Ring	313340	1



18-2691
LOWER UNIT SEAL KIT

-- CONTAINS --

Part #	Desc.	O.E. #	Qty.
18-2874	Solenoid Cover Gasket	314876	1
18-4248	Washer	311598	2
18-7109	O-Ring	317178	4
18-7127	O-Ring	313446	1
18-2001	Oil Seal	330137	2
18-7130	O-Ring	314728	1
18-2059	Oil Seal	321466	2



18-2692
LOWER UNIT SEAL KIT

-- CONTAINS --

Part #	Desc.	O.E. #	Qty.
18-0110	Shift Housing Gasket	324670	1
18-2026	Oil Seal	321453	2
18-2874	Solenoid Cover Gasket	314876	1
18-4248	Washer	311598	2
18-7109	O-Ring	317178	4
18-7120	O-Ring	322598	1
18-7127	O-Ring	313446	1
18-7130	O-Ring	314728	1
18-7137	O-Ring	318372	1
18-2001	Oil Seal	330137	2



18-2694
LOWER UNIT SEAL KIT
Replaces: 433550

-- CONTAINS --

Part #	Desc.	O.E. #	Qty.	Part #	Desc.	O.E. #	Qty.
18-2708	Wear Plate Gasket	336530	1	18-7481	Seal	315788	1
18-7115	O-Ring	302588	1	18-2708	Seal	333758	1
18-7127	O-Ring	313446	1	18-2059	Oil Seal	321466	2
18-7120	O-Ring	307853, 322598	1	18-2018	Oil Seal	0767970	2
18-7172	O-Ring	553126	1	18-2064	Oil Seal	332205	1
18-7197	O-Ring	318372	1	18-2705	Seal	315748	1
18-7475	O-Ring	332584	1	18-4248	Washer	311598	1
				18-7173	O-Ring	310327, 910582	1

APPLICATION BEGINS ON PAGE NEXT PAGE



18-2595
SHIFT ROD & WEAR PLATE GASKET SET
 Replaces: 982132

18-2595 SHIFT ROD & WEAR PLATE GASKET SET APPLICATION					
HP	YEARS	HP	YEARS	HP	YEARS
85	1978-80	125	1989-90	225	1986-90
88	1987-90	140	1977-90	235	1978-85
90	1981-90	150	1978-90	275	1985-90
100	1979-90	155C	1984-90	3.6L	1985-90
100C	1984-89	175	1977-90	300	1985-90
110	1986-89	185	1984-90		
115	1978-90	200	1976-90		

120 1985-90

OIL SEALS



Part #	O.E. #	Shaft Size	Dimensions (in)		Part #	O.E. #	Shaft Size	Dimensions (in)	
			O.D.	Width				O.D.	Width
18-0173	313283	0.795	1.320	0.307	18-2059	318223, 321466	0.750	1.126	0.200
18-0174	326716	0.750	1.382	0.242	18-2060	303804, 321467	1.000	1.375	0.250
18-0542	321831, 315288	0.750	1.253	0.186	18-2061	329922	0.822	1.375	0.195
18-0543	321895, 313507	1.540	1.926	0.243	18-2062	329923	0.875	1.375	0.207
18-0559	332585	0.285	0.357	0.940	18-2063	330327	0.625	1.124	0.188
18-2000	309989	1.375	2.000	0.313	18-2064	332205	0.730	1.130	0.194
18-2001	330137	1.125	1.624	0.250	18-2065	332261	0.625	1.375	0.195
18-2002	320862	1.188	1.692	0.250	18-2066	911019	1.000	1.375	0.435
18-2005	313284	0.625	1.128	0.250	18-2067	911685	2.000	2.509	0.315
18-2012	310599	1.000	1.499	0.250	18-2068	911701	0.500	0.905	0.250
18-2016	313992	1.187	1.875	0.250	18-2068	915702	0.500	0.905	0.250
18-2018	305987	1.000	1.375	0.250	18-2068	916058	0.500	0.905	0.250
18-2020	310649	2.500	3.000	0.250	18-2068	3853655	.500	.905	.250
18-2021	313258	0.750	1.375	0.250	18-2071	981195	1.500	2.125	0.250
18-2022	303345	0.554	1.000	0.375	18-2072	981196	1.750	2.502	0.250
18-2023	313282	0.554	1.062	0.312	18-2073	981268	1.625	2.502	0.250
18-2024	314167	0.425	0.937	0.312	18-2074	318451, 339620	1.625	2.125	0.250
18-2025	318972	0.500	0.875	0.250	18-2075	353076, 326751	1.562	2.062	0.300
18-2026	317843, 321453	0.875	1.250	0.188	18-8300	341280	0.866	1.378	0.280
18-2027	305306, 321459	0.625	1.125	0.250	18-8301	341281	1.220	1.693	0.280
18-2028	318973	0.500	1.250	0.188	18-8304	321830	20.37mm	31.8mm	6.35mm
18-2029	319256, 321481	0.687	1.250	0.250	18-8307	331103	1.100	1.628	0.448
18-2030	321786	0.625	1.125	0.188	18-8325	342786	28mm	41.5mm	7/11
18-2031	321787	0.625	1.125	0.312	18-8326	342787	18mm	29mm	8/12
18-2032	321788	0.500	1.000	0.188	18-8349	911795			
18-2033	321928	0.625	1.375	0.250	18-8350	3852548	1.375	2.186	0.500
18-2034	324639	0.437	0.937	0.188	18-8351	328603	1.100	1.690	0.320
18-2035	300599, 327031	0.425	0.875	0.313	18-8351	321504, 308500	1.110	1.570	0.320
18-2058	313353	1.938	2.438	0.250	18-8367	334950	1.250	1.687	0.250

OIL SEAL APPLICATION

HP	YEARS	PROPSHAFT	QTY.	DRIVESHAFT	QTY.	UPPER CRANKCASE	QTY.	LOWER CRANKCASE	QTY.
1.5,2,2.5,3	1958-68	-	1	18-2035	1	-	-	-	-
1.5,2	1968-90	18-2035	1	18-2035	1	-	-	-	-
2.5,4	② 1973-80	18-2035	1	18-2035	2	-	-	-	-
2.5	1987	18-2034	2	18-2035	2	-	-	-	-
2.5,4	② 1981-95	-	1	18-2035	2	-	-	-	-
3 Weedless	1958-68	18-2035	1	-	-	-	-	-	-
3,4,6 Weedless	1968-82	18-2024	1	18-2024	1	-	-	-	-
4	1981-90	18-2034	2	-	-	-	-	-	-
4	1984, 1986-95	-	-	18-2034	2	-	-	-	-
4.5,7.5	1980-87	-	1	18-2034	2	-	-	-	-
5.5,5.6,7.5	① 1957-64	18-2022	1	18-2035	1	-	-	-	-
5,6,8	1980-87	-	-	18-2034	2	-	-	-	-
6	1965-67	-	1	18-2023	1	-	-	-	-
6	1968-79	18-2023	1	18-2024	1	-	-	-	-
9.5	1964-73	18-2022	1	18-2022	1	-	-	-	-
9.9	1974-83	18-2029	1	18-2028	1	18-8304	-	18-0542	1
9.9	1984-95	18-2029	1	18-2028	1	18-8304	-	18-0542+18-2032	1
10	1957-58	18-2005	1	18-2032	1	-	-	-	-
10	1959-63	18-2022	1	18-2022	1	-	-	-	-

① 1968 Models 5802M,3M,6802C,3C

② Standard Gearcase

OIL SEAL APPLICATION (Cont.)

HP	YEARS	PROPSHAFT	QTY.	DRIVESHAFT	QTY.	UPPER CRANKCASE	QTY.	LOWER CRANKCASE	QTY.
10	1981	18-2023 (inner)	1	-	-	18-8304	-	18-0542	1
10	1989	18-2031+18-2027	1	18-2063+18-2027	1	18-8304	-	18-0542+18-2032	1
14	1988-90	18-2031+18-2027	1	18-2063+18-2027	1	18-8304	-	18-0542+18-2032	1
15	1974-83	18-2029	2	18-2028	1	18-8304	-	18-0542	1
15	1984-95	18-2029	2	18-2028	1	18-8304	-	18-0542+18-2032	1
18	1957	18-2005	1	18-2032	1	18-2060	1	-	-
18	1958-73	18-2005	1	18-2032	1	18-2018	1	-	-
20	1981-82	18-2031+18-2030	1	18-2030	1	18-8351	-	-	-
20	1983	18-2031+18-2030	1	18-2027+18-2030	1	18-8351	-	-	-
20	1984	18-2025+18-2027	1	18-2063+18-2030	1	18-8351	-	-	-
20	1985-86	18-2026	1	18-2033	1	18-8350	-	-	-
20	1987-95	18-2026	1	18-2033+18-2065	1	18-8350	-	-	-
25	1969-76	18-2005	1	18-2032	1	18-2018	1	-	-
25	1977-78	18-2005	1	18-2032	1	18-8351	-	-	-
25	1979-82	18-2031+18-2030	1	18-2030	1	18-8351	-	-	-
25	1983	18-2031+18-2030	1	18-2027+18-2030	1	18-8351	-	-	-
25	1984	18-2031+18-2027	1	18-2063+18-2030	1	18-8351	-	-	-
25	1985-86	18-2026	1	18-2033	2	18-8351	-	-	-
25	1987-95	18-2026	1	18-2033+18-2065	1	18-8351	-	-	-
25C	1982	18-2030	1	18-2030	1	18-8351	-	-	-
25C	1983	18-2031+18-2027	1	18-2027+18-2030	1	18-8350	-	-	-
25C	1984-90	18-2031+18-2027	1	18-2063+18-2027	1	18-8350	-	-	-
28	1962-64	18-2021	1	18-2005	1	18-8351	-	-	-
28	1987-90	18-2031+18-2027	1	18-2063+18-2027	1	18-8350	-	-	-
30	1984-86	18-2026	1	18-2033	1	18-8350	-	-	-
30	1987-95	18-2026	1	18-2033 (inner)	1	18-8350	-	-	-
33	1965-76	18-2021	1	18-2005	1	18-8351	-	-	-
35	1957-59	18-2021	1	18-2005	1	18-2018	1	-	-
35	1976	18-2026	1	18-2027	2	18-8351	-	-	-
35	1977-86	18-2026	2	18-2033	2	18-8351	-	18-2093	-
35	1987-90	18-2026	2	18-2033 (inner)	1	18-8350	-	18-2093	-
40	1960-61	18-2021	1	18-2005	1	18-2018	1	-	-
40	1962-73	18-2021	1	18-2005	1	18-8351	-	-	-
40	1974-76	18-2021	1	18-2029	1	18-0543	1	18-2001	1
40C	1981-86	18-2021	1	18-2029	2	18-0543	1	18-2001	2
40	1984-85	18-2060	2	18-2059	2	18-0543	1	18-2001	1
40 (AR,AE,AT)	1988	18-2001	1	18-2063+18-2027	1	18-0543	1	18-8307	-
40	1986-89	18-2060	2	18-2064+18-2059	1	18-0543	1	18-8307	-
45C	1985	18-2001	2	18-2063+18-2027	1	18-0543	1	18-8307	-
45C	1986	18-2001	2	18-2064+18-2059	1	18-0543	1	18-8307	-
45C	1987	18-2001	2	18-2063+18-2027	1	18-0543	1	18-8307	-
45C	1988-94	18-2001	2	18-2063+18-2027	1	18-0543	1	18-2001	-
45C	1995	18-2001	2	18-2064+18-2059	1	18-0543	1	-	-
48	1988-95	18-2060	2	18-2064+18-2059	1	18-0543	1	18-2063 (inner)	1
50	1971-74	18-2001 (Manual)	2	18-2027	2	18-0543	1	18-2001	1
50	1975	18-2060	2	18-2059	1	18-0543	1	18-2001	1
50	1979	18-2001	2	18-2027	2	18-0543	1	18-2001	1
50	1980	18-2060	2	18-2059	1	18-0543	1	18-2001	1
50/60 (rope start)	1981-83	18-2001	2	18-2027	1	18-0543	1	18-2001	1
50/60 (Electric)	1981-83	18-2060	2	18-2059	1	18-0543	1	18-2001	1
50/60	1984-85	18-2060	2	18-2059	1	18-0543	1	18-2001	1
50/60 Small Gearcase	1986-87	18-2060	2	18-2064+18-2059	1	18-0543	1	18-2001	1
50/60 Large Gearcase	1986-87	18-2001	2	18-2064+18-2059	1	18-0543	1	18-2001	1
50/60	1988-89	18-2001	2	18-2064+18-2059	1	18-0543	1	18-2001	1
50	1990-95	18-2060	2	18-2064+18-2059	1	18-0543	1	18-2063 (inner)	1
55	1968-69	18-2012	2	18-2059	2	18-0543	1	18-2001	1
55	1976-77	18-2060	2	18-2059	2	18-0543	1	18-2001	1
55	1978	18-2059	1	18-2059	2	18-0543	1	18-2001	1
55	1979-83	18-2001	2	18-2027	1	18-0543	1	18-2001	1
55 (Electric)	1980-83	18-2012	2	18-2059	2	18-0543	1	18-2001	1
55C	1984	18-2001	2	18-2063+18-2027	1	18-0543	1	18-2001	1
55C	1985	18-2001	2	18-2063	1	18-0543	1	18-2001	1
55C	1986	18-2001	2	18-2064+18-2059	1	18-0543	1	18-8307	-
55C	1987-94	18-2001	2	18-2063+18-2027	1	18-0543	1	18-8307	-
55C	1995	18-2001	2	18-2064+18-2059	1	18-0543	1	-	-
60 (Manual Shift)	1964-68	18-0173	1	18-0174	1	-	-	-	-
60	1970	18-2012	1	18-2059	2	18-0543	1	18-2001	1
60 (3 Cylinder)	1971	18-2001	2	18-2059	2	18-0543	1	18-2001	1
60 (Rope)	1980-83	18-2001	2	18-2027	2	18-0543	1	18-2001	1
60 (Electric)	1980-83	18-2001	2	18-2059	2	18-0543	1	18-2001	1

OIL SEAL APPLICATION (Cont.)

HP	YEARS	PROPSHAFT	QTY.	DRIVESHAFT	QTY.	UPPER CRANKCASE	QTY.	LOWER CRANKCASE	QTY.
60	1984-85	18-2060	2	18-2059	2	18-0543	1	18-2001	1
60SST	1989	18-2060	2	18-2064+18-2059	1	18-0543	1	18-2001	1
60SST	1990	18-2060	2	18-2064+18-2059	1	18-0543	1	18-8307	-
60 (3 Cylinder)	1987-95	18-2001	2	18-2064+18-2059	1	18-0543	1	18-8307	-
65 (Manual Shift)	1968	18-0173	1	18-0174	1	18-0543	1	-	-
65 (3 Cylinder)	1972-73	18-2001	2	18-2059	2	18-0543	1	18-2001	1
65C	1984-85	18-2001	2	18-2059	2	18-0543	1	18-2001	1
65C	1986-89	18-2001	2	18-2064+18-2059	1	18-0543	1	18-2001	1
70 (Large Gearcase)	1974-85	18-2001	2	18-2059	2	18-0543	1	18-2001	1
70 (Large Gearcase)	1986-95	18-2001	2	18-2064+18-2059	1	18-0543	1	18-8307	-
70 (Small Gearcase)	1977-85	18-2060	2	18-2059	2	18-0543	1	18-8307	-
75 (Manual Shift)	1960-62	18-0173	1	18-0174	1	-	-	-	-
75 (Large Gearcase)	1975-84	18-2001	2	18-2059	2	18-0543	1	18-2001	1
75 (Large Gearcase)	1986-87	18-2001	2	18-2064+18-2059	1	18-0543	1	18-8307	-
75 (Small Gearcase)	1975-84	18-2060	2	18-2059	2	18-0543	1	18-2001	1
80	1966-68	18-0173	1	18-0174	1	-	-	-	-
85	1969-70	18-2012	2	18-2059	2	18-2074	1	18-2001	1
85	1971-72	18-2001	2	18-2059	2	18-2074	1	18-2001	1
85	1973-80	18-2001	2	18-2026	2	18-2074	2	18-2001	1
88	1987-94	18-2001	2	18-2061+18-2062	1	18-2074	2	18-8307	-
90	1981-83	18-2001	2	18-2026	2	18-2074	2	18-2001	1
90	1984-94	18-2001	2	18-2061+18-2062	1	18-2062	1	18-8307	-
90 Seadrive	1985-90	18-2001	2	18-2061+18-2062	1	18-2074	2	18-2001	1
100	1971-72	18-2001	2	18-2059	2	18-2074	1	18-2001	1
100	1979-80	18-2001	2	18-2026	2	18-2074	2	18-2001	1
100C	1984-90	18-2002	2	18-2061+18-2062	1	18-2074	2	18-8307	-
110	1986-88	18-2001	2	18-2061+18-2062	1	18-2074	2	18-2001	1
115	1969-70	18-2012	2	18-2059	2	18-2074	1	18-2001	1
115	1973-83	18-2001	2	18-2026	2	18-2074	1	18-2001	1
115	1984-85	18-2001	2	18-2061+18-2062	1	18-2074	2	18-2001	1
115	1990-94	18-2001	2	18-2061+18-2062	1	18-2074	2	18-8307	-
120	1985	18-2002	2	18-2061+18-2062	1	18-2074	2	18-2075	2
120	1986-88	18-2001	2	18-2061+18-2062	1	18-2074	2	18-2075	2
120	1989	18-2002	2	18-2061+18-2062	1	18-2074	2	18-2075	2
120	1990-94	18-2001	2	18-2061+18-2062	1	18-2074	2	18-2075	2
125	1971-72	18-2001	2	18-2059	2	18-2074	1	18-2001	1
125C	1989	18-2002	2	18-2061+18-2062	1	18-2074	2	18-2075	1
125C (ESX models)	1989	18-2001	2	18-2061	1	18-2062	1	18-2075	1
135	1973-76	18-2001	2	18-2026	2	18-2074	2	18-2001	1
140	1977-83	18-2001	2	18-2026	2	18-2074	2	18-2001	1
140	1984	18-2001	2	18-2026	2	18-2074	2	18-2001	1
140	1985	18-2002	2	18-2061+18-2062	1	18-2074	2	18-2075	2
140	1986-94	18-2001	2	18-2061+18-2062	1	18-2074	2	18-2075	2
140TX	1989	18-2002	1	18-2061+18-2061	1	18-2074	2	18-2075	2
150	1978-83	18-2002	2	18-2026	2	18-2074	2	18-2075	2
150	1984	18-2002	2	18-2061+18-2062	1	18-2074	2	18-2075	2
150	1985-90	18-2002	2	18-2061+18-2062	1	18-2074	2	18-8307	-
155C	1984-85	18-2002	2	18-2061+18-2062	1	18-2074	2	18-2001	1
155C	1986-90	18-2002	2	18-2061+18-2062	1	18-2074	2	18-8307	-
175	1977-85	18-2002	2	18-2026	2	18-2074	2	18-2001	1
175	1986-90	18-2002	2	18-2061+18-2062	1	18-2074	2	18-8307	-
185	1984-85	18-2002	2	18-2061+18-2062	1	18-2074	2	18-2001	1
185	1990	18-2002	2	18-2061+18-2062	1	18-2074	2	18-2075	1
200	1976-83	18-2002	2	18-2026	2	18-2074	2	18-2001	1
200	1984-85	18-2002	2	18-2061+18-2062	1	18-2074	2	18-8307	-
200,225	1986-90	18-2002	2	18-2061+18-2062	1	18-2074	2	18-2075	2
235	1978-83	18-2002	2	18-2026	2	18-2074	2	18-2001	1
235	1984-85	18-2002	2	18-2061+18-2062	1	18-2074	2	18-2001	1
275	1985-88	18-2002	2	18-2061+18-2062	1	18-2074	2	18-2075	2

OIL SEAL APPLICATION - DRIVESHAFT HOUSING

HP	Years	Sierra Oil Seal	Qty.	Desc.	HP	Years	Sierra Oil Seal	Qty.	Desc.
5/6/6.5/8 ①	1987-90	18-2034	1	EH,L	75/80/85	1961-68	18-2060	1	PS
45/55 ①	1990	18-2063	1	EH A	90/100	1964-68	18-2060	1	PS
50/60/65	1958-68	18-2060	1	PS					

① Commercial models also
PS Pivot shaft

EH A Exhaust housing to adapter
EH,L Driveshaft to exhaust housing

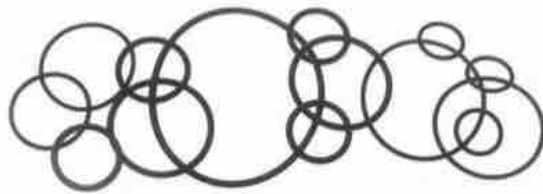

O-RINGS

Part #	O.E. #	Dimensions (in)	
		I.D.	Width
18-7100	301877	.245	.155
18-7101	305739	.250	.065
18-7102	307450	.430	.065
18-7103	308624	.924	.103
18-7104	308627	2.210	.135
18-7105	311338	.750	.065
18-7107	313175	4.750	.135
18-7108	313893	2.550	.100
18-7108	338518	2.550	.100
18-7109	317178	.214	.048
18-7111	301824	.197	.113
18-7112	302493	1.170	.135
18-7114	302540	1.000	.135
18-7115	302588	1.735	.135
18-7116	303067	.360	.100
18-7117	303360	1.060	.135
18-7118	305242	.300	.135
18-7120	307853	.215	.065
18-7121	308621	3.100	.135
18-7123	308876	2.235	.100
18-7126	313340	1.690	.100
18-7127	313446	3.315	.135
18-7128	313754	1.835	.100
18-7129	314491	.970	.065
18-7130	314728	2.125	.100
18-7133	305123	3.780	.135
18-7133	322119	3.780	.135
18-7134	303059	.500	.100
18-7135	310584	.750	.135
18-7137	318372	0.320	.155
18-7138	318717	1.500	.210
18-7139	319085	1.080	.210
18-7140	320303	2.750	.135
18-7141	321117	.180	.065
18-7142	322119	3.940	.135
18-7143	322501		
	331188	1.310	.100
18-7144	326849	4.250	.135
18-7145	333572	.250	.100
18-7146	554545	1.120	.100
18-7150	303598	.225	.115
18-7150	331380	.225	.115
18-7150	334913	.225	.115
18-7152	307082	2.625	.135
18-7153	911851	.862	.103
18-7153	3852565	.862	.103
18-7155	305270	1.620	.135
18-7156	309731	1.185	.100
18-7158	310967	.740	.100
18-7158	310585	.740	.100
18-7162	302337	2.025	.135
18-7164	302537	1.375	.100
18-7165	304174	.500	.065
18-7167	310414	3.625	.135
18-7168	202893	.370	.065
18-7169	911686	3.500	.135
18-7170	307239	1.359	.139
18-7172	553126	3.250	.135
18-7173	310327	1.875	.135
18-7174	910582	.620	.100
18-7174	326649	.620	.100
18-7178	320140	.920	.135
18-7180	303347	.445	.090
18-7198	308626	1.430	.100
18-7400	908194	4.000	.100
18-7401	908383	2.485	.100
18-7403	909316	1.500	.100
18-7404	909747	.300	.100
18-7406	911311	0.250	.065
18-7407	911700	4.125	.135
18-7407	3852531	4.125	.135
18-7408	911718	1.060	.100
18-7409	911871	1.175	.100
18-7411	321921	1.237	.103
18-7413	303191	.301	.070
18-7416	329380	.612	.103
18-7417	329381	.362	.103
18-7418	326741	4.484	.139
18-7440-1	301967	.799	.103
18-7457	319662	1.799	.103
18-7461	308458	1.612	.103
18-7475	332584	.250	.065
18-7477	909048	.480	.100
18-7510	321163	2.750	.070

① PKG. OF 1 ② PKG. OF 5 ③ PKG. OF 10 ④ PKG. OF 2 ■ Indicates quad rings rather than O-Rings
 ⑤ This product is priced per piece. To order priced per package, please add -9 to the part number.

POWERHEAD				
HP	YEAR	O RING	QTY	DESC
5.5	1959	18-7180	1	LC
9.5	1964-73	18-7156	1	UC
18	1957-72	18-7114	1	CCH
18/25	1957-76	18-7164	1	LLC
20/25	① 1977,79-90	18-7174	1	LC
20/25	1990-95	18-7146	1	CCH O
25/35	1957,69-76	18-7114	1	CCH
25/18	1971-76	18-7164	1	UC
25	② 1989-90	18-7123	1	CCH
25	② 1989-90	18-7457	1	UC
25/35	1978	18-7134	1	LC
28	1962-64	18-7164	1	LLC
28/30/35	1976-77,79-90	18-7174	1	LC
28/30/35	1990-95	18-7146	1	CCH O
33/35/40	1957-75	18-7164	1	LLC
35	1987	18-7128	1	UC
35	1987	18-7123	1	CCH
40/45	① 1976,81-95	18-7123	1	CCH
40)	① 1976,81-95	18-7128	1	UC
45/45SS	① 1985-95	18-7128	1	UC
45SS/48	1987-95	18-7123	1	CCH
48/50/55	① 1971-95	18-7128	1	UC
50	1958-59	18-7133	1	CCH
50/55	① 1968-90	18-7123	1	CCH
55/60	1968-71	18-7117	1	CCH O
60/65/75/80	1960-68	18-7133	2	CCH
60/SST60	1970-71,81-95	18-7128	1	UC
60/SST60	1970-95	18-7123	1	CCH
60/SST60	1989-90	18-7158	1	LC
65	① 1972-73,85-95	18-7123	1	CCH
65	① 1972-73,85-95	18-7128	1	UC
65/70	① 1989-90	18-7158	1	LC
70	1974-90	18-7123	1	CCH
70	1974-90	18-7128	1	UC
75	1975-88	18-7128	1	UC
75	1975-88	18-7123	1	CCH
V-4	1969-71	18-7117	1	CCH O
85	1968-80	18-7133	4	CCH
88/90/100	① 1964,81-95	18-7133	4	CCH
100	1966	18-7120	4	CCHS
110/115	1969-95	18-7133	4	CCH
125/135/140	1971-84	18-7133	4	CCH
150/155/175	① 1977-90	18-7133	4	CCH
200/235/185	1976-85	18-7133	4	CCH

CCH S Crankcase Head Screw
 LC Lower Crankshaft
 LLC Large Lower Crankshaft
 ① Commercial Models Only

CCH O Crankcase Head Outer
 UC Upper Crankshaft
 CCH Crankcase Head
 ② 88 Models DR, DE, DT

POWERHEAD				
HP	YEAR	O RING	QTY	DESC
4	1969-90	18-7111	1	FC
5 THRU 300	① 1957-90	18-7111	2	FC
20/25/30	1984-86	18-7101	1	EPMV
35/40	1984-86	18-7101	1	EPMV
45	① 1986-87	18-7101	1	EPMV
50	1985-86	18-7101	1	EPMV
55	① 1986-88	18-7101	1	EPMV
60/65/70	① 1985-86	18-7101	1	EPMV
75	1983-86	18-7101	1	EPMV
V-4/6	① 1980-86	18-7101	1	EPMV
200/225	1986-88	18-7115	1	EPP
V-8	1985-86	18-7115	1	EPP

① Commercial Models Also
 EPMV Electric Fuel Primer Manual Valve

FC Fuel Connector
 EPP Electric Primer Pump

POWER TILT AND TRIM				
HP	YEAR	O RING	QTY	DESC
35/40/45	① 1986-89	18-7168	1	LA
45SS	1988-90	18-7134	1	TEC
45SS	1988	18-7141	4	OL
50/55/60	① 1981-89	18-7168	1	LA
60/70/75	1981-90	18-7174	2	MVS,L
60/70/75	1981-90	18-7141	4	OL
60/70/75	1981-90	18-7165	2	MVS,S
60/70/75	1981-90	18-7102	1	FP
70/75	1981	18-7174	1	TR
V-4/6	① 1977-79	18-7168	3	RV
V-4/6	① 1977-90	18-7174	1	TR
V-4/6/8	1977-90	18-7174	2	MVS,L
V-4/6/8	① 1977-90	18-7102	1	FP
V-4/6/8	① 1977-90	18-7165	2	MVS,S
V-4/6/8	① 1977-90	18-7141	4	OL
85	1976-79	18-7168	1	LA
115/135	1974-77	18-7168	1	LA
200	1976	18-7168	3	RV
200/300	1990	18-7168	3	RV

① Commercial Models Also
 TEC Trim End Cap to Rod
 LA Line Assembly
 RV Relief Valve

MVS,L Manifold Valve Seat, Large
 MVS,S Manifold Valve Seat, Small
 TR Trim rod
 OL Oil Line

FP Fill Plug

POWER STEERING				
HP	YEAR	O RING	QTY	DESC
60/70/75	1981-90	18-7168	4	CP
V-4/6/8	1980-90	18-7168	4	CP
V-6/8	1986-90	18-7129	2	SC
V-6/8	1986	18-7135	3	PVHT

CP Pump Control Piston
 RV Pump Hsg. Relief Valve
 SV Spoon Valve

SC Steering Cylinder
 PVHT Piston to Valve Hsg. Tube Seal

DRIVESHAFT HOUSING				
HP	YEAR	O RING	QTY	DESC
2.5	1987-88	18-7101	1	SS
4	③ 1981-90	18-7101	1	SS
4	② 1984,86-90	18-7168	1	K&S
4	④ 1984,86-90	18-7146	2	SB
4.5	1980-84,86-87	18-7168	1	K&S
4.5	1980-87	18-7146	2	SB
4.5	1980	18-7146	1	EHC
5	1984-90	18-7168	1	K&S
5	1984-90	18-7146	2	SB
6	1984-90	18-7168	1	K&S
6	1984-90	18-7146	2	SB
6.5	① 1989-90	18-7168	1	K&S
6.5	① 1989-90	18-7146	2	SB
7.5	1980-83	18-7146	2	SB
7.5	1980-83	18-7168	1	K&S
7.5	1980	18-7146	1	EHC
8	1984-90	18-7146	2	SB
8	1984-90	18-7168	1	K&S
28	1962-64	18-7115	1	SB
33	1965-70	18-7115	1	SB
35	1959	18-7114	1	PS
40	1960-70	18-7102	1	SS
40	1961-70	18-7114	1	PS
40	⑤ 1971-76,81-90	18-7115	1	SB
45SS	1987,88	18-7115	1	SB
60	1964-67	18-7180	4	SA
65	1968	18-7180	4	SA
75	1960-61,64-65	18-7180	4	SA
80	1966-67	18-7180	4	SA

DRIVESHAFT HOUSING (Cont.)

HP	YEAR	O RING	QTY	DESC
85	1968	18-7180	4	SA
90	1964-65	18-7180	4	SA
100	1966-68	18-7180	4	SA

- ① Commercial
- ② 'RD' Models Only
- ③ 'BR' 'RL' 'RC' 'RE' Models Only
- ④ 'R' 'RD' Models Only
- ⑤ '82-90 Commercial
- EHC Exhaust Housing Cover
- K&S Knob & Shaft to Swivel Bracket
- PS Pivot Shaft
- SS Shift Shaft
- SA Shock Absorber
- SB Swivel Bracket

GEARCASE (Cont.)

HP	YEAR	O RING	QTY	DESC
25	1989-90	18-7137	1	SR
28/33	1962-63,65-67	18-7165	1	WT E
28/33	1962-70	18-7134	1	DS CC
28/33/35	1962-70	18-7115	1	PBH
28	1963-64	18-7100	1	SR
28	1987-95	18-7475	1	SR PP
30/35/33	1965-70,84-85	18-7120	1	SR PP
30/33	1965-95	18-7100	1	SR
30/35	1976-86	18-7109	2	PBH S
30/35	1976-95	18-7108	1	PBH
30/35	1976-95	18-7105	2	IH S
30/35	1983-95	18-7180	1	SR S
30	1984-90	18-7146	1	IH
30/35	1986-95	18-7475	1	SR PP
30/35	1986-95	18-7100	1	IH
30/35	1987-95	18-7145	2	D&F S
35	1957-58	18-7165	1	WT E
35	1957-59,87	18-7134	1	DS CC
35/40	1957-90	18-7100	1	SR
35	1976-77	18-7174	1	DS CC
35	1983-84,86-90	18-7146	1	IH
35	1987	18-7140	1	PBH
35	1987	18-7137	1	SR
35	1987	18-7115	1	DS BH
35	1987,90	18-7475	1	BS
35	1987-90	18-7475	2	PBH S
40	1960-85,89-90	18-7115	1	PBH
40/48	1960-88	18-7134	1	DS CC
40	1962-70	18-7152	1	PBH
40	1965-66,71,73-85	18-7120	1	SR PP
40	1966,70	18-7120	4	PBH S
40	1971,73-76,81-85	18-7165	1	WT E
40	1984	18-7109	4	PBH S
40/45	1984-86	18-7120	1	BS
40/48	1984-88	18-7140	1	PBH
40/48	1984-88	18-7115	1	DS BH
40/45 45 HP Comm	1984-95	18-7137	1	SR
40/45 45 HP Comm	1987-95	18-7475	1	BSS
40/50	1988-95	18-7145	2	D&F S
40/48/50	1989-90	18-7109	1	SR PP
40 Comm	1989-90	18-7165	1	WT E
40 Comm	1989-90	18-7475	1	SR PP
40/48/50	1989-95	18-7172	1	PBH
40/48/50	1989-95	18-7173	1	DS BH
45 Comm	1985-88	18-7134	1	IH
45 Comm	1985-95	18-7128	1	DS BH
45 Comm	1985-95	18-7127	1	PBH
45/48 45 HP Comm	1987-95	18-7145	2	D&F S
45SS	1987-90	18-7134	2	DS CC
45 Comm	1995	18-7475	4	PBH S
48	1987-88	18-7475	3	PBH S
48/50	1987-95	18-7475	1	BS
48	1987-95	18-7137	1	SR
50/60	1958-67	18-7118	1	SR
50/60/65	1958-68	18-7174	1	WT E
50/55	1958-69	18-7174	1	DS CC
50/55/60	1968-71	18-7126	1	DS BH
50/55	1968-72	18-7129	1	PS OP
50	1971	18-7100	1	SR
50	1971-74,79,81	18-7127	1	PBH
50	1971-81	18-7128	1	DS BH
50/55/60	1971-84	18-7109	4	PBH S
50/55	1971-88	18-7134	1	DS CC
50	1973-74	18-7156	2	SA,L
50	1973-74	18-7146	1	SA,S
50/55	1973-95	18-7137	1	SR
50	1975,79,81,			

GEARCASE

HP	YEAR	O RING	QTY	DESC
1.5/2	1968-90	18-7173	1	PBH
2/2.5/4	1988-90	18-7145	1	D&F S
3/4	1957-79	18-7168	1	DS CC
3/4 Std. Gearcase	1964-80	18-7173	1	PBH
4 ☆	1981-95	18-7162	1	PBH
4 RD Models	1984,86-95	18-7118	1	SR
4.5	1980-87	18-7118	1	SR
5/5.5	1957-68	18-7180	1	DS BH
5	1965-68	18-7173	1	PBH
5/6/108	1984-95	18-7118	1	SR
5/6/6.5/8 6.5 HP Comm	1988-95	18-7145	2	D&F S
5/6/108	1989-95	18-7168	1	WT E
5.5/6	1957-79	18-7100	1	SR
5.5/6/7.5	1957-79	18-7117	1	PBH
5.5	1964	18-7120	1	SR PP
6/7.5	1957-79	18-7180	1	DS BH
6	1965-79	18-7120	1	SR PP
6.5/7.5 7.5 HP Comm	1980-90	18-7118	1	SR
6.5 Comm	1989-90	18-7168	1	WT E
7.5/9.5	1957-73	18-7100	1	SR
9.5/10	1958-73	18-7117	1	PBH
9.5	1964-73	18-7120	1	SR PP
9.5	1965-66,68,70-73	18-7168	1	WT E
9.5/9.9/15	1974-84	18-7116	1	DS CC
9.9/15	1974-95	18-7100	1	SR
9.9/15	1974-95	18-7168	1	WT E
9.9/15	1974-90	18-7104	1	PBH
9.9/15	1974-90	18-7139	1	IH
9.9/15	1984-85	18-7120	1	SR PP
9.9/15	1986-95	18-7475	1	SR PP
9.9/15	1988-92	18-7145	2	D&F S
9.9/15	1993-96	18-4248	2	D&F S
10	1957	18-7112	1	PBH
10/14	1957-63,88-90	18-7100	1	SR
10/18/25	1957-77	18-7116	1	DS CC
10/14 Comm	1988-90	18-7145	2	D&F S
14 Comm	1988-89	18-7475	1	SR PP
15A	1987-90	18-7174	1	WT
18/25	1957-76	18-7112	1	PBH
18/20/25	1957-95	18-7100	1	SR
18/20/28	1964-85	18-7120	1	SR PP
20/25	1977,85-95	18-7105	2	IH S
20/25	1985-90	18-7146	1	IH
20/25	1985-95	18-7180	1	SR S
20/25	1985-95	18-7108	1	PBH
20/25	1986-95	18-7475	1	SR PP
20/25/30	1987-95	18-7475	2	PBH S
20/25/28	1988-95	18-7145	2	D&F S
20/25	1988-95	18-7100	1	IH
20/30	1990	18-7475	1	BS
25	1969-86	18-7120	1	SR PP
25	1977	18-7109	2	PBH S
25	1978	18-7134	1	DS CC
25	1989-95	18-7475	1	BS
25	1989-90	18-7172	1	PBH
25	1989-90	18-7109	1	SR PP
25	1989-90	18-7173	1	DS BH

GEARCASE (Cont.)					GEARCASE (Cont.)				
HP	YEAR	O RING	QTY	DESC	HP	YEAR	O RING	QTY	DESC
	82-88	18-7115	1	DS BH	V-4	1966-68	18-7118	1	SR
50	① 1975,79,81-88	18-7140	1	PBH	V-4	1966-68	18-7120	1	SR PP
50/60	1981-86	18-7120	1	BSS	80	1967	18-7120	4	PBH S
55	② 1968-69,79-81, 83-95	18-7127	1	PBH	V-4	1968-95	18-7127	1	PBH
55	③ 1976-82	18-7140	1	PBH	V-4	1969-72	18-7129	1	PS OP
55	④ 1976-82	18-7115	1	DS BH	V-4/6/8	1969-95	18-7130	1	DS BH
55	⑤ 1979-81,83-95	18-7128	1	DS BH	V-4	1971-86	18-7109	4	PBH S
55	⑥ 1981-88	18-7120	1	BS	V-4	1973-74	18-7146	1	SA,S
55 Comm	1988,90-95	18-7475	4	PBH S	V-4	1973-77	18-7156	2	SA,L
55 Comm	1989-95	18-7475	1	BS	V-4/6/8	1973-95	18-7137	1	SR
55 Comm	1989-95	18-7145	2	D&F S	V-4,6,8	1973-90	18-7158	1	DS CC
60 71 "E" Models	1964,66-67, 70-71	18-7120	4	PBH S	V-4	1975-77	18-7178	1	SA,S
60	⑦ 1964-67,80-87	18-7115	1	DS BH	V-4	1981-86	18-7120	1	BS
60/65/75 Std. Gearcase	1964-68	18-7152	1	PBH	V-4/6	1987-95	18-7475	4	PBH S
60	1964-71,86-88	18-7174	1	DS CC	V-4/6/8	1987-95	18-7475	1	BS
60 67 Std. Gearcase	1966-67	18-7120	1	SR PP	V-4/6/8	1987-95	18-7145	2	D&F S
60/65	1968-71	18-7129	1	PS OP	85/90	1964-68	18-7152	1	PBH
60	⑧ 1970-81,86-95	18-7127	1	PBH	100	1966-68	18-7167	1	PBH
60	⑨ 1980-81,86-95	18-7128	1	DS BH	100	⑩ 1984-90	18-7142	1	PBH
60	⑪ 1980-85	18-7134	1	DS CC	100 Comm	1986-90	18-7475	1	BS
60	⑫ 1980-87	18-7140	1	PBH	100 Comm	1987	18-7109	4	PBH S
60/SST60	1980-95	18-7137	1	SR	120	1985	18-7142	1	PBH
60/SST60/ 65 65 HP Comm	1987-95	18-7475	1	BS	125	1971	18-7173	1	PBH
60/SST60/ 65 65 HP Comm	1987-95	18-7145	2	D&F S	125 Comm	1989-90	18-7142	1	PBH
SST60	1989-90	18-7140	1	PBH	125 Comm	1990	18-7174	1	WT
SST60	1989-90	18-7174	1	DS CC	140	1985,88-90	18-7142	1	PBH
60/65/70 65 HP Comm	1989-90	18-7158	1	DS CC	V-6	1976-78	18-7178	1	SA,S
SST60	1989-90	18-7115	1	DS BH	V-6	1976-78	18-7156	2	SA,L
65/75	1960-68	18-7118	1	SR	V-6	1976-85	18-7109	4	PBH S
65 Std. Gearcase	1968	18-7120	1	SR PP	V-6	1976-90	18-7142	1	PBH
65 Std. Gearcase	1968	18-7115	1	DS BH	V-6	1986	18-7120	1	BS
65	⑬ 1968-73, 85-88,90	18-7174	1	DS CC	155	⑭ 1984,89-90	18-7142	1	PBH
65	⑮ 1971,73,85-86	18-7109	4	PBH S	155	⑯ 1984-90	18-7144	3	PBH
65	⑰ 1972-73,85-95	18-7127	1	PBH	200/225	1987	18-7120	1	BS
65	⑱ 1973,85-95	18-7137	1	SR	V-8	1985-86	18-7120	1	BS
65	⑲ 1973,85-95	18-7128	1	DS BH	V-8	1985-90	18-7144	3	PBH
65/70 75 "B" Models	1973-75	18-7156	2	SA,L	V-8	1985-90	18-7174	1	WT
65/70 75 "B" Models	1973-75	18-7146	1	SA,S					
65 Comm	1985-86	18-7120	1	BS					
65/70 65 HP Comm	1988-95	18-7475	4	PBH S					
70/75	1960-65,74-88	18-7174	1	DS CC					
70/75	1974-85	18-7109	4	PBH S					
70/75	1974-95	18-7137	1	SR					
70	⑳ 1974-95	18-7128	1	DS BH					
70	㉑ 1974-95	18-7127	1	PBH					
70 15" Transom	1977-85	18-7115	1	DS BH					
70 15" Transom	1977-85	18-7140	1	PBH					
70	1981-87	18-7120	1	BS					
70	1988-95	18-7475	1	BS					
70	1988-95	18-7145	2	D&F S					
75	1960,63-65	18-7120	4	PBH S					
75	1961-65	18-7174	1	WT E					
75	㉒ 1964-65,75-88	18-7115	1	DS BH					
75	1965	18-7120	1	SR PP					
75	㉓ 1975-87	18-7127	1	PBH					
75 20" Transom	1975-87	18-7128	1	DS BH					
75 15" Transom	1975-88	18-7140	1	PBH					
75	1981-86	18-7120	1	BS					
75	1987-88	18-7475	1	BS					
75	1987-88	18-7145	2	D&F S					
V-4	1964-66,68-70	18-7120	4	PBH S					
V-4	1964-67	18-7174	1	WT E					
V-4	1964-68	18-7115	1	DS BH					
V-4	1964-72	18-7174	1	DS CC					

- ① 35 hp '67 Models RC, RL
- ② '82-70 w/o Selectric Shift/'89-90 Comm.
- ③ '65 Std Gearcase/'75-'87 15" Transom
- ④ '76-'87 20" Transom
- ⑤ '77-'85 20" Transom
- ⑥ '79-'81 Electric Start
- ⑦ '79-'81 Rope Start
- ⑧ '79-'81 Rope Start/'82 Comm.
- ⑨ '79-'81 Rope Start/'83-'90 Comm.
- ⑩ '80-'81 Electric Start/'86-'87 — 15" Transom
- ⑪ '80-'81 Rope Start/'86-'87 — 20" Transom
- ⑫ '87 Models AR, AE
- ⑬ '87 Models RC, RL
- ⑭ '89 Models DR, DE, DT
- ⑮ '89 WTLZ, WTXZ Models '90 WTESM, WTXESM Comm.
- ⑯ '89 WTLZ, WTXZ / '90 WTLESM, WTESM Comm.
- ⑰ '89 WTPLY, WTALY, WTPXY, WTAXY, '90 WTPLA, WTALA, WTPXA/Comm.
- ⑱ AR, AE Models
- ★ B, BR Models
- ⊙ Comm. Models Also
- * Electric Start
- * Selectric Shift

- BS: Bearing Setscrew
- DS BH: Driveshaft Bearing Hsg.
- DS CC: Driveshaft to Crankcase
- D & F S: Drain & Fill Screw
- WT E: 5" Gearcase Extension, Water Tube
- GC 1: Gearcase (11 7/16")
- GC 2: Gearcase (12 7/8")
- GC 3: Gearcase (19 1/2")
- IH: Impeller Hsg.
- IHS: Impeller Hsg. Spacer
- PBH: Prop Bearing Hsg.
- PBH S: Prop Bearing Hsg. Screw
- PS OP: Prop Shaft Oil Pump
- SAL: Shift Assembly, Large
- SA,S: Shift Assembly, Small
- SR: Shift Rod
- SR PP: Shift Rod Pivot Pin
- SR S: Shift Rod Scraper
- WT: Water Tube



**18-5225
SPARK PLUG WIRE KIT**
Kit includes 25 ft Roll of Hypalon Ignition Wire With a Copper Conductor and a Large Assortment of Three Different End Fittings to Fit McCulloch Motors Wire available in 100' Spool 18-5226



**18-5226
IGNITION WIRE**
Metallic Core
100' Spool
7mm Hypalon



**18-5153
CONTACT SET**
Replaces: 75101A, 1340135, 38550135



**18-5241
CONDENSER**
Replaces: 38850115

HP	Years	Contact Set	Condenser	HP	Years	Contact Set	Condenser
3.6	1953-57	18-5153	—	7.5	1961-68	18-5153 ②	—
6	1960-62	18-5153 ②	—	10	1958	—	18-5241 ②
7.5	1952-87	18-5153 ②	—	25	1959	18-5153 ② ③	—
7.5	1958	18-5153 ② ③	—	30 - 33	1955-56	18-5153 ③	—
7.5	1960	18-5153 ②	—	40	1957-59	18-5153 ② ③	—

② Two Required

③ REPCO Magneto Only

8' LENGTH COMPLETE FUEL LINE ASSEMBLIES

5/16"
FUEL LINE ASSEMBLY

18-8013EP-2 *SILVERADO 4000 Premium*



*



**18-8004EP-1
PRIMER
BULB**



*

FUEL LINE ASSEMBLY COMPONENTS

8' LENGTH COMPLETE FUEL LINE ASSEMBLIES

3/8"
FUEL LINE ASSEMBLY

18-8015EP-2 *SILVERADO 4000 Premium*



*



**18-8005EP-1
PRIMER
BULB**



*

FUEL LINE ASSEMBLY COMPONENTS

12' LENGTH COMPLETE FUEL LINE ASSEMBLIES

5/16"
FUEL LINE ASSEMBLY

18-8032EP-2 *SILVERADO 4000 Premium*



*



**18-8004EP-1
PRIMER
BULB**



*

FUEL LINE ASSEMBLY COMPONENTS



PRIMER BULB ASSEMBLY

Comes complete with two Hose Clamps

Part #	Description
18-8002EP-1	For 1/2" I.D. Hose
18-8004PE-1	For 3/8" I.D. (large capacity bulb)
18-8005EP-1	For 1/2" I.D. (large capacity bulb)



**18-7852-1
FUEL WATER SEPARATOR
KIT**

Includes:
18-7845 Filter - 18-7853-1 Bracket
18-4256 1/4" (2) Brass Plugs
18-9004 Pipe Sealant with Teflon® is recommended for use on filter bracket fitting threads



FUEL FILTERS

18-7828-1 18-7830
(1/4" Small) (5/16")
18-7829 18-7831
(1/4" Large) (3/8")



**18-79989
TRAILERING STICKS**

Fits: Most outboards over 150hp with three ram intrigree tilt/trim.

* Tanks and Engines for picture purpose only.

MERCURY OUTBOARD											
HP	CYL	BEG. S/N	YEAR	HP	CYL	BEG. S/N	YEAR	HP	CYL	BEG. S/N	YEAR
2.2	1	8075603	1984	8	2	C221500	1990	35	2	1755799	1965
2.2	1	8087123	1985	9.8	2	5206550	1979	35	2	1960827	1966
2.2	1	A800761	1986	9.8	2	5541280	1980-81	35	2	2097800	1967
2.2	1	A805221	1987	9.8	2	5965263	1982	35	2	2300972	1968
2.2	1	A817421	1988	9.8	2	6263906	1983	35	2	2487558	1969
2.2	1	A837101	1989	9.8	2	6438338	1984	35	2	6445653	1984
3	1	A855097	1990	9.8	2	6620196	1985	35	2	6626696	1985
3.4 L	6	6436883	1984	9.8 (100)	2	1397581	1961	35	2	A922171	1986
3.4 L	6	A129445	1985	9.8 (110)	2	1455240	1962	35	2	B110789	1987
3.4 L	6	A912426	1986	9.8 (110)	2	1474328	1963	35	2	B238644	1988
3.5	1	6202173	1983	9.8 (110)	2	1607083	1964	35	2	B393190	1989
3.5	1	6434771	1984	9.8 (110)	2	1742746	1965	35 (300)	4	1271885	1960
3.5	1	6594744	1985	9.8 (110)	2	1865779	1966	40	2	2874704	1970
3.6	1	5404657	1980-81	9.8 (110)	2	2098352	1967	40	2	3043031	1971
3.6	1	5910968	1982	9.8 (110)	2	2290663	1968	40	2	3219678	1972
3.9	1	1655013	1964	9.8 (110)	2	2508759	1969	40	2	3474578	1973
3.9	1	1738941	1965	9.8 (110)	2	2798057	1970	40	2	3859435	1974
3.9	1	1865633	1966	9.8 (110)	2	3002814	1971	40	2	4118385	1975
3.9	1	2098037	1967	9.8 (110)	2	3263263	1972	40	2	4362215	1976
3.9	1	2278851	1968	9.8 (110)	2	3482753	1973	40	2	4564002	1977
4	1	2498136	1969	9.8 (110)	2	3795658	1974	40	2	4860103	1978
4	1	2771662	1970	9.8 (110)	2	4079675	1975	40	2	5174089	1979
4	1	3028361	1971	9.8 (110)	2	4304785	1976	40	2	5556230	1980-81
4	1	3296137	1972	9.8 (110)	2	4605112	1977	40	2	5991215	1982
4	1	3529446	1973	9.8 (110)	2	4839254	1978	40	2	6228285	1983
4	1	3764825	1974	9.9	2	A918999	1986	40	4	C159200	1989
4	2	5589202	1980-81	9.9	2	B114231	1987	40	4	C221500	1990
4	2	9075839	1976	9.9	2	B233200	1988	40 350	2	1356948	1961
4	2	9172806	1978	9.9	2	B385500	1989	45	4	1476510	1962
4	1	A818721	1988	9.9	2	C221500	1990	45	4	A914859	1986
4	1	A837101	1989	10	2	1290910	1960	45	4	B110789	1987
4	1	A855097	1990	15	2	1288910	1960	45	4	B238644	1988
4	1	A906702	1986	15	2	1346448	1961	45	4	B393190	1989
4	1	B114109	1987	15	2	B293117	1988	45 (400)	4	1279685	1960
4.5	1	4108120	1975	15	2	B385500	1989	45 (400)	4	1384806	1961
4.5	1	4377557	1976	15	2	C221500	1990	50	4	1421113	1961
4.5	1	4597262	1977	18	2	5860332	1980-81	50	4	1477910	1962
4.5	1	4869518	1978	18	2	5954911	1982	50	4	1552535	1963
4.5	1	5270784	1979	18	2	6171607	1983	50	4	1605952	1964
4.5	1	5595532	1980-81	18	2	6443973	1984	50	4	1755549	1965
4.5	1	6025119	1982	18	2	6617631	1985	50	4	1870389	1966
4.5	1	6232381	1983	20	2	1558310	1963	50	4	2097445	1967
4.5	1	6428076	1984	20	2	1606903	1964	50	4	2305101	1968
4.5	1	6608536	1985	20	2	1755849	1965	50	4	2514919	1969
5	1	A819951	1988	20	2	1866496	1966	50	4	2736807	1970
5	1	A837101	1989	20	2	1997990	1967	50	4	3009934	1971
5	1	A855097	1990	20	2	2296267	1968	50	4	3235063	1972
6	2	1408611	1961	20	2	2550065	1969	50	4	3478003	1973
6	2	1485612	1962	20	2	2827677	1970	50	4	3816308	1974
6	2	1551443	1963	20	2	2991679	1971	50	4	4141450	1975
6	2	1607513	1964	20	2	3226958	1972	50	4	4357650	1976
6	2	1745521	1965	20	2	3537531	1973	50	4	4576237	1977
6	2	1958278	1966	20	2	3755885	1974	50	4	4962056	1978
6	2	2096171	1967	20	2	4103290	1975	50	4	5193259	1979
6	2	2284857	1968	20	2	4293920	1976	50	4	5531630	1980-81
6	2	A910596	1986	20	2	4580036	1977	50	4	5949386	1982
6	2	B114231	1987	20	2	4819249	1978	50	4	6275323	1983
6	2	B233200	1988	20	2	5183393	1979	50	4	6448808	1984
6	2	B385500	1989	20	2	5606492	1980-81	50	4	6586624	1985
7.5	2	2529895	1969	20	2	A910971	1986	50	3	A912478	1986
7.5	2	2810637	1970	20	2	B114231	1987	50	3	B110789	1987
7.5	2	3016581	1971	20	2	B238464	1988	50	3	B239242	1988
7.5	2	3274633	1972	20	2	B385500	1989	50	3	B396036	1989
7.5	2	3488153	1973	20	2	C221500	1990	50	3	C221500	1990
7.5	2	3801458	1974	22 (200)	2	1292910	1960	60	3	1303411	1960
7.5	2	4087015	1975	22 (200)	2	1339948	1961	60	3	6428681	1984
7.5	2	4314385	1976	25	2	1467499	1962	60	3	6609651	1985
7.5	2	4691222	1977	25	2	5705532	1980-81	60	3	A197392	1986
7.5	2	4851693	1978	25	2	5942041	1982	60	3	B110789	1987
7.5	2	5226935	1979	25	2	6185159	1983	60	3	B239242	1988
7.5	2	5524660	1980-81	25	2	6453343	1984	60	3	B396036	1989
7.5	2	5936301	1982	25	2	6593849	1985	60	3	C221500	1990
7.5	2	6239857	1983	25	2	A911346	1986	65	4	1542745	1963
7.5	2	6430041	1984	25	2	B114231	1987	65	4	1606282	1964
7.5	2	6611886	1985	25	2	B238464	1988	65	4	1765044	1965
8	2	A197112	1986	25	2	B385500	1989	65	4	1869564	1966
8	2	B114231	1987	25	2	C221500	1990	65	4	2119749	1967
8	2	B233200	1988	35	4	1570507	1963	65	4	2309311	1968
8	2	B385500	1989	35	2	1628795	1964	65	4	2503991	1969

MERCURY OUTBOARD

HP	CYL	BEG. S/N	YEAR	HP	CYL	BEG. S/N	YEAR	HP	CYL	BEG. S/N	YEAR
65	4	2803562	1970	90	3	B110054	1987	150	6	3752620	1974
65	4	2997339	1971	90	3	B240451	1988	150	6	4125985	1975
65	3	3293184	1972	90	3	C100000	1989	150XS	6	4319880	1976
65	3	3547987	1973	90	3	C221500	1990	150XS	6	4602012	1977
65	3	3807833	1974	90cc	2	A907702	1986	150XS	6	4868648	1978
65	3	4136685	1975	90cc	2	B114221	1987	V-150	6	4868998	1978
65	3	4382057	1976	95	6	1869776	1966	V-150	6	5129480	1979
70	3	1296411	1960	95	6	2097280	1967	V-150	6	5503247	1980-81
70	3	1413611	1961	100	6	1503332	1962	V-150	6	5944791	1982
70	3	1503459	1962	100	6	1518384	1963	V-150	6	6220254	1983
70	3	4382057	1976	100	6	1665002	1964	V-150	6	6443213	1984
70	3	4571652	1977	100	6	1755459	1965	V-150	6	6616991	1985
70	3	4825249	1978	100	6	2318586	1968	V-150	6	A904646	1986
70	3	5128280	1979	100	6	2484633	1969	V-150	6	B116662	1987
70	3	5579017	1980-81	100	4	B209468	1988	V-150	6	B242881	1988
70	3	5974683	1982	100	4	C100000	1989	V-150	6	C100861	1989
70	3	6279960	1983	100	4	C221500	1990	V-150	6	C221500	1990
70	3	B110054	1987	102cc	2	A819211	1988	V-150XR2	6	A905191	1986
70	3	B240451	1988	102cc	2	A837101	1989	V-150XR2	6	B289430	1988
70	3	C100000	1989	110	6	1870204	1966	V-150XR4	6	B242885	1988
75	4	6432901	1984	110	6	2097385	1967	V-175	6	4301235	1976
75	4	6613221	1985	115	6	2836019	1970	V-175	6	4563802	1977
75	4	A197882	1986	115	6	3023086	1971	V-175	6	4838074	1978
75	3	C100000	1989	115	6	3270480	1972	V-175	6	5180109	1979
75	3	C221500	1990	115	6	3525441	1973	V-175	6	5488752	1980-81
80	4	1335465	1960	115	6	3761035	1974	V-175	6	6618751	1985
80	4	1398630	1961	115	6	4112635	1975	V-175	6	A918329	1986
80	4	2559001	1969	115	6	4310785	1976	V-175	6	B116662	1987
80	4	2783253	1970	115	6	4567952	1977	V-175	6	B241881	1988
80	4	2986444	1971	115	6	4855153	1978	V-175	6	C100861	1989
80	4	3186263	1972	115	6	5168574	1979	V-175	6	C221500	1990
80	4	4831999	1978	115	6	5600967	1980-81	V-200	6	4839034	1978
80	4	5141097	1979	115	6	6006834	1982	V-200	6	5158929	1979
80	4	5582562	1980-81	115	6	6262961	1983	V-200	6	5464486	1980-81
80	4	5987161	1982	115	6	6440183	1984	V-200	6	6073192	1982
80	4	6232941	1983	115	6	6630171	1985	V-200	6	6203991	1983
80	3	A966142	1987	115	6	A907777	1986	V-200	6	6435503	1984
80	3	B240451	1988	115	6	B117567	1987	V-200	6	6625221	1985
80	3	C100000	1989	115	6	B239242	1988	V-200	6	A913228	1986
85	6	1460999	1963	115	4	C100000	1989	V-200	6	B116662	1987
85	6	1648888	1964	115	4	C221500	1990	V-200	6	B241881	1988
85	4	3493913	1973	125	6	2314956	1968	V-200	6	C100861	1989
85	4	3865695	1974	125	6	2536210	1969	V-200	6	C221500	1990
85	4	4092965	1975	135	6	2839369	1970	210cc	2	A918999	1986
85	4	4590512	1977	135	6	3036066	1971	210cc	2	B114231	1987
85XS	4	4366802	1976	V-135	6	A909997	1986	210cc	2	B233405	1988
90	6	1755444	1965	V-135	6	B116662	1987	210cc	2	B385500	1989
90	6	4854301	1978	V-135	6	B241881	1988	V-220	6	B241881	1988
90	6	5160324	1979	V-135	6	C100861	1989	V-225	6	5615282	1980-81
90	6	5594657	1980-81	V-135	6	C221500	1990	V-250	6	C139860	1989
90	6	5996390	1982	140	6	3293234	1972	V-250	6	C221500	1990
90	6	6246856	1983	140	6	4865678	1978	V-275	6	C139860	1989
90	6	6436123	1984	140	6	5189788	1979	V-275	6	C221500	1990
90	6	6623151	1985	140	6	5625108	1980-81	V-300	6	5611648	1980-81
90	6	A902436	1986	150	6	3502806	1973	V-300	6	6239853	1983



**18-5007
TUNE-UP KIT**

—CONTENTS—

Part #	O.E. #	Description
18-5153	398-174	Contact Set
18-5206	398-693	Condenser



**18-5012
TUNE-UP KIT**

—CONTENTS—

Part #	O.E. #	Description
18-5148	394-1100A3	Contact Set
18-5169	394-1130A1	Condenser



**18-5139
CONTACT SET**

Replaces: 336-4318A2, 336-4318A4, 336-4318A3,
336-3948A3, 336-3948A2
(2) 18-5139 = (1) 336-4318A2



**18-5140
CONTACT SET**
Replaces: 398-2202



**18-5148
CONTACT SET**
Replaces: 394-1100A3, 394-1100A2,
394-352A1



**18-5153
CONTACT SET**
Replaces: 398-174



**18-5169
CONDENSER**
Replaces: 394-1130A1, 394-1130,
397-741, 397-359



**18-5206
CONDENSER**
Replaces: 398-693



**18-5207
CONDENSER**
Replaces: 398-173

HP	Model	Beginning Serial No	Ending Serial No	Contact Set	Condenser	Tune-Up Kit
3.9		1655013	2498155	18-5140	18-5212	18-5008
4		2498136	2693114	18-5140	18-5212	18-5008
4	ⓐ	2771622	A809600	18-5139	—	—
4.5		4107220	& UP	18-5139	—	—
5		1610265	2529894	18-5140	18-5212	18-5008
7.5	ⓑ	214324	& UP	18-5153	18-5207	—
7.5		2529895	2721150	18-5140	18-5212	18-5008
7.5		3274633	3801457	18-5139	—	—
9.8		1470349	1865776	18-5153	18-5206	18-5007
9.8		1865776	2708898	18-5140	18-5212	18-5008
9.8		2798057	3263262	18-5139	—	—
9.8		3263263	3795657	18-5139	—	—
10		1120826	112327	18-5153	18-5206	18-5007
10		595628	112327	18-5153	18-5206	18-5007
10		595628	& UP	18-5153	18-5206	18-5007
15		1200114	1499331	18-5153	18-5206	18-5007
20		860979	& UP	18-5153	18-5206	18-5007
20		2827677	3226957	18-5139	—	—
20		3226958	3537530	18-5139	—	—
22		1158546	1499331	18-5153	18-5206	18-5007
25 KF9		377150	379008	18-5148	18-5169	18-5012
25 KG9		377150	379008	18-5148	18-5169	18-5012
25 MARK40		377150	379008	18-5148	18-5169	18-5012
35	350	1271884	1448139	18-5148	18-5169	18-5012
35		1571114	2874703	18-5140	18-5212	18-5008
40		831021	1279684	18-5148	18-5169	18-5012
45		1139536	& UP	18-5148	18-5169	18-5012
50	MK 30 55			—	18-5169	—
30		1271884	1448139	—	18-5169	—
35	35A	1271884	1448139	—	18-5169	—
40		1279685	1476509	—	18-5169	—
45		1476510	1531958	—	18-5169	—
50		1421113	2305100	—	18-5169	—
50		1776179	2116317	—	18-5169	—
50	ⓐ	2116318	2305100	—	18-5169	—
65 (4CYL)		1542745	2309310	—	18-5169	—

ⓐ Phelon Magneto only ⓑ Manual start only Ⓒ Except "Gnat"



18-5187

IGNITION COIL

Replaces: 339-856991A1, 339-850227
For: Mariner 200DFI, 225DFI, V135DFI (2.5L), V150DFI (2.5L) and Mercury 3.0DFI

① **18-5181D**



18-5181
IGNITION COIL

Replaces: 802371A1

① **18-5186D**



18-5186
IGNITION COIL

Replaces: 339-7370A13, 339-832757A4

18-5158

IGNITION COIL

Replaces: 8M0077471, 879984T01, 879984A1, 879984T00

For: 40-60 EFI 4 Cylinder (DT409000-1C453839) USA (DP153500-1C453839) Belgium, 30-40 EFI 3 Cylinder (DT409000-1B226999) USA (DP153500-0P400999) Belgium, 30-40 EFI 3 Cylinder (1C000001-Up), 75-115 DFI 3 Cylinder (DT980000-Up), 80 JET 3 Cylinder (1B586067-Up), 200-225 DFI 3.0L (1B504989-1B912785), 200 Pro XS DFI 3.0L (1B504989-1B912785), 250 DFI 3.0L (1B528615-Up), 115 Pro XS 3 Cylinder (1B751825-Up), 125 DFI 3 Cylinder (1B736885-Up), 240 EFI SportJet (0E408400-Up), 600 SCI (0M952908-0M962865), 662 SCI (0M956680-Up), 700 SCI (0M962886-Up), 850 SCI (0M952900-Up), 1025 SCI (0M962886-Up), 1075 SCI (0M957032-Up), 1200 SCI (0M956534-Up)



18-5159

IGNITION COIL

Replaces: 339-8M0077473, 339-883778A02, 339-883778A01

For: 1650 (0M965309-Up), 1550 (0M973231-Up), 1100 (0M965965-Up), 1350 (0M965309-Up), 110 Jet (2.5L) (1B690542-Up), 150 Pro XS (2.5L) (1B690542-Up), 200 (DFI) 3.0L (1B504989-Up), 200 (3.0L-DFI)(DTS) (1B504989-Up), 200 Pro XS (DFI) 3.0L (1B504989-Up), 225 (DFI) 3.0L (1B504989-Up), 225 (3.0L-DFI)(DTS) (1B504989-Up), 250 (DFI) 3.0L (1B528615-Up), V-135 (DFI) 2.5L (1B417702-Up), V-150 (DFI) 2.5L (1B417702-Up), V-175 (DFI) 2.5L (1B417702-Up), 2.5XS (2.5L DFI) (0T997974-1E000796)



18-5433

IGNITION COIL

Replaces: 32193A2, 38547, 392-806529A1, 898253T24
(Uses External Resistor)



18-5154

PENCIL COIL

Replaces: 339-880615T01

Fits: 350SCI Verado (1B716557-2B143542), 200-275 Verado (6 Cyl) (0T980000-2B578935), 300 Verado (0P520553-2B578935), 200 Pro Verado (6 Cyl) (2B034840-2B577715), 250-300 Pro Verado (1B830170-2B577715), 75-115 EFI (1B366823-2B094995), 135-175 Verado (1B227000-2B576734), 200 Verado (4 Cyl) (1B517159-2B578935), 350 Verado (2B141617 & Up), 350 Pro Verado (2B141124 & Up), 400 Verado (2B141124 & Up)



18-5775

SWITCH BOX

Replaces: 332-7778A6, 332-7778A9, 332-7778A12, 332-7778A7, 332-7778A3, 332-7778A1, 332-5524A1, F7778A9, F749301



18-5776

SWITCH BOX

Replaces: 339-7452A3, 339-7452A2, 339-7452A1



18-5777

SWITCH BOX

Replaces: 339-7452A15, 339-7452A19, 339-7452A9, 339-7452A7



18-5778

SWITCH BOX

Replaces: 339-7452A14, 339-7452A21, 339-7452A11, 339-7452A8



18-5787

SWITCH BOX ASSEMBLY

Replaces: 332-4911A8
For: 40 HP



18-25400

PULSER COIL

Replaces: 16066004
Fits: Mercury 8/9.9 4-Stroke[R042475 & Up]





18-5790
SWITCH BOX ASSEMBLY
 Replaces: 18495A26, 18495A19
 18495A12
 For: 75-90 HP



18-5791
SWITCH BOX ASSEMBLY
 Replaces: 19052A8, 19052A5,
 19052A3
 For: 50-60 HP



18-5792
SWITCH BOX ASSEMBLY
 Replaces: 18061T
 For: 4/5 HP



18-5793
SWITCH BOX ASSEMBLY
 Replaces: 823034, 823034T
 For: 2.5/3.3 HP



18-5881
SWITCH BOX
 Replaces: 332-5772A7, 332-5772A5,
 332-5772A3, 332-5772A2,
 332-5772A1, F720301



18-1151
DISTRIBUTOR
ROTOR SHAFT BEARING
 Replaces: 30-20066
 SKF France R822T



18-1152
DISTRIBUTOR
ROTOR SHAFT BEARING
 Replaces: 30-26379
 SKF France 6002-2 RSI/HT

4-STROKE ENGINES

HP	Model	Beginning Serial No	Ending Serial No	Coll	Switch Box
30EFI (3 Cyl.)	USA	0T409000	1B226999	18-5158	N/A
30EFI (3 Cyl.)	Belgium	0P153500	0P400999	18-5158	N/A
30EFI (3 Cyl.)	Belgium	1C000001	& Up.	18-5158	N/A
40EFI (3 Cyl.)	USA	0T409000	1B226999	18-5158	N/A
40EFI (3 Cyl.)	Belgium	0P153500	0P400999	18-5158	N/A
40EFI (3 Cyl.)	Belgium	1C000001	& Up.	18-5158	N/A
40EFI (4 Cyl.)	USA	0T409000	1C453839	18-5158	N/A
40EFI (4 Cyl.)	Belgium	0P153500	1C453839	18-5158	N/A
50EFI (4 Cyl.)	USA	0T409000	1C453839	18-5158	N/A
50EFI (4 Cyl.)	Belgium	0P153500	1C453839	18-5158	N/A
60EFI (4 Cyl.)	USA	0T409000	1C453839	18-5158	N/A
60EFI (4 Cyl.)	Belgium	0P153500	1C453839	18-5158	N/A
75EFI (4 Cyl.)	USA	1B366823	2B094995	18-5154	N/A
90EFI (4 Cyl.)	USA	1B366823	2B094995	18-5154	N/A
115EFI (4 Cyl.)	USA	1B366823	2B094995	18-5154	N/A
135 Verado (4 Cyl.)	USA	1B227000	2B576734	18-5154	N/A
150 Verado (4 Cyl.)	USA	1B227000	2B576734	18-5154	N/A
175 Verado (4 Cyl.)	USA	1B227000	2B576734	18-5154	N/A
200 Verado (4 Cyl.)	USA	1B517159	2B578935	18-5154	N/A
200 Verado (6 Cyl.)	USA	0T980000	2B578935	18-5154	N/A
200 Pro Verado (6 Cyl.)	USA	2B034840	2B577715	18-5154	N/A
225 Verado (6 Cyl.)	USA	0T980000	2B578935	18-5154	N/A
250 Verado (6 Cyl.)	USA	0T980000	2B578935	18-5154	N/A
250 Pro Verado	USA	1B830170	2B577715	18-5154	N/A
275 Verado (6 Cyl.)	USA	0T980000	2B578935	18-5154	N/A
275 Pro Verado	USA	1B830170	2B577715	18-5154	N/A
300 Verado	USA	0P520553	2B578935	18-5154	N/A
300 Pro Verado	USA	1B830170	2B577715	18-5154	N/A
350 Verado	USA	2B141617	& Up.	18-5154	N/A
350SCi Verado	USA	1B716557	2B143542	18-5154	N/A
350 Pro Verado	USA	2B141124	& Up.	18-5154	N/A
400 Verado	USA	2B141124	& Up.	18-5154	N/A

② Two Required ③ Three Required ④ Four Required ⑥ Six Required

2-STROKE ENGINES

HP	Model	Beginning Serial No	Ending Serial No	Coil	Switch Box
4		G710613	& UP	—	18-5792
6		A197112	G760299	18-5186 ①	18-5777
6		G760300	T800749	18-5186	—
8		A197112	G760299	18-5186 ①	18-5777
8		A760300	& UP	18-5186	18-5777
210CC	Sail Power	A918999	& UP	18-5186 ①	18-5777
9.9		A197112	G760299	18-5186 ①	18-5777
9.9		G760300	& UP	18-5186	18-5777
10		D038000	G760299	—	18-5777
15		B292414	G760299	18-5186 ①	18-5777
15		G760300	& UP	18-5186	18-5777
15	Sea-Pro	G044027	G437999	18-5186	—
15		G438000	G760299	18-5186	18-5777
15		G760300	& UP	18-5186	—
15	Comm.	G760300	& UP	18-5186	—
15	Non-Comm.	G760300	& UP	18-5186	—
15XD	Comm.	G760300	& UP	18-5186	—
15XD	Non-Comm.	760300	& UP	18-5186	—
18		5837437	6443972	18-5186 ①	18-5776
18		6443973	& UP	18-5186 ①	—
18 BULLET	Comm.	6443973	& UP	18-5186	—
20		3537531	3755884	18-5186	—
20		6443973	G044026	18-5186 ①	18-5777
20		G044027	G437999	18-5186	—
20		G438000	G760299	18-5186 ①	18-5777
20	Comm.	G760300	T800999	18-5186	—
20 NON	Comm.	G760300	T800999	18-5186	—
20 JET		G044027	G760299	18-5186	—
20 JET		G760300	& UP	18-5186	—
25		5705532	6443972	18-5186 ①	18-5776
25	Uses Nut Connection	6443973	& UP	18-5186 ①	18-5776
25	Uses Bullet Connection	6443973	& UP	18-5186	18-5777
25		B238464	G044026	18-5186 ①	18-5777
25		G04027	G437999	18-5186	—
25		G438000	G760299	18-5186	—
25	Comm.	G760300	& UP	18-5186	—
25	Non-Comm.	G760300	& UP	18-5186	—
30	Jet	C159200	G589999	18-5186 ①	18-5881
35	Uses Nut Connection	6445653	B110788	18-5186 ①	18-5776
35	Uses Bullet Connection	6445653	B110788	18-5186 ①	18-5776
35		B110789	& UP	18-5186	18-5776
40		3336256	3859434	18-5186	—
40 (2 cyl.)		3859435	5823917	18-5186	—
40 (2 cyl.)		5823918	6443973	18-5186 ①	18-5776
40 (4 Cyl.)		C159200	& UP	18-5186 ②	18-5881
45/50 (4 Cyl.)		5531630	& UP	18-5186 ③	18-5881
45 (3 Cyl.)	Jet	G290584	G589999	18-5186	—
50 (4 Cyl.)		5193259	5531629	18-5186	18-5881
50 (4 Cyl.)		5531630	& UP	18-5186	18-5881
50/60 (3 Cyl.)		6428681	D000749	18-5186 ②	18-5775
50/55/60 (3 Cyl.)		D000750	G589999	18-5186 ②	18-5791
55 (3 Cyl.)		D000750	G589999	18-5186	—
60 (3 Cyl.)		6428681	D000749	18-5186	18-5775
60 (3 Cyl.)		D000750	G589999	18-5186	—
65 (3 Cyl.)		4382057	4571651	—	18-5775
65 jet		D283222	G437999	18-5186	—

① Two Required ② Three Required ③ Four Required ④ Six Required

2-STROKE ENGINES (CONT.)					
HP	Model	Beginning Serial No	Ending Serial No	Coil	Switch Box
70	MK75/78	1110600	& UP	18-5433	N/A
70 (6 Cyl.)		1296411	1566239	18-5433	N/A
Mercury 70		4571652	5128279	—	18-5775
Mariner70		5128280	& UP	18-5186 ②	18-5775
70		1296411	1566239	18-5433 ①	N/A
70		5579016	6426680	18-5186 ②	18-5775
70/75 (3 Cyl.)		C272000	D283221	18-5186 ②	18-5775
75 (3 cyl)		D283222	G437999	18-5186 ②	18-5790
75 (4 Cyl.)		6432901	& UP	18-5186 ③	18-5881
75 (3 Cyl.)		C222000	D283221	18-5186 ②	18-5775
75 (3 Cyl.)		D283222	G437999	18-5186 ②	18-5790
75DFI (3 Cyl.)		0T980000	& Up	18-5158	N/A
800 (6 Cyl.)		1335465	1566239	18-5433 ①	N/A
Mariner 80 (4 Cyl.)		5144547	& UP	18-5186 ②	—
Merc 80 (4 Cyl.)		5582562	6432900	18-5186 ③	—
80 (4 Cyl.)		4831999	5141096	—	18-5881
80 (4 Cyl.)		5141097	6432900	18-5186	18-5881
80 (3 Cyl.)		A996142	& UP	18-5186 ②	18-5775
80 Jet		D283222	G437999	—	18-5881
80 Jet (3 Cyl.)		1B586067	& Up	18-5158	N/A
85 (6 Cyl.)		1460999	1766823	18-5433 ①	N/A
85 (4 Cyl.)		4366802	4831998	—	18-5881
90		1766824	1869775	18-5433 ①	N/A
90 (6 cyl.)		S299506	& UP	18-5186 ④	18-5775 ①
90 (3 Cyl.)		A996142	D283221	18-5186 ③	18-5775
90 (3 Cyl.)		D283222	G437999	18-5186	18-5790
90 (Powerhead)	Sport Jet	E023150	E095067	—	18-5775
90DFI (3 Cyl.)		0T980000	& Up	18-5158	N/A
95		1869776	1935100	18-5433 ①	N/A
100 (6 cyl.)		1464949	2318585	18-5433 ①	N/A
100 (4 Cyl.)		B209468	G437999	18-5186 ②	18-5881
105 Jet		D082000	G303045	18-5186 ④	18-5775 ①
110		1870204	2314955	18-5433 ①	N/A
110 Jet	2.5L		1B490865	18-5187	N/A
110 Jet	2.5L	1B690542	& Up	18-5158	N/A
115 (6 Cyl.)		5314656	& Up	18-5186 ④	18-5775 ①
115 (6 Cyl.)		5314656	& Up	18-5186	—
115 (4 Cyl.)		B209468	6437999	18-5186 ②	—
115 (3 Cyl.)		C100000	G437999	—	18-5881 ①
115 DFI (3 Cyl.)		0T980000	& Up	18-5158	N/A
115 Pro XS (3 Cyl.)		1B751825	& Up	18-5158	N/A
125 (4 Cyl.)		D283222	G437999	18-5186	18-5881 ①
125 DFI (3 Cyl.)		1B736885	& Up	18-5158	N/A
V-135		A904646	G960499	18-5186 ④	18-5775 ①
V-135 DFI	2.5L	G590000	1B417701	18-5187	N/A
V-135 DFI	2.5L	1B417702	& Up	18-5158	N/A
140		5327663	& Up	18-5186 ②	18-5775 ①
140 Jet		D082000	G960499	18-5186 ④	18-5775 ①
150		A904646	G960499	18-5186	18-5775
V-150	Orange Coil	4868998	A904645	—	18-5775 ①
V-150	Blue Coil	4868998	A904645	18-5186	18-5775 ①
V-150		5129480	G960499	18-5186 ④	18-5775 ①
V-150 XR2		6616991	A904645	18-5186 ④	18-5775 ①
V-150 XR4		B242885	D819999	18-5186 ④	18-5775 ①
V-150 DFI	2.5L	G590000	1B417701	18-5187	N/A
V-150 DFI	2.5L	1B417702	& Up	18-5158	N/A

① Two Required ② Three Required ③ Four Required ④ Six Required

2-STROKE ENGINES (CONT.)

HP	Model	Beginning Serial No	Ending Serial No	Coil	Switch Box
150 Pro XS	2.5L	1B890542	& Up	18-5158	N/A
V-175		4301235	5180108	—	18-5775 ①
V-175,EFI, XR1		5180109	G960499	18-5186 ④	18-5775 ①
V-175 EFI		D000750	G960499	18-5186	—
V-175 DFI	2.5L	T178500	1B417701	18-5187	N/A
V-175 DFI	2.5L	1B417702	& Up	18-5158	N/A
V-200, XR1		5383918	G960499	18-5186 ④	18-5775 ①
V-200 EFI		C100861	G960499	18-5186	—
V-200 DFI		G590000	1B504988	18-5187	—
200 DFI		G960500	T800999	18-5187	N/A
200 DFI	3.0L	T801000	1B504988	18-5187	N/A
200 DFI	3.0L	1B504989	1B912785	18-5158	N/A
200 DFI (DTS)	3.0L	T980000	1B504988	18-5187	N/A
200 DFI (DTS)	3.0L	1B504989	& Up	18-5158	N/A
200XS DFI	2.5L	T235000	1E002110	18-5187	N/A
200 Pro XS	3.0L	1B504989	& Up	18-5158	N/A
200 Sport XS	3.0L	1E000797	1E002583	18-5187	N/A
V-220		B117316	& Up	18-5186 ④	18-5775 ①
V-225	2.4L	5628028	& Up	18-5186 ④	18-5775 ①
V-225 DFI		G590000	B504988	18-5187	—
V-225 PRO XS		B104549	B426650	18-5187	—
225 DFI	3.0L	G590000	1B504988	18-5187	N/A
225 DFI	3.0L	1B504989	1B912785	18-5158	N/A
225 DFI (DTS)	3.0L	T980000	1B504988	18-5187	N/A
225 DFI (DTS)	3.0L	1B504989	& Up	18-5158	N/A
240 EFI SportJet		E406400	& Up	18-5158	N/A
V-250	3.4L	C101891	& Up	18-5186	—
250XS	3.0L	T651945	1E002341	18-5187	N/A
250 DFI	3.0L	1B528615	& Up	18-5158	N/A
V-275	3.4L	C101891	& Up	18-5186	—
V-300	3.4L	5811648	& Up	18-5186	—



















① Two Required ② Three Required ③ Four Required ④ Six Required

PREMIUM MARINE SPARK PLUG WIRE LEADS

Sierra's MAGFORCE Ignition Wires are "Electronics Friendly" protecting all of your electronic devices and electronic engine controls from RFI and EMI while delivering the maximum amount of voltage. Exact fit design ensures easy installation and years of trouble - free service.



Part #	OEM #	Description
18-8819-1	—	7" Spark Plug Wire (8mm)
18-5228-1	—	9" Spark Plug Wire (8mm)
18-5228-1D③	84-813715A1	9" Spark Plug Wire (8mm)
★ 18-5227-1	—	9" Spark Plug Wire (7mm)
18-5227-1D②③	84-813715A1	9" Spark Plug Wire (7mm)
18-5229-9-1①②	—	22" Spark Plug Wire (7mm)
18-5230-9-1①②	—	10" Spark Plug Wire (7mm)
★ Metallic core wire ① PKG. OF 5 ② 7mm copper core wire		
③ Items ending in "D" are Display Packaged - Regular number is Non-Display		

 <p>18-5225 SPARK PLUG WIRE KIT Replaces: 84-99215A26, 84-813706A26, 84-93475A26, 84-93212A1, 84-90816A26 Kit includes 25 ft. Roll of 7 MM Hypalon Ignition Wire With a Metallic Core and a Large Assortment of Three Different End Fittings to Fit Outboard Motors.</p>	 <p>18-5226 IGNITION WIRE Metallic Core 100' Spool 7mm Hypalon</p>	 <p>PKG. OF 10 18-5224 18-5224-9① SPARK PLUG WIRE TERMINAL Replaces: 20121, 8M0084600</p>	
<p>PKG. OF 10</p>  <p>18-5750 18-5750-9① UNIVERSAL SPARK PLUG BOOTS Supplied complete w/Terminal Connector</p>	 <p>18-5752 UNIVERSAL SPARK PLUG BOOT 8mm</p>	 <p>18-28080 WIRE SET Replaces: 84-821945A56 Fits: 225(3.0L Carb) and 225/250(3.0L EFI) (G303045 & Below)</p>	
 <p>18-28081 WIRE SET Replaces: 84-813706A56 Fits: 225(3.0L Carb) and 225/250(3.0L EFI) w/CDM Modules (G303045 & Up)</p>	 <p>18-28082 WIRE SET Replaces: 84-813715A8 Fits: 100, 115, 125 & 80 Jet(4 cyl) (0G301750 & Below)</p>	 <p>18-28083 PLUG WIRE Replaces: 84-881908T (1 WIRE) Fits: Mercury V6 EFI/DFI/DTS</p>	 <p>18-28084 PLUG WIRE SET Replaces: 84-881908T (3 WIRES) Fits: Mercury 30-40 EFI 4-stroke(3 cyl)</p>
 <p>18-28085 PLUG WIRE SET Replaces: 84-881908T (4 WIRES) Fits: Mercury 40-6- EFI 4-stroke (4cyl)</p>	 <p>18-28086 PLUG WIRE SET Replaces: 84-881908T (6 WIRES) Fits: Mercury V6 EFI/DFI/DTS</p>	 <p>MP41000 IGNITION SWITCH Push to Choke — 3 Position — 6 Terminal Replaces: 87-88107, 87-88107A5 See ELECTRICAL PRODUCTS - Ignition Switches section for wiring diagram.</p>	 <p>MP41070-2 IGNITION SWITCH Push to Choke — 3 Position — 6 Wire Sealed Polyester Replaces: 87-17009A2</p>
 <p>MP51090 (Display Pkg.) MP51092 IGNITION SWITCH 3 Position Magneto — OFF- RUN- START PUSH to Choke Replaces: 87-17009A5</p>	 <p>MP52000 (Display Pkg.) MP52002 IGNITION SWITCH 3 Position Magneto — OFF- RUN- START PUSH to Choke — 8 Wire Replaces: 87-88107A5</p>	 <p>18-6751 MANUAL RELEASE VALVE Replaces: 893929A01, 813442A2, 813442A1, 811618A1, 811618, 812843A1, 99660A1 Fits: Most 2 & 4 Stroke Outboards with Integral tilt and trim</p>	 <p>18-6771 TILT/TRIM RESERVOIR Replaces: 18525A1</p>

① Priced per package



18-6778
TILT/TRIM RESERVOIR
 Replaces: 883166A1, 883166A2
 For: Motors with 4 screw attachments

(2 Wire w/ Relays)



18-6273-1
TILT/TRIM MOTOR
 High Performance Cartridge Pump
 w/Replaceable Motor
 Replaces: 99186, 99186-1, 99186-T
 Fits: 35-220 HP (1985-93) Mercury/Mariner Outboards
 w/ Design I, 3 Ram, 3 Wire Tilt/Trim Units w/ Side Fill Reservoir. Integral Trim/Tilt System
 Uses relay 18-5737



18-6757
TILT/TRIM MOTOR
 Fits: Mercury 35-220 HP (1985-92) w/ Design I, 3-Ram
 Side Fill Integral Trim/Tilt System w/ Square Style Eaton
 Motor and 18-6273-1 Tilt/Trim Motor Pump Assy
 Uses wire harness 18-6823

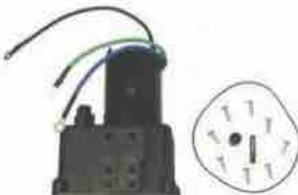

18-6763
TILT/TRIM MOTOR
 Replaces: 92975A28, A32
 To 1984 for Most Mercury Outboards
 (Motor and Reservoir Only)



18-6765
TILT/TRIM ASSEMBLY
 Replaces: 823653A5,
 92459A4, 823653A9
 Fits: 250,275 HP & V-3.4L,
 Serial No.5611648-UP
 (Motor Only)
 Replaces: 17649A02



18-6773
TRIM MOTOR
 Replaces: 828708, 878265A4
 For most late model Mercury/Mariner 1996 & UP (135,150,
 XR6 Mag III, 175, 200, 225, 250 HP — 105 - 140 HP Jet)



18-6774
TRIM MOTOR
 Replaces: 811628, 828708A1, 878265A6
 High-performance cartridge, replaceable motor. Design II,
 Ram 3, 2 wire, tilt/trim units. Squared style Eaton
 Uses wire harness 18-6823

18-6775
TILT/TRIM MOTOR
 Reference OE reservoir 811673 1
 Contains: All parts necessary, a new 3-wire
 motor/reservoir, drive shaft coupler, oil seal,
 O-ring and hardware.
 Yellow fill plug.
 For:

Models	Models
65 Jet	100 4-Cyl.
75 3-Cyl.	115 4-Cyl.
80 Jet	125 4-Cyl.
90 3-Cyl.	

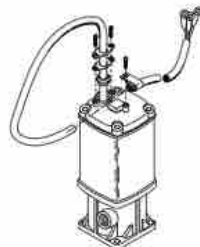

If you have this 3-wire single ram
 system, use 18-6775

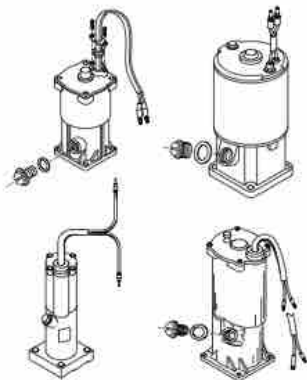

If you have any of the 2-wire single systems, use 18-6777

18-6777
TILT/TRIM MOTOR
 Replaces: 818903A1, 819762A4-A7, 819479A1, 819480A1, 81977A8-A9,
 822870A1, 830250A3-T3, 832021A1-T4-A2-T2, 855654A1-T2, 19217A1-
 A5, 854472A2, A3, A4, 2B094995 and below
 Now considered Mercury Design 1.
 Contains: All parts necessary, a new 2-wire motor/reservoir, drive shaft coupler, oil
 seal, O-ring and hardware. Yellow base O-ring.

For:

Models	Models
30 Jet	60 3-Cyl., Bigfoot
30 4-Stroke	65 Jet
35	75 3-Cyl.
40 2, 3, 4-Cyl.	75 4-Stroke
40 4-Stroke, Bigfoot	80 Jet
45 4-Stroke, Bigfoot,	90 3-Cyl.
Bodensee	90 4-Stroke
50 3-Cyl.	100 4-Cyl.
50 4-Stroke, Bigfoot	115 4-Cyl.
55 3-Cyl.	125 4-Cyl.



18-6448
ELECTRIC START CONVERSION KIT
Fits: Mercury 30 HP



18-6274
TILT/TRIM MOTOR
Replaces: 14336A20, 865380A13
Low pressure / high flow



BATTERY CABLES
Gauge Cable with soldered lug terminals on each end to accept a 3/8" stud.

Part No.	Size	Color	Gauge	Part No.	Size	Color	Gauge
BC88523	2'	red	4	BC88563	6'	red	2
BC88533	2'	black	4	BC88573	6'	black	2
BC88543	4'	red	2	BC88583	8'	red	1
BC88553	4'	black	2	BC88593	8'	black	1



18-9801
MULTI METER/DVA TESTER
Replaces: 91-99750A1
A must for testing Mercury ignition systems.



18-9800
COMPRESSION TESTER
Perfect for hard to reach bottom spark plug holes on older Mercury models.



18-9802
TIMING LIGHT
Replaces: 91-99379
Self-powered accurate up to 10,000 RPM's.



18-5864
STATOR
Replaces: 86617A20
For: 6-25 HP



18-5865
STATOR
Replaces: 398-5704A7
For: 50-70 HP



18-5870
STATOR
Replaces: 398-832075A4-A21
For: 30-125 HP
Replacement for the 18-5873 & 18-5874 kits



18-5871
STATOR
Replaces: 398-5454A32
For: 135-300 V6



18-5873
STATOR KIT
Replaces: 398-832075A6
For: 100, 115, 125 HP
Includes 18-5870 stator



18-5874
STATOR KIT
Replaces: 398-832075A14, 398-832075A20, 398-818535A15, 398-5919A8, 398-5919A6, 398-5919A2, 398-5454A63, 398-5454A25, 398-5454A21
For: 30-50 HP
Includes 18-5870 stator



18-5876
STATOR
Replaces: 398-9610A19
For: 135-200 HP

APPLICATION BEGINS ON NEXT PAGE



18-5854

STATOR

Replaces: 398-5454A17

*Note: Extra black lead goes to engine ground.



18-5855

STATOR

Replaces: 336-3996A7



18-5856

STATOR

Replaces: 398-5255



18-5857

STATOR

Replaces: 398-5454A7



18-5859

STATOR

Replaces: 398-5454A26, 398-5454A22, 398-5919A7, 398-5919A3



18-5860

STATOR

Replaces: 398-5454A35



18-5797

TRIGGER ASSEMBLY

Replaces: 96455A8, 96455A1, 68162A6, 68162A3
For: 3 cyl.



18-5798

TRIGGER ASSEMBLY

Replaces: 96455A9, 96455A6, 68162A8, 68162A5, 68162A1
For: 6 cyl.

STATOR & TRIGGER APPLICATIONS

HP	Beg. S/N	End S/N	Trigger	Stator	HP	Beg. S/N	End S/N	Trigger	Stator
6	A197112	G760299	—	18-5864	18XD	6443973	B236463	—	18-5864
7.5	2819637	3274632	—	18-5855	20	2827677	3226957	—	18-5855
8	A197112	G760299	—	18-5864	20	6443973	G044026	—	18-5864
8.8	2798057	3263262	—	18-5855	20, 20 JET	G044027	G437998	—	18-5863
9.9	A197112	G760299	—	18-5864	20, 20 JET	G438000	G760299	—	18-5864
XR10,10 MAG & SEA PRO	D038000	G760299	—	18-5864	20XD	6443973	B238463	—	18-5864
15	A197112	G760299	—	18-5864	25	5705532	8443972	—	18-5864
15 SEA PRO, SUPER 15	G044365	G437999	—	18-5863	25, 25 SEA PRO & MARATHON	B238464	G044026	—	18-5864
15 SEA PRO, SUPER 15	G438000	G760299	—	18-5864	25, 25 SEA PRO & MARATHON	G044027	G437999	—	18-5863
18	5837437	6443972	—	18-5864	25, 25 SEA PRO & MARATHON	G438000	G760299	—	18-5864

APPLICATION CONTINUED ON NEXT PAGE

STATOR & TRIGGER APPLICATIONS

HP	Beg. S/N	End S/N	Trigger	Stator	HP	Beg. S/N	End S/N	Trigger	Stator
25XD	5705532	G044029	—	18-5864	V150	A904646	C100860	18-5798	18-5860 ②
30 2 cyl. electric models	G055314	& UP	—	18-5870 **	V150	A904646	C100860	18-5798	18-5871
30 JET 3 cyl. electric models	G590000	T408989	—	18-5870 **	V150	C100861	C239552	18-5798	—
30 Jet 4 cyl. electric models	C158200	D055047	—	18-5874 **	V150	C239553	D081999	18-5798	18-5860 ③
35 2 cyl.	8445653	B110788	—	18-5864	V150	C239553	D081999	18-5798	— †
40 2 cyl.	3859435	5823917	—	18-5856 ①	V150	C239553	D081999	18-5798	—
40 2 cyl. electric start	G055314	& UP	—	18-5870 **	V150	D082000	G960499	18-5798	18-5876
40 3 cyl. electric start	G531301	& UP	—	18-5870 **	V150 EFI	D082000	G960499	18-5798	18-5876
40 3 cyl. electric start (Belgium)	9973100	& UP	—	18-5874 **	V150 XRI EFI	D082000	G303045	18-5798	18-5876
40 4 cyl. electric start	C159200	D055047	—	18-5874	150 XR-4	B242885	C100860	18-5798	18-5860
40 JET electric start	T178500	& UP	—	18-5874 **	150 XR-4	C100861	C239552	18-5798	—
45 4 cyl. manual start only	5531630	B110788	—	—	150 XR-4	C239553	D081999	18-5798	18-5860 ③
45 4 cyl. electric models	5531630	& UP	—	18-5870	150 XR-4	C239553	D081999	18-5798	— †
45 JET electric models	G590000	T129554	—	18-5874 **	150 XR-4	C239553	D081999	18-5798	—
50 4 cyl. manual start only	4357640	& UP	—	—	150 XR-4, MAG II	C239553	D081999	18-5798	—
50 4 cyl. electric models	4357640	& UP	—	18-5870	150 XR-4, MAG II	C239553	D081999	18-5798	—
50 3 cyl.	6428681	D000749	18-5797	18-5855	150 XR-6, MAG III	D082000	G960499	18-5798	18-5876
50, 55 3 cyl. electric start	G590000	& UP	—	18-5870	V175	4301235	6618750	18-5798	18-5857
50 3 cyl. electric models (Belgium)	9973100	& UP	—	18-5870	V175	6618751	C100860	18-5798	18-5871 ④
55 3 cyl. electric models	D000750	G589999	—	18-5870	V175	6618751	C100860	18-5798	18-5857 ④
55 3 cyl. electric models (Belgium)	9741042	9973088	—	18-5870	V175	6618751	C100860	18-5798	18-5860 ⑤
60 3 cyl.	6428681	D000749	18-5797	18-5855	V175	C100861	C239552	18-5798	—
60 3 cyl. electric models	G590000	& UP	—	18-5870 **	V175	C239553	D081999	18-5798	18-5860 ③
60 3 cyl. electric models (Belgium)	9973100	& UP	—	18-5870 **	V175	C239553	D081999	18-5798	—
60 3 cyl. Bigfoot	G590000	G760299	—	18-5874 **	V175	C239553	D081999	18-5798	— †
65 (850) 3 cyl.	4382057	4571651	—	18-5855	V175	D082000	G960499	18-5798	18-5876
70 3 cyl.	4571652	A996141	18-5797	18-5855	V175 MAG, EFI	D000750	D081999	18-5798	—
75 4 cyl.	6432901	& UP	—	18-5859	V175 EFI	D303046	G960499	18-5798	18-5876
75 3 cyl. electric models	G438000	& UP	—	18-5870	V175 XRI EFI	D000750	D081999	18-5798	—
80 (80, 800) 4 cyl.	4831999	6432900	—	18-5859	V175 XRI EFI	D082000	G303045	18-5798	18-5876
80 JET	G438000	& UP	—	18-5870 **	V200	4899034	6625220	18-5798	18-5857 ④
85 (850) 4 cyl.	4368902	4831998	—	18-5859	V200	6618751	C100860	18-5798	18-5860
90 6 cyl.	5299505	& UP	18-5798	18-5854	V200	C100861	D081999	18-5798	18-5860 ③
90 3 cyl. electric models	G438000	& UP	—	18-5870	V200	C100861	C291519	18-5798	— †
90 3 cyl. (Belgium) electric models	9927000	& UP	—	18-5870	V200	C100861	C291519	18-5798	—
100 4 cyl.	G438000	& UP	—	18-5870 **	V200	D082000	G960499	18-5798	18-5876
100 4 cyl.	9927000	& UP	—	18-5870 **	V200 EFI	C100861	D081999	18-5798	—
100 4 cyl. with voltage reg.	B209468	G437899	—	18-5873 **	V200 EFI	G303046	G960499	18-5798	18-5876
100 4 cyl. with voltage reg. (Belgium)	9523024	9926999	—	18-5873 **	V200 XRI EFI	C291520	D081999	18-5798	— †
105 JET	D082000	G960499	18-5798	18-5876	V200 XRI EFI	D082000	G960499	18-5798	18-5876
115 6 cyl.	5314656	& UP	18-5798	18-5854	V220	B117816	& UP	—	18-5860
115 4 cyl. electric models	G438000	& UP	—	18-5870 **	V225	5628028	& UP	18-5798	18-5857
115 4 cyl. electric models (Belgium)	9927000	& UP	—	18-5870 **	SPORTJET MODELS				
115 4 cyl. with voltage reg.	C10000	G437899	—	18-5873 **	80	ALL W/RED STATOR		—	18-5870
115 4 cyl. with voltage reg. (Belgium)	9559771	9926999	—	18-5873 **	95XR	ALL W/RED STATOR		—	18-5870
125 4 cyl.	G438000	& UP	—	18-5870 **	120XR	ALL W/RED STATOR		—	18-5870
125 4 cyl. (Belgium)	9927000	& UP	—	18-5870 **	175XR2	ALL		—	—
125 4 cyl. with voltage reg.	D283222	G437899	—	18-5873 **	① Electric start models only ② Stators with 5/8" laminations only ③ Applications with 16 amp Stator and non-louvered flywheel cover ④ Applications not using a voltage regulator ⑤ Stators with 5/8" laminations and used with 15 amp voltage regulator ⑥ Flywheel without screws ** May require the purchase of voltage regulator if not currently equipped † Applications with clear 40 amp stator with louvered flywheel cover				
125 4 cyl. with voltage reg. (Belgium)	9793577	9926999	—	18-5873 **					
V135	A904646	C100860	18-5798	18-5860 ②					
V135	A904646	C100860	18-5798	18-5871					
V135	C100861	C239552	18-5798	—					
V135	C239553	D081999	18-5798	18-5860 ③					
V135	C239553	D081999	18-5798	—					
V135	C239553	D081999	18-5798	—					
V135	D082000	G960499	18-5798	18-5876					
140	5327663	& UP	18-5798	18-5854					
140 JET	UP TQ	G760299	18-5798	18-5876					
V150	4868998	A904645	18-5798	18-5857					

All Voltage Regulators have built-in capacitors that provide high voltage spike protection.



18-5741
VOLTAGE REGULATOR

Replaces: 815279A2, 815279-1
For: Mercury engines with 16 amp or 40 amp charging system model/years 1989-91



18-5743
VOLTAGE REGULATOR

Replaces: 815279-3, 815279-5, 883072T
For: Mercury engines with 16 amp or 40 amp charging system model/years 1992 to present
***Note:** Black wire (not pictured) goes to engine ground.

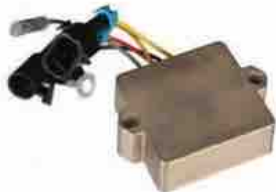

18-5732
VOLTAGE REGULATOR

Replaces: 893640T01
Fits: 30/40/50/60 EFI 4 Stroke



18-5707
RECTIFIER

Replaces: 62351A1, 62351A2, 816770, 816770T
All applications with square, 3 post rectifier



18-5802D
Display Package

18-5802
SOLENOID

Replaces: 65057A1, 65057T1, 65057, 54981



18-5808D
Display Package

18-5808
SOLENOID

Replaces: 47886, 47886T



18-5810D
Display Package

18-5810
SOLENOID
Horizontal Post



18-5811
STARTER SOLENOID

Replaces: 809463A1, 8094631, 809463, 8094621, 809462
For: PG280 Series Starters, (Verado 200-275 HP), (75/95 1.5L DFI), (115/135/150/175/200 2.5L DFI), (225 3.0L DFI)



18-5815D
Display Package

18-5815
SOLENOID

Replaces: 89-68258A4, 89-853654A1, 89-76545, 89-76545T, 89-65258, 89-61053, 89-15857



18-5816D
Display Package

18-5816
SOLENOID

Replaces: 89-96054, 89-96054T, 89-91975
Flat Bracket



18-5817D
Display Package

18-5817
SOLENOID

Replaces: 89-96158, 89-96158T, 94318, 846070
Vertical Post, Angled Bracket

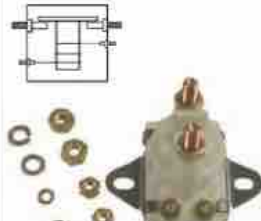

18-5818
SOLENOID
Replaces: 89-818864, 89-818864T

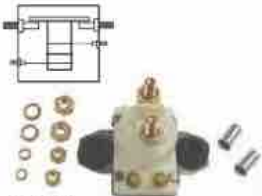

18-5819
SOLENOID

Replaces: 89-818997A1, 89-818997T1, 89-818997A2

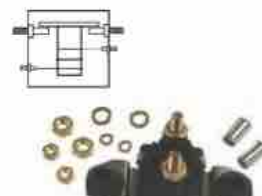

18-5820
SOLENOID

Replaces: 89-818999A2, 89-825842A1, 89-850188T1



18-5821
STARTER SOLENOID

Replaces: 89-825096T, 825096T01
Fits: 9.9 4-Stroke(1999 & Up), 15 4-stroke (1999 & Up), 30 4-stroke(2002 & Up), 40/50/60 4-stroke(2001 & Up), 75/90 4-stroke(2000 & Up)







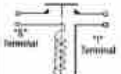

18-5822
CHOKE SOLENOID

Replaces: 54293A13, 54293A10, 54293A4
Fits: 75 4cyl (1984 & Up), V150 (1978 & Up), V150 Magnum (1978-85), V150 Marathon (1978-85), V150 XR 2 (1978-85), V1500 (1978-85), V175 (1976-99), V1750 (1976-88), V200 (1978 & Up), V2000 (1978-88)

APPLICATION ON NEXT PAGE

① Items ending in "D" are Application Packaged - Regular number is Non-Display

 <p>18-5834 SOLENOID Replaces: 89-817109A2 For: 75 HP (3 cyl.) S/N G127500 & UP</p>	<p style="text-align: center;">① 18-5836D</p>  <p style="text-align: center;">Display Package</p>  <p>18-5836 SOLENOID Replaces: 25661, 256611, 25661T1</p>	 <p>18-5729 POWER TRIM RELAY Replaces: 87-18211 For: 35 (2 cyl.) (with Ram Trim) OC159200 & UP 60 (3 cyl.) (with Ram Trim) OB122920 - OD000749</p>	 <p>18-5737 POWER TRIM RELAY Replaces: 87-19761 For: 40 (4 cyl.) (with Relays) OC159200 & UP</p>
 <p>18-5849 RELAY, SHROUDED, TRIM Replaces: 882751A1, 828151A1, 828151, 882751A2 Fits: Power Trim Relay used on most 2-stroke and 4-stroke (non-Verado®) engines.</p>	 <p>18-5850 RELAY, SHROUDED Replaces: 882751A04 Fits: 135hp - 350hp Verado (2005 - Current); 496Mag & 496HO (2004 - Current); 8.1HO (2004 - Current)</p>	 <p>18-5851 RELAY, SHROUDED Replaces: 865202T, 807057T, 807057</p>	 <p>18-5852 RELAY, SHROUDED Replaces: 821509T01, 821509, 853292 Fits: Four-Stroke: 45hp (OG231123-OG472132); 50hp. (OG231123-OT178499)</p>

① Items ending in "D" are Display Packaged - Regular number is Non-Display

SOLENOID APPLICATION

HP	Beg. S/N	End. S/N	Starter Solenoid/Relay	Power Trim Solenoid	Power Trim Relay
4-Stroke					
9.9 (4-Stroke)(323cc)	OG760300	OT979999	18-5821	—	—
15 (4-Stroke)(323cc)	OG760300	1B727495	18-5821	—	—
30 (4-Stroke) Carb	OG760300	& Up	—	—	18-5849
30 (4-Stroke) EFI	OT409000	1B226999	18-5821	—	18-5849
40 (4-Stroke)(3 cyl) Carb	OG760300	& Up	—	—	18-5849
40 (4-Stroke)(3 cyl) EFI	OT409000	& Up	18-5821	—	18-5849
40 (4-Stroke)(4 cyl) Carb	OT228405	OT598999	18-5821	—	18-5849
40 (4-Stroke)(4 cyl) EFI	OT409000	& Up	18-5821	—	18-5849
45 (4-Stroke) Bodensee	OG231123	OG472132	18-5821	—	18-5852
45 (4-Stroke) Bodensee	OG472133	OT178499	18-5821	—	18-5849
50 (4-Stroke)	OG231123	OT178499	18-5821	—	18-5852
50 (4-Stroke)(4 cyl) Carb 996cc	OT178500	OT598999	18-5821	—	18-5849
50 (4-Stroke)(4 cyl) EFI 996cc	OT409000	& Up	18-5821	—	18-5849
60 (4-Stroke)(4 cyl) Carb 996cc	OT178500	OT598999	18-5821	—	18-5849
60 (4-Stroke)(4 cyl) EFI 996cc	OT409000	& Up	18-5821	—	18-5849
75 (4-Stroke) Carb 1596cc	OG960500	1B226999	18-5821	—	—
75 (4-Stroke) EFI 1596cc	1B366823	& Up	18-5834	—	—
90 (4-Stroke) Carb 1596cc	OG960500	1B226999	18-5821	—	—
90 (4-Stroke) EFI 1731cc	1B366823	& Up	18-5821	—	—
115 (4-Stroke) EFI w/ 2 relay trim	OT178500	OT800999	—	—	18-5849
115 (4-Stroke) EFI 1731cc	OT809000	1B366822	—	—	18-5849
115 (4-Stroke) EFI 1731cc	1B366823	& Up	18-5821	—	—
135 (4-Stroke) Verado	1B227000	& Up	18-5850	—	18-5850
150 (4-Stroke) Verado	1B227000	& Up	18-5850	—	18-5850
175 (4-Stroke) Verado	1B227000	& Up	18-5850	—	18-5850
200 (4-Stroke)(4 cyl) Verado	1B517159	& Up	18-5850	—	18-5850
200 (4-Stroke)(6 cyl) Verado	OT980000	& Up	18-5850	—	18-5850
225 (4-Stroke)(6 cyl) Verado	OT980000	& Up	18-5850	—	18-5850
250 (4-Stroke)(6 cyl) Verado	OT980000	& Up	18-5850	—	18-5850
275 (4-Stroke)(6 cyl) Verado	OT980000	& Up	18-5850	—	18-5850
300 (4-Stroke)(6 cyl) Verado	1B517434	& Up	18-5850	—	18-5850
350 (4-Stroke)(6 cyl) Verado	1B716557	& Up	18-5850	—	18-5850
2-Stroke					
HP	Beg. S/N	End. S/N	Starter Solenoid	Power Trim Solenoid	Power Trim Relay
6/8/9.9	A197112	OD280999	18-5816	—	—
15	A197112	OD280999	18-5816	—	—
18	5837437	& UP	18-5816	—	—
20	4709593	6443972	18-5815	—	—
20	6443973	OG044026	18-5816	—	—
25	5705532	G044026	18-5816	—	—
30 (2 cyl) 644cc	G053314	& UP	—	—	18-5849
30 JET non-handle	C159200	G589999	18-5816	—	—
35 2 cyl (w/ 3 Ram Trim)	6445653	C159199	18-5817	18-5817	—

① Use 18-5817 for applications with circuit breaker and fuse.

② For units with 10-32, 5/16-18 terminals.

③ For design II applications use 18-5820.

④ For units with 8-32, 1/4-20 terminals.

④ Use 18-5818 if off white solenoid is needed.

⑤ w/rubber bushing solenoid

SOLENOID APPLICATION

HP	Beg. S/N	End. S/N	Starter Solenoid	Power Trim Solenoid	Power Trim Relay
35 2 cyl (w/ 1 Ram Trim)	C159200	& UP	18-5817	—	18-5729
40 2 cyl	2874704	5556229	18-5836	—	—
40 2 cyl	5556230	5823917	18-5815	—	—
40 2 cyl	5823918	G053313	18-5817	—	—
40	G053314	& UP	18-5816 ⑤	—	—
40 4 Cyl.(w/solenoids)	C159200	& UP	18-5816	18-5820	—
40 4 Cyl.(w/relays)	C159200	& UP	18-5816	—	18-5737
45 4 Cyl.(w/o circuit breaker)	5531630	6146848	18-5815	18-5815	—
45 4 Cyl.(w/circuit breaker)	5531630	6146848	18-5815	18-5817	—
45 4 Cyl.(w/o circuit breaker)	6146849	B110788	18-5817	18-5815 ①	—
45 4 Cyl.(w/circuit breaker)	6146849	B110788	18-5817	18-5817	—
45 4 Cyl.	B110789	& UP	18-5817	18-5817	—
45 JET (w/flush mount solenoid)	D000750	G290584	18-5816	—	—
45 JET	G290585	G589999	18-5820	—	—
50	3008819	4140999	18-5836	—	—
50	4141000	5531629	18-5815	—	—
50 4 Cyl.(w/circuit breaker)	5531630	6146848	18-5815	18-5815 ①	—
50 4 Cyl.(w/circuit breaker)	5531630	6146848	18-5815	18-5817	—
50 4 Cyl.(w/o circuit breaker)	6146849	& UP	18-5817	18-5815 ①	—
50 4 Cyl.(w/circuit breaker)	6146849	& UP	18-5817	18-5817	—
50 3 Cyl.	6428681	B122929	18-5816	18-5817	—
50 3 Cyl. (w/ 3 Ram Trim)	B122930	C160935	18-5817	18-5817	—
50 3 Cyl. (w/ 1 Ram Trim)	B122930	D000749	18-5817	—	18-5729
50 3 Cyl.	D000750	G290584	18-5816	—	18-5849
50 3 cyl	G290585	G589999	18-5820	—	18-5849
50 3 cyl	G590000	& UP	—	—	18-5849
55 3 Cyl.	D000750	G290584	18-5816 ⑤	—	18-5849
55 3 Cyl.	G290585	G589999	18-5820	—	18-5849
60 3 Cyl.	6428681	B122929	18-5816	18-5817	—
60 3 Cyl. (w/solenoids)	B122930	D000749	18-5817	18-5817	—
60 3 Cyl. (w/relays)	B122930	D000749	18-5817	—	18-5729
60 3 Cyl.	D000750	G290584	18-5816 ⑤	—	18-5849
60 3 Cyl.	G290585	G589999	18-5820	—	18-5849
65 4 Cyl.	2446775	3293183	18-5836	—	—
65 3 Cyl.	3547987	4571651	18-5815	—	—
65 JET	G127500	& UP	18-5834	—	—
70 3 Cyl.	4571652	5579016	18-5815	—	—
70 3 Cyl.	5579017	6104369	18-5815	18-5815 ①	—
70 3 Cyl.	6104370	6428680	18-5816	18-5815 ①	—
70 3 Cyl.	A996147	& UP	18-5817	18-5817	—
75 4 Cyl.	6432901	& UP	18-5816	18-5817	—
75 3 cyl w/ 1 Ram Trim	C222000	D252460	—	—	18-5849
75 3 Cyl.	D252461	G127499	18-5817	18-5819	—
75 3 Cyl.	G127500	G360002	18-5834	18-5819	—
75 3 Cyl.	G360003	& UP	18-5834	—	18-5849
75 Optimax 3 cyl (1.5L)	T801000	& UP	18-5834	—	18-5849
80	2559001	3493912	18-5836	—	—
80 4 Cyl.	4831999	5582561	18-5815	—	—
80 4 Cyl.	5582562	6030903	18-5815	18-5815 ①	—
80 4 Cyl.	6030904	6432900	18-5816	18-5815 ①	—
80 3 Cyl.	A996142	& UP	18-5817	18-5817	—
80 JET 4 cyl	D283222	& UP	18-5834	—	—
80 JET 3 cyl	B586067	& UP	18-5834	—	18-5849
85 4 Cyl.	3493913	3865694	18-5836	—	—
85 4 Cyl.	3865695	4831998	18-5815	—	—
90	4845301	5299505	18-5815	18-5815	—
90	5299506	6026608	18-5815	18-5815 ①	—
90	6026609	6436122	18-5816	18-5815 ①	—
90	6436123	& UP	18-5816	18-5817	—
90 3 Cyl.	A996142	C221999	18-5817	18-5817	—
90 3 Cyl. w/ 1 Ram Trim	C222000	D252460	—	—	18-5849
90 3 Cyl.	D252461	G127499	—	18-5819	—
90 3 Cyl.	G127500	G360002	18-5834	18-5819	—
90 3 Cyl.	G360003	& UP	18-5834	—	18-5849
90 Optimax 3 cyl (1.5L)	T801000	& UP	18-5834	—	18-5849
100 6 Cyl.	2318586	3253111	18-5836	—	—
100 4 Cyl. w/ 1 Ram Trim & 5/16-18 starter terminal	B209468	D252460	18-5834	—	18-5849
100 4 Cyl. w/ 3 Ram Trim & 5/16-18 starter terminal	B209468	D252460	18-5834	—	—
100 4 Cyl.	D252461	G359967	18-5834	18-5819	—
100 4 Cyl.	G359968	& UP	18-5834	—	18-5849
105 JET w/ flush mounted starter solenoid	D082000	G303045	18-5815	—	—
105 JET w/ rubber mounted starter solenoid	D082000	G303045	18-5834	—	—
105 JET	G303046	& UP	18-5834	—	—
110 6Cyl.	1870204	2314955	18-5836	—	—
115	2836019	4112634	18-5836	18-5836	—
115	4112635	5600966	18-5815	18-5815	—
115	5600967	6051525	18-5815	18-5815 ①	—
115	6051526	6436122	18-5816	18-5817 ①	—
115	6436123	& UP	18-5816	18-5817	—
115 4 Cyl. w/ 3 Ram Trim & 5/16-18 starter terminal	C100000	D252460	18-5834	—	—
115 4 Cyl. w/ 1 Ram Trim & 5/16-18 starter terminal	C100000	D252460	18-5834	—	18-5849
115 4 Cyl.	D252461	G359967	18-5834	18-5819	—
115 4 Cyl.	G359968	& UP	18-5834	—	18-5849
115 Optimax 3 cyl (1.5L)	T801000	& UP	18-5834	—	18-5849

① Use 18-5817 for applications with circuit breaker and fuse.

③ For units with 10-32, 5/16-18 terminals.

⑤ For design II applications use 18-5820.

② For units with 8-32, 1/4-20 terminals.

④ Use 18-5818 if off white solenoid is needed.

⑥ w/rubber bushing solenoid

SOLENOID APPLICATION

HP	Beg. S/N	End. S/N	Starter Solenoid	Power Trim Solenoid	Power Trim Relay
115 Pro XS	8751825	& UP	18-5834	—	18-5849
125	2314956	3253111	18-5836	—	—
125 4 Cyl.	D283222	G359967	18-5834	18-5819	—
125 4 Cyl.	G359968	& UP	18-5834	—	18-5849
125 Optimax 3 cyl (1.5L)	B736885	& UP	18-5834	—	18-5849
135	2839369	3293233	18-5836	—	—
V135	A904646	C100860	18-5815 ①	18-5817	—
V135	A904646	C100860	18-5816 ②	18-5817	—
V135	C100861	C239552	18-5815	18-5817	—
V135	C239553	D081999	18-5815 ④	18-5817	—
V135 (w/flush mounted solenoid)	D082000	G201874	18-5815	18-5819	—
V135 (w/rubber bushing solenoid)	D082000	G201874	18-5834	18-5819	—
V135 (w/flush mounted solenoid)	G201875	G303045	18-5815	—	18-5849
V135 (w/rubber bushing solenoid)	G201875	G303045	18-5834	—	18-5849
V135	G303046	& UP	18-5834	—	18-5849
V135 DFI	G590000	& UP	18-5834	—	18-5849
140	3293234	3502805	18-5836	18-5836	—
140	4865678	& UP	18-5815	18-5815	—
140 JET	G303046	T178499	18-5834	—	18-5849
150	3502806	4121434	18-5836	18-5836	—
150	4121435	4865677	18-5815	18-5836	—
150 XS	4868648	5327662	18-5815	18-5815	—
V150	4868998	6042945	18-5815	18-5817	—
V150	6042946	A904645	18-5816	18-5817	—
V150	A904646	C100860	18-5815 ③	18-5817	—
V150	A904646	C100860	18-5817 ⑤	18-5817	—
V150	C100861	C239552	18-5815	18-5817	—
V150	C239553	D081999	18-5815 ⑥	18-5817	—
V150, 150 EFI w/flush mounted solenoid	D082000	G201874	18-5815	18-5819	—
V150, 150EF w/rubber mount solenoid	D082000	G201874	18-5834	18-5819	—
V150, 150 EFI w/flush mounted solenoid	G201875	G303045	18-5815	—	18-5849
V150, 150EF w/rubber mount solenoid	G201875	G303045	18-5834	—	18-5849
V150, 150 EFI	G303046	& UP	18-5834	—	18-5849
V150 DFI	G590000	& UP	18-5834	—	18-5849
150 XR-4/Magnum II	B242885	C239552	18-5815	18-5817	—
150 XR-4/Magnum II w/standard color solenoid	C239553	D081999	18-5815	18-5817	—
150 XR-4/Magnum II w/off white color solenoid	C239553	D081999	18-5815	18-5818 ⑦	—
150 XR-6/Magnum III w/flush mounted solenoid	D082000	G201874	18-5815	18-5819	—
150 XR-6/Magnum III w/rubber mounted solenoid	D082000	G201874	18-5834	18-5819	—
150 XR-6/Magnum III	G201875	G303045	18-5815	—	—
150 XR-6/Magnum III w/flush mounted solenoid	G201875	G303045	18-5815	—	18-5849
150 XR-6/Magnum III w/rubber mounted solenoid	G201875	G303045	18-5834	—	18-5849
150 XR-6/Magnum III	G303046	& UP	18-5834	—	18-5849
V175	4301235	6618750	18-5815	18-5815	—
V175	6618751	C239552	18-5816 ②	18-5817	—
V175	6618751	C239552	18-5815 ③	18-5817	—
V175	C100861	C239552	18-5815	18-5817	—
V175	C239553	D081999	18-5815 ④	18-5817	—
V175, 175 EFI w/ flush mounted solenoid	D082000	G201874	18-5815	18-5819	—
V175, 175 EFI w/ rubber mounted solenoid	D082000	G201874	18-5834	18-5819	—
V175, 175 EFI w/ flush mounted solenoid	G201875	G303045	18-5815	—	18-5849
V175, 175 EFI w/ rubber mounted solenoid	G201875	G303045	18-5834	—	18-5849
V175, 175 EFI	G303046	& UP	18-5834	—	18-5849
V175 DFI	G590000	& UP	18-5834	—	18-5849
V175 Pro XS	B516339	& UP	18-5834	—	18-5849
V200	4839034	6073191	18-5815	18-5815	—
V200	6073192	6225220	18-5816	18-5817	—
V200	6625221	C100860	18-5816 ②	18-5817	—
V200	6625221	C100860	18-5815 ③	18-5817	—
V200	C100861	C291519	18-5815	18-5817	—
V200 (2.5L)	C291520	D081999	18-5815 ④	18-5817	—
V200 w/ flush mounted solenoid	D082000	G201874	18-5815	18-5819	—
V200 w/ rubber mounted solenoid	D082000	G201874	18-5834	18-5819	—
V200, 200 EFI (w/flush mounted solenoid)	D082000	G201874	18-5815	18-5819	—
V200, 200 EFI (w/rubber bushing solenoid)	D082000	G201874	18-5834	18-5819	—
V200, 200 EFI (w/flush mounted solenoid)	G201875	G303045	18-5815	—	18-5849
V200, 200 EFI (w/rubber bushing solenoid)	G201875	G303045	18-5834	—	18-5849
V200, 200 EFI	G303046	& UP	18-5834	—	18-5849
V200 DFI	G386496	& UP	18-5834	—	18-5849
V220 (Laser)	B117316	& UP	18-5815	18-5817	—
V225 2.4L	5628028	& UP	18-5815	18-5815	—
V225 3.0L	D280813	G129221	18-5834	18-5819	—
V225 3.0L	G129222	G303045	18-5834	18-5819	—
V225 3.0L	G129222	G303045	18-5834	—	18-5849
V225 3.0L	G303046	& UP	18-5834	—	18-5849
V225 DFI	G590000	& UP	18-5834	—	18-5849
V225 Sea Pro / Marathon	G245605	& UP	18-5834	—	18-5849
V225 Pro XS	B104549	& UP	18-5834	—	18-5849
V225/250 EFI	G129222	& UP	18-5834	—	18-5849
V250XB	G980600	& UP	18-5834	—	18-5849
V250 Pro XS	B426561	& UP	18-5834	—	18-5849
V250/275 (3.4L)	C101891	& UP	18-5815	18-5817	—
300 (3.4L)	5611648	& UP	18-5815	18-5817	—

① Use 18-5817 for applications with circuit breaker and fuse. ② For units with 10-32, 516-18 terminals. ③ For design II applications use 18-5820.
 ④ For units with 8-32, 114-20 terminals. ⑤ Use 18-5818 if off white solenoid is needed. ⑥ w/rubber bushing solenoid



18-5929
ALTERNATOR
Replaces: 892940T
All Verado's



18-6454
ALTERNATOR
Replaces: 875285T1, 8M0064021, 889955A03, 834832, 881246T, 857006T
5S/1 50 amp Spool mount
Fits: 2.5L

NEW



18-6408
ALTERNATOR
Replaces: 863077T
For: Mercruiser 377 Scorpion
97-Up



18-6455
ALTERNATOR
Replaces: 875286T, 875286A1, 881247A1
5S/1 50 amp
Fits: 1.5L and 3.0L
For: 200 DFI, 200 DFI/DTS, 225 EFI, 225 EFI, Sea Pro, 225 DFI/DTS, 250 EFI



18-6840
ALTERNATOR
Replaces: 50-897755T, 897755T
Fits: 75-115HP EFI (4-Stroke)



18-18000
SERPENTINE BELTS
Replaces: 57-892318
For: 75 DFI (2005-06), 90 DFI (2005-06), 15 DFI (2004-06)



18-15128
SERPENTINE BELTS
Replaces: 57-880566014
Fits: All Verados-135-275HP

SERPENTINE BELTS

18-18100
SERPENTINE BELTS
Replaces: 57-828507Q4
For: 135 DFI (1998-Up), 150 DFI (1998-Up), 175 DFI (2001-Up)

SERPENTINE BELTS

18-15129
SERPENTINE BELTS
Replaces: 57-828507 1
Fits: 200 DFI (1997& Up), 225 DFI (1998 & Up)



18-6500
SERVICE END ALTERNATOR HARNESS
Replaces: 84-881262A2
Fits: Optimax (1998-01) For: Delco Alternators

ALL STARTERS ARE COUNTER CLOCKWISE ROTATION



18-6435
STARTER
Replaces: 50-888161T, 50-884044T, 50-859377T, 50-893888T
Fits: 40,50,60 HP 4 Stroke 4 Cyl, 0P094500 & UP; 50,60 HP EFI 4 Stroke 4 Cyl, 0P153500-UP



18-6436
STARTER
Replaces: 50-859171T, 50-834749, 50-898265001
Fits: 40HP Italy 4 Stroke 0G760300-UP; 45HP Bodensee 0G760300-UP; 50HP 4 Stroke 0G760300-UP; 50HP Bigfoot 4 Stroke 0G760300-UP



18-6437
STARTER
Replaces: 50-888151T, 50-830308T, 50-859169T, 50-893888T
Fits: 25HP 4 Stroke 0G760300 & UP



18-6438
STARTER
Replaces: 50-888160T, 50-884045T, 50-859170T, 50-854636T, 50-893887T
Fits: 30,40HP 3 Cyl 4 Stroke 0G760300 & UP



18-6425
STARTER
Replaces: 50-804312T1
For: 4 Stroke 75 HP, and 90HP except Verado



18-6440
STARTER
Replaces: 50-892339T, 50-853329T
Fits: 90 V135, V150, V175, V200, 2.5L DFI, 0T178500 & UP; 200, 250 HP, 3.0L, 0T467442 & UP, and Inline 4 and 6 cyl. Verados. Models with solenoid operated bendix.



18-5601
STARTER
Replaces: 50-55601, 50-55601A2, 50-38890A1
Fits: 35-50 HP models



18-5602
STARTER
Replaces: 50-67341, 50-58788A3, 50-893891T, 50-44369A1
Fits: 35-40 HP, 2 cyl. & 50 HP, 4 cyl. models



18-5642
STARTER
Replaces: 50-66015, 50-66015T, 50-893891T, 50-44369A1
Fits: 50-90 HP models (1976-99), 10 Tooth Drive Gear



18-6282
STARTER
Replaces: 50-8329972, 50-832997003
Fits: Mercury V6 Jet (1996 and up), 8 Tooth Drive Gear



18-6283
STARTER
Replaces: 50-8331535, 50-898265008
For: Mercury 2.5 DFI (1999 and up), 200HP V6 DFI (1996-99), 225HP V6 DFI (1998 and up), 3.0L V6 (1999 and up) 9 Tooth Drive Gear
Uses Drive Kit 18-5658



18-5605
STARTER
Replaces: 50-73521, 50-73521T, 50-898265005
Fits: 40-50 HP models



18-5606
STARTER
Replaces: 50-44369, 50-60315, 50-44369A1, 50-898265012
Fits: 50-70 HP models (1976-94)



18-5608
STARTER
Replaces: 50-44415, 50-77141, 50-79472, 50-44414, 50-79472 1, 50-893893
Fits: 2.5L, 3.4L & 135 Jet models



18-5610
STARTER
Replaces: 50-66015T, 50-660151, 50-660153, 50-893892T, 50-893892T
(8 Tooth)
Fits: 1.7L, 1.9L & 1.4L (1988-2008)



18-5611
STARTER
Replaces: 50-90983A-1, 50-90983T1, 50-8M0033984
For: 6-15 HP (1986-96), 18-25 HP (1980-87), 10 tooth drive gear



18-5620
STARTER
Replaces: 50-818445-3, 50-818445-2, 50-818445 5, 50-898265009
Fits: 2.5L, 3.0L & 225-250 HP models (1993-2000)

ALL STARTERS ARE COUNTER CLOCKWISE ROTATION



**18-5621
STARTER**
Replaces: 50-822462, 50-822462T1,
50-893890T
Fits: 30-60 HP models



**18-5636
STARTER**
Replaces: 50-57465A1, 50-57867,
50-64975, 50-72467, 50-58788A3
Length: 11 1/2"
Fits: 65-175 HP models (1973-88)



**18-6824
OUTBOARD STARTER**
Replaces: 50-60594A, A1, T01
Fits: 2.0, 2.4, and 2.5L Racing Engines



**18-6825
STARTER**
Replaces: 50-86976
(9 Tooth)
Fits: 200-225HP V6 engines



**18-6828
STARTER**
Replaces: 50-41583
Fits: 35, 35 (2 CYL.), 402, 40 (2 CYL.)



**18-6829
STARTER**
Replaces: 50-852570, T, 50-857065, 50-859168,
T, 859168, T
Fits: Mercury, Mariner 9.9-15HP 4-Stroke Engines



**18-6864
STARTER**
Replaces: 50-819271, 50-820193A1
Fits: Mercury 40-50HP Engines



**18-6940
STARTER**
Replaces: 50-825991A2
Fits: 9.9HP 4-Stroke Engines



**18-6943
STARTER**
Replaces: 50-893894
Fits: 9.9-15HP Engines

NEW



**18-55505
OUTBOARD STARTER**

Replaces: 8M0142679
Fits: 175-300 HP; 250-300 VERADO; 250 4.6L V8 Verado (4-stroke) - 2B529482 AND UP, 300 4.6L V8 Verado (4-stroke) - 2B529482 AND UP, 300 4.6L V8 Verado (4-stroke) SEAPRO - 2B529482 AND UP, 225 4.6L V8 (4-STROKE) SEAPRO - 2B529482 AND UP, 250 4.6L V8 (4-STROKE) SEAPRO - 2B529482 AND UP, 250 4.6L V8 (4-STROKE) RACING - 1E080500 AND UP, 300 4.6L V8 (4-STROKE) RACING - 1E080500 AND UP, 200 4.6L V8 PRO XS (4-STROKE) 2B529482 AND UP, 225 4.6L V8 PRO XS (4-STROKE) 2B529482 AND UP, 250 4.6L V8 PRO XS (4-STROKE) 2B529482 AND UP, 300 4.6L V8 PRO XS (4-STROKE) 2B529482 AND UP, 175 3.4L V6 (4-STROKE) 2B529482 AND UP, 200 3.4L V6 (4-STROKE) 2B529482 AND UP, 200 3.4L V6 (4-STROKE) SEAPRO 2B529482 AND UP, 175 3.4L V6 PRO XS (4-STROKE) 2B529482 AND UP

NEW



**18-55506
OUTBOARD STARTER**

Replaces: 8M0137769
Fits: 75 EFI (4-STROKE) - 2B095049 AND UP, 75 EFI (4-STROKE) SEAPRO 2B095049 AND UP, 80 EFI (4-STROKE) 2B095049 AND UP, 90 EFI (4-STROKE) 2B095049 AND UP, 90 EFI (4-STROKE) SEAPRO 2B095049 AND UP, 100 EFI (4-STROKE) 2B095049 AND UP, 115 EFI (4-STROKE) 2B095049 AND UP, 115 EFI (4-STROKE) SEAPRO 2B095049 AND UP, 65 JET (4-STROKE) 2B095049 AND UP, 80 JET (4-STROKE) 2B095049 AND UP, 115 PRO XS (4-STROKE) 2B225488 AND UP

ALL STARTERS ARE COUNTER CLOCKWISE ROTATION



18-6250 STARTER REPAIR KIT
Prestolite
2 Brush

18-6251 STARTER REPAIR KIT
Prestolite
4 Brush

18-5697 DRIVE BRUSH KIT
Replaces: 75384
See chart below for additional application

18-5650 DRIVE ASSEMBLY
Replaces: 57380
See chart below for additional application

18-5656 DRIVE ASSEMBLY
Replaces: 68575
(10 Tooth)
See chart below for additional application

18-5658 DRIVE ASSEMBLY
Replaces: 86177, 86177 1
(9 Tooth)
See chart below for additional application

18-5674 DRIVE ASSEMBLY
Replaces: 75661, 13310T1
(8 Tooth)
See chart below for additional application

MERCURY

H.P.	Req. Serial #	Ending Serial #	O.E.M.#	Starter #	O.E.#	Drive Assembly	O.E.#	Drive Tooth Count	Brush Kit	O.E.#
6	A197112	& Up	50-8M0033984/50-90983A1	18-5611	96562	—	—	10	—	—
7.5	3801458	4851692	50-73531	Ⓢ	96562	—	96562/75427	10	18-5697	75384
7.5	4851693	& Up	50-78011	Ⓢ	96562	—	96562/75427	10	18-5697	75384
8/9.9/15	A197112	& Up	50-8M0033984/50-90983A1	18-5611	96562	—	—	10	—	—
18	5837437	& Up	50-8M0033984/50-90983A1	18-5611	96562	—	—	10	—	—
20	4709593	6443973	50-76275	Ⓢ	96562	—	96562/75427	10	—	—
20	6443973	& Up	50-8M0033984/50-90983A1	18-5611	96562	—	—	10	—	—
25	5705532	& Up	50-8M0033984/50-90983A1	18-5611	96562	—	—	10	—	—
30 2 cyl.	G053314	& Up	50-893890T/50-822462	18-5621	N.L.A.	18-5656	68575	10	18-5697	75384
30 JET	G159200	G589999	50-898265005/50-73521	18-5605	68575 3	18-5656	68575	10	18-5697	75384
30 JET 3 cyl.	G590000	T408999	50-893890T/50-822462	18-5621	90643	18-5656	68575	10	18-5697	75384
35 2 cyl.	6445653	& Up	50-41583T/50-41583	Ⓢ	N.L.A.	—	43076/43076T	10	18-5697	75384
35/40 2 cyl.	6445652	& DQWN	50-56601A2/50-56601	18-5601	N.L.A.	18-5650	57380	9	18-5697	75384
40 2 cyl.	G053314	& Up	50-893890T/50-822462	18-5621	68575 3	18-5656	68575	10	18-5697	75384
40H.P. 3 cy.	G590000	G760299	50-893890T/50-822462	18-5621	68575 3	18-5656	68575	10	18-5697	75384
40 3 cyl.	G760300	& Up	50-893890T/50-822462	18-5621	68575 3	18-5656	68575	10	18-5697	75384
40 4 cyl.	C159200	& Up	50-898265005/50-73521	18-5605	68575 3	18-5656	68575	10	18-5697	75384
40 JET	T178500	& Up	50-893890T/50-822462	18-5621	68575 3	18-5656	68575	10	18-5697	75384
45 4 cyl.	5531630	& Up	50-898265005/50-73521	18-5605	68575 3	18-5656	68575	10	18-5697	75384
45 JET	D000750	G589999	50-44369A1/50-65436/50-60315	18-5606 Ⓢ	68575 3	18-5656	—	—	—	—
45 JET	G590000	T129554	50-893890T/50-822462	18-5621	68575 3	18-5656	68575	10	18-5697	75384
50 4 cyl.	4357639	& Below	50-56601A2/50-38990A1	18-5601	N.L.A.	18-5650	57380	9	18-5697	75384
50 4 cyl.	4357640	& Up	50-898265005/50-73521	18-5605	68575 3	18-5656	68575	10	18-5697	75384
50 3 cyl.	B122930	G589999	50-44369A1	18-5606 Ⓢ	68575 3	18-5656	—	—	—	—
50 3 cyl.	G590000	& Up	50-893890T/50-822462	18-5621	68575 3	18-5656	68575	10	18-5697	75384
55 3 cyl.	D000750	G589999	50-44369A1	18-5606 Ⓢ	68575 3	18-5656	—	—	—	—
55 3 cyl.	G590000	& Up	50-893890T/50-822462	18-5621	68575 3	18-5656	68575	10	18-5697	75384
60 3 cyl.	6428681	G589999	50-44369A1/50-65436/50-60315	18-5606 Ⓢ	68575 3	18-5656	—	—	—	—
60 3 cyl.	G590000	& Up	50-893890T/50-822462	18-5621	68575 3	18-5656	68575	10	18-5697	75384
60 3 cyl. Bigfoot	G590000	G760299	50-893890T/50-822462 1	18-5621	68575 3	18-5656	68575	10	18-5697	75384
65 4 cyl.	2803822	3293183	50-57867A1/50-58788	18-5636	68575 3	18-5656	68575	10	18-5697	75384
65 3 cyl.	3293184	4571651	50-44369A1/50-65436/50-60315	18-5606	68575 3	18-5656	—	—	—	—
65 Jet	D283222	& Up	50-893891T/50-66015	18-5642	68575 3	18-5656	68575	10	18-5697	75384
70 3 cyl.	457165	A996142	50-44369A1/50-65436/50-60315	18-5606	68575	18-5656	—	—	—	—
80 4 cyl.	2783253	3493912	50-57867A1/50-58788	18-5636	N.L.A.	—	68575	10	18-5697	75384
80 4 cyl.	4831999	& Up	50-893891T/50-66015	18-5642 Ⓢ	68575 3	18-5656	68575	10	18-5697	75384
85 4 cyl.	3865694	& Below	50-58788A3/50-58788	18-5636	N.L.A.	18-5656	68575	10	18-5697	75384
85 4 cyl.	3865695	4366801	50-67341	18-5602	68575 3	18-5656	68575	10	18-5697	75384
80 Jet	D283222	& Up	50-893892T/50-66015-1	18-5610	68575 3	18-5656	75660/13310T1	8	18-5697	75384
90	Ⓢ 4845301	& Up	50-72467/50-64975/50-57465A1	18-5636	68575 3	18-5656	68575	10	18-5697	75384
90 3 cyl.	A996142	& Up	50-893891T/50-66015	18-5642	68575 3	18-5656	68575	10	18-5697	75384
100 4 cyl.	B209468	G965520	50-893892T/50-66015-1	18-5610	68575 3	18-5674	75660/13310T1	8	18-5697	75384
105 JET	G760299	& Below	50-893893/50-44414/50-44415/50-79472/50-77141/50-44414/50-44415	18-5608	13310T 1	18-5674	75660/13310T1	8	18-5697	75384
115 6 cyl. Ⓢ	4855153	& Up	50-72467/50-64975/50-57465A1	18-5636	68575 3	18-5656	68575	10	18-5697	75384
115 4 cyl.	C100000	& Up	50-893892T/50-66015-1	18-5610	68575 3	18-5674	75660/13310T1	8	18-5697	75384
125 4 cyl.	D283222	& Up	50-893892T/50-66015-1	18-5610	68575 3	18-5674	75660/13310T1	8	18-5697	75384
135 V-6	A904646	G960499	50-893893/50-79472/50-77141/50-44414/50-44415	18-5608	13310T 1	18-5674	75660/13310T1	8	18-5697	75384

Note: Some starters will replace Prestolite versions however replacement parts are for Bosch versions only.

Ⓢ Inline 6 cylinder

Ⓢ With 8 tooth pinion

Ⓢ With 9 tooth pinion

Ⓢ No replacement starter available, drive parts only

Ⓢ Bosch models only

Ⓢ Some applications require Mercury adapter #44368 (prior to S/N 0D000750)

MERCURY										
H.P.	Beg. Serial #	Ending Serial #	O.E.M.#	Starter #	O.E.#	Drive Assembly	O.E.#	Drive Tooth Count	Brush Kit	O.E.#
140 6 cyl. Inline ② 140 JET	4865678 G960499	& UP & Below	50-72467/50-64975/50-57465A1 50-893893/50-44414/50-44415/ 50-79472/50-77141	18-5636 18-5608	68575 3 1310T 1	18-5656 18-5674	68575 75660/13310T1	10 8	18-5697 18-5697	75384 75384
150 ② V150	4121435 4868998	& Up G960499	50-72467/50-84975/50-57465A1 50-793793/50-79472/50-77141	18-5636 18-5608	68575 3 1310T 1	18-5656 18-5674	68575 75660/13310T1	10 8	18-5697 18-5697	75384 75384
150 XR2 150 XR4	4868998 B242885	A9D4645 D819999	50-44414/50-44415 50-893893/50-79472/50-77141/ 50-44414/50-44415	18-5608 18-5608	N.L.A. 13310T 1	18-5674 18-5674	75660/13310T1 75660/13310T1	8 8	18-5697 18-5697	75384 75384
150 XR6	D082000	G960499	50-893893/50-79472/50-77141/ 50-44414/50-44415	18-5608	13310T 1	18-5674	75660/13310T1	8	18-5697	75384
150 EFI	G303046	T408999	50-893893/50-79472/50-77141/ 50-44414/50-44415	18-5608	13310T 1	18-5674	75660/13310T1	8	18-5697	75384
V175 175 EFI, XRI, MAG	4301235 D000750	G960499 G960499	50-893893/50-79472/50-77141 50-893893/50-44414/50-44415	18-5608 18-5608	13310T 1 N.L.A.	18-5674 18-5674	75660/13310T1 75660/13310T1	8 8	18-5697 18-5697	75384 75384
200 200 EFI, XRI	4839034 C100861	G960499 G960499	50-893893/50-79472/50-77141 50-893893/50-44414/50-44415	18-5608 18-5608	13310T 1 N.L.A.	18-5674 18-5674	75660/13310T1 75660/13310T1	8 8	18-5697 18-5697	75384 75384
2.4EF/2.5EFI/ 2.5 Carb/	ALL ALL	— —	50-893893/50-79472/50-77141/ 50-44414/50-44415 50-893893/50-79472/50-77141/ 50-44414/50-44415	18-5608 18-5608	13310T 1 13310T 1	18-5674 18-5674	75660/13310T1 75660/13310T1	8 8	18-5697 18-5697	75384 75384
3.4L/MOD VP ④	ALL	—	50-893893/50-79472/50-77141/ 50-44414/50-44415	18-5608	13310T 1	18-5674	75660/13310T1	8	18-5697	75384
V200 V225 225 3.0L Carb.	5363918 5628028 D280813	8435503 D280812 T408999	50-86976 50-86976 50-898265009/50-818445-3/ 50-818445-2	18-6825 18-6825 18-5620	8677 1 8677 1 13310T 1	18-5658 18-5658 18-5674	86177/86177 1 86177/86177 1 75661/13310T1	9 9 8	18-5697 18-5697 18-5697	75384 75384 75384
225/250 EFI 3.0L 250XB	G129222 G980600	& Up & Up	50-898265009/50-818445-3/ 50-818445-2 50-898265009/50-818445-3/ 50-818445-2	18-5620 18-5620	13310T 1 13310T 1	18-5674 18-5674	75661/13310T1 75661/13310T1	8 8	18-5697 18-5697	75384 75384

Note: Some starters will replace Prestolite versions however replacement parts are for Bosch versions only. ② Inline 6 cylinder ③ With 8 tooth pinion ④ With 9 tooth pinion ⑤ No replacement starter available, drive parts only ⑥ Bosch models only some applications require Mercury adapter #44368 (prior to S/N 0D000750)

**18-4915
STARTER ROPE**

Replaces: 50-12066A9, 50-12066Q9,
50-45093, 50-28985A2, 50-22791A1, 50-12066A1



**18-6506
REWIND SPRING**

Replaces: 24-29340A1, T1



REWIND SPRING APPLICATION

Model/HP	Beg. S/N	End S/N	Rewind Spring	Model/HP	Beg. S/N	End S/N	Rewind Spring
Merc 4	2498136	4107219	18-6506	Merc 35	1217222	1271884	18-6506
Merc 4.5	4107220	& UP	18-6506	Merc 35	1356948	1448139	18-6506
Merc 6	1408611	2387383	18-6506	Merc 35	1571114	1960826	18-6506
Merc 7.5	2529895	& UP	18-6506	Merc 35	1960827	2097279	—
Mar 8	M-677-000101	& UP	—	Merc 35	2097832	2258868	—
Merc 9.8	ALL	ALL	18-6506	Merc 35	2300962	2453068	—
Mar 9.9	M-682-000551	M-682-032885	—	Merc 35	2487558	2874703	—
Mark (10) 10	ALL	ALL	18-6506	Merc 35	6445653	& UP	—
Merc 10	1290910	1455239	18-6506	Mark (53) 40	831021	& UP	18-6506
Mark (15) 15	ALL	ALL	18-6506	Merc 40	1279685	1476509	18-6506
Merc 15	1288910	1349697	18-6506	Mar 40	ALL	ALL	—
Mar 15	M-684-000101	& UP	—	Merc 40	2874704	3336257	—
Merc 20	3537531	6443972	18-6506	Merc 40	3326258	& UP	—
Merc 20	1292910	3537530	18-6506	Merc 40	C159200	& UP	—
Mar 20	M-653-07615	& BELOW	—	Mark (58) 45	1139538	& UP	18-6506
Mar 20	M-653-07616	& UP	—	Merc 45	1476510	1531588	18-6506
Mar 20	M-6A9-000101	& UP	—	Merc 50	1421113	2116317	18-6506
Mark (28) 22	ALL	ALL	18-6506	Merc 50	5531630	& UP	— ②
Merc 25	1467499	1499331	18-6506	Merc 50	1770179	& UP	—
Mar 25	M-648-19025	& BELOW	& BELOW	Mark (75) 60	ALL	ALL	18-6506
Mar 25	M-695-000101	& UP	& UP	Merc 60	ALL	ALL	18-6506
Mar 28	ALL	ALL	—	Merc 65	1542745	1765043	18-6506
Merc 30	1271885	1356947	18-6506	Mark (78) 70	ALL	ALL	18-6506
Mar 30	ALL	ALL	18-6521	Merc 70	ALL	ALL	18-6506

① Above Prop Exhaust ② 4 cyl. only

 <p>18-7354 CARB KIT Replaces: 1395-8506 V-175 outboards Serial Number 4301235 thru DC100860</p>	 <p>18-7355 CARB KIT Replaces: 1395-811691 2</p>	 <p>18-7356 CARB KIT Replaces: 1395-811691 3</p>	 <p>18-7004 CARB KIT Replaces: 1395-6200</p>
 <p>18-7005 CARB KIT Replaces: 1395-6452</p>	 <p>18-7006-1 CARB KIT Replaces: 1399-1717, 1399-2015, 1399-3523, 1395-4808, 1395-8791994024, 879194024</p>	 <p>18-7007 CARB KIT Replaces: 1399-5135, 1399-5198</p>	 <p>18-7013 CARB KIT For: AJ, KA, KB, KC, KD Carburetor</p>
 <p>18-7021 CARB KIT For: WM, WMK</p>	 <p>18-7211-1 CARB KIT Replaces: 1395-8112231</p>	 <p>18-7212 CARB KIT Replaces: 1395-97611, 1395-9761, 1395-9803, 1395-9725, 1395-9645, 1395-9377, 1395-9179, 1395-811357</p>	 <p>18-7213 CARB KIT Replaces: 8107492</p>
 <p>18-7214 CARB KIT Replaces: 8107493</p>	 <p>18-7215 CARB KIT Replaces: 1395-9024</p>	 <p>18-7226 CARB KIT Replaces: 1395-9650 Fits: 30 JET, 40/45 4 CYL 4 Stroke, Carb models WMA-7B,9,10,13</p>	 <p>18-7290 CARB KIT Replaces: 84419M</p>
 <p>18-7291 CARB KIT Replaces: 84475M</p>	 <p>18-7293 CARB KIT Replaces: 92520M</p>	 <p>18-7738 CARB KIT Replaces: 802706A1 For: 9.9 4 Stroke (323cc) (1999 & up) and 15.4 Stroke (1998 & up)</p>	 <p>18-7743 CARB KIT Replaces: 804346T1 For: 75 4 Stroke (2000 & up), 90 4 Stroke (2000 & up)</p>

APPLICATION BEGINS ON NEXT PAGE

 <p>18-7750-1 CARB KIT Replaces: 1395-8236354, 1395-8236353, 1395-8236352, 1395-8236351, 1395-823635, 1395-811222, 1395-9599 Fits: WME-1, 1A, 1B, 4, 5, 6, 6A, 7, 7B, 8, 9, 10, 10A, 11, 14, 15, 15A, 17, 18, 20, 20A, 21, 21A, 22, 22B, 23, 24, 25, 27, 28, 32, 32B, 33, 34, 35, 36, 36A, 37, 37A, 38, 39A, 40, 40A, 42, 42A, 43, 44, 45, 50, 52, 53, 57, 58, 63, 64, 65, 66, 67, 68, 69, 79, 81</p>	 <p>18-7765 CARB KIT Replaces: 11502M</p>	 <p>18-7769 CARB KIT Replaces: 814481M</p>	 <p>18-7770 CARB KIT Replaces: 84456M</p>	 <p>18-7815 CARB KIT Replaces: 1399-5137</p>
 <p>18-7062 INLET VALVE Replaces: 1395-95951 Fits: WME-1, 1A, 1B, 4, 5, 6, 6A, 7, 7B, 8, 9, 10, 10A, 11, 14, 15, 15A, 17, 18, 20, 20A, 21, 21A, 22, 22B, 23, 24, 25, 27, 28, 27, 28, 32, 32A, 33, 34, 35, 36, 36A, 37, 37A, 38, 39A, 40, 40A, 42, 42A, 43, 44, 45, 50, 52, 53, 57, 58, 63, 64, 65, 66, 67, 68, 69, 79, 81</p>	 <p>18-7057 NEEDLE & SEAT Replaces: 1399-1473, 1395-9258, 1399-1138, 1399-9258 1 .078 Bore</p>	 <p>18-0715 FLOAT CHAMBER GASKET Replaces: 809086, 25-809086</p>	 <p>18-7061 NEEDLE & SEAT Replaces: 1395-8318, 1395-83181 .065 Bore</p>	 <p>18-7295 NEEDLE VALVE Replaces: 1395-9022</p>
 <p>18-7233 NEEDLE & SEAT Replaces: 1395-7824</p>	 <p>18-36850 NEEDLE & SEAT Replaces: 1395-8116901 Fits: Mercruiser 2.5 & 3.0L Carbs</p>	 <p>18-7380 FLOAT Replaces: 809569 15 (4-Stroke) All, 50 (4-Stroke)</p>	 <p>18-7381 FLOAT Replaces: 16253 4 (SN A855097 & Up), 5 (SN A855097 & Up)</p>	 <p>18-7382 FLOAT Replaces: 804184 75 (4-Stroke) All, 90 (4-Stroke) All</p>
 <p>18-7208 FLOAT Replaces: 1395-8983, 1395-8673</p>	 <p>18-72000 FLOAT Replaces: 1395-9594 Fits: WME1, 1A, 1B, 4, 5, 6, 6A, 7, 7B, 8, 9, 10, 10A, 11, 14, 15, 15A, 17, 18, 20, 20A, 21, 21A, 22, 22B, 23, 24, 26, 27, 28, 32, 32A, 33, 34, 35, 36, 36A, 37, 37A, 38, 39A, 40, 40A, 42, 42A, 43, 44, 45, 50, 52, 53, 57, 58, 63, 64, 65, 66, 67, 68, 69, 79, 81</p>	 <p>18-7249 FLOAT KIT Replaces: 19273 Fits: WM-3, 5, 6, 8, 9, 10, 11, 12, 13, 13A, 14, 15, 15A, 16, 16A, 17, 18</p>	 <p>18-7209 FLOAT Replaces: 1395-9293</p>	 <p>18-36956 FLOAT Replaces: 1395-9267 Fits: Mercury V6 w/ Dual Float Carbs</p>

MARINER CARBURETOR KIT APPLICATION

HP	Year/Serial No.	Carb Kit	HP	Year/Serial No.	Carb Kit	HP	Year/Serial No.	Carb Kit
6 C-D	Ser.No.Code 6H8 & 6H6	18-7765	25A	M-648-24991 & Up ML-648-64046 & Up E-648-27056 & Up EL-648-56526 & Up	18-7770	30A	M-689-230100 & Up ML-689-530100 & Up E-689-250100 & Up EL-689-550100 & Up	18-7770
8C	Ser.No.Code 6G1	18-7765						
9.9C	M-682-070796 & Up ML-682-368040 & Up E-682-251511 & Up EL-682-55146 & Up	18-7769	25C	Ser.No.Code 695	18-7770	48	M-670-02641 & Up ML-670-34581 & Up	18-7290
	15C	M-684-052848 & Up ML-684-332302 & Up E-684-252381 & Up EL-684-553251 & Up	18-7769	28	M-664-05306 & Up! ML-664-41686 & Up! E-664-26236 & Up! EL-664-57421 & Up	18-7770	W48 Ser.No.Code 670 55 Ser.No.Code 663 W55 Ser.No.Code 663 60 Ser.No.Code 675	18-7290 18-7290 18-7290 18-7290

MERCURY CARBURETOR KIT APPLICATION (Cont.)

HP	Year — S/N	Carburetor Model	Carburetor Kit	Gasket Kit	Needle & Seat	Float
3.9	1964-68	KB-7A, KB-7B	18-7013	18-7006-1	18-7057	18-7208
	80-81, 86-87	KB-10A	18-7013	18-7006-1	18-7057	18-7208
4 (1 cyl.)		WMD-1	—	18-7006-1	18-7061	18-7208
4.5	1980-85	KD-10A	18-7013	18-7006-1	18-7057	18-7208
4.5	1980-85	WMD-1	18-7021	18-7006-1	18-7061	18-7208
n	1961-68	KB-6A, 6B, 7B, A, J57A 39, 41, 47, 49	18-7013	18-7006-1	18-7057	18-7208
		KB-9A, KB-12A BB-7C WMB-2, 4 39, 41, 47, 49, 57	18-7013	18-7006-1 18-7007 —	18-7057 18-7295 18-7295	18-7208 18-7209 18-7209
7.5	1969-73	KB-5A, 8A, 11A	18-7013	18-7006-1	18-7057	18-7208

APPLICATION CONTINUED ON NEXT PAGE

MERCURY CARBURETOR KIT APPLICATION (Cont.)						
HP	Year - S/N	Carburetor Model	Carburetor Kit	Gasket Kit	Needle & Seat	Float
9.8		BB-6A, BB-6C	—	18-7007	18-7295	18-7209
9.9 (2 stroke)	S/N A197112-Up	WMB-1, 3	—	—	18-7295	18-7209
		WMC-5, 5A, 5B, 7, 7A, 17, 17B, 17C, 18, 18A, 18B, 19, 19A, 20, 20A, 20B	—	18-7212	—	—
9.9 (2 stroke)		WMC-23, 28, 34, 39, 41, 41A, 47, 47A, 49, 49A, 57	—	18-7212	—	—
(323cc)		—	18-7738	—	—	—
10	1957-61	AJ-52A	18-7013	18-7006-1	18-7057	18-7208
10		AJ-56AB	—	18-7006-1	18-7057	18-7208
10		KB-1A, 4A	—	18-7006-1	18-7057	18-7208
Marathon		50, 50A, 55, 55A	—	18-7212	—	—
XR-10	All	WMC-23, 48, 48A, 49, 49A	—	18-7212	—	—
MAG 10	All	WMC-23, 48, 48A, 49, 49A	—	18-7212	—	—
15	1959-61	AJ-52A, AJ-56A	18-7013	18-7006-1	18-7057	18-7208
15 (150)		KB-1A, 4A	—	18-7006-1	18-7057	18-7208
15	S/N A197112-Up	WMC-5, 5A, 5B, 7, 7A, 17, 17B, 17C, 18, 18A, 18B, 19, 19A, 20, 20A, 20B	—	18-7212	—	—
15		WMC-23, 28, 34, 39, 41, 41A, 47, 47A, 49, 49A, 57	—	18-7212	—	—
15	S/N OG590000-Up	—	18-7738	—	—	—
Marathon		50, 50A, 55, 55A	—	18-7212	—	—
		46A, 50, 53, 54, 56	—	18-7212	—	—
		50, 53, 54, 56	—	18-7212	—	—
15 (4-Stroke)	S/N OG590000-Up	—	18-7738	—	—	—
18		11, 12	—	18-7212	—	—
		WMC-13, 13A, 14, 14A, 15A, 16A, 24, 25, 26, 27, 29, 30, 31, 31A	—	18-7212	—	—
20		11, 12	—	18-7212	—	—
		WMC-13, 13A, 14, 14A, 15A, 16A, 24, 25, 26, 27, 29, 30, 31, 31A	—	18-7212	—	—
20 (200)	1963-72	KA-20A, 22A, 22B, 22C, 23A, 25A	18-7013	18-7006-1	18-7057	18-7208
		BA-20, BA-2E	—	18-7007	—	18-7209
		46A, 50, 53, 54, 56	—	18-7212	—	—
22	1958-59	KA-KC	18-7013	18-7006-1	18-7057	18-7208
		11, 12	—	18-7212	—	—
25 (2 cyl)		WMC-13, 13A, 14, 14A, 15A, 16A, 24, 25, 26, 27, 29, 30, 31, 31A, 32, 32A, 35, 35A, 35B, 36, 37, 44, 45, 46, 46A, 50, 53, 54, 56	—	18-7212	—	—
		63, 64, 65, 66, 67	18-7750-1	18-7211-1	—	18-72000
30 (300) 4-cyl.		AJ-54A	—	—	18-7057	18-7208
30 (300) 4-cyl.		KB-2A	—	17-7006-1	18-7057	18-7208
30 JET (3 cyl)		WME-53, 68, 69	18-7750-1	18-7211-1	—	18-72000
30 JET (4 cyl)		WMA-10, 13	18-7226	—	—	—
		9C, 13A	18-7013	18-7006-1	18-7061	18-7208
35	1963-69	KB-2A	18-7013	18-7006-1	18-7057	18-7208
35	1984-89	WMK-38	18-7021	18-7006-1	18-7061	18-7208
35		AJ-54A	—	—	18-7057	18-7208
		KA-2A, KA-9A	18-7013	18-7006-1	18-7057	18-7208
40	1954-59	AJ	18-7013	18-7006-1	18-7057	18-7208
40	1970-74	WMK-1, WMK-8	18-7021	18-7006-1	18-7061	18-7208
		WMK-31	18-7021	18-7006-1	18-7061	18-7208
		64, 65, 66, 67	18-7750-1	18-7211-1	—	18-72000
40 (3 cyl)		WME-53, 68, 69	18-7750-1	18-7211-1	—	18-72000
40 (4 cyl)		WMA-4	—	18-7215	18-7295	18-7209
40 (4 cyl)		WMA-7B	18-7226	—	—	18-7209
40 (4 cyl)		WMA-9, 10, 13	18-7226	—	—	—
45	1958-62	KA-2A	18-7013	18-7006-1	18-7057	18-7208
45	1958-62	AJ-54A	18-7013	18-7006-1	18-7057	18-7208
45 (4 cyl)	1986	Tillotson/Walbro	—	18-7007	—	18-7209
45 (4 cyl)	1987-Up	WMA-4	—	18-7215	18-7295	18-7209
45 (4 cyl)		KA-17A	18-7013	—	18-7057	18-7208
45 (4 cyl)		WMA-7B	18-7226	—	—	18-7208
45 (4 cyl)		WMA-9, 10, 13	18-7226	—	—	—
45 JET (3 cyl)		WME-57, 58	18-7750-1	18-7211-1	—	18-72000
		24A, 26A, 26B, 27A	18-7013	18-7006-1	18-7057	18-7208
50	1976-85	BA-3B, BA-3C, BA-3D	—	18-7007	—	18-7209
50 (3 cyl)	1986-90	WM-13, 13A, 15, 15A, 16, 16A, 18	—	18-7004	—	18-7249
50 (3 cyl)		WME-22, 22B, 23, 24, 26, 27, 28, 35, 43, 44, 45, 53, 68, 69	18-7750-1	18-7211-1	—	18-72000
50 (4cyl)	1986-Up	WMA-1, 3	—	18-7215	18-7295	18-7209
50 (4cyl)		BA-3A, 3B, 3C, 3D, 4A	—	18-7007	18-7295	18-7209
50 (4cyl)		WMK-8	18-7021	18-7006-1	18-7061	18-7208
55 (3 cyl)		WM-13, 13A, 15, 15A, 16, 16A, 18	18-7249	18-7004	—	—
55		WME-22, 22B, 23, 24, 26, 27, 28, 35, 43, 44, 45, 57, 58	18-7750-1	18-7211-1	—	18-72000
60 (3 cyl)	S/N D000750-Up	WME-22, 22B, 23, 24, 26, 27, 28, 35, 43, 44, 45, 57, 58	18-7750-1	18-7211-1	—	18-72000
60 (3 cyl)	1984-90	WM-13, 13A, 15, 15A, 16, 16A, 18	—	18-7004	—	18-7249
60	1957-60	AJ-53A, AJ-55A, KB	18-7013	18-7006-1	18-7057	18-7208
60 600 (6 cyl)		KB-3A	—	18-7006-1	18-7057	18-7208
65 650 (4 cyl)	1963-71	KC-2A, 5A, 5B, 5C, 11A, 15A	18-7013	18-7006-1	18-7057	18-7208
65 650 (3 cyl)	1972-75	WMK-5, WMK-12	—	—	—	—
		WMK-13, WMK-20	18-7021	18-7006-1	18-7061	18-7208
65	1976	WM-2, WM-4	—	18-7004	18-7061	18-7208
Jet 65 (3 cyl)	S/N A996142-Up	WME-1, 1A, 1B, 4.5, 6.6A, 7, 7B, 8, 9, 10, 10A, 15, 15A, 17, 18, 19, 25, 29, 30, 31, 41, 46, 47, 48, 49, 59, 60, 61, 62, 75, 76, 77	18-7750-1	18-7211-1	—	18-72000
70	1958-62	KC, KA-2A	18-7013	18-7006-1	18-7057	18-7208

APPLICATION CONTINUED ON NEXT PAGE

MERCURY CARBURETOR KIT APPLICATION (Cont.)

HP	Year — S/N	Carburetor Model	Carburetor Kit	Gasket Kit	Needle & Seat	Float
70 (4 cyl.)		KA-8A, 12A	18-7013	18-7008-1	18-7057	18-7208
70	1977-83	WM-6, 8, 9, 11, 60,61,62	— 18-7750-1	18-7004 18-7211-1	18-7061 —	18-7249 18-72000
75 (4 cyl.)	1984-86	WM-14, 17 60,61,62	— 18-7750-1	18-7004 18-7211-1	— —	18-7249 18-72000
75 (4 Stroke)	S/N OG960500-Up	—	18-7743	—	—	—
.80 (4 cyl.)	1960-61	60,61,62	—	18-7211-1	—	18-72000
.80 (4 cyl.)	1969-72	KD-4A	18-7013	18-7006-1	18-7061	18-7208
.80 (4 cyl.)	1978-83	WMK-2	18-7021	18-7006-1	18-7061	18-7208
.80 (4 cyl.)		WM-5, 10, 12, 14, 17	—	18-7004	18-7061	18-7249
.80 800 (6 cyl.)		KA-10A, 11A, 14A, 16A, KC-3A	—	18-7006-1	18-7057	18-7208
		34, 40, 40A, 50, 51, 52, 79	18-7750-1	18-7211-1	—	18-72000
.85	1973-75	WMK-4, WMK-16, WMK-17	18-7021	18-7006-1	18-7061	18-7208
.85 850 (6 cyl.)	1963-65	KA, KC	18-7013	18-7006-1	18-7057	18-7208
.85	1976-77	WM-3, WM-5	—	18-7004	18-7061	18-7249
		48, 49, 59, 60, 61, 62	18-7750-1	18-7211-1	—	18-72000
90 (4 Stroke)	S/N OG960500-Up	—	18-7743	—	—	—
90 (6 cyl.)	1965	KC-6A	18-7013	18-7006-1	18-7057	18-7208
		WMK-39	18-7021	18-7006-1	18-7061	18-7208
95	1966-67	KC-6A	18-7013	18-7006-1	18-7057	18-7208
		40, 40A, 50, 51, 52, 79	18-7750-1	18-7211-1	—	18-72000
100 (6 cyl.)	1962-69	KC-1A, 7A, 10A, 14A	18-7013	18-7006-1	18-7057	18-7208
100 (6 cyl.)		KD-1A, 1B, 2A, 3A	18-7013	18-7006-1	18-7061	18-7208
V-105 Jet	1994-95 S/N OD082000-OG303045	WMH-13, 13B, 23, 31	18-7355	18-7213	—	—
V-105 Jet	1996 & Up S/N OG303046 & Up	WMV-2, 2A	18-7356	18-7214	—	—
110		KC-1A, 7A, 7B, 10A, 14A	18-7013	18-7006-1	18-7057	18-7208
		40, 40A, 50, 51, 52	18-7750-1	18-7211-1	—	18-72000
115 (6 cyl.)	1970-77	KD-6A, KD-6B	18-7013	18-7006-1	18-7061	18-7208
115 (6 cyl.)	1970-88	WMK-3, 10, 15, 18, 26, 28, 32, 36, 40, 41, 41-1A, 41-1B, 41-3A, 41-3B	18-7021	18-7006-1	18-7061	18-7208
125	1968-69	KD-1A, 1B, 2A, 3A	18-7013	18-7006-1	18-7057	18-7208
		34, 40, 40A, 50, 51, 52, 81	18-7750-1	18-7211-1	—	18-72000
135	1970-71	KD-7A, KD-7B	18-7013	18-7006-1	18-7057	18-7208
135	1970-71	WMK-4	18-7021	18-7006-1	18-7061	18-7208
V-135	1986-88 S/N OA904646-OC100860	WH-33, 40	18-7354	18-7005	18-7233	—
V-135	1986-88 S/N OA904646-OC100860	WH-32, 35, 38	18-7354	18-7005	—	—
V-135	1989-90 S/N OC100861-OC239552	WH-35, 38	—	18-7005	18-7233	—
V-135	1989-90 S/N OC100861-OC239552	WH-40, 48	18-7354	18-7005	18-7233	—
V-135	1991 S/N OC239553-OD081999	WMH-8, 8A	18-7355	18-7213	—	—
V-135	1992-95 S/N OD082000-OG303045	WMH-12A, 12B, 28, 30	18-7355	18-7213	—	—
V-135	1996-98 S/N OG303046-OG760299	WMV-1, 1A	18-7356	18-7214	—	—
V-135	1999 & Up S/N OG760300 & Up	WMV-1A, 15, 15A	18-7356	18-7214	—	—
140	1972	WMK-7, WMK-9	18-7021	18-7006-1	18-7061	18-7208
140	1978-80	WMK-25, WMK-28	18-7021	18-7006-1	18-7061	18-7208
V-140 Jet	1994-95 S/N OG082000-OG303045	WMH-16, 21, 34, 39	18-7355	18-7213	—	—
V-140 Jet	1996-98 S/N OG303046-OG760299	WMV-5, 5A	18-7356	18-7214	—	—
V-140 Jet	1999 & Up S/N OG760300 & Up	WMV-5A	18-7356	18-7214	—	—
150	1973-77	WMK-11	18-7021	18-7006-1	18-7061	18-7208
150	1973-78	WMK-14, WMK-19, WMK-22	— 18-7021	— 18-7006-1	— 18-7061	— 18-7208
3.4L	1984-86	WO-3 29, 35, 38, 40, 48	— —	— 18-7005	— 18-7233	— —
V-150	1979-85 S/N OA904645 & Below	WH-9	—	18-7005	—	—
V-150	1979-85 S/N OA904645 & Below	WH-12	—	18-7005	18-7233	—
V-150	1979-85 S/N OA904645 & Below	WH-29	18-7354	18-7005	18-7233	—
V-150	1986-90 S/N OA904646-OC239552	WH-35, 38	—	18-7005	18-7233	—
V-150	1986-90 S/N OA904646-OC239552	WH-40, 48	18-7354	18-7005	18-7233	—
V-150	1990-91 S/N OC239553-OD081999	WMH-1, 7	18-7355	18-7213	—	—
V-150	1992-95 S/N OD082000-OG303045	WMH-13, 13B, 23, 31	18-7355	18-7213	—	—
V-150	1996-98 S/N OG303046-OG760299	WMV-2, 2A	18-7356	18-7214	—	—
V-150	1999 & Up S/N OG760300 & Up	WMV-3A, 16, 16A	18-7356	18-7214	—	—
V-150 (XR4, MAGII)	1988 S/N OB242885-OC100860	WH-41A	18-7354	18-7005	18-7233	—
V-150 (XR4, MAGII)	1989 S/N OC100861-OC239552	WH-41	18-7354	18-7005	18-7233	—
V-150 (XR4, MAGII)	1989 S/N OC100861-OC239552	WH-41A	18-7354	18-7005	18-7233	—
V-150 (XR4, MAGII)	1990-91 S/N OC239553-OD081999	WMH-6	18-7355	18-7213	—	—
V-150 (XR6, MAGIII)	1996-98 S/N OG303046-OG760299	WMV-3, 3A	18-7356	18-7214	—	—
V-150 (XR6, MAGIII)	1999 & Up S/N OG760300 & Up	WMV-3A, 16, 16A	18-7356	18-7214	—	—
V-150 (XR6, MAGIII)	1992-95 S/N OD082000-OG303045	WMH-14A, 25, 92A	18-7355	18-7213	—	—
V-175	1976-88 S/N 4301235-OC100860	WH-1, 4, 7, 7A, 13, 17, 28, 39, 46	—	18-7005	18-7233	—
V-175	1976-88 S/N 4301235-OC100860	WH-17R, 30, 34	18-7354	18-7005	18-7233	—
V-175	1990 S/N OC100861-OC239552	WH-34	18-7354	18-7005	18-7233	—
V-175	1991 S/N OC239553-OD081999	WMH-2, 11	18-7355	18-7213	—	—
V-175	1992-95 S/N OD082000-OG303045	WMH-15, 22, 33	18-7355	18-7213	—	—
V-175	1996-98 S/N OG303046-OG760299	WMV-4, 4A	18-7356	18-7214	—	—
V-175	1999 & Up S/N OG760300 & Up	WMV-4A 22, 26, 28, 31, 39, 46	18-7356 —	18-7214 18-7005	— 18-7233	— —
V-200	1991 S/N OC291520-OD081999	WMH-3	18-7355	18-7213	—	—
V-200	1992-95 S/N OD082000-OG303045	WMH-16, 21, 34, 39	18-7355	18-7213	—	—
V-200	1996-98 S/N OG303046-OG760299	WMV-5, 5A	18-7356	18-7214	—	—
V-200	1999 & Up S/N OG760300 & Up	WMV-5A	18-7356	18-7214	—	—
V200	1990-92 S/N 4839034-OC100860	WH-3A, 11	—	18-7005	—	—
V-225 (2.4L)	1981 & Up, 5628028 & Up	WH-5, 20	—	18-7005	18-7233	—
	thru G303045	WMH-19, 45, 46, 47	18-7355	18-7213	—	—
V225	1980-81	WH-15	—	18-7005	18-7233	—
V-225 (3.0L)	S/N OD280813-OG303045	WMH-19, 46, 47	18-7355	18-7213	—	—
V-225 (3.0L)	S/N OG303046-OG760299	WMV-7, 13	18-7356	18-7214	—	—
V-225 (3.0L)	S/N OG303046 & Up	WMV-13, 13A	18-7356	18-7214	—	—
V-225 (3.0L)	S/N OG245605-OG303045	WMH-45	18-7355	18-7213	—	—
Seapro/Marathon V-225 (3.0L)	S/N OG303046-OG760299	WMH-6, 11A	18-7356	18-7214	—	—
Seapro/Marathon V-225 (3.0L)	S/N ALL & Up	WMV-11, 11A, 13, 13A, 19	18-7356	18-7214	—	—
Seapro/Marathon V250	1989-90	WD-BA-1, 2, 3, 4, 5, 6	—	—	18-7061	—

APPLICATION CONTINUED ON NEXT PAGE

MERCURY CARBURETOR KIT APPLICATION (Cont.)

HP	Year — S/N	Carburetor Model	Carburetor Kit	Gasket Kit	Needle & Seat	Float
V275	1989-91	WD-9/9A-1,2,3,4,5,6	—	—	18-7061	—
V300	1980 & Up S/N 5611648 & Up	WD-3, 5 26,30,31,32,33,34	18-7213	—	18-7061	—
XR4	1988-90	WH-41,WH-41A 26,30,31,32,33,34	18-7213	18-7005	—	—

① Except EFI, XRI

























SONAR PRO

SIERRA ONLINE APPLICATION RESOURCE

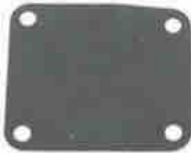
Finding the right Sierra part has never been easier.

- Up-To-Date Product Info
- Search by Sierra or OEM part number or Engine Model No.
- Includes Images & Exploded Views



 <p>18-8957 CHECK VALVE Replaces: 22-8189941, 22-818994</p>	<p>PKG. OF 2</p>  <p>18-8956 COUPLER Couples 3/8" to 5/16" Hose Replaces: 22-8M0001721</p>	 <p>18-8958 FITTING Replaces: 22-424254</p>	 <p>18-8866 FUEL PUMP Replaces: 899106T01, 892874T01 Fits: Mercury 4 stroke outboard</p>
 <p>18-7804 FUEL PUMP KIT Replaces: 23014A1</p>	 <p>18-7806-1 FUEL PUMP KIT</p>	 <p>18-7807 FUEL PUMP KIT Replaces: 55278A1</p>	 <p>18-7808 FUEL PUMP KIT Replaces: 55278A5</p>
 <p>18-7809 FUEL PUMP KIT Replaces: 55278A4, 55278A3</p>	 <p>18-7810 FUEL PUMP KIT Replaces: 90363A1</p>	 <p>18-7811 FUEL PUMP KIT Replaces: 89031A1, 66599A1</p>	 <p>18-7812 FUEL PUMP KIT Replaces: 89031A2, 66599A2</p>
 <p>18-7813 FUEL PUMP KIT Replaces: 89031A3, 66599A3</p>	 <p>18-7814 FUEL PUMP KIT Replaces: 89031A4</p>	 <p>18-7817 FUEL PUMP KIT Replaces: 21-42990A7, A8, A9, A10, 21-857005A1</p>	 <p>18-7818-1 FUEL PUMP KIT Replaces: 42909A1, 42909A2, 42909A3, 42909A4</p>
 <p>18-7833 FUEL PUMP DIAPHRAGM Replaces: 11497M</p>	 <p>18-7834 FUEL PUMP DIAPHRAGM Replaces: 91748M</p>	 <p>18-7837 FUEL PUMP DIAPHRAGM Replaces: 84262M</p>	 <p>18-7838 FUEL PUMP DIAPHRAGM Replaces: 84265M</p>
 <p>18-7839 FUEL PUMP DIAPHRAGM Replaces: 80606M</p>	 <p>18-7840 FUEL PUMP DIAPHRAGM Replaces: 84141M</p>	 <p>18-7847 FUEL PUMP DIAPHRAGM</p>	

DIAPHRAGM APPLICATION ON NEXT PAGE

MERCURY FUEL PUMP KITS

HP	Beginning	Ending	Fuel Pump Kit	HP	Beginning	Ending	Fuel Pump Kit
7.5	3488153	& UP	18-7815 ②	115 (4 CYL)	B209468	& UP	18-7817 ②
8	A197112	& UP	18-7212	115 (115, 1150) SQUARE F/P	6436123	& UP	18-7817
9.8	3482753	& UP	18-7815 ②	115 (4 CYL)	D283222	& UP	18-7817
9.9	A197112	& UP	18-7212	115 (6 CYL) DFI	G960500	T178999	18-7817
10	1057994	1455239	18-7804	115 (3 CYL) DFI	T801000	& UP	18-7817
15	1200114	1349667	18-7804	115 PRO XS	B751825	& UP	18-7817
15	B392414	& UP	18-7212	120	ALL		18-7806-1
20	1866496	2296266	18-7804	120XR	ALL		18-7806-1
20	3537531	A010970	18-7815 ②	125 (1250) 6 CYL	2314956	2839386	18-7804
20	6443973	T800749	18-7212	125 (4 CYL)	D283222	& UP	18-7817
20 JET	G044027	& UP	18-7212	125 (1250BP) 6 CYL	2400059	2641954	18-7817
22	1158546	1499331	18-7804	125 (3 CYL) DFI	B736986	& UP	18-7817
25	1467489	1499331	18-7804	135	2939369	3293233	18-7807
25	6443973	& UP	18-7212	V-135	C100860	& Below	18-7812 ①
30	950250	1448139	18-7804	V-135	A904646	& UP	18-7817 ②
30 JET	C158200	T408999	18-7817	V-135 TRIANGULAR F/P	A904646	C100860	18-7813
35	6445652	& BELOW	18-7804	V-135 SQUARE F/P	A904646	D081999	18-7817
35	6445653	B110788	18-7809	V-135	D082000	T178499	18-7817
35	B110789	& UP	18-7817	V-135 DFI (DESIGN II)	G590000	G780299	18-7817
40 (2 cyl.)	831021	1478509	18-7804	V135 DFI	G760300	& UP	18-7817
40 (2 CYL)	2874704	5556229	18-7807	140	3293234	3502805	18-7807
40 (2 CYL)	C158200	& UP	18-7817	140	4856578	5327662	18-7811
40 (2 CYL)	G053314	& UP	18-7817	140 JET	ALL		18-7817
40 (3 CYL)	G590000	T999999	18-7817	150	3502806	4866677	18-7807
40 FOUR STROKE JET 2 CYCLE	G780300	& UP	18-7817	150 EFI	G303046	& UP	18-7817
45	1139534	1531958	18-7804	V-150	C100860	& Below	18-7812 ①
45 (4 cyl.)	B110789	& UP	18-7817	V-150	A904646	C100860	18-7817 ②
45/50 (4 cyl.)	3478003	B110788	18-7815 ②	V-150 XP2	ALL		18-7812
45 JET	6428681	& UP	18-7817	V-150 (150HP)	4868998	A904646	18-7812
45 JET	D000750	T129554	18-7817	V-150 SQUARE F/P	A904646	C100860	18-7817
50 (4 cyl.)	2116318	4357639	18-7804	V-150	C100861	D081999	18-7817
50 (3 cyl.)	6428681	B122929	18-7809	V-150 CARB & EFI	D082000	B226939	18-7817
50 (3 cyl.)	B122930	T999999	18-7817	V-150 DFI (DESIGN II)	G590000	G780299	18-7817
50/55 (3 cyl.)	D000750	& UP	18-7817	V-150 DFI (DESIGN III)	G690000	G780299	18-7817
60	1072997	1542744	18-7804	V-150 DFI	G780300	& UP	18-7817
60	6428681	B122929	18-7809	V-175	C100860	& Below	18-7812 ①
60 (3 cyl.)	B122930	& UP	18-7817	175 EFI	G303046	G589999	18-7817
60 (3 cyl.)	D000750	& UP	18-7817	V-175	6618751	& UP	18-7817 ②
65	1542745	2803561	18-7804	V-175 TRIANGULAR F/P	4301235	C100860	18-7812
65	ALL 3 CYL		18-7807	V-175 SQUARE F/P	4301235	& UP	18-7817
65 JET	D283222	& UP	18-7817	V-175	C100861	D303045	18-7817
65 (650) 4 CYL	2119749	2803561	18-7804	V-175	D303046	G960499	18-7817
70	1149038	1566239	18-7804	V-175 EFI	D000750	D081999	18-7817
70 (3 cyl)	4571652	6428680	18-7809	V-175 EFI	D082000	T408999	18-7817
70 (3 cyl)	A996142	C221999	18-7818-1	V-175 EFI	T409000	T800899	18-7817
75 (4 CYL) SQUARE F/P	6432901	& UP	18-7817	V-175 DFI	T178500	& UP	18-7817
75 (3 CYL) 90 DEGREE OIL CHECK VALVE	C222000	D283221	18-7818-1	V-175 PRO XS	B516339	& UP	18-7817
75 (3 CYL) INLINE OIL CHECK VALVE	C222000	D283221	18-7817	200 EFI	G303046	G589999	18-7817
75 (3 CYL)	D283222	& UP	18-7817	V-200	6073192	6367229	18-7810
75 (3 CYL) DFI	T980000	& UP	18-7817	V-200	6367230	6625220	18-7814 ②
75 (4 cyl.)	6432901	& UP	18-7808 ①	V-200	4839034	6073191	18-7812
75 (4 cyl.)	6432901	& UP	18-7817 ②	V-200	6625221	& UP	18-7817 ②
75 (3 cyl.)	A996142	D283221	18-7818-1	V-200	6625221	C291519	18-7817
80	1335465	2670574	18-7804 ②	V-200	C291520	B226939	18-7817
80	2783253	2856331	18-7807 ②	V-200 EFI	C100861	D081999	18-7817
80	2559001	2670574	18-7808 ②	V-200	D082000	T408999	18-7817
80	4831999	6432900	18-7808	V-200 (2.5L) EFI	T409000	& UP	18-7817
80 (3 CYL)	A996142	C221999	18-7818-1	V-200 (3.0L) EFI	T750184	& UP	18-7817
80 JET (3 CYL)	D0283222	& UP	18-7817	V-200 DFI	G590000	T589999	18-7817
80 JET (4 CYL)	B586087	& UP	18-7817	V-200 DFI	T590000	T5800999	18-7817
85	1409999	1766823	18-7804	V-200 DFI	T801000	& UP	18-7817
85	3493913	4831996	18-7808	V-200 PRO XS	B504989	& UP	18-7817
90 (6 cyl.)	1766824	4845300	18-7804	V-220 LASER	B117316	& UP	18-7817
90 (6 CYL)	5299506	6436122	18-7811 ②	V-225	6628028	& UP	18-7810
90 (6 CYL)	6436123	& UP	18-7817 ②	V-225 SEA PRO/MARATHON (3.0L)	D208813	& UP	18-7810
90 (3 CYL)	A996142	D283221	18-7818-1	V-225 (3.0L) EFI	G129222	& UP	18-7817
90 (3 CYL) INLINE OIL CHECK VALVE	C222000	D283221	18-7817	V-225 (3.0L) DFI	G590000	T589999	18-7817
90 (3 CYL) 90 DEGREE OIL CHECK VALVE	C222000	D283221	18-7818-1	V-225 DFI	T590000	T800999	18-7817
90 (3 CYL)	D283222	& UP	18-7817	V-225 DFI	T801000	& UP	18-7817
90 (3 CYL) DFI	T801000	& UP	18-7817	V-225 DTS	T590000	B417701	18-7817
95 (950) 6 CYL	1869776	2318585	18-7804	V-225 DTS	B417702	& UP	18-7817
95XR	ALL		18-7806-1	V-225 PRO XS	B104549	& UP	18-7817
100	2318586	3253111	18-7804	V-250 (3.4L)	C101891	& UP	18-7817
100 (4 CYL) 90 DEGREE OIL CHECK VALVE	B209468	D283221	18-7818-1 ②	V-250 (3.0L) EFI	G129222	& UP	18-7817
100 (4 CYL) INLINE OIL CHECK VALVE	B209468	D283221	18-7817 ②	V-250XB	G960500	T800999	18-7817
100 (4 CYL)	D283222	G055520	18-7817	V-250 DFI	B528615	& UP	18-7817
105 JET	ALL		18-7817	V-250 PRO XS	B426681	& UP	18-7817
110	1870204	2314955	18-7804	V-275 (3.4L)	C101891	& UP	18-7817
115	3781034	& BELOW	18-7807	V-300 (3.4L)	5611548	& UP	18-7812
115 (6 CYL)	5314856	6436122	18-7813 ②	XR4XP6	C100860	& Below	18-7817
115 (6 CYL) TRIANGULAR F/P	6436123	& UP	18-7817 ②	Magnum II	ALL		18-7817
115 (4 CYL)	B209468	& UP	18-7818-1 ②				

① Except models with square fuel pump
 ② Models equipped with Tillotson BA, BB, BD carburetors
 ③ Dual fuel pump applications

④ Single fuel pump applications
 ⑤ Models with square fuel pumps

⑥ Use with white fuel pump body
 ⑦ Use with black fuel pump body

MARINER DIAPHRAGMS (Japanese Models)

Model	S/N Code	S/N	Diaphragms	Model	S/N Code	S/N	Diaphragms
5C	6E3	ALL	18-7834	28	644	M-664-151346 & UP	②
6C	6H8	ALL	18-7833	30	689	ALL	②
6D	6H6	ALL	18-7833	40 TC	6E9	ALL	②
8B	677	ML-677-316416 & UP	18-7837	40A APE	676	M-676-A00346 — 001990	18-7839
8B	677	M-677-012921 & UP	18-7837	40A APE	676	M-676-A001991 & UP	②
8C	6G1	ALL	18-7833	40A APE	676	ML-676-A41358 — 302250	18-7839
9.9C	682	ALL	①	40A APE	676	ML-676-A302251 & UP	②
15A	651	ALL	18-7839	40A APE	676	E-676-A10121 — 100355	18-7839
15C	664	ALL	①	40A APE	676	E-676-A100356 & UP	②
20A APE	653	ALL	18-7839	40A APE	676	EL-676-A50631 — 400940	18-7839
20C TPE	6A9	ALL	②	40A APE	676	EL-676-A400941 & UP	②
25A	648	EL-648-550230 & BELOW	18-7839	40B TPE	676	ALL	②
25A	648	EL-648-550231 & UP	②	40C TC	6E9	ALL	②
25A	648	E-648-26825 & BELOW	18-7839	48	670	ML-670-302510 & BELOW	18-7839
25A	648	E-648-26826 & UP	②	48	670	ML-670-302511 — 311995	②
25A	648	ML-648-304174 & BELOW	18-7839	48	670	M-670-02640 & BELOW	18-7839
25A	648	ML-648-304174 & UP	②	48	670	M-670-02641 — 002180	②
25A	648	M-648-19025 & BELOW	18-7839	W48	670	ML-670-311996 & UP	18-7839
25A	648	M-648-19026 & UP	②	W48	670	M-670-002161 & UP	18-7839
25C TPE	695	EL-695-550101 — 555959	②	55	663	EL-663-315379 — 317710	18-7839
25C TPE	695	EL-695-555960 & UP	18-7839	55	663	EL-663-317711 & UP	②
25C TPE	695	E-695-250101 — 253861	②	55	663	E-663-004041 — 004317	18-7839
25C TPE	695	E-695-253862 & UP	18-7839	55	663	E-663-004318 & UP	②
25C TPE	695	ML-695-300101 — 318173	②	55	663	ML-663-36475 & BELOW	18-7839
25C TPE	695	ML-695-318174 & UP	18-7839	55	663	ML-663-02730 & BELOW	18-7839
25C TPE	695	M-695-000101 — 023895	②	W55	663	ML-663-578278 — 583880	18-7839
25C TPE	695	M-695-023896 & UP	18-7839	W55	663	ML-663-583881 & UP	②
28	644	EL-664-570795 & BELOW	18-7839	60 2 CYL	6F0	ALL	18-7839
28	644	EL-664-570796 & UP	②	60 2 CYL	675	EL-675-30101 — 300280	18-7839
28	644	E-664-270310 & BELOW	18-7839	60 2 CYL	675	EL-675-300281 — 304180	②
28	644	E-664-270311 & UP	②	60 2 CYL	675	EL-675-304180 & UP	18-7839
28	644	ML-664-451125 & BELOW	18-7839	60 2 CYL	675	E-675-00101 — 000180	18-7839
28	644	ML-664-451126 & UP	②	60 2 CYL	675	E-675-00181 — 001170	②
28	644	M-664-151345 & BELOW	18-7839	60 2 CYL	675	E-675-001171 & UP	18-7839

① Requires the use of both 18-7837 and 18-7838

② Requires the use of both 18-7839 and 18-7840

8' LENGTH COMPLETE FUEL LINE ASSEMBLIES

3/8" FUEL LINE ASSEMBLY

18-8010EP-2 *SILVERADO 4000 Premium*



FUEL LINE ASSEMBLY COMPONENTS

8' LENGTH COMPLETE FUEL LINE ASSEMBLIES

3/8" FUEL LINE ASSEMBLY

18-8012EP-2 *SILVERADO 4000 Premium*

OE# 32-858114Q08,
32-858114K08



FUEL LINE ASSEMBLY COMPONENTS

Has 1/4" NPT threaded fitting on engine end and 1/4" NPT threaded fitting on the tank end. Primer bulb is included in this 8ft. (2.44 m) assembly. Fits various applications using the older style twist type disconnects at the engine end and either a bayonet or thread-in fitting on the tank end.

8' LENGTH COMPLETE FUEL LINE ASSEMBLIES

3/8" FUEL LINE ASSEMBLY

18-8024EP-2 *SILVERADO 4000 Premium*

OE# 32-858104Q08,
32-858104K08



FUEL LINE ASSEMBLY COMPONENTS

Has standard quick connect type fitting on engine end and 1/4" NPT threaded fitting on the tank end. Primer bulb is included in this 8 ft. (2.44 m) assembly. Fits Force 40 HP and larger (1993 & Newer), Force 9.9/15/25HP (1998), and all Mercury/Mariner outboards using clip on type disconnect at engine ends and a tank with threaded fuel pickup fitting.

* Tanks and Engines for picture purpose only.

8' LENGTH COMPLETE FUEL LINE ASSEMBLIES

3/8" FUEL LINE ASSEMBLY

18-8025EP-2 *SILVERADO 4000 Premium*

OE# 32-858105Q08, 32-858105K08



*

*

FUEL LINE ASSEMBLY COMPONENTS

Has standard quick connect type fitting on engine end and bayonet style fitting on the tank end. Primer bulb is included in this 8 ft. (2.44 m) assembly. Fits Force 40 HP and larger (1993 & Newer), Force 9.9/15/25HP (1998), and all Mercury/Mariner outboards using clip-on type disconnect at the engine end and an older style tank with bayonet type connection.

8' LENGTH COMPLETE FUEL LINE ASSEMBLIES

3/8" FUEL LINE ASSEMBLY

18-8016EP-2 *SILVERADO 4000 Premium*

OE# 32-858109Q12, 32-858109K12



18-80402 TANK CONNECTOR (SOLD SEPARATELY)



18-8091 FUEL CONNECTOR



18-8005EP-1 PRIMER BULB



18-8076 FUEL CONNECTOR



*

*

FUEL LINE ASSEMBLY COMPONENTS

Has double sealed quick connect type fitting on tank end and clip-on type quick connect on engine end. Primer bulb is included in this 8ft. (2.44m) assembly. Fits Force 40 HP and larger (1993 & Newer), Force 9.9/15/25HP (1998) and all Mercury Mariner outboards using clip-on type disconnects at both tank and engine ends

* Tanks and Engines for picture purpose only.

PRIMER BULBS



18-8002EP-1
18-8002EP-1-10①
PRIMER BULB
1/4"

18-8005EP-1
18-8005EP-1-10①
PRIMER BULB
3/8"

Replaces: 13330A3, 13330Q, 13330Q5
Large capacity bulb

18-8004EP-1
18-8004EP-1-10①
PRIMER BULB
5/16"

Replaces: 89396A38, 89396Q38
Large capacity bulb

HOSE BARB APPLICATION



PART #	MERCURY OE #	BARB	NPT	CONN. TYPE
18-8054	22-63186	5/16"	1/8"	Male
18-8055	22-63187	5/16"	1/4"	Male
18-8073	-	3/8"	1/8"	Male
18-8074	-	3/8"	1/4"	Male



18-7599 FUEL LOCK

Protect your outboard from theft, disconnect fuel line and simply install fuel lock. Designed to fit clip on style fuel connectors. Fits: Johnson Evinrude, Mercury/Mariner, Yamaha and Honda.

① Discount shop pack of 10 - Priced per package



18-7083
PRIMER BULB
 Replaces: 858763, 8168773, 8168772, 8168771, 816877, 684311
 Fits: 30 2cyl(AII), 30 JET 3cyl(AII), 40 2cyl(AII), 40 3cyl(AII), 40 JET(AII), 50 3cyl(G590000 & Up), 55 3cyl(G590000 & Up), 60 3cyl(G590000 & Up), 60 3cyl Bigfoot(AII), 65 JET (AII), 75 3cyl(D283222 & Up), 90 3cyl(D283222 & Up)



18-80410-1
FUEL CONNECTOR
 Replaces: 22-13563T3
Female Hose connector
 3/8"
 Fits: 4/5 2-Stroke (1999 & Up)
 Mates with **18-80412**



18-80412
FUEL CONNECTOR
 Replaces: 22-816856T2
Male Hose connector
 1/2"
 Fits: 100 4-cyl. (1988-99), 115 4-cyl. (1989 & up), 125 4-cyl. (1994 & up), 65 Jet (1994 & up), 75 3-cyl. (1987 & up), 80 Jet (1984 & up), 90 3-cyl. (1987 & up)
 Mates with **18-80410-1**



18-8068
TANK CONNECTOR
 (1/4" NPT)
 (Female)



18-8069
FUEL CONNECTOR
 5/16"
 Replaces: 22831Q3, 22831A3, 22831A4, 22831B3, 22831A1
 (Female)



18-8070
FUEL CONNECTOR
 1/2"
 Replaces: 30185A3, 30185Q3, 30185B3, 30185A1, 29196, 16610M
 (Male)



18-8075
FUEL CONNECTOR
 (1/4")
 Replaces: 22-14213M, 2214213Q, 22-81042M
 Mates with **18-8077-1**



18-8076
18-8076-10^①
FUEL CONNECTOR
 (3/8")
 Replaces: 22-13563A3, 22-13563Q3
 Mates with **18-8077-1**



18-8077-1
18-8077-1-10^①
TANK CONNECTOR
 (1/4" NPT)
 Mates with **18-8075, 18-8076, 18-8085**



18-8082
TANK CONNECTOR
 Mercury Straight Fitting
 (1/4" NPT)
 (Female)



18-8083
FUEL CONNECTOR
 1/2"
 (Female)



18-8084
FUEL CONNECTOR
 1/2"
 Replaces: 30185A3, 30185Q3, 30185B3, 30185A1, 29196, 22-16610M
 (Male)



18-8085
18-8085-10^①
FUEL CONNECTOR
 (5/16")
 Mates with **18-8077-1**



18-8091
FUEL CONNECTOR
 (3/8")
 Replaces: 22-13563Q7, 22-13563T7, 22-13563A7, 22-13563A6
 Mates with **18-80402**



18-80402
FUEL CONNECTOR
 (1/4" NPT)
 Mates with **18-8091**

① Discount shop pack of 10 - Priced per package

**- UNIVERSAL DESIGN -
DIRECT REPLACEMENT FOR MERCURY AND YAMAHA
FUEL WATER SEPARATOR BRACKETS**



Bracket Type	Part #	Replaces	Bracket Type	Part #	Replaces
1/4" Stainless Steel	18-7777		1/4" Aluminum	18-7853-1	Mercury 89876A3, 89876, 55481
3/8" Stainless Steel	18-7776		3/8" Aluminum	18-7775	

FUEL WATER SEPARATOR KITS

**21 MICRON FILTER
KITS FOR
CARBURETED
ENGINES**



Kit Type	Part #	Micron Rating	Contents	Replaces
1/4" Aluminum (Short Filter)	18-7848-1	21	1 - 18-7844 filter & 1 18-7853-1 bracket 2 - 18-4256 1/4" pipe plugs	35-807172A4, Q4, 35-60494A4, 35-805369A4, 35-57250A1, 35-55501A1, 35-52456A1, 35-60494A1, 52444
1/4" Aluminum Bonus Pack Contains spare filter	18-7848-2	21	2 - 18-7844 filter & 1 18-7853-1 bracket 2 - 18-4256 1/4" pipe plugs	
1/4" Aluminum (Tall Filter)	18-7852-1	21	1 - 18-7845 filter & 1 18-7853-1 bracket 2 - 18-4256 1/4" pipe plugs	
1/4" Aluminum Bonus Pack Contains spare filter	18-7852-2	21	2 - 18-7845 filter & 1 18-7853-1 bracket 2 - 18-4256 1/4" pipe plugs	
3/8" Aluminum (Tall Filter)	18-7775-1	21	1 - 18-7845 filter & 1 18-7775 bracket 2 - 18-4264 3/8" pipe plugs	
1/4" Stainless Steel (Tall Filter)	18-7777-1	21	1 - 18-7845 filter & 1 18-7777 bracket 2 - 18-4256 1/4" pipe plugs	
3/8" Stainless Steel (Tall Filter)	18-7776-1	21	1 - 18-7845 filter & 1 18-7776 bracket 2 - 18-4264 3/8" pipe plugs	

* Display Packaged

10 MICRON FILTER KITS FOR FUEL INJECTED ENGINES

• Display Packaged



Kit Type	Part #	Micron Rating	Contents
1/4" Aluminum (Short Filter)	18-7983-1 •	10	1 - 18-7944 filter & 1 18-7853-1 bracket • 2 - 18-4256 1/4" pipe plugs
1/4" Aluminum Bonus Pack (Contains spare filter)	18-7983-2 •	10	2 - 18-7944 filter & 1 18-7853-1 bracket • 2 - 18-4256 1/4" pipe plugs
1/4" Aluminum (Tall Filter)	18-7982-1 •	10	1 - 18-7945 filter & 1 18-7853-1 bracket • 2 - 18-4256 1/4" pipe plugs
1/4" Aluminum Bonus Pack (Contains spare filter)	18-7982-2 •	10	2 - 18-7945 filter & 1 18-7853-1 bracket • 2 - 18-4256 1/4" pipe plugs
1/4" Aluminum (High Capacity Filter)	18-7986-1 •	10	1 - 18-7866 filter & 1 18-7853-1 bracket • 2 - 18-4256 1/4" pipe plugs
3/8" Aluminum (Tall Filter)	18-7986-1	10	1 - 18-7945 filter & 1 18-7775 bracket • 2 - 18-4264 3/8" pipe plugs
1/4" Stainless Steel (Tall Filter)	18-7984-1 •	10	1 - 18-7945 filter & 1 18-7777 bracket
3/8" Stainless Steel (Tall Filter)	18-7985-1 •	10	1 - 18-7945 filter & 1 18-7776 bracket • 2 - 18-4264 3/8" pipe plugs
1/4" Aluminum (Tall Filter)	18-79912	10	1 - 18-79911 & 1 - 18-7853-1



10 MICRON FILTER KITS WITH DRAIN BOWLS

Sierra AquaVue™ and metal bowl separator filters allow water to be drained from the filter to extend service life. Use the AquaVue™ bowl for outboard, above deck installations. USCG regulations require the use of the flame resistant metal bowl below deck.

Kit Type	Part #	Micron Rating	Contents
1/4" Aluminum w/ AquaVue™ bowl	18-7932-1 •	10	1 - 18-7919 filter & 1 18-7853-1 bracket 1 - 18-7922-1 AquaVue™ bowl 2 - 18-4256 1/4" pipe plugs
1/4" Aluminum w/ metal drain bowl	18-7951 •	10	1 - 18-7919 filter & 1 18-7853-1 bracket 1 - 18-7924 metal bowl 2 - 18-4256 1/4" pipe plugs
1/4" Stainless Steel w/ AquaVue™ bowl	18-7937-1 •	10	1 - 18-7919 filter & 1 18-7777 bracket 1 - 18-7922-1 AquaVue™ bowl 2 - 18-4256 1/4" pipe plugs
1/4" Stainless Steel w/ metal drain bowl	18-7938 •	10	1 - 18-7919 filter & 1 18-7777 bracket 1 - 18-7924 metal bowl 2 - 18-4256 1/4" pipe plugs

• Display Packaged

COMPACT BRACKET AND SEPARATOR KIT FOR SMALL OUTBOARDS AND FRESH WATER APPLICATIONS



18-7965-1
10 MICRON COMPACT SEPARATOR KIT
 Contains:
 1 - 18-7774 bracket
 1 - 18-7865 filter



18-7774
COMPACT ALUMINUM BRACKET

REPLACEMENT FILTERS



UNIVERSAL DESIGN - DIRECT REPLACEMENT FOR MERCURY AND YAMAHA

10 MICRON REPLACEMENT FILTERS			10 MICRON REPLACEMENT FILTERS		
Part #	Description	Replaces	Part #	Description	Replaces
18-7944	Short - 3.875"	35-807172, 35-802893Q, 35-806771, 35-8053691, 35-805369, 35-604941, 35-60494, 35-57250, 35-55501, 35-52456,	18-79911	Long - 8.5"	35-8M0079962
18-7945	Long - 4.35"	35-802893Q, 35-806771, 35-8053691, 35-805369, 35-604941, 35-60494, 35-57250, 35-55501, 35-52456	18-7596		35-866594K01
21 MICRON REPLACEMENT FILTERS					
Part #	Description	Replaces			
18-7844	Short - 3.875"	35-807172, 35-807172, 35-806771,			
18-7845	Long - 4.35"	35-8053691, 35-60494A4, 35-604941, 35-57250, 35-55501			
18-7866	High Capacity - 6"				
18-7865	Compact 10 Micron				
18-7967	Early model with sensor	35-18458Q3, 35-18458A3, 35-18458A2, 35-17808A1, 35-14571A1			
18-7968	Late model with sensor	35-18458Q4, 35-184585			



10 MICRON REPLACEMENT FILTERS AND KITS WITH DRAIN BOWLS
(SEE CHART BELOW)
• Display Packaged



18-8955 FUEL WATER SEPARATOR COVER
Fits: 18-7944 & 18-7945 sized filter.

REPLACEMENT FILTERS			FILTER & BOWL KITS	
Part #	Description	Replaces	Part #	Description
18-7919	Spin on replacement	35-809097, 35-8M0103095 Racor S3213	18-7928-1	Filter & AquaVue™ Bowl Mercury Style Contains: 18-7919 filter, 18-7922-1 bowl
18-7920	Spin on replacement	35-809099 Racor S3214	18-7929	Filter & Metal Bowl Mercury Style Contains: 18-7919 filter, 18-7924 bowl
18-7948	Spin on replacement Fits - 320RRAC01	35-886638 Racor S3227	18-7969	Filter & Metal bowl Contains: 18-7948 filter, 18-7924 bowl
REPLACEMENT BOWLS				
Part #	Description			
18-7922-1	AquaVue™ Collection Bowl			
18-7924	Metal Collection Bowl			
		18-7994-1 • Filter & AquaVue™ Bowl Contains: 18-7948 filter, 18-7922-1 bowl		

  <p>18-7936 FUEL FILTER ELEMENT Replaces: 35-888289T2 Fits: 225 EFI (2003-06), (SN 07853945 & Up)</p>	 <p>18-7712 FUEL FILTER (INLINE) Replaces: 35-16248 Fits: 4/5 2 cyl (1999 & Up), 4/5/6 4 stroke (1999 & Up), 8/9.9 4-stroke (2005 & Up)</p>	 <p>18-7713 FUEL FILTER (INLINE) Replaces: 35-80365M Fits: Mercury/Mariner 9.9 4-Stroke(1995-98), 15 4-Stroke (1998 & Up), Yamaha 6 (1989, 1992-99), 8 (1989-99, 2001-02), F4 (1999-02), F9.9 (1989-95, 1997-99, 2001-02), FT 9.9 (1988-90)</p>
 <p>18-7714 FUEL FILTER (INLINE) Replaces: 35-877565T1 Fits: 25 4-Stroke (1998 & Up), 30 4-Stroke (1999-01), 30 3 cyl 4-Stroke (1999-01), 40 4-Stroke (1998-01), 40 4-Stroke 4 cyl (2001-02), 40 Carb 3-cyl 4-Stroke (2002 & Up), 50 4-Stroke 4 cyl (2001-02), 60 4-Stroke 4 cyl (2001-02), 75 4-Stroke (2000 & Up), 90 4-Stroke (2000 & Up)</p>	 <p>18-7718 FUEL FILTER (INLINE) 5/16" Replaces: 35-879885T For: 135/150/175 4-Stroke Verado (S/N 1B227000 & Up), 200/225 4-Stroke Verado (S/N 0T980000 & Up), 250/275 4-Stroke Verado (S/N 0T801000 & Up)</p>	 <p>18-7802 FUEL FILTER Replaces: 35-87946A3, 35-87946-Q3, Q4 For: 6 HP thru 25 HP</p>
 <p>18-7832 FUEL FILTER Replaces: 1399-3938, 1399-1754, 1399-1136 For: A.J, KA, KB, KC, KD, WM, WMC Carb.</p>	 <p>18-7979 FUEL FILTER Replaces: 881540 Fits: 115 EFI (4 Stroke), 75HP (4 Stroke), 75HP (4 Stroke) (Bodensee), 90HP (4 Stroke)</p>	 <p>18-7981 FUEL FILTER Replaces: 35-884380T, 35-8M0020349 Fits: All Verados, 90HP (DFI) (3 cyl), 115 DFI (3 cyl) / 200HP (DFI) / 225HP (DFI) (including 3.0L DFI)</p>

FUEL FILTERS



Part #	Application
18-7828-1	1/4" small capacity (For 1/4" fuel line)
18-7829	1/4" large capacity (For 1/4" fuel line) Replaces: 35-16494, 35-816296, 35-816296T, 35-816296K03
18-7830	5/16" Replaces: 35-164941, 35-816296-1, 35-816296T1, 35-8162961, 35-816396Q1 35-816296B2, 35-816296B1, 35-134301
18-7831	3/8" Replaces: 802128A1



18-7997
AIR FILTER

Replaces: 35-853333T, 35-853333
Fits: V115 DFI (2.5L) (2000), V-135 DFI (2.5L) (1998 & Up), V-150 DFI (2.5L) (1998 & Up), V-175 DFI (2.5L) (2001 & Up), 200 DFI (1998-02), 225 DFI (1998-02)



18-7999
AIR FILTER

Replaces: 35-896247
For: 135/150/175 4-Stroke Verado (S/N 1B227000 & Up)

PKG. OF 10



18-7113-9[Ⓜ]
O-RING

Replaces: 25-897536, 25-98277
Fits: 18-7802 Filter Element (35-87946Q3)



18-3605
THERMOSTAT KIT

Fits: V-135 DFI (2.5L) (1998 & Up), V-150 DFI (2.5L) (1998 & Up), V-175 DFI (2.5L) (2000 & Up)

18-3606D Display Package



18-3606
THERMOSTAT KIT 130[Ⓜ]

Fits: 200 3.0L DFI DTS (ALL), 200 3.0L EFI (2003 & Up) (OT750164 & Up), 200 DFI (1997 & Up) (OG386496 & Up), 225 3.0L EFI (1999 & Up) (OG760300 & Up), 225 3.0L EFI SeaPro (2004 & Up) (OT801000 & Up), 225 3.0L DFI DTS (2003 & Up) (OT599000 & Up), 225 DFI (1998 & Up) (OG590000 & Up), 250 3.0L EFI (1999 & Up) (OG760300 & Up), 250 Long 3.0L EFI (OT861319 & Up)



18-43175
THERMOSTAT KIT 130[Ⓜ]

Replaces: 855676002
Fits: Mercury 15 Carb(2cyl) 4-Stroke (R235949 & Up), 15 SeaPro 4-Stroke (R051685 & Up), 20 Carb(2cyl) 4-Stroke (R235168 & Up), 25 EFI(3cyl)4-Stroke (R106999 & Up), 25 Jet EFI(3cyl)4-Stroke (R165086 & Up), 25 SeaPro 4-Stroke (R051710 & Up), 30 EFI(3cyl)4-Stroke (T409000-1B226999), 8 4-Stroke (209cc) (R042475 & Up), 9.9 4-Stroke (209cc) (R042475 & Up)



18-3672D Display Package

18-3672
THERMOSTAT KIT

— CONTAINS —

Part #	Desc.	Q.E.#
18-3553	Thermostat, Brass	75692
18-0182	Thermostat Gasket	27-62366

HP	Req. S/N	End S/N	HP	Req. S/N	End S/N
V135	A904646 & UP		V150 MAGII	C230553	4571651
V150	A904646 & UP		V150 MAGIII	D082000	4825248
V150 XR4	C239553	C159198	V175	C100861	& UP
V150 XR6	D082000 & UP		V200	6435503	& UP



18-3569
THERMOSTAT KIT

Replaces: 803061T1
Includes **18-3549** thermostat

HP	Req. S/N	End S/N	HP	Req. S/N	End S/N
70 3 cyl.	A996142	& UP	100 4 cyl.	B209488	& UP
75 3 cyl.	C222000	& UP	115 4 cyl.	C100000	& UP
80 3 cyl.	A996142	& UP	125 4 cyl.	D283222	& UP
90 3 cyl.	A996142	& UP			



18-43052
THERMOSTAT KIT

Replaces: 14586A3, 75962A9, 75962A10, 75962A11
Fits: Mercury 6-25 hp 2-Stroke



18-3535
THERMOSTAT 130[Ⓜ]

Replaces: 885599004
Fits: 200 3.0L DFI DTS (ALL), 200 3.0L EFI (2003 & Up) (OT750164 & Up), 200 DFI (1997 & Up) (OG386496 & Up), 225 3.0L EFI (1999 & Up) (OG760300 & Up), 225 3.0L EFI SeaPro (2004 & Up) (OT801000 & Up), 225 3.0L DFI DTS (2003 & Up) (OT599000 & Up), 225 DFI (1998 & Up) (OG590000 & Up), 250 3.0L EFI (1999 & Up) (OG760300 & Up), 250 Long 3.0L EFI (OT861319 & Up)



18-3536
THERMOSTAT 143[Ⓜ]

Replaces: 833072003
Fits: V135 DFI 2.5L (1998 & Up) (OG590000 & Up), V150 DFI 2.5L (1998 & Up) (OG590000 & Up), V175 DFI 2.5L (2001 & Up) (OT178500 & Up)



18-3537
THERMOSTAT 143[Ⓜ]

Replaces: 833072002, 833072004
Fits: 75 3 cyl DFI 1.5L (2006 & Up) (OT980000 & Up), 90 3 cyl DFI 1.5L (2004 & Up) (OT801000 & Up), 115 3 cyl DFI 1.5L (2004 & Up) (OT801000 & Up)

[Ⓜ] Items ending in "D" are Display Packaged - Regular number is Non-Display

[Ⓜ] Priced per package



18-3631
THERMOSTAT W/ HOUSING
Replaces: 892864T04
Fits: 135-300 Verado



18-3633
THERMOSTAT
Replaces: 8M0090819
Fits: 75-115HP, 115 Pro XS (2B094996 & Up)



18-3635
THERMOSTAT
Replaces: 892864T06
Fits: 75-115HP (1B366823-2B094995), 150 EFI (1B905505 & Up)



18-3638
THERMOSTAT
Replaces: 804540
Fits: 2.5-3.5HP (0R131842 & Up), 4-6HP (0R411838 & Up)



18-3640
THERMOSTAT
Replaces: 8M0117413
Fits: 40-60HP (1C050252 & Up)



18-3642
THERMOSTAT
Replaces: 855676A1
Fits: 40HP (3Cyl) (1C049739 & Up)



18-3553
THERMOSTAT
Replaces: 62981, 66850, 75692
143°

18-3553 THERMOSTAT APPLICATION

HP	Beg. S/N	End. S/N	HP	Beg. S/N	End. S/N
7.5	5226935	& UP	V150	A904646	& UP
9.8	5206550	& UP	V175	C100861	& UP
40	3336258	C159199	V200	6435503	& UP
50/60	D000750	& UP	V220	B117316	& UP
65	3547987	4571651	V225	5628028	& UP
70	4571652	4825248	V300/3.4L	5611648	& UP
70/75/80/90	A996142	& UP	XR4	C239553	D081999
100/115	B209468	& UP	Magnum II	C239553	D081999
V135	A904646	& UP			



18-3549
THERMOSTAT
Replaces: 14586
For: 6, 7, 8, 9.8 & 15 HP
Mercury/Mariner A197112 & Later
120°

18-3549 THERMOSTAT APPLICATION

MARINER		
HP	Serial #	
6, 8, 9.9 (2 cyl.)	A197112	Later
Sea Pro 10	D038000	Later
15 (2 cyl.)	B292414	Later
18XD, 20XD, 25XD	B114231	Later
25 (2 cyl.) 25 Sea Pro	B238464	Later
30 (2 cyl.)	G055314	Later
45 Jet, 50, 55, 60 (3 cyl.)	G290585	Later
MERCURY		
Sea Pro 10	D038000	Later
15 (2 cyl.)	B292414	Later
18XD, 20XD, 25XD	B114231	Later
25 (2 cyl.) 25 Sea Pro	B238464	Later
30 (2 cyl.)	G055314	Later
45 Jet, 50, 55, 60 (3 cyl.)	G290585	Later



18-3556
THERMOSTAT
Replaces: 895338
3/4" - 130°



18-43051
THERMOSTAT COVER KIT
Fits: Mercury V6



18-5896
SENDER
Replaces: 12415
1/8" - 27NPT Threads



18-3007
18-3007-10
IMPELLER
Replaces: 47-89983,
47-89983T



18-3008
IMPELLER
Replaces: 47-20813, 47-25287



18-3012
IMPELLER
Replaces: 47-22748



18-3017
18-3017-10ⓐ
IMPELLER
Replaces: 47-89984, 47-899842, 47-89984T3, 47-89984T4, 47-899844, 47-30221, 47-65960, 47-85460



18-3039
IMPELLER
Replaces: 47-65957, 47-89981, 47-39074
• .456" ID



18-3052
IMPELLER
Replaces: 47-56780, 47-65958, 47-89982



18-3054
IMPELLER
Replaces: 47-68988, 47-89980
• .438" ID



18-3056
18-3056-10ⓐ
IMPELLER
Replaces: 47-430261, 47-430262, 47-43026T2, 47-430264



18-3057
IMPELLER
Replaces: 47-85089-3



18-3062
IMPELLER
Replaces: 47-420381, 47-420382, 47-42038Q02



18-3063
IMPELLER
Replaces: 47-95611M, 47-81242M



18-3066
IMPELLER
Replaces: 47-11590M



18-3067
IMPELLER
Replaces: 47-84797M, 47-81604M



18-3069
IMPELLER
Replaces: 47-81423M, 47-97108M, 47-82824M



18-3072
IMPELLER
Replaces: 47-80395M



18-3073
IMPELLER
Replaces: 47-96305M



18-3074
IMPELLER
Replaces: 47-84027M, 47-84027T, 47-96619M



18-3098
IMPELLER
Replaces: 47-161543, 47-16154

APPLICATION BEGINS ON PAGE 417

ⓐ Discount shop pack of 10 - Priced per package

 <p>18-45312 IMPELLER Replaces: 47-95289, 47-952892 Fits: Mercury 2(T884302 & Up), 2.5(A855097 & Up), 3.3(G710613 & Up)</p>	 <p>18-8900 IMPELLER Replaces: 47-19453</p>	 <p>18-3293 IMPELLER KEY Replaces: 28-43037 Also large O/B's</p>		
 <p>18-3300 IMPELLER KEY Replaces: 28-83444M For models: 40A, 40B, 40C</p>	 <p>18-3305 IMPELLER KEY Replaces: 28-81912M, 28-83701M For models: 6C-D, 8C, 9.9C, 15C</p>	 <p>18-1838 SEAL, SHORT (1 3/4") Replaces: 43023 25 (4-Stroke), 30 (2 Cyl.), 30 (4-Stroke), 40 (2 Cyl.), 40 (3 Cyl.), 40 (4-Stroke), 50 (3 Cyl.), 50 (4-Stroke), 50 Bigfoot (4-Stroke)</p>	 <p>18-1839 SEAL, LONG (2-1/4") Replaces: 8235471 25 (4-Stroke), 30 (2 Cyl.), 30 (4-Stroke), 40 (2 Cyl.), 40 (3 Cyl.), 40 (4-Stroke), 50 (3 Cyl.), 50 (4-Stroke), 50 Bigfoot (4-Stroke)</p>	
 <p>18-3109 WATER TUBE GUIDE Replaces: 23-29804, 23-29804T, 23-52928 (Use with 18-3116 Housing)</p>	 <p>18-3013 UPPER WATER PUMP SEAL Replaces: 26-821309 For: 4-Stroke O/B's, 25/30/40/45/50 HP s/n OG750300 & UP</p>	 <p>18-3110 WATER PUMP HOUSING WITH BUSHING Replaces: 26-38970, 26-36557A1, 26-29677 (Part of 18-3116 Housing)</p>	 <p>18-3014 LOWER WATER PUMP SEAL Replaces: 26-821310 For: 4-Stroke O/B's, 25/30/40/45/50 HP s/n OG760300 & UP</p>	 <p>18-3151 WATER COUPLING ASSEMBLY Replaces: 816597</p>
 <p>18-3154 WATER COUPLING ASSEMBLY Replaces: 826763A</p>	<p>PKG. OF 5</p>  <p>18-3227-9[Ⓢ] WATER PUMP DOWEL PIN Replaces: 17-35973 For: 20-225HP S/N 1866496-Up</p>	 <p>18-1730 COUPLING Replaces: 43585 For: 200, 225, 250 & 275 Verado's</p>	 <p>18-3113 INSERT CUP Replaces: 70977</p>	 <p>18-3114 INSERT CUP Replaces: 48752, 48752T</p>
 <p>18-3115 INSERT CUP Replaces: 48753</p>	 <p>18-3435 INSERT CUP</p>	 <p>18-3107 IMPELLER PLATE Replaces: 54705, 32768</p>	 <p>18-3117 IMPELLER PLATE Replaces: 32435, 324351, 30605</p>	 <p>18-3122 IMPELLER PLATE Replaces: 817276, 8172761, 8172763</p>
 <p>18-3139 IMPELLER PLATE Replaces: 46895</p>	 <p>18-3436 IMPELLER PLATE</p>	 <p>18-4577 WEAR PLATE Replaces: 8213542</p>	 <p>18-3116 WATER PUMP HOUSING Replaces: 46-96148, 46-96148A1, 46-96148T1, 46-64141A1, 46-48743A1</p>	 <p>18-3118 WATER PUMP HOUSING Replaces: 46-48746A1, 46-77822A1, 46-48746A3</p>

APPLICATION BEGINS ON PAGE 417



18-3414
WATER PUMP BASE
Replaces: 46-96146A5, 46-73804A1



18-3416
WATER PUMP BASE
Replaces: 46-96146A6, 46-96146A2, 46-78400A1, 46-73802A2



18-3419
WATER PUMP BASE
Replaces: 46-42579A3



18-3422
WATER PUMP BASE
Replaces: 46-77516A1, 46-73842A2, 46-68390A1, 46-65498A1, 46-48745A1



18-3423
WATER PUMP BASE
Replaces: 46-73640A1



18-3424
WATER PUMP BASE
Replaces: 46-77177A1



18-3445
WATER PUMP BASE
Replaces: 46-812966A7, 46-812996A3, 46-812996A9
For: 40-60 HP



18-43212
WATER PUMP HOUSING
Replaces: 46-803750A02, 46-8037502
Fits: Mercury 8/9, 9 4-Stroke(209cc)



18-3207
IMPELLER REPAIR KIT
Replaces: 47-89983T2, 47-89983Q1

— CONTAINS —

Part #	Desc.	O.E. #	Qty.
18-3007	Impeller	47-89983	1
18-2945	Drain Screw Gasket	12-20260, 12-19183	2
18-2823	Low. Water Pump Base to Face Plate Gasket	27-32769, 27-19553	1
18-2824	Upper Face Plate to Pump Body Gasket	27-32770	1
18-2825	Water Pump Base Gasket	27-32771, 27-19551	1
18-2941	Water Pump Base Gasket	27-77417, 27-19552	1
18-2948	Rubber Washer	12-49221-1	1
18-3107	Plate	54705	1
18-7155	O-Ring	25-26855	1
18-7174	O-Ring	25-45711	1
18-7115	O-Ring	25-26722	1



18-3214
IMPELLER REPAIR KIT
Replaces: 47-43026T6, 47-43026T8, 47-43026T11

— CONTAINS —

Part #	Desc.	O.E. #	Qty.
NSS	Water Pump Base to Face Plate Gasket	27-43033-1	1
18-2565	Water Pump Base to Gear Housing Gasket	27-43047-1	1
18-2566	Face Plate to Water Pump Cover Gasket	27-817277	1
18-2944	Seal Ring	26-45577	1
18-3056	Impeller	47-43026-1	1
18-3122	Impeller Plate	817278	1
18-7420	O-Ring	25-21836	2



18-3215
IMPELLER REPAIR KIT
Replaces: 47-85089T7

— CONTAINS —

Part #	Desc.	O.E. #	Qty.
18-2560	Impeller Washer Gasket	12-86645	2
18-2561	Gear Housing to Face Plate Gasket	27-85087	1
18-2562	Gear Housing to Face Plate Gasket	27-99326-1	1
18-3057	Impeller	47-85089-3	1
18-7419	O-Ring	25-69202	1



18-3149-2
WATER PUMP KIT
Replaces: 46-42040A1, 46-42040A3, 46-42040A5, 46-42040T5
For: 10 Magnum, Marathon, Sea Pro, Viking
15 Marathon, Sea Pro 6, 8, 9.9HP, XR10

APPLICATION BEGINS ON PAGE 417

Ⓢ Items ending in "D" are Display Packaged - Regular number is Non-Display



18-3265
IMPELLER REPAIR KIT

Replaces: 47-43026Q06, 47-43026T11, 47-8M0100526
For: 135/150/175 4-Stroke Verado (S/N 1B227000 & Up), 200/225 4-Stroke Verado (S/N OT980000 & Up), 250/275 4-Stroke Verado (S/N OT801000 & Up)



18-3217
IMPELLER KIT
Similar to: 46-96148A5 without base or housing

— CONTAINS —

Part #	Desc.	O.E. #	Qty.
18-3109	Water Tube	23-29804	1
18-3017	Impeller	47-89984	1
18-2919	Water Pump Gasket	27-42631-1	1
18-3110	Grommet	26-38970	1
18-2945	Drain Screw Gasket	12-20260, 12-19183	2
18-2826	Water Pump Base to Gear Housing Gasket	27-85610	1
18-2914	Water Pump Gasket	27-85608-1	1
18-2915	Water Pump Gasket	27-85609-1	1
18-2944	Seal Ring	26-45577	1
18-3117	Plate	32435	1
18-7158	O-Ring	25-30613	1
18-7162	O-Ring	25-33145	1
18-7173	O-Ring	25-30224	1
18-7176	O-Ring	25-90011	1
18-2801	Water Pump Gasket	27-32438	1
18-7426	O-Ring	35-30271	1



18-3239
IMPELLER REPAIR KIT

— CONTAINS —

Part #	Desc.	O.E. #	Qty.
18-3039	Impeller	47-89981	1
18-3139	Impeller Plate	46895	1
18-7409	O-Ring	—	1



18-3252
IMPELLER REPAIR KIT
Replaces: 47-89982T1

— CONTAINS —

Part #	Desc.	O.E. #	Qty.
18-2004	Oil Seal	26-20070	2
18-2006	Oil Seal	26-897154	1
18-2827	Upper Face Plate to Water Pump Body Gasket	27-39623	1
18-2828	Lower Water Pump Base to Face Plate	27-39625	1
18-3052	Impeller	47-89982	1
18-7164	O-Ring	25-33466	1



18-3406
UPPER WATER PUMP REPAIR KIT
Replaces: 817275A08
For: 135/150/175 4-Stroke Verado (S/N 1B227000 & Up), 200/225 4-Stroke Verado (S/N OT980000 & Up), 250/275 4-Stroke Verado (S/N OT801000 & Up)



18-3407
UPPER WATER PUMP REPAIR KIT
Replaces: 817275A09
For: 135/150/175 4-Stroke Verado (S/N 1B227000 & Up), 200/225 4-Stroke Verado (S/N OT980000 & Up), 250/275 4-Stroke Verado (S/N OT801000 & Up)

18-3314
WATER PUMP KIT



— CONTAINS —

Part #	Desc.	O.E. #	Qty.
18-3109	Water Tube Guide	23-29804	1
18-3017	Impeller	47-89984	1
18-3116	Housing	46-96148A1	1
18-3414	Base	46-96148A5	1
18-2919	Water Pump Gasket	27-42631-1	1
18-3110	Grommet	26-38970	1
18-2945	Drain Screw Gasket	12-20260, 12-19183	2
18-2826	Water Pump Base to Gear Housing Gasket	27-85610-1	1
18-2914	Water Pump Gasket	27-85608-1	1
18-2915	Water Pump Gasket	27-85609-1	1
18-2944	Seal Ring	26-45577	1
18-3117	Plate	32435	1
18-7158	O-Ring	25-30613	1
18-7162	O-Ring	25-33145	1
18-7173	O-Ring	25-30224	1
18-7176	O-Ring	25-90011	1
18-2801	Gasket	27-32438	1
18-7426	O-Ring	35-30271	1

18-3316
WATER PUMP KIT

Replaces: 46-78400A2, 46-96148A8, 46-32437A3



— CONTAINS —

Part #	Desc.	O.E. #	Qty.
18-3109	Water Tube Guide	23-29804	1
18-3017	Impeller	47-89984	1
18-3116	Housing	46-96148A1	1
18-3416	Base	46-96148A6	1
18-2919	Water Pump Gasket	27-42631-1	1
18-3110	Grommet	26-38970	1
18-2945	Drain Screw Gasket	26-20260, 12-19183	2
18-2826	Water Pump Base to Gear Housing Gasket	27-85610-1	1
18-2914	Water Pump Gasket	27-85608-1	1
18-2915	Water Pump Gasket	27-85609-1	1
18-2944	Seal Ring	26-45577	1
18-3117	Plate	32435	1
18-7158	O-Ring	25-30613	1
18-7162	O-Ring	25-33145	1
18-7173	O-Ring	25-30224	1
18-7176	O-Ring	25-90011	1
18-2801	Gasket	27-32438	1
18-7196	O-Ring	25-38099	1
18-7426	O-Ring	35-30271	1

18-3319
WATER PUMP KIT

Replaces: 46-42579A4



— CONTAINS —

Part #	Desc.	O.E. #	Qty.
18-3109	Water Tube Guide	23-29804	1
18-3017	Impeller	47-89984	1
18-3116	Housing	46-96148A1	1
18-3419	Base	46-42579A3	1
18-2919	Water Pump Gasket	27-42631-1	1
18-3110	Grommet	26-38970	1
18-2945	Drain Screw Gasket	26-20260, 12-19183	2
18-2826	Water Pump Base to Gear Housing Gasket	27-85610-1	1
18-2914	Water Pump Gasket	27-85608-1	1
18-2915	Water Pump Gasket	27-85609-1	1
18-2944	Seal Ring	26-45577	1
18-3117	Plate	32435	1
18-7158	O-Ring	25-30613	1
18-7162	O-Ring	25-33145	1
18-7173	O-Ring	25-30224	1
18-7176	O-Ring	25-90011	1
18-2801	Gasket	27-32438	1
18-7426	O-Ring	35-30271	1

18-3507
WATER PUMP KIT

(Without Base)

Replaces: 46-60366A1

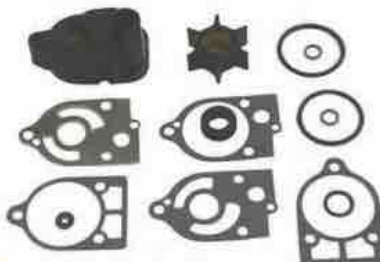

— CONTAINS —

Part #	Desc.	O.E. #	Qty.
18-3007	Impeller	47-89983	1
18-3118	Upper Pump Housing	46-77822A1	1
18-2945	Drain Screw Gasket	12-20260, 12-19183	2
18-2823	Lower Water Pump Base to Face Plate Gasket	27-32769, 27-19553	1
18-2824	Upper Face Plate To Body Gasket	27-32770, 27-19551	1
18-2825	Water Pump Base Gasket	27-32771	1
18-2841	Water Pump Base Gasket	27-77417, 27-19552	1
18-2948	Drain Plug	12-49221-1	1
18-3107	Plate	54705	1
18-7155	O-Ring	25-26855	1
18-7174	O-Ring	25-45711	1
18-7115	O-Ring	25-26722	1

18-3517
WATER PUMP KIT

(Without Base)

Replaces: 46-96148A5, 46-96148A8, 46-78400A2, 46-73804A3
46-73802A3, 46-69222A3, 46-64141A11, 46-80367A4, 46-58618A4
46-57234A3, 46-48747A3, 46-42579A4, 46-44292A4, 46-32437A1



— CONTAINS —

Part #	Desc.	O.E. #	Qty.
18-3109	Water Tube	23-29804	1
18-3017	Impeller	47-89984	1
18-3116	Housing	46-96148A1	1
18-2919	Water Pump Gasket	27-42631-1	1
18-3110	Grommet	26-38970	1
18-2945	Drain Screw Gasket	26-20260, 12-19183	2
18-2826	Water Pump Base to Gear Housing Gasket	27-85610-1	1
18-2914	Water Pump Gasket	27-85608-1	1
18-2915	Water Pump Gasket	27-85609-1	1
18-2944	Seal Ring	26-45577	1
18-3117	Plate	32435	1
18-7158	O-Ring	25-30613	1
18-7162	O-Ring	25-33145	1
18-7173	O-Ring	25-30224	1
18-7176	O-Ring	25-90011	1
18-2801	Water Pump Gasket	27-32438	1
18-7426	O-Ring	35-30271	1

18-3322
WATER PUMP KIT

Replaces: 46-77516A3



— CONTAINS —

Part #	Desc.	O.E. #	Qty.
18-3007	Impeller	47-89983	1
18-3118	Upper Pump Housing	46-77822A1	1
18-3422	Water Pump Base	46-77516A1	1
18-2945	Drain Screw Gasket	12-20260, 12-19183	2
18-2823	Lower Water Pump Base to Face Plate Gasket	27-32769, 27-19553	1
18-2824	Upper Face Plate To Body Gasket	27-32770, 27-19551	1
18-2825	Water Pump Base Gasket	27-32771	1
18-2841	Water Pump Base Gasket	27-77417, 27-19552	1
18-2948	Drain Plug	12-49221-1	1
18-3107	Plate	54705	1
18-7155	O-Ring	25-26855	1
18-7174	O-Ring	25-45711	1
18-7115	O-Ring	25-26722	1



18-3323
WATER PUMP KIT
Replaces: 46-73640A2

— CONTAINS —

Part #	Desc.	O.E. #	Qty.
18-3007	Impeller	47-89983	1
18-3118	Upper Pump Housing	46-77822A1	1
18-3423	Water Pump Base	46-73640A1	1
18-2945	Drain Screw Gasket	12-20260, 12-19183	2
18-2823	Lower Water Pump Base to Face Plate Gasket	27-32769, 27-19553	1
18-2824	Upper Face Plate To Body Gasket	27-32770, 27-19551	1
18-2825	Water Pump Base Gasket	27-32771	1
18-2841	Water Pump Base Gasket	27-77417, 27-19552	1
18-2948	Drain Plug	12-49221-1	1
18-3107	Plate	54705	1
18-7155	O-Ring	25-26855	1
18-7174	O-Ring	25-45711	1
18-7115	O-Ring	25-26722	1

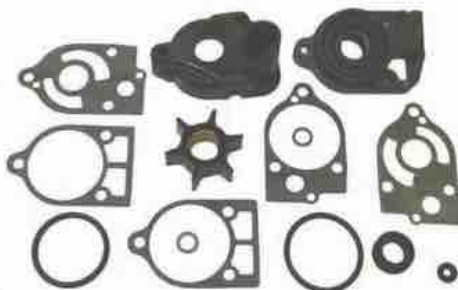

18-3324
WATER PUMP KIT
Replaces: 46-77177A3

— CONTAINS —

Part #	Desc.	O.E. #	Qty.
18-3007	Impeller	47-89983	1
18-3118	Upper Pump Housing	46-77822A1	1
18-3424	Water Pump Base	46-77177A1	1
18-2945	Drain Screw Gasket	12-20260, 12-19183	2
18-2823	Lower Water Pump Base to Face Plate Gasket	27-32769, 27-19553	1
18-2824	Upper Face Plate To Body Gasket	27-32770, 27-19551	1
18-2825	Water Pump Base Gasket	27-32771	1
18-2841	Water Pump Base Gasket	27-77417, 27-19552	1
18-2948	Drain Plug	12-49221-1	1
18-3107	Plate	54705	1
18-7155	O-Ring	25-26855	1
18-7174	O-Ring	25-45711	1
18-7115	O-Ring	25-26722	1



18-3571
WATER PUMP HOUSING KIT
Replaces: 817275A1
V-6 outboard



18-3572
WATER PUMP HOUSING KIT
Replaces: 46-43024A3, 817275A2



18-3148
WATER PUMP REPAIR KIT
Without Housing
Replaces: 46-84277M, 46-84277T

— CONTAINS —

Part #	Desc.	O.E. #	Qty.
18-0768	Wear Plate Gasket	—	1
18-3074	Impeller	47-84027M	1
18-3305	Woodruff Key	28-8192M	1



18-3446
WATER PUMP KIT
Replaces: 46-70941A3
For: 4/4.5 HP

— CONTAINS —

Part #	Desc.	O.E. #	Qty.
18-3039	Impeller	47-89981	1
18-3139	Impeller Plate	46895	1

18-3448
WATER PUMP KIT
Replaces: 46-48744A3
For: 20 HP 1967-80



— CONTAINS —

Part #	Desc.	O.E.#	Qty.
18-3052	Impeller	47-89982	1
18-2827	Upper Face Plate Gasket	27-39623	1
18-2828	Lower Face Plate Gasket	27-39625	1
18-2829	Water Pump Base Gasket	27-39626	1

18-4531
WATER PUMP REPAIR KIT
Without Housing

Replaces: 821354A2
Fits: 25 (4-Stroke), 30 (2 Cyl.), 30 (4-Stroke), 40 (2 Cyl.), 40 (3 Cyl.), 40 (4-Stroke), 50 (3 Cyl.), 50 (4-Stroke), 50 Bigfoot (4-Stroke)



— CONTAINS —

Part #	Desc.	O.E.#	Qty.
18-1838	Seal, Short 1 3/4"	43023	1
18-1839	Seal, Long 2 1/4"	8235471	1
18-2560	Waasher	12-866451	2
18-0345	Gasket, Upper Water Pump	27-822189	1
18-99155	Gasket, Lower Water Pump	27-822217	1
18-4577	Plate, Wear	8213542	1
18-3057	Impeller	47-850893	1

18-3570
WATER PUMP KIT

— CONTAINS —

Part #	Desc.	O.E.#	Qty.
NSS	Water Pump Housing	—	1
18-3056	Impeller	47-430262	1
18-2599	Face Seal & Tool	26-816575A2	1
18-3122	Impeller Plate	817276	1

HP	Reg. S/N	Enrl. S/N	HP	Reg. S/N	Enrl. S/N
817275A2 APPLICATION					
— 817275A2 APPLICATION (Cont.)					
40 (4 stroke)			80 Jet	DD283222	& UP
(4 cyl.) Bigfoot	OT2284D5	& UP	90 (3 cyl.)	DA996142	& UP
50 (4 stroke)			90 (4 stroke)	DG9960500	& UP
935cc Big Foot	OG231123	OT178499	100 (4 cyl.)	DB209468	& UP
50 (4 stroke)			115 (4 cyl.)	DC109000	& UP
996cc Big Foot	OT178500	& UP	125 (4 cyl.)	DD283222	& UP
60 (3 cyl.)			817275A1 APPLICATION		
Bigfoot	DD000750	& UP	45 (4 stroke)		
60 (4 stroke)			Bigfoot Rotabase	OG231123	& UP
Bigfoot	OT178500	& UP	V-200 DFI (3.0L)	OG386496	DG589999
65 Jet	OC283222	& UP	V-200 DFI (3.0L)	OG590000	& UP
70 (3 cyl.)	DA996142	& UP	V-225 (3.0L)		
75 (3 cyl.)	OC222000	& UP	Carb & EFI	DD280813	& UP
75 (4 stroke)	DG996050	& UP	V-225 DFI	DG590000	& UP
80 (3 cyl.)	DA996142	& UP	V-250 (3.0L) EFI	DG129222	& UP

18-3425
WATER PUMP KIT
Without Housing

Replaces: 84188M, 84188T



— CONTAINS —

Part #	Desc.	O.E.#	Qty.
18-0282	Wear Plate to Pump Housing Gasket	27-81417M	1
18-3435	Insert Cup	—	1
18-0294	Wear Plate to Pump Base Gasket	—	1
18-3069	Impeller	47-81423M, 47-97108M	1
18-0256	Bolt	—	2
18-3436	Impeller Plate	—	1
18-3297	Impeller Key	—	1

18-3426
WATER PUMP KIT
With Housing
Replaces: 42431M, 84829M, 97793M, 97793T



— CONTAINS —

Part #	Desc.	O.E.#	Qty.
18-3067	Impeller	47-84797M	1
NSS	Impeller Key	28-81603M	1

18-3427
WATER PUMP KIT
With Housing
Replaces: 81242M, 95661M



— CONTAINS —

Part #	Desc.	O.E.#	Qty.
18-0773	Wear Plate Gasket	—	1
18-3067	Impeller	47-84797M	1
NSS	Impeller Key	28-81603M	1



18-48317
COMPLETE WATER PUMP KIT

Replaces: 46-803750A03
Fits: Mercury B-9.9 4-Stroke(209cc)(R042475 & Up)

MARINER COOLING SYSTEM APPLICATION

Mariner Models	S/N Code	S/N	Impeller	Plate	Impeller Cup	Impeller Repair Kit	Complete Kit
2A	646	All	18-3072	—	—	—	—
2B	6A1	All	18-3072	—	—	—	—
4A	6E0	All	18-3073	—	—	—	—
5C	6E3	All	18-3073	—	—	—	—
6C	6H8	All	18-3066	—	—	—	—
6D	6H6	All	18-3066	—	—	—	—
8A(M)	655	000000-000300	18-3063	—	—	—	—
8A(ML)	655	000000-300101	18-3063	—	—	—	—
8B(M)	677	000101 & Up	18-3063	—	—	—	—
8B(ML)	677	300101 & Up	18-3063	—	—	—	—
8C	6G1	All	18-3066	—	—	—	—
9.9C	682	All	18-3074	—	—	18-3148	—
15A(M)	651	000285 & Below	18-3063	—	—	—	—
15A(ML)	651	3000100 & Below	18-3063	—	—	—	—
15C	684	All	18-3074	—	—	18-3148	—
20C(M)	6A9	000101-005810	18-3067	18-3436	—	18-3426	—
20C(ML)	6A9	300101-306542	18-3067	18-3436	—	18-3426	—
20C(E)	6A9	250101-250819	18-3067	18-3436	—	18-3426	—
20C(EL)	6A9	550101-550693	18-3067	18-3436	—	18-3426	—
20C(M)	6A9	010112 & Up	18-3067	—	—	—	18-3427
20C(ML)	6A9	306543 & Up	18-3067	—	—	—	18-3427
20C(E)	6A9	250820 & Up	18-3067	—	—	—	18-3427
20C(EL)	6A9	550694 & Up	18-3067	—	—	—	18-3427
25C(M)	695	000101-014870	18-3067	18-3436	—	—	18-3426
25C(ML)	695	000000-312185	18-3067	18-3436	—	—	18-3426
25C(E)	695	000000-252290	18-3067	18-3436	—	—	18-3426
25C(EL)	695	000000-553575	18-3067	18-3436	—	—	18-3426
25C(M)	695	014871 & Up	18-3067	—	—	—	18-3427
25C(ML)	695	312186 & Up	18-3067	—	—	—	18-3427
25C(E)	695	252291 & Up	18-3067	—	—	—	18-3427
25C(EL)	695	553576 & Up	18-3067	—	—	—	18-3427
28	664	All	18-3067	—	—	—	—
30	689	All	18-3067	—	—	—	—
30A(M)	689	000366-014805	18-3067	18-3436	—	—	18-3426
30A(ML)	689	301911-315315	18-3067	18-3436	—	—	18-3426
30A(E)	689	100251-103275	18-3067	18-3436	—	—	18-3426
30A(EL)	689	401216-407815	18-3067	18-3436	—	—	18-3426
30A(M)	689	022059 & Up	18-3067	—	—	—	18-3427
30A(ML)	689	321377 & Up	18-3067	—	—	—	18-3427
30A(E)	689	105325 & Up	18-3067	—	—	—	18-3427
30A(EL)	689	411947 & Up	18-3067	—	—	—	18-3427
48/48W	670	All	18-3069	18-3436	18-3435	18-3425	—
55/W55	663	All	18-3069	18-3436	18-3435	18-3425	—
60	675,6F0	All	18-3069	18-3436	18-3435	18-3425	—

MERCURY COOLING SYSTEM APPLICATION

Horsepower	Beginning Serial #	Ending Serial #	Impeller	Impeller Plate	Insert Cup	Upper Housing	Base	Impeller Repair Kit	Thermostat	Upper Kit	Complete Kit
3.3 (with shift)	D901217	& UP	18-3098								
3.5	358136	6202172	18-3012								
3.5	6202173	& UP	18-3054								
3.6	5404657	& UP	18-3054								
3.9	1655013	2498135	18-3012	18-3139							
4 (1 cyl.)	2498136	4107219	18-3039	18-3139				18-3239			
4 (2 cyl.)	5589202	& UP	18-3054	—							
4 (made in USA)	5595532	A809600	18-3054	18-3139							
4 (made in USA)	5595532	& UP	18-3039	18-3139		18-3446		18-3239			18-3446
4 (1 cyl.)	A809601	& UP	18-3098	—						—	
4.5	4107220	5595531	18-3039	18-3139				18-3239			18-3446
4.5	5595532	& UP	18-3054	18-3139							
4.5	5595532	& UP	18-3039	18-3139				18-3239			18-3446
5	574128	786612	18-3012								
5 (1 cyl.)	A809601	& UP	18-3098	—							
5 4-STROKE	R000001	& UP	18-3098								
6	888005	1916138	18-3012								
6	1916139	2193817	18-3039	18-3139				18-3239			
6	A197112	OT800749	18-3062								
6	1582403	1916138	18-3039								
6	1916139	2193817	18-3039								
6	2193818	2529894	18-3039								
6	2385673	2387383	18-3039								
7.5	2529895	4131609	18-3039	18-3139							
7.5	4131610	5226934	18-3039	18-3139				18-3239			18-3446
7.5	5206550	& UP	18-3054								
7.5	5206550	& UP	18-3039	18-3139				18-3239			18-3446

- 1 Models with aluminum upper pump housings
- 2 Models with aluminum water pumps
- 3 Models with plastic upper pump housings
- 4 Models with plastic water pumps
- 5 Pump screws without insulators
- 6 Pump screws with insulators
- 7 Models with driveshaft retaining nut

- 8 Models without driveshaft retaining nut
- 9 Models with flush hole
- 10 Models without flush hole
- 11 Models having plastic upper housing use #48752 inset cup
- 12 Units already having a complete pump replacement using 46-46893A 6 should use the 2193818-2529894 serial group for components
- 13 Units already having a complete pump replacement using 46-46893A 6 should use USA 3795658-4126549 serial group for components
- 14 Units which have already had a complete pump replacement with the 46-46893A 6 pump should use the "Early Mariner Impellers" chart for components

MERCURY COOLING SYSTEM APPLICATION

Horsepower	Beginning Serial #	Ending Serial #	Impeller	Impeller Plate	Insert Cup	Upper Housing	Base	Impeller Repair Kit	Thermostat	Upper Kit	Complete Kit
8	A197112	& UP	18-3062								
8 (4-stroke Bodensee)	G760300	& UP	18-3062								
110 (9.8)	1865779	2196388	18-3039								
110 (9.8)	2196389	3795657	18-3039								
110 (9.8)	3795658	4126459	18-3039								
110 (9.8)	4126460	5206549	18-3039	18-3139				18-3239			
110	5206550	& UP	18-3054								
9.8	5206550	& UP	18-3039	18-3139				18-3239	18-3553		18-3446
9.9	A197112	& UP	18-3062								
9.9 (4 Stroke) STANDARD CASE	G760300	T979999	18-3062								
XR10 SeaPro	D038000	& UP	18-3062						18-3549		
10	500022	1057993	18-3008								
15	B292414	& UP	18-3062						18-3549		
15 SeaPro	G044365	& UP	18-3062								
16	700000	& UP	18-3008								
18	5837437	& UP	18-3057								
20	860970	1292909	18-3008								
20	2827677	6443972	18-3052					18-3252			18-3448
20	6443973	T800749	18-3057					18-3215			
22	1158546	1238089	18-3008								
25,25XD,25 Sea Pro	5705532	& UP	18-3057					18-3215			
25 (3 cyl.)	E268781	& UP	18-3057					18-3215			
30	950250	1260724	18-3008								
30	1271884	1448139	18-3007	18-3107				18-3207		18-3507	
30 Jet	C159200	G589999	18-3007	18-3107	18-3115	18-3118	18-3424	18-3207		18-3507	18-3324
30 Jet	G590000	& UP	18-3057								
30 (2 cyl)	G053314	T598999	18-3057								
35	1217222	1448139	18-3007								
35	1571114	1960826	18-3007	18-3107				18-3207		18-3507	
35	1960827	2453068	18-3007	18-3107				18-3207		18-3507	
35	6445653	& UP	18-3007	18-3107	18-3115	18-3118	18-3424	18-3207		18-3507	18-3324
40	941751	1224480	18-3008								
40	1224481	1476509	18-3007								
40	2874704	4362214	18-3007	18-3107	18-3115	18-3118	18-3422	18-3207		18-3507	18-3322
40 (2 cyl) thru 1983	4860103	& UP	18-3057	18-3107	18-3115	18-3118	18-3424	18-3207		18-3507	18-3324
40 (3 cyl)	G531301	& UP	18-3057							18-3507	
40 (4 cyl)	C159200	& UP	18-3007	18-3107	18-3115	18-3118	18-3424	18-3207			
40 (4-stroke) 2:1 ratio	G760300	T408999	18-3057								
40 (EFI 4-stroke) 1.83:1 ratio	T409000	& UP	18-8900				18-3445				
40 (EFI 4-stroke) 2.31:1 ratio	T409000	B344398	18-3056					18-3214			
40 (4-stroke, 4 cyl.) 2.31:1 ratio	T228405	T598999	18-3056					18-3214			
40 (4-stroke, Std)	G231123	T178499	18-3057								
40 4-stroke Carb BIG FOOT	C033811	& UP	18-3056								
40	1279685	1476509	18-3007							18-3507	
45	5531630	& UP	18-3007	18-3107	18-3115	18-3118	18-3424	18-3207			
45 Jet (3 cyl)	D000750	& UP	18-8900								
45 (4-stroke, std) Bodensee	G231123	& UP	18-3057								
45 (4-stroke, bigfoot) Bodensee	G231123	& UP	18-3056					18-3214			
50	1421113	1480498	18-3007							18-3507	
50	1477910	1521913	18-3007								
50	1521914	2305100	18-3007	18-3107				18-3207		18-3507	
50 aluminum w/p	2305101	2478119	18-3007								
50 plastic w/p	2305101	2478119	18-3007								
500	2514919	4357639	18-3007	18-3107	18-3115	18-3118	18-3422	18-3207		18-3507	
50 (4cyl)	4357640	5531629	18-3007	18-3107	18-3115	18-3118	18-3423	18-3207		18-3507	
50 (4cyl)	5531630	& UP	18-3007			18-3118					
50 (4 cyl)	4962056	& UP	18-3007	18-3107	18-3115	18-3118	18-3424	18-3207		18-3507	
50 (3 cyl)	6428681	D000749	18-3007	18-3107	18-3115	18-3118	18-3424	18-3207			
50 (3 cyl)	D000750	G589999	18-8900				18-3445		18-3553		
50 (3 cyl)	G590000	& UP	18-3057								
50 (4-stroke, Std)	G231123	T178499	18-3057								
50 (4-stroke, 4 cyl.) STANDARD	T178500	T598999	18-8900				18-3445				
50 (4-stroke, 4 cyl.) BIG FOOT	T178500	& UP	18-3056			18-3572		18-3214			
50 (EFI 4-stroke) STANDARD	T409000	B344398	18-8900				18-3445				
50 (EFI 4-stroke) BIG FOOT	T409000	B344398	18-3056					18-3214			
55 (3 cyl)	D000750	& UP	18-8900				18-3445				
60	6428681	D000749	18-3007	18-3107	18-3115	18-3118	18-3424	18-3207			18-3324
60 (3cyl) standard	D000750	& UP	18-3056	18-3122				18-3214	18-3553		
60 Marathon	D000750	& UP	18-3056	18-3122				18-3214			
60 Big Foot	D000750	& UP	18-3056	18-3122				18-3214	18-3553		
60 (3 cyl)	D000750	& UP	18-8900						18-3553		
60 4-STROKE STANDARD	OT178500	T598999	18-8900				18-3445	18-3214			
60 4-STROKE, BIG FOOT	OT178500	T598999	18-3056					18-3214			
60 4-STROKE EFI BIG FOOT	T409000	B344398	18-3056								

1 Models with aluminum upper pump housings

2 Models with aluminum water pumps

3 Models with plastic upper pump housings

4 Models with plastic water pumps

5 Pump screws without insulators

6 Pump screws with insulators

7 Models with driveshaft retaining nut

8 Models without driveshaft retaining nut

9 Models with flush hole

10 Models without flush hole

11 Models having plastic upper housing use #48752 inset cup

12 Units already having a complete pump replacement using 46-46893A 6 should use the 2193818-2528994 serial group for components

13 Units already having a complete pump replacement using 46-46893A 6 should use USA 3795638-4126549 serial group for components

14 Units which have already had a complete pump replacement with the 46-46893A 6 pump should use the "Early Mariner Impellers" chart for components

MERCURY COOLING SYSTEM APPLICATION

Horsepower	Beginning Serial #	Ending Serial #	Impeller	Impeller Plate	Insert Cup	Upper Housing	Base	Impeller Repair Kit	Thermostat	Upper Kit	Complete Kit
65(4 cyl) aluminum w/p	1542745	280351	18-3017	18-3117	18-3114			18-3217		18-3507	
65 (4cyl) plastic w/p	1542745	280351	18-3017			18-3116					
65 (4cyl)	2803562	2874263	18-3017			18-3116					
65 (4cyl)	2997439	3293183	18-3017			18-3116					
65(3 cyl)	3293184	4382056	18-3007	18-3107	18-3115	18-3116	18-3422	18-3207		18-3507	
65(3 cyl)	4382057	4571651	18-3007	18-3107	18-3115	18-3116	18-3424	18-3207			
65 Jet	00283222	& UP	18-3056	18-3122				18-3214			
70	1413611	1436114	18-3017	18-3117				18-3217		18-3507	
70 (6cyl)	1482212	1503458	18-3017								
700 E-2 (6cyl)	1503459	1503958	18-3017								
700 EL-2 (6cyl)	1503459	1566239	18-3017								
700 E-2 (6cyl)	11	1503959	1566239	18-3017		18-3116					
700 EL-2 (6cyl)	11	1505111	1566239	18-3017		18-3116					
70 (3 cyl)	4571652	4977156	18-3007	18-3107	18-3115	18-3116	18-3423	18-3207	18-3553	18-3507	
70	4977157	6428680	18-3007	18-3107	18-3115	18-3116	18-3424	18-3207			
70	B110054	& UP	18-3056					18-3214			18-3517
70 (3cyl)	6	A996142	C221999	18-3056		18-3572			18-3553		
70 (3cyl)	5	A996142	C221999	18-3056		18-3572			18-3553		
75 (4 cyl)	6432901	& UP	18-3017	18-3117	18-3114	18-3116	18-3414	18-3217			
75 (3 cyl)	A996142	C221999	18-3056					18-3214	18-3553		
75 (3 cyl)	C222000	& UP	18-3056					18-3214	18-3569		
75 (3 cyl)	C222000	& UP	18-3056	18-3122				18-3214	18-3569		
75 (3cyl) Optimax	T980000	& UP	18-3056			18-3572					
75 4-STROKE	G960500	B366822	18-3056					18-3214			
75 4-STROKE	B366823	& UP	18-3056			18-3572					
80	1355468	3493912	18-3017	18-3117				18-3217			18-3517
80 (6cyl)	1335465	1398629	18-3017								
80 (4 cyl)	4831999	6432900	18-3017	18-3117	18-3114	18-3116	18-3414	18-3217			
80 (3 cyl)	6	A996142	C221999	18-3056				18-3214	18-3553		
80 (3 cyl)	5	A996142	C221999	18-3056		18-3572			18-3553		
80 Jet	D283222	& UP	18-3056	18-3122				18-3214			
850 E & EL (6cyl)	1460999	1567039	18-3017	18-3117				18-3217		18-3517	
850 E-1, EL-1 (6cyl)	11	1566240	1766823	18-3017							
85 (4 cyl)	4590512	& UP	18-3017	18-3117	18-3114	18-3116	18-3414	18-3217			
85 XS (4cyl)	3493913	4831998	18-3017			18-3116					
850 XS (4cyl)	3493913	4831998	18-3017			18-3116					
850, 850 XS (4cyl)	3493913	4590511	18-3017			18-3116					
900 (90hp) (6 cyl)	11	1766824	1869775	18-3017	18-3117			18-3217		18-3517	
90 (6 cyl)	4845301	& UP	18-3017	18-3117	18-3114	18-3116	18-3414	18-3217			
90 (3 cyl)	B110054	C221999	18-3056					18-3214			
90 (3 cyl)	A996142	& UP	18-3056					18-3214	18-3553		
90 (3 cyl)	A996142	& UP	18-3056	18-3122				18-3214	18-3553		
90 4-STROKE	G960500	B366822	18-3056			18-3572		18-3214			
90 4-STROKE	B366823	& UP	18-3056			18-3572		18-3214			
95	1869776	2318585	18-3017	18-3117				18-3217			
115 (3CYL) Optimax	T801000	& UP	18-3056			18-3572					
950 (95hp) (6 cyl)	11	1869776	2318585	18-3017							
1000(6 cyl)	1464949	1503331	18-3017	18-3117				18-3217			
1000 (6cyl)	1503332	2318585	18-3017			18-3116					
100 (4 cyl)	B209468	& UP	18-3056					18-3214	18-3553		
100 (4 cyl)	B209468	& UP	18-3056	18-3122				18-3214	18-3553		18-3517
1000 SS (6cyl)	1	2318586	2413843	18-3017		18-3116					
1000 SS (6cyl)	3	2318586	2413843	18-3017		18-3116					
1000 SS E-1	1	2484633	2836018	18-3017		18-3116					
1000 SS E-1	3	2484633	2836018	18-3017		18-3116					
1000 BP (6cyl)	2399698	3253111	18-3017			N.L.A.					
105 Jet	00182000	& UP	18-3017	18-3117	18-3114	18-3116	18-3419	18-3217			
110	1	1870204	2314955	18-3017	18-3117			18-3217			
110	3	1870204	2314955	18-3017		18-3317					
115 (6cyl)	2836019	4112634	18-3017	18-3117				18-3217		18-3517	
115 (6cyl)	4112635	4394236	18-3017								
115 (6 cyl)	4394237	& UP	18-3017	18-3117	18-3114	18-3116	18-3414	18-3217			
115 (4 cyl)	6	C100000	& UP	18-3056				18-3214	18-3569		
115 (4cyl)	5	C100000	& UP	18-3056		18-3572			18-3569		
115 (4 cyl)	B209468	& UP	18-3056	18-3122				18-3214			
115 4-STROKE	T178500	B366822	18-3056					18-3214			
115 4-STROKE	B366823	& UP	18-3056			18-3572					
115 (3cyl) Optimax	T801000	& UP	18-3056			18-3572					
115 Pro XS	B751825	& UP	18-3056			18-3572					
125 (6cyl)	2	2314956	2839368	18-3017	18-3117			18-3217			
125 (6cyl)	4	2314956	2839368	18-3017							
125 (4 cyl)	6	D283222	& UP	18-3056					18-3569		
125 (4cyl)	5	D283222	& UP	18-3056			18-3572				
125 (3cyl) Optimax	B736885	& UP	18-3056			18-3572					

- 1 Models with aluminum upper pump housings
- 2 Models with aluminum water pumps
- 3 Models with plastic upper pump housings
- 4 Models with plastic water pumps
- 5 Pump screws without insulators
- 6 Pump screws with insulators
- 7 Models with driveshaft retaining nut

- 8 Models without driveshaft retaining nut
- 9 Models with flush hole
- 10 Models without flush hole
- 11 Models having plastic upper housing use #48752 inset cup
- 12 Units already having a complete pump replacement using 46-46893A 6 should use the 2193818-2529884 serial group for components
- 13 Units already having a complete pump replacement using 46-46893A 6 should use USA 3795658-4126549 serial group for components
- 14 Units which have already had a complete pump replacement with the 46-46893A 6 pump should use the "Early Mariner Impellers" chart for components

MERCURY COOLING SYSTEM APPLICATION

Horsepower	Beginning Serial #	Ending Serial #	Impeller	Impeller Plate	Insert Cup	Upper Housing	Base	Impeller Repair Kit	Thermostat	Upper Kit	Complete Kit
135	2839369	3293233	18-3017	18-3117				18-3217			18-3517
V 135	904646	& UP	18-3017	18-3117	18-3114	18-3116	18-3419	18-3217			—
135 4-STROKE VERADO	B227000	& UP	18-3056			18-3572					18-3407
140	3293234	3502805	18-3017	18-3117				18-3217			18-3517
140	4865678	& UP	18-3017	18-3117	18-3114	18-3116	18-3414	18-3217			18-3517
140 Jet	D082000	& UP	18-3017	18-3117	18-3114	18-3116	18-3419	18-3217			—
150	3502806	4121434	18-3017	18-3117				18-3217			18-3517
150 (6cyl)	9	4121435	4865677	18-3017	18-3117	18-3114	18-3116	18-3414	18-3217		18-3517
150 (6cyl)	10	4121435	4865677	18-3017				18-3414			—
1500 XS (6cyl)	4868648	5327662	18-3017								—
V 150	A904646	& UP	18-3017	18-3117	18-3114	18-3116	18-3419	18-3217			18-3517
V 150	A904645	& BELOW	18-3017	18-3117	18-3114	18-3116	18-3416	18-3217			18-3517
V-135 DFI	G590000	& UP	18-3017								—
V-150 Carb	8	4868998	A904645	18-3017							—
V-150 Carb	7	4868998	A904645	18-3017							—
V-150 Carb, EFI, DFI		A904646	& UP	18-3017							—
V-150XR2, 4, 6 - MAGNUM II, III	8	4868998	& UP	18-3017							—
V150XR2, 4, 6 - MAGNUM II, III	7	4868998	& UP	18-3017							—
150 4-STROKE VERADO (4cyl)	B227000	& UP	18-3056			18-3572				18-3406	18-3407
V 175	6618751	& UP	18-3017	18-3117	18-3114	18-3116	18-3419	18-3217			18-3517
V 175	4301235	6618750	18-3017	18-3117	18-3114	18-3116	18-3416	18-3217			18-3517
V-175 Carb, EFI, DFI		6618751	& UP	18-3017							—
175 4-STROKE VERADO (4cyl)	B227000	& UP	18-3056			18-3572				18-3406	18-3407
V 200	6625221	& UP	18-3017	18-3117	18-3114	18-3116	18-3419	18-3217			18-3517
V-200	8	4839034	6625220	18-3017	18-3117	18-3114	18-3116	18-3416	18-3217		—
V-200	7	4839034	6625220	18-3017							—
V-200 DFI (3.0L)	G386496	G589999	18-3056					18-3214			18-3517
V-200 EFI (3.0L)	T750164	B504988	18-3056								—
V-200 Carb. & EFI (2.5L)	6625221	& UP	18-3017								—
V-200 DFI (3.0L)	G590000	T598999	18-3056			18-3572					—
V-200 DFI (3.0L)	T590000	B504988	18-3056			18-3572					—
V-200 DFI (3.0L)	B504989	& UP	18-3056			18-3572					18-3407
200 4-STROKE VERADO (4cyl)	B517159	& UP	18-3056			18-3572				18-3406	18-3407
200 4-STROKE 4.8 INCH TORPEDO	T980000	& UP	18-3056			18-3572				18-3406	18-3407
V 220 LASER	B117316	& UP	18-3017	18-3117	18-3114	18-3116	18-3419	18-3217			18-3517
V-225 (2.4L)	8	5628028	& UP	18-3017							—
V-225 (2.4L)	7	5628028	& UP	18-3017							—
V-225 (3.0L) CARB & EFI	D280813	G760299	18-3056								—
V-225 (3.0L) CARB & EFI	G760300	T408999	18-3056			18-3571					—
V-225 (3.0L) EFI	T409000	B504988	18-3056			18-3571					—
V-225 DFI	G590000	T598999	18-3056			18-3571					—
V-225 DFI	T599000	B504988	18-3056			18-3571					—
V-225 DFI	B504989	& UP	18-3056			18-3571					18-3407
V-225 Pro XS	B104549	B752546	18-3056			18-3571					—
V-225 Pro XS	B752547	& UP	18-3056			18-3571					18-3407
225 4-STROKE VERADO 4.8 INCH TORPEDO	T980000	& UP	18-3056			18-3572					18-3407
V-250 (3.0L) EFI	G129222	T408999	18-3056			18-3571					—
V-250 (3.0L) EFI	T409000	B504988	18-3056			18-3572					—
V-250 DFI	B528615	& UP	18-3056			18-3572					18-3407
V-250 Pro XS	B426561	B752546	18-3056			18-3571					—
V-250 Pro XS	B752547	& UP	18-3056			18-3572					18-3407
250 4-STROKE VERADO 4.8 INCH TORPEDO	T980000	& UP	18-3056			18-3572					18-3407
275 4-STROKE VERADO 4.8 INCH TORPEDO	T980000	& UP	18-3056			18-3572					18-3407
300 4-STROKE VERADO 4.8 INCH TORPEDO	B517434	& UP	18-3056			18-3572					18-3407
MARK 5	574128	786612	18-3012								—
MARK 6, 6A	888005	& UP	18-3012								—
MARK 50	ALL	& UP	18-3007								—
MARK 55	831021	& UP	18-3007								—
MARK 55A	1227131	& UP	18-3007								—
MARK 58 E, MARK 58A (M&E)	1139538	& UP	18-3007								—
9	OG129222	& UP	18-3056	18-3117	18-3114	18-3116	18-3419	18-3214			18-3517
XR4/Magnum II	ALL		18-3017					18-3217			—

1 Models with aluminum upper pump housings
 2 Models with aluminum water pumps
 3 Models with plastic upper pump housings
 4 Models with plastic water pumps
 5 Pump screws without insulators
 6 Pump screws with insulators
 7 Models with driveshaft retaining nut

8 Models without driveshaft retaining nut
 9 Models with flush hole
 10 Models without flush hole
 11 Models having plastic upper housing use #48752 insert cup
 12 Units already having a complete pump replacement using 46-46893A 6 should use the 2193818-2529894 serial group for components
 13 Units already having a complete pump replacement using 46-46893A 6 should use USA 3795658-4126549 serial group for components
 14 Units which have already had a complete pump replacement with the 46-46893A 6 pump should use the "Early Mariner Impellers" chart for components

ALL PISTONS ARE SUPPLIED COMPLETE WITH PISTON RINGS, WRIST PIN AND CIRCLIPS.

MARINER (JAPANESE MODELS) Sierra Piston Kit Contents (See Application Charts for Specific Applications)

Model / HP	Cyl.	Bore Size	Piston	OEM Part #	Piston Ring	OEM Part #
0.9 / 15	2	std	18-4135	761-7982M, 761-7982T, 761-7134M, 761-7133M, 761-7131M	18-3976	39-15329M, 39-15320T
48	2	std	18-4136	761-8484M, 761-7198M, 761-7197M, 761-7196M	—	—

MARINER PISTON RINGS - JAPANESE MODELS

.25mm O.S.	O.E. #	.25mm O.S.	O.E. #	.25mm O.S.	O.E. #	.50mm O.S.	O.E. #
18-3977	39-18939M, 39-18939T	18-3986	39-81096M	18-3992	39-83196M	18-3978	39-15322M

MARINER PISTON AND RINGS APPLICATION - JAPANESE MODELS

Model	Ser# Code	Ser #	Standard Piston	.25mm Piston	.50mm Piston	Standard Rings	.25mm Rings	.50mm Rings	Qty. Req'd
9.9	682	ALL	18-4135	—	—	18-3976	18-3977	18-3978	2
15C	684	ALL	18-4135	—	—	18-3976	18-3977	18-3978	2
30A	689	ALL	18-4136	—	—	—	—	—	2
20C, 25A	6A9	ALL	—	—	—	—	18-3986	—	2
25C	695	ALL	—	—	—	—	18-3986	—	2
28	664	ALL	—	—	—	—	18-3986	—	2
48	670	S-02941 & Up / L33132 & UP	—	—	—	—	18-3992	—	2
W48	670	M 002731 & Up / ML 314101 & Up	—	—	—	—	18-3992	—	2
60	675	E 00101-001170 / EL 30101-304180	—	—	—	—	18-3992	—	2

MERCURY / MARINER Sierra Piston Kit Contents (See Application Charts for Specific Applications)

Model / HP	Cyl.	Bore Size	Piston	OEM Part #	Piston Ring	OEM Part #	Circlips	OEM Part #
2 RING PISTONS - HIGH DOME								
35-140	2-6	2.875 / Std.	—	774-9137A12	18-3918	39-817096A6	18-4294	40-52035
35-140	2-6	2.680 / .015	—	774-9137A13	18-3919	39-817096A16	18-4294	40-52035
35-140	2-6	2.905 / .030	—	774-9137A14	18-3920	39-817096A26	18-4294	40-52035
2 RING PISTONS - LOW DOME								
35-140	2-6	2.875 / Std.	—	774-9137A9	18-3918	39-817096A6	18-4294	40-52035
35-140	2-6	2.680 / .015	18-4515	774-9137A10	18-3919	39-817096A16	18-4294	40-52035
35-140	2-6	2.905 / .030	—	774-9137A11	18-3920	39-817096A26	18-4294	40-52035
3 RING PISTONS - HIGH DOME								
35-140	2-6	2.675 / Std.	—	776-8896A3	① 18-3902	39-78816A12, 39-45155A12	18-4294	40-52035
35-140	2-6	2.890 / .015	—	776-8897A2	18-3916	39-78811A12, 39-45204A12	18-4294	40-52035
35-140	2-6	2.905 / .030	—	776-8898A2	② 18-3917	39-88392A12, 39-88392	18-4294	40-52035
3 RING PISTONS - LOW DOME								
35-140	2-6	2.875 / Std.	—	776-8600A9	① 18-3902	39-78816A12	18-4294	40-52035
35-140	2-6	2.890 / .015	—	776-9095A1	② 18-3916	39-78811A12, 39-45204A12	18-4294	40-52035
35-140	2-6	2.905 / .030	18-4156	776-9096A1	18-3917	39-88392A12, 39-88392	18-4294	40-52035
2 RING PISTONS - CROSSFLOW								
40-50	4	2.565 / Std.	18-4620	780-9229A7, 743-5172A6, 743-3193A4, 743-3193A2	18-3966	39-18653A12	18-4294	40-52035
40-50	4	2.580 / .015	18-4621	780-9229A10, 743-3366A2, 743-3366A1	18-3967	39-18653A1	18-4294	40-52035
40-50	4	2.595 / .030	18-4622	780-9229A11, 743-7716A2	18-3968	39-18653A2	18-4294	40-52035
50-80	3	2.875 / Std.	—	783-9613A1	18-4019	39-19721A5	18-4294	40-52035
50-60	3	2.890 / .015	18-4017	783-9613A2, 783-9613T2	18-4020	39-19721A1	18-4294	40-52035
50-60	3	2.905 / .030	18-4018	783-9613A3, 783-9613T3	18-4021	39-19721A2	18-4294	40-52035
70-115	3-4	3.375 / Std.	18-4623	777-815965T4, 777-815965A4	18-3979	39-96170A12	18-4294	40-52035
70-115	3-4	3.390 / .015	18-4624	777-815965A5	—	39-96170A3	18-4294	40-52035
70-115	3-4	3.405 / .030	18-4625	777-815965A6	18-3981	39-96170A4	18-4294	40-52035
75-125	3-4	3.500 / Std.	18-4626	2704-826191T4, 2704-826191A4, 2704-826191A6, 2704-821896A6, 2704-812896A2	18-3982	39-822321A12, 39-824905A12	18-4294	40-52035
75-125	3-4	3.515 / .015	18-4627	2704-821896A3	—	39-822321A1	18-4294	40-52035
75-125	3-4	3.530 / .030	18-4628	2704-821896A4	18-3984	39-822321A2	18-4294	40-52035

3 RING PISTON AND RINGS APPLICATION (REFERENCE ONLY) ①

HP	Cyl.	Beginning Serial No.	Ending Serial No.	Std. Cyl. Dia. (Bore)	Std. Piston	.015 O.S. Piston	.030 O.S. Piston	Std. Rings	.015 O.S. Rings	.030 O.S. Rings
3.5	1	6202173	& UP	2	—	—	—	—	—	—

APPLICATION CONTINUED ON NEXT PAGE

- ① 3 ring high dome NLA, 2 ring piston are now substituted ② 3 ring low dome NLA, 2 ring piston are now substituted
 ③ Chart is for referencing only, pistons received will be 2 ring version
 ④ This product is priced per piece. To order priced per package, please add -9 to the part number.

3 RING PISTON AND RINGS APPLICATION (REFERENCE ONLY)

HP	Cyl.	Beginning Serial No.	Ending Serial No.	Std. Cyl. Dia. (Bore)	Std. Piston	.015 O.S. Piston	.030 O.S. Piston	Std. Rings	.015 O.S. Rings	.030 O.S. Rings
3.6	1	5404657	& UP	2	—	—	—	—	—	—
3.9	1	1655013	2496135	2	—	—	—	—	—	—
4 (1 Cyl)	1	2496136	A809600	2	—	—	—	—	—	—
4.5	1	4107220	& UP	2	—	—	—	—	—	—
7.5	2	2529895	& UP	2	—	—	—	—	—	—
9.8	2	1470349	& UP	2	—	—	—	—	—	—
20	2	1922910	5942040	2.562	—	—	—	—	—	—
25	2	1467499	149931	2.562	—	—	—	—	—	—
30 Jet (42 HP)	4	0C159200	& UP	2.562	18-4620	18-4621	18-4622	18-3966	18-3967	18-3968
30 Jet (40 HP)		0C159200	& UP	2.562	18-4620	18-4621	18-4622	18-3966	18-3967	18-3968
35	2	6445653	& UP	2.875	—	—	—	18-3918	18-3916	18-3920
40 (4 cyl)	4	1279285	1470509	2.562	—	—	—	—	—	—
40	2	2045260	C159199	2.875	—	—	—	18-3918	18-3916	18-3920
40, 402	2	3336258	6445652	2.875	—	—	—	18-3918	18-3916	18-3920
40	4	0C159200	& UP	2.562	18-4620	18-4621	18-4622	18-3966	18-3967	18-3968
45	4	1476510	& UP	2.562	18-4620	18-4621	18-4622	18-3966	18-3967	18-3968
45	4	5531630	0B110788	2.562	18-4620	18-4621	18-4622	18-3966	18-3967	18-3968
45	4	0B110789	& UP	2.562	18-4620	18-4621	18-4622	18-3966	18-3967	18-3968
45 JET	3	D000750	G589999	2.955	—	18-4017	18-4018	18-4019	18-4020	18-4021
50, 500	4	2116318	9428680	2.562	18-4620	18-4621	18-4622	18-3966	18-3967	18-3968
50	3	6428681	B122929	2.875	18-4500	18-4515	—	18-3918	18-3916	18-3920
50	3	B122930	D000749	2.875	18-4500	—	—	18-3918	18-3916	18-3920
50	3	D000750	G589999	2.955	—	18-4017	18-4018	18-4019	18-4020	18-4021
55	3	6428681	B122929	2.875	18-4500	18-4515	—	18-3918	18-3916	18-3920
55	3	B122930	D000749	2.875	18-4500	18-4515	—	18-3918	18-3916	18-3920
55	3	D000750	G589999	2.955	—	18-4017	18-4018	18-4019	—	18-4021
60	6	1303411	1542744	2.562	—	—	—	—	18-4020	—
60	3	6428681	B122929	2.875	—	—	—	18-3918	18-3916	18-3920
60	3	B122930	D000749	2.875	—	—	—	18-3918	18-3916	18-3920
60	3	D000750	G589999	2.955	—	18-4017	18-4018	18-4019	18-4020	18-4021
65, 650	3	3293184	4382056	2.875	—	—	—	18-3918	18-3916	18-3920
65, 650	3	4382057	4571651	2.875	—	—	—	18-3918	18-3916	18-3920
70	3	4571652	A996141	2.875	—	—	—	18-3918	18-3916	18-3920
70 (3 cyl) w/Rod #646-8188461	3	A996142	& UP	3.375	18-4623	18-4624	18-4625	18-3979	—	—
75	4	6432991	& UP	2.875	—	—	—	18-3918	18-3916	18-3920
75 (3 cyl) w/Rod #646-818846	3	C222000	D283221	3.375	18-4623	18-4624	18-4625	18-3979	—	18-3981
75 (3 cyl)	3	D283222	& UP	3.5	18-4626	18-4627	18-4628	18-3982	—	—
80, 850	4	2559001	3493812	2.875	—	—	—	18-3918	18-3916	18-3920
80, 800	4	4631999	6432900	2.875	—	—	—	18-3918	18-3916	18-3920
80 Jet	3	D283222	& UP	3.5	18-4626	18-4627	18-4628	18-3982	—	—
85, 850	4	3493913	4831998	2.875	—	—	—	18-3918	18-3916	18-3920
85, 850	4	4386902	4831998	2.875	—	—	—	18-3918	18-3916	18-3920
85 Mar.	4	4731888	4842728	2.875	—	—	—	18-3918	18-3916	18-3920
90, 900	6	4845301	& UP	2.875	—	—	—	18-3918	18-3916	18-3920
90 (3 cyl) w/Rod #646-818846	3	A9964142	D283221	3.375	18-4623	18-4624	18-4625	18-3979	—	18-3981
90 (3 cyl)	3	D283222	& UP	3.5	18-4626	18-4627	18-4628	18-3982	—	—
95	6	1869776	2318585	2.875	—	—	—	18-3918	18-3916	18-3920
100 SS	6	2318586	2836018	2.875	—	—	—	18-3918	18-3916	18-3920
100 BP	6	2399698	3253111	2.875	—	—	—	18-3918	18-3916	18-3920
100 (4 cyl) w/Rod #646-818846	4	B209468	D283221	3.375	18-4623	18-4624	18-4625	18-3979	—	18-3981
100 (4cyl)	4	D283222	& UP	3.5	18-4626	18-4627	18-4628	18-3982	—	—
115 1150	6	2836019	5829643	2.875	—	—	—	18-3918	18-3916	18-3920
115 Merc.	6	5829644	B209467	2.875	18-4500	18-4515	—	18-3918	18-3916	18-3920
115 Mar.	6	5738991	5861526	2.875	—	—	—	18-3918	18-3916	18-3920
115 Mar.	6	5861527	C100000	2.875	18-4500	18-4515	—	18-3918	18-3916	18-3920

APPLICATION CONTINUED ON NEXT PAGE

3 RING PISTON AND RINGS APPLICATION (REFERENCE ONLY)										
HP	Cyl.	Beginning Serial No.	Ending Serial No.	Std. Cyl. Dia. (Bore)	Std. Piston	.015 O.S. Piston	.030 O.S. Piston	Std. Rings	.015 O.S. Rings	.030 O.S. Rings
115 (4 cyl) w/Rod #546-818845	4	C100000	D283221	3.375	18-4623	18-4624	18-4625	18-3979	—	18-3981
115 (4cyl)	4	D283222	& UP	3.5	18-4626	18-4627	18-4628	18-3982	—	—
125 BF	6	2641855	3253111	2.875	—	—	—	18-3915	18-3916	18-3920
135	6	2839369	3283233	2.875	—	—	—	18-3918	18-3916	18-3920
140 1400	6	3293234	3502805	2.875	—	—	—	18-3915	18-3916	18-3920
140 1400	6	4865678	& UP	2.875	18-4500	18-4515	—	18-3918	18-3916	18-3920
150 1500	6	3502806	5327622	2.875	18-4500	18-4515	—	18-3918	18-3916	18-3920

Chart is for referencing only, pistons received will be 2 ring version

2 RING INLINE PISTON & RINGS APPLICATION													
HP	Cyl.	Beginning Serial No.	Ending Serial No.	Pistons			Port			Piston Rings			
				Dia. (Bore)	Std. (Port)	Std.	.015" O.S.	Std.	.030 O.S.	Std.	.015" O.S.	.030 O.S.	
105 JET	V-6	D082000	& UP	3.125	—	—	—	18-4013	—	—	18-3921	18-3922	18-3923
V-135	V-6	A904646	C239552	3.125	—	—	—	18-4560	—	—	18-4575	18-3921	18-3922 18-3923
V-135 (w/ rod 844-8141)	V-6	C239553	G960499	3.125	—	—	—	18-4013	—	—	18-3921	18-3922 18-3923	
V-135 (2.5L) (w/o rod 636-8141)	V-6	C239553	G960499	3.125	—	—	—	18-4560	—	—	18-4575	18-3921 18-3922 18-3923	
V-140 JET	V-6	D082000	G960499	3.5	18-4635	18-4636	18-4637	18-4638	NA	NA	18-3962	—	18-3994
V-140 JET	V-6	G960500	UP	3.5	18-4635	18-4636	18-4637	18-4638	NA	NA	18-3962	—	18-3994
V-150 MAR	V-6	5600162	6038680	3.125	—	—	—	18-4560	—	—	18-4575	18-3921 18-3922 18-3923	
V-150 MAR	V-6	6038681	C239552	3.125	—	—	—	18-4560	—	—	18-4575	18-3921 18-3922 18-3923	
V-150, 150, 1500	V-6	4668988	6042945	3.125	—	—	—	18-4560	—	—	18-4575	18-3921 18-3922 18-3923	
V-150	V-6	6042946	C239552	3.125	—	—	—	18-4560	—	—	18-4575	18-3921 18-3922 18-3923	
V-150 (w/ rod 544-8141)	V-6	C239553	G960499	3.125	—	—	—	18-4013	—	—	18-3921 18-3922 18-3923		
V-150 (2.5L) (w/o rod 636-8141)	V-6	C239553	G960499	3.125	—	—	—	18-4560	—	—	18-4575	18-3921 18-3922 18-3923	
V-150 EFI XRE MAGIII	V-6	D082000	G960499	3.5	18-4635	18-4636	18-4637	18-4638	NA	NA	18-3962	—	—
V-150 XR4 MAGIII	V-6	B242885	C239552	3.375	—	—	—	18-4565	18-4570	—	—	18-3924 18-3925	—
V-150 XR4 MAGIII	V-6	C239553	D081999	3.375	—	—	—	18-4565	—	—	—	18-3924 18-3925	—
V-175, 175, 1750	V-6	4301235	6618750	3.125	—	—	—	18-4560	—	—	18-4575	18-3921 18-3922 18-3923	
V-175	V-6	6618751	C239552	3.375	—	—	—	—	—	—	18-3927	—	—
V-175	V-6	C239553	D081999	3.375	—	—	—	—	—	—	18-3924 18-3925	—	—
V-175	V-6	D082000	G960499	3.5	18-4635	18-4636	18-4637	18-4638	NA	NA	18-3962	—	18-3994
V-175	V-6	G960500	& UP	3.5	18-4635	18-4636	18-4637	18-4638	NA	NA	18-3962	—	18-3994
V-175 XRI EFI	V-6	D000750	D081999	3.5	18-4635	18-4636	18-4637	18-4638	NA	NA	18-3962	—	18-3994
V-175	V-6	D000750	D081999	3.5	18-4635	18-4636	18-4637	18-4638	NA	NA	18-3962	—	18-3994
V-175 XRI EFI	V-6	D082000	G303045	3.5	18-4635	18-4636	18-4637	18-4638	NA	NA	18-3962	—	18-3994
V-175 XRI EFI	V-6	G303046	& UP	3.5	18-4635	18-4636	18-4637	18-4638	NA	NA	18-3962	—	18-3994
V-200, 2.00L, 2000	V-6	4839034	6203990	3.375	—	—	—	—	—	—	18-3927	—	—
V-200 (2.4L)	V-6	6203991	C291519	3.375	—	—	—	—	—	—	18-3927	—	—
V-200 (2.5L) (w/ rod #544-818141)	V-6	C291520	D081999	3.5	18-4635	18-4636	18-4637	18-4638	NA	NA	18-3962	—	18-3994
V-200 (2.5L)	V-6	D082000	& UP	3.5	18-4635	18-4636	18-4637	18-4638	NA	NA	18-3962	—	18-3994
V-200 XRI EFI	V-6	C100861	C291519	3.375	—	—	—	—	—	—	18-3927	—	—
V-200 XRI EFI	V-6	C291520	G960499	3.5	18-4635	18-4636	18-4637	18-4638	NA	NA	18-3962	—	18-3994
V-225	V-6	B117316	UP	3.375	—	—	—	—	—	—	18-3927	—	—
V-225	V-6	5628028	D280812	3.375	—	—	—	—	—	—	18-3927	—	—
V-225 (3.0L)	V-6	D280813	UP	3.625	18-4639	18-4640	18-4641	18-4642	—	—	18-4644 18-4050 18-4051 18-4052		

SIERRA V-6 PISTON KIT CONTENTS (SEE APPLICATION CHARTS FOR SPECIFIC APPLICATIONS)

Model / HP	Cyl.	Bore Size	Piston	OEM Part #	Piston Ring	OEM Part #	Wrist Pin	Circlips
135, 150 2 Liter	V-6	3.125 / Std. (port)	—	765-7442T32	18-3921	39-93481A12	18-4287	N.S.S.
135, 150 2 Liter	V-6	3.125 / Std. (std)	—	765-7441T32	18-3921	39-93481A12	18-4287	N.S.S.
135, 150 2 Liter	V-6	3.140 / .015 (port)	—	765-7444A11	18-3922	39-78918A4	18-4287	N.S.S.
135, 150 2 Liter	V-6	3.140 / .015 (std)	18-4013	765-7443A11	18-3922	39-78918A4	18-4287	N.S.S.
135, 150 2 Liter	V-6	3.155 / .030 (port)	—	765-7446A11	18-3923	39-85636A4	18-4287	N.S.S.

4 of — = 1 of 39-21665A12
 4 of 18-3902 = 1 of 39-78816A12
 4 of 18-3916 = 1 of 39-78811A12
 4 of 18-3917 = 1 of 39-88392A12
 3 of 18-3918 = 1 of 39-817096A6

3 of 18-3919 = 1 of 39-817096A16
 3 of 18-3920 = 1 of 39-817096A26
 6 of 18-3921 = 1 of 39-93481A12
 2 of 18-3922 = 1 of 39-78918A4
 2 of 18-3923 = 1 of 39-85636A4

6 of 18-3924 = 1 of 39-16487A12
 2 of 18-3925 = 1 of 39-815267A4
 6 of 18-3966 = 1 of 39-18653A12
 6 of 18-3968 = 1 of 39-18653A2
 6 of 18-3967 = 1 of 39-18653A1

3 of 18-4019 = 1 of 39-19721A6
 6 of 18-3982 = 1 of 39-822321A12
 6 of 18-4050 = 1 of 39-827179A12
 6 of 18-3927 = 1 of 39-813011A12

APPLICATION CONTINUED ON NEXT PAGE

SIERRA V-6 PISTON KIT CONTENTS (SEE APPLICATION CHARTS FOR SPECIFIC APPLICATIONS)

Model / HP	Cyl.	Bore Size	Piston	OEM Part #	Piston Ring	OEM Part #	Wrist Pin	Circlips
135, 150 2 Liter	V-6	3.155 / .030 (std)	—	765-7445T11	18-3923	39-85636A4	18-4287	N.S.S.
135-175	V-6	3.125 / Std. (port)	—	765-7442A3, A36	18-3921	39-93481A12	18-4287	N.S.S.
135-175	V-6	3.125 / Std. (std)	18-4545	765-7441A3, A36	18-3921	39-93481A12	18-4287	N.S.S.
135-175	V-6	3.140 / .015 (port)	—	765-7442A2, A12	18-3922	39-78918A4	18-4287	N.S.S.
135-175	V-6	3.140 / .015 (std)	18-4560	765-7443A2, A12	18-3922	39-78918A4	18-4287	N.S.S.
135-175	V-6	3.155 / .030 (port)	—	N/A	18-3923	39-85636A4	18-4287	N.S.S.
135-175	V-6	3.155 / .030 (std)	18-4575	N/A	18-3923	39-85636A4	18-4287	N.S.S.
175-225	V-6	3.375 / Std. (port)	—	766-8667A41/ T41	18-3927	39-813011A12	18-4287	N.S.S.
175-225	V-6	3.375 / Std. (std)	—	766-8666A41/ T41	18-3927	39-813011A12	18-4287	N.S.S.
175-225	V-6	3.390 / .015 (port)	—	766-8667A36/ A43	18-3925	39-815267A4	18-4287	N.S.S.
175-225	V-6	3.390 / .015 (std)	—	766-8666A36/ A43	18-3925	39-815267A4	18-4287	N.S.S.
175-225	V-6	3.405 / .030 (port)	—	NLA	—	NLA	18-4287	N.S.S.
150 XR4/MAG II	V-6	3.375 / Std. (port)	—	766-8667A42/ T42	18-3924	39-18487A12	18-4287	N.S.S.
150 XR4/MAG II	V-6	3.375 / Std. (std)	—	766-8666A42/ T42	18-3924	39-18487A12	18-4287	N.S.S.
150 XR4/MAG II	V-6	3.390 / .015 (port)	18-4585	766-8667A36/ A43	18-3925	39-815267A4	18-4287	N.S.S.
150 XR4/MAG II	V-6	3.390 / .015 (std)	—	766-8666A36/ A43	18-3925	39-815267A4	18-4287	N.S.S.
150 XR4/MAG II	V-6	3.405 / .030 (port)	18-4580	NLA	—	NLA	18-4287	N.S.S.
140-200, XR6/MAG III	V-6	3.500 / Std. (port)	18-4635	785-9737T9	18-3982	39-822321A12	18-4287	N.S.S.
140-200, XR6/MAG III	V-6	3.500 / Std. (std)	18-4636	785-9738T9	18-3982	39-822321A12	18-4287	N.S.S.
140-200, XR6/MAG III	V-6	3.515 / .015 (port)	18-4637	785-9737A10	—	39-822321A1	18-4287	N.S.S.
140-200, XR6/MAG III	V-6	3.515 / .015 (std)	18-4638	785-9738T10	—	39-822321A1	18-4287	N.S.S.
225 (3.0L)	V-6	3.6265 / Std. (port)	18-4639	700-85639AT1	18-4050	39-827179A12	18-4287	N.S.S.
225 (3.0L)	V-6	3.6265 / Std. (std)	18-4640	700-856295T1	18-4050	39-827179A12	18-4287	N.S.S.
225 (3.0L)	V-6	3.6415 / .015 (port)	18-4641	700-87657A2	18-4051	39-826293A12	18-4287	N.S.S.
225 (3.0L)	V-6	3.6415 / .015 (std)	18-4642	700-87657A2	18-4051	39-826293A12	18-4287	N.S.S.
225 (3.0L)	V-6	3.6565 / .030 (port)	18-4643	700-87657A2	18-4052	39-826297A12	18-4287	N.S.S.
225 (3.0L)	V-6	3.6565 / .030 (std)	18-4644	700-87657A2	18-4052	39-826297A12	18-4287	N.S.S.

4 of — = 1 of 39-21665A12
 4 of 18-3902 = 1 of 39-78816A12
 4 of 18-3916 = 1 of 39-78811A12
 4 of 18-3917 = 1 of 39-88392A12
 3 of 18-3918 = 1 of 39-817096A5

3 of 18-3919 = 1 of 39-817096A16
 3 of 18-3920 = 1 of 39-817096A26
 6 of 18-3921 = 1 of 39-93481A12
 2 of 18-3922 = 1 of 39-78918A4
 2 of 18-3923 = 1 of 39-85636A4

6 of 18-3924 = 1 of 39-18487A12
 2 of 18-3925 = 1 of 39-815267A4
 6 of 18-3966 = 1 of 39-18653A12
 6 of 18-3968 = 1 of 39-18653A2
 6 of 18-3967 = 1 of 39-18653A1

3 of 18-4019 = 1 of 39-19721A6
 6 of 18-3982 = 1 of 39-822321A12
 6 of 18-4050 = 1 of 39-827179A12
 6 of 18-3927 = 1 of 39-813011A12

Ⓢ For chrome bore blocks

PKG. OF 200



NEEDLE BEARINGS

NEEDLE BEARINGS



16 Needles - Multi re-use cage



18-1194
ROD BEARING

Replaces: 31-17514A1, 8M004528, 31-17514A2, 31-8M0045428, 31-17514, 31-67526A1, 31-67526A2, 31-67526, 31-821146A1, 31-814337A1, 879366
 For: 30-60HP 2&3 Cyl., Mag II, V-135-200 & XR4

Part #	Replaces:	Description
18-4036	29-47270	Piston End
18-4037	29-71422	Main Bearing

Part #	Replaces	Description
18-4038	31-62596A1, 31-63075A1, 31-61424A2, 31-58659A1, 31-55332A1, 31-47245A1	Crank End - w/o Cage
18-4039	31-17514A2, 31-8M0045430	Crank End - w/o Cage

18-1153
BALL BEARING

Replaces: 30-63326, 30-63326T, 30-49313, 30-54215, 30-20464



18-1154
BALL BEARING

Replaces: 30-63742



18-1196
UPPER MAIN BEARING

Replaces: 31-74248T, 31-74248
 For: V135, 150, 175, 200 (carb)



18-1345
BALL BEARING

Replaces: 30-67923T, 30-67923, 30-41421
 For: 135-225 HP V-6



Ⓢ This product is priced per piece. To order priced per package, please add -9 to the part number.



18-1346
BALL BEARING

Replaces: 30-43011T, 30-43011
For: 75-125 3 & 4 cyl.



18-1398
BALL BEARING

Replaces: 30-72961, 30-20861
For: 3.5-9.8 HP & Mercury
belt driven water pump

HP	Cyl.	Req. S/N	End S/N	Center Main Bearing	Con. Rod Crank End	Main Valve Block	Con. Rod Piston End	Lower Main Bearing	Lower O-ring	Lower Oil Seal	Lower Oil Seal 2	Upper O-ring	Upper Main Bearing	Upper Oil Seal	Upper Roller Bearing
3.5		9202173	& UP	—	—	—	—	—	—	—	—	18-7152	18-1398	—	—
3.6		5404657	& UP	—	—	—	—	18-1398	—	—	—	18-7152	18-1398	—	—
3.9	1	1655013	2499135	—	—	—	—	18-1398	—	—	—	18-7152	18-1398	—	—
4 (40)	1	2498196	4107219	—	—	—	—	18-1398	—	—	—	18-7152	18-1398	—	—
4	1	5505532	& UP	—	—	—	—	18-1398	—	—	—	18-7152	18-1398	—	—
4 (40)	2	5589202	& UP	—	—	—	—	18-1398	18-7102	—	—	—	—	18-0516	—
4.5 (4.5, 45)	1	4107220	& UP	—	—	—	—	18-1398	—	—	—	18-7152	18-1398	—	—
4.5	1	5585532	& UP	—	—	—	—	18-1398	—	—	—	18-7152	18-1398	—	—
6 (60)		1916139	2529894	—	—	—	—	18-1398	—	—	—	19-7459	18-1398	—	—
6		A197112	T800749	—	—	—	—	—	—	—	—	—	—	—	—
7.5 (75)		2529895	5226834	—	—	—	—	18-1398	—	—	—	18-7152	18-1398	—	—
10 (100)		1290910	& UP	—	—	—	—	—	—	—	—	—	—	—	—
10 (MARATHON, XP10, SEAPRO)		D038000	& UP	—	—	—	—	—	—	—	—	—	—	—	—
15 (150)		1290910	1499331	—	—	—	—	—	—	18-2026	18-2026	—	18-1153	—	—
15		B292414	& UP	—	—	—	—	—	—	—	—	—	—	—	—
15 (EXPORT SEAPRO)		G044365	G202749	—	—	—	—	—	—	18-0537	—	—	—	—	—
15 (SEAPRO)		G438000	& UP	—	—	—	—	—	—	—	—	—	—	—	—
15 (SUPER)		B238464	G202749	—	—	—	—	—	—	18-0537	—	—	—	—	—
18		5837437	6239752	—	—	—	—	—	—	18-0537	—	—	—	—	—
20		1558310	2296266	—	—	—	—	—	—	18-2026	18-2026	—	18-1153	—	—
20 (200, 20)		2296267	& UP	—	—	—	—	—	—	—	—	—	—	—	—
25 (KF 9)	4	377150	495761	—	—	—	—	—	—	—	—	—	—	—	—
10 (MK10)	2	1057894	1122327	—	—	—	—	—	—	—	—	—	—	—	—
15 (MK15)	2	1200114	1287384	—	—	—	—	—	—	—	—	—	—	—	—
18 (MK20)	2		ALL	—	—	—	—	—	—	—	—	—	—	—	—
20 (MK25)	2	860979	& UP	—	—	—	—	—	—	—	—	—	—	—	—
22 (MK28)	2	1158546	1238089	—	—	—	—	—	—	—	—	—	—	—	—
30 (MK30)	4		ALL	—	—	—	—	—	—	—	—	—	—	—	—
35 (MK35)	4	1217222	1271884	—	—	—	—	—	—	—	—	—	—	—	—
25 (MK40)	4	711400	& UP	—	—	—	—	—	—	—	—	—	—	—	—
40 (MK50)	4		ALL	—	—	—	—	—	—	—	—	—	—	—	—
40 (MK55)	4	831021	& UP	—	—	—	—	—	—	—	—	—	—	—	—
45 (MK58)	4	1139538	& UP	—	—	—	—	—	—	—	—	—	—	—	—
60 (MK75)	6		ALL	18-4037	—	—	—	—	—	—	—	—	—	—	—
70 (MK75)	6	1143038	& UP	18-4037	—	—	—	—	—	—	—	—	—	—	—
3.5 / 3.6 / 3.9	1		ALL	—	—	—	—	18-1398	—	—	—	—	18-1398	—	—
9.8	2	1865779	& UP	—	—	—	—	18-1398	—	—	—	—	18-1398	—	—
20	2	1292910	6443972	—	—	—	—	18-1153	—	—	—	—	18-1153	—	—
20 (20 XD)	2	6443973	B114230	—	—	—	—	—	—	18-0537	—	—	—	—	—
25	2	1467499	1499331	—	—	—	—	—	—	—	—	—	—	—	—
25	2	5705532	6241936	—	—	—	—	—	—	18-0537	—	—	—	—	—
25 (250)		1290910	1499331	—	—	—	—	—	—	—	—	—	—	—	—
30 (300)	4	1271965	1448139	—	—	—	—	18-1154	18-7151	—	18-2016	18-7151	18-1154	—	—
30 (64cc)	2	G053314	D589999	—	18-4039	—	18-4036	18-1154	18-7176	18-2016	—	—	—	—	—
30 (64cc)	2	G590000	T598999	—	18-1194	—	18-4036	—	—	—	—	—	—	—	—
30 JET	4	C159200	& UP	18-4037	—	—	—	18-1154	—	—	—	—	18-1154	—	—

APPLICATION CONTINUED ON NEXT PAGE

HP	Cyl.	Eng. S/N	End S/N	Center Main Bearing	Con. Rod Crank End	Main Valve Block	Con. Rod Piston End	Lower Main Bearing	Lower O-ring	Lower Oil Seal	Lower Oil Seal 2	Upper O-ring	Upper Main Bearing	Upper Oil Seal	Upper Rotter Bearing
30 JET	3	G590000	& UP	—	—	—	18-4036	18-1154	—	—	—	—	—	—	—
35 (350, 35A)	4	121722	1448139	—	—	—	—	18-1154	—	—	—	—	18-1154	—	—
35 (350)	2	1571114	1898815	—	—	—	—	18-1154	18-7151	—	—	—	18-1154	—	—
35	2	6445653	B110788	—	—	—	18-4036	18-4036	18-1154	—	—	—	—	—	—
40 (400E, 400M)	4	1279665	1367697	—	—	—	—	18-1154	—	—	—	—	18-1154	—	—
40 (400E, 400M)	4	1384806	1476509	—	—	—	—	—	—	—	—	—	—	—	—
40 (400)	2	2874704	3045259	—	—	—	18-4036	18-4036	18-1154	18-2016	18-2016	—	—	18-2016	—
40 (402)	2	3045260	3336257	—	—	—	18-4036	—	—	—	—	—	—	—	—
40 (402)	3	3336258	4117706	—	—	—	18-4036	—	—	—	—	—	—	—	—
40 (402, 40)	—	4117710	5556229	—	—	—	18-4036	—	18-2016	18-2016	—	—	—	18-2016	—
40	2	5556230	6443972	—	—	—	18-4036	—	—	—	—	—	—	—	—
40	2	G053314	& UP	—	—	—	18-1194	—	18-4036	18-1154	18-2016	—	—	—	—
40	3	G531301	& UP	—	—	—	18-1194	—	18-4036	18-1154	18-2016	—	—	—	—
40	4	C159200	& UP	18-4037	—	—	—	18-1154	18-7161	18-2016	—	—	18-7151	18-1154	—
45 (450)	4	1476510	1531568	—	—	—	—	18-1154	—	18-2016	18-7151	18-1154	18-1154	—	—
45	4	5531630	& UP	18-4037	—	—	—	18-1154	18-7151	18-2016	18-7151	18-1154	18-1154	—	—
45 JET	—	D000750	D589999	—	—	—	18-4036	—	18-4036	18-1154	18-7176	18-2016	—	—	18-2016
45 JET (59 CID)	3	G590000	& UP	—	—	—	18-1194	—	18-4036	18-1154	18-7176	18-2016	—	—	—
50 (500)	4	1421113	1755548	—	—	—	—	18-1154	18-7151	—	18-2016	18-7151	18-1154	18-2016	—
50 (500)	—	1770179	2305100	—	—	—	—	—	—	—	—	—	—	—	—
50 (500, 50)	—	2305151	5193253	—	—	—	—	—	—	—	—	—	—	—	—
50	4	5193259	5531629	18-4037	—	—	—	18-1154	—	—	—	—	—	18-1154	—
50	4	5531630	& UP	18-4037	—	—	—	—	—	—	—	—	—	—	—
50	3	6428681	D000749	18-4037	18-4036	—	18-4036	—	18-7161	18-2016	18-2016	—	—	—	18-2016
50	3	D000750	G589999	—	—	—	18-4036	—	18-4036	18-1154	18-7176	18-2016	—	—	18-2016
50	3	G590000	& UP	—	—	—	18-1194	—	18-4036	18-1154	18-7176	18-2016	—	—	—
55	3	D000750	G589999	—	—	—	18-4036	—	18-4036	18-1154	18-7176	18-2016	—	—	18-2016
55	3	G590000	& UP	—	—	—	18-1194	—	18-4036	18-1154	18-7176	18-2016	—	—	—
60 (600)	4	1303411	1542744	18-4037	—	—	—	18-1154	18-7151	—	18-2016	18-7151	18-1154	18-2016	—
60	3	6428681	D000749	18-4037	18-4036	—	18-4036	—	18-7161	18-2016	18-2016	—	—	—	18-2016
60	3	D000750	G589999	—	—	—	18-4036	—	18-4036	18-1154	18-7176	18-2016	—	—	18-2016
60 (59 CID)	3	G590000	& UP	—	—	—	18-1194	—	18-4036	18-1154	—	—	—	—	—
65 (650)	4	1545745	1765043	18-4037	—	—	—	18-1154	18-7151	—	18-2016	—	—	—	18-2016
65 (650)	4	1765044	2119748	18-4037	—	—	—	—	—	—	—	—	—	—	—
65 (650)	4	2119749	2309310	18-4034	—	—	—	—	—	—	—	—	—	—	—
65 (650)	4	2309311	3293163	18-4037	—	—	—	—	—	—	—	—	—	—	—
65 (650)	3	3293184	4571651	18-4037	18-4036	—	18-4036	—	18-7151	18-2016	18-2016	18-7961	—	—	18-2016
65 (650)	3	8006640	8042349	18-4037	18-4036	—	18-4036	—	—	—	—	—	—	—	—
65 (650)	3	9020074	9135824	18-4037	18-4036	—	18-4036	—	—	—	—	—	—	—	—
65 (650)	3	7013633	7087822	18-4037	18-4036	—	18-4036	—	—	—	—	—	—	—	—
65 JET	—	D283222	& UP	—	—	—	—	18-1346	—	18-2016	—	18-7414	—	—	18-0523
70 (700)	6	1296411	1566239	18-4037	—	—	—	18-1154	18-7151	—	18-2016	18-7151	18-1154	18-2016	—
70	3	4571652	5579016	18-4037	18-4036	—	18-4036	—	18-7161	18-2016	18-2016	—	—	—	18-2016
70	3	5579017	6428680	18-4037	18-4036	—	18-4036	—	—	—	—	—	—	—	—
70 CONNECTING ROD #638-8532-1	3	A996142	C221998	—	—	—	—	18-1346	—	18-2016	—	18-7414	—	—	18-0523
75	4	5432901	& UP	18-4037	18-4036	—	18-4036	18-1154	18-7151	18-2016	18-2016	18-7961	—	—	18-2016
75 CONNECTING ROD #638-8532-1	3	C222000	& UP	—	—	—	—	18-1346	—	18-2016	—	18-7414	—	—	18-0523
75 DFI (1.5L)	—	T980000	B189548	—	—	—	—	18-1346	—	18-2016	—	—	—	—	—
80 (800)	6	1335465	1566239	18-4037	—	—	—	18-1154	18-7151	—	18-2016	18-7151	18-1154	18-2016	—
80 (800)	4	2559001	2670574	18-4037	18-4036	—	18-4036	18-1154	18-2016	18-2016	18-2016	18-7961	—	—	18-2016
80 (800)	4	2783253	3493812	18-4037	18-4036	—	18-4036	—	—	—	—	—	—	—	—
80 (800, 80)	4	4831999	5582561	18-4037	18-4036	—	18-4036	18-1154	18-7161	18-2016	18-2016	18-7961	—	—	18-2016

HP	Cyl.	Eng. S/N	End S/N	Center Main Bearing	Con. Rod Crank End	Main Valve Block	Con. Rod Piston End	Lower Main Bearing	Lower O-ring	Lower Oil Seal	Lower Oil Seal 2	Upper O-ring	Upper Main Bearing	Upper Oil Seal	Upper Roller Bearing
80 (80)	4	5882582	6422900	18-4037	18-4038	—	18-4038	—	—	—	—	—	—	—	—
80 CONNECTING ROD #638-8532-1	3	A996142	C221999	—	—	—	—	18-1346	—	18-2016	—	18-7414	—	18-0523	—
80 JET		D283222	& UP	—	—	—	—	18-1346	—	18-2016	—	18-7414	—	18-0523	—
85 (850, 76 CID)	6	1460999	1464848	18-4037	—	—	—	18-1154	18-7151	—	18-2016	18-2016	—	18-2016	—
85 (850, 90 CID)	6	1566240	1766823	18-4037	—	—	—	18-1346	18-2016	—	18-2016	—	—	18-2016	—
85 (850)	4	3483913	3865694	18-4037	18-4038	—	18-4036	18-1154	18-7161	18-2016	18-2016	18-7961	—	18-2016	—
85 (850)	4	3865695	4831999	18-4037	18-4038	—	18-4036	—	—	—	—	—	—	—	—
90 (900)	6	1766824	1850448	18-4037	—	—	—	18-1154	18-2016	—	18-2016	—	—	18-2016	—
90 (900)	6	1850449	1859775	18-4037	—	—	—	—	—	—	—	—	—	—	—
90 (900, 90)	6	4845301	5594656	18-4037	18-4038	—	18-4036	18-1154	18-7161	18-2016	18-2016	—	—	18-2016	—
90 (90)	6	5084657	& UP	18-4037	18-4038	—	18-4036	—	—	—	—	—	—	—	—
90 (90) CONNECTING ROD #638-8532-1	3	A996142	D283221	—	—	—	—	18-1346	—	18-2016	—	18-7414	—	18-0523	—
95 (950E)	6	1869776	2318585	18-4037	—	—	—	18-1154	18-7151	—	18-2016	—	—	18-2016	—
95 (950E-SS)		1869776	2318585	18-4037	—	—	—	18-1154	18-2016	—	18-2016	—	—	18-2016	—
95 (950E-SS-1)		1869776	2318585	18-4037	—	—	—	—	—	—	—	—	—	—	—
100 (1000)	6	1464949	2318585	18-4037	—	—	—	18-1154	18-7151	—	18-2016	—	—	18-2016	—
100 (1000SS)		2318586	2836018	18-4037	—	—	—	18-1154	18-7151	—	18-2016	—	—	18-2016	—
100 (1000BP)		2399698	2641854	18-4037	—	—	—	—	—	—	—	—	—	—	—
100 (1000BP)		2641855	3253111	18-4037	18-4038	—	18-4036	18-1154	18-7151	18-2016	18-2016	18-7961	—	18-2016	—
100	4	B209468	& UP	—	—	—	—	18-1346	—	—	—	—	—	—	—
105 JET		D820000	& UP	—	18-1194	—	—	18-1345	—	—	—	—	—	—	—
110 (1100E)		1870204	2314855	18-4037	—	—	—	18-1154	18-7151	—	18-2016	—	—	18-2016	—
110 (1100-SS)	6	1870204	2314855	18-4037	—	—	—	18-1154	18-2016	—	18-2016	—	—	18-2016	—
110 (1100E-SS-1)	6	1870204	2314855	18-4037	—	—	—	—	—	—	—	—	—	—	—
115 (1150)	6	2895016	3525440	18-4037	18-4038	—	18-4036	18-1154	18-7151	18-2016	18-2016	18-7961	—	18-2016	—
115 (1150, 115)		3525441	5600966	18-4037	18-4038	—	18-4036	—	—	—	—	—	—	—	—
115	6	5600967	6262960	18-4037	18-4038	—	18-4036	—	—	—	—	—	—	—	—
115	6	6262961	C099999	18-4037	18-4038	—	18-4036	—	—	—	—	—	—	—	—
115 CONNECTING ROD #638-8532-1	4	C100000	D283221	—	—	—	—	18-1346	—	18-2016	—	18-7414	—	18-0523	—
115 OPTIMAX	6	G980500	T178499	—	18-1194	—	—	—	—	—	—	—	—	—	—
125 (1250, 1250BP)	6	2314958	2841854	18-4037	18-4038	—	18-4036	18-1154	18-2016	—	—	18-7961	—	18-2016	—
125 (1250BP)		2641955	3253111	18-4037	18-4038	—	—	—	—	—	—	—	—	—	—
125	4	D283222	& UP	—	—	—	—	18-1346	—	18-2016	—	18-7414	—	18-0523	—
135 (1350)		2893369	3283239	18-4037	18-4038	—	18-4036	18-1154	18-7151	18-2016	18-2016	18-7961	—	18-2016	—
1400		3293234	3502805	18-4037	18-4038	—	18-4036	18-1154	—	—	—	—	—	—	—
1400-140		4865678	& UP	18-4037	18-4038	—	18-4036	—	—	—	—	—	—	—	—
140 JET	V-6	D082000	& UP	—	18-4039	—	—	18-1345	18-0860	18-2016	18-2016	18-0858	—	18-2016	—
V-135 W/ METAL CAGED MAIN BRG	V-6	A904646	C239552	—	18-1194	—	—	—	—	—	—	—	—	—	—
V-135 W/ PLASTIC CAGED MAIN BRG	V-6	A904646	C239552	—	18-1194	—	—	—	—	—	—	—	—	—	—
V-135 CONNECTING ROD #638-8118	V-6	C239553	D082000	—	18-1194	—	—	—	—	—	—	—	—	—	—
V-135	V-6	D082000	& UP	—	18-1194	—	—	—	—	—	—	—	—	—	—
V-135 DF1	V-6	D082000	G760299	—	18-4039	—	—	18-1345	—	—	—	—	—	—	—
V-135 DF1	V-6	G760300	& UP	—	18-1194	—	—	—	—	—	—	—	—	—	—

APPLICATION CONTINUED ON NEXT PAGE

HP	Cyl.	Eng. S/N	End S/N	Center Main Bearing	Con. Rod Crank End	Main Valve Block	Con. Rod Piston End	Lower Main Bearing	Lower O-ring	Lower Oil Seal	Lower Oil Seal 2	Upper O-ring	Upper Main Bearing	Upper Oil Seal	Upper Rotter Bearing
1500-1500XS	V-6	3502808	5327662	18-4037	18-4038	—	18-4036	18-1154	18-7161	18-2016	18-2016	18-7951	—	18-2016	—
1500-1500XS	V-6	8095615	8052549	18-4037	18-4038	—	18-4036	—	—	—	—	—	—	—	—
1500-1500XS	V-6	7010533	7112772	18-4037	18-4038	—	18-4036	—	—	—	—	—	—	—	—
V-150 (V-1500)	V-6	4868998	C100860	—	18-4039	—	—	18-1345	—	18-2016	18-2016	—	—	18-2016	18-1196
V-150	V-6	C100861	C239552	—	18-1194	—	—	18-1345	18-0860	18-2016	18-2016	18-0858	—	18-2016	—
V-150 CONNECTING ROD #636-8118	V-6	C239553	D061999	—	18-1194	—	—	18-1345	18-0860	18-2016	18-2016	18-0858	—	18-2016	—
V-150 CONNECTING ROD #644-818141	V-6	C239553	D061999	—	18-1194	—	—	—	—	—	—	—	—	—	—
V-150 DFI	V-6	D082000	& UP	—	18-1194	—	—	18-1345	18-0860	18-2016	18-2016	18-0858	—	18-2016	—
V-150 EFI	V-6	D082000	& UP	—	18-4039	—	—	18-1345	—	—	—	—	—	—	—
150	V-6	4868998	D061999	—	18-1194	—	—	—	—	—	—	—	—	—	—
XR-4	V-6	G780300	& UP	—	18-1194	—	—	—	—	—	—	—	—	—	—
XR-4	V-6	B242885	C239552	—	18-1194	—	—	—	—	—	—	—	—	—	—
XR-4	V-6	C239553	D061999	—	18-1194	—	—	—	—	—	—	—	—	—	—
XR-6	V-6	D082000	& UP	—	18-4039	—	—	18-1345	—	—	—	—	—	—	—
V-175 (1750)	V-6	4301235	6618750	—	18-4039	—	—	18-1345	—	18-2016	18-2016	—	—	18-2016	18-1196
V-175	V-6	6618751	C239552	—	18-1194	—	—	18-1345	18-0860	18-2016	18-2016	18-0858	—	18-2016	—
V-175	V-6	C239553	D061999	—	18-1194	—	—	18-1345	18-0860	18-2016	18-2016	18-0858	—	18-2016	—
V-175	V-6	D082000	& UP	—	18-1194	—	—	—	—	—	—	—	—	—	—
V-175 XRI	V-6	D000750	D061999	—	18-1194	—	—	18-1345	18-0860	18-2016	18-2016	18-0858	—	18-2016	—
V-175 EFI	V-6	D082000	& UP	—	18-4039	—	—	18-1345	—	—	—	—	—	—	—
V-175	V-6	T178520	& UP	—	18-1194	—	—	18-1345	18-0860	18-2016	18-2016	18-0858	—	18-2016	—
DFI & PRO XS															
175 (1750)	V-6	8058870	& UP	—	18-1194	—	—	—	—	—	—	—	—	—	—
V-200 (V2000)	V-6	4830034	5363917	—	18-1194	—	—	18-1345	—	—	—	—	—	—	—
V-200 (V2000)	V-6	5363918	6073191	—	18-1194	—	—	18-1345	—	18-2016	18-2016	—	—	18-2016	18-1196
V-200 (2.4L)	V-6	6073192	C291519	—	18-1194	—	—	18-1345	18-0860	18-2016	18-2016	18-0858	—	18-2016	—
V-200 (2.5L) CONNECTING ROD #636-8118	V-6	C291520	D061999	—	18-1194	—	—	—	—	—	—	—	—	—	—
V-200 (2.5L) CONNECTING ROD #644-818141	V-6	C291520	D061999	—	18-1194	—	—	—	—	—	—	—	—	—	—
V-200	V-6	D082000	& UP	—	18-4039	—	—	18-1345	—	—	—	—	—	—	—
V-200 EFI	V-6	C100861	C291519	—	18-1194	—	—	18-1345	18-0860	18-2016	18-2016	18-0858	—	18-2016	—
V-200 EFI CONNECTING ROD #644-818141	V-6	C291520	D061999	—	18-1194	—	—	—	—	—	—	—	—	—	—
V-200 EFI CONNECTING ROD #636-8118	V-6	C291520	D061999	—	18-1194	—	—	—	—	—	—	—	—	—	—
V-200 EFI (2.5L)	V-6	D082000	B226999	—	18-4039	—	—	18-1345	—	—	—	—	—	—	—
V-220	V-6	B117316	& UP	—	18-1194	—	—	—	—	—	—	—	—	—	—
V-225	V-6	5628028	D280812	—	18-1194	—	—	18-1345	18-0860	18-2016	18-2016	—	—	18-2016	—
V-225 (225, SEAPRO)	V-6	D280813	& UP	—	18-4039	—	—	18-1345	—	—	—	—	—	—	—
V-225 DFI	V-6	G590000	T325116	—	—	—	—	18-1345	18-0860	—	—	18-7414	—	—	—
V-225	V-6	G129222	& UP	—	—	—	—	18-1345	18-0860	—	—	18-7414	—	—	—
V-250 EFI	V-6	G129222	T325116	—	—	—	—	18-1345	18-0860	—	—	18-7414	—	—	—
V-250	V-6	C101891	& UP	—	18-4039	—	—	18-1345	—	—	—	18-7414	—	18-2016	—
V-250 DFI & PRO XS	V-6	B528615	& UP	—	—	—	—	18-1345	18-0860	—	—	18-7414	—	—	—
V-275	V-6	C101891	& UP	—	—	—	—	—	—	—	—	18-7414	—	—	—
V-3.4L	V-6	5611648	& UP	—	18-4039	—	—	18-1345	—	—	—	18-7414	—	—	—

 <p>18-2144 MOTOR MOUNT Replaces: 67209, 77326, 78687, 78687T Small Diameter Upper Motor Mount Includes: (1) Upper Motor Mount and (1) 1/4" O.D. x 7/8" I.D. Stainless Steel Washer</p>	 <p>18-7901 OIL FILTER Replaces: 825467A1, T1 For: 9.9HP S/N OH000058-OH017099 (1995-98)</p>	 <p>18-7758 OIL FILTER Replaces: 35-877761K01, 35-877761Q01 For: 75/90/115 hp. (S/N 1B366823 (2006) & Up)</p>
 <p>18-7918 OIL FILTER Replaces: 35-883701K01, 35-877769K01 For: Verado 200-300 HP, Inline 6 cylinder</p>	 <p>18-7921 OIL FILTER Replaces: 35-896546T, 35-877767K01 For: Verado 135-200 HP, Inline 4 cylinder</p>	 <p>18-7906-1 OIL FILTER Replaces: 35-822626T7, 35-822626Q15, 35-8226267 Fits: 225 HP (Non-Verado)</p>
 <p>18-7913 OIL FILTER Replaces: 35-822626Q1 For: 8 HP (323cc) 2001-2004 / 9.9 HP (323cc) 1999-2004 / 15 HP. (323cc) 1998 and NEWER / 20 HP. 2008 and NEWER / 30 HP (492cc) 2006 and NEWER</p>	 <p>18-7914 OIL FILTER Replaces: 35-822626Q2, 35-822626Q04, 35-877768K01, 35-822626K04, 35-822626T2, 35-8M0064104, 35-8M0008397 For: 25 HP. (498cc) 1998-2005 / 30 HP. (747cc) 1999-2005 / 40, 50, 60 HP. 1995 and NEWER / 75, 90 Carburelated 2000-2005 / 115 EFI (S/N 1B366822 and BELOW)</p>	 <p>18-1800 OIL RESERVIOR FLOAT SWITCH Replaces: 12886A6</p>

TIMING BELTS

Sierra Timing Belts provide extended durability and smoother performance characteristics required by today's marine engines.

FEATURES:

- Neoprene or Nitrile construction for maximum durability based on application
- Positive Slip Proof engagement
- Fiberglass tension member for excellent flex and elongation behavior
- Chemical and Contaminant Resistance for Long Life
- Meets or Exceeds OEM belt specifications
- Modified Curvilinear or Trapezoidal tooth profile for direct OE fitment/replacement
- Recommended periodic maintenance interval of 5 years or 1000 hours of use
(Note: Timing belt should be inspected every 100 hours and replaced as necessary.)
- Inexpensive insurance to prevent catastrophic engine failure



Part No.	Replaces	Fits
18-15146	8M0072670	25 HP EFI (3 CYL) Fourstroke 0R106999 and Above; 25 HP JET EFI (3 CYL) 0R165086 and Above; 30 HP EFI (3 CYL) Fourstroke 0R106999 and Above
18-15147	835392Q	9.9 HP Fourstroke 0G760300-1B226999; 15 HP Fourstroke 1B227000-1B727495; 15 HP Fourstroke 0G760300-1B226999
18-15148	8M0065179	40 HP (3 CYL) Fourstroke 1C049739 and Above; 40-50-60 HP Fourstroke 1C050252 and Above
18-15149	57-895120	8 HP Fourstroke 0R042475 and Above; 9.9 HP Fourstroke 0R042475 and Above
18-15150	57-895120002	10 HP Carb (2 CYL) Fourstroke 0R575531-0R833819; 15 HP Carb (2 CYL) Fourstroke 0R235949-0R833819; 15 HP Carb Fourstroke JCI 0R558208-0R833819; 15 HP SEAPRO Fourstroke 0R051685-0R123564; 15 HP SEAPRO Fourstroke 0R123565 and Above; 20 HP Carb (2 CYL) Fourstroke 0R235168-0R833819



18-0663
PLENUM GASKET KIT
 Fits: Mercury 75 4-Stroke (2000-03),
 90 4-Stroke (2000 & Up),



18-4334
POWERHEAD GASKET SET
 Replaces: 27-41499A87
 For: 15HP, 18HP, 20HP & 25HP outboards

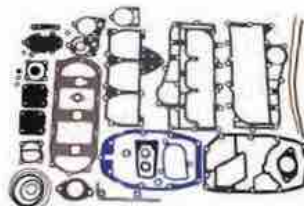

18-4326
POWERHEAD GASKET SET
 Replaces: 27-43779A87
 For: 50,55,60 HP, 3 cyl.

— CONTAINS —

Part #	Desc.	O.E.#	Qty.
18-4261	Fiber Washer	19643	1
18-0320	Gasket	27-13937-6	6
18-0324	Gasket	27-15172-3	3
18-0670	Gasket	27-43007 5	1
18-2565	Gasket	27-43047-1	1
18-2945	Drain Screw Gasket	12-20260	3
18-7164	O-Ring	25-33466	1
18-7196	O-Ring	25-45710	1
18-7167	O-Ring	25-45254	1
18-0182	Gasket	27-62386	1
18-2740	Cylinder Block Gasket	27-43005 7	1
18-2741	Gasket	27-43004 7	2
18-0339	Thermostat Gasket	27-43006-2	1
18-0341	Exhaust Gasket	27-43008, 27-430062, 27-430083, 27-430085	1
18-2563	Gasket	27-43034-1	1
NSS	Gasket	22-43033-1	1
18-2566	Impeller Gasket	27-817277	1
18-7105	O-Ring	25-62705	2
18-7414	O-Ring	25-64067	1
18-0858	O-Ring	25-54029	1
18-7803	Diaphragm Kit	21-857005A1	1



18-4336
POWERHEAD GASKET SET
 Replaces: 27-43004A99, 27-43004A90, 27-43004A86
 For: 70, 80, 90HP 3 cyl outboards

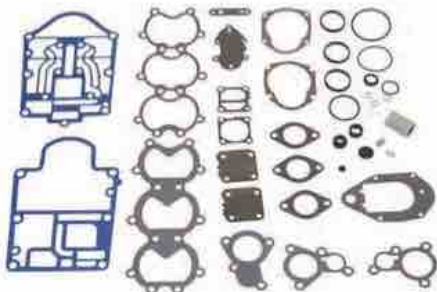

18-4337
POWERHEAD GASKET SET
 Replaces: 27-812867A97, 27-812867A96, 27-812867A91
 For: 45 Jet, 50HP, 55HP, 60HP, 3. cyl outboards

CONTAINS —

Part #	Desc.	O.E.#	Qty.
18-7152	O-Ring	25-20863	1
18-2945	Drain Screw Gasket	12-19183	3
18-7173	O-Ring	25-30224	1
18-0182	Thermostat Gasket	27-62386	1
18-2719	Induction Manifold Gasket	27-812869	1
18-2721	Adapter Plate Gasket	27-627264	1
18-2729	Thermostat Cover Gasket	27-812867 2	1
18-2749	Thermostat Gasket	27-812867 1	1
NSS	Exhaust Gasket	27-812866	1
18-0319	Exhaust Cover Gasket	27-828533	1
18-0622	Lower Wear Plate Gasket	27-19701	1
18-0345	Water Pump Gasket	27-722189	1
18-2593	Water Pump Gasket	N/A	1
18-2566	Impeller Gasket	27-817277	1
18-7176	O-Ring	25-90011	1
18-7950	O-Ring	25-45258	1
18-7817	Diaphragm Kit	21-857005A1	1

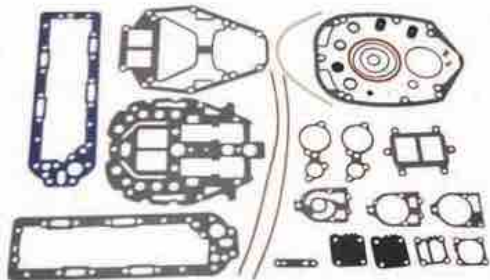

18-4338
POWERHEAD GASKET SET
 Replaces: 27-814754A00
 For: V-135, V-150 DFI outboards

CONTAINS —

Part #	Desc.	O.E.#	Qty.
18-2506-1	Exhaust Plate Gasket	27-99176-3	1
18-0850	O-Ring	25-62709	1
18-0858	O-Ring	25-54029	1
18-0182	Thermostat Gasket	27-62386	2
18-0642	Divider Plate Gasket	27-19050-3	1
18-2735	Divider Plate Gasket	27-190506	1
18-0936	Gasket	27-78690	2
18-2511	Gasket	27-99173-2	1
18-0643	Powerhead Base Gasket	27-183071	1
18-2919	Gasket	27-42631-1	1
18-7176	O-Ring	25-90011	1
18-2914	Water Pump Gasket	27-85808-1	1
18-2915	Water Pump Gasket	27-85809-1	1
18-7159	O-Ring	25-31534	1
18-7153	O-Ring	25-25439	1
18-7174	O-Ring	25-45711	2
18-0970	Fuel Pump Gasket	27-98769-1	1
18-0135	Adapter Cover Gasket	27-78246	1
18-2514	Crankcase Gasket	27-53650	2

GASKET SET APPLICATION BEGINS ON PAGE 436*POWERHEAD GASKET SETS DO NOT INCLUDE HEAD GASKETS



**18-4339
POWERHEAD GASKET SET**

Replaces: 27-14697A87
For: V200EFI and V220 outboards

CONTAINS —			
Part #	Desc.	O.E.#	Qty.
18-3862	Head Gasket	27-41246-1	2
18-7153	O-Ring	25-21836	1
18-7164	O-Ring	25-33486	1
18-7159	O-Ring	25-31534	1
18-0135	Gasket	27-78246	1
18-7426	Slinger	25-30271	1
18-0182	Gasket	27-62386	2
18-0860	O-Ring	25-62700	1
18-0936	Gasket	27-78690	2
18-2919	Gasket	27-42631-1	1
18-2915	Gasket	27-85609-1	1
18-2506-1	Exhaust Plate Gasket	27-99176-3	1
18-2503	Drive Shaft Gasket	27-99177-1	1
18-2513	Cork	27-11338	2
18-0644	Reed Plate Gasket	27-14697-2	1
18-0645	Gasket	27-16737-1	1
18-2502	Gasket	27-90484-1	2
18-2511	Gasket	27-99173-2	1
18-2914	Gasket	27-85608-1	1
18-3110	Grinnmet	26-38970	2
18-7174	O-Ring	25-45711	2
18-7178	O-Ring	25-90011	1
18-8305	Divider Plate Seal	26-814754	1
18-0858	O-Ring	25-54029	1
18-0952	Gasket	27-88907	1
18-7421	O-Ring	25-20415	1
18-0970	Fuel Pump Gasket	27-98769-1	1
18-7817	Diaphragm Kit	21-857005A1	1

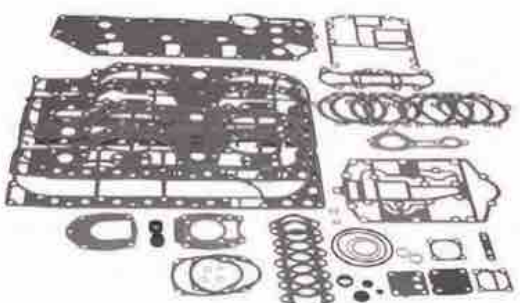

**18-4340
POWERHEAD GASKET SET**

Replaces: 27-13461A99, 27-13461A90, 27-13461A89, 27-13461A88
For: 80 Jet, 100HP, 115HP, and 125HP 4 cyl outboards

CONTAINS —			
Part #	Desc.	O.E.#	Qty.
18-4261	Fiber Washer	19643	1
18-7961	O-Ring	25-47254	1
18-0320	Gasket	27-13937-6	8
18-0324	Gasket	27-15172-4	8
18-0670	Gasket	27-43007-5	1
18-2565	Gasket	27-43047-2	1
18-2945	Drain Screw Gasket	19-19183	3
18-7198	O-Ring	25-45710	1
18-0182	Gasket	27-62386	1
NSS	Gasket	27-13461-2	2
18-2943	Cylinder Block Gasket	27-44328-4	1
18-2621	Outer Exhaust Plate Gasket	27-13958-1	2
18-2610	Baffle Plate Gasket	27-812775-4	1
18-2611	Inner Exhaust Plate Gasket	27-812775-5	1
18-0339	Thermostat Gasket	27-43006-2	1
18-0341	Exhaust Gasket	27-43008-6, 27-43008, 27-43008E, 27-43008B, 27-43008C	1
18-2563	Gasket	27-43034-1	1
NSS	Gasket	27-43033-1	1
18-2566	Impeller Gasket	27-817277	1
18-7105	O-Ring	25-62705	1
18-7414	O-Ring	25-64067	1
18-0858	O-Ring	25-54029	1
18-0970	Fuel Pump Gasket	27-98769-1	1
18-7817	Diaphragm Kit	21-857005A1	1

— CONTAINS —			
Part #	Desc.	O.E.#	Qty.
18-0182	Thermostat Gasket	27-62386	2
18-0858	O-Ring	25-4029	1
18-0860	O-Ring	25-62700	1
18-0129	Reed Block Gasket	27-65744-3	6
18-0135	Adapter Cover Gasket	27-78246	1
18-0936	Relief Valve Plate Gasket	27-78690	2
18-0952	Relief Valve Plate Gasket	27-88907	2
18-7421	O-Ring	25-20415	2
18-7411	O-Ring	25-35480	1
18-2501	Reed Block Housing Gasket	27-93536-1	1
18-2502	Divider Plate Gasket	27-90484-1	2
18-2503	Drive Shaft Hsg. to Exhaust Plate Gasket	27-99177-1	1
18-2506	Exhaust Plate Gasket	27-99176-3	1
18-2508	Exhaust Plate Gasket	27-99776-1	2
18-2509	Carb. Mtg. Gasket	27-67751	3
18-2510	Reed Block Housing Gasket	27-96781-1	1
18-2511	Drive Shaft Housing to Plate Gasket	27-99173-2	1
18-2513	Cyl. Block Sealing Gasket	27-11338	2
18-2803	Carb. Mounting Gasket	27-90430	3
18-2808	Cyl. Cover	27-96278	2
18-2826	Water Pump Base to Gear Housing Gasket	27-85610-1	1
18-2914	Water Pump Gasket	27-85608-1	1
18-2915	Water Pump Gasket	27-85609-1	1
18-3110	Bushing	26-38970	2
18-7153	O-Ring	25-25439	1
18-7157	O-Ring	25-29976	1
18-7159	O-Ring	25-31534	1
18-7182	O-Ring	25-33145	1
18-7164	O-Ring	25-33486	1
18-7188	O-Ring	25-48171	4
18-7174	O-Ring	25-45711	2
18-7176	O-Ring	25-90011	1
18-7812	Fuel Pump Kit	89031A2	1
18-9863	Head Gasket	27-96542-1	2
18-0359	Induction Silencer Cover Gasket	27-87275-1	1
18-0384	Carburetor Gasket	27-89221-1	3
18-2919	Water Pump Gasket	27-42631-1	1
18-7406	O-Ring	—	1

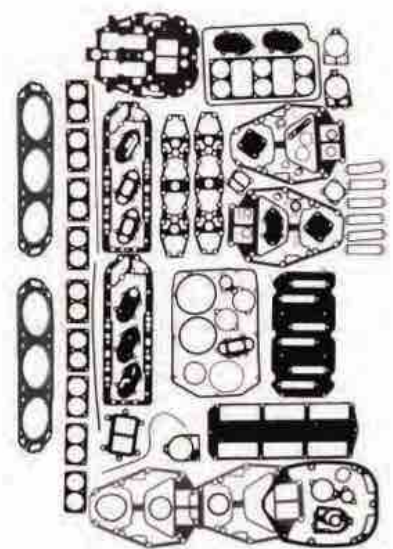

**18-4317
POWERHEAD GASKET SET**

Replaces: 27-90484A88, 27-90484A86, 27-90484A32

GASKET SET APPLICATION BEGINS ON PAGE 436
*POWERHEAD GASKET SETS DO NOT INCLUDE HEAD GASKETS

— CONTAINS —

Part #	Desc.	O.E.#	Qty.
18-0182	Thermostat Gasket	27-62386	2
18-0858	O-Ring	254029	1
18-0860	O-Ring	25-62700	1
18-0129	Reed Block Gasket	27-65744-3	6
18-0135	Adapter Cover Gasket	27-78246	1
18-0936	Relief Valve Plate Gasket	27-78690	2
18-0952	Relief Valve Plate Gasket	27-88907	2
18-7421	O-Ring	25-20415	2
18-7411	O-Ring	25-35480	1
18-2501	Reed Block Hsg. Gasket	27-93538-1	1
18-2502	Divider Plate Gasket	27-90484-1	2
18-2503	Drive Shaft Hsg. to Exhaust Plate Gasket	27-99177-1	1
18-2506	Exhaust Plate Gasket	27-99176-3	1
18-2508	Exhaust Plate Gasket	27-99778-1	2
18-2509	Carb. Mtg. Gasket	27-67751	3
18-2510	Reed Block Hsg Gasket	27-96761-1	1
18-2511	Drive Shaft Hsg to Plate Gasket	27-99173-2	1
18-2513	Cyl Block Sealing Gasket	27-11338	2
18-2603	Carb. Mtg. Gasket	27-90430	3
18-2808	Cyl. Cover	27-96278	2
18-2826	Water Pump Base to Gear Housing Gasket	27-85610-1	1
18-2914	Water Pump Gasket	27-85608-1	1
18-2915	Water Pump Gasket	27-85609-1	1
18-3110	Bushing	26-38970	2
18-7153	O-Ring	25-25439	1
18-7157	O-Ring	25-29976	1
18-7159	O-Ring	25-31534	1
18-7162	O-Ring	25-33145	1
18-7164	O-Ring	25-33466	1
18-7168	O-Ring	25-48171	4
18-7174	O-Ring	25-45711	2
18-7176	O-Ring	25-90011	1
18-7812	Fuel Pump Kit	89031A2	1
18-3862	Head Gasket	27-41246-1	2
18-0359	Induction Silencer Cover Gasket	27-62725-1	1
18-0384	Carburetor Gasket	27-89221-1	3
18-2919	Water Pump Gasket	27-42631-1	1
18-7408	O-Ring	—	1
18-7178	O-Ring	25-90011	1

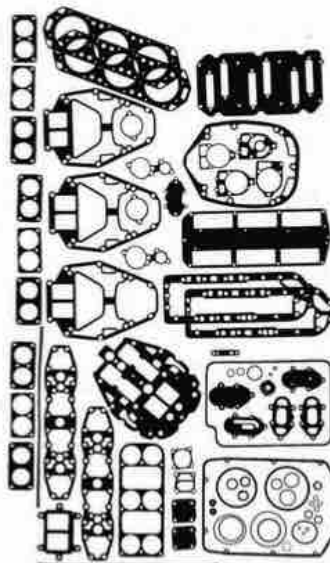

18-4319

POWERHEAD GASKET SET

Replaces: 27-11338A88, 27-89221A88, 27-89221A85, 27-89221A84, 27-89221A32, 27-11338A85

— CONTAINS —

Part #	Desc.	O.E.#	Qty.
18-0940	Baffle Plate to Exhaust Gasket	27-85488-2	1
18-0879	Adapter Plate Gasket	27-38501-1	1
18-2810	Block Cover Gasket	27-43777-2	1
18-0103	Powerhead to Ext. Plate Gasket	27-79650-1	2
18-0137	Baffle Plate Gasket	27-85492-2	1
18-2800	Carb. Flange Gasket	27-75791-1	2
18-0870	Transfer Port Cover Gasket	27-27936-1	2
18-0539	Rubber Seal Gasket	37721	1
18-7161	O-Ring	25-32546	1
18-2844	Thermostat Gasket	27-48818-1	1
18-2823	Lower Water Pump Base to Face Plate Gasket	27-19553	1
18-0938	Water Inlet Tube Gasket	27-79797-1	1
18-2825	Water Pump Base Gasket	27-32771	1
18-7153	O-Ring	25-25439	1
18-7151	O-Ring	25-20081	1



***18-4325**

POWERHEAD GASKET SET

Replaces: 27-85491A90, 25-85491A87

— CONTAINS —

Part #	Desc.	O.E.#	Qty.
18-0912	Drive Shaft Hsg. Plate Gasket	27-66102-1	1
18-0133	Water Jacket Cover Gasket	27-73665	1
18-0944	Water Jacket Cover Gasket	27-85496-1	1
18-0107	Exhaust Cover Gasket	27-85498-1	1
18-7421	O-Ring	25-20415	1
18-3110	Grommet	26-38970	2
18-7411	O-Ring	25-35480	1
18-2500	VC Gasket	27-85493	1
18-2514	Crankcase to Cyl Block Gasket	27-53650	2
18-2802	Carb. Flange Gasket	27-48164-1	2
18-2826	Water Pump Base to Gear Housing Gasket	27-85610	1
18-2835	Powerhead Gasket	27-69238	1
18-2914	Water Pump Gasket	27-85608	1
18-2915	Water Pump Gasket	27-85609-1	1
18-7153	O-Ring	25-25439	1
18-7157	O-Ring	25-29976	1
18-7161	O-Ring	25-32546	1
18-7162	O-Ring	25-33145	1
18-7167	O-Ring	25-47254	2
18-7807	Fuel Pump Kit	59278A1	1
18-0351	Distributor Cap Gasket	27-55896	1
18-7426	O-Ring	25-30271	1
18-4261	Washer	19643	1

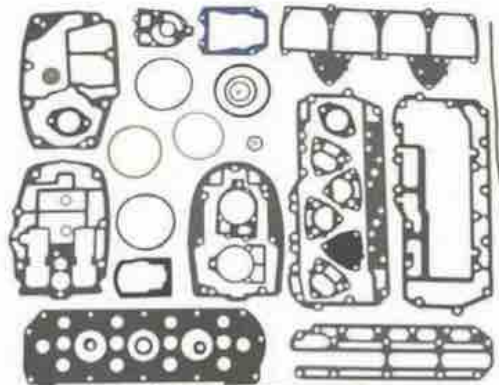

***18-4351**

POWERHEAD GASKET SET

Replaces: 27-64203A75, 27-64203A74, 27-64203A73

— CONTAINS —

Part #	Desc.	O.E.#	Qty.
18-0870	Transfer Port Cover Gasket	27-27936-1	2
18-0879	Adapter Plate Gasket	27-30501-1	1
18-0103	Powerhead to Ext. Plate Gasket	27-79650-1	2
18-0938	Water Inlet Tube Gasket	27-79797-1	1
18-0942	Baffle Plate Gasket	27-85491-2	1
18-0137	Baffle Plate Gasket	27-85492-2	1
18-7421	O-Ring	25-20415	1
18-2507	Cyl. Block Cover Gasket	27-85487	1
18-2800	Carb. Flange Gasket	27-75791-1	2
18-2810	Block Cover Gasket	27-43777-2	1
18-2823	Lower Water Pump Base to Face Plate Gasket	27-32769, 27-19553	1
18-2824	Upper Face Plate to Pump Body Gasket	27-32770, 27-19551	1
18-2825	Water Pump Base Gasket	27-32771	1
18-2841	Water Pump Base Gasket	27-77417, 27-19552	1
18-7151	O-Ring	25-20081	2
18-7153	O-Ring	25-25439	1
18-7115	O-Ring	25-26722	1
18-7155	O-Ring	25-26855	1
18-7160	O-Ring	25-31986	1
NSS	O-Ring	25-29619	1
18-7413	O-Ring	25-62702	2
18-7804	Fuel Pump Kit	23014A1	1
18-2571	Carb Flange Gasket	27-31402	2



***18-4353**

POWERHEAD GASKET SET

Replaces: 27-72486A32, 27-72486A79, 27-72486A78, 27-72486A76, 27-46110A72, 27-46110A2, 27-46110A1

— CONTAINS —

Part #	Desc.	O.E.#	Qty.
18-0182	Thermostat Gasket	27-62386	1
18-0879	Adapter Plate Gasket	27-38501-1	1
18-0988	Powerhead to Plate Gasket	27-62860-1	1
18-0914	Thermostat Cover Gasket	27-66847	1
18-0938	Water Inlet Tube Gasket	27-79797-1	1
18-0940	Baffle Plate to Exhaust Gasket	27-85488-2	1
NSS	Baffle Plate to Block Gasket	27-85489-2	1
18-7421	O-Ring	25-20415	1
18-7411	O-Ring	25-35480	1
18-2802	Carb Flange Gasket	27-48164-1	1
18-2805	Block Cover Gasket	27-85490-2	1
18-2823	Lower Water Pump Base to Face Plate Gasket	27-19553	1
18-2824	Upper Face Plate to Pump Body Gasket	27-19551	1
18-2825	Water Pump Base Gasket	27-32771	1
18-2838	Transfer Port Cover Gasket	27-55279-1	1
18-2841	Water Pump Base Gasket	27-19552	1
18-7115	O-Ring	25-26722	1
18-7143	O-Ring	25-65936	2
18-7145	O-Ring	25-64068	3
18-7153	O-Ring	25-25439	1
18-7155	O-Ring	25-26855	1
18-7160	O-Ring	25-31986	1
18-7187	O-Ring	25-47254	1
18-7413	O-Ring	25-62702	3
18-7414	O-Ring	25-64067	1
18-7807	Fuel Pump Kit	55278A1	1
18-4261	Washer	19643	1



***18-4355**

POWERHEAD GASKET SET

Replaces: 27-78028A78, 27-55306A75, 27-55306A74, 27-55306A73, 27-55306A72

— CONTAINS —

Part #	Desc.	O.E.#	Qty.
18-7153	O-Ring	25-25439	1
18-7120	O-Ring	25-38933	1
18-3110	Bushing	26-38970	2
18-7164	O-Ring	25-33466	1
18-7167	O-Ring	25-47254	1
18-2802	Carb. Flange Gasket	27-48164-1	3
18-7413	O-Ring	25-62702	2
18-7161	O-Ring	25-32546	2
18-7173	O-Ring	25-30224	1
18-3110	Grommet	26-38970	1
18-7421	O-Ring	25-20415	1
18-7162	O-Ring	25-33145	1
18-7157	O-Ring	25-29976	1
18-2914	Water Pump Gasket	27-85608-1	1
18-2915	Water Pump Gasket	27-85609-1	1
18-2801	Water Pump Gasket	27-32438	1
18-2826	Water Pump Base to Gear Housing Gasket	27-85610-1	1
18-0912	Drive Shaft Hsg. Gasket	27-66102-1	1
18-2573	Water Jacket Cover Gasket	27-72142-1	1
18-2574	Exhaust Cover Gasket	27-85495-2	1
18-0946	Transfer Port Gasket	27-85653-1	1
18-2513	Crankcase to Cyl. Block Gasket	27-53862	2
18-2807	Block Cover Gasket	27-98185	1
18-2835	Powerhead Gasket	27-69238-1	1
18-2839	Exhaust Cover	27-85497-2	1
18-7807	Fuel Pump Kit	55278A1	2
18-7813	Fuel Pump Kit	89031A3	1
18-7426	O-Ring	25-30271	1

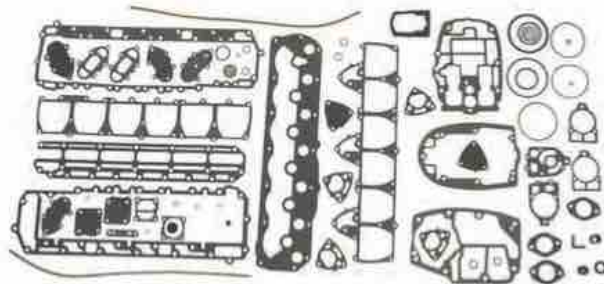

***18-4356**

POWERHEAD GASKET SET

Replaces: 27-85653A87, 27-85653A79, 27-85653A32, 27-60476A75, 27-60476A74, 27-60476A73, 27-60476A72

GASKET SET APPLICATION BEGINS ON PAGE 436

*POWERHEAD GASKET SETS DO NOT INCLUDE HEAD GASKETS

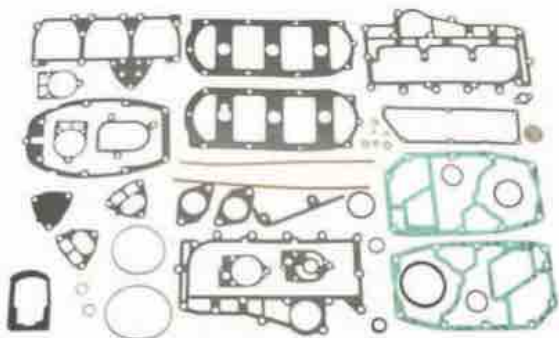

*18-4357

POWERHEAD GASKET SET

Replaces: 27-88449A32, 27-88449A80, 27-76589A79, 27-76589A78, 27-76589A77, 27-73440A76

— CONTAINS —			
Part #	Desc.	O.E.#	Qty.
18-0182	Thermostat Gasket	27-62386	1
18-0879	Adapter Plate Gasket	27-38501-1	1
18-0904	Powerhead to Exhaust Gasket	27-60317	1
18-0918	Plate to Exhaust Manifold Gasket	27-69524-2	1
18-0131	Baffle Plate Gasket	27-69525-2	1
18-0922	Baffle Plate Gasket	27-70335-1	1
18-0932	Transfer Passage Cover Gasket	27-76862-1	1
18-0938	Water Inlet Tube Gasket	27-79797-1	1
18-0139	Powerhead to Exhaust Plate Gasket	27-89451-1	1
18-7421	O-Ring	25-20415	1
18-2945	Drain Screw Gasket	12-20260	2
18-7411	O-Ring	25-35480	1
18-2504	Block Cover Gasket	27-88449	1
18-2512	Crankcase to Cyl. Block Gasket	27-60286	2
18-2804	Carb. Flange Gasket	27-73377-1	2
18-2809	Block Cover Gasket	27-43779-2	1
18-2823	Lower Water Pump Base to Face Plate Gasket	27-19553	1
18-2824	Upper Face Plate to Pump Body Gasket	27-19551	1
18-2825	Water Pump Base Gasket	27-32771	1
18-2841	Water Pump Base Gasket	27-19552	1
18-7143	O-Ring	27-77417	1
18-7153	O-Ring	25-25439	1
18-7115	O-Ring	25-26722	1
18-7155	O-Ring	25-26855	1
18-7160	O-Ring	25-31986	1
18-7161	O-Ring	25-32546	1
18-7413	O-Ring	25-62702	2
NSS	O-Ring	25-64966	1
18-7809	Fuel Pump Kit	55278A4	1
18-4261	Washer	19643	1



*18-4359

POWERHEAD GASKET SET

Replaces: 27-815791A92, 27-815792A90, 27-815810A90, 27-815809A90

— CONTAINS —			
Part #	Desc.	O.E.#	Qty.
18-0135	Gasket, Adapter	27-78246	1
18-0182	Gasket, Thermostat	27-62386	2
18-0384	Gasket, Carburetor	27-89221-1	3
18-0641	Gasket, Carb Mounting	27-828292	3
18-0642	Gasket, Divider Plate	27-19050-3	1
18-0643	Gasket, Exh. Plate	27-18307-1	1
18-0644	Gasket, Reed Plate	27-14697-2	1
18-0645	Gasket, Adapter Plate	27-16737-1	1
18-0646	Gasket, Reed Plate	27-813859	1
18-0838	O-Ring	—	1
18-0858	O-Ring	25-54029	1
18-0860	O-Ring	25-62700	1
18-0936	Gasket, Relief Valve	27-78690	2
18-2506	Gasket, Pwr Head	27-99176-3	1
18-2509	Gasket, Carb Mounting	27-67751	3
18-2511	Gasket, Drive Shaft To Hsg Plate	27-99173-2	1
18-2513	Gasket, Crankcase Cvr.	27-11338	2
18-2914	Gasket, Water Pump	27-85608-1	1
18-2915	Gasket, Water Pump	27-85609-1	1
18-2919	Gasket, Water Pump	27-42631-1	1
18-3110	Seal	25-38970	2
18-7153	O-Ring	25-25439	1
18-7157	O-Ring	25-29976	1
18-7159	O-Ring	25-31534	1
18-7174	O-Ring	25-45711	1
18-7176	O-Ring	25-90011	1
18-8305	Seal, Divider Plate	26-814754	1



 <p>18-64217 POWERHEAD GASKET SET Replaces: 27-815791A00 Fits: Mercury 150/175 EFI(G960500-T408999)</p>	 <p>18-3845 HEAD GASKET Replaces: 27-825032 For: 4-Stroke O/B's, 40/45/50 HP S/N OG760300 & Up</p>	 <p>18-2736 HEAD GASKET Replaces: 27-863895, 27-863891, 27-863893 For: 15-25HP 2 cyl</p>
 <p>18-3804 HEAD GASKET Replaces: 27-19138M, 19138, 27-84733M For: Model 30A; S/N Code 689</p>	 <p>18-3828 HEAD GASKET Replaces: 27-18937M, 27-18937, 27-98990M, 27-83899M For: Model 9.9C; S/N Code 682 & Model 15C; S/N Code 684</p>	 <p>18-3861 HEAD GASKET Replaces: 27-187851, 27-187853, 27-18785T For: Model 135, 150 and XR4</p>
 <p>18-3862 HEAD GASKET Replaces: 27-41246-1 For: Model 175, 200, XR4</p>	 <p>18-3844 HEAD GASKET Replaces: 27-803508 For: 4-Stroke O/B's, 4/5/6 HP S/N DR000001 & Up</p>	 <p>18-3871 HEAD GASKET Replaces: 27-18786-1 For: Model 175, XR4, Mag II</p>
 <p>18-3863 HEAD GASKET Replaces: 27-96542-1 For: Model 150</p>	 <p>18-3864 HEAD GASKET Replaces: 27-822844-1 For: Model 175, 200 and XR6</p>	 <p>18-3872 HEAD GASKET Replaces: 27-41245-1 For: 200 and 225 HP</p>
 <p>18-3827 HEAD GASKET Replaces: 27-8254821, 27-825482 For: 8, 9.9 HP 4-Stroke</p>	 <p>18-60916 CYLINDER HEAD GASKET Replaces: 27-850836001 Fits: Mercury 8/9.9 (R042475 & Up)</p>	<p>PKG. OF 5</p>  <p>18-7400 18-7400-9 O-RING HEAD GASKET Replaces: 25-818573 1 per cylinder, 3 per cylinder head</p>

① Priced per Package
GASKET SET APPLICATION ON NEXT PAGE
*POWERHEAD GASKET SETS DO NOT INCLUDE HEAD GASKETS

HEAD GASKET/GASKET SET APPLICATION













Model	Cyl.	Eng. S/N	End S/N	Gasket Set	Head O-Rings	Head Gasket	Head Seals
4.5/E (4 stroke)	1 CYL	R000001	& UP	—	—	18-3844	—
8 FOUR STROKE (232cc)		H000058	H017349	—	—	18-3827	—
8 FOUR STROKE (232cc)		G760300	T178499	—	—	18-3827	—
9.9 FOUR STROKE (232cc)		H000058	H017349	—	—	18-3827	—
18 (18XD)	2	6416713	6445972	18-4334	—	—	—
20 (20,20XD, 200)	2	6443973	OT800999	18-4334	—	—	—
20 JET	2	G044027	& UP	18-4334	—	—	—
30 JET (40 HP)	4 CYL	C159200	& UP	18-4325	—	—	—
35	2 CYL	6445653	B110786	18-4355	—	—	—
40, 402	2 CYL	3336258	G053313	18-4355	—	—	—
40	4 CYL	C159200	& UP	18-4325	—	—	—
40 FOUR STROKE (232cc)	3 CYL	G231123	T178499	—	—	18-3845	—
45	4 CYL	5531630	0B110786	18-4353	—	—	—
45	4 CYL	B110789	& UP	18-4325	—	—	—
45 Jet	3 CYL	D000750	& UP	18-4337	—	—	—
45 FOUR STROKE (BODENSEE)		G231123	T178499	—	—	18-3845	—
50, 500	4 CYL	E116318	& UP	18-4353	—	—	—
50, 60	4 CYL	6428661	B122929	18-4357	—	—	—
50	3 CYL	D000750	G0589999	18-4337	—	—	—
50	3 CYL	B122930	D000749	18-4326	—	—	—
50 FOUR STROKE		G231123	T178499	—	—	18-3845	—
55	3 CYL	6428661	B122929	18-4357	—	—	—
55	3 CYL	D000750	& UP	18-4337	—	—	—
65 (650)	3 CYL	3293184	4382056	—	—	—	—
65 (650)	3 CYL	4382057	4571651	18-4357	—	—	—
70	3 CYL	4571652	A996141	18-4357	—	—	—
70	3 CYL	A996142	& UP	18-4336	—	—	—
75	4 CYL	6432901	& UP	—	—	—	—
80	3 CYL	A996142	& UP	18-4336	—	—	—
80 Jet	4 CYL	D283222	& UP	18-4340	—	—	—
80, 800	4 CYL	2559001	3493912	18-4350	—	—	—
80, 800	4 CYL	4831899	6432900	—	—	—	—
85, 850	4 CYL	3493913	4366801	18-4351	—	—	—
85, 850	4 CYL	4366802	4831936	—	—	—	—
90, 900	6 CYL	4845301	& UP	18-4356	—	—	—
90	3 CYL	A996142	& UP	18-4336	—	—	—
100	4 CYL	B209469	& UP	18-4340	—	—	—
105 JET	6 CYL	D082000	& UP	18-4359	—	18-3864(2)	— 1
115	4 CYL	C100000	& UP	18-4340	—	—	—
125	4 CYL	D283222	& UP	18-4340	—	—	—
140 (140, 1400)	6 CYL	3293254	3502805	18-4356	—	—	—
140 (140, 1450)	6 CYL	4865678	& UP	18-4356	—	—	—
140 (140, 1400)	6 CYL	4865678	& UP	18-4356	—	—	—
150 (1500)	6 CYL	3502806	5327622	18-4356	—	—	—
V-135	V-6	A904846	C239552	18-4317 U	—	18-3863	—
V-135	V-6	C239553	G960499	18-4359	—	18-3861	— 1
V-135 DFI	V-6	G990000	G960499	18-4336	—	—	— 1
140 JET	V-6	D082000	G960499	18-4359	—	18-3864	— 1
V-150 (150, 1500)	V-6	4868998	6042945	18-4315	—	—	—
V-150	V-6	6042946	C239552	18-4317 U	—	18-3863	—
V-150	V-6	C239553	G960499	18-4359	—	18-3861	— 1
V-150	V-6	G960500	& UP	18-4338	—	—	— 6
V-150 (XR/MAGNUM II)	V-6	B242885	C239552	18-4319 U	—	—	—
V-150 XR4	V-6	C239553	D081999	18-4359	—	18-3871	— 1
V-150 (XR6/MAGNUM III)	V-6	D082000	G960499	18-4359	—	18-3864(2)(3)	— 1
V-150 (EFI)	V-6	D082000	G960499	18-4359	N/A	—	— 1

① Gasket set includes head gasket ④ Used on a 2.5L with a 0.5" bore 2 Cyl head o-rings & seal not included in gskt kit
 ② 2 head gaskets required ⑤ Requires 3 per cylinder head 3 Cyl head o-rings not included in gskt kit 6 Cyl head gaskets & seal not included in gskt set
 ③ Used on a 2.4L with a 3.38" bore 7 head gaskets not included in gskt set

HEAD GASKET/GASKET SET APPLICATION







Model	Cyl	Eng. S/N	End. S/N	Gasket Set	Head O-Rings	Head Gasket	Head Seals
150 MAR	V-6	5600162	6038680	18-4315	—	—	—
150 MAR	V-6	6038681	C239553	18-4317 ①	—	18-3863 ②	—
150 MAR	V-6	C239554	& UP	18-4359	—	18-3861 ②	—
V-175 (175, 1750)	V-6	4301235	6618750	18-4315	—	—	—
V-175	V-6	6618751	C239552	18-4319 ①	—	18-3862	—
V-175	V-6	C239553	D081996	18-4359	—	18-3871 ②③	— 1
V-175	V-6	D082000	G960499	18-4359	—	18-3864 ②④	—
V-175 (EFI)	V-6	D000750	D081996	18-4359	—	18-3871 ②③	— 1
V-175 XRI EFI	V-6	D000750	D081999	18-4359	—	18-3864 ②④	—
V-175 (EFI)	V-6	D082000	G303045	18-4359	—	18-3864 ②④	— 1
V-200 (200, 2000)	V-6	4839034	6073191	—	—	18-3872 ⑤	—
V-200	V-6	6073192	6203990	—	—	18-3872 ⑤	—
V-200	V-6	6203991	C291519	18-4319 ①	—	18-3862 ②③	—
V-200	V-6	C291520	D081999	18-4359	—	18-3864 ②④	— 1
V-200	V-6	D082000	G960499	18-4359	—	—	— 1
V-200 (EFI)	V-6	C100861	OC291519	18-4339	—	18-3862	—
V-200 (EFI)	V-6	C291520	G960499	18-4359	—	18-3864	— 1
V-200 (DFI) 3.0L	V-6	G386496	G589999	—	18-7400	—	—
V-200 (DFI) 3.0L	V-6	G590000	G960499	18-4335	18-7400	—	— 2
V-200 (DFI) 3.0L	V-6	G960500	T178499	—	18-7400	—	— 3
V-200 XRI EFI	V-6	C100861	C291519	—	—	18-3862 ⑤	—
V-200 XRI EFI	V-6	C291520	& UP	18-4359	—	18-3864 ②④	—
V-220	V-6	B117316	& UP	18-4339	—	18-3862 ⑤	—
V-225 SEA PRO	V-6	G245805	DT408999	—	18-7400 ⑥	—	—
V-225 (EFI) 3.0L	V-6	G129222	T408999	—	18-7400 ⑥	—	—
V-225 DFI (3.0L)	V-6	G590000	OG960499	18-4335	18-7400 ⑥	—	— 3
V-225 DFI (3.0L)	V-6	G960500	T178499	—	18-7400 ⑥	—	— 3
V-250 (EFI) 3.0L	V-6	G129222	T408999	—	18-7400 ⑥	—	—

- ① Gasket set includes head gasket ② Used on a 2.5L with a 3.5" bore 2 Cyl head o-rings & seal not included in gskt kit
 ② 2 head gaskets required ③ Requires 3 per cylinder head 3 Cyl head o-rings not included in gskt kit 5 Cyl head gaskets & seal not included in gskt set
 ③ Used on a 2.4L with a 3.38" bore 7 head gaskets not included in gskt set

			
18-0324 CARB TO MANIFOLD GASKET Replaces: 27-15172 3, 27-151724, 27-15172, 27-93214	18-0384 CARB GASKET Replaces: 27-892211, 27-817533, 27-89221, 27-8M0027781 200/225 HP	18-0633 CARB MOUNTING GASKET Replaces: 27-192061, 27-42178, 27-19206, 27-414491, 27-41449	18-0641 CARB MOUNTING GASKET Replaces: 27-828292
PKG. OF 3 	PKG. OF 2 	PKG. OF 2 	PKG. OF 2 
18-2509 CARB MOUNTING GASKET Replaces: 27-67751 V-6	18-2571 18-2571-9 ⑥ CARB FLANGE GASKET Replaces: 27-31402	18-2572 18-2572-9 ⑥ CARB FLANGE GASKET Replaces: 27-63309, 27-22023	18-2800 18-2800-9 ⑥ CARB MOUNTING GASKET Replaces: 27-757911, 27-75791, 27-69659, 27-26891 20-45-50 HP
PKG. OF 2 	PKG. OF 3 	PKG. OF 4 	PKG. OF 2 
18-2802 18-2802-9 ⑥ CARB FLANGE GASKET Replaces: 27-48164, 27-481641	18-2803 18-2803-9 ⑥ CARB MOUNTING GASKET Replaces: 27-90430, 27-904301 V-6	18-2804 18-2804-9 ⑥ CARB MOUNTING GASKET Replaces: 27-733771, 27-73377 3-4 Cyl.	18-2568 18-2568-9 ① STRAINER COVER SCREW GASKET Replaces: 27-25848

SEE PAGE 219 FOR OUR COMPLETE LINE OF GASKET SEALANTS

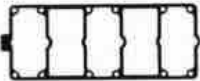











© Priced per Package

 <p>18-2569 18-2569-9① FILTER COVER GASKET Replaces: 27-25849</p>	 <p>18-2570 18-2570-9① STRAINER COVER GASKET Replaces: 27-25851, 27-34614</p>	 <p>18-2575 18-2575-9① CARB BOWL GASKET Replaces: 1399-99</p>	 <p>18-0970 18-0970-9① FUEL PUMP GASKET Replaces: 27-987691, 27-98769</p>	 <p>18-0740-1 THROTTLE BODY GASKET Replaces: 27-805396</p>												
 <p>18-0359 INDUCTION SILENCER COVER GASKET Replaces: 27-672751, 27-67275</p>	 <p>18-2737 REED BLOCK GASKET Replaces: 27-850283 For: 200 DFI, 225 DFI</p>	 <p>18-0129 REED BLOCK GASKET Replaces: 27-657443, 27-657442, 27-657441, 27-65744 V-6</p>	 <p>18-0320 REED BLOCK GASKET Replaces: 27-13937-6</p>	 <p>18-0644 REED PLATE GASKET Replaces: 27-146972</p>												
 <p>18-0646 REED PLATE GASKET Replaces: 27-813859</p>	 <p>18-2501 18-2501-9① REED BLOCK HOUSING GASKET Replaces: 27-935361, 27-93536, 27-67738 V-6</p>	 <p>18-2510 18-2510-9① REED BLOCK HOUSING GASKET Replaces: 27-967611, 27-96761 V-200</p>	<p>CRANKCASE GASKETS</p> <table border="1"> <thead> <tr> <th>Part #</th> <th>Replaces:</th> <th>Description</th> </tr> </thead> <tbody> <tr> <td>18-2512 ②, ③</td> <td>27-60286</td> <td>Crankcase to Cyl. Block 3 Cyl.</td> </tr> <tr> <td>18-2513 ②</td> <td>27-11338, 27-67208</td> <td>Cyl. Block Sealing V-6</td> </tr> <tr> <td>18-2514 ②</td> <td>27-53650</td> <td>Crankcase to Cyl. Block 4 Cyl.</td> </tr> </tbody> </table>		Part #	Replaces:	Description	18-2512 ②, ③	27-60286	Crankcase to Cyl. Block 3 Cyl.	18-2513 ②	27-11338, 27-67208	Cyl. Block Sealing V-6	18-2514 ②	27-53650	Crankcase to Cyl. Block 4 Cyl.
Part #	Replaces:	Description														
18-2512 ②, ③	27-60286	Crankcase to Cyl. Block 3 Cyl.														
18-2513 ②	27-11338, 27-67208	Cyl. Block Sealing V-6														
18-2514 ②	27-53650	Crankcase to Cyl. Block 4 Cyl.														
 <p>18-0645 ADAPTER PLATE GASKET Replaces: 27-167371</p>	 <p>18-0624 ATTENUATOR GASKET Replaces: 27-188891</p>	 <p>18-0107 EXHAUST COVER GASKET Replaces: 27-85498-1, 27-85498, 27-64203, 27-72510 4 Cyl.</p>	 <p>18-0131 BAFFLE GASKET Replaces: 27-695252, 27-695251, 27-69525, 27-64857 3 Cyl.</p>	 <p>18-0133 WATER JACKET GASKET Replaces: 27-73665, 27-52892 4 Cyl.</p>												
 <p>18-0137 BAFFLE GASKET Replaces: 27-85492-2 50 HP</p>	 <p>18-0371 BAFFLE GASKET Replaces: 27-78409, 27-39316, 27-72915 20 HP</p>	 <p>18-0373 BAFFLE GASKET Replaces: 27-78411, 27-45088, 27-72917 20 HP</p>	 <p>18-0918 PLATE TO EXHAUST MANIFOLD GASKET Replaces: 27-695242, 27-695241, 27-69524 3 Cyl.</p>	 <p>18-2712 ADAPTER PLATE GASKET Replaces: 27-414181, 27-41418, 27-85979 For: 15-25 2 cyl</p>												
 <p>18-2621 BAFFLE GASKET Replaces: 27-139581 For: 100HP 4 cyl, 115HP 4 cyl</p>	 <p>18-2710 REED BLOCK GASKET Replaces: 27-414172, 27-414171, 27-41417, 27-85978 For: 15-25HP 2 cyl</p>	 <p>18-0380 THERMOSTAT GASKET Replaces: 27-83940M</p>	 <p>18-2721 THERMOSTAT GASKET Replaces: 27-827284 For: 30-60HP 3 cyl outboards</p>	 <p>18-2729 THERMOSTAT GASKET Replaces: 27-8128672 For: 30-40HP 2 cyl, 45 Jet, 50-60 3 cyl</p>												

SEE PAGES 219 FOR OUR COMPLETE LINE OF GASKET SEALANTS











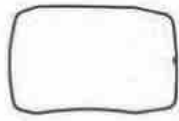







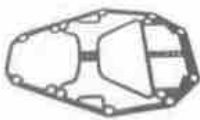

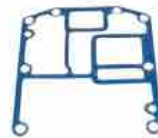

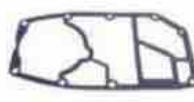

① Priced per Package

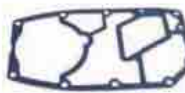
② This product is priced per piece. To order priced per package, please add -9 to the part number

 <p>18-2749 THERMOSTAT GASKET Replaces: 27-8128671, 27-812867 For: 45 Jet, 50-60 HP 3 cyl</p>	 <p>18-3675 THERMOSTAT GASKET Replaces: 27-850318, 27-8503181 For: 200-250HP 3.0L, (DFI and EFI)</p>	 <p>18-0922 18-0922-9Ⓢ BAFFLE GASKET Replaces: 27-703351, 27-70335 3 Cyl.</p>	 <p>18-0940 BAFFLE GASKET Replaces: 27-854882, 27-854881, 27-85488, 27-78027, 27-55308</p>	 <p>18-0942 BAFFLE GASKET Replaces: 27-85491-2, 27-854913, 27-854911, 27-85491, 27-72486, 27-46110 45/50 HP</p>
 <p>18-0944 BAFFLE GASKET Replaces: 27-854961, 27-85496, 27-64204, 27-72508</p>	 <p>18-0232 COVER GASKET Replaces: 27-81031M</p>	 <p>18-2573 18-2573-9Ⓢ WATER JACKET GASKET Replaces: 27-721421, 27-72142, 27-60475 6 Cyl.</p>	 <p>18-2574 18-2574-9Ⓢ EXHAUST COVER GASKET Replaces: 27-854952, 27-854951, 27-85495, 27-72507, 27-60476 6 Cyl.</p>	 <p>18-2836 18-2836-9Ⓢ BAFFLE GASKET Replaces: 27-78035, 27-72918, 27-46233, 27-31439 7.5-10 HP</p>
 <p>18-2839 18-2839-9Ⓢ EXHAUST COVER GASKET Replaces: 27-854972, 27-854971, 27-85497, 27-72509, 27-60477</p>	 <p>18-0151 DIVIDER PLATE GASKET Replaces: 27-76636, 27-75952 V-6</p>	 <p>18-0642 DIVIDER PLATE GASKET Replaces: 27-190503, 27-19050, 27-190502, 27-190505</p>	 <p>18-2502 18-2502-9Ⓢ DIVIDER PLATE GASKET Replaces: 27-904841, 27-90484, 27-87396 V-6</p>	 <p>18-0870 TRANSFER PORT COVER GASKET Replaces: 27-279361, 27-27936</p>
 <p>18-0926 TRANSFER PORT COVER GASKET Replaces: 27-73645</p>	 <p>18-0932 TRANSFER PASSAGE COVER GASKET Replaces: 27-768621, 27-76862 3 Cyl.</p>	 <p>18-0946 TRANSFER PORT GASKET Replaces: 27-85653-1, 27-856730, 27-85653 6 Cyl.</p>	 <p>18-2838 18-2838-9Ⓢ TRANSFER PORT COVER GASKET Replaces: 27-552791, 27-55279</p>	 <p>18-0372 CYLINDER BLOCK GASKET Replaces: 27-78410, 27-52579, 27-72916 20 HP</p>
 <p>18-2740 CYLINDER BLOCK GASKET Replaces: 27-430057, 27-430056, 27-430055, 27-430053, 27-430052, 27-430051 For: 65 Jet, 75HP 3 cyl, 90HP 3 cyl</p>	 <p>18-2943 CYLINDER BLOCK GASKET Replaces: 27-443281, 27-443282, 27-443283, 27-443284 For: 80 Jet, 100HP, 115HP, and 125HP 4 cyl outboards</p>	 <p>18-2500 18-2500-9Ⓢ EXHAUST COVER GASKET Replaces: 27-85493, 27-72505, 27-52893 80 HP</p>	 <p>18-2505 18-2505-9Ⓢ CYLINDER BLOCK GASKET Replaces: 27-961711, 27-96171 75-80 HP</p>	 <p>18-2507 18-2507-9Ⓢ CYLINDER BLOCK GASKET Replaces: 27-85487, 27-78026, 27-72487, 27-37816 40-50 HP</p>
 <p>18-2805 18-2805-9Ⓢ COVER GASKET Replaces: 27-85490-2 35-40 HP</p>	 <p>18-2504 18-2504-9Ⓢ COVER GASKET Replaces: 27-88449, 27-76401, 27-74511, 27-60310 3 Cyl.</p>	 <p>18-2806 18-2806-9Ⓢ CYLINDER COVER GASKET Replaces: 27-65788 V-6</p>	 <p>18-2807 18-2807-9Ⓢ COVER GASKET Replaces: 27-981853, 27-9818512, 27-981851, 27-98185, 27-85494, 27-72506, 27-64940, 27-53863 90-115 HP</p>	 <p>18-2808 18-2808-9Ⓢ CYLINDER COVER GASKET Replaces: 27-96278 V-6</p>

SEE PAGES 219 FOR OUR COMPLETE LINE OF GASKET SEALANTS

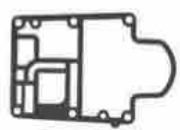
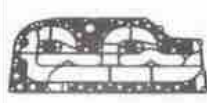
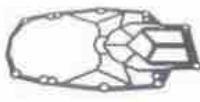
Ⓢ Priced per Package

 <p>18-60917 CYLINDER COVER GASKET Replaces: 27-803508017 Fits: Mercury 89.9 (R042475 & UP)</p>	<p>PKG. OF 2</p>  <p>18-2810 18-2810-9Ⓜ BLOCK COVER GASKET Replaces: 27-437772, 27-437771, 27-43777, 27-96483 45-50 HP</p>	<p>PKG. OF 2</p>  <p>18-2837 18-2837-9Ⓜ BLOCK COVER GASKET Replaces: 27-41382, 27-78087, 27-72918, 27-66358, 27-31436</p>	 <p>18-0333 POWERHEAD BASE GASKET Replaces: 27-39401</p>	 <p>18-0334 MOUNTING PLATE TO DRIVESHAFT HOUSING GASKET Replaces: 27-39402</p>
 <p>18-0336 ADAPTER PLATE GASKET Replaces: 27-41670-3, 27-41670-5 18 HP</p>	 <p>18-0649 SHIFT ROD HOUSING GASKET Replaces: 27-858935 For: 200 HP T801000 & UP, 200 HP OPTIMAX DFI G438000 & UP, 225 HP EFI G438000 & UP, 225 HP OPTIMAX DFI G590000-G960499, 250 HP EFI G438000 & UP, (MODELS WITH "C-3 CASTING": 200 HP OPTIMAX DFI G386496-G437999, 225 HP D280813-G437999, 225 HP EFI G129222-G437999, 250 HP EFI G129222-G437999)</p>	 <p>18-0341 EXHAUST PLATE GASKET Replaces: 27-430086, 27-43008, 27-430082, 27-430083, 27-430085 For: 70-90, 100, 115 & 125 HP</p>	 <p>18-0791 SHIFT SHAFT COVER GASKET Replaces: 27-880729 For: All Verado's 135/150/175/200 225/250/275</p>	
 <p>18-0369 POWERHEAD BASE GASKET Replaces: 27-75909 V-6</p>	 <p>18-0378 POWERHEAD BASE GASKET Replaces: 27-823142, 27-823142 2</p>	 <p>18-0670 POWERHEAD BASE GASKET Replaces: 27-430075, 27-430073, 27-43007</p>	 <p>18-0385 POWERHEAD BASE GASKET Replaces: 27-89937, 27-31557, 27-30803, 27-45748 4.5-9.8 HP</p>	 <p>18-0643 POWERHEAD BASE GASKET Replaces: 27-18307-1, 27-183078</p>
 <p>18-0879 ADAPTER PLATE GASKET Replaces: 27-385011, 27-38501, 27-37724</p>	 <p>18-0904 POWERHEAD BASE GASKET Replaces: 27-60317 65 HP</p>	 <p>18-0135 ADAPTER COVER GASKET Replaces: 27-78246, 27-78246 1</p>	 <p>18-0103 POWERHEAD BASE GASKET Replaces: 27-796501, 27-79650, 27-37725, 27-72496</p>	 <p>18-0139 POWERHEAD BASE GASKET Replaces: 27-884511, 27-88451, 27-78623, 27-76589</p>
 <p>18-2735 DIVIDER PLATE GASKET Replaces: 27-190506 For: 140 Jet, 115-200HP (2.5L), XR-8</p>	 <p>18-2713 DRIVESHAFT HOUSING GASKET Replaces: 27-433374, 27-43337, 27-43337A1, 27-433371, 27-433372, 27-433373, 27-96286 For: 15-25 2 cyl</p>	 <p>18-2714 EXHAUST COVER GASKET Replaces: 27-414995, 27-414994, 27-414993, 27-414992, 27-892157 For: 15-25 HP, 2 Cyl.</p>	 <p>18-2716 EXHAUST COVER GASKET Replaces: 27-414991, 27-41499, 27-92332 For: 18XD, 20XD (2 cyl), 25XD</p>	 <p>18-2741 EXHAUST COVER PLATE GASKET Replaces: 27-430047, 27-430045, 27-430043, 27-430042, 27-430041, 27-43004009 For: 85 Jet, 75HP 3 cyl, 90HP 3 cyl</p>
 <p>18-2717 EXHAUST MANIFOLD GASKET Replaces: 27-414758, 27-414757, 27-414756, 27-414755, 27-414754, 27-414753, 27-414752, 27-414751, 27-41475, 27-92331, 27-892158 For: 15-25HP 2 cyl</p>	 <p>18-0319 POWERHEAD BASE GASKET Replaces: 27-828553 For: 30-60HP 2 cyl and 3 cyl</p>	 <p>18-2610 OUTER EXHAUST PLATE GASKET Replaces: 27-8127754, 27-812755 For: 80 Jet, 100HP, 115HP, and 125HP 4 cyl outboards</p>	 <p>18-2739 EXHAUST PLATE GASKET Replaces: 27-8329335, 27-8329334, 27-8329333, 27-8329332, 27-8329331, 27-832933006 For: 250XS (3.0L) DFI</p>	 <p>18-2611 INNER EXHAUST PLATE GASKET Replaces: 27-8127551, 27-8127755, 27-812755A01 For: 80 Jet, 100HP, 115HP, and 125HP 4 cyl outboards</p>





SEE PAGE 219 FOR OUR COMPLETE LINE OF GASKET SEALANTS

Ⓜ Priced per Package

 <p>18-0912 DRIVE SHAFT HOUSING PLATE GASKET Replaces: 27-661021, 27-66102, 27-60945</p>	 <p>18-0934-1 POWERHEAD BASE GASKET Replaces: 27-78069</p>	 <p>18-0988 POWERHEAD BASE GASKET Replaces: 27-628601, 27-62860, 27-37976</p>	 <p>PKG. OF 2 18-2503 18-2503-9① DRIVE SHAFT HOUSING TO EXHAUST PLATE GASKET Replaces: 27-991771, 27-991772, 27-99177, 27-78068 V-6</p>	 <p>PKG. OF 2 18-2506-1 18-2506-1-9① EXHAUST PLATE GASKET Replaces: 27-991763, 27-991764, 27-991762, 27-99176 V-175/V-200</p>
 <p>PKG. OF 2 18-2508-1 18-2508-1-9① EXHAUST PLATE GASKET Replaces: 27-997761, 27-99776, 27-96440 V-135/V-150</p>	 <p>PKG. OF 2 18-2809 18-2809-9① BLOCK COVER GASKET Replaces: 27-437792, 27-437791, 27-43779, 27-96485 50-60-HP</p>	 <p>PKG. OF 2 18-2511 18-2511-9① DRIVE SHAFT HOUSING TO EXHAUST PLATE GASKET Replaces: 27-99173-2 V-6</p>	 <p>18-60919 EXHAUST COVER GASKET Replaces: 27-834952001 Fits: Mercury 8/9.9 (R042475 & Up)</p>	 <p>PKG. OF 2 18-2835 18-2835-9① POWERHEAD BASE GASKET Replaces: 27-692381, 27-69238, 27-66101, 27-64173, 27-60479 75-90-115-140 Hp</p>
 <p>18-0982-1 POWERHEAD GASKET Replaces: 27-56304, 27-48713</p>	 <p>18-60918 ENGINE BASE GASKET Replaces: 27-835427003 Fits: Mercury 8/9.9 (R042475 & Up)</p>	 <p>PKG. OF 2 18-0182 18-0182-9① THERMOSTAT GASKET Replaces: 27-62386</p>	 <p>18-0323 THERMOSTAT GASKET Replaces: 27-14318-2, 27-14318 3</p>	 <p>18-0339 THERMOSTAT GASKET Replaces: 27-43006-2, 27-430066 70-90 HP</p>
 <p>18-0835 THERMOSTAT GASKET Replaces: 27-824853, 27-8248531 Fits: Mercury 9.9-60 H.P., 4-Stroke</p>	 <p>18-0292 WEAR PLATE TO PUMP HOUSING GASKET Replaces: 27-81417M</p>	 <p>18-60920 THERMOSTAT GASKET Replaces: 27-853702005 Fits: Mercury 8/9.9 (R042475 & Up)</p>	 <p>PKG. OF 2 18-0936 18-0936-9① RELIEF VALVE PLATE GASKET Replaces: 27-78690 V-6</p>	 <p>PKG. OF 2 18-0952 18-0952-9① RELIEF VALVE PLATE GASKET Replaces: 27-88907 V-6</p>
 <p>PKG. OF 2 18-2558 18-2558-9① IMPELLER GASKET Replaces: 27-19204-2 6/8/9.9/15</p>	 <p>PKG. OF 2 18-0294 18-0294-9① WEAR PLATE TO PUMP BASE GASKET Replaces: 27-81421M</p>	 <p>PKG. OF 2 18-2559 18-2559-9① IMPELLER GASKET Replaces: 27-42206, 27-19202 6/8/9.9/15</p>	 <p>PKG. OF 2 18-2561 18-2561-9① IMPELLER GASKET Replaces: 27-85087 18/25 S/N 6443972 & Below</p>	





















SEE PAGE 219 FOR OUR COMPLETE LINE OF GASKET SEALANTS

① Priced per Package

<p>PKG. OF 2</p>  <p>18-2564-1 IMPELLER GASKET 70/75/80/90/100/115 Replaces: 27-430331, 27-43033</p>	<p>PKG. OF 2</p>  <p>18-2565 18-2565-9① IMPELLER GASKET 70/75/80/90/100/115 Replaces: 27-430472, 27-430471, 27-43047</p>	<p>PKG. OF 2</p>  <p>18-2566 18-2566-9① IMPELLER GASKET 75/90/100/115 Replaces: 27-817277, 27-8172771</p>	<p>PKG. OF 2</p>  <p>18-2562 18-2562-9① IMPELLER GASKET 18/20/25 S/N 6443973 & Above Replaces: 27-993261, 27-99326</p>
<p>PKG. OF 2</p>  <p>18-2563 18-2563-9① IMPELLER GASKET 70/75/80/90/100/115 Replaces: 27-430341, 27-43034</p>	<p>PKG. OF 2</p>  <p>18-2801 18-2801-9① WATER PUMP GASKET Replaces: 27-32438 4-6 Cyl.</p>	<p>PKG. OF 2</p>  <p>18-2823 18-2823-9① LOWER WATER PUMP GASKET Replaces: 27-32769, 27-19553 40-50-70 HP</p>	<p>PKG. OF 2</p>  <p>18-2824 18-2824-9① UPPER WATER PUMP GASKET Replaces: 27-32770, 27-19551</p>
<p>PKG. OF 2</p>  <p>18-2825 18-2825-9① WATER PUMP BASE GASKET Replaces: 27-32771 40-50-70</p>	<p>PKG. OF 2</p>  <p>18-2826 18-2826-9① WATER PUMP BASE GASKET Replaces: 27-85610 1, 27-85670 4</p>	<p>PKG. OF 2</p>  <p>18-2827 18-2827-9① UPPER FACE PLATE GASKET Replaces: 27-39623 20 HP</p>	<p>PKG. OF 2</p>  <p>18-2828 18-2828-9① LOWER WATER PUMP GASKET Replaces: 27-39625 20 HP</p>
<p>18-0622 LOWER WEAR PLATE GASKET Replaces: 27-19701</p> 	<p>18-2593 WATER PUMP GASKET Replaces: 27-194541 For: 45 Jet, 50HP, 55HP, 60HP 3 cyl outboards</p> 	<p>18-0345 WATER PUMP GASKET Replaces: 27-822189 For: 25-60HP outboards, 2, 3 cyl. & 4 stroke models</p> 	<p>PKG. OF 2</p> <p>18-2841 18-2841-9① WATER PUMP BASE GASKET Replaces: 27-77417, 27-19552</p> 

SEE PAGES 219 FOR OUR COMPLETE LINE OF GASKET SEALANTS

① Priced per Package

<p>PKG. OF 2</p>  <p>18-2914 18-2914-9Ⓢ WATER PUMP GASKET Replaces: 27-856081, 27-85608, 27-32433, 27-30603, 27-8M0090319</p>	<p>PKG. OF 2</p>  <p>18-2915 18-2915-9Ⓢ WATER PUMP GASKET Replaces: 27-856091, 27-858524, 27-85609, 27-32434, 27-30604</p>	<p>PKG. OF 2</p>  <p>18-2919 18-2919-9Ⓢ WATER PUMP GASKET Replaces: 27-426311, 27-42631</p>	 <p>18-0514 WATER TUBE RUBBER SEAL Replaces: 26-25329</p>
 <p>18-0521 WATER TUBE RUBBER SEAL Replaces: 26-36557</p>	 <p>18-0563 WATER TUBE RUBBER SEAL Replaces: 26-36556</p>	 <p>18-0539 EXHAUST LEG RUBBER SEAL Replaces: 37721</p>	 <p>18-2728 WATER TUBE SEAL Replaces: 26-42102, 26-421021</p>
<p>PKG. OF 2</p>  <p>18-2560 18-2560-9Ⓢ IMPELLER GASKET Replaces: 12-86645, 12-866451, 8M0027721 18/20/25</p>	<p>PKG. OF 5</p>  <p>18-2430 18-2430-9Ⓢ 18-24301-9Ⓢ (PKG. OF 50) DRAIN SCREW GASKET Replaces: 26-830749 For: All Verado</p>	<p>PKG. OF 2</p>  <p>18-2945 18-2945-9Ⓢ DRAIN SCREW GASKET Replaces: 12-20260, 12-19183, 12-191832, 191833, F50556, F8077, F8186 Used in most lower units and sea water pumps</p>	<p>PKG. OF 2</p>  <p>18-2948 18-2948-9Ⓢ RUBBER WASHER Replaces: 12-492211, 12-49221, 12-23245 For plastic flush screw and fuel tank vent</p>
 <p>18-4261 WASHER Replaces: 19643</p>	<p>PKG. OF 4</p>  <p>18-0568-9Ⓢ INSULATOR BUSHING Replaces: 23-43045</p>	 <p>18-8305 DIVIDER PLATE SEAL Replaces: 26-814754, 428381, 42838, 69668, 88726</p>	 <p>18-4698 18-46981-9Ⓢ (PKG. OF 50) DRAIN FILL WASHER Replaces: 27-81987, 27-81987M</p>
 <p>18-4275 WASHER Replaces: 12-29245, 12-824793, 12-38753, 12-32733, 12-25945, 12-22388</p>	<p>PKG. OF 2</p>  <p>18-4858-9Ⓢ WASHER Replaces: 12-45176 Fits: Mercury Outboard 25 H.P. and Up, Mercuriser #1, R, MR, Alpha I Gen II and Bravo Drive Units</p>	 <p>18-8309 WATER COOLED REGULATOR SEAL Replaces: 18717</p>	 <p>18-2731 GROMMET Replaces: 26-81607M For: 28 HP</p>



SEE PAGES 219 FOR OUR COMPLETE LINE OF GASKET SEALANTS

Ⓢ Priced per Package

35 & 40 2 Cylinder

Serial # 2736807-G053313

50, 60, 65 3 Cylinder

Serial # 3293184-D000749

70 3 Cylinder

Serial # 4571652-6428680

40, 45, 50 4 Cylinder

Serial # 4357640 & later

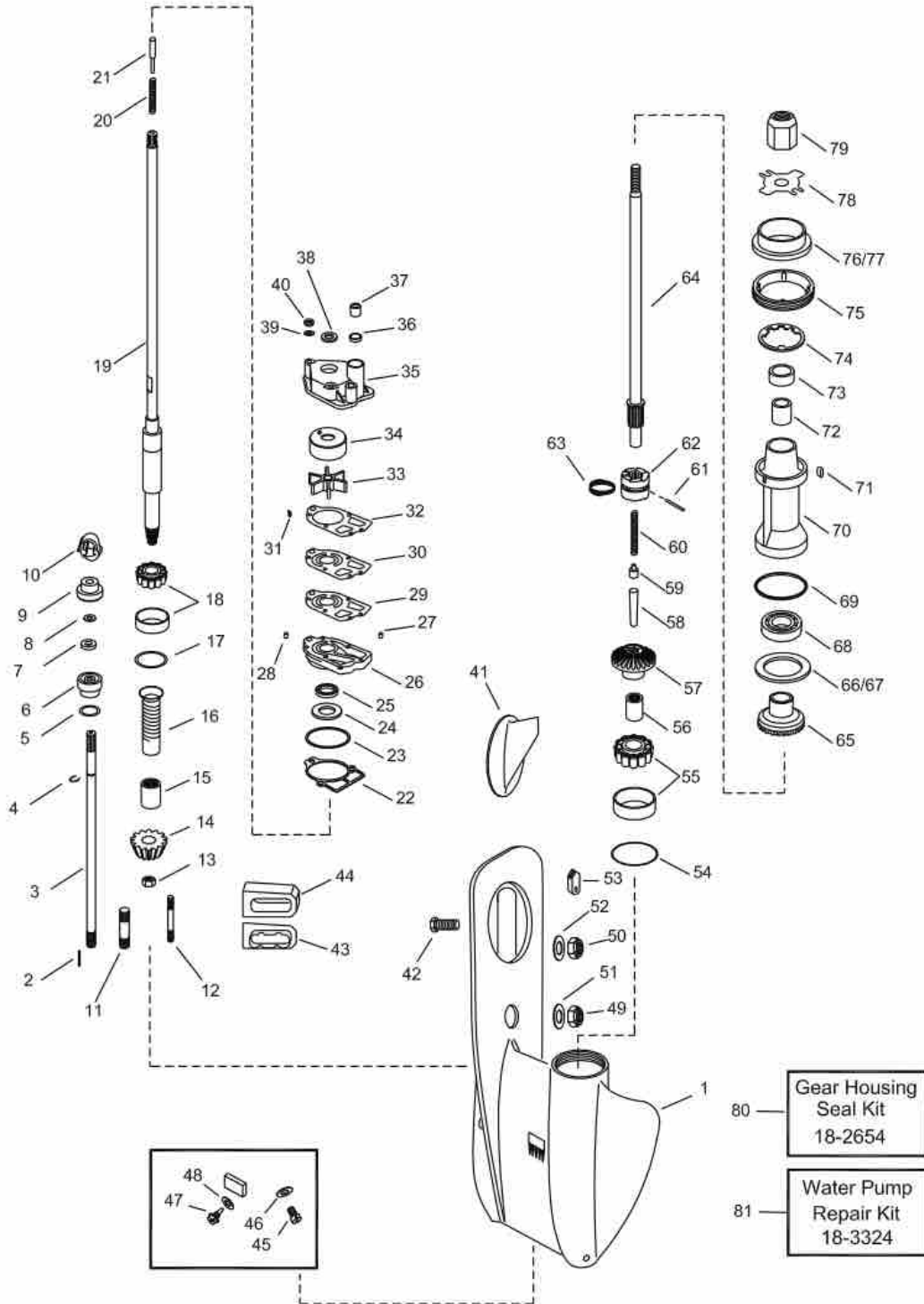

Figure #	Description	Part #	O.E.M. #	Qty.	Figure #	Description	Part #	O.E.M. #	Qty.
1	Gear Housing	—	1643-9539A1	1	48	Flush Plug Washer	18-2948	12-492211	1
2	Dowel Pin	—	17-85500	2	49	Nut	18-2361	11-34933	1
3	Shift Shaft	—	76163A1	1	50	Nut	—	1134863	1
4	E-Clip	18-4295	53-29641	1	51	Washer	—	12-65791	1
5	O-Ring	18-7153	25-25439	1	52	Washer	—	12-45175	1
6	Shift Shaft Bushing	18-2155	23-77631A2	1	53	Shift Cam	—	76039	1
7	Seal	18-2054	26-816461	1	54	Shim Set	—	15-38374A1	AR
8	Washer	18-2316	12-77674	1	55	Tapered Roller Bearing	18-1162	31-38356A1	1
9	Reverse Lock Base	—	78036	1	56	Roller Bearing	18-1096	31-21739	1
10	Reverse Lock Cam	—	433081	1	57	Forward Gear	—	43-55608A4	1
11	Stud	—	16-33778	3	58	Cam Follower	—	38441	1
12	Stud	—	16-57933	2	59	Slide	—	20843	1
13	Pinion Nut	—	11-55910	1	60	Spring	—	24-38114	1
14	Pinion Gear	—	43-98097	1	61	Cross Pin	—	17-38113	1
15	Roller Bearing	—	31-62091	1	62	Clutch	—	52-92911	1
16	Sleeve	—	88181	1	63	Spring	—	24-39845	1
17	Shim Set	—	15-92881A1	AR	64	Prop Shaft	—	44-75365	1
18	Tapered Bearing	—	31-77420A1	1	65	Reverse Gear	—	43-79158	1
19	Drive Shaft	—	45-981801	1	66	Thrust Washer	—	12-32004	1
20	Spring	—	24-20254	1	67	Shim Set	—	15-20927A1	AR
21	Pin	—	17-30545	1	68	Ball Bearing	18-1190	30-20839T	1
22	Gasket	18-2841	27-19552	1	69	O-Ring	18-7160	2531986	1
23	O-Ring	18-7115	25-26722	1	70	Bearing Carrier	—	69386A1	1
24	Seal	18-2055	26-79831	1	71	Key	—	28-30281	1
25	Seal	18-2011	26-90562	1	72	Roller Bearing	—	3121700	1
26	Water Pump Base	18-3424	46-77177A1	1	73	Seal	18-2051,	26-69188,	1
27 & 28	Pin, Dowel	—	17-35973	1			18-2052	26-619189	
29	Gasket	18-2823	27-19553	1	74	Tab Washer	—	14-53012	1
30	Face Plate	18-3107	54705	1	75	Cover Nut	—	11-87763	1
31	Key	—	28-56662	1	76	Thrust Hub	18-4233	73345A1	1
32	Gasket	18-2824	27-19551	1	77	Thrust Hub	18-3204	14-76281	1
33	Impeller	18-3007	47-89983	1	78	Tab Washer	18-3204	14-76281	1
34	Insert	18-3115	48753	1	79	Nut	18-3702	11-69578A	1
35	Water Pump body	18-3118	46-77822A1	1	80	Gear Housing Seal Kit	18-2654	26-79831A1	1
36	Nylon Washer	—	12-38453	1	81	Water Pump Repair Kit	18-3324	46-77177A3	1
37	Seal	—	26-38452	1					
38	Slinger	—	25-20273	1					
39	Washer	18-4275	12-29245	3					
40	Nut	—	11-13438	3					
41	Trim Tab	18-6011	31640A1	1					
42	Screw	—	10-66024	1					
43	Support Plate	—	92815	1					
44	Exhaust Tube Seal	18-0539	37721	1					
45	Drain Screw	18-2244	10-79953	2					
46	Drain Screw Gasket	18-2945	12-19183	2					
47	Flush Plug	—	19-48750	1					

AR As required

70, 75, 80, 90

Serial # A996142 & later

100, 115, 125

Serial # B209468 & later

4 Cylinder

- 68 — Gear Housing Seal Kit 18-2626
- 69 — Water Pump Repair Kit 18-3214

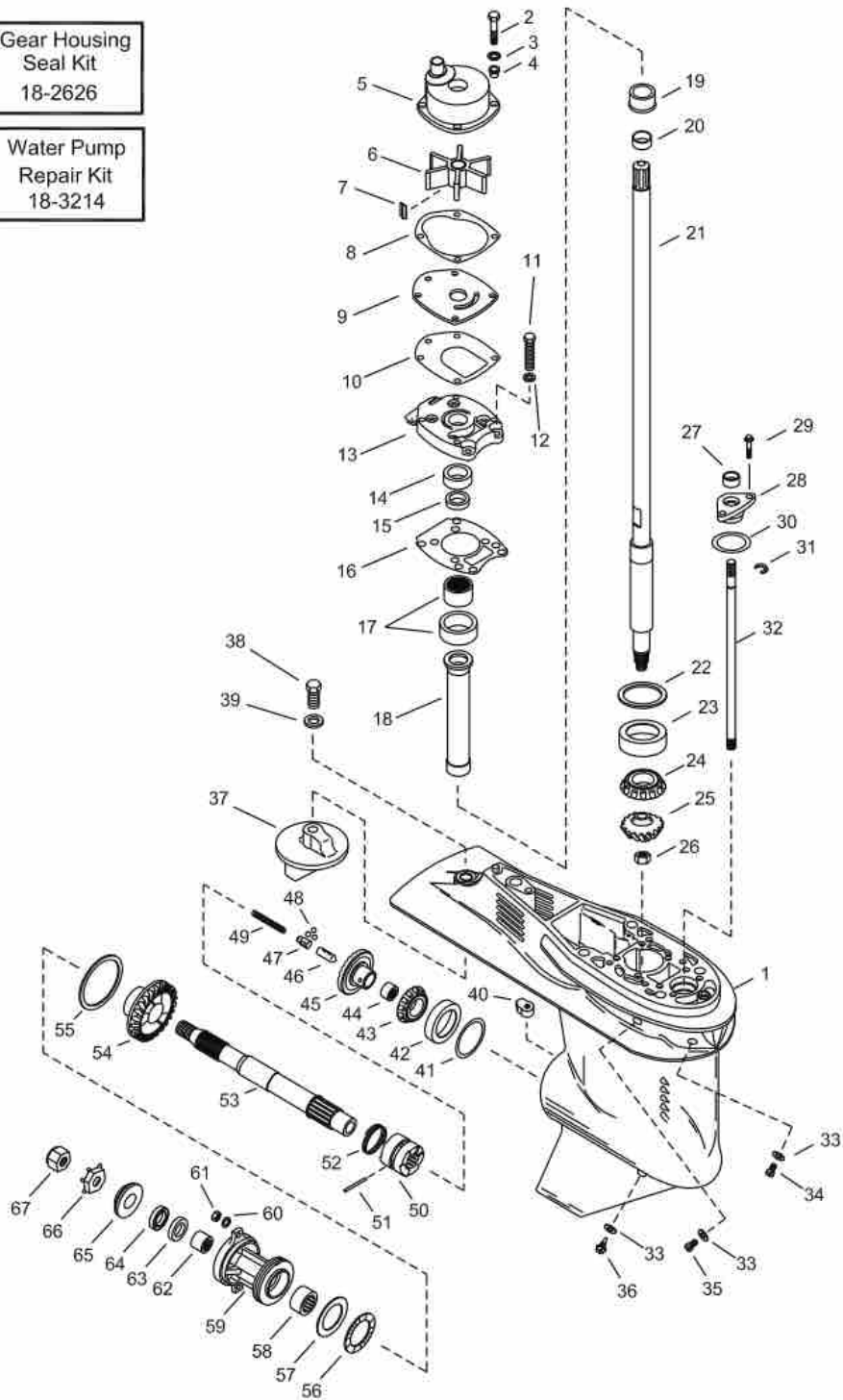

Figure #	Description	Part #	O.E.M. #	Qty.	Figure #	Description	Part #	O.E.M. #	Qty.
1	Gear Housing	—	1667-9011A73	1	49	Spring	—	24-30622	1
2	Screw	—	10-8248327	4	50	Clutch	18-2236	52-822539	1
3	Washer	18-4275	12-29245	4	51	Cross Pin	18-2357	17-30632	1
4	Insulator	18-0568	23-43045	4	52	Spring	18-2348	24-30893	1
5	Water Pump Housing	18-3572	817275A2	1	53	Prop Shaft	—	44-12238T	1
6	Impeller	18-3056	47-430262	1	54	Reverse Gear	—	43-12635	1
7	Impeller Key	18-3293	28-43037	1	55	O-Ring	18-7961	25-97386	1
8	Gasket	18-2566	27-817277	1	56	Thrust Bearing	18-1112	31-12576	1
9	Face Plate	18-3122	817276	1	57	Thrust Washer	18-1191	12-12577	1
10	Gasket	18-2564-1	27-430331	1	58	Roller Bearing	18-1113	31-12578	1
11	Screw	—	10-824832-6	6	59	Bearing Carrier	—	12596A2	1
12	Washer	18-4275	12-29245	6	60	Washer	—	12-70132	2
13	Pump Base	—	43055A4	1	61	Nut	—	11-401198	2
14	Seal	18-0583	26-43035	1	62	Roller Bearing	18-1158	31-30956	1
15	Seal	18-0522	26-43036	1	63	Seal	18-2002	26-76868	1
16	Gasket	18-2565	27-430472	1	64	Seal	18-2053	26-70081	1
17	Carrier w/Bearing	—	43040A1	1	65	Thrust Washer	18-4221	13191A1	1
18	Tube, Oiler	—	43046	1	66	Tab Washer	18-3200	14-31210	1
19	Sleeve	—	42461A1	1	67	Prop Nut	18-3700	11-52707	1
20	Ring	—	42461A1	1					
21	Drive Shaft	—	45-43031A1	1					
22	Shim Assembly	—	15-44492A1	AR					
23	Race (sold with #24)	18-1118	31-42677A1	1					
24	Bearing (sold with #23)	18-1118	31-42677A1	1					
25	Pinion Gear	—	43-44484	1					
26	Pinion Nut	18-3719	11-35921	1					
27	Seal	18-2054	26-8164641	1					
28	Bushing Assembly	—	23-43052A4	1					
29	Screw	—	10-824832-6	2					
30	O-Ring	18-7198	25-45710	1					
31	E-Ring	18-4295	53-29641	1					
32	Shift Shaft	—	43048A1	1					
33	Drain Screw Gasket	18-2945	12-19183	3					
34	Plug	—	10-28653	1					
35	Drain Screw	18-2244	10-79953	1					
36	Plug	18-2375	22-67892A1	1					
37	Trim Tab	18-6011	31640A1	1					
38	Bolt, Anode Mounting	18-6245	10-15942	1					
39	Washer, Anode Mounting	18-4858-9	12-45176	1					
40	Shim Cam	—	76039	1					
41	Shim Assembly	—	15-44491A1	AR					
42 & 43	Bearing & Race	18-1156	13-30894A1	1					
44	Roller Bearing	18-1157	31-30895	1					
45	Forward Gear	—	43-12634A2	1					
46 & 47	Cam Follower Assembly	—	12239A1	1					
48	Ball Bearing	—	30-44530	3					

AR As required

V-150

Serial # A904645 & earlier

V-175

Serial # 6648750 & earlier

V-200

Serial # 6625220 & earlier

86 — Gear Housing Seal Kit 18-2653

87 — Water Pump Repair Kit (with housing) 18-3217

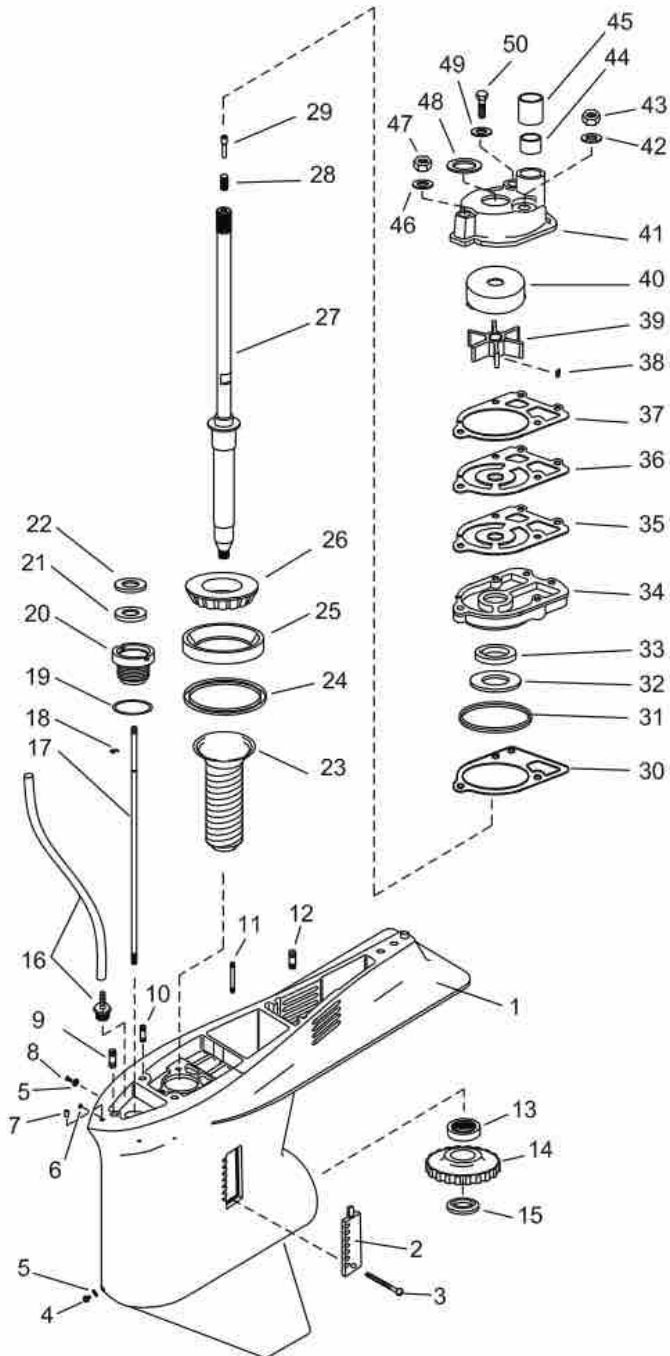

Complete Gear Housings Listed on Page 455

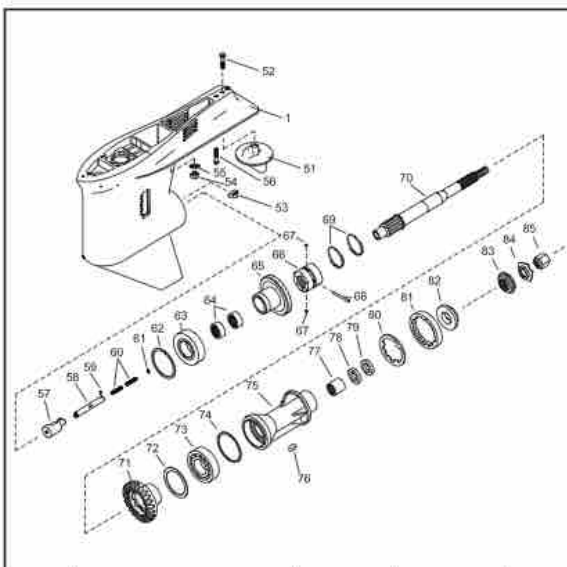

Figure #	Description	Part #	O.E.M. #	Qty.
1	Gear Housing	--	1647-9148A65	1
2	Water Insert (Starboard)	--	66885	1
	Water Insert (Port)	--	66884	1
3	Screw	18-3197	10-76156	1
4	Drain Screw	18-2375	22-67892A1	1
5	Drain Screw Gasket	18-2945	12-19183	2
6	Nut	18-2344	11-45812	1
7	Dowel Pin	--	17-43044	2
8	Drain Screw	18-2244	10-79953	1
9	Stud	--	16-78638	1
10	Stud	--	16-56297	1
11	Stud	--	16-30667	2
12	Stud	--	16-579201	2
13	Roller Bearing	--	31-35934A1	1
14	Pinion Gear	--	43-780811	1
15	Pinion Nut	18-3719	11-35921	1
16	Speedometer Tube	--	22-85822A10	1
17	Shift Shaft	--	78902 2	1
18	E-Clip	18-4295	53-29641	1
19	O-Ring	18-7153	25-25439	1
20	Shift Shaft Bushing	18-2155	23-77631A2	1
21	Seal	18-2054	26-816461	1
22	Rubber Washer	18-2316	12-77674	1
23	Sleeve	--	23-98621	1
24	Shim Assembly	18-2295	15-57007A1	AR
25	Roller Bearing	--	31-53079A1	1
26	Roller Bearing	--	31-53079A1	1
27	Drive Shaft Assembly	--	45-98682A1	1
28	Spring	--	24-34576	1
29	Pin	--	17-30545	1
30	Gasket	18-2826	27-856101	1
31	O-Ring	18-7162	25-33145	1
32	Seal	18-2014	26-89238	1
33	Seal	18-2013	26-16977	1
34	Water Pump Base	18-3416	46-96146A6	1
35	Gasket	18-2914	27-856081	1
36	Face Plate	18-3117	32435	1
37	Gasket	18-2915	27-856091	1
38	Key	--	28-56654	1
39	Impeller	18-3017	47-899842	1
40	Insert	18-3114	48752	1
41	Water Pump Body	18-3116	43-96148A1	1
42	Washer	18-4275	12-29245	3
43	Nut	18-3722	11-20361	2
44	Seal	18-3110	26-38970	1
45	Guide Sleeve	18-3109	23-29804	1
46	Washer	18-4270	12-36001	1
47	Nut	18-3722	11-45592	1
48	Slinger	18-7426	25-30271	1
49	Washer	18-4275	12-29245	3
50	Screw	--	10-96411	1
51	Trim Tab	18-6011	3164A1	1
52	Screw	--	10-66024	1
53	Shift Cam	--	78956	1
54	Nut	18-3721	11-34933	1
55	Washer	--	12-45176	2
56	Screw	--	10-65210	1
57	Cam Follower	--	89594A1	1
58	Actuator Rod	--	79911 1	1
59	Locating Pin	--	17-78906	1
60	Spring	--	24-749910	2
61	Washer	--	12-78910	1
62	Shim Assembly	18-2285	15-47397A1	AR
63	Bearing	18-1166	31-78172A1	1
64	Forward Gear	--	43-78082A3	1
65	Roller Bearing	18-1122	31-73363	2
66	Clutch	--	52-823174	1
67	Detent Pin	--	17-78909	2
68	Cross Pin	--	17-78905	1
69	Retaining Spring	--	24-78962	2
70	Prop Shaft	18-2239	44-94148	1
71	Reverse Gear	--	43-85462	1
72	Thrust Ring	--	68100 1	1
73	Ball Bearing	18-1155	30-88957	1
74	O-Ring	18-7159	25-31534	1
75	Key	--	28-30281	1
76	Roller Bearing	18-1158	31-30956	1
77	Seal (Inner)	18-2002	26-76868	1
78	Seal (Outer)	18-2053	26-70081	1
79	Tab Washer	18-2299	14-79447	1
80	Cover Nut	18-3751	79448	1
81	Thrust Hub	18-4220	13171	1
82	Spline Washer	18-3714	12-31211A2	1
83	Tab Washer	18-3200	14-31210	1
84	Prop Nut	18-3700	11-52707	1

AR As required



18-1190
BALL BEARING
Replaces: 30-20839T, 30-20839,
30-62699, F1000034
Reverse gear for Force, Mercury, Mariner
from 25-60HP (2, 3 cylinders, & 4-stroke)
including 30Jet - 45Jet



18-1191
THRUST WASHER
Replaces: 12-12577
30-125HP



18-1111
REVERSE GEAR BEARING
Replaces: 31-62799A1



18-1112
REVERSE GEAR THRUST BEARING
Replaces: 31-12576



18-1113
REVERSE GEAR BEARING
Replaces: 31-12578,
31-12578T



18-1115
PINION BEARING
Replaces: 31-32898,
31-32898T, 31-29982



18-1117
PINION BEARING
Replaces: 31-42647A1, 31-42647,
31-F694057



18-1118
DRIVE SHAFT BEARING
Replaces: 31-42677A1



18-1122
INSIDE FORWARD GEAR BEARING
Replaces: 31-73363, 31-73363T



18-1143
TAPERED ROLLER BEARING
Replaces: 31-36387A1



18-1153
BALL BEARING
Replaces: 30-63326,
30-63326T, 30-49313, 30-54215,
30-20464



18-1154
BALL BEARING
Replaces: 30-63742,
30-63742T



18-1155
BALL BEARING
Replaces: 30-88957A1,
30-88957T, 30-35914, 30-17927,
30-88957



18-1347
MAIN BEARING
Replaces: 31-88269T
For: 250/275/3.4L



18-1156
FORWARD GEAR BEARING
Replaces: 31-30894A1



18-1197
TAPERED FORWARD GEAR BEARING
Replaces: 31-828439A2
For: Alpha One Gen II (1996-97)
(s/n OF680000-0K999999)



18-1157
FORWARD GEAR INNER BEARING
Replaces: 31-30895, 31-30895T



18-1158
CARRIER BEARING
Replaces: 31-30956, 31-30956T,
31-F523058



18-1159
TAPERED ROLLER BEARING
Replaces: 31-35928A1,
31-35928T1

APPLICATION BEGINS ON NEXT PAGE



**18-1163
TAPERED ROLLER
BEARING**
Replaces: 31-48941A1

**18-1162
TAPERED ROLLER
BEARING**
Replaces: 31-38356A1, 31-F84901,
F84901, F84903

**18-1166
TAPERED ROLLER
BEARING**
Replaces: 31-78172A1

**18-1126
TAPERED ROLLER
BEARING**
Replaces: 31-54036A1



**18-1170
LOWER PINION BEARING**
Replaces: 31-812767A1

**18-0557
SEAL CARRIER**
Replaces: 888909A1
For: All Verado's
135/150/175/200/225/250/275

**18-2370
CARRIER BEARING**
Replaces: 19291A3
(For: 40/50 HP 1995-99, 70 HP 1991-95,
75 HP 1996-98) (Mercury/Mariner 30/40
HP 2 cyl 9854537-P016999, 30/40 4-stroke
G760300-up, 40/50 HP/30Jet 3 cyl 9973100-
up, 60 HP 3 cyl D000750-up, 60 HP 4-stroke
9973100-up)

Model	Serial Number	Bearing (Drive Shaft)	Bearing Pinion	Inside Bearing Forward Gear	Outside Bearing Forward Gear	Bearing Reverse Gear	Thrust Bearing Reverse Gear	Bearing Model Carrier
30 (4-stroke, Bigfoot)	G760300 & Up	18-1118	—	18-1157	18-1156	18-1113	18-1112	18-1158
30 (4-stroke, non-Bigfoot)	G760300 & Up	—	—	—	18-1107	—	—	—
30 EFI (4-stroke, Bigfoot)	T409000 & Up	18-1118	—	18-1157	18-1156	18-1113	18-1112	18-1158
30 EFI (4-stroke, non-Bigfoot)	T409000 & Up	—	—	—	18-1107	—	—	—
35 (2 cyl.)	6445653 & Up	—	—	—	18-1162	—	N/A	—
350	1960827 - 2874703	—	—	18-1162	—	N/A	—	—
400 (2 cyl.)	2874704 - 3336257	—	—	—	18-1162	—	N/A	—
402	3336258 - 4117709	—	—	—	18-1162	—	N/A	—
402	4117710 - 4860102	—	—	—	18-1162	—	N/A	—
402/40 (2 cyl.)	4860103 - 5556229	—	—	—	18-1162	—	N/A	—
40 (2 cyl.)	5556230 - G053313	—	—	—	18-1162	—	N/A	—
40 (4 cyl.)	C159200 & Up	—	—	—	18-1162	—	N/A	—
40 (4-stroke, Bigfoot)	G231123 & Up	18-1118	—	18-1157	18-1156	18-1113	18-1112	18-1158
40 (4-stroke, non-Bigfoot)	G231123 & Up	—	—	—	18-1107	—	—	—
40 (4-stroke, 4 cyl. Bigfoot)	T228405 & Up	18-1118	—	18-1157	18-1156	18-1113	18-1112	18-1158
40 (4-stroke, 4 cyl. non-Bigfoot)	T228405 & Up	—	—	—	18-1170	—	—	—
40 EFI (4-stroke, 3 cyl. non-Bigfoot)	T409000 & Up	—	—	—	18-1103	18-1190	—	—
40 EFI (4-stroke, 3 cyl. Bigfoot)	T409000 & Up	18-1118	—	18-1157	18-1156	18-1113	18-1112	18-1158
40 EFI (4-stroke, 4 cyl. non-Bigfoot)	T409000 & Up	—	—	—	18-1170	—	—	—
45 (4 cyl.)	5531630 & Up	—	—	—	18-1162	—	N/A	—
45 (Bodensee 4-stroke, Bigfoot)	G231123 - T178499	18-1118	—	18-1157	18-1156	18-1113	18-1112	18-1158
45 (Bodensee 4-stroke, non-Bigfoot)	G231123 - T178499	—	—	—	18-1103	—	—	—
500	2305101 - 2858813	—	—	—	18-1162	—	N/A	—
500	2858814 - 4140999	—	—	—	18-1162	—	N/A	—
500	4141000 - 4357639	—	—	—	18-1162	—	N/A	—
500 / 50	4357640 - 4962055	—	—	—	18-1162	—	N/A	—
500 / 50	4962056 - 5531629	—	—	—	18-1162	—	N/A	—
50 (4 cyl.)	5531630 & Up	—	—	—	18-1162	—	N/A	—
50 (3 cyl.)	6428681 - D000749	—	—	—	18-1162	—	N/A	—
50 (3 cyl.)	D000750 - G589999	—	—	—	18-1170	—	N/A	—
50 (4-stroke, Bigfoot)	G231123 & Up	18-1118	—	18-1157	18-1156	18-1113	18-1112	18-1158
50 (4-stroke, non-Bigfoot)	G231123 & Up	—	—	—	18-1107	—	—	—

① Standard Rotation Only.
 ② For Units With A Casting Number Of 1655-9572C Only.
 ③ For Units With A Casting Number Of 1674-814247C Only.

④ Two Bearings Required.
 ⑤ For 5/8 Dual Bearing Application.
 ⑥ Use 18-1155 For Counter Rotation Applications.

Model	Serial Number	Bearing (Drive Shaft)	Bearing Pinion	Inside Bearing Forward Gear	Outside Bearing Forward Gear	Bearing Reverse Gear	Thrust Bearing Reverse Gear	Bearing Model Carrier
30 (4-stroke, Bigfoot)	G780300 & Up	18-1118	—	18-1157	18-1156	18-1113	18-1112	18-1158
30 (4-stroke, non-Bigfoot)	G780300 & Up	—	—	—	18-1107	—	—	—
30 EFI (4-stroke, Bigfoot)	T409000 & Up	18-1118	—	18-1157	18-1156	18-1113	18-1112	18-1158
30 EFI (4-stroke, non-Bigfoot)	T409000 & Up	—	—	—	18-1107	—	—	—
35 (2 cyl.)	6445653 & Up	—	—	—	18-1162	—	N/A	—
350	1960827 - 2874703	—	—	18-1162	—	N/A	—	—
400 (2 cyl.)	2874704 - 3336257	—	—	—	18-1162	—	N/A	—
402	3336258 - 4117709	—	—	—	18-1162	—	N/A	—
402	4117710 - 4860102	—	—	—	18-1162	—	N/A	—
402/40 (2 cyl.)	4860103 - 5556229	—	—	—	18-1162	—	N/A	—
40 (2 cyl.)	5556230 - G053313	—	—	—	18-1162	—	N/A	—
40 (4 cyl.)	C159200 & Up	—	—	—	18-1162	—	N/A	—
40 (4-stroke, Bigfoot)	G231123 & Up	18-1118	—	18-1157	18-1156	18-1113	18-1112	18-1158
40 (4-stroke, non-Bigfoot)	G231123 & Up	—	—	—	18-1107	—	—	—
40 (4-stroke, 4 cyl. Bigfoot)	T228405 & Up	18-1118	—	18-1157	18-1156	18-1113	18-1112	18-1158
40 (4-stroke, 4 cyl. non-Bigfoot)	T228405 & Up	—	—	—	18-1170	—	—	—
40 EFI (4-stroke, 3 cyl. non-Bigfoot)	T409000 & Up	—	—	—	18-1103	18-1190	—	—
40 EFI (4-stroke, 3 cyl. Bigfoot)	T409000 & Up	18-1118	—	18-1157	18-1156	18-1113	18-1112	18-1158
40 EFI (4-stroke, 4 cyl. non-Bigfoot)	T409000 & Up	—	—	—	18-1170	—	—	—
45 (4 cyl.)	5531630 & Up	—	—	—	18-1162	—	N/A	—
45 (Bodensee 4-stroke, Bigfoot)	G231123 - T178499	18-1118	—	18-1157	18-1156	18-1113	18-1112	18-1158
45 (Bodensee 4-stroke, non-Bigfoot)	G231123 - T178499	—	—	—	18-1103	—	—	—
500	2305101 - 2858813	—	—	—	18-1162	—	N/A	—
500	2858814 - 4140999	—	—	—	18-1162	—	N/A	—
500	4141000 - 4357639	—	—	—	18-1162	—	N/A	—
500 / 50	4357640 - 4962055	—	—	—	18-1162	—	N/A	—
500 / 50	4962056 - 5531629	—	—	—	18-1162	—	N/A	—
50 (4 cyl.)	5531630 & Up	—	—	—	18-1162	—	N/A	—
50 (3 cyl.)	6428681 - D000749	—	—	—	18-1162	—	N/A	—
50 (3 cyl.)	D000750 - G589999	—	—	—	18-1170	—	N/A	—
50 (4-stroke, Bigfoot)	G231123 & Up	18-1118	—	18-1157	18-1156	18-1113	18-1112	18-1158
50 (4-stroke, non-Bigfoot)	G231123 & Up	—	—	—	18-1107	—	—	—
50 EFI (4-stroke, non-Bigfoot)	T409000 & Up	—	—	—	18-1107	—	—	—
50 EFI (4-stroke, Bigfoot)	T409000 & Up	18-1118	—	18-1157	18-1156	18-1113	18-1112	18-1158
55 (3 cyl.)	D000750 - G589999	—	—	—	18-1170	—	N/A	—
55 Seapro, Marathon, Pontoon	D000750 & Up	18-1118	—	18-1157	18-1156	18-1113	18-1112	18-1158
60 (3 cyl.)	6428681 - D000749	—	—	—	18-1162	—	N/A	—
60 (3 cyl.)	D000750 - G589999	—	—	—	18-1170	—	N/A	—
60 EFI (4-stroke, non-Bigfoot)	T409000 & Up	—	—	—	18-1103	—	—	—
60 EFI (4-stroke, Bigfoot)	T409000 & Up	18-1118	—	18-1157	18-1156	18-1113	18-1112	18-1158
650 (4 cyl.)	1542745 - 1765403	18-1153	—	18-1157	18-1156	—	N/A	18-1158
650 (4 cyl.)	2119749 - 2309310	18-1153	—	18-1157	18-1156	—	N/A	18-1158
650 (4 cyl.)	2309311 - 2452709	18-1153	—	18-1157	18-1156	—	N/A	18-1158
650 (4 cyl.)	2503991 - 2803561	18-1153	—	18-1157	18-1156	—	N/A	18-1158
650 (4 cyl.)	2803562 - 2874263	—	—	18-1157	18-1156	—	N/A	18-1158
650 (4 cyl.)	2997339 & Up	—	—	18-1157	18-1156	—	N/A	18-1158
650 (3 cyl.)	3293184 - 3525440	—	—	—	18-1162	—	N/A	—
650 (3 cyl.)	3547987 - 4571851	—	—	—	18-1162	—	N/A	—
70 (3 cyl.)	4571852 - 4977156	—	—	—	18-1162	—	N/A	—
70 (3 cyl.)	4977157 - 5579016	—	—	—	18-1162	—	N/A	—
70 (3 cyl.)	5579017 - 6428680	—	—	—	18-1162	—	N/A	—
70 (3 cyl.)	A996142 - & Up	18-1118	N/A	18-1157	18-1156	18-1113	18-1112	18-1158
75 (4 cyl.)	6432901 & Up	—	—	18-1157	18-1156	N/A	N/A	18-1158
76 (3 cyl.)	A996142 - & Up	18-1118	N/A	18-1157	18-1156	18-1113	18-1112	18-1158
800 (4 cyl.)	2559001 - 3144218	18-1153	—	18-1157	18-1156	—	N/A	18-1158
800 (4 cyl.)	3144219 - 3493912	—	—	18-1157	18-1156	—	N/A	18-1158
80 (4 cyl.)	4831999 - 6432900	—	—	18-1157	18-1156	N/A	N/A	18-1158
80 (3 cyl.)	A996142 & Up	18-1118	N/A	18-1157	18-1156	18-1113	18-1112	18-1158
850 (4 cyl.)	3493913 - 4831998	—	—	18-1157	18-1156	—	N/A	18-1158
900 (6 cyl.)	1766824 - 1869775	18-1153	—	18-1157	18-1156	—	N/A	18-1158
900/90 (6 cyl.)	4845301 - & Up	—	—	18-1157	18-1156	N/A	N/A	18-1158
90 (3 cyl.)	A996142 & Up	18-1118	N/A	18-1157	18-1156	18-1113	18-1112	18-1158

① Standard Rotation Only.
 ② For Units With A Casting Number Of 1655-9572C Only.
 ③ For Units With A Casting Number Of 1674-814247C Only.
 ④ Two Bearings Required.

⑤ For 5/8 Dual Bearing Application.
 ⑥ Use 18-1155 For Counter Rotation Applications.
 ⑦ Using pinion stamped 43-19672.

Model	Serial Number	Bearing (Drive Shaft)	Bearing Pinion	Inside Bearing Forward Gear	Outside Bearing Forward Gear	Bearing Reverse Gear	Thrust Bearing Reverse Gear	Bearing Model Carrier
100 (4 cyl.)	B209468 - & Up	18-1118	N/A	18-1157	18-1156	18-1113	18-1112	18-1158
1150	2836019 - 2933900	18-1153	—	18-1157	18-1156	—	N/A	18-1158
1150	2933901 - 3525440	18-1153	—	18-1157	18-1156	—	N/A	18-1158
1150	3525441 - 4112634	18-1153	—	18-1157	18-1156	—	N/A	18-1158
1150	4112635 - 4855152	—	—	18-1157	18-1156	—	N/A	18-1158
1150 / 115	4855153 - 5314655	—	—	18-1157	18-1156	N/A	N/A	18-1158
115 (6 cyl.)	5314656 - 5600966	—	—	18-1157	18-1156	N/A	N/A	18-1158
115 (6 cyl.)	5600967 - 6436122	—	—	18-1157	18-1156	N/A	N/A	18-1158
115 (6 cyl.)	6436123 & Up	—	—	18-1157	18-1156	N/A	N/A	18-1158
115 (4 cyl.)	C100000 & Up	18-1118	N/A	18-1157	18-1156	18-1113	18-1112	18-1158
125 (4 cyl.)	0T827234 & Below (8)	18-1118	N/A	18-1157	18-1156	18-1113	18-1112	18-1158
1250	2314956 - 2839368	18-1153	—	18-1157	18-1156	—	N/A	18-1158
1350	2839369 - 2940020	18-1153	—	18-1157	18-1156	—	N/A	18-1158
1350	2940021 - 3293233	18-1153	—	18-1157	18-1156	—	N/A	18-1158
1400	3293234 - 3502805	18-1153	—	18-1157	18-1156	—	N/A	18-1158
140	4865687 & Up	—	—	18-1157	18-1156	N/A	N/A	18-1158
1500	3502806 - 4121434	18-1153	—	18-1157	18-1156	—	N/A	18-1158
1500	4121435 - 4865677	—	—	18-1157	18-1156	—	N/A	18-1158
V-135	A904646 & Up	18-1143	18-1117	18-1122 (8)	18-1166	18-1155	N/A	18-1158
V-135	C100861 & Up	18-1143	18-1117	18-1122 (8) (9)	18-1166 (1) (2)	18-1155 (1)	N/A	18-1158
V-135	C239553 & Up	18-1143	18-1117	18-1122 (8) (9)	18-1166 (1) (2)	18-1155 (1)	N/A	18-1158
V-135	D082000 & Up	18-1143	18-1117	18-1115 (1) (2)	18-1166 (1) (2)	18-1155 (1)	N/A	18-1158
V-150	4868998 - 5432021	—	—	18-1122 (8)	18-1166	18-1155	N/A	18-1158
V-150	5432022 - 6042945	—	—	18-1122 (8)	18-1166	18-1155	N/A	18-1158
V-150	6042946 - 6443212	—	—	18-1122 (8)	18-1166	18-1155	N/A	18-1158
V-150	6443213 - 6616990	—	—	18-1122 (8)	18-1166	18-1155	N/A	18-1158
V-150	6616991 - A904645	—	—	18-1122 (8)	18-1166	18-1155	N/A	18-1158
V-150	A904646 & Up	18-1143	18-1117	18-1122 (8)	18-1166	18-1155	N/A	18-1158
V-150	C100861 & Up	18-1143	18-1117	18-1122 (8) (9)	18-1166 (1)	18-1155	N/A	18-1158
V-150	C239553 & Up	18-1143	18-1117	18-1122 (8) (9)	18-1166 (1) (2)	18-1155 (1)	N/A	18-1158
V-150	D082000 & Up	18-1143	18-1117	18-1115 (1) (2)	18-1166 (1) (2)	18-1155 (1)	N/A	18-1158
V-150XRI (EFI)	D082000 & Up	18-1143	—	18-1157	18-1156 (1)	N/A	N/A	18-1158
V-150XRI (EFI)	D082000 & Up	18-1143	18-1117	18-1115 (1) (2)	18-1166 (1) (2)	18-1155 (1)	N/A	18-1158
V-150XRI (EFI)	D082000 & Up	18-1143	18-1117	18-1115 (1) (2)	18-1166 (1) (2)	18-1155 (1)	N/A	18-1158
V-175	4301235 - 5393736	—	—	18-1122 (8)	18-1166	18-1155	N/A	18-1158
V-175	5393737 - 6618750	—	—	18-1122 (8)	18-1166	18-1155	N/A	18-1158
V-175	6618751 & Up	18-1143	18-1117	18-1122 (8)	18-1166	18-1155	N/A	18-1158
V-175	C100861 & Up	18-1143	18-1117	18-1122 (8) (9)	18-1166 (1) (2)	18-1155 (1)	N/A	18-1158
V-175	C239553 & Up	18-1143	18-1117	18-1122 (8) (9)	18-1166 (1) (2)	18-1155 (1)	N/A	18-1158
V-175	D082000 & Up	18-1143	18-1117	18-1115 (1) (2)	18-1166 (1) (2)	18-1155 (1)	N/A	18-1158
V-175XRI (EFI)	D000750 & Up	18-1143	18-1117	18-1122 (8) (9)	18-1166	18-1155	N/A	18-1158
V-175XRI (EFI)	D000750 & Up	18-1143	18-1117	18-1122 (8) (9)	18-1166	18-1155	N/A	18-1158
V-175XRI (EFI)	D082000 & Up	18-1143	—	18-1157	18-1156 (1)	N/A	N/A	18-1158
V-175XRI (EFI)	D082000 & Up	18-1143	18-1117	18-1115 (1) (2)	18-1166 (1) (2)	18-1155 (1)	N/A	18-1158
V-175XRI (EFI)	D082000 & Up	18-1143	18-1117	18-1115 (1) (2)	18-1166 (1) (2)	18-1155 (1)	N/A	18-1158
V-200	4839034 - 5363917	—	—	18-1122 (8)	18-1166	18-1155	N/A	18-1158
V-200	5363918 - 6073191	—	—	18-1122 (8)	18-1166	18-1155	N/A	18-1158
V-200	6073192 - 6203990	—	—	18-1122 (8)	18-1166	18-1155	N/A	18-1158
V-200	6203991 - 6435502	—	—	18-1122 (8)	18-1166	18-1155	N/A	18-1158
V-200	6435503 - 6625220	—	—	18-1122 (8)	18-1166	18-1155	N/A	18-1158
V-200	6625221 - C100860	18-1143	18-1117	18-1122 (8)	18-1166	18-1155	N/A	18-1158
V-200V								
V-200 (EFI)	C100861 - C291519	18-1143	18-1117	18-1122 (8)	18-1166	18-1155	N/A	18-1158
V-200 (2.5L)	C291520 - D081999	18-1143	18-1117	18-1122 (8) (9)	18-1166 (1) (2)	18-1155 (1)	N/A	18-1158
V-200	D082000 & Up	18-1143	18-1117	18-1115 (1) (2)	18-1166 (1) (2)	18-1155 (1)	N/A	18-1158
V-200XRI (EFI)	C291520 & Up	18-1143	18-1117	18-1122 (8)	18-1166	18-1155	N/A	18-1158
V-200XRI (EFI)	D082000 & Up	18-1143	—	18-1157	18-1156 (1)	N/A	N/A	18-1158
V-200XRI (EFI)	D082000 & Up	18-1143	18-1117	18-1115 (1) (2)	18-1166 (1) (2)	18-1155 (1)	N/A	18-1158
V-200XRI (EFI)	D082000 & Up	18-1143	18-1117	18-1115 (1) (2)	18-1166 (1) (2)	18-1155 (1)	N/A	18-1158
V-220	B117316 & Up	18-1143	18-1117	18-1122 (8)	18-1166	18-1155	N/A	18-1158
V-225	5628028 & Up	—	—	18-1122 (8)	18-1166	18-1155	N/A	18-1158
225	D280813 & Up	18-1143	18-1117	18-1157 (1)	18-1159 (1)	18-1155 (1)	N/A	18-1158
XR-4 (3)	B242885 & Up	18-1143	—	18-1157	18-1156	N/A	N/A	18-1158
XR-4	B242885 & Up	18-1143	—	18-1157	18-1156	N/A	N/A	18-1158
XR-4 (4)	C100861 & Up	18-1143	—	18-1157	18-1156	N/A	N/A	18-1158
XR-4 (4)	C100861 & Up	18-1143	—	18-1157	18-1156	N/A	N/A	18-1158
XR-4	C239553 & Up	18-1143	—	18-1157	18-1156	N/A	N/A	18-1158
XR-6	D082000 & Up	18-1143	—	18-1157	18-1156	N/A	N/A	18-1158

- (1) Standard Rotation Only.
- (2) For Units With A Casting Number Of 1655-9572C Only.
- (3) For Units With A Casting Number Of 1674-814247C Only.
- (4) Two Bearings Required.
- (5) For 5/8 Dual Bearing Application.
- (6) Use 18-1155 For Counter Rotation Applications.
- (7) Using pinion stamped 43-19672.



18-2244
18-22441-9(1)
(PKG. OF 50 WITHOUT GASKET)
DRAIN PLUG
• 3/8" -16 thread
Replaces: 10-20259, 10-28634, 10-28634A1, 10-79953A2, 10-79953Q2, 10-79953, 10-79953Q04, 816610A1, 816610A2, F40109, 10-F50109
Includes gasket **18-2945**

(1) Priced per Package



18-2375
18-23751-9(1)
(PKG. OF 50 WITHOUT GASKET)
DRAIN PLUG
• 3/8" -16 thread
Replaces: 10-14834, 10-14834A1, 22-67892, 22-67892A1, 22-67892A05, 22-67892A06, 28-8M0058389
Includes gasket **18-2945**

(2) Items ending in "D" are Display Packaged - Regular number is Non-Display



18-2155
SHIFT SHAFT HOUSING BUSHING
Replaces: 23-37428A1, 23-55419A1, 23-77631A2
35-200 HP



**18-3719
PINION NUT**

Replaces: 11-35921, 11-47411,
11-826375, 11-F694188
5/8" - 18 thread • 1 1/16" wrench



**18-2359
DRIVE SHAFT NUT SET**

— INCLUDES —

Sierra #	Description	Replaces:
18-3719	Pinion Nut	11-35921
18-2343	Pinion Nut Washer	12-92721
18-2343-9	Pinion Nut Washer	12-92721

© Priced per Package



**18-1736
DRIVESHAFT ASSEMBLY**

Replaces: 45-43031A1
Fits: 100 4 cyl (1988 & Up), 115 4 cyl (1989 & Up),
125 4 cyl (1994 & Up)



**18-1737
DRIVESHAFT (32 1/4" long)**

Replaces: 45-440001
Fits: V-115 DFI 2.5L (2000), V-135 (1986 & Up), V-135 DFI 2.5L (1998 & Up), V-150 (1978 & Up), V-150 EFI (1998-01), V-150 Mag/EFI (1993-95), V-150 DFI 2.5L (1998 & Up), V-150 Mag (1980-85), V-175 (1976-99), V-175 EFI (1996 & Up), V-175 Mag/EFI (1991-95), V-175 DFI 2.5L (2001 & Up), V-175 XPI EFI (1991-95), V-200 (1978 & Up), V-200 EFI (1989-01), V-200 Mag/EFI (1992-95), V-200 DFI 2.5L (2002 & Up), V-200 XR/EFI (1991-95), XR-4 (1988-91), XR-6 (1992 & Up)



**18-2239
PROP SHAFT**

Replaces: 44-94148



**18-2254
PROP SHAFT**

Replaces: 44-850308



**18-2260
PROP SHAFT**

Replaces: 44-17915



**18-2236
SLIDING CLUTCH**

Replaces: 52-12777, 52-34239, 52-814756,
52-822539, 52-822539T



**18-1550
COMPLETE GEAR SET**

Replaces: 43-850036T,
43-881260A3, 52-850048T
Forward, Pinion, Reverse and Clutch for 4 cyl.: Fits: 100 4 cyl with 6 JAW reverse clutch(1988-98), 115 4 cyl with 6 JAW reverse clutch(1989-98), 125 4 cyl with 6 JAW reverse clutch(1994-98) (2.07:1 Ratio)



**18-1551
COMPLETE GEAR SET**

Replaces: 43-803615T2,
52-859340T, 43-828175A1
Forward, Pinion, Reverse and Clutch for V-6:
Fits: V-150 (XR6, Mag III)(1997 & Up), V-150 EFI (1997 & Up), V150 DFI (1998 & Up), V-175 (1997 & Up), V-175 EFI (1997 & Up), V-175 DFI (2001 & Up), V-200 (1997 & Up), V-200EFI 2.5L (1997 & Up) (1.87:1 Ratio)



**18-1560
REVERSE GEAR**

Replaces: 43-850036T, 43-850036
Fits: 75 4-Stroke (2000-02), 90 4-Stroke (2000-02), 100 4 cyl with 6 JAW Rev Clutch (1988 & Up), 115 4 cyl with 6 JAW Rev Clutch (1989 & Up), 115 4-Stroke EFI (2001 & Up), 125 4 cyl with 6 JAW Rev Clutch (1994 & Up) (2.07:1 Ratio)



**18-1564
GEAR SET**

Replaces: 43-803615T2, 43-803615T1
Fits: V-150 (1978 & Up), V-150 EFI (1996-01), V-150 DFI 2.5L (1998 & Up), V-150 EFI 2.5L (2002 & Up), V-175 EFI (1996-01), V-175 DFI 2.5L (2001 & Up), V-175 EFI 2.5L (2002-03), V-200 (1978 & Up), V-200 EFI (1989-01), V-200 EFI 2.5L (2002 & Up) (1.87:1 Ratio)





**18-1565
CLUTCH**
Replaces: 52-859340T
Fits: V-115 DFI 2.5L (2000), V-135 (1986 & Up), V-135 DFI 2.5L (1998 & Up), V-150 (1978 & Up), V-150 EFI (1996-01), V-150 Mag/EFI (1993-95), V-150 DFI 2.5L (1996 & Up), V-150 Mag (1980-85), V-175 (1976-99), V-175 EFI (1996 & Up), V-175 Mag/EFI (1991-95), V-175



**18-1566
REVERSE GEAR**
Replaces: 43-828175A1
Fits: V-150 (1978 & Up), V-150 EFI (1996-01), V-150 DFI 2.5L (1998 & Up), V-175 (1976-99), V-175 EFI (1996-01), V-175 DFI 2.5L (2001 & Up), V-200 (1978 & Up), V-200 EFI (1989-01), V-200 EFI 2.5L (2002 & Up), XR-6 (1992-99) (1.87:1 Ratio)



**18-4830
GEAR HOUSING ASSEMBLY**
Replaces: 1667-9011G59
Fits: 100 4cyl (1988-99), 115 4cyl (1989 & Up), 115 3cyl DFI (2004 & Up), 115 EFI 4-Stroke (2001 & Up), 125 4cyl (1994 & Up), 30 4-Stroke (1999-01), 30 Carb 3cyl 4-Stroke (2002 & Up), 40 4-Stroke (1998-01), 40 4-Stroke 4cyl (2001-02), 40 Carb 3cyl 4-Stroke (2002 & Up), 40 EFI 4cyl 4-Stroke (2002 & Up), 40 Jet (2001 & Up), 45 Jet (1994-98), 50 4-Stroke (1995-00), 50 4cyl 4-Stroke (2001-02), 50 Bigfoot 4-Stroke (1995-00), 50 EFI 4cyl 4-Stroke (2002 & Up), 55 3cyl (1996 & Up), 60 3cyl (1984 & Up), 60 3cyl Bigfoot (1988), 60 4cyl 4-Stroke (2001-02), 60 EFI 4cyl 4-Stroke (2002 & Up), 65 Jet (1994 & Up), 75 3cyl (1987 & Up), 75 4-Stroke (2000 & Up), 75 3cyl 1.5L DFI (1995 & Up), 80 Jet (1994 & Up), 90 3cyl (1987 & Up), 90 4-Stroke (2000 & Up), 90 3cyl 1.5L DFI (2004 & Up) with 6 Jaw Clutch (Design II)



**18-4832
GEAR HOUSING ASSEMBLY**
Replaces: 1647-9148T93
Fits: 140 Jet (All), Magnum II (1992-99), V-115 DFI 2.5L (2000), V-135 (1986 & Up), V-135 DFI 2.5L (1998 & Up), V-150 (1978 & Up), V-150 EFI (1996-01), V-150 DFI 2.5L (1998 & Up), V-175 (1976-99), V-175 EFI (1996-01), V-175 DFI 2.5L (2001 & Up), V-200 (1978 & Up), V-200 EFI (1989-01), V-200 EFI 2.5L (2002 & Up), XR6 (1992 & Up)



**18-4851
COMPLETE GEARCASE**
Replaces: 1647-6693A3, 1647-7350A5, 1647-7350A26, 1647-8688A1, 1647-9148A69, 1647-9148A8, 1647-9148A84, 1647-9148T84, 1647-9148R84
Fits: 135/150/200/225 V6 (1.87:1 Ratio)

MERCURY OUTBOARD LOWER UNIT APPLICATIONS

Model	Serial Number	Drive Shaft	Pinion Nut	Propeller Shaft	Clutch
40 Four Stroke - BigFoot	0T178500 - 1B226999		18-3719	18-2254	—
50 Four Stroke - BigFoot	0G231123 - 1B226999		18-3719	18-2254	—
60 Sea Pro/Marathon/BigFoot	0G590000 & UP		18-3719	18-2254	④
60 Four Stroke - BigFoot	0T178500 - 1B226999		18-3719	18-2254	—
650 (4 cyl.)	1542745 - 1765403	N.L.A.	—	—	18-2236
650 (4 cyl.)	2119749 - 2309310	—	—	—	18-2236
650 (4 cyl.)	2309311 - 2452709	—	18-3719	—	18-2236
650 (4 cyl.)	2503991 - 2803561	—	18-3719	—	18-2236
650 (4 cyl.)	2803562 - 2874263	—	18-3719	—	18-2236
650 (4 cyl.)	2997339 & Up	—	18-3719	—	18-2236
70 (3 cyl.)	A996142 - & Up	—	18-3719	—	18-2236 ⑤
70 (3 cyl.)	A996142 - & Up	—	18-3719	18-2254	—
75 (4 cyl.)	6432901 & Up	—	18-3719	—	18-2236
75 (3 cyl.)	A996142 - & Up	—	18-3719	—	18-2236 ⑤
75 (3 cyl.)	A996142 - 0G760299	—	18-3719	18-2254	—
75 (3 cyl.)	0G760300 & Up	—	18-3719	18-2254	—
75 DFI	0T980000 & Up	—	18-3719	18-2254	—
75 Four Stroke	0G960500 - 0T800999	—	18-3719	18-2254	—
800 (4 cyl.)	2559001 - 3144218	—	18-3719	—	18-2236
800 (4 cyl.)	3144219 - 3493912	—	18-3719	—	18-2236
80 (4 cyl.)	4831999 - 6432900	—	18-3719	—	18-2236
80 (3 cyl.)	A996142 & Up	—	18-3719	—	18-2236 ⑤
80 (3 cyl.)	A996142 & Up	—	18-3719	18-2254	④
850 (4 cyl.)	3493913 - 4831998	—	18-3719	—	18-2236
900 (6 cyl.)	1766824 - 1869775	N.L.A.	—	—	18-2236
900/90 (6 cyl.)	4845301 - & Up	—	18-3719	—	18-2236
90 (3 cyl.)	A996142 - 0G760299	—	18-3719	—	18-2236 ⑤
90 (3 cyl.)	A996142 - 0G760299	—	18-3719	18-2254	④
90 (3 cyl.)	0G760300 & Up	—	18-3719	18-2254	—
90 DFI	0T801000 & Up	—	18-3719	18-2254	—
90 Four Stroke	0G960500 - 0T800999	—	18-3719	18-2254	—

① Long shaft only ③ Offshore only ⑤ 3 Jaw reverse clutch nut
 ② Standard rotation only ④ 6 Jaw reverse clutch ⑥ Pre-load pin, w/o driveshaft N.L.A. No longer available

APPLICATION CONTINUED ON NEXT PAGE

MERCURY OUTBOARD LOWER UNIT APPLICATIONS

Model	Serial Number	Drive Shaft	Pinion Nut	Propeller Shaft	Clutch
100 (4 cyl.)	B209468 - 0G760299	—	18-3719	—	18-2236 ①
100 (4 cyl.)	B209468 - 0G760299	—	18-3719	18-2254	— ②
100 (4 cyl.)	0G760300 & Up	—	18-3719	18-2254	—
1150	2836019 - 2933900	—	18-3719	—	18-2236
1150	2933901 - 3525440	—	18-3719	—	18-2236
1150	3525441 - 4112634	—	18-3719	—	18-2236
1150	4112635 - 4855152	—	18-3719	—	18-2236
1150 / 115	4855153 - 5314655	—	18-3719	—	18-2236
115 (6 cyl.)	5314656 - 5600966	—	18-3719	—	18-2236
115 (6 cyl.)	5600967 - 6436122	—	18-3719	—	18-2236
115 (6 cyl.)	6436123 & Up	—	18-3719	—	18-2236
115 (4 cyl.)	C100000 - 0G760299	—	18-3719	—	18-2236 ③
115 (4 cyl.)	C100000 - 0G760299	—	18-3719	18-2254	— ④
115 (4 cyl.)	0G760300 & Up	—	18-3719	18-2254	—
115 DFI	0T801000 & Up	—	18-3719	18-2254	—
115 Four Stroke	0T178500 - 0T800999	—	18-3719	18-2254	—
1250	2314956 - 2839368	—	18-3719	—	18-2236
125 (4 cyl.)	0D283222 - 0G760299	—	18-3719	—	18-2236 ⑤
125 (4 cyl.)	0D283222 - 0G760299	—	18-3719	18-2254	— ⑥
125 (4 cyl.)	0G760300 & Up	—	18-3719	18-2254	—
1350	2839369 - 2940020	—	18-3719	—	18-2236
1350	2940021 - 3293233	—	18-3719	—	18-2236
1400	3293234 - 3502805	—	18-3719	—	18-2236
140	4865687 & Up	—	18-3719	—	18-2236
1500	3502806 - 4121434	—	18-3719	—	18-2236
1500	4121435 - 4865677	—	18-3719	—	18-2236
V-135	0A904646 - 0G437999	18-1737	18-3719	18-2239	—
V-135	0G438000 - 0T178499	18-1737	18-3719	18-2239 ⑦	—
V135 DFI	G590000 - 1B417701	18-1737	18-3719	18-2239	18-1565
V140	T178500 & Up	—	18-3719	18-2239	—
V-150 (Casting # 1647-6670C)	4868998 - 0A904645	—	18-3719	—	—
V-150 (Casting #1647-8675C)	4868998 - 0A904645	—	18-3719	18-2239	—
V-150	4868998 - 0A904645	18-1737	18-3719	18-2239	—
V-150	0A904646 - 0G437999	18-1737	18-3719	18-2239	—
V-150	0G438000 & Up	18-1737	18-3719	18-2239	18-1565
V-150 XR-4 (Casting #1655-9572C)	B242885 - 0D081999	—	18-3719	—	18-2236
V-150 XR-4 (Casting #1674-814247C)	B242885 - 0D081999	—	18-3719	—	18-2236
V-150 XR-6	D082000 - 0G303045	18-1737	18-3719	18-2239	18-2236
V-150 XR-6	0G438000 & Up	18-1737	18-3719	18-2239	18-1565
V-150XRI (EFI)	D082000-0G437999	18-1737	18-3719	— ⑧	18-2236 ⑨
V-150XRI (EFI)	0G438000 & Up	18-1737	18-3719	18-2239 ⑩	18-1565
V150 DFI	G590000 & Up	18-1737	18-3719	18-2239	—
V-175	4301235 - 5393736	— ⑪	18-3719	—	—
V-175	5393737 - 6618750	— ⑫	18-3719	18-2239	—
V-175	6618751 - 0G437999	18-1737	18-3719	18-2239	—
V-175	0G438000 & Up	18-1737	18-3719	18-2239	18-1565
V-175XRI (EFI)	D000750 - 0G437999	18-1737	18-3719	18-2239	—
V-175XRI (EFI)	0G438000 & Up	18-1737	18-3719	18-2239	18-1565
V-200	4839034 - 6625220	— ⑬	18-3719	18-2239	—
V-200	6625221 - 0G437999	18-1737	18-3719	18-2239	—
V-200	0G438000 & Up	18-1737	18-3719	18-2239	18-1565
V-200 (EFI)	C100861 - 0G437999	18-1737	18-3719	18-2239	—
V-200 (EFI)	0G438000 & Up	18-1737	18-3719	18-2239	18-1565
V-200 (2.5L)	C291520 - D081999	—	18-3719	18-2239 ⑭	—
V-200 DFI	0G438000 & Up	—	18-3719	—	18-1565
V-220	B117316 & Up	—	18-3719	18-2239	—
V-225	5628028 & Up	— ⑮	18-3719	18-2239	—
225	D280813 & Up	—	18-3719	—	—
HIGH PERFORMANCE MODELS					
2.4 EFI	B290010 & Up	—	18-3719	18-2260 ⑯ ⑰	—
XR-2	B290314 - C276429	—	18-3719	18-2260 ⑱	—
MOD-VP	B290066 - C276379	—	18-3719	18-2260	—

- ① Long shaft only ③ Offshore only ⑤ 3 Jaw reverse clutch nut
 ② Standard rotation only ④ 6 Jaw reverse clutch ⑥ Pre-load pin, w/o driveshaft N.L.A. No longer available

PKG. OF 10

**18-0202-9®
INSERT**

Replaces: 8227731
 Fits: Mercury/Mariner
 25-125hp Outboards



**18-3751
SPANNER NUT**
 Replaces: 79448
 For: V-6



**18-2298
TAB WASHER**
 Replaces: 14-18323, 14-17460



**18-2299
TAB WASHER**
 Replaces: 14-79447, 14-52833



**STAINLESS STEEL
LOCKNUTS**

Part #	O.E. #	Thread Size	Std. Pkg.
*18-3720 ⑳	11-34932	3/8" - 24	1
*18-3721 ㉑	11-34933, 11-95702, 11-82671015, 11-46355, 11-33962, 11-29241, 11-24648, 11-22178, 11-21298	7/16" - 20	6
*18-3722 ㉒	11-35888, 11-20361, 11-8267089	1/4" - 28	5
*18-3723 ㉓	11-45592	5/16" - 24	1

*To order locknuts in packages of 5, add -9 to end of part number

® Priced per package



POWER TRIM HOSE

For all power trim equipped, inline engines except models with power trim pump mounted between the engine clamp brackets.

Part #	Replaces:	Description
18-2110	32-45327, 32-88005, 32-97153A1	Small Diameter 2 required per engine
18-2111	32-88006, 32-45959, 32-97154A1	Large Diameter 2 required per engine



**18-3701
PROP NUT KIT**
Replaces: 11-52707A1, 11-52707A2, 11-52707Q1

—CONTAINS—

Part #	O.E. #	Description
18-3200 (2)	14-31210, 14-816629	Tab Washer
18-3700	11-52707	Prop Nut

PKG. OF 10



**18-3200
18-3200-9②
TAB WASHER**
Replaces: 14-31210, 14-816629, 14-816629Q, 14-F697140



**18-3702
PROP NUT KIT**
Replaces: 11-69578A1, T1, Q1
—CONTAINS—

Part #	O.E. #	Description
18-3204 (2)	14-76281	Tab Washer
18-3704	11-69578	Prop Nut

PKG. OF 10



**18-3204
18-3204-9②
TAB WASHER**
Replaces: 14-76281



**18-3700
PROP NUT**
Replaces: 11-52707, 11-52707A1, 11-52707Q1, 11-52707A2, 11-827614 F7040



**18-3704
PROP NUT**
Replaces: 11-69578



**18-3703
PROP NUT**
Replaces: 11-88228
For: 9.9-25 HP 1986-Up



**18-3714
BRASS CASTLE WASHER**
Replaces: 12-31211A2, 12-31211, 12-31211A3, 12-31211Q03
For: 135-275 HP (V6 2 cycle)

TAB WASHER/PROP NUT/PROP NUT KIT APPLICATION

HP	Beg. S/N	End. S/N	Tab Washer	Prop Nut	Prop Nut Kit	HP	Beg. S/N	End. S/N	Tab Washer	Prop Nut	Prop Nut Kit	
9.9 ②	G760300	& UP	—	18-3703	—	80	2559001	& UP	18-3200	18-3700	18-3701	
15 ④	G590000	& UP	—	18-3703	—	85	1460999	3493912	18-3200	—	—	
18	5837437	& UP	—	18-3703	—	85	3493913	4831998	18-3200	18-3700	18-3701	
20	6443973	& UP	—	18-3703	—	90	1766824	4845300	18-3200	—	—	
25	6416713	& UP	—	18-3703	—	90	4845301	& UP	18-3200	18-3700	18-3701	
35	— ③	—	18-3204	18-3704	18-3702	95	1869776	2318585	18-3200	—	—	
40	— ③	—	18-3204	18-3704	18-3702	100	1464949	2484632	18-3200	—	—	
50	— ③	—	18-3204	18-3704	18-3702	100	2484633	2836018	18-3200	18-3700	18-3701	
60	— ③	—	18-3204	18-3704	18-3702	100	B209468	& UP	18-3200	18-3700	18-3701	
65	1542745	2503990	18-3200	—	—	110	1870204	2314955	18-3200	—	—	
65	2503991	3293183	18-3200	18-3700	18-3701	115	2836019	& UP	18-3200	18-3700	18-3701	
70	1482212	1566239	18-3200	—	—	125	2314956	2536209	18-3200	—	—	
70	— ③	A996141	18-3204	18-3704	18-3702	125	2536210	2839368	18-3200	18-3700	18-3701	
70	A996142	& UP	18-3200	18-3700	18-3701	135	2839369	3293233	18-3200	18-3700	18-3701	
75	6432901	& UP	18-3200	18-3700	18-3701	140	3293234	& UP	18-3200	18-3700	18-3701	
80	1405637	1566239	18-3200	—	—	150(Inline)	3502806	& UP	18-3200	18-3700	18-3701	
③ Fits most applications ④ 4-Stroke Bigfoot							V-6	All	—	18-3200	18-3700	18-3701



**18-4444
PROP WRENCH**
Replaces: 91-95830A1, 91-95830, 91-38277A1



**18-4446
PROP WRENCH KIT**
— CONTAINS —

Part #	Desc.	O.E. #	Qty.
18-3200	Tab Washer	14-31210, 14-816629	2
18-3700	Prop Nut	11-52707	1
18-4444	Prop Wrench	91-95830A1	1



**18-4459
PROP WRENCH**
Replaces: 91-821887A1, 91-859046Q4, 91-859046T4

① Items ending in "D" are Display Packaged - Regular number is Non-Display
② Priced per Package



**18-9075
SPACER**
Replaces: 23-888690
For: 2-Stroke: 115hp. - 300hp. (1993-Current)
4-Stroke: 115hp. - 225hp. (2002-Current)



**18-9076
COLLAR**
Replaces: 23-888690-1
For: 2-Stroke: 115hp. - 300hp. (1993-Current)
4-Stroke: 115hp. - 225hp. (2002-Current)



**18-9077
WAVE WASHER**
Replaces: 13-888363-2
For: 2-Stroke: 115hp. - 300hp. (1993-Current) 4-Stroke: 115hp. - 225hp. (2002-Current)



**18-9079
WAVE WASHER KIT**
Replaces:
Fits: Yamaha 2-stroke 115-300hp (1993 & Up); Yamaha 4-stroke 115-225hp (2002 & Up); Mercury 4-stroke 225 EFI S/N 0T853945 & Up



**18-9078
STAINLESS STEEL WASHER**
Replaces: 12-855692-2
For: 2-Stroke: 115hp. - 300hp. (1993-Current)
4-Stroke: 115hp. - 225hp. (2002-Current)



18-4220 
THRUST WASHER
Part # Replaces
18-4220 12-13171, 12-77987, 12-8354671,
12-77987A1, 12-835467, 12-835467Q01
V-6 Outboards & Mercruiser Stern Drives
18-4221 13191A1, 75282A1
4 & 6 Inline - 75-150 HP



**18-4233
THRUST WASHER**
Replaces: 73345, 73345A1,
12-92647M
35-70 HP



**18-9010
MOTOR FLUSHER**
Heavy Duty 



**18-3607
RETAINER BRACKET**
Replaces: 893409
For: 200/225 4-Stroke Verado (S/N OT980000 & Up), 250/275 4-Stroke Verado (S/N OT801000 & Up)



**18-79989
TRAILING STICKS**
Fits: Most outboards over 150hp with three ram integral tilt/trim.

Zinc is for saltwater only applications.
Magnesium is for fresh water only applications.
Aluminum is for brackish water or salt water environments.



**18-6156A
18-6156M
ANODE KIT**
Verado 4 cyl. All Models



**18-6157A
18-6157M
ANODE KIT**
Replaces: 8M0058677
Verado 6 cyl. All Models



② **18-6241**
③ **18-6011**
① **18-6011A**
ANODE
Replaces:
31640, 31640A1, 97-31640Q4,
97-31640B4, 31640A4, 31640A2,
31640Q, 31640Q3, 72436A1
Use on inline 3, 4 & 6 Cyl. V6



③ **18-6014**
① **18-6014A**
ANODE
Replaces:
46399A1, 822777A1, 822777Q1,
822777A4, 822777A3, 8227772,
822777, 46399A2
For use with 225 (3.0L Carb.) models



③ **18-6016**
②④ **18-60161**
②⑤ **18-60161-9**
① **18-6016A**
② **18-6244**
ANODE
Replaces:
76214, 97-76214Q5, 97-762145,
76214A5, 786214A2, 762142,
762142A1
200, 225, 250HP, V-155-V-200, & All Bravos



③ **18-6068**
ANODE
Replaces: 826134, 826134A1,
97-826134Q

 <p>③ 18-6249 ① 18-6249A ANODE Replaces: 43396A2, B18298A1, Q1 For use on transom mount bracket: 175HP/150EF/200EF (S/N OG303046 & Up)</p>	<p>① 18-6245D Display Package</p>  <p>18-6245 ANODE MOUNTING BOLT Replaces: 10-32470 For use with: 18-6011, 18-6014, 18-6016 7/16" X 1 7/8" Allen Head Cap Screw</p>	 <p>18-2599 FACE SEAL AND TOOL Replaces: 26-816575A2</p>	 <p>18-2742 SHIFT SHAFT BOOT Replaces: 85552</p>
--	---	--	---



18-2624
LOWER UNIT SEAL KIT
Replaces: 26-85090A2

— CONTAINS —

Part #	Desc.	O.E.#	Qty.
18-0579	Oil Seal	26-41131	1
18-0580	Oil Seal	26-41132	1
18-0586	Seal	26-99325	2
18-7419	O-Ring	25-69202	1
18-2562	Gear Hsg to Face Plate Gasket	27-99326-1	1
18-2945	Drain Screw Gasket	12-20260	2
18-2742	Boot	85552	1
18-2560	Washer	12-86645	2
18-7135	O-Ring	25-35276	1
18-7188	O-Ring	25-805726	2
18-7956	O-Ring	25-85549	1
18-7100	O-Ring	25-85594	1



18-2626
LOWER UNIT SEAL KIT
Replaces: 26-43035A4, 26-43034A1, 26-43034A2, 26-43034A3

— CONTAINS —

Part #	Desc.	O.E.#	Qty.
18-0522	Oil Seal	26-43036	1
18-0583	Oil Seal	26-43035	1
18-2002	Oil Seal	26-30550, 26-76868	1
18-2053	Oil Seal	26-70081	1
18-2054	Oil Seal	26-8164641	1
18-2563	Face Plate to Water Pump Cover Gasket	27-43034-1	1
18-2564-1	Water Pump Base to Face Plate Gasket	27-43033-1	1
18-2565	Water Pump Base to Gear Housing Gasket	27-43047-2	1
18-2566	Face Plate to Water Pump Cover Gasket	27-817277	1
18-2945	Drain Screw Gasket	12-19183	3
18-4261	Washer	19643	1
18-7188	O-Ring	25-805726	1
18-7198	O-Ring	25-45710	1

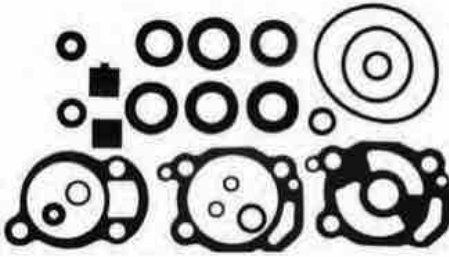

18-2627
LOWER UNIT SEAL KIT
Replaces: 26-66303A1

— CONTAINS —

Part #	Desc.	O.E.#	Qty.
18-0595	Seal	26-66303	2
18-2004	Seal, Water Pump Base	26-20070	2
18-2006	Seal, Water Pump Base	26-897154	1
18-2019	Seal	26-26805	1
18-2827	Upper Face Plate to Water Pump Gasket	27-39623	1
18-2828	Lower Water Pump Base to Face Gasket	27-39625	1
18-2945	Drain Screw Gasket	12-20260	1
18-4261	Washer	12-20262	1
18-7120	O-Ring	25-38933	1
18-7163	O-Ring	25-33465	1
18-7164	O-Ring	25-33466	1
18-7180	O-Ring	25-26802	2

① Aluminum

③ Zinc

APPLICATION BEGINS ON PAGE 463

— CONTAINS —

Part #	Desc.	O.E.#	Qty.
18-0584	Oil Seal, Prop Shaft	26-66022	1
18-2010	Seal, Wtr Pump Base	26-897153	1
18-2945	Drain Screw Gasket	12-20260	1
18-4261	Washer, Fill Screw	12-20262	1
18-7116	O-Ring	25-62704	1
18-7120	O-Ring	25-38933	1
18-7156	O-Ring	25-29439	1
18-7168	O-Ring	25-48171	1
18-7171	O-Ring	25-30529	1
18-7180	O-Ring	25-26802	1
18-8308	Seal, Shift Shaft	26-30696	1
18-8310	Seal, Water Pump Base	26-30900T	1



18-2628
LOWER UNIT SEAL KIT
Replaces: 26-77066A1

— CONTAINS —

Part #	Desc.	O.E.#	Qty.
18-2006	Seal	26-897154	2
18-2560	Washer	12-86645	2
18-2562	Gear Housing to Face Plate Gasket	27-99326-1	1
18-2742	Boot	85552	1
18-2945	Drain Screw Gasket	12-20260	2
18-7135	O-Ring	25-35276	1
18-7419	O-Ring	25-69202	1
18-7956	O-Ring	25-85549	1
18-7100	O-Ring	25-85594	1
18-8348	Slinger	25-86203	1



18-2629
LOWER UNIT SEAL KIT
Replaces: 26-85090A1

— CONTAINS —

Part #	Desc.	O.E.#	Qty.
18-0500	Seal	26-817472	1
18-0622	Gasket, Lower Wear Plate	27-19701	1
18-2051	Seal	26-69188	1
18-2052	Seal	26-69189	1
18-2945	Drain Screw Gasket	12-19183	3
18-7168	O-Ring	25-48171	2
18-7173	O-Ring	25-30224	1
18-7950	O-Ring	25-45258	1



18-2635
LOWER UNIT SEAL KIT
Replaces: 26-814669A2

— CONTAINS —

Part #	Desc.	O.E.#	Qty.
18-2563	Face Plate to Water Pump Gasket	27-43034-1	1
18-2564-1	Water Pump Base to Face Plate Gasket	22-43033-1	1
18-2945	Drain Screw Gasket	12-19183,12-20260	2
18-2599	Face Seal & Tool	26-816575A2	1
18-2014	Oil Seal	26-89238	1
18-2013	Oil Seal	26-16977	1
18-2054	Oil Seal	26-8164641	1
18-7159	O-Ring	25-31534	1
18-7176	O-Ring	25-90011	1
18-7420	O-Ring	25-21836	2
18-7440-1	O-Ring	25-36318	2



18-2642
LOWER UNIT SEAL KIT
Replaces: 26-816575A5



18-2646-1
LOWER UNIT SEAL KIT
 Replaces: 26-816575A3, 26-816575A1

— CONTAINS —			
Part #	Desc.	O.E.#	Qty.
18-2599	Face Seal and Tool	26-818575A2	1
18-2564-1	Water Pump Base To Face Plate Gasket	27-43033-1	1
18-2566	Face Plate to Water Pump Cover Gasket	27-817277	1
18-2945	Drain Screw Gasket	12-19183	1
18-2944	Seal	26-45577	1
18-2002	Oil Seal	26-30550, 26-76868	1
18-2009	Oil Seal	26-892361	1
18-2013	Oil Seal	26-16977	1
18-2014	Oil Seal	26-89238	1
18-2056	Oil Seal	26-965031	2
18-2076	Oil Seal	26-12224	1
18-2077	Oil Seal	26-14077	1
18-7159	O-Ring	25-31534	1
18-7168	O-Ring	25-48171	2
18-7176	O-Ring	25-90011	1
18-7420	O-Ring	25-21836	2
18-7440-1	O-Ring	25-36318	2
18-2056	Oil Seal	26-66302	2
18-7413	O-Ring	25-62702	2
18-2009	Oil Seal	26-892361	1
18-2430	Drain Screw Gasket	26-830749	1



18-2653
LOWER UNIT SEAL KIT
 Replaces: 26-55682A1

— CONTAINS —			
Part #	Desc.	O.E.#	Qty.
18-3110	Grommet	26-38970	1
18-2002	Oil Seal	26-30550, 26-76868	2
18-2007	Oil Seal	26-94038	1
18-2009	Oil Seal	26-892361	1
18-2013	Oil Seal	26-16977	1
18-2014	Oil Seal	26-89238	1
18-2048	Oil Seal	26-24590	1
18-2050	Oil Seal	26-55682	1
18-2053	Oil Seal	26-70081	1
18-2826	Water Pump Base to Gear Housing Gasket	27-85610-1	1
18-2914	Water Pump Gasket	27-85608-1	1
18-2915	Water Pump Gasket	27-85609-1	1
18-2948	Rubber Washer	12-49221-1	1
18-7153	O-Ring	25-25439	1
18-7157	O-Ring	25-29976	1
18-7158	O-Ring	25-30613	1
18-7159	O-Ring	25-31534	1
18-7161	O-Ring	25-32546	1
18-7162	O-Ring	25-33145	1
18-7173	O-Ring	25-30224	1
18-2801	Water Pump Gasket	27-32438	1
18-7426	O-Ring	25-30271	1
18-2945	Drain Screw Gasket	12-20260, 12-19183	2



18-2654
LOWER UNIT SEAL KIT
 Replaces: 26-79831A1

— CONTAINS —			
Part #	Desc.	O.E.#	Qty.
18-2008	Oil Seal	26-56788	1
18-2011	Oil Seal	26-90562	1
18-2048	Oil Seal	26-24590	1
18-2051	Oil Seal	26-69188	1
18-2052	Oil Seal	26-69189	1
18-2054	Oil Seal	26-816464	1
18-2055	Oil Seal	26-79831	1
18-2823	Lower Water Pump Base to Face Plate Gasket	27-32769	1
18-2824	Upper Face Plate to Pump Body Gasket	27-19551	1
18-2825	Water Pump Base Gasket	27-32770	1
18-2841	Water Pump Base Gasket	27-19552, 27-77417	1
18-2948	Rubber Washer	12-49221-1	1
18-7153	O-Ring	25-25439	1
18-7155	O-Ring	25-26855	1
18-7160	O-Ring	25-31986	1
18-7115	O-Ring	25-26722	1
18-2945	Drain Screw Gasket	12-20260, 12-19183	2



18-2655
LOWER UNIT SEAL KIT
 Replaces: 26-89238A2

— CONTAINS —			
Part #	Desc.	O.E.#	Qty.
18-2155	Bushing Gasket	23-77631A2	1
18-2919	Gasket	27-42631-1	1
18-2002	Oil Seal	26-30550, 26-76868	2
18-2013	Oil Seal	26-16977	1
18-2014	Oil Seal	26-89238	1
18-2914	Water Pump Gasket	27-85608-1	1
18-2915	Water Pump Gasket	27-85609-1	1
18-3110	Bushing	26-38970	1
18-7159	O-Ring	25-31534	1
18-7176	O-Ring	25-90011	1
18-7157	O-Ring	25-29976	1
18-7153	O-Ring	25-25439	1
18-2009	Oil Seal	26-89236	1
18-7426	O-Ring	25-30271	1
18-2945	Drain Screw Gasket	12-20260, 12-19183	2

APPLICATION BEGINS ON PAGE 463



18-2697-1
LOWER UNIT SEAL KIT
Replaces: 26-41365A3

— CONTAINS —

Part #	Desc.	O.E.#	Qty.
18-0581	Oil Seal	26-413651	2
18-0584	Oil Seal	26-66022	1
18-0585	Oil Seal	26-821928	1
18-0586	Oil Seal	26-99325	1
18-2728	Water Tube Seal	26-42102-1	1
18-2945	Drain Screw Gasket	12-19183	2
18-3149-2	Water Pump Base	46-42040A5	1
18-4261	Washer	19643	1
18-7162	O-Ring	25-33145	1



18-74501
GEAR HOUSING SEAL KIT

Replaces: 27-99049M
Fits: Mariner 9.9C & 15C models



18-2725
LOWER UNIT SEAL KIT
Replaces: 26-830749A01

For: 135/150/175 4-Stroke Verado (S/N 1B227000 & Up), 200/225 4-Stroke Verado (S/N OT980000 & Up), 250/275 4-Stroke Verado (S/N OT801000 & Up)



18-2785
LOWER UNIT SEAL KIT
Replaces: 27-41899M

— CONTAINS —

Part #	Desc.	O.E.#	Qty.
18-4698	Drain or Fill Washer Gasket	27-81987M	3
18-0554	Oil Seal	26-84813M	1
18-0296	Oil Seal	26-854017M	2



18-2787
LOWER UNIT SEAL KIT
Replaces: 27-92648M

— CONTAINS —

Part #	Desc.	O.E.#	Qty.
18-4898	Drain or Fill Washer Gasket	27-81987M	3
18-0296	Oil Seal	26-854017M	2
18-0297	Oil Seal	26-82234M	2
18-0298	O-Ring	25-82275M	1
18-0299	O-Ring	25-82289M	1
18-0292	Wear Plate to Pump Housing Gasket	27-81417M	1
18-0267	Oil Seal	26-82257M	1
18-0294	Wear Plate to Pump Base Gasket	27-81421M	1



18-8382
LOWER UNIT SEAL KIT

Replaces: 26-816575A4
For: 200 HP (T801000 & UP), 200 HP OPTIMAX DFI (G438000 & UP), 225 HP EFI (G438000 & UP), 225 HP OPTIMAX DFI (G590000-G960499), 250 HP EFI (G438000 & UP), MODELS WITH "C-3 CASTING": 200 HP OPTIMAX DFI (G386496-G437999), 225 HP (D280813-G437999), 225 HP EFI (G129222-G437999), 250 HP EFI (G129222-G437999)

GEAR HOUSING SEAL KIT APPLICATION

HP	Beg. Serial #	End. Serial #	Part #	HP	Beg. Serial #	End. Serial #	Part #
4 (1cyl)	5595532	A809600	18-2628	60 (3 cyl)	6428681	D000749	18-2654
4.5 (1 cyl)	4107220	& UP	18-2628	60 (3 cyl)	D000750	& UP	18-2635
6	A197112	& UP	18-2697-1	non-Bigfoot			
7.5	4851693	& UP	18-2628	60 (3 cyl)	D000750	& UP	18-2626
8	A197112	& UP	18-2697-1	Bigfoot			
8 Bodensee (4-stroke)	G760300	T178499	18-2697-1	60 (4-stroke)	T178500	& UP	18-2626
9.8	4839254	& UP	18-2628	Bigfoot			
9.9	A197112	& UP	18-2697-1	60 (4-stroke)	T178500	& UP	18-2635
9.9 (4-stroke) non-Bigfoot	G760300	& UP	18-2697-1	non-Bigfoot			
9.9 (4-stroke) Bigfoot	G760300	& UP	18-2624	60 Seapro/ Marathon/ Big Foot (3 cyl)	D000750	& UP	18-2626
Seapro/XR10	D038000	& UP	18-2697-1	70	4571652	A996141	18-2654
15	A197112	& UP	18-2697-1	70	A996142	& UP	18-2626
15 (4-stroke) non-Bigfoot	G760300	& UP	18-2697-1	75 (4 cyl)	6432901	& UP	18-2653
15 (4-stroke) Bigfoot				G760300	& UP	18-2624	75 (3 cyl)
Magnum/ Marathon 15XD/ Super 15	ALL		18-2624	75 (4-stroke)	G960500	& UP	18-2626
18	5837437	6443972	18-2629	80 (4 cyl)	4831999	6432900	18-2653
18	6443973	& UP	18-2624	80 (3 cyl)	A966142	& UP	18-2626
20	4709593	6443972	18-2627	90 (6 cyl)	4845301	& UP	18-2653
20	6443973	& UP	18-2624	90 (3 cyl)	A996142	& UP	18-2626
25	5705532	6443972	18-2629	90 (4-stroke)	G960500	& UP	18-2626
25	6443973	& UP	18-2624	100 (4 cyl)	B209468	& UP	18-2626
25 Lightning (3 cyl)	E268781	& UP	18-2624	115 (6 cyl)	4855153	B209467	18-2653
30 (4-stroke) (3 cyl) Bigfoot	G760300	& UP	18-2626	115 (4 cyl)	C100000	& UP	18-2626
35	6445653	& UP	18-2654	115EFI (4-stroke)	T178500	& UP	18-2626
40 (2 cyl)	4860103	G053313	18-2654	125 (4 cyl)	D283222	& UP	18-2626
40 (4 cyl)	C159200	& UP	18-2654	V-135	A904646	& UP	18-2655
40 (4-stroke) (3 cyl) Bigfoot	G760300	& UP	18-2626	V-135 DFI	G590000	& UP	18-2655
45	5531630	& UP	18-2654	140 (6 cyl)	4865678	& UP	18-2653
50 (4 cyl)	4357640	& UP	18-2654	V-150	4868648	A904645	18-2653
50 (3 cyl)	6428681	D000749	18-2654	V-150 (carb)	A904646	& UP	18-2655
50 (3 cyl)	D000750	G589999	18-2635	V-150 XR4, XR6, MAGII, III	B242885	& UP	18-2655
50 (4-stroke) (4 cyl) Bigfoot	G760300	& UP	18-2626	V-150 EFI	D820000	& UP	18-2655
50 (4-stroke) Bigfoot	G231123	& UP	18-2626	V-150 DFI	G590000	& UP	18-2655
50 (4-stroke) non-Bigfoot	T178500	& UP	18-2635	V-175	4301235	6618750	18-2653
55 (3 cyl)	D000750	& UP	18-2635	V-175 (carb)	6618751	& UP	18-2655
				V-175 XRI(EFI)	D000750	& UP	18-2655
				V-200	4839034	6625220	18-2653
				V-200 (carb)	6625221	& UP	18-2655
				V-200 XRI(EFI)	C100861	& UP	18-2655
				V-200 DFI (3.0L)	G386496	G960499	18-2642
				V-220	B117316	& UP	18-2655
				V-225	5628028	& UP	18-2653
				V-225	D280813	& UP	18-2646-1
				V-225/225 DFI	G386496	& UP	18-2642
				V-250	G386496	& UP	18-2642

MARINER LOWER UNIT SEAL KITS (Japanese Models)

Model	Serial #	O.E. Kit #	Part #
20C	(6A9-) ALL	27-41899M/27-95660M	18-2785
25C	(695-) ALL	27-41899M/27-95660M	18-2785
30A	(689-) ALL	27-41899M/27-95660M	18-2785
W48	(670-) ALL	27-92648M	18-2787
55/W55	(663-) ALL	27-92648M	18-2787
60	(675-) ALL (6F0-) ALL	27-92648M	18-2787

OIL SEALS



Part #	O.E. #	Shaft Size (in.)	Dimensions (in.)	
			O.D.	Width
18-0531	26-72785	0.790	1.880	0.248
18-0537	26-85107	1.020	1.507	0.251
18-0554	26-84813M	0.787	1.339	0.260
18-0560 ①	26-888483	1.250	1.690	0.256
18-0564 ②	26-888483	1.250	1.690	0.256
18-0579	26-41131	1.141	1.313	0.344
18-0580	26-41132	0.750	1.250	0.312
18-0581	26-413651	0.500	0.984	0.200
18-0583	26-43035	1.063	1.496	0.197
18-0584	26-66022	0.056	1.000	0.312
18-0585	26-821928	0.687	1.125	0.312
18-0586	26-99325	0.675	1.125	0.260
18-0595	26-66303	0.688	1.125	0.250
18-2002	26-76888, 26-30550	1.188	1.692	0.250
18-2004	26-20070	0.625	1.000	0.250
18-2006	26-897154	0.625	1.125	0.312
18-2008	26-56788	0.875	1.250	0.375
18-2010	26-897153	0.437	0.875	0.250
18-2053	26-70081	1.185	1.754	0.360
18-8308	26-30696	0.297	0.625	0.156
18-8310	26-30900T	0.453	0.828	0.172
18-8347	26-8164641	0.375	0.750	0.243

① Line Cutter Seal ② Pkg. of 4 ③ Metal ④ Rubber

Part #	O.E. #	Shaft Size (in.)	Dimensions (in.)	
			O.D.	Width
18-0172	26-97530	0.845	1.500	0.315
18-0267	26-82257M	0.354	0.748	0.197
18-0296	26-854017M	0.866	1.417	0.236
18-0297	26-82234M	0.906	1.457	0.236
18-0515	26-30530	0.540	1.004	0.303
18-0516	26-30913	0.500	0.639	0.187
18-0517	26-32911	1.100	1.260	0.127
18-0518 ②	26-34217	0.282	0.394	0.083
18-0519	26-14240	3.782	4.536	0.482
18-0522	26-43036	1.045	1.474	0.187
18-0523	26-43993	1.640	2.132	0.282
18-0525	26-45587	0.390	0.628	0.124
18-0526	26-48443	0.750	1.379	0.256
18-0527	26-56397	0.750	1.127	0.343
18-0529	26-62818	1.640	2.256	0.319

POWERHEAD SEALS APPLICATION

HP	Cyl.	Beginning Serial No.	Ending Serial No.	Upper Crankshaft	Qty.	Lower Crankshaft	Qty.
3.5	1	6202173	UP	—	—	18-0527	1
3.6	1	5404657	UP	—	—	18-0527	1
4	1	2771622	4107219	—	—	18-0527	1
4	1	5589202	UP	18-0515	1	—	—
4.5	1	4107220	UP	—	—	18-0527	1
7.5/9.8/110	2	2810637	3274633	—	—	18-0527	1
10/15/20/25	2	1290910	1499331	—	—	18-2013	1
20	2	1558310	2031773	—	—	18-2013	2
20	2	2031774	2827677	—	—	18-2013	2
18,20,25XD	2	6443973	UP	—	1	18-0537	1
20 JET	2	G053314	UP	—	1	18-0537	1
30	2	1271885	1356947	18-2016	1	18-2016	1
30JET	2	C159200	UP	18-2016	1	18-2016 ①	2
MK 35 A	2	1217222	1271884	18-2016	1	18-2016	1
35	2	1356948	1571113	18-2016	1	18-2016	1
35	2	1571114	2874703	—	—	18-2016 (lower)	1
35	2	6445653	UP	18-2016	1	18-2016	2
40	4	1279685	2874703	18-2016	1	18-2016	1
40	2	2874704	3336257	18-2016	1	18-2016	2
40	2	3336258	4117709	18-2016	1	18-2016	1
40	2	4117710	5556229	18-2016	1	18-2016	1
40	2	5556230	6445653	18-2016	1	18-2016	2
40	4	C159200	UP	18-2016	1	18-2016 ①	2
45	4	1476510	1531568	18-2016	1	18-2016	1
45	4	5531630	UP	18-2016	1	18-2016	2
45 JET	3	ALL	—	—	—	18-2016 (inner)	1
50	4	1421113	2858813	18-2016	1	18-2016 (inner)	1
50	4	2855514	UP	18-2016	1	18-2016	2
50/60	3	6428681	D000750	18-2016	1	18-2016	2
50/55/60	3	D000750	UP	—	—	18-2016 (inner)	1
60	6	1303411	1542744	18-2016	1	18-2016	1
65	4	1542745	2803561	18-2016	1	18-2016 (inner)	1
65	4	2803562	3293183	18-2016	1	18-2016	2
65	3	3293184	3547986	18-2016	1	18-2016	2
65	3	3547987	4571651	18-2016	1	18-2016	2
65 JET	3	D283222	UP	18-0523	1	18-2016	1

① Fits most models

POWERHEAD SEALS APPLICATION

HP	Cyl.	Beginning Serial No.	Ending Serial No.	Upper Crankshaft	Qty.	Lower Crankshaft	Qty.
70	6	1296411	1566239	18-2016	1	18-2016 (inner)	1
70	3	4571852	6428680	18-2016	1	18-2016	2
70	3	A996142	UP	18-0523	1	18-2016	1
75	4	6432901	A996141	18-2016	1	18-2016	2
75	3	A996142	D283221	18-0523	1	18-2016	1
75	3	D283222	UP	18-0523	1	18-2016	1
80	6	1335465	1566239	18-2016	1	18-2016	1
80	4	2559001	4831998	18-2016	1	18-2016	2
80	4	4831999	UP	18-2016	1	18-2016	2
80	3	A996142	UP	18-0523	1	18-2016	1
80 JET	4	D283222	UP	18-0523	1	18-2016	1
85	6	1460999	1766823	18-2016	1	18-2016	1
85	4	3493913	4831998	18-2016	1	18-2016	2
90	6	1766824	1869775	18-2016	1	18-2016 (outer)	1
90	6	4845301	A996141	18-2016	1	18-2016	2
90	3	A996142	D283221	18-0523	1	18-2016	1
90	3	D283221	UP	18-0523	1	18-2016	1
95	6	1869776	2318585	18-2016	1	18-2016 (inner)	1
100	6	1464949	2836018	18-2016	1	18-2016	1
100BP	6	2641855	3253111	18-2016	1	18-2016	2
100	4	B209468	D283221	18-0523	1	18-2016	1
100	4	D283222	UP	18-0523	1	18-2016	1
105JET	V-6	D082000	UP	18-2016	1	18-2016	2
110	6	1870204	2314955	18-2016	1	18-2016	1
115	6	2836019	3525440	18-2016	1	18-2016	2
115	6	3525441	C100000	18-2016	1	18-2016	2
125	6	2314956	3253111	18-2016	1	18-2016 (inner)	1
135	6	2839369	3293233	18-2016	1	18-2016	2
135	V-6	A904646	UP	18-2016	1	18-2016	2
140	6	3293234	UP	18-2016	1	18-2016	2
140JET	V-6	D082000	UP	18-2016	1	18-2016	2
150	6	3502806	5327662	18-2016	1	18-2016	2
150	V-6	4868998	6042945	18-2016	1	18-2016	2
150	V-6	6042946	UP	18-2016	1	18-2016	2
175	V-6	4301235	5875203	18-2016	1	18-2016	2
175	V-6	5875204	6618751	18-2016	1	18-2016	2
175	V-6	6618751	UP	18-2016	1	18-2016	2
200	V-6	4839034	5875303	18-2016	1	18-2016	2
200	V-6	5875303	6073191	18-2016	1	18-2016	2
200	V-6	6073192	UP	18-2016	1	18-2016	2
220	V-6	B117316	UP	18-2016	1	18-2016	2
225	V-6	5628028	UP	18-2016	1	18-2016	2

① Fits most models

LOWER UNIT SEALS APPLICATION

HP	Beginning Serial No.	Ending Serial No.	Prop Shaft Inner/Outer	Water Pump Base Upper/Lower	Water Pump Housing	Shift Shaft
3.5/3.8	5404657	UP	-	18-2010	18-0516	-
3.9	1655013	2498135	18-0515	-	18-0516	-
4	2498136	5589201	18-0515	-	18-0516	-
4	5589202	5595531	-	18-2010	18-0516	-
4/4.5	5589203	A809601	-	18-2010	18-0516	-
6	1408611	2529894	18-0515	-	18-0516	-
7.5	2529895	3801457	18-0515	-	18-0516	-
7.5	3801458	5206549	-	-	18-0516	-
7.5	5206550	UP	-	18-2010	18-0516	-
9.8	1470349	3795657	18-0515	-	18-0516	-
9.8	3795658	5206549	-	-	18-0516	-
9.8	5206550	UP	-	18-2010	18-0516	-
18	5837437	6443972	-	18-2006/18-2006	-	-
20	1558310	1866494	18-2019/18-2019	18-2006	18-2004	-
20	1866495	6443972	18-2019/18-2019	18-2004/18-2006	18-2004	-
25	5705532	6443972	-	18-2006/18-2006	-	-
30	1271885	1356947	18-2011	18-2011	18-2015	18-2009
30	G055314	UP	18-2051/18-2052	-	-	-
MK 35A	1217222	1271884	18-2011	18-2011	18-2015	18-2009
35	1356948	1448139	18-2011	18-2011	18-2015	18-2009
35	1571114	1960826	18-2011	18-2011	18-2017	18-2009
35	1960827	2874703	18-2011/18-2015	18-2011/18-2055	18-2017	18-2009
35	6445653	UP	18-2051/18-2052	18-2011/18-2055	-	18-2054
40	1279685	2874703	18-2011	18-2011	18-2015	18-2009
40	2874704	3336257	18-2008	18-2011/18-2055	18-2017	18-2009
40	3336258	4117709	18-2008	18-2011/18-2055	18-2017	18-2048
40	4117710	4860102	18-2051/18-2052	18-2011/18-2055	-	18-2009/18-2048

② .438 ID ONLY

LOWER UNIT SEALS APPLICATION (Cont.)

HP	Beginning Serial No.	Ending Serial No.	Prop Shaft Inner/Outer	Water Pump Base Upper/Lower	Water Pump Housing	Shift Shaft
40	4860103	6445652	18-2051/18-2052	18-2011/18-2055	-	18-2054
40 4cyl	C159200	G053313	18-2051/18-2052	18-2011/18-2055	-	18-2054
40 2cyl	G055314	UP	18-2051/18-2052	-	-	-
45	1476510	1531568	18-2011	18-2011	18-2017	18-2009
45 4cyl	5531630	UP	18-2051/18-2052	18-2011/18-2055	-	18-2054
50	1421113	1639472	18-2011	18-2011	18-2017	18-2009
50	1639473	1770178	18-2011	18-2011	18-2017	18-2009
50	1770179	2305100	18-2011/18-2015	18-2011/18-2055	18-2017	18-2009
50	2305101	2858813	18-2011/18-2015	18-2011/18-2055	18-2017	18-2048
50	2858814	4140999	18-2008	18-2011/18-2055	18-2017	18-2009/18-2048
50	4141000	4962055	18-2051/18-2052	18-2011/18-2055	-	18-2009/18-2048
50	4962056	5531630	18-2051/18-2052	18-2011/18-2055	-	18-2054
50 3cyl	6428681	D000750	18-2051/18-2052	18-2011/18-2055	-	18-2054
50/55/60 3 cyl	D000751	UP	18-2051/18-2052	-	-	18-2054
60	1303411	1542744	-	18-2011	18-2015	-
60	6428681	D000750	18-2051/18-2052	18-2011/18-2055	-	18-2054
65	1542745	2874263	18-2002/18-2002	18-2007	18-2013	18-2009
65	2874263	3293183	18-2002/18-2002	18-2007/18-2050	18-2013	18-2009/18-2048
65 3cyl	3293184	4136684	18-2008	18-2011/18-2055	18-2017	18-2009/18-2048
65 3cyl	4136685	4571651	18-2051/18-2052	18-2011/18-2055	18-2017	18-2009/18-2048
70	1296411	1413610	18-2011	-	18-2015	-
70	1413611	1566239	18-2002/18-2002	18-2007	18-2013	18-2009
70 3cyl	4571652	4977156	18-2051/18-2052	18-2011/18-2055	-	18-2009/18-2048
70 3cyl	4977157	5579016	18-2051/18-2052	18-2011/18-2055	-	18-2054
70 3cyl	5579017	A996142	18-2051/18-2052	18-2011/18-2055	-	18-2009
70/75 3cyl	A996142	UP	18-2002/18-2053	18-0522 (lower)	-	-
75 4cyl	6432901	A996142	18-2002/18-2053	18-2013/18-2007	-	18-2054
80	1335465	1398629	18-2002/18-2002	18-2007	18-2013	18-2009
80	1398630	1566239	18-2002/18-2002	18-2007	18-2013	18-2009
80 4cyl	2559001	3144218	18-2002/18-2002	18-2013/18-2007	18-2013	18-2009/18-2048
80 4cyl	3144219	4831998	18-2002/18-2002	18-2050/18-2007	18-2013	18-2009/18-2048
80 4cyl	4831999	5582561	18-2002/18-2002	18-2013/18-2007	-	18-2054
80 4cyl	5582562	A996142	18-2002/18-2053	18-2013/18-2007	-	18-2054
80 3cyl	A996142	UP	18-2002/18-2053	18-0522 (lower)	-	-
85	1460999	1766823	18-2002/18-2002	18-2007	18-2013	18-2009
85 4cyl	3493913	4590511	18-2002/18-2002	18-2050/18-2007	-	18-2009/18-2048
85 4cyl	4590512	4831998	18-2002/18-2002	18-2013/18-2007	-	18-2009/18-2048
90	1766824	1869775	18-2002/18-2002	18-2013/18-2007	18-2013	18-2009
90	4845301	5594656	18-2002/18-2002	18-2013/18-2007	-	18-2054
90	5594657	A996142	18-2002/18-2053	18-2013/18-2007	-	18-2054
90 3cyl	A996142	UP	18-2002/18-2053	18-0522 (lower)	-	-
95	1869776	2318585	18-2002/18-2002	18-2013/18-2007	18-2013	18-2009/18-2048
100,100SS	1464949	2836018	18-2002/18-2002	18-2013/18-2007	18-2013	18-2009
100BP	2399698	2641854	18-2002/18-2002	18-2013/18-2007	18-2013	18-2009/18-2048
100 4cyl	B209468	UP	18-2002/18-2053	18-0522 (lower)	-	-
110	1870204	2314955	18-2002/18-2002	18-2013/18-2007	18-2013	18-2009/18-2048
115	2836019	3525440	18-2002/18-2002	18-2013/18-2007	18-2013	18-2009/18-2048
115	3525440	4112634	18-2002/18-2002	18-2013/18-2007	-	18-2009/18-2048
115	4112635	4855152	18-2002/18-2002	18-2013/18-2007	-	18-2009/18-2048
115	4855153	5600966	18-2002/18-2002	18-2013/18-2007	-	18-2054
115	5600967	C100000	18-2002/18-2053	18-2013/18-2007	-	18-2054
115 4cyl	C100000	UP	18-2002/18-2053	18-0522 (lower)	-	-
125	2314956	2839368	18-2002/18-2002	18-2013/18-2007	18-2013	18-2009
135	2839369	3293233	18-2002/18-2002	18-2013/18-2007	18-2013	18-2009
140	3293234	3502805	18-2002/18-2002	18-2013/18-2007	18-2013	18-2009/18-2048
140	4865678	UP	18-2002/18-2002	18-2013/18-2007	-	18-2054
150	3502806	4121434	18-2002/18-2002	18-2013/18-2007	-	18-2009/18-2048
150	4121434	5327662	18-2002/18-2002	18-2013/18-2007	-	18-2009/18-2048

V-6'S

150/150XR2	4868998	5432021	18-2002/18-2002	18-2013/18-2014	-	18-2054
150/150XRS	5432021	A904646	18-2002/18-2002	18-2013/18-2014	-	18-2054
135/150/XR2	A904646	UP	18-2002/18-2002	18-2013/18-2014	-	18-2054
175	4301235	6618750	18-2002/18-2002	18-2013/18-2014	-	18-2054
175	6618751	UP	18-2002/18-2002	18-2013/18-2014	-	18-2054
200	4839034	6073191	18-2002/18-2002	18-2013/18-2014	-	18-2054
200	6073192	UP	18-2002/18-2002	18-2013/18-2014	-	18-2054
220	B117316	UP	18-2002/18-2002	18-2013/18-2014	-	18-2054
225	5628028	D280813	18-2002/18-2002	18-2013/18-2014	-	18-2054
250/275	C101891	UP	18-2002/18-2002	-	-	18-2054
3.4	5611648	UP	18-2002/18-2002	-	-	18-2054

POWER TRIM OIL SEAL

H.P.	Beginning S/N	Ending S/N	Oil Seals	Qty.	Desc.
115	2836019	3525440	18-2048	1	Starboard Mounting Bracket
140	3293234	UP	18-2048	1	Starboard Mounting Bracket
150	3502806	4865677	18-2048	1	Starboard Mounting Bracket
150 XS	4868648	5327662	18-2048	1	Starboard Mounting Bracket

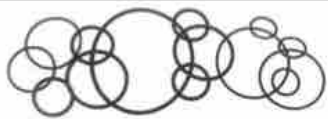
		DIMENSIONS (in.)		Part #	O.E. #	DIMENSIONS (in.)	
		O.D.	Width			O.D.	Width
				18-7166 (2) (4)	25-45254	0.615	0.065
				18-7167 (2) (4)	25-861844	3.809	0.139
				18-7168 (2) (4)	25-20587, 25-21720, 25-26834, 25-46171, 25-801334436	0.37	0.065
				18-7169 (2) (4)	25-35984, 25-70937	3.5	0.135
				18-7170 (2) (4)	25-33504	1.965	0.135
				18-7171 (2) (4)	25-30529	1.92	0.1
				18-7172 (2) (4)	25-31305	3.25	0.135
				18-7173 (2) (4)	25-27018, 25-30224Q	1.875	0.135
				18-7174 (2) (4)	25-45711	0.62	0.1
				18-7175 (2) (4)	25-62817	3.75	0.27
				18-7176 (2) (4)	25-896523, 25-F74305, F74305-1, F74305, F6M4555	2.16	0.1
				18-7177 (2) (4)	25-53421, 25-59712	2.625	0.065
				18-7180 (2) (4)	12-31060, 25-26802, 25-8M2000926	0.445	0.09
				18-7188 (2)	25-805726	0.961	0.0635
				18-7195 (2)	25-9M0027717	2.75	0.07
				18-7198 (2) (4)	25-45710	1.43	0.1
				18-7410 (2) (4)	25-36390	0.676	0.07
				18-7411 (2) (4)	25-35480, 25-47385, 25-8M2000816	1.25	0.1
				18-7413 (2) (4)	22-22175, 25-62702, 25-F50342-1, F50342, F17510	0.301	0.07
				18-7414 (2) (4)	25-82384, 25-823683	1.989	0.07
				18-7419 (2) (4)	25-69202	2.675	0.103
				18-7420 (2) (4)	25-21836	0.706	0.139
				18-7421 (2) (4)	25-16524	0.15	0.065
				18-7426 (3) (4)	25-30271	0.74	0.31
				18-7440-1 (3)	25-36318	0.799	0.103
				18-7448 (1)	25-97387	4.467	0.103
				18-7458 (1)	20311, 25-20826	2.234	0.139
				18-7484 (1)	25-38685, 25-848361	4.234	0.139
				18-7487 (2) (4)	25-54030, 25-F523555, F523555	2.867	0.103
				18-7474 (1)	25-94288	1.239	0.07
				18-7956 (3) (4)	25-85549	2.48	0.1969
				18-7100 (2) (4)	25-85594	0.2362	0.1575
				18-7961	25-47254	3.65	0.135
				18-76995	25-803513007	1.220	0.095
Part #	O.E. #	DIMENSIONS (in.)					
		O.D.	Width				
18-0856 (2) (4)	25-54029	2.800	0.103				
18-0860 (2) (4)	25-62700	3.237	0.103				
18-7102 (2) (4)	25-62706	0.426	0.07				
18-7103 (2) (4)	25-29545	0.924	0.103				
18-7105 (2) (4)	25-62705, 25-F7848342	0.75	0.065				
18-7107 (2) (4)	25-67202	4.75	0.135				
18-7114 (2) (4)	25-29145, 25-843315, 25-F762738	1	0.135				
18-7115 (1)	25-28722	1.735	0.135				
18-7116 (1)	25-20633, 25-22174, 25-82704, 25-85148, 25-F24342, 8022568	0.96	0.1				
18-7117 (1)	25-35027	1.046	0.139				
18-7120 (1)	25-38933	0.215	0.065				
18-7121 (1)	25-35028, 25-882613, 802231	3.1	0.135				
18-7124		2.5	0.103				
18-7125		2.3	0.103				
18-7135 (1)	25-20365, 25-35276	0.75	0.135				
18-7143 (2) (4)	27-58025, 25-65936, 391-5081	1.31	0.1				
18-7145 (2) (4)	25-64068	0.25	0.1				
18-7146 (2) (4)	25-47632	1.12	0.1				
18-7151 (2) (4)	25-20081, 25-39572	3	0.135				
18-7152 (2) (4)	25-20863	2.625	0.135				
18-7153 (2) (4)	25-25439, 25-20679, 25-F53795-1, F53795	0.962	0.103				
18-7156 (2) (4)	25-26855	1.62	0.135				
18-7156 (2) (4)	25-29439	1.185	0.1				
18-7157 (2) (4)	25-29976	3.5	0.21				
18-7158 (2) (4)	25-30613, 25-846357	0.74	0.1				
18-7159 (2) (4)	25-31534, 25-48451	3.855	0.21				
18-7160 (2) (4)	25-31986	2.635	0.21				
18-7161 (2) (4)	25-32546	3.25	0.07				
18-7162 (2) (4)	25-32424, 25-33145	3.025	0.135				
18-7163 (2) (4)	25-33465, 25-853220, 25-807149	2.415	0.1				
18-7164 (2) (4)	25-33466, 25-67675, 25-846356, 27-898101789	1.375	0.1				
18-7165 (2) (4)	25-45253, 25-806609, 25-F461342	0.5	0.065				
18-7165 (2) (4)	25-32509	0.5	0.065				

① Pkg. of 1 ② Pkg. of 5 ③ Pkg. of 2

MARINER O-RINGS (Japanese Models)

Part No.	O.E. No.	Dimensions		Part No.	O.E. No.	Dimensions	
		I. D.	Width (mm)			I. D.	Width (mm)
18-0298	25-82275M	41.50	3.0	18-0299	25-82289M	66.04	5.33

POWERHEAD SEALS & O-RING APPLICATION

Model	Beginning Serial #	Ending Serial #	Lower O-Ring	Lower Oil Seal	Upper O-Ring	Upper Oil Seal
3.5 (1cyl)	6202173	& UP	N/A	N.L.A.	18-7152	N/A
3.9 (39) (1cyl)	1655013	2498135	N/A	N.L.A.	18-7152	N.L.A.
4 (1cyl)	1655013	2498135	N/A	N/A	18-7152	N/A
4 (40) (1cyl)	2498136	2693114	N/A	N.L.A.	18-7152	N.L.A.
4 (1cyl)	2771622	4107219	N.L.A.	N/A	18-7152	N.L.A.
4 (40) (2cyl)	5589202	& UP	18-7102	N/A	N/A	18-0515
4.5 (4.5, 45) (1cyl)	4107220	4597261	N/A	N/A	18-7152	N.L.A.
4.5 (4.5, 45) (1cyl)	4597262	5595531	N/A	N.L.A.	18-7152	N/A
4.5 (4.5, 45) (1cyl)	5595532	& UP	N/A	N.L.A.	18-7152	N/A
6 (60)	1916139	2529894	N/A	N.L.A.	18-7459	N.L.A.
6 (2cyl)	1408611	2529894	N/A	N/A	18-7152	N/A
7.5 (75)	2529895	2721150	N/A	N.L.A.	18-7152	N.L.A.

④ This product is priced per piece. To order priced per package, please add -9 to the part number.

POWERHEAD SEALS & O-RING APPLICATION

Model	Beginning Serial #	Ending Serial #	Lower O-Ring	Lower Oil Seal	Upper O-Ring	Upper Oil Seal
7.5 (2cyl)	2810637	3801457	N/A	N.L.A	18-7152	N/A
7.5 (75) (2cyl)	3274633	& UP	N/A	N/A	18-7152	N/A
7.5 (7.5, 75)	3801458	& UP	N/A	N/A	18-7152	N/A
9.8 (110)	1865779	2798058	N/A	N.L.A	18-7152	N.L.A
9.8 (110)	2798057	3795657	N/A	N.L.A	18-7152	N/A
9.8 (2cyl)	2810637	3274633	N/A	N/A	18-7152	N/A
9.8 (9.8, 110)	3795658	& UP	N/A	N/A	18-7152	N/A
9.8 (2cyl)	3274633	& UP	N/A	N/A	18-7152	N/A
10 (100)	1290910	1499331	N/A	18-2026	N.L.A.	N.L.A
110 (2cyl)	2810637	3274633	N/A	N/A	18-7152	N/A
110 (2cyl)	3274633	& UP	N/A	N/A	18-7152	N/A
15 (150)	1290910	1499331	N/A	18-2026	N.L.A.	N.L.A
15 (SEA PRO)	G044365	G437999	N/A	18-0537	N/A	N/A
15 (SEA PRO)	G438000	& UP	N/A	26-12566 1	N/A	N/A
15 (SUPER)	B238464	& UP	N/A	18-0537	N/A	N/A
15 (18, 18XD)	5837437	& UP	N/A	18-0537	N/A	N/A
20 (200)	1290910	1499331	N/A	18-2026	N.L.A.	N.L.A
20 (200)	1558310	2031773	N/A	18-2026	N.L.A.	N/A
20 (2cyl)	2031774	2827677	N/A	N/A	18-7151	N/A
20 (20, 200)	2827677	6443972	N/A	18-2056	18-7151	N/A
20 (20, 20XD)	6443973	T800749	N/A	18-0537	N/A	N/A
20 JET	G044027	& UP	N/A	18-0537	N/A	N/A
25 (250)	1290910	1499331	N/A	18-2026	N.L.A.	N.L.A
25 (25, 25XD) (2cyl)	5705532	& UP	N/A	18-0537	N/A	N/A
30 (2cyl)	1271885	1448139	18-7151	N.L.A	18-7151	18-2016
30 (2cyl) 644cc	G053314	& UP	18-7176	18-2016	N/A	N/A
30 (2cyl) 430cc	G575500	& UP	N/A	18-2016	N/A	N/A
30 JET (4cyl)	C159200	D279349	18-7161	18-2016	18-7151	18-2016
30 JET (4cyl)	D279350	& UP	18-7161	18-2016	18-7151	18-2016
30 JET (3cyl)	G531301	& UP	18-7176	18-2016	N/A	N/A
MK 35A (2cyl)	1217222	1271884	18-7151	N/A	18-7151	N/A
35 (350)	1271884	1448139	18-7151	N.L.A	18-7151	18-2016
35 (2cyl)	1368948	1571113	18-7151	N/A	18-7151	N/A
35 (2cyl)	1571114	2874703	18-7151	N/A	18-7172	N.L.A
35 (2cyl)	6445653	& UP	18-7414	18-2016	18-7167	18-2016
40 (402) (2cyl)	1279685	1476509	18-7151	N/A	18-7151	18-2016
40 (4cyl)	1279685	2874703	18-7151	N/A	18-7151	N/A
40 (2cyl)	2874704	3336257	N/A	18-2016	18-7167	18-2016
40 (2cyl)	3336258	3346479	N/A	18-2016	18-7961	18-2016
40 (2cyl)	3336258	4117709	N/A	N/A	18-7167	N/A
40 (2cyl)	4117710	& UP	18-7414	18-2016	18-7167	18-2016
40 (2cyl)	5556230	6445653	18-7414	N/A	18-7167	N/A
40 (4cyl)	C159200	D279349	18-7161	18-2016	18-7151	18-2016
40 (402) (2cyl)	3477010	4117709	N/A	18-2016	N/A	18-2016
40 (2cyl) 644cc	G053314	& UP	18-7176	18-2016	N/A	N/A
40 (4cyl)	D279350	& UP	18-7161	18-2016	18-7151	18-2016
40 (3cyl)	G531301	& UP	18-7176	18-2016	N/A	N/A
45 (450) (4cyl)	1476510	1531568	18-7151	N.L.A	18-7151	18-2016
45 (4cyl)	5531630	& UP	18-7151	18-7151	18-7151	18-2016
45 JET	D000750	G589999	18-7176	18-2016	18-7176	N/A
45 JET	G590000	& UP	18-7176	18-2016	N/A	N/A
50 (500) (4cyl)	1421113	1639472	18-7151	18-7151	18-7151	18-2016
50 (500) (4cyl)	1639473	2858813	18-7151	N/A	18-7151	18-2016
50 (50, 500) (4cyl)	2855614	& UP	18-7151	18-2016	18-7151	18-2016
50 (3cyl)	D000750	G589999	18-7176	18-2016	N/A	N/A
50 (3cyl)	6428681	D000750	18-7161	18-2016	N/A	18-2016
50 (3cyl)	D000750	& UP	18-7176	N/A	N/A	N/A
50 (3cyl)	G590000	& UP	18-7176	18-2016	N/A	N/A
55 (3cyl)	D000750	G589999	18-7176	18-2016	N/A	N/A
55 (3cyl)	G590000	& UP	18-7176	18-2016	N/A	N/A
60 (3cyl)	6428681	D000749	18-7161	18-2016	N/A	18-2016
60 (3cyl)	D000750	& UP	18-7176	N/A	N/A	N/A
60 (600) (4cyl)	1303411	1542744	18-7151	N/A	18-7151	18-2016
60 (3cyl)	D000750	G589999	18-7176	18-2016	N/A	N/A
65 (650) (4cyl)	1542745	2803561	18-7151	N/A	18-7172	18-2016
65 (650) (4cyl)	2803562	3203183	18-7151	18-2016	18-7172	18-2016
65 (650) (3cyl)	3293184	4571651	18-7161	18-2016	18-7167	18-2016
65 (3cyl)	3547987	4571651	18-7161	N/A	N/A	N/A
65 JET	D283222	& UP	N/A	18-2016	18-7414	18-0523
70 (700) (6cyl)	1296411	1566239	18-7151	N/A	18-7151	18-2016
70 (3cyl)	4571652	6428680	18-7161	18-2016	N/A	18-2016
70 (3cyl)	A996142	B240450	N/A	18-2016	18-7414	18-0523

APPLICATION CHART CONTINUES ON NEXT PAGE

POWERHEAD SEALS & O-RING APPLICATION (Cont.)

Model	Beginning Serial #	Ending Serial #	Lower O-Ring	Lower Oil Seal	Upper O-Ring	Upper Oil Seal
70 (3cyl)	B240451	& UP	18-0858	18-2016	18-7414	18-0523
75 (4cyl)	6432901	& UP	18-7161	18-2016	18-7961	18-2016
75 (3cyl)	C222000	& UP	N/A	18-2016	18-7414	18-0523
80 (800) (6cyl)	1335465	1566239	18-7151	N/A	18-7151	18-2016
80 (800) (4cyl)	2559001	3493912	18-7151	18-2016	18-7961	18-2016
80 (80, 800) (4cyl)	4831999	6432900	18-7161	18-2016	18-7961	18-2016
80 (3cyl)	A996142	B240450	N/A	18-2016	18-7414	18-0523
80 (3cyl)	B240451	& UP	18-0858	18-2016	18-7414	18-0523
80 JET	D283222	G760299	N/A	18-2016	18-7414	18-0523
80 JET w/ROUND UPPER O-RING	G760300	& UP	N/A	18-2016	18-7414	18-0523
80 JET w/SQUARE UPPER O-RING	G760300	& UP	N/A	18-2016	N/A	18-0523
85 (850) (6cyl)	1460999	1464848	18-7151	N/A	18-7151	18-2016
85 (850) (6cyl)	1566240	1766823	18-7151	N/A	N.L.A.	18-2016
85 (850) (4cyl)	3493913	4831998	18-7161	18-2016	18-7961	18-2016
90 (900) (6cyl)	1766824	1869775	18-7151	N/A	N.L.A.	18-2016
90 (90, 900) (6cyl)	4845301	& UP	18-7161	18-2016	18-7961	18-2016
90 (3cyl)	A996142	B240450	N/A	18-2016	18-7414	18-0523
90 (3cyl)	B240451	C221999	18-0858	18-2016	18-7414	18-0523
90 (3cyl)	C222000	& UP	N/A	18-2016	18-7414	18-0523
95 (950) (6cyl)	1869776	2318585	18-7151	N/A	N.L.A.	18-2016
100 (1000) (6cyl)	1464949	2318585	18-7151	N/A	N.L.A.	18-2016
100 (1000SS) (6cyl)	2318586	2413847	18-7151	N/A	N.L.A.	18-2016
100 (1000SS) (6cyl)	2484633	2836018	18-7151	18-2016	N.L.A.	18-2016
100 (1000BP) (6cyl)	2399698	2641854	18-7151	18-2016	N.L.A.	18-2016
100 (1000BP) (6cyl)	2641855	3253111	18-7151	18-2016	18-7961	18-2016
100 (4cyl)	B209468	G760299	N/A	18-2016	18-7414	18-0523
100 w/ROUND UPPER O-RING (4cyl)	G760300	& UP	N/A	18-2016	18-7414	18-0523
100 w/SQUARE UPPER O-RING (4cyl)	G760300	& UP	N/A	18-2016	25-858225	18-0523
110 (1100)	1870201	2314955	18-7151	N/A	N.L.A.	18-2016
115 (1150) (6cyl)	2836019	3525440	18-7151	18-2016	18-7961	18-2016
115 (115, 1150) (6cyl)	3525441	& UP	18-7161	18-2016	18-7961	18-2016
115 (4cyl)	C100000	G760299	N/A	18-2016	18-7414	18-0523
115 w/ROUND UPPER O-RING (4cyl)	G760300	& UP	N/A	18-2016	18-7414	18-0523
115 w/SQUARE UPPER O-RING (4cyl)	G760300	& UP	N/A	18-2016	N/A	18-0523
115 DFI (1.5L)	T801000	& UP	N/A	18-2016	N/A	N/A
115 PRO XS	B751825	& UP	N/A	18-2016	N/A	N/A
125 (1250) (6cyl)	2314956	2839368	18-7151	N/A	18-7961	18-2016
125 (4cyl)	D283222	G760299	N/A	18-2016	18-7414	18-0523
125 w/ROUND UPPER O-RING (4cyl)	G760300	& UP	N/A	18-2016	18-7414	18-0523
125 w/SQUARE UPPER O-RING (4cyl)	G760300	& UP	N/A	18-2016	N/A	18-0523
135 (1350) (6cyl)	2839369	3293233	18-7151	18-2016	18-7961	18-2016
140 (140, 1400) (6cyl)	3293234	& UP	18-7161	18-2016	18-7961	18-2016
150 (1500) (6cyl)	3502806	4865677	18-7161	18-2016	18-7961	18-2016
150 (1500XS) (6cyl)	4868648	5327662	18-7161	18-2016	18-7961	18-2016
V-105 JET	D082000	& UP	18-0860	18-2016	18-0858	18-2016
V-135 CARB w/1.50 ID UPPER BRG	A904646	C100860	18-0860	18-2016	18-0858	18-2016
V-135 CARB w/1.37 ID UPPER BRG	A904646	C100860	18-0860	18-2016	18-0858	18-2016
V-135 CARB	C100861	& UP	18-0860	18-2016	18-0858	18-2016
V-135 CARB	C239553	& UP	18-0860	18-2016	18-0858	18-2016
V-135 DFI	G590000	& UP	18-0860	18-2016	18-0858	18-2016
V-140 JET	D082000	& UP	18-0860	18-2016	18-0858	18-2016
V-150 (V-1500) CARB	4868998	A904645	N/A	18-2016	N/A	18-2016
V-150 w/1.50 ID UPPER BRG	A904646	C100860	18-0860	18-2016	18-0858	18-2016
V-150 w/1.37 ID UPPER BRG	A904646	C100860	18-0860	18-2016	18-0858	18-2016
V-150 CARB	C100861	C239552	18-0860	18-2016	18-0858	18-2016
V-150 XR4 / MAGNUM II	B242885	C239552	18-0860	18-2016	18-0858	18-2016
V-150 CARB	C239553	& UP	18-0860	18-2016	18-0858	18-2016
V-150 XR4 / 6 MAG II, III	C239553	& UP	18-0860	18-2016	18-0858	18-2016
V-150 EFI	D082000	& UP	18-0860	18-2016	18-0858	18-2016
V-150 DFI	G590000	& UP	18-0860	18-2016	18-0858	18-2016
V-175 (V-175, 1750) CARB	4301235	5393736	N/A	18-2016	N/A	18-2016
V-175 CARB	5393737	6618750	N/A	18-2016	N/A	18-2016
V-175 CARB	6618751	C239552	18-0860	18-2016	18-0858	18-2016
V-175 CARB	C239553	& UP	18-0860	18-2016	18-0858	18-2016
V-175 EFI	D000750	& UP	18-0860	18-2016	18-0858	18-2016
V-175 DFI	T178500	& UP	18-0860	18-2016	18-0858	18-2016
V-175 PRO XS	B516339	& UP	18-0860	18-2016	18-0858	18-2016
V-200 (V-200, 2000) CARB	4839034	5363917	25-67207	18-2016	N/A	18-2016
V-200 CARB	5363918	6073191	N/A	18-2016	N/A	18-2016
V-200 CARB	6073192	C291519	18-0860	18-2016	18-0858	18-2016
V-200 CARB	C291520	& UP	18-0860	18-2016	18-0858	18-2016
V-200 EFI	C100861	C291519	18-0860	18-2016	18-0858	18-2016

APPLICATION CHART CONTINUES ON NEXT PAGE

POWERHEAD SEALS & O-RING APPLICATION

Model	Beginning Serial #	Ending Serial #	Lower O-Ring	Lower Oil Seal	Upper O-Ring	Upper Oil Seal
V-200 EFI (2.5L)	C291520	& UP	18-0860	18-2016	18-0858	18-2016
V-200 DFI	G386496	& UP	18-0860	N/A	18-7414	N/A
V-200 PRO XS	B504989	& UP	18-0860	N/A	18-7414	N/A
V-200 LASER	B117316	& UP	18-0860	18-2016	18-0858	18-2016
V-225 (2.4L)	5628028	& UP	18-0860	18-2016	N/A	18-2016
V-225 (3.0L) SEA PRO / MARATHON CARB	G245605	G303045	18-0860	N/A	18-7414	N/A
V-225 (3.0L) SEA PRO / MARATHON CARB	G303046	& UP	18-0860	N/A	18-7414	N/A
V-225 DFI	G590000	& UP	18-0860	N/A	18-7414	N/A
V-225 PRO XS	B104549	& UP	18-0860	N/A	18-7414	N/A
V-225 EFI	G129222	G303045	18-0860	N/A	18-7414	N/A
V-225 EFI	G303046	& UP	18-0860	N/A	18-7414	N/A
V-250 w/o UPPER BEARING FITTING	C101891	& UP	N/A	N.L.A	18-7414	18-2016
V-250 w/UPPER BEARING FITTING	C101891	& UP	N/A	N.L.A	18-7414	18-2016
V-250 EFI	G129222	G303045	18-0860	N/A	18-7414	N/A
V-250 EFI	G303046	& UP	18-0860	N/A	18-7414	N/A
V-250 DFI	B528615	& UP	18-0860	N/A	18-7414	N/A
V-250 PRO XS	B426561	& UP	18-0860	N/A	18-7414	N/A
V-275 CARB w/o UPPER BEARING FITTING	C101891	& UP	N/A	N.L.A	18-7414	N/A
V-275 CARB w/UPPER BEARING FITTING	C101891	& UP	N/A	N.L.A	18-7414	N/A
V-300 (3.4L)	5611648	& UP	N/A	N.L.A	18-7414	N/A

① Requires 2 ② Shift Shaft Retainer ④ Fits most applications

LOWER UNIT O-RING APPLICATION

HP	Beg. S/N	End S/N	Bearing Carrier	Water Pump Base	Shift Shaft	Drive Shaft
3.9	1655013	2498135	18-7121	18-7156	18-7180	18-7168
4	2498136	5589201	18-7121	18-7156	18-7180	18-7168
4/4.5	5589203	A809601	18-7173	18-7156	18-7180	-
6	1408611	2529894	18-7171	18-7156	18-7180	18-7168
6	A197112	UP	18-7162	-	-	-
7.5	2529895	3801457	18-7171	18-7156	18-7180	18-7168
7.5	3801458	5206549	18-7171	18-7156	18-7180	-
7.5	5206550	UP	18-7171	18-7156	18-7180	18-7116
8	A197112	UP	18-7162	-	-	-
9.8	1470349	3795657	18-7171	18-7156	18-7180	18-7168
9.8	3795658	5206549	18-7171	18-7156	18-7180	-
9.8	5206550	UP	18-7171	18-7156	18-7180	18-7116
9.9/15	A197112	UP	18-7162	-	-	-
18	5837437	6443972	-	18-7419	-	-
20	1558310	1866494	18-7163	18-7164	18-7180	18-7180
20	1866495	6443972	18-7163	18-7164	18-7180	18-7180
25	5705532	6443972	-	18-7419	-	-
18/20/25XD	6443973	UP	-	18-7419	18-7135 ②	-
30	1271885	1356947	18-7152	18-7115	18-7153	-
30	G055314	UP	-	-	18-7155 ②	-
MK 35A	1217222	1271884	18-7152	18-7115	18-7153	-
35	1356948	1448139	18-7152	18-7115	18-7153	-
35	1571114	1960826	18-7160	18-7155	18-7153	-
35	1960827	2874703	18-7160	18-7155	18-7153	-
35	6445653	UP	18-7160	18-7115	18-7153	-
40	1279685	2874703	18-7152	18-7115	18-7153	-
40	2874704	3336257	18-7160	18-7155	18-7153	-
40	3336258	4117709	18-7160	18-7155	18-7153	-
40	4117710	4860102	18-7160	18-7155	18-7153	-
40	4860103	6445652	18-7160	18-7115	18-7153	-
40 4cyl	C159200	G055313	18-7160	18-7115	18-7153	-
40 2cyl	G055314	UP	-	-	18-7155 ②	-
45	1476510	1531588	18-7160	18-7155	18-7153	-
45 4cyl	5531630	UP	18-7160	18-7115	18-7153	-
50	1421113	1639472	18-7152	18-7155	18-7153	-
50	1639473	1770178	18-7160	18-7155	18-7153	-

① Requires 2 ② Shift Shaft Retainer ④ Fits most applications

LOWER UNIT O-RING APPLICATION

HP	Beg. S/N	End S/N	Bearing Carrier	Water Pump Base	Shift Shaft	Drive Shaft
50	1770179	2305100	18-7160	18-7155	18-7153	-
50	2305101	2858813	18-7160	18-7155	18-7153	-
50	2858814	4140999	18-7160	18-7155	18-7153	-
50	4141000	4962055	18-7160	18-7155	18-7153	-
50	4962056	5531630	18-7160	18-7155	18-7153	-
50 3cyl	6428681	D000750	18-7160	18-7155	18-7153	-
50/55/60 3 cyl	D000751	UP	-	18-7173	-	-
60	1303411	1542744	-	18-7115	-	-
60	6428681	D000750	18-7160	18-7155	18-7153	-
65	1542745	2874263	18-7157	18-7173	18-7153	18-7158
65	2874263	3293183	18-7157	18-7162	18-7153	18-7158
65 3cyl	3293184	4136684	18-7160	18-7155	18-7153	-
65 3cyl	4136685	4571651	18-7160	18-7155	18-7153	-
70	1296411	1413610	18-7114	18-7155 ①	-	-
70	1413611	1566239	18-7157	18-7173	18-7153	18-7158
70 3cyl	4571652	4977156	18-7160	18-7155	18-7153	-
70 3cyl	4977157	5579016	18-7160	18-7115	18-7153	-
70 3cyl	5579017	A996142	18-7160	18-7115	18-7153	-
70/75 3cyl	A996142	UP	-	-	18-7198	-
75 4cyl	6432901	A996142	18-7157	18-7162	18-7153	-
80	1335485	1398629	18-7157	18-7155	18-7153	18-7158
80	1398630	1566239	18-7157	18-7173	18-7153	18-7158
80 4cyl	2559001	3144218	18-7157	18-7173	18-7153	18-7158
80 4cyl	3144219	4831998	18-7157	18-7162	18-7153	-
80 4cyl	4831999	5582561	18-7157	18-7162	18-7153	-
80 4cyl	5582562	A996142	18-7157	18-7162	18-7153	-
80 3cyl	A996142	UP	-	-	18-7198	-
85	1460999	1766823	18-7157	18-7173	18-7153	18-7158
85 4cyl	3493913	4590511	18-7157	18-7162	18-7153	-
85 4cyl	4590512	4831998	18-7157	18-7162	18-7153	-
90	1766824	1869775	18-7157	18-7162	18-7153	18-7158
90	4845301	5594656	18-7157	18-7162	18-7153	-
90	5594657	A996142	18-7157	18-7162	18-7153	-
90 3cyl	A996142	UP	-	-	18-7198	-
95	1869776	2318585	18-7157	18-7173	18-7153	18-7158
100,100SS	1464949	2836018	18-7157	18-7173	18-7153	18-7158
100BP	2399698	2641854	18-7157	18-7173	18-7153	18-7158
100 4cyl	B209468		-	-	18-7198	-
110	1870204	2314955	18-7157	18-7173	18-7153	18-7158
115	2836019	3525440	18-7157	18-7173	18-7153	18-7158
115	3525440	41122634	18-7157	18-7173	18-7153	-
115	41122635	4855152	18-7157	18-7162	18-7153	-
115	4855153	5600966	18-7157	18-7162	18-7153	-
115	5600967	C100000	18-7157	18-7162	18-7153	-
115 4cyl	C100000	UP	-	-	18-7198	-
125	2314956	2839368	18-7157	18-7173	18-7153	18-7158
135	2839369	3293233	18-7157	18-7173	18-7153	18-7158
140	3293234	3502805	18-7157	18-7173	18-7153	-
140	4865678	UP	18-7157	18-7162	18-7153	-
150	3502806	4121434	18-7157	18-7173	18-7153	-
150	4121434	5327662	18-7157 ②	18-7162	18-7153	-
V-6						
HP	Beg. S/N	End S/N	Bearing Carrier	Water Pump	Shift Shaft	Drive Shaft
150/150XR2	4869998	5432021	18-7159	18-7162	18-7153	-
150/150XRS	5432021	A904646	18-7159	18-7176	18-7153	-

① Requires 2 ② Shift Shaft Retainer ③ Fits most applications

V-6 (Cont.)

HP	Beg. S/N	End S/N	Bearing Carrier	Water Pump	Shift Shaft	Drive Shaft
135/150/XR2	A904646	UP	18-7159	18-7176	18-7153	-
175	4301235	6618750	18-7159	18-7162	18-7153	-
175	6618751	UP	18-7159	18-7176	18-7153	-
200	4839034	6073191	18-7159	18-7162	18-7153	-
200	6073192	UP	18-7159	18-7176	18-7153	-
220	B117316	UP	18-7159	18-7176	18-7153	-
225	5628028	D280813	18-7159	18-7162	18-7153	-
250/275	C101891	UP	18-7159	-	18-7153	-
3.4	5611648	UP	18-7159	-	18-7153	-

SWIVEL BRACKET ASSEMBLY O-RING APPLICATION

HP	Beg. S/N	End S/N	O-Ring	Qty	Desc	HP	Beg. S/N	End S/N	O-Ring	Qty	Desc
3.9	1655013	2498105	18-7153	2	SB	V 135	A904646	UP	18-7174	1	TT
4	2498136	3529445	18-7153	1	SB	V 150	4868998	UP	18-7164	1	SB
6	1436115	2529894	18-7153	2	SB	V 150	5432022	6605990	18-7168	2	TLL
7.5	2529895	3488152	18-7153	2	SB	V 150	6443213	UP	18-7174	1	TT
9.9	1470349	3482752	18-7153	2	SB	V 175	4301235	UP	18-7164	1	SB
35 ①	B110789	C159199	18-7164	1	SB,U	V 175	5488752	6618750	18-7168	2	TLL
35 ①	B110789	C159199	18-7174	1	TT	V 175	6618751	UP	18-7174	1	TT
45 4 Cyl ①	B110789	UP	18-7174	1	TT	V 200	4839034	UP	18-7164	1	SB
45 4 Cyl ①	B110789	UP	18-7164	1	SB,U	V 200	5464486	6625220	18-7168	2	TLL
50 3 Cyl ①	B122930	C160935	18-7164	1	SB,U	V 200	6625221	UP	18-7174	1	TT
50 3 Cyl ①	B122930	C160935	18-7174	1	TT	V 200 EFI	C100861	UP	18-7174	1	TT
60 3 Cyl ①	B122930	C160935	18-7174	1	TT	V 200 EFI	C100861	UP	18-7164	1	SB
60 3 Cyl ①	B122930	C160935	18-7164	1	SB,U	V 220	B117316	UP	18-7174	1	TT
70	A996142	UP	18-7174	2	TT	V 220	B117316	UP	18-7164	1	SB
70	A996142	UP	18-7164	1	SB	V 225	5628028	UP	18-7164	1	SB
75	6432901	UP	18-7174	2	TT	V 225	5628028	UP	18-7168	2	TLL
75	6432901	UP	18-7164	1	SB	V 250	C101891	UP	18-7168	2	TLL
80	A996142	UP	18-7164	1	SB	V 250	C101891	UP	18-7174	1	TT
80	A996142	UP	18-7174	2	TT	V 275	C101891	UP	18-7174	1	TT
90	6436123	UP	18-7164	1	SB	V 275	C101891	UP	18-7168	2	TLL
90	6436123	UP	18-7174	2	TT	3.4 LT	5611648	UP	18-7168	2	TLL
100	B209468	UP	18-7164	1	SB	3.4 LT	5611648	UP	18-7174	1	TT
100	B209468	UP	18-7174	1	TT	3.4 LT	5611648	UP	18-7164	1	SB
115	6436123	UP	18-7164	1	SB	XR-4/Magnum II	B242885	UP	18-7174	1	TT
115	6436123	UP	18-7174	2	TT	XR-4/Magnum II	B242885	UP	18-7164	1	SB
V 135	A904646	UP	18-7164	1	SB						

① Models with power trim only TLL Tilt Lock Lever
 SB,U Swivel Bracket, Upper TT Tilt Tube
 SB Swivel Bracket



 <p>18-5225 SPARK PLUG WIRE KIT Kit includes 25 ft. Roll of 7 MM Hypalon Ignition Wire With a Metallic Core and a Large Assortment of Three Different End Fittings to Fit Outboard Motors.</p>	 <p>18-5226 IGNITION WIRE Metallic Core 100' Spool 7mm Hypalon</p>	<p>PKG. OF 10</p>  <p>18-5224 18-5224-9① SPARK PLUG WIRE TERMINAL</p>	<p>PKG. OF 10</p>  <p>18-5750 18-5750-9① UNIVERSAL SPARK PLUG BOOTS Supplied complete w/Terminal Connector</p>
 <p>18-5752 UNIVERSAL SPARK PLUG BOOT 8mm</p>	 <p>18-5133 IGNITION COIL Replaces: 3A0060401M, 3A0060481M Fits: 2002 and Prior M and NS Model 25C2, C3, 30A3, A4; 2003 25C3, A4; 2005 25C3</p>	 <p>18-5134 CDI Replaces: 3G2060602M Fits: 2002 and Prior M and NS Model 15D2, 18E, E2, 9.9D, D2; 2003 15D2, 18E2, 9.9D2</p>	 <p>18-5143 EXCITER COIL Replaces: Tohatsu 369060210M Fits: 4C, 5B, 5BS (2003)</p>
 <p>18-5165 EXCITER COIL Replaces: Nissan 3G3060211M Fits: 9.9D(2002 and below)9.9D2(2003 and below), 15D(2002 and below), 15D2(2003 and below), 18E(2002 and below), 18E2(2003 and below)</p>	 <p>18-5166 IGNITION COIL Replaces: Nissan/Tohatsu 3M3060482M, 3G2-06040-2 Fits: 9.9D(2002 and below)9.9D2(2003 and below), 15D(2002 and below), 15D2(2003 and below), 18E(2002 and below), 18E2(2003 and below)</p>		

① Priced per Package

NISSAN/TOHATSU IGNITION APPLICATION

Model	Year Start	Year Stop	Ignition Coil	CDI	Exciter Coil
FSB	2003	2014	-	-	-
M15	1997	2002	-	18-5134	18-5165
M15	2003	2003	18-5166	18-5134	18-5165
M18	1997	2003	18-5166	18-5134	18-5165
M2.5	1997	2005	-	-	-
M25	1997	2005	18-5133	-	-
M3.5	1997	2005	-	-	-
M30	1997	2003	18-5133	-	-
M4	2003	2003	-	-	18-5143

APPLICATION CONTINUES ON NEXT PAGE

NISSAN/TOHATSU IGNITION APPLICATION

Model	Year Start	Year Stop	Ignition Coil	CDI	Exciter Coil
M5	2003	2003	-	-	18-5143
M9.9	1997	2003	18-5166	18-5134	18-5165
MFS8	2006	2014	-	-	-
MFS8	2003	2004	-	-	-
MFS9.8	2003	2014	-	-	-
NS2.5	1997	2005	-	-	-
NS3.5	1997	2005	-	-	-
NS15	1997	2002	-	18-5134	-
NS18	1997	2002	-	18-5134	-
NS9.9	1997	2002	-	18-5134	-
NSF8	2004	2004	-	-	-
NSF8	2010	2014	-	-	-
NSF9.8	2005	2005	-	-	-
NSF9.8	2010	2014	-	-	-



18-6418
OUTBOARD STARTER

Replaces: Tohatsu 353760104M
Fits: M45A2, M50C, M60A, M70A2, M90A, M140A, NS45A2, NS50C, NS60A, NS70A2, NS90A, NSD90A, NS120A, NS140A.
(9 Tooth)



18-6430
OUTBOARD STARTER

Replaces: Tohatsu B29A-90500A
Fits: 1981-on 2WT60A



18-6431
OUTBOARD STARTER

Replaces: Tohatsu 346760100M
Fits: 2cyl Engines 40C, 50C & 50A, 70A, NS26C, NS30A, NS35C, NS40C



18-6432
OUTBOARD STARTER

Replaces: Tohatsu 3C8760101M
Fits: M50D, M60B, M60C, MD40D, MD50A MFS25A, MFS30A, NS40D, NS50D, NS60C, NS70B, NS70C, NSD25A, NSD30A, NSD50A



18-6823
WIRING HARNESS

Replaces: Universal
Converts 3-wire Tilt and Trim motors to 2-Wire design



18-6448
ELECTRIC START CONVERSION KIT

Fits: Tohatsu 25 & 30 HP



18-56001
BRUSH HOLDER ASSEMBLY

Fits: 90-140 HP 2 Stroke
Use with **18-6418** Starter Assembly



18-7712
FUEL FILTER (INLINE)

Replaces: 369022300M
Fits: 2 stroke, 5 HP thru 9.8 HP/4 stroke, 4 HP thru 30 HP



18-7828-1
(1/4" Small) Small Capacity
(For 1/4" Fuel Line)

18-7829
(1/4" Large) Large Capacity
(For 1/4" Fuel Line)

18-7830 (5/16")

18-7831 (3/8")

FUEL FILTERS



FUEL WATER SEPARATORS



Sierra offers a complete line of 10 and 21 micron fuel water separating filters including drainable bowl filters to protect your carbureted and fuel injected engine.

Refer to pages 136-140 for a complete listing of OEM and universal applications.

Sierra fuel water separators remove over 99.8% of emulsified water from your gasoline. Sierra's 10 micron filters are over 90% efficient at removing particles as small as 10 micron. All filters flow @ 90 GPH to feed even the hungriest motor. Sierra 10 micron filters are recommended to prevent damage to sensitive inboard and outboard fuel injection systems.



18-8002EP-1
18-8002EP-1-10
PRIMER BULB
1/4"

18-8004EP-1
18-8004EP-1-10
PRIMER BULB
3/16"
Large capacity bulb

18-8005EP-1
18-8005EP-1-10
PRIMER BULB
3/8"
Large capacity bulb



18-8078
TANK CONNECTOR
1/4" N.P.T. .508 O.D.
Nissan Tank Large Inlet
Fits: All models
Mates with 18-8079
(Male)



18-80410-1
FUEL CONNECTOR
Replaces: 394-70250-0
Female Hose connector
3/8"
Fits: 4HP-30HP 4-stroke



18-8079
FUEL CONNECTOR
(Tank End, Quick Connect)
Replaces: 3B2702810M,
65750-95500
Fits: All models
Mates with 18-8078
Female to 3/8" hose barb



18-8088
FUEL CONNECTOR
(Engine End)
Replaces: 3B2702501M
3/8" Hose
Fits: 5-90HP 2-stroke and TLDI models
Mates with 18-8089



18-8089
FUEL CONNECTOR
(Engine End)
Replaces: 3B2-70260-0
(Metric Threads)
3/8" Hose
Fits: 5-90HP 2-stroke and TLDI models
Mates with 18-8088



PKG. OF 10



SNAPPER CLAMPS
18-8020 **18-8021**
18-8020-9 **18-8021-9**
#8 For 5/16" Hose #10 For 3/8" Hose



18-7290
CARB KIT
Replaces: 345871224M
Kit contains enough components
to rebuild 2 carburetors.
For: All 35/40C HP (1 per engine)



18-7291
CARB KIT
Replaces: 345871220M
For: All 25/30 HP (1 per engine);
All 45A2, 50C, 60C, 70A2 (2 per engine)



18-7765
CARB KIT
Replaces: 369871221M
For: All 4/5 HP (1 per engine)



18-8920
IMPELLER

Replaces: 3B2650211M
Fits: 8 (8B models), 9.8 (9.8B model), 8 4-Stroke (All), 9.8 4-Stroke (All)



18-8921
IMPELLER

Replaces: 334650210M
Fits: 9.9 (All), 15 (All), 18 (All), 9.9 4-Stroke (All B Models), 15 4-Stroke (All B Models), 18 4-Stroke (All)



18-8922
IMPELLER

Replaces: 3C8650212M
Fits: 40 3-cyl (D models), 40 TLDI 2-Stroke (All) 50 3-cyl (D models), 50 TLDI 2-Stroke (All), 70 TLDI 2-Stroke (All), 90 TLDI 2-Stroke



18-8923
IMPELLER

Replaces: 345650210M
Fits: 25 (25C model), 25 4-Stroke (All A Models, B Models with white bushing), 30 (30A model), 30 4-Stroke (All A Models, B models with white bushing), 40 2-cyl (40C model)



18-8924
IMPELLER

Replaces: 3C7650211M, 3B7650212M
Fits: 60 3-cyl (B & C models), 70 3-cyl (B & C models), MD 70, MD 90 (TLDI), 115, 140, 90 2-Stroke



18-45404
IMPELLER

Replaces: 353650210M
Fits: Nissan/Tohatsu NS50C, NS60A, NS70A2(2002 & Up)



18-43175
THERMOSTAT KIT

Replaces: 3R3010300M
Fits: Nissan/Tohatsu 9.9-30 HP 4-Stroke



18-43212
WATER PUMP HOUSING

Replaces: 3B2650160M
Fits: 8/9.9 4-Stroke(209cc)



18-48317
COMPLETE WATER PUMP KIT

Replaces: 3B2873222M
Fits: F8/9.8

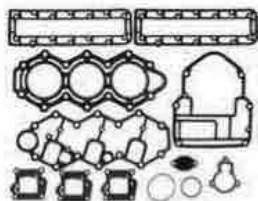

18-4434
POWERHEAD GASKET SET

Replaces: 3C8-87121-4
Fits: All 40-50 HP



18-7911-1
OIL FILTER

Replaces: 3R0-07615-0
Fits: 9.9-30HP



18-4435
POWERHEAD GASKET SET

Replaces: 3F3871210M
Fits: All 60-70 HP

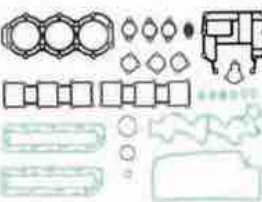

18-4436
POWERHEAD GASKET SET

Replaces: 3B7871218M
Fits: All 80 HP



18-74610
LOWER UNIT SEAL KIT

Replaces: 398873213M
Fits: 18 & 15 (1997-08), 9.9 (1997-04)



18-74611
LOWER UNIT SEAL KIT

Replaces: 346873217M
Fits: 25 (1997-05), 30 (1997-03)



18-3850
HEAD GASKET
Replaces: 3C8010055M
Fits: All 40-50 HP



18-3886
HEAD GASKET
Replaces: 3T9010050M
Fits: All 90 HP



18-4299
HEAD GASKET
Replaces: 3F3010051M
Fits: All 60-70 HP



18-51000
RECOIL STARTER SPRING
Replaces: 3AA050040M
Fits: Tohatsu 8 4-Stroke(2004-12), 9.8 4-Stroke(2004-12)



18-60103
DRAIN PLUG GASKET
Replaces: 332600060M
Fits: All Nissan/Tohatsu models



18-60103-50
DRAIN PLUG GASKET
Fits: All Nissan/Tohatsu models



18-60916
CYLINDER HEAD GASKET
Replaces: 3V1010050M
Fits: F8/9.8



18-60917
CYLINDER COVER GASKET
Replaces: 3V1010240M
Fits: F8/9.8



18-60918
ENGINE BASE GASKET
Replaces: 3V1013030M
Fits: F8/9.8



18-60919
EXHAUST COVER GASKET
Replaces: 3V1023050M
Fits: F8/9.8



18-60920
THERMOSTAT GASKET
Replaces: 346-01032-0
Fits: F8/9.8



18-2448
LOWER UNIT FILL/DRAIN KIT
M8 - 1.25 thread
Fits: Yamaha, Nissan/Tohatsu, & Honda Lower Units



18-72656
DRAIN PLUG & GASKET
Replaces: Nissan-Tohatsu 332600052M, 332600060M
M8 - 1.25 thread
Fits: Nissan/Tohatsu - All Models



18-73964
PROP NUT KIT
Fits: Nissan/Tohatsu F8/9.8



18-79989
TRAILERING STICKS
Fits: Most outboards over 150HP with three ram intrigrel tilt/trim.



18-76695
O-RING
Replaces: Nissan-Tohatsu 3R0074220M
Fits: 8/9.9 s/n Qr042475 and Up

Suzuki Model Identification

Model Description	Horsepower	Model Variation Length	Shaft Year	Model
DT = 2-cycle DF = 4-cycle PU = Jet Drive	Examples: 9.9 40 115 250	E - Elec. Start w/Tiller Handle R - Elec. Start w/Remote Control C - Oil Injection G - Counter Rotation N - High Thrust Propeller T - Power Tilt & Trim w/Elec. Start w/Remote Control H - Power Tilt & Trim w/Elec. Start w/Tiller Handle SF - Super Four SS - Super Six M - Manual Start w/Tiller Handle V - Comlink Voice Caution System	S = 15" L = 20" X = 25"	D = 1983 E = 1984 F = 1985 G = 1986 H = 1987 J = 1988 K = 1989 L = 1990 M = 1991 N = 1992 P = 1993 R = 1994 S = 1995 T = 1996 V = 1997 W = 1998 X = 1999 Y = 2000 K1 = 2001 K2 = 2002 K3 = 2003 K4 = 2004 K5 = 2005 K6 = 2006 K7 = 2007 K8 = 2008

EXAMPLE: DT40CRSN - 2-cycle, 40 HP, Oil Injection, Elec. Start w/remote control, 15", 1992 Model Year

PKG. OF 10



18-5224
18-5224-9 ⓘ
SPARK PLUG WIRE TERMINAL



18-5225
SPARK PLUG WIRE KIT
 Kit includes 25 ft. Roll of 7 MM Hypalon Ignition Wire With a Metallic Core and a Large Assortment of Three Different End Fittings to Fit Outboard Motors.



18-5226
IGNITION WIRE
 Metallic Core
 100' Spool
 7mm Hypalon

PKG. OF 10



18-5750
18-5750-9 ⓘ
UNIVERSAL SPARK PLUG BOOTS
 Supplied complete w/Terminal Connector



18-5752
UNIVERSAL SPARK PLUG BOOTS
 8mm



18-5151
IGNITION COIL
 Replaces: 33410-94400, 33410-92L10
 Fits: DT40C(1986-98)

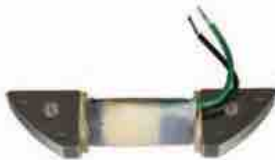

18-5152
IGNITION COIL
 Replaces: 32140-93900
 Fits: DT 9.9(1983-87), DT15 (1983-88)



18-5144
CDI
 Replaces: 32900-93911
 Fits: DT15



MP51010 (CLAMSHELL)
MP51012 (BULK 100 PCS/CTN)
IGNITION SWITCH
 Replaces: 37110-99E00
 Colors on wires match factory color codes
 Suzuki 2 & 4 Stroke Outboards

ⓘ Priced per Package



18-6414
OUTBOARD STARTER
 Replaces: 31100-95600
 Fits: 75 HP



18-6416
OUTBOARD STARTER
 Replaces: 31100-94610
 Fits: 115, 140 H.P. (9 Tooth) (1984-UP)



18-6417
OUTBOARD STARTER
 Replaces: 31100-92E00
 Fits: 150, 200, 225 H.P. (1985-UP)



18-6419
OUTBOARD STARTER
 Replaces: 31100-89J00
 Fits: 4 Stroke DF40 (1999-01) (9 tooth)



18-6827
STARTER
 Replaces: 31100-94600, 31100-94601,
 31100-94610
 Fits: 115, 140HP engines



18-6428
OUTBOARD STARTER
 Replaces: 31100-95313
 Fits: 50/60 HP (1984-85), 75/85 HP (1984-87)



18-6429
OUTBOARD STARTER
 Replaces: 31100-94702
 Fits: DT 55/65 (1985-88)



18-6831
STARTER
 Replaces: Suzuki 31100-90J00
 Hitachi S114-837, A
 Fits: Suzuki 90-115HP 2001-08



18-6941
STARTER
 Replaces: 31100-93J00, 96J00, 96J01
 Fits: 70-300HP 2004-up



18-6945
STARTER
 Replaces: 31100-95J00, 95J01
 Fits: Johnson, Suzuki 25HP 2006-11



18-56009
BRUSH HOLDER ASSEMBLY
 Replaces: 31173-99E00
 Fits: 115-140 HP 2 Stroke
 Use with 18-6416 Starter



18-9802
TIMING LIGHT
 Self-powered accurate up to 10,000 RPM's

**18-5731
RELAY, STARTER**

Replaces: 38860-76F01
Fits: DF9.9 2005-2010, DF15 2005-2010, DF25 2006-2010, DF40 2003-2010, DF50 2003-2010, DF60 2003-2010, DF70 2003-2010, DF80 2009-2010, DF90 2003-2010, DF100 2009-2010, DF115 2003-2010, DF140 2003-2010, DF150 2006-2010, DF175 2006-2010, DF200 2004-2010, DF225 2004-2010, DF250 2004-2010, DF300 2007-2010



**18-18303
POWER TRIM MOTOR**

Replaces: 38100-92J02, 38100-92J10, 38100-93J01, 38100-93J02, 38100-96J00
(O-Ring included)
Fits: DF60-300(2001-07)



**18-18304
POWER TRIM MOTOR**

Replaces: 37100-87J00-0EP, 38100-87J0EP
(O-Ring included)
Fits: DF40(1999-00), DF50(1999-00)



**18-6785
TILT/TRIM MOTOR**

Replaces: 38100-87E10-0ED, 38100-87000-0IT, 38100-87E20-0ED
(O-Ring included)
For: V-4 & V-6 1988-1990
 V-6/3 wire hook-up 3 bolt flange



**18-6786-1
TILT/TRIM MOTOR**

Replaces: 38100-87D10-0ED, 38100-87D10-35J, 38100-87D10-0IT, 38100-92E00-0ED
For: V4 & V6 (1990-up), DT90 (1991-97), DT100 & DT200 (1991-2000), DT150 & DT225 (1991-2003), DT175 (1991-92)
 3 Bolt flange 2 wire connection



**18-6793
TRIM MOTOR**

Replaces: 38100-87J11, 38100-87J20
(O-Ring included)
Fits: DF40, DF50 (2001-08)



**18-6823
WIRING HARNESS**

Replaces: Universal
 Converts 3-wire Tilt and Trim motors to 2-Wire design



4-STROKE FUEL SYSTEM KITS



**18-7761
CARBURETOR
REBUILD KIT**
Fits: Suzuki DF4-DF6 (2005 & Up)



**18-7773
CARB KIT**
Replaces: 13910-89J01
Fits: DF 25/30 (All Years)



**18-3495
DIAPHRAGM KIT**
Replaces: 15170-93911
Fits: DT8(All 1988-97), DT9.9(All 1988-97), DT15(All 1988-97)



**18-3496
DIAPHRAGM KIT**
Replaces: 15170-94320
Fits: DT25(All 1989-99), DT30(All 1989-99), DT40(All 1988-98), DT55(All 1988-97), DT65(All 1988-97)



**18-3497
DIAPHRAGM KIT**
Replaces: 15170-91J00
DF4-DF6 (2003 & UP)



**18-3498
DIAPHRAGM KIT**
Replaces: 15170-94J00, 15170-94J0V
DF9.9-DF15 HP(2005 & UP)



**18-3499
DIAPHRAGM KIT**
Replaces: 15170-99E00
DF9.9,DF15 (1997-2004), DF25 (2000-2006) (Non-V twin), DF40,DF50 (1999-2006), DF60,DF70 (1998-2007).

2-STROKE FUEL SYSTEM KITS

18-7752
CARB KIT
Replaces: 13910-87D00

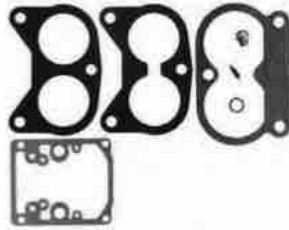

18-7753
CARB KIT
Replaces: 13910-94400



18-7754
CARB KIT
Replaces: 13910-94701



18-7755
CARB KIT
Replaces: 13910-95D00



CARBURETOR KIT APPLICATION

HP/Model	Year	Part #	HP/Model	Year	Part #	HP/Model	Year	Part #
DT25C	1989-98	18-7755	DT65	1985-97	18-7753	DT100	1989-98	18-7752
DT30C	1988-97	18-7755	DT75	1985-97	18-7754	DT115	1986-98	18-7754
DT40C	1984-98	18-7753	DT85	1985-98	18-7753	DT140	1986-98	18-7753
DT55	1985-97	18-7754	DT90	1989-97	18-7752	V-6	ALL	18-7752

FUEL WATER SEPARATORS



Sierra offers a complete line of 10 and 21 micron fuel water separating filters including drainable bowl filters to protect your carbureted and fuel injected engine.

Refer to pages 136-140 for a complete listing of OEM and universal applications.

Sierra fuel water separators remove over 99.8% of emulsified water from your gasoline. Sierra's 10 micron filters are over 90% efficient at removing particles as small as 10 micron. All filters flow @ 90 GPH to feed even the hungriest motor. Sierra 10 micron filters are recommended to prevent damage to sensitive inboard and outboard fuel injection systems.

Sierra #	Suzuki #	Description
18-7953	15410-87J30	Fuel Filter Fits: DF25, DF70, DF90, DF115, DF140 (Incl.140T & 140Z) (2006 & Newer)
18-7936 *	15412-93J00	Fuel Filter Element
18-7947	99105-20006	Spin on Replacement Filter
18-7987	99105-20006-BWL	AquaVue™ Mini Collection Bowl
18-7948	99105-20005	Spin on Replacement Filter
18-7922-1	99105-20004BWL	AquaVue™ Collection Bowl
18-7735	15410-94400	Fuel Filter Kit
18-7711	15410-96J00	Fuel Filter (Inline)
18-7716	15410-87J10	Fuel Filter
18-7719	15410-98500	Fuel Filter

* Retail Packaged Item



18-32154
OXYGEN SENSOR
Replaces: 18213-98J00
Fits: DF100A, DF115A, DF140A, DF250A, (2011-Up), DF300 (2007-Up)

PRIMER BULBS



18-8002EP-1
18-8002EP-1-10 Ⓢ
PRIMER BULB
 1/4"

18-8004EP-1
18-8004-10EP-1 Ⓢ
PRIMER BULB
 1/2"
 Large capacity bulb

18-8005EP-1
18-8005-10PE-1 Ⓢ
PRIMER BULB
 1/2"
 Large capacity bulb

18-80409
FUEL CONNECTOR
 • 1/4" barb
 Motor Side
Replaces: 65720-94401
Fits: DT4-DT65
Mates with 18-80418



18-80418
FUEL CONNECTOR
 • 1/4" barb
Replaces: 65750-94404
Fits: DT4-DT140
Mates with 18-80409 & 18-809



18-80419
FUEL CONNECTOR
Replaces: 65750-87J10,
 65750-87J11
Fits: DF25-DF140 (5/16" version of
 18-80404)
Mates with 18-80425



18-80425
FUEL CONNECTOR
Replaces: 65720-986B0
Fits: DF25-DF140
Mates with 18-80404 & 18-80419



18-8062
FUEL CONNECTOR
 • 3/8" barb
Replaces: 65750-98505
Mates with 18-8071



18-8071
TANK CONNECTOR
 1/4" NPT .432 O.D.
Replaces: 99105-00192
Mates with 18-8062
(Male)



18-8078
TANK CONNECTOR
 1/4" N.P.T. .508 O.D.
Replaces: 65740-95500,
 99105-00193
Fits: All models
Mates with 18-8079
(Male)



18-8079
FUEL CONNECTOR
 Tank End, Quick Connect
Replaces: 65750-95510,
 65750-95500
Fits: All models
Mates with 18-8078
Female to 3/8" hose barb



18-8087
FUEL CONNECTOR
 • 5/16" barb
 Motor Side
Replaces: 65720-94411
Fits: DT75-DT140



18-80404
FUEL CONNECTOR
 3/8"
Fits: DF25-DF140 HP
Mates with 18-80425



18-80405
FUEL CONNECTOR
 Female to 3/8" hose barb
Mates with 18-8078



18-8090
FUEL CONNECTOR
 (1/4" NPT)
Mates with 18-80418



18-3000
IMPELLER
Replaces: 17461-92D02
Fits: DT 8C/9.9C (1989-97)



18-3035
IMPELLER
Replaces: 17461-93J00
For: DF200, DF225, DF250 (2004-05)



18-3049
IMPELLER
Replaces:
 17461-87E11, 17461-87E12
Fits: DF 60/70 (1998-01),
 DF 90-100 (1999-01)



18-3023
IMPELLER
Replaces:
 17461-90J00, 17461-90J01,
 17461-94500, 17461-94501,
 17461-94502, 17461-94503,
 17461-94504, 17461-94505,
 17461-94506, 17461-94510,
 17461-94511, 17461-94520
Fits: 2 Stroke DF90, DF115, DF140 (2000-
 05), DT115 (1981-01), DT140 (1981-01),
 DT150 (1986-01), DT200 (1986-00)



18-3092
IMPELLER
Replaces: 17461-93001,
 17461-93003, 17461-93004



 <p>18-3094 IMPELLER Replaces: 17461-94700, 17461-94701</p>	 <p>18-3095 IMPELLER Replaces: 17461-95300, 17461-95301, 17461-95302</p>	 <p>18-3096 IMPELLER Replaces: 17461-96301, 17461-96311, 17461-96312</p>
 <p>18-3097 IMPELLER Replaces: 17461-98501, 17461-98502, 17461-98503, 17461-985M0</p>	 <p>18-3099 IMPELLER Replaces: 17461-93902, 17461-93901, 17461-93903 For: DT 9.9, 15 (1983-97), DF 9.9, 15 (1997-05)</p>	 <p>18-3291 IMPELLER KEY Replaces: 09420-05006, 09420-05009 Fits: V-6 2-Stroke (1986-03), DF90 /115/140(2001-04)</p>
 <p>18-3292 IMPELLER KEY Replaces: 17462-93990, 09420-03005 Fits: DT 6C/9.9C (1989-97), DF 9.9/15 (1997-04), DT 9.9 (1985-87), DT 15 (1983-88), DT 15C (1989-97)</p>	 <p>18-3296 IMPELLER KEY Replaces: 09420-05005 Fits: DT 115/140 (1983-01)</p>	 <p>18-3404 IMPELLER KEY Replaces: 09420-04009 Fits: DF 60/70 (1998-01), DF 90-100 (1989-01)</p>
 <p>18-3186 IMPELLER PLATE Replaces: 17471-98503 Fits: DT 6 (1984-02), DT 8 (1986-97)</p>	 <p>18-3189 IMPELLER PLATE Replaces: 17471-87D01 Fits: V-6 2-Stroke (1986-03)</p>	 <p>18-3190 IMPELLER PLATE Replaces: 17471-93902 Fits: DF 9.9/15 (1997-04), DT 9.9 (1985-87), DT 15 (1983-88), DT 15C (1989-97)</p>
 <p>18-3191 IMPELLER PLATE Replaces: 17471-94501 Fits: DT 115/140 (1983-01)</p>	 <p>18-3192 IMPELLER PLATE Replaces: 17471-87E01, 17471-92J00 Fits: DF 60/70 (1998-01), DF 90-100 (1989-01), DF 90/115/140 (2001-04)</p>	 <p>18-3193 IMPELLER PLATE Replaces: 17471-92D10 Fits: DT 6C/9.9C (1989-97)</p>



18-3242
IMPELLER REPAIR KIT
Replaces: 17400-96350,
17400-96351, 17400-96353

— CONTAINS —			MODEL	YEAR	MODEL	YEAR
Part #	Description	O.E. #				
18-3096	Impeller	17461-96311	DT20	1965-68	DT35	1967-99
18-0461	Gasket	17472-96301	DT25	1964-68	DT40C	1964-68
			DT30	1964-67		



18-3243
IMPELLER REPAIR KIT
Replaces: 17400-94700, 17400-94701

— CONTAINS —			MODEL	YEAR	MODEL	YEAR
Part #	Description	O.E. #				
18-3094	Impeller	17461-94700	DT55	1985-95	DT85	1985-95
18-0460	Gasket	17472-95310				



18-3244
IMPELLER REPAIR KIT
Replaces: 17400-95550, 17400-95350, 17400-95351
Fits: DT75, DT85 (1985-95)

— CONTAINS —		
Part #	Description	O.E. #
18-3095	Impeller	17461-95300
18-0459	Gasket	17472-95200



18-3253
WATER PUMP KIT
Replaces: 17400-87D11
Fits: V6 2-Stroke (1986-03)



18-3254
WATER PUMP KIT
Replaces: 17400-87E03, 17400-87E04
Fits: DF 60/70 (1998-06), DT 90-100 (1989-01)



18-3255
WATER PUMP KIT
Replaces: 17400-92D01
Fits: DT 8C/9.9C (1989-97)



18-3256
WATER PUMP KIT
Replaces: 17400-93951
Fits: DF 9.9/15 (1997-06), DT 9.9 (1985-87),
DT 15 (1983-88), DT 15C (1989-97)

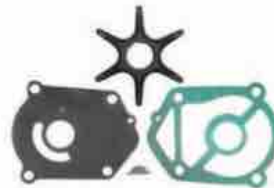

18-3257
WATER PUMP KIT
Replaces: 17400-94611
Fits: DT 115/140 (1983-01)



18-3258
WATER PUMP KIT
Replaces: 17400-90J11, 17400-90J20
Fits: DF 90/115/140 (2001-05)



18-3259
WATER PUMP KIT
Replaces: 17400-98551
Fits: DT 6 (1984-02), DT8 (1986-97)



18-3260
WATER PUMP KIT
Replaces: 17400-98652
Fits: DT 4 (1984-98), DT 5 (1999-02)



18-3264
WATER PUMP REPAIR KIT
Replaces: 17400-93J00,
17400-93J02
For: DF200, DF225, DF250 (2004-09)







18-3267
WATER PUMP KIT
Replaces: 17400-98J00,
17400-98J01
Fits: DF300 (2007-Current)



18-3266
WATER PUMP REPAIR KIT
Replaces: 17400-98661
For: DF4, DF6 (2003-07)

			
<p>18-3480 WATER PUMP HOUSING Replaces: 17411-93901 Fits: DT9.9(1983-97, 2004-10), DT15(1983-97, 2004-10)</p>	<p>18-3481 WATER PUMP HOUSING Replaces: 17411-94421 Fits: DF25(All models 2000-05) DF25(models DF25Q, DF25Q(OR), DF25T 2006-07), DF30(All 2000-07), DT40C(1986-98), DF40(All 2000-07), DF50(All 1989-10)</p>	<p>18-0761 PUMP CASE GASKET Replaces: 17472-91J00 For: DF4 (2003-05), DF6 (2003-05)</p>	<p>18-0778 PUMP CASE GASKET Replaces: 17472-93J00 For: DF150(2006-10), DF175(2006-10), DF200(2004-10), DF225(2004-10), DF250(2004-10)</p>

			
<p>18-0459 WATER PUMP GASKET Replaces: 17472-95200</p>	<p>18-0460 WATER PUMP GASKET Replaces: 17472-95310</p>	<p>18-0461 WATER PUMP GASKET Replaces: 17472-96301</p>	<p>18-0477-9^① WATER PUMP GASKET Replaces: 17472-98503 Fits: DT 6 (1984-02), DT8 (1986-97)</p>

PKG. OF 5			
			
<p>18-0478 WATER PUMP GASKET Replaces: 17472-93911 Fits: DF 9.9/15 (1997-04), DT 9.9 (1985-87), DT 15 (1983-88), DT 15C (1989-97)</p>	<p>18-0479 WATER PUMP GASKET Replaces: 17472-92D10 Fits: DT 8C/9.9C (1989-97)</p>	<p>18-0792 THERMOSTAT GASKET Replaces: 13119-91J00</p>	<p>18-0793 THERMOSTAT GASKET Replaces: 17582-93J00</p>

			
<p>18-0794 THERMOSTAT GASKET Replaces: 17685-97J00</p>	<p>18-0795 THERMOSTAT GASKET Replaces: 17685-89J00</p>	<p>18-0796 THERMOSTAT GASKET Replaces: 17685-99E00</p>	<p>18-0797 THERMOSTAT GASKET Replaces: 17685-87D10</p>

HP/Model	Year	Impeller	Gasket	Water Pump Kit	HP/Model	Year	Impeller	Gasket	Water Pump Kit
DT2/2.2	1983-97	18-3097	—	—	DT50M	1980-84	18-3094	18-0460	18-3243
DT3.5	1983-84	18-3097	—	—	DF50	1989-09	18-3096	18-0461	18-3242
DT4	1984-98	18-3097	—	18-3260	DF50	2010	18-3096	18-0461	—
DF4	2003-10	18-3097	18-0761	18-3266	DT55	1985-97	18-3094	18-0460	18-3243
DT5	1977-83, 1999-02	18-3097	—	18-3260	PU55 (jet)	1989-94	18-3094	18-0460	—
DT6	1984-02	18-3097	18-0477-9	18-3259	DT60	1983	18-3094	18-0460	18-3243
DF6	2003-10	18-3097	18-0761	18-3266	DT60	1984	18-3095	18-0460	—
DT6	1980-87	18-3097	18-0477-9	18-3259	DF60	1998-09	18-3049	—	—
DT6	1988-97	18-3000	18-0479	18-3255	DF60	2010	18-3096	18-0461	—
DF6	2010	18-3099	—	—	DT65	1982-prior	18-3094	18-0459	—
DT9.9	1977-82	18-3092	—	—	DT65	1985-97	18-3094	18-0460	18-3243
DT9.9	1983-87	18-3099	18-0478	18-3256	DF70	1989-08	18-3049	—	—
DT9.9	1988-97	18-3000	18-0479	18-3255	DF70	2010	18-3096	18-0461	—
DF9.9	1997-10	18-3099	18-0478	18-3256	DT75	1983-97	18-3095	18-0459	18-3244
DT14	1977-80	18-3092	—	—	DF80	2009-10	18-3049	—	—
DT15	1983-97	18-3099	18-0478	18-3256	DT85	1983-00	18-3095	18-0459	18-3244
DT15C	1989-97	18-3099	18-0478	18-3256	PU85 (jet)	1989-97	18-3095	18-0459	—
DF15	1997-10	18-3099	18-0478	18-3256	DT90	1989-97	18-3049	—	18-3254
DT16	1977-82	18-3092	—	—	DF90	2001-08	18-3023	—	—
DT20	1986-88	18-3096	18-0461	18-3242	DF90	2009-10	18-3049	—	—
DT25	1980-82	18-3092	—	—	DT100	1987-01	18-3049	—	18-3254
DT25	1983-88	18-3096	18-0461	18-3242	DF100	2009-10	18-3023	—	—
DF25	2000-06	18-3096	18-0461	18-3242	DT115	1986-01	18-3023	—	18-3257 **
DF25 V-Twin	2006-10	18-3096	18-0461	—	DF115	2001-10	18-3023	—	18-3258 **
DT30	1983-87	18-3096	18-0461	18-3242	DT140	1986-01	18-3023	—	18-3257
DT30	1988-97	—	18-0461	—	DF140	2002-10	18-3023	—	—
DF30	2000-07	18-3096	18-0461	18-3242	DT150	1986-03	18-3023	—	18-3253
DT35	1980-82	18-3094	18-0459	—	DF150	2006-10	18-3023	18-0778	—
DT35	1987-89	18-3096	18-0461	18-3242	DT175	1987-92	18-3023	—	18-3253
DT40	1980-82	18-3094	18-0459	—	DF175	2006-10	18-3023	18-0778	—
DT40	1983	18-3094	18-0460	—	DT200	1986-00	18-3023	—	18-3253
DT40/DT40C	1984-98	18-3096	18-0461	18-3242	DF200	2004-10	18-3035	18-0778	18-3264
DF40	1999-09	18-3096	18-0461	18-3242	DT225	1990-03	18-3023	—	18-3253
DF40	2010	18-3096	18-0461	—	DF225	2004-10	18-3035	18-0778	18-3264
PU40 (jet)	1989-94	18-3096	18-0461	—	DF250	2004-10	18-3035	18-0778	18-3264
DT50	1982-prior	18-3094	18-0459	—	DF300	2007-10	18-3035	18-0851	18-3267
DT50	1983-84	18-3094	18-0480	18-3243					

① Priced per Package

* SN 681517 & earlier

** SN 812175 & Later



O.E. INTERCHANGE

Part #	Description	O.E. #
18-39480	Piston Rings	12140-93121
18-39530	Piston Rings	12140-96361-050
18-39540	Piston Rings	12140-94400
18-40110	Piston Kit	12110-94400
18-40140	Piston Kit	12110-93120
18-42850	Piston Pin	12151-94400
18-42860	Wrist Pin	12151-93100
18-42870	Wrist Pin	12151-92502
18-42940-9	Ⓢ Ⓢ Circlips	09381-14001
18-42950-9	Ⓢ Ⓢ Circlips	09381-18002
18-42960-9	Ⓢ Ⓢ Circlips	09381-20003

HP/Model	Years	PISTON		RINGS		WRIST PIN		CIRCLIP	
		Std.	.50mm	Std.	.50mm	Std.	.50mm	Std.	.50mm
DT9.9	1983-87	18-40140	—	18-39480	—	18-42860	—	18-42940-9	—
DT15	1983-88	18-40140	—	18-39480	—	18-42860	—	18-42940-9	—
DT25	1983-88	—	—	—	18-39530	—	18-42870	—	18-42950-9
DT30	1983-87	—	—	—	18-39530	—	18-42870	—	18-42950-9
DT40	1984-98	18-40110	—	18-39540	—	18-42850	—	18-42960-9	—



18-1757

CONNECTING ROD

Replaces: 12161-93902
Fits: DT9.9, DT15 (1983-97)



18-1758

CONNECTING ROD

Replaces: 12161-96300, 12161-91L00
Fits: DT25 (1983-88), DT30 (1983-87)



18-1759

CONNECTING ROD

Replaces: 12161-94400, 12161-92L00
Fits: DT 40 (1984-98)



18-1757K

CONNECTING ROD KIT

Replaces: 12161-93902
Fits: DT9.9 (1983-87), DT15 (1983-87)



18-1759K

CONNECTING ROD KIT

Replaces: 12161-94400
Fits: DT40 (1984-98)



18-1412

ROD BEARING

Replaces: 09263-20051
Fits: DT9.9 (1983-87), DT15 (1983-87)



18-1414

ROD BEARING

Replaces: 09263-14022
Fits: DT9.9 (1983-87), DT15 (1983-87), DT14/16 (1980-82)



18-1415

ROD BEARING

Replaces: 09263-18016
Fits: DT25 (1983-88), DT30 (1983-87)



18-1416

ROD BEARING

Replaces: 09263-27005
Fits: 40 (1984-98)



18-1417

WRIST PIN BEARING

Replaces: 09263-20072
Fits: 40 (1984-98)



18-3806

HEAD GASKET

Replaces: 11141-98401, 11141-98411



18-3807

HEAD GASKET

Replaces: 11141-98101, 11141-98130



18-3808

HEAD GASKET

Replaces: 11141-93901, 11141-93960



18-3809

HEAD GASKET

Replaces: 11141-96303, 11141-96344



18-3810

HEAD GASKET

Replaces: 11141-94401, 11141-94450



18-3813

HEAD GASKET

Replaces: 11141-95305, 11141-95320



18-3814
HEAD GASKET
Replaces: 11141-95505, 11141-95512



18-3816
HEAD GASKET
Replaces: 11141-98504, 11141-98510, 11141-98522

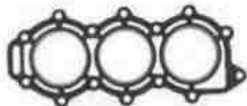

18-3819
HEAD GASKET
Replaces: 11141-95D90, 11141-95D10



18-3820
HEAD GASKET
Replaces: 11141-94701, 11141-94702, 11141-94720



18-3822
HEAD GASKET
Replaces: 11141-87E90, 11141-87E10



18-3823
HEAD GASKET
Replaces: 11141-94506, 11141-94620



18-3824
HEAD GASKET
Replaces: 11141-94600, 11141-94620



18-3825
HEAD GASKET
Replaces: 11141-87D90, 11141-87D60

Model	Year	Cyl	Head Gasket	Model	Year	Cyl	Head Gasket	Model	Year	Cyl	Head Gasket
2	1983-89	1	18-3806	25	1989	3	18-3819	85	1983-87	3	18-3814
5	1983	2	18-3816	30	1983-87	2	18-3809	90	1989	V-4	18-3822
6	1984-89	2	18-3807	30	1988-89	3	18-3819	100	1989	V-4	18-3822
8	1983-87	2	18-3807	35	1987-89	2	18-3810	115	1983-85	4	18-3823
8	1988-89	2	-	40	1984-89	2	18-3810	115	1986-89	4	18-3824
9.9	1983-87	2	18-3808	50	1984	2	18-3813	140	1983-85	4	18-3823
9.9	1988-89	2	-	55	1985-89	3	18-3820	140	1986-89	4	18-3824
15	1983-89	2	18-3808	65	1985-89	3	18-3820	150	1986	V-6	18-3825
25	1983-88	2	18-3809	75	1983-87	3	18-3814	200	1986	V-6	18-3825



18-7895
OIL FILTER
Replaces: 16510-93J00
Thread Spec: 3/4" x 16NPT



18-7896
OIL FILTER
Replaces: 16510-61A20-MHL
Fits: DF70A, DF80A, DF90A, DF90-DF115



18-7897
OIL FILTER
Replaces: 16510-82703
Fits: DF140



18-7903
OIL FILTER
Replaces: 16510-05240
For: DF9.9, DF15 (1996-06)



18-7905-1
OIL FILTER
Replaces: 16510-96J00
Fits: DF150-DF300



18-7915-1
OIL FILTER
Replaces: 16510-87J00
Fits: DF25-DF70



18-8870
OIL FILTER
Replaces: 16510-45H10
Fits: F9.9 Type T7H(Sn 110001 & Newer), F15(SN 110001 & Newer)



18-0650
OIL SEAL HOUSING GASKET

Replaces: 56132-95J00
Fits: F 25 V-Twin (2006-07)



18-0651
PUMP CASE PANEL GASKET

Replaces: 17472-98J00
Fits: F300 (2007)

PKG. OF 5



18-8331
18-8331-9①
DRAIN PLUG GASKET

Replaces: 09168-10022



18-8334
SHIFT SHAFT SEAL

Replaces: 25223-94400

PKG. OF 10



COTTER PINS

Part #	Replaces
18-3737 ②	09204-02004
For: DT9.9 & 15C, DF9.9 & 15, 8 & 9.9C Oil Injected	
18-3735 ②	09204-03003, 09204-03004
For: DT20, 25C, 30C	



18-3726
PROP NUT

Replaces: 09141-18005



18-3710
PROP NUT

Replaces: 09141-14008



18-3774
PROP NUT KIT

Replaces: 57630-94500
For: DT75/85/90/100/115, 140 with V-Style, DF60/70 with V-Style
— CONTAINS —

Part #	O.E. #	Desc.
18-3726	09141-18005	Prop Nut
18-3735	09204-03003,	Cotter
	09204-03004	Pin
—	09160-18028	Washer
—	57633-94500	Spacer



18-3775
PROP NUT KIT

Replaces: 57630-92E00
For: V-6
— CONTAINS —

Part #	O.E. #	Description
18-3726	09141-18005	Prop Nut
18-3735	09204-03003,	Cotter Pin
	09204-03004	
—	09160-18019	Washer
18-3795	57633-87D30	Spacer



18-3777
PROP NUT KIT

Replaces: 57630-94300
For: DT40/55/65
— CONTAINS —

Part #	O.E. #	Description
18-3726	09141-18005	Prop Nut
18-3735	09204-03003,	Cotter Pin
	09204-03004	
—	09160-18028	Washer



18-3778
PROP NUT KIT

Replaces: 57630-96300
For: DT20/25C/30C
— CONTAINS —

Part #	O.E. #	Description
18-3735	09204-03003,	Cotter Pin
	09204-03004	
—	09160-18028	Washer
18-3710	09141-14008	Prop Nut
—	57633-96300	Spacer



② **18-6032**
ANODE

Replaces: 55320-95310
5S-140 HP



③ **18-6033**
ANODE

Replaces: 55125-87D00
150-200 HP



③ **18-6098**
ANODE

Replaces: 55125-96310
DF25, DF30, DT20, DT25, DT25C, DT30, DT30C, DT35



⑤ **18-6161A**
④ **18-6161M**
ANODE KIT

Fits: Suzuki 90-140HP Engines



18-79989
TRAILERING STICKS

Fits: Most outboards over 150hp with three ram intrigrel tilt/trim.



18-8380
LOWER UNIT SEAL KIT

Replaces: 25700-93J00
For: All DF150/DF175/DF200/DF225/DF250

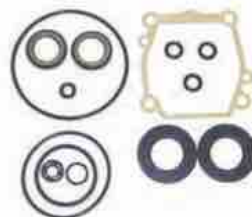

18-8381
LOWER UNIT SEAL KIT

Replaces: 25700-99E00
For: DF 60(2001 & Up), DF70(2001 & Up)

① Priced per Package. ② This product is priced per piece. To order priced per package, please add -9 to the part number
③ Aluminum ④ Magnesium ⑤ Zinc

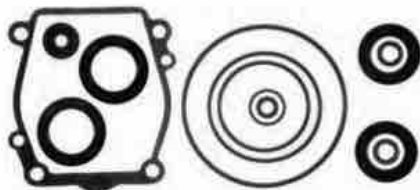

18-8335
LOWER UNIT SEAL KIT
 Replaces: 25700-87D00

— CONTAINS —

Part #	Description	O.E. #	Qty.
18-7118	O-Ring	09280-08005	1
18-7183	O-Ring	09280-69001	1
18-8331	Drain Plug Gasket	09168-10022	2
18-7440-1	O-Ring	—	1
18-0544	Oil Seal	09282-24004	2



18-8337
LOWER UNIT SEAL KIT
 Replaces: 25700-94400

— CONTAINS —

Part #	Description	O.E. #	Qty.
18-0461	Water Pump Gasket	17472-96301	1
18-7151	O-Ring	09280-75001	1
18-7413	O-Ring	09280-08005	2
18-8331	Drain Plug Gasket	09168-10022	3
18-8334	Shift Shaft Seal	25223-94400	1
18-8345	Seal	09289-22007	2
18-7180	O-Ring	—	1

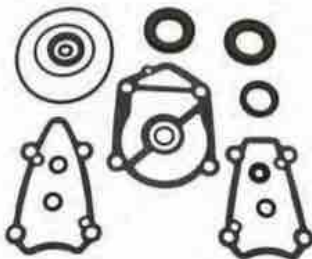

18-8338
LOWER UNIT SEAL KIT
 Replaces: 25700-94500

— CONTAINS —

Part #	Description	O.E. #	Qty.
18-7118	O-Ring	09280-08008	1
18-8331	Drain Plug Gasket	09168-10022	3
18-7182	Oil Seal	—	1
18-7133	O-Ring	—	1

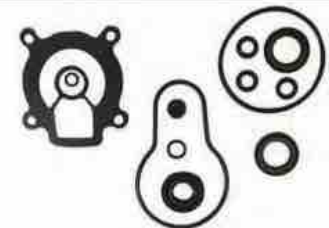

18-8339
LOWER UNIT SEAL KIT
 Replaces: 25700-94700

— CONTAINS —

Part #	Description	O.E. #	Qty.
18-0460	Water Pump Gasket	17472-95310	1
18-7151	O-Ring	09280-76006	1
18-7180	O-Ring	—	1
18-7413	O-Ring	09280-08005	1
18-8329	Seal	09289-17005	1
18-8331	Drain Plug Gasket	09168-10022	3
18-8334	Shift Shaft Seal	25223-94400	1
18-8345	Seal	09289-22007	2



18-8340
LOWER UNIT SEAL KIT
 Replaces: 25700-95500

— CONTAINS —

Part #	Description	O.E. #	Qty.
18-0459	Water Pump Gasket	17472-95200	1
18-8331	Drain Plug Gasket	09168-10022	3
18-8334	Shift Shaft Seal	25223-94400	1
18-7180	O-Ring	—	1
18-7413	O-Ring	09280-08005	1
18-7127	O-Ring	—	1



18-8341
LOWER UNIT SEAL KIT
 Replaces: 25700-95D00

— CONTAINS —

Part #	Description	O.E. #	Qty.
18-0461	Water Pump Gasket	17472-96301	1
18-7118	O-Ring	09280-50005	1
18-7413	O-Ring	09280-08005	1
18-7140	O-Ring	09282-17006	1
18-8331	Drain Plug Gasket	09168-10022	3



18-8373
LOWER UNIT SEAL KIT
 Replaces: 25700-90J01
 Fits: DF 90/115 (All Years)



18-8374
LOWER UNIT SEAL KIT
 Replaces: 25700-92J00
 Fits: DF140 (All Years)

SEAL KIT APPLICATION NEXT ON PAGE



**18-8385
SEAL KIT**

Replaces: 25700-95J00
Fits: DF25 V-Twin (2006-07)

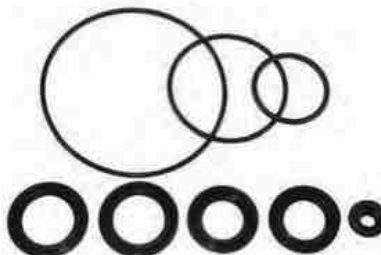

**18-8386
SEAL KIT**

Replaces: 25700-98J00
Fits: DF300 (2007)

SEAL KIT APPLICATION

HP/MODEL	YEAR	PART #	HP/MODEL	YEAR	PART #
DT25C	All	18-8341	DT115	All	18-8338
DF25	All	18-8341	DF115	All	18-8373
DF25 V-Twin	2006-07	18-8385	DT140	All	18-8338
DT30C	All	18-8341	DF140	All	18-8374
DF30	All	18-8341	DT150	All	18-8335
DT40C	All	18-8337	DF150	All	18-8380
DF40	All	18-8337	DT175	All	18-8335
DF50	All	18-8337	DF175	All	18-8380
DT55	All	18-8339	DT200	All	18-8335
DF60	2001-07	18-8381	DF200	All	18-8380
DT65	All	18-8339	DT225	All	18-8335
DF70	2001-07	18-8381	DF225	All	18-8380
DT75	All	18-8340	DF250	All	18-8380
DT85	All	18-8340	DF300	All	18-8386
DF90	All	18-8373			

PKG. OF 2



OIL SEALS

Part #	O.E. #	I.D.	Dimensions	
			O.D. (mm)	Width
18-0544	09282-24004	23.2	40.3	7
18-0545	09289-10002	9	22.2	8
18-0551	09283-10011	9	22.2	8
18-0569	09284-08003			
18-8345	09289-22007	22.2	35	5
18-8375		29	45	6
18-8378		8	22	7

PKG. OF 5

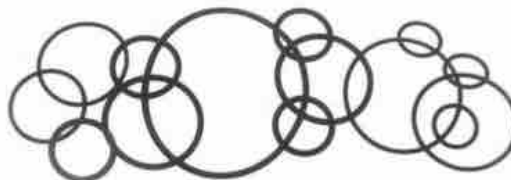

O-RINGS

Part No.	O.E. No.	Dimensions	
		I. D.	Width (mm)
18-7118 ①	09280-08008	69.40	3.10
18-7140 ①	09280-75002	69.00	3.50

① This product is priced per piece. To order priced per package, please add -9 to the part number

Model Description	Horsepower	Trim & Tilt/Starting Method	Shaft Length	Control Method	Model Year	Special Model Variation Code (Used on 25HP engines)
B = Inshore series C = C series model CV = C series D = Twin rotating propellers DX = Twin rotating propellers OX66 EFI E = Enduro series model F = Four stroke engine model LF = Left hand four stroke L = Left hand engine model LX = Left hand OX66 EFI LZ = Left hand HPDI P = Pro series model PX = Pro series OX66 EFI S = Saltwater series model SX = Saltwater series OX66 EFI T = Four stroke engine with high thrust V = V max series model VX = V max OX66 EFI VZ = V max HPDI Z = HPDI series	Example: 6 9.9 200 250	T = Power tilt or trim/tilt (1984-1990) P = Power tilt with electric start E = Electric start (1984-1990) M = Manual tilt with manual start	S = 15" L = 20" X = 25" U = 30"	R = Remote control H = Tiller handle J = Jet drive unit	N = 1984 K = 1985 J = 1986 H = 1987 G = 1988 F = 1989 D = 1990 P = 1991 Q = 1992 R = 1993 S = 1994 T = 1995 U = 1996 V = 1997 W = 1998 X = 1999 Y = 2000 Z = 2001 A = 2002 B = 2003 C = 2004 D = 2005	2 = 3 Cyl. 1997 3 = 3 Cyl.

Starting in April 2005 (2006 Model Year and newer) Yamaha no longer designated model years at the end of the model number identification. Beginning at this time any subsequent "new model" will have a letter designation between the Horsepower and the Control / Tilt Method.

Example:

VZ300TLRD = 2005

VZ300TLR = New model after April 2005.

VZ300BTLR = Newest Model and direct replacement for previous models.

EXAMPLE: SX150TLRY - Saltwater EFI, 150 HP, Trim & Tilt w/electric start, 20", Remote control, 2000 model



18-5130
CDI

Replaces: 688-85540-16-00
Fits: 90(1988-91), C75(1994-96), C85(1991-96), CV85(1989-90), E75(1995-96)



18-5131
CDI

Replaces: 695-85540-11, 695-85540-12-00
Fits: 9.9(1984-95), 15(1984-95), C25(1992-97), CV25(1990)



18-5132
CDI

Replaces: 63V-85540-00-00, 63V-85540-01-00, 63V-85540-02-00
Fits: 9.9(1999-09), 15(1999-09)



18-5110
IGNITION COIL

Replaces: 6E5-85570-11-00
For: 115 (4 cyl.), 1985-91



18-5111
IGNITION COIL

Replaces: 697-85570-11-00
For: 55 (2 cyl.) 1989-94 and 90 1984-88



18-5112
IGNITION OIL

Replaces: 6E7-85570-19-00, 680-85570-09-00, 6E7-85570-10-00, 695-85570-10-00
For: 9.9/15 (1988-93)



18-5128
IGNITION COIL

Replaces: 6R3-85570-01-00
For: 115/130/150HP (1994-04) 175HP (1994-95, 1997-98, 2000) 200HP (1994-98) 225HP (1997) B115HP (1998-99) C115HP (1997-98) for late model V4 & V6



18-5183
COIL, CHARGE

Replaces: 63V-85520-00, 63V-85520-01
Fits: 9.9(1996-09), 15(1996-09)



18-5195
COIL, IGNITION

Replaces: 689-81311-40-00
Fits: 25(1984-87), 30(1984-86), C30(1991-92), C40(1994-97), CV30(1989-90), CV40(1990)



18-5138
COIL, IGNITION

Replaces: 680-85570-00-00, 680-85570-02-00
Fits: T6 (02-05), F6, F8 (01-05); C25 (96-97)



18-5113
COIL, IGNITION

Replaces: 61N-85570-00-00, 61N-85570-10-00
Fits: 25(1994-95, 2001-09)



18-25650
COIL, PULSER

Replaces: 66M-85580-00-00
Fits: F9.9(2005-06), T9.9(2005-06), F15(1996-06)



18-25652
COIL, PULSER

Replaces: 63V-85580-01-00
Fits: 9.9(2003-09), 15(2003-09)



18-25604
LIGHTING COIL

Replaces: 63V-85533-00-00
Fits: 9.9(1996-09), 15(1996-09)



18-5135
CDI

Replaces: 6E5-85540-10-00, 6E5-85540-11-00, 6E5-85540-12-00
Fits: 115 ET 1984-1989; 130 ET 1988-1989; C115TLR 1991-1996; C115TXR 1992-1996; L130ETX 1989; 1989 2-225HP



18-5136
CDI

Replaces: 6F5-85540-21-00, 6F5-85540-22-00
Fits: 40HP 2 Cylinder (Intl)



18-25300
CDI UNIT ASSEMBLY

Replaces: 66M-85540-01-00
Fits: F9.9(2005-06), F15(2000-06)

PREMIUM MARINE SPARK PLUG WIRE LEADS

Sierra's MAGFORCE Ignition Wires are "Electronics Friendly" protecting all of your electronic devices and electronic engine controls from RFI and EMI while delivering the maximum amount of voltage. Exact fit design ensures easy installation and years of trouble - free service.

Part #	OEM #	Application
18-5217-1	67F-82341-00-00	F75 (2003-2017), F80 (1999-2003), F90 (2003-2017), F100 (1999-2003)
18-5218-1	67F-82342-00-00	F75 (2003-2017), F80 (1999-2003), F90 (2003-2017), F100 (1999-2003)
18-5219-1	67F-82343-00-00	F75 (2003-2017), F80 (1999-2003), F90 (2003-2017), F100 (1999-2003)
18-5220-1	67F-82344-00-00	F75 (2003-2017), F80 (1999-2003), F90 (2003-2017), F100 (1999-2003)
18-8847-1 (Set)	67F-82341-00-00 + 67F-82342-00-00 + 67F-82343-00-00 + 67F-82344-00-00	F75 (2003-2017), F80 (1999-2003), F90 (2003-2017), F100 (1999-2003)

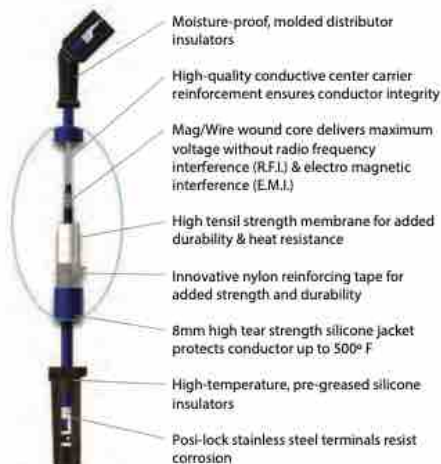









MP39160
MOMENTARY PUSH SWITCH
For outboard installations.



MP51020 (CLAMSHELL)
MP51022 (BULK 100 PCS/CTN)
IGNITION SWITCH
Replaces: 703-82510-12-00
Yamaha Control Box 2 & 4 stroke
Colors on wires match factory color codes



MP51030 (CLAMSHELL)
MP51032 (BULK 100 PCS/CTN)
IGNITION SWITCH
Replaces: 61B-82510-01-00, 61B-82510-00-00
Yamaha Dash Mount 2 Stroke
Dual Engine Application Colors on wires match factory color codes

 <p>MP51040 (CLAMSHELL) MP51042 (BULK 100 PCS/CTN) IGNITION SWITCH Replaces: 703-82510-43-00 Yamaha Control Box 2 & 4 stroke Push to Choke Colors on wires match factory color codes</p>	 <p>MP51050 (CLAMSHELL) MP51052 (BULK 100 PCS/CTN) IGNITION SWITCH Replaces: 6K1-82510-06-00 Yamaha Dash Mount 2 & 4 Stroke Dual Engine Application, Push to Choke Colors on wires match factory color codes</p>	 <p>MP28860 IGNITION LANAYARD Replaces: 682-62556-00-00</p>
 <p>18-65450 ENGINE STOP SWITCH Replaces: 6E9-82575-02-00 Fits: Yamaha 6(1995-00), 6(1995-09), 9.9(1994-95), C30(1994-98), C40(1994-97)</p>	 <p>18-5225 SPARK PLUG WIRE KIT Kit includes 25 ft. Roll of 7 MM Hypalon Ignition Wire With a Metallic Core and a Large Assortment of Three Different End Fittings to Fit Outboard Motors.</p>	 <p>18-5226 IGNITION WIRE Metallic Core 100' Spool 7mm Hypalon</p>
<p>PKG. OF 10</p>  <p>18-5750 18-5750-9① UNIVERSAL SPARK PLUG BOOTS Replaces: OMC 581027, 580339 Supplied complete w/Terminal Connector</p>	 <p>18-5752 UNIVERSAL SPARK PLUG BOOTS 8mm</p>	<p>PKG. OF 10</p>  <p>18-5224 18-5224-9① SPARK PLUG WIRE TERMINAL Replaces: Mercury 20121 OMC 510364</p>

① Priced per Package

YAMAHA OUTBOARD IGNITION CHART APPLICATION

HP	Year Start	Year Stop	CDI	Ignition Coil	Charge Coil (Stator)	Pulsar Coil	Lighting Coil
8.9	1984	1995	18-5131	18-5111	-	-	-
9.9	1996	1998	-	-	18-5183	18-25652	18-25604
9.9	1999	2009	18-5132	-	18-5183	18-25652	18-25604
15	1984	1995	18-5131	18-5112	-	-	-
15	1996	1998	-	-	18-5183	18-25652	18-25604
15	1999	2009	18-5132	-	18-5183	18-25652	18-25604
20	1996	1997	-	18-5113	-	-	-
25	1984	1987	-	-	18-5195	-	-
25	1994	2009	-	18-5113	-	-	-
30	1984	1986	-	-	18-5195	-	-
90	1984	1988	-	18-5111	-	-	-
90	1988	1991	18-5130	-	-	-	-
115	1984	1989	18-5135	18-5110	-	-	-
115	1994	2009	-	18-5128	-	-	-
130	1988	1989	18-5135	18-5110	-	-	-
130	1994	2004	-	18-5112	-	-	-
150	1984	1989	-	18-5110	-	-	-
150	1994	2009	-	18-5112	-	-	-
175	1984	1989	-	18-5110	-	-	-

APPLICATION CONTINUED ON NEXT PAGE

YAMAHA OUTBOARD IGNITION CHART APPLICATION (Cont.)

HP	Year Start	Year Stop	CDI	Ignition Coil	Charge Coil (Stator)	Pulser Coil	Lighting Coil
175	1994	1995	-	18-5112	-	-	-
175	2000	2000	-	18-5112	-	-	-
200	1984	1989	-	18-5110	-	-	-
200	1994	1996	-	18-5112	-	-	-
225	1994	1997	-	18-5112	-	-	-
B115	1996	1999	-	18-5112	-	-	-
C25	1992	1995	18-5131	18-5112	-	-	-
C25	1996	1997	18-5131	18-5138	-	-	-
C30	1991	1992	-	-	18-5195	-	-
C30	1993	1997	-	18-5113	-	-	-
C40	1991	1997	-	-	18-5195	-	-
C55	1991	1994	-	18-5111	-	-	-
C75	1994	1996	18-5130	-	-	-	-
C85	1991	1996	18-5130	-	-	-	-
C115	1991	1996	18-5135	18-5110	-	-	-
C115	1997	2000	-	18-5112	-	-	-
C150	1996	1999	-	18-5112	-	-	-
CV25	1990	1990	18-5131	18-5112	-	-	-
CV30	1989	1990	-	-	18-5195	-	-
CV40	1990	1990	-	-	18-5195	-	-
CV55	1989	1990	-	18-5111	-	-	-
CV85	1989	1990	18-5130	-	-	-	-
D150	1997	1999	-	18-5112	-	-	-
E48	1995	1996	-	18-5112	-	-	-
E75	1995	1996	18-5130	-	-	-	-
F6	2001	2006	-	18-5138	-	-	-
F8	2001	2015	-	18-5138	-	-	-
F9.9	2005	2006	18-25300	-	-	18-25650	-
F9.9	2007	2014	-	18-5138	-	-	-
F15	1988	1999	-	-	-	18-25650	-
F15	2000	2005	18-25300	-	-	18-25650	-
F25	1998	2004	-	-	-	-	-
F25	2005	2005	-	-	-	-	-
F30	2001	2005	-	-	-	-	-
F40	2000	2006	-	-	-	-	-
L130	1989	1989	18-5135	18-5110	-	-	-
L130	1994	2001	-	18-5112	-	-	-
L150	1986	1989	-	18-5110	-	-	-
L150	1994	1999	-	18-5112	-	-	-
L200	1986	1989	-	18-5110	-	-	-
L200	1994	1999	-	18-5112	-	-	-
P115	1994	1996	-	18-5112	-	-	-
P150	1994	1999	-	18-5112	-	-	-
P175	1994	1999	-	18-5112	-	-	-
P200	1994	1999	-	18-5112	-	-	-
PROV150	1986	1989	-	18-5110	-	-	-
S115	1996	1999	-	18-5112	-	-	-
S130	1996	1999	-	18-5112	-	-	-
S150	1996	1999	-	18-5112	-	-	-
S175	1996	1999	-	18-5112	-	-	-
S200	1996	1999	-	18-5112	-	-	-
T8	2001	2010	-	18-5138	-	-	-
T9.9	2005	2006	18-25300	-	-	18-25650	-
T9.9	2007	2014	-	18-5138	-	-	-
T25	2001	2004	-	-	-	-	-

APPLICATION CONTINUED ON NEXT PAGE

YAMAHA OUTBOARD IGNITION CHART APPLICATION (Cont.)

HP	Year Start	Year Stop	CDI	Ignition Coil	Charge Coil (Stator)	Pulser Coil	Lighting Coil
T25	2005	2005	-	-	-	-	-
T25	2006	2006	-	-	-	-	-
V150	2000	2008	-	18-5112	-	-	-
V175	2000	2000	-	18-5112	-	-	-
V6EXCEL	1987	1989	-	18-5110	-	-	-
V6SPECIAL	1984	1986	-	18-5110	-	-	-



18-5819
SOLENOID

Replaces: 65W-81941-00-00
For: F25 (1998-04), F30 (2001-04), F40 (2000-04)



18-5853
SOLENOID

Replaces: 61A-81941-00-00, 6E5-81941-11-00, 6E5-81941-10-00, 6E5-81941-00-00
For: 2-Stroke: 115hp - 150hp. (1994-Current); 175hp (1994-2000); 200hp (1994-2005); 225hp. (1995-2004); 250hp (1990-2004)



18-5821
STARTER
SOLENOID

Replaces: 6G1-81941-10-00
Fits: 3.9/15(1988-97), 20(1996-97), 25(1985, 1988-99), 30(1985-87, 1989-93, 1995-99, 2001), 40(1989-90, 1992-01), 50(1989-97, 1999-02), 1990(1992-02), F15(1998-03), F40(1999), F50(1996-02), F60(2002-03), F75(2003-04), F80(1999-03), F90(2003-04), F100(1999-02)



18-5879
SOLENOID

Replaces: 688-81950-10-00, 688-81941-00-00
For: 2-Stroke: 40hp (1984-88); 50hp (1984-88); 60hp. (2001-06); 70hp. (1991-Current); 90hp. (1984-91)



18-5746
STATOR ASSEMBLY

Replaces: 6H3-85510-A0, 6H3-85510-A1
Fits: E60(1995-99), P60(1991), 70(1984-91)



18-6410
OUTBOARD STARTER

Replaces: Yamaha 689-81800-13-00, 689-81800-11, 689-81800-12
Fits: 25-40HP (11 tooth)



18-6411
OUTBOARD STARTER

Replaces: 6H3-81800-11-00, 6H3-81800-10
Fits: 60HP



18-6412
OUTBOARD STARTER

Replaces: 697-81800-12, 99999-03249-00
Fits: 55-60HP 2 cylinder (9 tooth)



CE

18-6413
OUTBOARD STARTER
Replaces: 6E5-81800-11-00,
6E5-81800-12-00
Fits: 55-60HP 2 cylinder (9 tooth)



CE

18-6415
OUTBOARD STARTER
Replaces: 6N7-81800-10-00
Fits: 115-250HP (9 tooth)



18-6961
STARTER
Replaces: 6CB-81800-00-00
Fits: 200, 225, 250 4 Cycle (2006 & Up)



CE

18-6420
OUTBOARD STARTER
Replaces: 6L2-81800-20-00
Fits: 20HP MLHU & MSHU (1996),
20HP MLHV & MSHV 1997 25 (1988-98)



CE

18-6421
OUTBOARD STARTER
Replaces: 6F5-81800-11, 6J4-81800-01-00
Fits: 25HP (1999&2001), 30HP (1996-99 & 2001),
40HP (1992-03) C40 1997-02, P40 (1998)
50 (1992-97 & 2000 & 2002-03) C50 (1998-01), P50 (1993-96)



CE

18-6422
OUTBOARD STARTER
Replaces: 6H4-81800-12-00
Fits: 40HP (1984-86), 50HP (1986-88), Pro 50
(1987-88)



CE

18-6423
OUTBOARD STARTER
Replaces: 688-81800-12-00
Fits: C75 (1994-96), (1998-99), P75 (1996-99),
C80 TLRV (1997), C85 (1991-96)
CV85 (1990), 90 (1984-03), B90 (1998-99) C90 (1997-01)



CE

18-6425
OUTBOARD STARTER
Replaces: 67F-81800-02-00
Fits: F75 (2003), F80 (2001-02), F90 (2003), F100
(2001-02)



CE

18-6426
OUTBOARD STARTER
Replaces: 68F-81800-01-00
Fits: LZ150(00-05), LZ200(00-11), VZ150(00-11),
VZ175(01-11), VZ200(01-04), Z150(00-05), Z175(01-
05), Z200(00-11)



CE

18-6427
OUTBOARD STARTER
Replaces: 68V-81800-01-00
Fits: F115 2001-03



18-6832
STARTER
Replaces: 60V-81800-00-00,
60X-81800-00-00
Fits: 250HP engines 2003-04



18-6833
STARTER
Replaces: 69J-81800-00-00
Fits: 2002-2004 200-225HP



18-6861
STARTER
Replaces: Yamaha 61A-81800-01-00,
69L-81800-00-00, 69W-81800-00
Hitachi S114-559B
Fits: Yamaha 200-250HP Engines



18-6942
STARTER
Replaces: Yamaha 69W-81800-00-00
Hitachi S114-682
Fits: 2002-04 60HP, 2003-04 50HP



18-6943
STARTER
Replaces: 66M-81800-01-00, 02-00
Fits: 9.9-15HP Engines

HP	Stroke	Model	Year	Starter	HP	Stroke	Model	Year	Starter
9.9		9.9	1984-1997	18-6420	40		C40	1991-1997	18-6410
9.9	4	F9.9ELR2	2006 & UP	18-6943	40		C40ELRP	1991	18-6410
9.9		F9.9ELR2D	2005	18-6943	40		C40ELRQ - C40TLRZ	1992-2001	18-6410
9.9	4	F9.9MLH2	2006 & UP	18-6943	40		CV40ELD	1990	18-6410
9.9		F9.9MLH2D	2005	18-6943	40		F40TLRX	1999	18-6413
9.9	4	F9.9MSH2D	2006 & UP	18-6943	40		P40	1998	18-6421
9.9		F9.9MSH2D	2005	18-6943	40		P40TLHW - P40TLRW	1996	18-6421
9.9	4	T9.9ELH2	2006 & UP	18-6943	50		50	1984-1988	18-6422
9.9		T9.9ELH2D	2005	18-6943	50		50	1989-2009	18-6421
9.9	4	T9.9ELR2 - T9.9EXH2	2006 & UP	18-6943	50		50EJRC - 50TLHV	1992-2001	18-6421
9.9		T9.9EXH2D	2005	18-6943	50	2	50TLR	2006 & UP	18-6421
15		15	1984-1997	18-6420	50		50TLRA - 50TLRZ	1996-2005	18-6421
15	4	F15ELH	2006 & UP	18-6943	50		C50	1998-2001	18-6421
15		F15ELHA - F15ELHD	2002-2005	18-6943	50		C50TLRW - C50TLRZ	1998-2001	18-6421
15	4	F15ELHK	2006 & UP	18-6943	50		F50	1995-2002	18-6413
15		F15ELHY - F15ELHZ	2000-2001	18-6943	50		F50TJRA - F50TLRZ	1995-2002	18-6413
15	4	F15ESH	2006 & UP	18-6943	50		P50	1991-1996	18-6421
15		F15ESHA - F15ESHD	2002-2005	18-6943	50		P50TLRR - P50TLRU	1993-1996	18-6413
15	4	F15ESHK	2006 & UP	18-6943	50		T50	1996-2002	18-6413
15		F15ESHY - F15ESHZ	2000-2001	18-6943	50		T50TLRA - T50TLRY	1996-2002	18-6413
15	4	F15MLH	2006 & UP	18-6943	55		C55	1991-1995	18-6412
15		F15MLHA - F15MLHD	2002-2005	18-6943	55		CV55	1989-1990	18-6412
15	4	F15MLHK	2006 & UP	18-6943	60		60	2001-2005	18-6411
15		F15MLHY - F15MLHZ	2000-2001	18-6943	60	2	60TLR	2006 & UP	18-6411
15	4	F15MSH	2006 & UP	18-6943	60		60TLRA - 60TLRZ	2001-2005	18-6411
15		F15MSHA - F15MSHD	2002-2005	18-6943	60		C60	1996-2001	18-6411
15	4	F15MSHK	2006 & UP	18-6943	60		C60ELRU - C60TLRZ	1996-2001	18-6411
15		F15MSHY - F15MSHZ	2000-2001	18-6943	60		P60	1991-1999	18-6411
15	4	F15PLH	2006 & UP	18-6943	60		P60TLHP - P60TLHX	1991-1999	18-6411
15		F15PLHA - F15PLHD	2002-2005	18-6943	70		70	1984-2009	18-6411
15	4	F15PLHK	2006 & UP	18-6943	70		70ETLD - 70ETLN	1984-1990	18-6411
15		F15PLHZ	2001	18-6943	70	2	70TLR	2006 & UP	18-6411
15	4	F15PLR	2006 & UP	18-6943	70		70ETLN - 70TRP	1984-2005	18-6411
15		F15PLRA - F15PLRD	2002-2005	18-6943	70		C70	2000-2001	18-6411
15	4	F15PLRK	2006 & UP	18-6943	70		C70TLRY - C70TLRZ	2000-2001	18-6411
15		F15PLRZ	2001	18-6943	75		C75	1994-1999	18-6423
25		25 (2 CYL)	1984-1987	18-6410	75		C75TLRS - C75TLRX	1994-1999	18-6423
25		25 (2 CYL)	1988-2009	18-6420	75		F75	2003-2004	18-6425
25		C25	1991-1997	18-6410	75		F75	2005-2011	18-6427
25		CV25	1990	18-6410	75		F75TLRB - F75TLRD	2003-2005	18-6425
25	2	25ELH	2006 & UP	18-6420	75		F75TLRD	2005	18-6427
25		25ELH - 25ELN	1984-1987	18-6410	75		P75	1996-1999	18-6423
25	2	25ELR	2006 & UP	18-6420	75		P75TLHU - P75TLHX	1996-1999	18-6423
25	2	25ESH	2006 & UP	18-6420	80		C80	1997	18-6423
25		25ESH - 25ESN	1984-1987	18-6410	80		C80TLRV	1997	18-6423
25	2	25ESR	2006 & UP	18-6420	80		F80	1999-2003	18-6425
25		25LH - 25LN	1984-1987	18-6410	80		F80TJRA - F80TLRZ	2001-2003	18-6425
25	2	25MLH	2006 & UP	18-6420	85		C85	1991-1996	18-6423
25		25MLHX3	1999	18-6421	85		C85ELD - C85TLRU	1990-1996	18-6410
25	2	25MSH	2006 & UP	18-6420	85		CV85	1989-1990	18-6423
25		25MSHX3 - 25MSHZ3	1999-2001	18-6421	85		CV85ELF	1989	18-6410
25		25SH - 25SN	1984-1987	18-6410	90		90	1984-2009	18-6423
25		C25ELD - C25SHSV	1990-1997	18-6410	90		90ETLD - 90TJRZ	1984-2001	18-6410
30		30	1984-1986	18-6410	90	2	90TLR	2006 & UP	18-6410
30		30	1987-2001	18-6421	90		90TLRA - 90TLRZ	1991-2005	18-6410
30		30ELHT - 30ELHY	1995-2001	18-6421	90		B90	1997-1999	18-6423
30		30ELJ - 30ELN	1984-1986	18-6410	90		B90TLRV - B90TLRX	1997-1999	18-6410
30		30ELRT - 30ELRZ	1995-2001	18-6421	90		C90	1997-2001	18-6423
30		30ESJ - 30ESN	1984-1986	18-6410	90		C90TLRV - C90TLRZ	1997-2001	18-6410
30		30ESRT - 30MSHZ	1995-2001	18-6421	90		F90	2003-2004	18-6425
30		C30	1991-1997	18-6410	90		F90	2006-2011	18-6427
30		C30ELD - C30MLHS	1990-1997	18-6410	90	4	F90TJR	2006 & UP	18-6427
30		CV30	1989-1990	18-6410	90		F90TJRB - F90TJRC	2003-2004	18-6425
30		CV30ELF	1989	18-6410	90	4	F90TLR	2006 & UP	18-6427
40		40	1984-1988	18-6422	90		F90TLRB - F90TLRC	2003-2004	18-6425
40		40	1989-2005	18-6421	90	4	F90TXR	2006 & UP	18-6427
40		40EJRC	1992	18-6421	100		F100	1999-2003	18-6425
40		40EJRR - 40TLHV	1993-2001	18-6421	100		F100TLRA - F100TXRZ	2001-2003	18-6425
40	2	40TLR	2006 & UP	18-6421	115		115	1984-1996	18-6413
40		40TLRA - 40TLRZ	1994-2005	18-6421	115		115	2000-2009	18-6415

APPLICATION CONTINUED ON NEXT PAGE

HP	Stroke	Model	Year	Starter	HP	Stroke	Model	Year	Starter
115		115ETLD	1990	18-6413	175		Z175TXRA - Z175TXRZ	2001-2005	18-6426
115		115ETLD-JD	1990	18-6413	200		200	1984-1996	18-6413
115		115ETLF	1989	18-6413	200		200ETLD - 200TXRT	1984-1996	18-6413
115		115ETLF-JD	1989	18-6413	200	4	F200TXR	2006 & UP	18-6833
115		115ETLG	1988	18-6413	200		F200TXRA - F200TXRD	2002-2005	18-6833
115		115ETLG-JD	1988	18-6413	200	4	F200XTR	2006 & UP	18-6833
115		115ETLH	1987	18-6413	200		L200	1986-1996	18-6413
115		115ETLH-JD	1987	18-6413	200		L200ETF - L200TXRU	1986-1996	18-6413
115		115ETLJ - 115TXRT	1984-1996	18-6413	200	4	LF200TXR	2006 & UP	18-6833
115		C115	1991-1996	18-6413	200		LF200TXRA - LF200TXRD	2002-2005	18-6833
115		C115	2000	18-6415	200		LX200	1999-2001	18-6415
115		C115LXRQ - C115TXRU	1991-1996	18-6413	200		LZ200	2002-2011	18-6426
115		F115	2000-2011	18-6427	200	2	LZ200TXR	2006 & UP	18-6426
115	4	F115TJR	2006 & UP	18-6427	200		LZ200TXRA - LZ200TXRZ	2000-2005	18-6426
115		F115TJRA - F115TJRD	2002-2005	18-6427	200		P200TLRS - P200TLRU	1994-1996	18-6413
115	4	F115TLR	2006 & UP	18-6427	200		S200	1996	18-6413
115		F115TLRA - F115TLRZ	2001-2005	18-6427	200		S200TXRU	1996	18-6413
115	4	F115TXR	2006 & UP	18-6427	200		SX200	1999-2005	18-6415
115		F115TXRA - F115TXRZ	2001-2005	18-6427	200		V-200	1998-1999	18-6424
115		LF115	2000-2011	18-6427	200		V200TLRW - V200TLRX	1998-1999	18-6861
115	4	LF115TXR	2006 & UP	18-6427	200		VX200	2000-2003	18-6424
115		LF115TXRA - LF115TXRD	2002-2005	18-6427	200		VX200TLRA - VX200TLRZ	2001-2003	18-6861
115		P115	1993-1996	18-6413	200		VZ200	2001-2004	18-6426
115		P115TLRR - S115TLRU	1993-1996	18-6413	200		VZ200TLRA - VZ200TLRZ	2001-2004	18-6426
130		130	1988-1996	18-6413	200		Z200	2000-2011	18-6426
130		130	2000-2004	18-6415	200	2	Z200TLR	2006 & UP	18-6426
130		130ETLD - 130TXRT	1988-1995	18-6413	200		Z200TLRD	2005	18-6426
130		L130	1989-1996	18-6413	200		Z200TLRY - Z200TLRZ	2000-2001	18-6426
130		L130	2000-2001	18-6415	200	2	Z200TXR	2006 & UP	18-6426
130		L130ETXD - S130TXRU	1990-1996	18-6413	200		Z200TXRA - Z200TXRZ	2000-2005	18-6426
150		150	1984-1996	18-6413	225		225TUR	1995	18-6861
150		150	2000-2009	18-6415	225		225TXRS	1994	18-6861
150		150ETLD - 150TXRT	1990-1997	18-6413	225		225TXRT	1995	18-6861
150		C150	1996	18-6413	225	4	F225TUR	2006 & UP	18-6833
150		C150TLRU	1996	18-6413	225		F225TURA - F225TURD	2002-2005	18-6833
150		C150TXRU	1996	18-6413	225	4	F225TXR	2006 & UP	18-6833
150		DX150	1999-2005	18-6415	225		F225TXRA - F225TXRD	2002-2005	18-6833
150		L150	1986-1996	18-6413	225		L225	1994-1999	18-6424
150		L150ETXD - L150TXRU	1986-1996	18-6413	225		L225TUR - L225TXRX	1994-1999	18-6861
150	4	LF150TXR	2006 & UP	18-6413	225	4	LF225TUR	2006 & UP	18-6833
150		LX150	1999-2001	18-6415	225		LF225TURA - LF225TURD	2002-2005	18-6833
150		LZ150	2000-2005	18-6426	225	4	LF225TXR	2006 & UP	18-6833
150	2	LZ150TXR	2006 & UP	18-6426	225		LF225TXRA - LF225TXRD	2002-2005	18-6833
150		LZ150TXRA - LZ150TXRZ	2000-2005	18-6426	225		LX225	2000-2003	18-6424
150		Z150	2000-2005	18-6415	225		LX225TXRA - LX225TXRZ	2000-2003	18-6861
150		P150	1991-1996	18-6413	225		S225	1996-1999	18-6424
150		P150TLRQ - P150TLRU	1986-1996	18-6413	225		S225TURU - S225TXRX	1996-1999	18-6861
150		PRO V-150	1986-1990	18-6413	225		SX225	2000-2003	18-6424
150		S150	1996	18-6413	225		SX225TURA - SX225TXRZ	2000-2003	18-6861
150		S150TLRU / S150TXRU	1996	18-6413	225		V225	1998-1999	18-6424
150		SX150	2000-2001	18-6415	225		V225TLRW - V225TLRX	1998-1999	18-6861
150		V-150	2000-2008	18-6415	225		VX225	2000-2003	18-6424
150		VX150	2000-2004	18-6415	225		VX225TLRA - VX225TLRZ	2000-2003	18-6861
150		VZ150	2000-2011	18-6426	250		250	1990-1995	18-6424
150	2	VZ150TLR	2006 & UP	18-6426	250		250ETXD - 250TXRT	1990-1995	18-6861
150		VZ150TLRA - Z150TLRZ	2000-2004	18-6426	250		L250	1990-1999	18-6424
150	2	Z150TXR	2006 & UP	18-6426	250		L250ETXD - L250TXRX	1990-1999	18-6861
150		Z150TXRA - Z150TXRZ	2000-2004	18-6426	250		LX250	2000-2003	18-6424
175		175	1984-1995	18-6413	250		LX250TURA - LX250TXRZ	2000-2003	18-6861
175		175	2000	18-6415	250		S250	1996-1999	18-6424
175		175ETLD - 175TXRT	1984-1995	18-6413	250		S250TURU - S250TXRX	1996-1999	18-6861
175		P175	1994-1996	18-6413	250		SX250	2000-2003	18-6424
175		P175TLRS - P175TLRU	1994-1996	18-6413	250		SX250TURA - SX250TXRZ	2000-2003	18-6861
175		S175 / S175TXRU	1996	18-6413			V-6 SPECIAL	1984-1986	18-6413
175		V-175	2000	18-6415			V-6 SPECIAL L	1984	18-6413
175		VZ175	2001-2011	18-6426			V-6SPECIAL X	1984	18-6413
175	2	VZ175TLR	2006 & UP	18-6426					
175		VZ175TLRA - VZ175TLRZ	2001-2005	18-6426					
175		Z175	2001-2005	18-6426					
175	2	Z175TXR	2006 & UP	18-6426					



18-50000
STARTER HANDLE
Replaces: 689-15755-01-00 + 6G1-15779-00-00
Fits: Yamaha 15 hp & Up (1988 & Up)



18-50001
STARTER HANDLE
Replaces: 6G1-15755-00-00, 6G1-15779-00-00
Fits: 2.5-9.9 hp(1988 & Up)



18-56005
BRUSH HOLDER ASSEMBLY
Replaces: 6E5-81840-10-00
Fits starters: 689-81800-13-00(18-6410), 6H3-81800-11-00 (18-6410), 6F5-81800-11-00, 6J481800-01-00(18-6421), 6H4-81800-12-00 (18-6422), 6E5-81800-11-00, 6E5-81800-12-00 (18-6413)



18-56007
BRUSH HOLDER ASSEMBLY
Replaces: 61A-81840-00-00
Fits starters: 61A-81800-00-00, 61A-81800-01-00, 69L-81800-00-00 Fits:225 (1991-96), 250 (1990-95), L225 (1994-99), L250 (1990-99), LX225,LX250(2000-03), P150,P175 (1994-96), P200 1991-96, S225/S250 1996-99), SX225,SX250 (2000-03), V200/V225 (1998-99), VX200 (2000-05), VX225 (2000-04), VX250 (2002-04)



18-6798
TRIM MOTOR
Replaces: 69J-43880-00-00, 60V-43880-00-00
(O-Ring included)
Fits: F200, F225 (2004-06), F250 (2005-06), LF200, LF225, LF250, LZ200, LZ225, LZ250 (2004-06)



18-6748
TRIM MOTOR
Replaces: 67C-43880-00-00, 67C-43880-01-00
Fits: F30, F40 (2001 & Up)



18-6259
TILT/TRIM MOTOR
Replaces: 6H1-43880-00-00
(O-Ring Included)
Fits: 70/90HP (1987-91), C85/P60HP (1991)



18-6787
TILT/TRIM MOTOR
Replaces: 67F-43880-00-00
(O-Ring Included)
Fits: Yamaha 4-Stroke F75 (2003-04), F80 (1999-03), F90 (2003-04), F100 (1999-02)



18-6788
TILT/TRIM MOTOR
Replaces: 6H5-43880-02-00
(O-Ring Included)
Fits: Yamaha 40-50hp (1985-92)



18-6789
TILT/TRIM MOTOR
Replaces: 62X-43880-09-00
(O-Ring Included)
Fits: Yamaha 40-100hp (1995-03)



18-6760
TRIM MOTOR
Replaces: 6G5-43880-02-00
(O-Ring Included)
For: 115-200HP (1987-96)



18-6781
TILT/TRIM MOTOR
Replaces: 6H1-43880-02-00
2-wire connection, 3 bolt mount
For: 40HP (1994) 50HP (1992-95) 60HP (1997-up) 70HP (1996-up) 90HP (1992-up)



18-6782
TILT/TRIM MOTOR
Replaces: 61A-43880-01-00, 61A-43880-02-00
3-bolt mount, 4 wire connection
(O-Ring Included)
For: 225-250HP



18-6783
TILT/TRIM MOTOR
Replaces: 64E-43880-00-00, 64E-43880-01-00
2-wire ring terminal connection 4-bolt mount
(O-Ring Included)
For: 115-225HP (1997-2002)



18-6811
POWER TRIM MOTOR
Replaces: 62Y-43800-11-00, 62Y-43880-00-00, 69W-43880-00-00
(O-Ring included)
Fits: 40(2003 & Up), 50(2003 & Up), C40(2003), F50(2003-04), T50(2003-04), 2002-04 60hp 4-stroke



18-6812
TRIM MOTOR
Replaces: 62X-43880-00-00,
62X-43880-01-00, 62X-43880-09-00
Fits: 1995-03 Yamaha 40-100HP



18-6821
TRIM MOTOR
Replaces: 688-43880-11-00,
6E5-43880-01-00, -02-00
Fits: Yamaha 50-200HP 1985-86



18-6836
TRIM MOTOR
Replaces: 6C5-43880-00-00,
6C5-43880-01-00
Fits: 2005-06 F50 and F60



18-1522
RELAY, TRIM ASSEMBLY
Replaces: 63P-81950-00
Fits: 25-150, 200-225 HP (06-Up), 50-90, 250 HP (05-Up),
150 HP (04-Up)



18-1523
RELAY, TRIM ASSEMBLY
Replaces: 61A-81950-01
Fits: F25 HP (98-Up), T25 HP (01-Up), 60 HP (93-Up), 70
HP (93-Up), 75 HP (94-99), 80 HP (97), 85 HP (93-96), 90
HP (93-09), 150 HP (99-05), 200 HP (98-05), 225 HP
(90-04), 250 HP (90-04)



18-1524
RELAY ASSEMBLY
Replaces: 6H1-81950-01-00
Fits: 40 (1994-05), 50 (1994-05), C40 (1997-01), C50
(1998-01), F30 (2000-08), F40 (2000-08), F50 (1995-04),
F60 (2002-04), P40 (1998), P50 (1992-96), T50 (1996-04),
T60 (2003-04)



18-1525
RELAY ASSEMBLY
Replaces: 60E-81950-00-00
Fits: F30LA (2013-19), F30LEHA (2013-19), F40JEA (2008-19), F40JEHA (2008-19), F40LA (2008-19), F40LEHA (2008-
19), F40SA (2019-19), F50SA (2019-19), F60LA (2012), F60LB (2013-19), F60TLR (2005-11), T50LA (2012), T60LB
(2013-19), T50TLR (2005-11), F60JA (2012), F60JB (2013-19), F60LA (2012), F60LB (2013-19), F60TLR (2005-11), F60TLR (2005-11),
F60TLR (2005-11), T60LA (2012), T60LB (2013-19), T60TLR (2005-11), F70LA (2010-19), F75LA (2012-17), F75TLR
2005-11), F90JA (2012-17), F90LA (2012-17), F90TUR (2005-11), F90TLR (2005-11), F90TXR (2005-11), F90XA (2012-
17), LF115XA (2011-18), LF115XB (2014-18), F115JA (2011-14), F115JB (2014-18), F115LA (2011-14), F115LB (2014-
18), F115XA (2011-14), F115XB (2014-18)



18-6823
WIRING HARNESS
Converts 3-wire Tilt and Trim motors to
2-Wire design

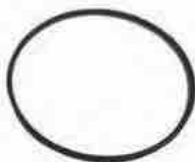

18-7484
BACK-UP RING
Replaces: 65W-43871-00-00
For: F25-F40 1999-2006 w/Power Trim



18-2083
FUEL INJECTOR SEAL
Replaces: 68V-13766-00-00



18-2081
TRIM SEALS
Replaces: 64E-43822-00-00
18-2082
Replaces: 64E-4384J-00-00



18-9802
TIMING LIGHT
Self-powered accurate up to 10,000 RPM's



18-7058
CARBURETOR KIT
Replaces: 63V-W0093-00-00
Fits: 9.9(1996-09), 15(1996-09)



18-7059
CARBURETOR KIT
Replaces: 677-W0093-00-00,
677-W0093-04-00
Fits: 9.9(1984-85), 15(1984-85)

 <p>18-7002 CARBURETOR KIT Replaces: 6E5-W0093-06-00 Fits: 115 (1986-88, 1992-93, 1995), 130 (1988, 1992-93, 1995), 150, 175 (1986-87, 1992-95), 200 (1986-87, 1992-95), 225 (1992-93)</p>	 <p>18-7290* CARB KIT Replaces: 696-W0093-02-00 *Kit contains enough components to rebuild 2 carburetors</p>	 <p>18-7291 CARB KIT Replaces: 6H1-W0093-01-00 (3) of 18-7291 = (1) of 6H1-W0093-01-00</p>	
 <p>18-7293 CARB KIT Replaces: 6A1-W0093-01-00</p>	 <p>18-7736 CARB KIT Replaces: 67D-W0093-00-00 For: (1999-02) F4</p>	 <p>18-7737 CARB KIT Replaces: 61N-W0093-00-00 For: (1993-97) C30</p>	
 <p>18-7738 CARB KIT Replaces: 66M-W0093-01-00, 66M-W0093-00-00 For: (1998-02) F15</p>	 <p>18-7739 CARB KIT Replaces: 6L2-W0093-00-00 For: (1996-97) 20 (1988-02) 25 3 cyl</p>	 <p>18-7740 CARB KIT Replaces: 6E9-W0093-02-00 For: (1990-94) C40 2 cyl</p>	
 <p>18-7741 CARB KIT Replaces: 6E9-W0093-03-00 For: (1995-98) C40 2 cyl</p>	 <p>18-7742 CARB KIT Replaces: 6H0-W0093-00-00 For: (1997) C80</p>	 <p>18-7743 CARB KIT Replaces: 67F-W0093-00-00 For: (1999-02) F80/F100</p>	 <p>18-7744 CARB KIT Replaces: 6N6-W0093-02-00 For: (1990-91) 115, 130, L130</p>
 <p>18-7747 CARB KIT Replaces: 6G5-W0093-08-00 For: (1985-86) 150/175/200, V6 Special</p>	 <p>18-7756 CARB KIT Replaces: 64D-W0093-00-00 For: (1996-01) 150/150L/175 (1996-99) 200/L200 (2000-01) 150/175 (1997-98) D150</p>	 <p>18-7759 CARB KIT Replaces: 6K7-W0093-09-00 For: (1990-91) 150/175/200 (1991-92) P200</p>	 <p>18-7765 CARB KIT Replaces: 6G1-W0093-00-00</p>



18-7766
CARB KIT
Replaces: 6H3-W0093-02-00
(3) of 18-7766 = (1) of 6H3-W0093-02-00



18-7767
CARB KIT
Replaces: 6H4-W0093-01-00
(3) of 18-7767 = (1) of 6H4-W0093-01-00



18-7768
CARB KIT
Replaces: 6H4-W0093-03-00
(3) 18-7768 = (1) 6H4-W0093-03-00



18-7769
CARB KIT
Replaces: 6E7-W0093-04-00



18-7770
CARB KIT
Replaces: 689-W0093-02-00



18-7772
CARB KIT
Replaces: 61A-W0093-01-00, 61A-W0093-00-00
For: (1991-96) 225/250 3.1 liter, L225, L250



18-34600
CARBURETOR
Replaces: 66M-14301-00-00,
66M-14301-12-00
Fits: F15(2006 & Up)



18-34601
CARBURETOR
Replaces: 67D-14301-13-00
Fits: F4(2005 & Up)



18-34603
CARBURETOR
Replaces: 63V-14301-00-00
Fits: 9.9(1996-03), 15(1996-03)



18-34604
CARBURETOR
Replaces: 69M-14301-11-00
Fits: F2.5MSH(2006 & Up)



18-34605
CARBURETOR
Replaces: 66T-14301-00-00
Fits: T40/T30 Enduro Series



18-7049
NEEDLE VALVE
Replaces: 62Y-14392-00-00, 61N-14392-00-00,
6L2-14392-00-00
Fits: C30(1993-97)



18-7054
NEEDLE VALVE
Replaces: 6G1-14546-00-00, 6G1-14546-01-00
Fits: 3(1988-02), 6(1986-00), 8(1984-03), 9.9(1996-03),
15(1996-03), F25(1998-03), F30(2000-02), F40(2000-02),
T25(2001-03)



18-7055
NEEDLE VALVE
Replaces: 6E5-14546-00-00,
6J8-14546-00-00
Fits: 25 MLJ-V3(1997), 25MLHW3(1998),
25 MSHV3(1997), 25 MSHW3(1998),
30(1987-98), 115(1986-09), 130(1988-04),
150(1986-09), 175(1986-95, 2000), 200(1986-98),
225(1990-97), 8115(1998-99), 250(1991-95),
C115(1991-00), C150(1996-99), D150(1997-99),
L130(1989-01), L150(1986-99), L200(1986-99),
L225(1994-96), L250(1990-96), P115(1993-96),
P150(1991-99), P175(1994-99), P200(1991-99),
S115(1996-99), S130(1996-99), S150(1996-99),
S175(1996-99), S200(1996-99), S225(1996),
S250(1996), V150(2000-08), V175(2000)



18-7056
NEEDLE VALVE
Replaces: 6H3-14590-00-00,
6H3-14590-01-00, 67F1439A-00-00,
6H2-14591-00-00
Fits: 40(1984-92), 50(1984-92), 70(1984-01),
C40(1991-94), C60(1996-01), C70(2000-01),
CV40(1990), E60(1995-00), F60(2000-02),
F100(2000-02), P50(1991-92), P60(1991-99)

 <p>18-700u NEEDLE VALVE Replaces: 692-14590-00-00, 692-14590-01-00 Fits: 90(1984-02), B90(1997-99), C75(1994-99), C80(1997), C85(1991-96), C90(1997-01), CV85(1989-90), E75(1995-00), P75(1996-99)</p>	 <p>18-7073 NEEDLE VALVE Replaces: 6E8-14380-12-00, 6E7-14390-12-00 Fits: 9.9(1986-95), 15(1986-95)</p>	 <p>18-7079 NEEDLE VALVE Replaces: 626-14390-90 Fits: 9.9(1984-85), 15(1984-85)</p>	 <p>18-7063 FLOAT Replaces: 6L2-14385-00-00 Fits: 20(1996-97), 25(1988-09), C30(1993-97), F15(1989-06), F40(1999), F50(1995-03), F60(2002-04), F9.9(2005-06), T50(1996-04), T60(2003-04), T9.9(2005-06)</p>
 <p>18-7064 FLOAT Replaces: 63V-14985-00 Fits: 9.9(1996-09), 15(1996-09), F25(1998-13), F30(2001-05), F40(2000-08), T25(2001-13)</p>	 <p>18-7065 FLOAT Replaces: 647-14385-00-00 Fits: 4(1984-85), 5(1984-85), 9.9(1984-85), 15(1984-85)</p>	 <p>18-7066 FLOAT Replaces: 648-14385-00-00 Fits: 25(1984-87), 30(1984-86), C25(1991-97), C30(1991-92), CV25(1990), CV30(1989-90)</p>	 <p>18-7067 FLOAT Replaces: 6G1-14985-00-00 Fits: 3(1988-02), 6(1986-00), 8(1984-00), 40(1984-88), 50(1984-88), 70(1984-91), C60(1996-01), E60(1995-00), PRO 50(1987-88), P60(1991)</p>
 <p>18-7068 FLOAT Replaces: 6E5-14385-01-00, 6E5-14385-00-00 Fits: 115(1984), 150(1984), 175(1984), 200(1984)</p>	 <p>18-7069 FLOAT Replaces: 6E5-14385-02-00 Fits: 115(1986-09), 130(1988-04), 150(1986-09), 175(1986-00), 200(1986-98), 200(1990-97), B115(1998-99), C115(1991-00), C150(1996-99), D150(1997-99), L130(1989-01), L150(1988-99), L200(1986-99), P115(1993-96), P150(1991-99), P175(1994-99), P200(1991-99), PRO150(1986-90), S115(1996-99), S130(1996-99), S150(1996-99), S175(1996-99), S200(1996-99), V150(2000-08), V6 Excel(1987-89), V6 Special(1986)</p>	 <p>18-7392 FLOAT Replaces: 676-14985-01-00 Fits: 90(1984-90), C40(1991-97), C75(1994-99), C80(1997), C85(1991-96), CV40(1990), CV85(1989-90), E75(1995-00)</p>	
 <p>18-7393 FLOAT Replaces: 6E7-14385-00-00 Fits: 4(1986-94), 5(1994), 9.9(1986-95), 15(1986-95)</p>	 <p>18-0710 FLOAT CHAMBER GASKET Replaces: 68V-14984-00 Fits: F115 (2000-10), LF115 (2000-10), F200 (2002-10), LF200 (2002-10), F225(2002-05), LF225(2002-05), F225TXR models(2007-10), LF225TXR models(2007-10)</p>	 <p>18-0711 FLOAT CHAMBER GASKET Replaces: 66K-14984-00 Fits: DX 150(1999-05), LX 150(1999-01), LZ 150(2000-05), PX 150(1989), VX 150(2000-04), VZ 150(2000-10), Z 150(2000-05), VZ 175(2001-10), Z175(2001-05), LX200(1999-01), LZ200(2000-10), SX200(1999-05), V200(1999), VX200(2000-05), VZ200(2001-09), Z200 (2000-10), L225(1999), LX225(2000-03), S225(1999), SX225(2000-03), V225(1999), VX225(2000-04), VZ225(2003-09), L250(1999), LX250(2000-03), LZ250(2003-05), S250(1999), SX250(2000-03), VX250(2002-04), VZ250(2003-09), Z250(2003-05), LZ300(2004-06), VZ300(2004-09), Z300(2004-06)</p>	
 <p>18-0712 FLOAT CHAMBER GASKET Replaces: 63P-14984-00 Fits: F150 TLR (2004-10), F150 TXR (2004-10), LF150 TXR (2004-10)</p>	 <p>18-0713 FLOAT CHAMBER GASKET Replaces: 6P2-14984-00 Fits: F225TLR(2007-09), F250(2005-10), LF250(2005-10)</p>	 <p>18-0714 FLOAT CHAMBER GASKET Replaces: 6AW-14984-00 Fits: F300(2007-09), LF300(2007-09), F350(2007-10), LF350(2007-10)</p>	

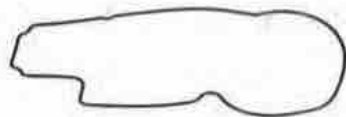

18-0715
FLOAT CHAMBER GASKET

Replaces: 65L-14984-00
Fits: V200(1998), L225(1997-98), S225(1997-98), V225(1998), L250(1997-98), S250(1997-98)

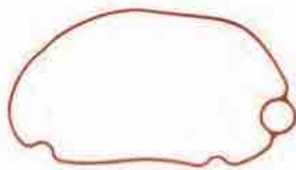

18-0716
FLOAT CHAMBER GASKET, VITON

Replaces: 6CB-14984-00
Fits: F115(2001-14), F200(2011-14), F225(2010-14), F250(2010-14), F300(2010-14), F350(2011-14), FL250(2010), FL300(2010), LF115(2011-14), LF200(2011-14), LF225(2010-14), LF250(2010-14), LF300(2010-14), LF350(2011-14), VF150(2013-14), VF200(2010-14), VF225(2010-14), VF250(2009-14)

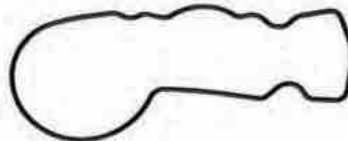

18-0717
FLOAT CHAMBER GASKET, VITON

Replaces: 6CS-14984-00
Fits: F50(2005-14), F60(2005-14), F70(2010-14), F75(2005-14), F90(2005-14), T50(2005-14), T60(2005-14)



18-99146
FLOAT CHAMBER GASKET

Replaces: 677-14384-01
Fits: 9.9(1984-95), 15(1984-95)



18-0707
SEAL, VITON

Replaces: 6CB-13016-00
Fits: F115(2011-14), F175(2014), F200(2011-14), F225(2010-14), F250(2010-14), F300(2010-14), F350(2012-14), FL250(2010), FL300(2010), LF115(2011-14), LF200(2011-14), LF225(2010-14), LF250(2010-14), LF300(2010-14), LF350(2012-14), VF150(2013-14), VF200(2010-14), VF225(2009-14), VF250(2009-14)

H.P.	Year	Carb Kit	Per Engine	Needle Valve Assy	Per Engine	H.P.	Year	Carb Kit	Per Engine	Needle Valve Assy	Per Engine
2	1984-88	16-7293	1			60	2001-02			18-7056	3
3	1988-02	18-7765	1	18-7054	1	C60	1996-01	18-7766	3	18-7056	3
F4	1999-02	18-7736	1			E60	1995-00	18-7766	3	18-7056	3
6	1986-96	18-7765	1	18-7054	1	P60	1991	18-7766	3	18-7056	3
6	1997-00		1	18-7054	1	P60	1992-99			18-7056	3
8	1984-96	18-7766	1	18-7054	1	70	1984-91	18-7786	3	18-7056	3
8	1997-00		1	18-7054	1	70	1992-01			18-7056	3
9.9	1984-85	18-7059	1	18-7079	1	C70	2000-01			18-7056	3
9.9	1986-95	18-7769	1	18-7073	1	C75	1994-97	18-7291	3	18-7060	3
9.9	1996-03	18-7058	1	18-7064	1	C75	1998-99	18-7742	3	18-7060	3
9.9	2004-09	18-7058	1			E75	1995-90	18-7291	3	18-7060	3
F9.9	2006	18-7738	1			P75	1996-99			18-7060	3
T9.9	2005-06	18-7738	1			C80	1997	18-7742	3	18-7060	3
15	1984-85	18-7059	1	18-7079	1	F80	1999-02	18-7743	3	18-7056	3
15	1986-92	18-7769	1	18-7073	1	C85	1991-96	18-7291	3	18-7060	3
15	1993-95		1	18-7073	1	CV85	1989-90	18-7291	3	18-7060	3
15	1996-03	18-7058	1	18-7064	1	90	1984-91	18-7291	3	18-7060	3
15	2004-09	18-7058	1			90	1992-02			18-7060	3
F15	1998-05	18-7738	1			B90	1997-99			18-7060	3
20	1986-97	18-7739	1			C90	1987-01			18-7060	3
25 (2 cyl)	1984-87	18-7770	1			F100	1999-02	18-7743	3	18-7056	3
25 (2 cyl)	1988-09	18-7739	1			115	1986-88, 1992-95	18-7002	2	18-7055	4
F25	1998-03		1	18-7054	1	115	1990-91	18-7744	2	18-7055	4
C25	1991-1997	18-7770	1			115	1992-09		2	18-7055	4
CV25	1990	18-7770	1			B115	1999-99			18-7055	4
T25	2001-03		1	18-7064	1	C115	1991			18-7055	4
30	1984-86	18-7770	1			C115	1992-95	18-7002	2	18-7055	4
30	1987-98		1	18-7055	1	C115	1996-00			18-7055	4
F30	2000-02		1	18-7064	1	P115	1993-96	18-7002	2	18-7055	4
C30	1991-92	18-7770	1			S115	1996-99			18-7055	4
C30	1993-97	18-7737	1	18-7049	1	130	1988, 1992-95	18-7002	2	18-7055	4
CV30	1989-90	18-7770	1			130	1990-91	18-7744	1	18-7055	4
40	1984-88	18-7767	3	18-7056	3	130	1992-04			18-7055	4
40	1989-92	18-7768	3	18-7056	3	L130	1989			18-7055	4
40	1993-05	18-7768	3			L130	1990-91	18-7744	1	18-7055	4
F40	2000-02		1	18-7054	3	L130	1992-95	18-7002	2	18-7055	4
C40	1991-93	18-7740	1	18-7056	2	L130	1996-01			18-7055	4
C40	1994-97	18-7741	1			S130	1996-99			18-7055	4
C40	2002-03	18-7768	3			150	1985-86	18-7747	1	18-7055	6
PA0	1998	18-7768	1			150	1987, 1992-95	18-7002	3	18-7055	6
E48	1995-00	18-7290	2			150	1990-91	18-7759	1	18-7055	6
50	1984-88	18-7767	3	18-7056	3	150	1996-01	18-7756	3	18-7055	6
50	1989-92	18-7768	3	18-7056	3	150	2002-09			18-7055	6
50	1993 & Up	18-7768	3			C150	1996-99	18-7756	3	18-7055	6
C60	1998-01	18-7768	3			D150	1997-99	18-7756	3	18-7055	6
PRO 50	1997-88	18-7767	3			L150	1988, 1992-95	18-7002	3	18-7055	6
PRO 50	1989-90	18-7768	3			L150	1990-91	18-7759	1	18-7055	6
P50	1991-92	18-7768	3	18-7056	3	L150	1996-99	18-7756	3	18-7055	6
P50	1993-96	18-7768	3			Z150					
C55	1991-95	18-7290	2			P150	1991	18-7759	1	18-7055	6
CV55	1989-90	18-7290	2			P150	1992-95	18-7002	3	18-7055	6

① Kit contains enough components to rebuild 2 carburetors

APPLICATION CONTINUED ON NEXT PAGE

HP.	Year	Carb Kit	Per Engine	Needle Valve Assy	Per Engine	HP.	Year	Carb Kit	Per Engine	Needle Valve Assy	Per Engine
P150	1996-99	18-7756	3	18-7055	6	200	1996-99	18-7756	3	18-7055	6
PRO V150	1987	18-7002	3			L200	1988, 1992-95	18-7002	3	18-7055	6
PRO V150	1990	18-7759	1			L200	1990-91	18-7759	1	18-7055	6
S150	1996-99	18-7756	3	18-7055	6	L200	1996-99	18-7756	3	18-7055	6
V150	2000-01	18-7756	3			P200	1991	18-7759	1	18-7055	6
V150	2002-08			18-7055	6	P200	1993-95	18-7002	3	18-7055	6
175	1985-86	18-7747	2			P200	1996-99	18-7756	3	18-7055	6
175	1987, 1992-95	18-7002	3	18-7055	6	S200	1996-99	18-7756	3	18-7055	6
175	1990-91	18-7759	1	18-7055	6	V6 Special	1984-86	18-7747	2		
175	1992-95			18-7055	6	V6 Exotic	1987-89	18-7759	1		
175	2000	18-7756	3	18-7055	6	225	1990-91	18-7759	1	18-7055	6
P175	1994-95	18-7002	3	18-7055	6	225	1992-95	18-7002	3	18-7055	6
P175	1996-99	18-7756	3	18-7055	6	225	1996-97	18-7756	3	18-7055	6
S175	1996-99	18-7756	3	18-7055	6	L225	1994-96	18-7772	6	18-7055	6
V175	2000	18-7756	3			S225	1996	18-7772	6	18-7055	6
200	1985	18-7747	2			250	1990-95	18-7772	6	18-7055	6
200	1986-87, 1992-95	18-7002	3	18-7055	6	L250	1991-96	18-7772	6	18-7055	6
200	1990-91	18-7759	1	18-7055	6	S250	1996	18-7772	6	18-7055	6

* Carb Kit contains enough components to rebuild 2 carburetors

 <p>18-35302 FUEL PUMP ASSEMBLY Replaces: 66M-24410-10-00 Fits: F9.9(2005-06), T9.9(2005-06), F15(1998-06)</p>	 <p>18-7334 FUEL PUMP Replaces: 692-24410-00-00, 663-24410-00-00, 6A0-24410-00-00, 6A0-24410-05-00, 6A0-24410-04-00, 6A0-24410-03-00, 6A0-24410-02-00, 6A0-24410-01-00 For: 2-Stroke 40 HP - 90 HP (1984-2009) Uses Kit 18-7797</p>	 <p>18-7340 FUEL PUMP Replaces: 68V-13907-03-00, 68V-13907-02-00, 68V-13907-01-00, 68V-13907-00-00 Fits: F115(2000-04, 2006-11), LF115(2000-11)</p>	 <p>18-7341 FUEL PUMP Replaces: 66K-13907-00-00 Fits: DX150(1999-01), LX150(1999-01), LX200(1999-01), LX225(2000-01), PX150(1999), SX150(1999-01), SX200(1999-01), SX225(2000-01), SX250(2000-01), V200(1999), V225(1999), VX150(2000-01), VX200(2000-01), VX225(2000-01)</p>
 <p>18-7342 FUEL PUMP Replaces: 68F-13907-00, 68F-13907-01-00, 68F-13907-00-00 Fits: LZ150(2000-05), LZ200(2000-12), VZ150(2000-12), VZ175(2001-12), VZ200(2001-04), Z150(2000-05), Z175(2001-05), Z200(2000-12)</p>	 <p>18-7343 FUEL PUMP Replaces: 60V-13907-00-00 Fits: LZ250(2003-05), LZ300(2004-06), VZ200(2005-09), VZ225(2003-09), VZ250(2003-09), VZ300(2004-09), Z250(2003-05), Z300(2004-06)</p>	 <p>18-7349 FUEL PUMP Replaces: 6E5-24410-03-00, 6E5-24410-10-00, 6E5-24410-04-00, 6E5-24410-02-00, 6E5-24410-01-00, 6E5-24410-00-00 For: 2-Stroke 115 HP - 300 HP (1984-2004) Uses Kit 18-7788</p>	 <p>18-7388 DIAPHRAGM Replaces: 6G1-24411-00-00 Fits: 3(1989-02), 6(1986-00), 8(1984-09), 9.9(1996-09), 15(1996-09)</p>
 <p>18-7389 DIAPHRAGM Replaces: 6E0-24411-00-00 Fits: 4(1984-99), 5(1984-85, 1994-02)</p>	 <p>18-7390 DIAPHRAGM Replaces: 63V-24411-00-00 Fits: 9.9(1996-09), 15(1996-09)</p>	 <p>18-7391 DIAPHRAGM Replaces: 692-24411-00-00 Fits: 40(1995-05), 50(1995-09), 60(2001-05), 70(1995-09), 90(1995-09), B90(1997-99), C25(1996-97), C30(1996-97), C40(1995-03), C50(1998-01), C55(1995), C60(1998-01), C70(2000-01), C75(1995-99), C80(1997), C85(1995-96), C90(1997-01), E48(1995-00), E60(1995-00), E75(1995-00), P40(1998), P50(1995-96), P60(1995-99), P75(1996-99)</p>	 <p>18-7787 FUEL PUMP KIT For: 40-90 HP — CONTAINS — Part # Description O.E.# 18-7840 Diaphragm (Front) 663-24411-00-00 18-7839 Diaphragm 648-24411-00-00</p>
 <p>18-7788 FUEL PUMP KIT Replaces: 6E5-24411-00-00 (V-4, V-6) — CONTAINS — Part # Description O.E.# 18-7843 Gasket (Rear) 6E5-24411-00-00 18-7842 Diaphragm (Top) 6E5-24411-00-00</p>	 <p>18-7367 FUEL PUMP KIT Contains: 18-7833 & 18-7388</p>	 <p>18-7368 FUEL PUMP KIT Contains: 18-7834 & 18-7389</p>	 <p>18-7369 FUEL PUMP KIT Contains: 18-7388 & 18-7390</p>



18-7797
FUEL PUMP KIT
Contains: 18-7839 & 18-7840



18-7798
FUEL PUMP KIT
Contains: 18-7838 & 18-7837



18-7799
FUEL PUMP KIT
Contains: 18-7842 & 18-7843



18-7833
FUEL PUMP DIAPHRAGM
Replaces: 6G1-24471-00-00



18-7834
FUEL PUMP DIAPHRAGM
Replaces: 6E0-24471-00-00



18-7837
FUEL PUMP DIAPHRAGM
Replaces: 677-24411-02-00



18-7838
FUEL PUMP DIAPHRAGM
Replaces: 677-24471-01-00



18-7839
FUEL PUMP DIAPHRAGM
Replaces: 648-24411-00-00



18-7840
FUEL PUMP DIAPHRAGM
Replaces: 663-24411-00-00



18-7841
FUEL PUMP DIAPHRAGM
Replaces: 6J8-24471-00-00



18-7842
FUEL PUMP DIAPHRAGM
Replaces: 6E5-24471-00-00



18-7843
FUEL PUMP DIAPHRAGM
Replaces: 6E5-24411-00-00

Model	Year	Diaphragms	Kits	Model	Year	Diaphragms	Kits	Model	Year	Diaphragms	Kits
3	1988-02	18-7833 / 18-7388	18-7367	E75	1995-00	18-7840		Z175	2001-01	18-7842	
4	1984-99	18-7834 / 18-7389	18-7368	P75	1996-99	18-7840		Z175	2002-04	18-7842 / 18-7843	18-7799
5	1984-85	18-7834 / 18-7389	18-7368	C80	1997	18-7840		200	1984-98	18-7842 / 18-7843	18-7799
5	1986-91	18-7834		R5	1990	18-7798		L200	1986-99	18-7842 / 18-7843	18-7799
5	1994-02	18-7834 / 18-7389	18-7368	C85	1991-94	18-7839 / 18-7840	18-7797	LX200	1999-01	18-7842	
6	1986-00	18-7833 / 18-7388	18-7367	C85	1995-96	18-7840		L2200	2000-01	18-7842	
8	1984-09	18-7833 / 18-7388	18-7367	CV85	1989-90	18-7839 / 18-7840	18-7797	L2200	2002-04	18-7842 / 18-7843	18-7799
9	1984-95	18-7837 / 18-7836	18-7798	90	1984-94	18-7839 / 18-7840	18-7797	P200	1991-99	18-7842 / 18-7843	18-7799
9	1996-09	18-7388 / 18-7390	18-7369	90	1995-09	18-7840		S200	1996-99	18-7842 / 18-7843	18-7799
15	1984-95	18-7837 / 18-7836	18-7798	R90	1997-99	18-7840		SX200	1999-01	18-7842	
15	1996-09	18-7388 / 18-7390	18-7369	C90	1997-01	18-7840		SX200	2002-04	18-7842 / 18-7843	18-7799
20	1986-97	18-7837		I15	1984-04	18-7842 / 18-7843	18-7799	V200	1999	18-7842	
25	1984-87	18-7840		R115	1988-99	18-7842 / 18-7843	18-7799	V200	1998	18-7842 / 18-7843	18-7799
25	1984-87			C115	1991-00	18-7842 / 18-7843	18-7799	VX200	2000-01	18-7842	
25	1988-09	18-7837		P115	1993-96	18-7842 / 18-7843	18-7799	VX200	2002-04	18-7842 / 18-7843	18-7799
C25	1991-95	18-7840	18-7797	S115	1996-99	18-7842 / 18-7843	18-7799	VZ200	2001	18-7842	
C25	1996-97	18-7840		I30	1988-04	18-7842 / 18-7843	18-7799	VZ200	2002-04	18-7842 / 18-7843	18-7799
CV25	1990	18-7839 / 18-7840	18-7797	C150	1996-99	18-7842 / 18-7843	18-7799	Z200	2000-01	18-7842	
25	1990	18-7837		L130	1989-99	18-7842 / 18-7843	18-7799	Z200	2002-04	18-7842 / 18-7843	18-7799
30	1984-86	18-7839 / 18-7840	18-7797	L130	2000-01	18-7842		Z25	1990-97	18-7842 / 18-7843	18-7799
30	1987-90	18-7841		S130	1996-99	18-7842 / 18-7843	18-7799	L225	1994-99	18-7842 / 18-7843	18-7799
30	1991-02	18-7841		I50	1984-04	18-7842 / 18-7843	18-7799	LX225	2000-01	18-7842	
C30	1991-95	18-7839 / 18-7840	18-7797	D150	1997-99	18-7842 / 18-7843	18-7799	LX225	2002-03	18-7842 / 18-7843	18-7799
C30	1996-97	18-7840		L150	1986-99	18-7842 / 18-7843	18-7799	S225	1996-99	18-7842 / 18-7843	18-7799
CV30	1989-90	18-7839 / 18-7840	18-7797	LX150	1999-01	18-7842		SX225	2000-01	18-7842	
40	1984-94	18-7839 / 18-7840	18-7797	LZ150	2000-01	18-7842		SX225	2002-03	18-7842 / 18-7843	18-7799
40	1995-01	18-7840		LZ150	2002-04	18-7842 / 18-7843	18-7799	V225	1999	18-7842	
C40	1991-94	18-7839 / 18-7840	18-7797	DX150	1999-01	18-7842		V225	1998	18-7842 / 18-7843	18-7799
C40	1995-02	18-7840		DX150	2002-04	18-7842 / 18-7843	18-7799	VX225	2000-01	18-7842	
CV40	1990	18-7839 / 18-7840	18-7797	P150	1991-99	18-7842 / 18-7843	18-7799	VX225	2002-04	18-7842 / 18-7843	18-7799
P40	1998	18-7840		S150	1996-99	18-7842 / 18-7843	18-7799	VZ225	2003-04	18-7842 / 18-7843	18-7799
E48	1995-00	18-7840		SX150	1999-01	18-7842		250	1990-95	18-7842 / 18-7843	18-7799
50	1986-94	18-7839 / 18-7840	18-7797	SX150	2002-04	18-7842 / 18-7843	18-7799	L250	1990-99	18-7843	
50	1995-09	18-7840		V150	2000-01	18-7842		LX250	2000-01	18-7842	
C50	1998-01	18-7840		V150	2002-04	18-7842 / 18-7843	18-7799	LX250	2002-03	18-7842 / 18-7843	18-7799
P50	1991-94	18-7839 / 18-7840	18-7797	VX150	2000-01	18-7842		LZ250	2003-04	18-7842 / 18-7843	18-7799
P50	18-1995-96	18-7840		VX150	2002-01	18-7842 / 18-7843	18-7799	S250	1996-99	18-7842 / 18-7843	18-7799
55	1990	18-7798		VZ150	2000-04	18-7842		SX250	2000-01	18-7842	
C55	1991-94	18-7839 / 18-7840	18-7797	VZ150	2002-04	18-7842 / 18-7843	18-7799	SX250	2002-03	18-7842 / 18-7843	18-7799
CV55	1989-90	18-7839 / 18-7840	18-7797	Z150	2000-01	18-7842		VX250	2002-04	18-7842 / 18-7843	18-7799
60	2001-05	18-7840		Z150	2002-04	18-7842 / 18-7843	18-7799	VZ250	2003-04	18-7842 / 18-7843	18-7799
C60	1996-01	18-7840		PRO 150H	1987	18-7798		Z250	2003-04	18-7842 / 18-7843	18-7799
E60	1995-00	18-7840		I75	1984-95	18-7842 / 18-7843	18-7799	LZ300	2004	18-7842 / 18-7843	18-7799
P60	1991-94	18-7839		I75	1996-00	18-7842		VZ300	2004	18-7842 / 18-7843	18-7799
70	1984-94	18-7839 / 18-7840	18-7797	P175	1994-99	18-7842 / 18-7843	18-7799	Z300	2004	18-7842 / 18-7843	18-7799
70	1995-09	18-7840		S175	1996-99	18-7842 / 18-7843	18-7799	V6			
C70	2000-01	18-7840		V175	2000	18-7842		Special	1984-86	18-7842 / 18-7843	18-7799
C75	1994	18-7839 / 18-7840	18-7797	VZ175	2001	18-7842		V6 Excel	1987-89	18-7842 / 18-7843	18-7799
C75	1995-99	18-7840		VZ175	2002-04	18-7842 / 18-7843	18-7799				

- UNIVERSAL DESIGN -
FUEL WATER SEPARATOR BRACKETS



Bracket Type	Part #	Replaces	Bracket Type	Part #	Replaces
1/4" Stainless Steel	18-7777	MAR-FLTHD-SS-12	1/4" Aluminum	18-7853-1	MAR-FLTHD-AL-12
3/8" Stainless Steel	18-7776		3/8" Aluminum	18-7775	

FUEL WATER SEPARATOR KITS



**21 MICRON FILTER KITS
FOR CARBURETED ENGINES**

Kit Type	Part #	Micron Rating	Contents	Replaces
1/4" Aluminum (Short Filter)	18-7848-1	21	1 - 18-7844 filter & 1 18-7853-1 bracket 2 - 18-4256 1/4" pipe plugs	
1/4" Aluminum Bonus Pack Contains spare filter	18-7848-2	21	2 - 18-7844 filter & 1 18-7853-1 bracket 2 - 18-4256 1/4" pipe plugs	
1/4" Aluminum (Tall Filter)	18-7852-1	21	1 - 18-7845 filter & 1 18-7853-1 bracket 2 - 18-4256 1/4" pipe plugs	MAR-SEPAR-AT-OR
1/4" Aluminum Bonus Pack Contains spare filter	18-7852-2	21	2 - 18-7845 filter & 1 18-7853-1 bracket 2 - 18-4256 1/4" pipe plugs	
3/8" Aluminum (Tall Filter)	18-7775-1	21	1 - 18-7845 filter & 1 18-7775 bracket 2 - 18-4264 3/8" pipe plugs	
1/4" Stainless Steel (Tall Filter)	18-7777-1	21	1 - 18-7845 filter & 1 18-7777 bracket 2 - 18-4256 1/4" pipe plugs	ABB-SPRTR-HD-SS
3/8" Stainless Steel (Tall Filter)	18-7776-1	21	1 - 18-7845 filter & 1 18-7776 bracket 2 - 18-4264 3/8" pipe plugs	



**10 MICRON FILTER KITS
FOR FUEL INJECTED ENGINES**

Kit Type	Part #	Micron Rating	Contents	Replaces
1/4" Aluminum (Short Filter)	18-7983-1	10	1 - 18-7944 filter & 1 18-7853-1 bracket 2 - 18-4256 1/4" pipe plugs	
1/4" Aluminum Bonus Pack Contains spare filter	18-7983-2	10	2 - 18-7944 filter & 1 18-7853-1 bracket 2 - 18-4256 1/4" pipe plugs	
1/4" Aluminum (Tall Filter)	18-7982-1	10	1 - 18-7945 filter & 1 18-7853-1 bracket 2 - 18-4256 1/4" pipe plugs	
1/4" Aluminum Bonus Pack Contains spare filter	18-7982-2	10	2 - 18-7945 filter & 1 18-7853-1 bracket 2 - 18-4256 1/4" pipe plugs	
1/4" Aluminum (High Capacity Filter)	18-7966-1	10	1 - 18-7866 filter & 1 18-7853-1 bracket 2 - 18-4256 1/4" pipe plugs	MAR-SEPAR-AT-OR
3/8" Aluminum (Tall Filter)	18-7986-1	10	1 - 18-7945 filter & 1 18-7775 bracket 2 - 18-4264 3/8" pipe plugs	
1/4" Stainless Steel (Tall Filter)	18-7984-1	10	1 - 18-7945 filter & 1 18-7777 bracket 2 - 18-4256 1/4" pipe plugs	MAR-SPRTR-HD-SS
3/8" Stainless Steel (Tall Filter)	18-7985-1	10	1 - 18-7945 filter & 1 18-7776 bracket 2 - 18-4264 3/8" pipe plugs	

* Display Packaged



10 MICRON FILTER KITS WITH DRAIN BOWLS

Sierra AquaVue™ and metal bowl separator filters allow water to be drained from the filter to extend service life. Use the AquaVue™ bowl for outboard, above deck installations. USCG regulations require the use of the flame resistant metal bowl below deck.

• Display Packaged

Kit Type	Part #	Micron Rating	Contents
1/4" Aluminum w/ AquaVue™ bowl	18-7932-1 •	10	1 - 18-7919 filter & 1 18-7853-1 bracket 1 - 18-7922-1 AquaVue™ bowl 2 - 18-4256 1/4" pipe plugs
1/4" Aluminum w/ metal drain bowl	18-7951 •	10	1 - 18-7919 filter & 1 18-7853-1 bracket 1 - 18-7924 metal bowl 2 - 18-4256 1/4" pipe plugs
1/4" Stainless Steel w/ AquaVue™ bowl	18-7937-1 •	10	1 - 18-7919 filter & 1 18-7777 bracket 1 - 18-7922-1 AquaVue™ bowl 2 - 18-4256 1/4" pipe plugs
1/4" Stainless Steel w/ metal drain bowl	18-7938 •	10	1 - 18-7919 filter & 1 18-7777 bracket 1 - 18-7924 metal bowl 2 - 18-4256 1/4" pipe plugs

COMPACT BRACKET AND SEPARATOR KIT - FOR SMALL OUTBOARDS AND FRESH WATER APPLICATIONS

18-7774
COMPACT ALUMINUM BRACKET



18-7965-1
10 MICRON COMPACT SEPARATOR KIT
Replaces: MAR-MINIF-LT-AS
Contains:
1 - 18-7774 bracket
1 - 18-7865 filter



REPLACEMENT FILTERS



UNIVERSAL DESIGN - DIRECT REPLACEMENT FOR MERCURY AND YAMAHA



10 MICRON REPLACEMENT FILTERS AND KITS WITH DRAIN BOWLS

• Display Packaged

10 MICRON REPLACEMENT FILTERS

Part #	Description	Replaces
18-7944	Short - 3.875"	
18-7945	Long - 4.35"	ABB-FUELF-IL-TR
18-7866	High Capacity - 6'	MAR-FUELF-IL-TR
18-7865	Compact 10 Micron	MAR-MINIF-IL-TR

21 MICRON REPLACEMENT FILTERS

Part #	Description	Replaces
18-7844	Short - 3.875"	
18-7845	Long - 4.35"	ABB-FUELF-IL-TR

REPLACEMENT FILTERS

Part #	Description	Replaces
18-7919	Spin on replacement	MAR-24563-00-00 Racor S3213
18-7920	Spin on replacement	Racor S3214
18-7947	Spin on replacement • Fits - 120RRAC01	Racor S3240
18-7948	Spin on replacement • Fits - 320RRAC01	Racor S3227
18-7949	Spin on replacement • Fits - 660RRAC02	Racor S3232

REPLACEMENT FILTERS

Part #	Description	Replaces
18-7922-1	AquaVue™ Collection Bowl	
18-7924	Metal Collection Bowl	MAR-10171-00-10

FILTER & BOWL KITS

Part #	Description
18-7928-1 •	Filter & AquaVue™ Bowl • Mercury/Yamaha Style Contains: 18-7919 filter, 18-7922-1 bowl
18-7929 •	Filter & Metal Bowl • Mercury/Yamaha Style Contains: 18-7919 filter, 18-7924 bowl

18-8953
FUEL WATER SEPARATOR COVER
Fits: Yamaha mini-10 size filter



18-8954
FUEL WATER SEPARATOR COVER
Fits: Yamaha 18-7866 sized filter



 <p>18-7486 O-RING, FUEL FILTER BOWL Replaces: 61A-24564-00-00 File: V6</p>	 <p>18-7487 O-RING, FUEL FILTER ELEMENT Replaces: 65L-24564-00-00 File: V6</p>	 <p>18-7488 GASKET, FUEL FILTER BOWL Replaces: 6P3-24564-00-00 Fits: FILF 150 - F300 (2006 - Current), VZ150 - VZ300 (2006 - Current), Z200 - Z300 (2006 - Current)</p>	 <p>18-7710-1 FUEL FILTER Replaces: 68T-24251-00-00 Fits: FB, F8 (2001 & Up)</p>									
 <p>18-7713 FUEL FILTER (INLINE) Replaces: 646-24251-02-00 Fits: 6 (1989, 1992-99), 8 (1989-99, 2001-02), F4 (1999-02), F9.9 (1989-95, 1997-99, 2001-02), FT 9.9 (1988-90)</p>	 <p>18-7780 FUEL FILTER Replaces: 6F5-24563-00-00 For: 9.9 - 225NR</p>	 <p>18-7781 FUEL FILTER Replaces: 61N-24563-00-00 For: 9.9/90° SX</p>	 <p>18-7782 FUEL FILTER Replaces: 61A-24563-00-00 For: V6, 3.1L, D-T</p>									
 <p>FUEL FILTERS</p> <table border="1"> <thead> <tr> <th>Part #</th> <th>Application:</th> </tr> </thead> <tbody> <tr> <td>18-7828-1</td> <td>1/4" Small Capacity (For 1/4" Fuel Line)</td> </tr> <tr> <td>18-7829</td> <td>1/4" Large Capacity (For 1/4" Fuel Line)</td> </tr> <tr> <td>18-7830</td> <td>3/16" Replaces: 65W-24251-10-00</td> </tr> <tr> <td>18-7831</td> <td>3/8"</td> </tr> </tbody> </table>	Part #	Application:	18-7828-1	1/4" Small Capacity (For 1/4" Fuel Line)	18-7829	1/4" Large Capacity (For 1/4" Fuel Line)	18-7830	3/16" Replaces: 65W-24251-10-00	18-7831	3/8"	 <p>18-7516 FUEL FILTER Replaces: 67F-24251-02-00 For: F100 (1999-01)</p>	 <p>18-7517 FUEL FILTER Replaces: 65L-24563-00-00 For: 150-250 (1997-05)</p>
Part #	Application:											
18-7828-1	1/4" Small Capacity (For 1/4" Fuel Line)											
18-7829	1/4" Large Capacity (For 1/4" Fuel Line)											
18-7830	3/16" Replaces: 65W-24251-10-00											
18-7831	3/8"											
 <p>18-7955 10 MICRON FUEL FILTER ELEMENT Replaces: 68F-24563-10-00 Fits: 150hp - 300hp. (2004-2006) Models Z, VZ, LZ</p>	 <p>18-7979 FUEL FILTER Replaces: 68V-24563-00-00</p>	 <p>18-79799 FUEL FILTER Replaces: 6D8-WS24A-00-00 F50-F115 after April 2006 For filter housing marked "6D8" ONLY!</p>	 <p>18-79809 FUEL FILTER Replaces: 6P3-24563-01-00, 6P3-WS24A-00-00, 6P3-WS24A-01-00 F150, F200, F225, F250, Z-VZ 150 to 300 hp. after April 2006 For filter housing marked "6P3" ONLY!</p>									
 <p>18-79905 10 MICRON FUEL FILTER Replaces: 69J-24501-10-00 Fits: F150 - F225 (2006 - Current), F250 - (2005 - Current)</p>	 <p>18-79970 FUEL FILTER Replaces: 68G-13915-00 Fits: F30(2013), F40(2008-13), F50(2005-13), F60(2005-13), F70(2010-13), F75(2005-13), F90(2005-13), T50(2005-13), T60(2005-13)</p>	 <p>18-79972 ELEMENT, FILTER (CARB INLET) Replaces: 67F-14371-01 Fits: F75(2003-04), F80(2002-03), F90(2003-04), F100(2002-03)</p>	 <p>18-79973 FUEL FILTER Replaces: 6C5-13915-00 Fits: F50(2005-13), F60(2005-13), F70(2010-13), F75(2005-13), F90(2005- 13), T50(2005-13), T60(2005-13)</p>									



18-79977
FUEL FILTER

Replaces: 6L5-24251-00
Fits: 3(1992-02), F2.5(2003-12), F4(1999-08)



18-79979
FUEL FILTER

Replaces: 6CB-24501-00
F225 4.2L (2010), F250 4.2L (2010), F300 4.2L (2010), LF225 4.2L (2010), LF250 4.2L (2010), LF300 4.2L (2010), VF200 4.2L (2009-10), VF225 4.2L (2009-10), VF250 4.2L (2009-10)



18-79980
FUEL FILTER

REPLACES: 68F-24563-00
Fits: LZ150(2000-04), LZ200(2000-04), LZ250(2003-04), VZ150(2000-04), VZ175(2001-04), VZ200(2001-04), VZ225(2003-04), VZ250(2003-04), Z150(2000-04), Z175(2001-04), Z200(2000-04), Z250(2003-04)



18-79981
FUEL FILTER

Replaces: 69J-24501-00
Fits: F150(2004-05), F200(2002-05), F225(2002-05), LF150(2004-05), LF200(2002-05), F225(2002-05)



18-79982
FUEL FILTER

Replaces: 69J-24502-00
Fits: F150(2005-14), F200(2005-10), F225(2005-10), F75(2005-14), F90(2005-14), FL150(2010), LF150(2005-14), LF200(2005-10), LF225(2005-10)



18-79983
FUEL FILTER

Replaces: 6C5-24251-00
Fits: F115(2014-15), F30(2013-15), F40(2008-15), F50(2005-15), F60(2005-15), F70(2010-15), F75(2005-15), F90(2005-15), LF115(2014-15), T50(2005-15), T60(2005-11), VF115(2015)



18-79984
FUEL FILTER

Replaces: 6AW-24502-10, 6AW-24502-00-00
Fits: 2007-09, F350(2007-11), FL350(2010), LF300(2007-09), LF350(2007-11)



18-79985
FUEL FILTER

Replaces: 68V-24502-30, 68V-24502-20-00
Fits: F115(2010-11), LF115(2010-11)



18-79986
FUEL FILTER

Replaces: 68V-24502-02, 68V-24502-01-00
68V-24502-00-00
Fits: F115(2005-09), LF115(2005-09)



18-79907
VST FILTER

Replaces: 60V-24251-01-00
Fits: LZ150(2005), VZ150(2005-10), Z150(2005), VZ175(2005-10), Z175(2005), LZ200(2005-10), VZ200(2005-09), Z200(2005-10), VZ225(2005-09), LZ225(2005), VZ225(2005-09), Z225(2005), LZ300(2005-06), VZ300(2005-09), Z300(2005-08)



18-79900
VST FILTER (TAN)

Replaces: 66K-13915-00-00
Fits: DX150 (1999-05), LX150 1999-01, PX150 (1999), SX150 (1999-04), VX150 (2000-04), LX200 (1999-01), SX200 (1999-05), V200 (1999), VX200 (2000-05), L225 (1999), LX225 (2000-03), S225 (1999), SX225 (2000-03), V225 (1999), VX225 (2000-04), L250 (1999), LX250 (2000-03), SX250 (2000-03), VX250 (2002-04)



18-79901
VST FILTER (BLUE)

Replaces: 65L-13915-00-00
Fits: L225 (1997-98), S225 (1997-98), L250 (1997-98), V200 (1998), V225 (1998)



**18-79902
VST FILTER**
Replaces:
63P-13915-00-00
Fits: F150 TXR(2004-09), F150 TLR(2004-09), F150 TJR(2009), LF150 TXR(2004-09), F250 TXR(2005-09), F250 TUR(2005-09), F300 TXR(2007-09), F300 TUR(2007-09), F350 TXR(2007-09), F350 TUR(2007-09), F225TLR (2007-09)



**18-79903
VST FILTER**
Replaces:
68V-13915-00-00
Fits: F115 (2000-09), F200 TXR(2002-09), LF200 TXR(2002-09), F225 TXR(2002-09), F225 TUR(2002-09)



**18-79904
VST FILTER (YELLOW)**
Replaces:
68F-13915-00-00
Fits: HPDI 150(2000-05), V-Max HPDI 150(2000-09), V-Max HPDI 175(2001-09), HPDI 200(2000-09), HPDI 225(2003-09), HPDI 250 (2003-09), HPDI 300(2004-09)



**18-79978
VST FILTER**
Replaces: 6CB-13915-00
Fits: F225 4.2L (2010), F250 4.2L (2010), F300 4.2L (2010), LF225 4.2L (2010), LF250 4.2L (2010), LF300 4.2L (2010), VF200 4.2L (2009-10), VF225 4.2L (2009-10), VF250 4.2L (2009-10)



**18-79910
FUEL FILTER ASSEMBLY**
Replaces: 61N-24560-00, 61N-24560-10
Fits: 15(1994-09), 20(1996-97), 25(1994-09), 30(1995-01), 40(1994-05), 50(1994-09), 60(2001-05), 70(1994-09), 9.9(1994-09), 90(1994-09), B90(1997-99), C25(1994-97), C30(1994-97), C40(1994-03), C50(1998-01), C55(1994-95), C60(1996-01), C75(1994-99), C80(1997), C85(1994-96), C90(1997-01), E48(1995-00), E60(1995-00), E75(1995-00), F15(2005-10), F20(2006-10), F25(2005, 2009-10), F40(1999), F50(1995-04), F9.9(2005-06)



**18-79950
VST KITS**
Replaces: Kit 1
Fits: F150(04-12), LF150(04-12)

- CONTAINS -		
Part #	Description	O.E.#
18-79902	VST Filter	63P-13915-00-00
18-79905	Fuel Filter, 10 Micron	68J-04501-10-00
18-0712	Float Chamber Gasket	63P-14984-00-00



**18-79951
VST KITS**
Replaces: Kit 2
Fits: F115(00-11), F200(02-10), F225(02-06), F225TXR(07-10), LF115(00-11), LF200(02-10), LF225(02-06), LF225 TXR(07-10)

- CONTAINS -		
Part #	Description	O.E.#
18-79903	VST Filter	68V-13915-00-00
18-0710	Float Chamber Gasket	68V-14984-00-00



**18-79952
VST KITS**
Replaces: Kit 3
Fits: DX150(99-05), L225(99), L250(99), LX150(99-01), LX200(99-01), LX225(00-03), LX250(00-03), FX150(99), S225(99), S250(99), SX150(99-04), SX200(00-05), SX225(00-03), SX250(00-03), V200(99), V225(99), VX150(00-04), VX200(00-05), VX225(00-04), VX250(02-04)

- CONTAINS -		
Part #	Description	O.E.#
18-79900	VST Filter	66K-13915-00-00
18-0711	Float Chamber Gasket	66K-14984-00-00



**18-79953
VST KITS**
Replaces: Kit 4
Fits: LZ150(00-05), LZ200(00-11), LZ250(03-05), LZ300(04-06), VZ150(00-11), VZ175(01-11), VZ200(01-09), VZ225(03-09), VZ250(03-09), VZ300(04-09), Z150(00-05), Z175(01-05), Z200(00-11), Z250(03-05), Z300(04-06)

- CONTAINS -		
Part #	Description	O.E.#
18-79904	VST Filter	68F-13915-00-00
18-0711	Float Chamber Gasket	66K-14984-00-00



**18-79954
VST FILTER & GASKET KIT**
Fits: F225TLR (2007-2009), F250 (2005-2010), LF250 (2005-2010)

- CONTAINS -		
Part #	Description	O.E.#
18-79902	VST Filter	63P-13915-00-00
18-0713	Float Chamber Gasket	6P2-14984-00-00



**18-79955
VST FILTER & GASKET KIT**
Fits: F300 (2007-2009), LF300 (2007-2009), F350 (2007-2010), LF350 (2007-2010)

- CONTAINS -		
Part #	Description	O.E.#
18-79902	VST Filter	63P-13915-00-00
18-0714	Float Chamber Gasket	6AW-14984-00-00



**18-79956
VST FILTER & GASKET KIT**
Fits: F115 (2001-2014), F200 (2011-2014), F250 (2010-2014), F300 (2010-2014), F350 (2011-2014), FL250 (2010), FL300 (2010), LF115 (2011-2014), LF200 (2011-2014), LF225 (2010-2014), LF250 (2010-2014), LF300 (2010-2014), LF350 (2011-2014), VF150 (2013-2014), VF200 (2010-2014), VF225 (2010-2014), VF250 (2009-2014)

- CONTAINS -		
Part #	Description	O.E.#
18-79902	VST Filter	63P-13915-00-00
18-0716	Float Chamber Gasket, Viton	6CB-14984-00-00



**18-79957
VST FILTER & GASKET KIT**
Fits: F50 (2005-2014), F60 (2005-2014), F70 (2010-2014), F75 (2005-2014), F90 (2005-2014), T50 (2005-2014), T60 (2005-2014)

- CONTAINS -		
Part #	Description	O.E.#
18-79973	Fuel Filter	6C5-13915-00-00
18-0717	Float Chamber Gasket, Viton	6C5-14984-00-00



**18-2083
FUEL INJECTOR SEAL**
Replaces:
68V-13766-00-00



18-7655
OXYGEN SENSOR
 Replaces: 67H-8592A-01-00,
 67H-8592A-00-00
 Fits: PX150 (1999), DX150 (99-05),
 LX150, LX200 (99-01), VX150 (00-04)



18-7656
OXYGEN SENSOR
 Replaces: 68F-8592A-00-00
 Fits: L225, L250 (99-99), LX225, LX250 (00-03), LZ150
 (00-05), LZ200 (00-12), S225, S250 (97-99), SX150 (99-
 04), SX200 (99-05), SX225, SX250 (00-03), V200, V225
 (99-99), VX200 (00-05), VX225 (99-05), VX250 (02-04),
 VZ150 (00-14), VZ175 (01-12), VZ200 (01-04), Z150
 (00-05), Z175 (01-05), Z200 (00-12)



18-7606
WATER SENSOR PROBE
 Replaces: MAR-10171-30-00

8' LENGTH COMPLETE FUEL LINE ASSEMBLIES

3/8"
FUEL LINE ASSEMBLY

18-8017EP-2 SILVERADO 4000 Premium

OE# 6YL-24306-60-00



18-8077-1
TANK CONNECTOR
 (SOLD SEPARATELY)



18-8076
FUEL CONNECTOR

18-8005EP-1
PRIMER BULB

18-8076
FUEL CONNECTOR



*

*

FUEL LINE ASSEMBLY COMPONENTS
 Fits: F75-F250 and 115-300 HP



3/8"
FUEL LINE ASSEMBLY

18-8017S-1 SILVERADO 4000 Premium

OE# 6YL-24306-60-00



18-8077-1
TANK CONNECTOR
 (SOLD SEPARATELY)



18-8076
FUEL CONNECTOR

18-8005S
PRIMER BULB

18-8076
FUEL CONNECTOR



*

*

FUEL LINE ASSEMBLY COMPONENTS
 Fits: F75-F250 and 115-300 HP



PRIMER BULBS



18-8002EP-1
18-8002EP-1-10
PRIMER BULB
 1/4"

18-8005EP-1
18-8005EP-1-10
PRIMER BULB
 3/4"

18-8004EP-1
18-8004EP-1-10
PRIMER BULB
 9/16"

Replaces: 174512
 Large capacity bulb

Large capacity bulb



18-8040
FUEL TANK ELBOW
 Universal Fitting with
 1/4" NPT Threads
 Replaces: ABA-FBARB-90-DG
 (Brass)



18-8055
HOSE BARB
 1/4" NPT threads for connection of 5/16" I.D.
 hose
 Replaces: ABA-FLINE-BA-RB
 (Brass)



18-8077-1
18-8077-1-10
TANK CONNECTOR
 (1/4" NPT)
 Fits: F75-F250 and 115-300HP
 Mates with 18-80413, 18-80414, 18-80415





18-80413
FUEL CONNECTOR
1/4"
Replaces: 6Y1-24305-06-00, 6Y1-24305-04
Mates with 18-8077-1



18-80414
FUEL CONNECTOR
Replaces: 6G1-24305-05-00, 6G1-24305-04
Fits: 6(1989, 1992-93), 8(1984-85, 1989-93, 2001-02), 9,9(1984-93, 2000-03), 15(1984-93, 2000-03), 25(1984-85, 1989-93, 2000-03), 30(1984-87, 1989-93, 1999, 2001-02), 40(1984-86, 1989-90, 1992-93, 2000-03), 50(1986-93, 2000-03), 60(2001-03), 70(1984-93, 2000-03), 90(1984-93, 2000-03), C25(1991, 1993), C30(1991-93), C40(1991-93, 2000-02), C50(2000-01), C55(1991-93), C80(2000-01), C70(2000-01), C85(1991-93), C90(2000-01), E48(2000), F6(2001-03), F8(2001-03), F9.9(1985-93, 2001-03), F15(1998-99, 2000-01), F25(1998-99, 2000-03), F30(2001-03), F40(1999, 2000-03), F50(1999, 2000-03), F60(2002-03), T8(2001-03), T9.9(1991-93, 1999, 2001-03), T25(2001-03), T50(1999, 2000-03), T60(2003)
Use with Yamaha 6mm fuel line
Mates with 18-8077-1



18-80415
FUEL CONNECTOR
Replaces: 6E5-24305-05, 6Y2-24305-05
Use with Yamaha 6mm fuel line
Mates with 18-8077-1

18-9145
OETIKER CLAMP KIT
Replaces: YB-6AW04-A

Part #	Qty.	Yamaha #	Oetiker #	Description	
18-9141	1	YB-6AW04-4	14100082	Oetiker Jaw Pincers	
Part #	Qty.	Yamaha #	Oetiker #	Nominal ID	
				Inches	mm
18-9133-9	50	YB-6AW04-1	16700016	5/8"	15.7
18-9146-9	50	YB-6AW04-3	16702498	25/32"	19.8

All clamps are standard package of 10. Each Package of 10 is available individually.

* Tanks and Engines for picture purpose only.

① Discount shop pack of 10 - Priced per package

 <p>18-3040 IMPELLER Replaces: 63V-44352-01-00</p>	 <p>18-3042 IMPELLER Replaces: 67F-44352-00-00</p>	 <p>18-3063 IMPELLER Replaces: 662-44352-01-00</p>	 <p>18-3065 IMPELLER Replaces: 6L2-44352-00-00</p>
--	--	---	--

 <p>18-3066 IMPELLER Replaces: 6G1-44352-00-00</p>	 <p>18-3067 IMPELLER Replaces: 689-44352-02-00</p>	 <p>18-3068 IMPELLER Replaces: 6H4-44352-02-00</p>	 <p>18-3069 IMPELLER Replaces: 6H3-44352-00-00</p>	 <p>18-3070 IMPELLER Replaces: 688-44352-03-00</p>
--	--	--	---	--

 <p>18-3071 IMPELLER Replaces: 6E5-44352-01-00</p>	 <p>18-3072 IMPELLER Replaces: 646-44352-01-00</p>	 <p>18-3073 IMPELLER Replaces: 6E0-44352-00-00</p>	 <p>18-3074 IMPELLER Replaces: 682-44352-01-00</p>	 <p>18-3088 IMPELLER Replaces: 6F5-44352-00-00</p>
--	--	--	---	--



18-45617-1
IMPELLER
Replaces: 6CE-44352-00-00
Fits: F225-F350, FL250-FL350 & VF250 Engines



18-8910
IMPELLER
Replaces: 68T-44352-00-00



18-8911
IMPELLER
Replaces: 6L5-44352-00-00



18-8925
IMPELLER
Replaces: 6AW-44352-00-00



18-3185
WATER PUMP HOUSING
Replaces: 61N-44311-01-00,
61N-44311-00-00



18-43263
WATER PUMP HOUSING
Replaces: 68D-G4311-01-00



18-3170
WATER PUMP HOUSING
Replaces: 6E5-44311-00-00



18-3173-1
WATER PUMP HOUSING
Replaces: 61A-44311-00-00,
61A-44311-01-00



18-3171
WATER PUMP HOUSING
Replaces: 688-44311-01-00



18-3356
WATER PUMP HOUSING
Includes Impeller Cup
Replaces: 63V-44301-00-00
Fits: Two-Stroke: 9.9hp-15hp (1996-Current), Four-Stroke:
6hp-8hp (2001-Current), 9.9hp. (2006-Current), 15hp
(1998-Current)



18-3482
WATER PUMP HOUSING
Replaces: 6CE-44311-01-00



18-3486
WATER PUMP HOUSING
Replaces: 6L2-44311-01-00
Fits: F25C (2016-17)



18-3483
WATER PUMP HOUSING
Replaces: 6AW-44311-01-00
Fits: F300, LF300 (2007-09), F350A, LF350A (2010-11),
F350B, LF350B (2012-15), F350C, LF350C (2016-18), FL350
(2010)



18-3484
WATER PUMP HOUSING
Replaces: 6AW-44311-01-00
Fits: F15C, F20 (2006-17)



18-3485
WATER PUMP HOUSING
Replaces: 6CJ-44311-00-00
Fits: F70A (2010-17)



18-4567
WATER PUMP HOUSING
Replaces: 6AH-44311-00
Fits: F4 (2009-17), F6 (2009-17)



18-9081
WATER PUMP HOUSING COVER
Replaces: 6E5-44312-00-00
Fits: 75 (2017), 90 (2016-2017), 115 (1984-2017), 130 (1988-2004), 150-250 (1984-2017), 250 (1990-2017), 300 (2004-2009)



18-9082
WATER PUMP HOUSING COVER
Replaces: 6AW-44312-00-00
Fits: F225 (2010-15), F250 (2010), F250 (2010-15), F300 (2007-15), F350 (2007-15), FL250 (2010), FL300 (2010), FL350 (2010), LF225 (2010-15), LF250 (2010-15), LF300 (2007-15), LF350 (2007-15), VF250 (2015)

PKG. OF 2



18-43716
IMPELLER PIN
Replaces: 93604-18080-00
Fits: 3 (1988-02), 4 (1984-99), 5 (1984-01), F2.5 (2003-14), F4 (1999-14), F6 (2009-14)

IMPELLER KEYS

Part No.	OE No.
18-3297	90280-03M03-00
18-3305	90280-03024-00, 90280-03003-00
18-3300	90280-04M00-00
18-3301	90280-04M04-00
18-3302	90280-04M05-00



BOLTS



Part No.	OE No.	Application
18-0256	97095-08045-00 97080-08045-00	8-1.25 x 45mm F6 (2001-05), F8 (2001-05) M8-1.25x45mm 18-8S/S
18-2605	90119-08M87-00	F80 (1999-03), F90 (2003-04), F100 (1999-02) M8-1.25x75mm 18-8 S/S
18-2606	90119-08M13-00	F80 (1999-03), F90 (2003-04), F100 (1999-02) M8-1.25x50mm 18-8 S/S
18-2607	97095-06040-00	For: 3HP (1988-99, 2002) M8-1.0x40mm 18-8 S/S
18-8400-9 ^① Ⓢ	90119-08M15-00	8-1.25 x 29mm

18-9079
WAVE WASHER KIT
Replaces: 61A-45538-00-00 + 61A-45527-00-00 + 90206-22M19 + 90201-22M01
Fits: Yamaha 2-stroke 115-300hp (1993 & Up); Yamaha 4-stroke 115-225hp (2002 & Up); Mercury 4-stroke 225 EFI S/N 0T653945 & Up



— CONTAINS —

Part #	Desc.	O.E.#	Qty.
18-9075	Spacer	61A-45538-00-00	1
18-9076	Collar	61A-45527-00-00	1
18-9077	Wave Washer	90206-22M19-00	1
18-9078	Stainless Steel Washer	90201-22M01-00	2



18-1828
WATER DAMPER SEAL
Replaces: 663-44366-00
Fits: F30 (2013-17), F40A (2008-17)



18-1836
WATER DAMPER SEAL
Replaces: 6L2-44367-00
Fits: F15C, F20 (2006-17)



18-1837
WATER DAMPER SEAL
Replaces: 6L2-44367-00
Fits: F25C (2016-17)



18-1840
WATER DAMPER SEAL
Replaces: 6EE-G4366-00
Fits: F2.5 (2015-17)



18-1829
WATER SEAL DAMPER
Replaces: 6AW-44365-00-00
Fits: F225 (2010-15), F250 (2010), F250 (2010-15), F300 (2007-15), F350 (2007-15), FL250 (2010), FL300 (2010), FL350 (2010), LF225 (2010-15), LF250 (2010-15), LF300 (2007-15), LF350 (2007-15), VF250 (2015)

① Priced per Package ② PKG. of 4

APPLICATION BEGINS ON PAGE 523

**18-1830
WATER SEAL DAMPER**

Replaces: 663-44366-00

Fits: 25 ML, MS(1997-02), 30(1987-01), 40(1984-05), 50(1986-09), 60(2001-05), 70(1984-09), 90(1984-09), B90(1997-99), C30(1995), C40(1991-01), C50(1998-01), C55(1991-95), C60(1996-01), C70(2000-01), C75(1994-99), C80(1997), C85(1991-96), C90(1997-01), E48(1995-00), E60(1995-00), E75(1995-00), F30(2001-05, 2013), F40(1999-13), F50(1995-13), F60(2002-13), F70(2010-13), F75(2003-11), F80(1999-03), F90(2003-13), F100(1999-03), F200(2002-12), F225(2002-12), F250(2005-12), L225(1994-99), L250(1990-99), LF200(2002-12), LF225(2002-10), LF250(2005-12), LX225(2000-03), LX250(2000-03), LZ250(2003-05), LZ300(2004-06), P40(1998), P50(1991-96), P60(1991-99), P75(1996-99), S225(1996-99), S250(1996-99), SX225(2000-03), SX250(2000-03), T25(2001-13), T50(1996-13), T60(2003-13), V200(1998-99), V225(1998-99), VX200(2000-05), VX225(2000-04), VX250(2002-04), VZ200(2005-09), VZ225(2005-09), VZ250(2003-09), VZ300(2004-09), Z250(2003-05), Z300(2004-06)



**18-1831
WATER SEAL DAMPER**

Replaces: 682-44366-00
Fits: 9.9(1984-95), 15(1984-95)



**18-1832
WATER SEAL DAMPER**

Replaces: 682-44367-00
Fits: 9.9(1984-95), 15(1984-95)



**18-1833
WATER SEAL DAMPER**

Replaces: 647-44366-00
Fits: 6(1986-00), 8(1984-00), 9.9(1996-09), 15(1996-09), F9.9(2005-06), F15(1998-06), T9.9(2005-06)



**18-1834
WATER SEAL DAMPER**

Replaces: 682-44365-00
Fits: 6(1986-00), 6(1984-00), 9.9(1996-09), 15(1996-09), F9.9(2005-06), F15(1998-06), T9.9(2005-06)



**18-1835
WATER SEAL DAMPER**

Replaces: 6E5-44365-00-00
Fits: 75(2017), 90(2016-2017), 115(1984-2017), 130(1988-2004), 150-250(1984-2017), 250(1990-2017), 300(2004-2009)



**18-3505
WATER SEAL DAMPER**

Replaces: 63V-44365-10-00
Fits: 2-Stroke: 9.9hp & 15hp 1997-Current
4-Stroke: F6 & F/T8 2001-Current; F/T 9.9 2005-Current; F15 1998-Current



**18-3166
WATER SEAL DAMPER**

Replaces: 6E0-44366-00-00
For: 2(1984-85, 88-99, 2002), 3(1988-99, 02), 4(1984-85, 88-99), 5(1984-85, 95-02), F2.5(2003-05)



**18-3176
WATER SEAL DAMPER**

Replaces: 68T-44366-00-00
For: F6, F8(2001-05), C30(1993-97)



**18-3148
WATER PUMP KIT**

Without Housing
Replaces: 682-W0078-A1-00

— CONTAINS —

Part #	Desc.	O.E.#	Qty.
18-0768	Gasket, Water Pump	682-44315-A0-00	2
18-2697	Bolt	97095-08045-00	4
18-3074	Impeller	682-44352-01-00	1
18-3297	Key, Impeller	90280-03024-00	1
NSS	Grommet	682-44365-00-00	1
NSS	Cup, Insert	682-44322-00-00	1
NSS	Plate, Wear	682-44323-00-00	1



**18-3411
WATER PUMP KIT W/HOUSING**

Replaces: 682-W0078-A1, 682-44300-01
For: 9.9(1984-95), 15(1984-95), F9.9(1985-96), FT9.9(1985-90), T9.9(1991-96)

— CONTAINS —

Part #	Desc.	O.E.#	Qty.
18-0768	Gasket, Water Pump	682-44315-A0-00	2
18-2697	Bolt	97095-08045-00	4
18-3074	Impeller	682-44352-01-00	1
18-3297	Key, Impeller	90280-03024-00	1
NSS	Seal, Water	682-44365-00-00	1
NSS	Cup, Insert	682-44322-00-00	1
NSS	Plate, Wear	682-44323-00-00	1
NSS	Housing, Water Pump	682-44300-01-00	1



**18-3310
WATER PUMP KIT**

Without Housing
Replaces: 6G5-W0078-01-00

— CONTAINS —

Part #	Description	O.E.#	Qty.
18-0244	Gasket, Water Pump	6E5-44315-00-00	1
18-0256	Bolt	97395-08045-00-00	4
18-3071	Impeller	6E5-44352-00-00	1
18-3302	Key, Impeller	90280-04M05-00	1
18-3345	Plate, Wear	6G5-44323-00-00	1
18-7483	O-Ring, Water Pump	93210-37M67-00	1
18-7485	O-Ring, Water Pump	93210-86M38-00	1
NSS	Cup, Insert	6E5-44322-00-00	1
NSS	Washers, Bolt	90209-08M02-00	4



**18-3311
WATER PUMP KIT**

With Housing
Replaces: 6G5-W0078-A1-00

— CONTAINS —

Part #	Description	O.E.#	Qty.
18-0244	Gasket, Water Pump	6E5-44315-A0-00	1
18-0256	Bolt	97095-08045-00	4
18-3071	Impeller	6E5-44352-01-00	1
18-3170	Housing, Water Pump	6E5-44311-00-00	1
18-3302	Key, Impeller	90280-04M05-00	1
18-3333	Cup, Insert	61A-44322-00-00	1
18-3345	Plate, Wear	6G5-44323-01-00	1
18-7483	O-Ring (6G8)	93210-37M67-00	1
18-7485	O-Ring	93210-86M38-00	1
NSS	Pin, Dowel	93806-12019-00	2
NSS	Washer, Bolt	90209-08M02-00	4



**18-3312
WATER PUMP KIT**
Without Housing
Replaces: 6N6-W0078-00-00

— CONTAINS —

Part #	Description	O.E. #	Qty.
18-0244	Gasket, Water Pump	6E5-44315-A0-00	1
18-0256	Bolt	97095-08045-00	4
18-3071	Impeller	6E5-44352-01-00	1
18-3302	Key, Impeller	90280-04M05-00	1
18-3333	Cup, Insert	61A-44322-00-00	1
18-3344	Plate, Wear	6E5-44323-00-00	1
18-7483	O-Ring (6G8)	93210-37M67-00	1
18-7485	O-Ring	93210-86M38-00	1
NSS	Pin, Dowel	93606-12019-00	2
NSS	Washer, Bolt	90209-08M02-00	4



**18-3313-1
WATER PUMP KIT**
(with Housing)
Replaces: 6N6-W0078-01-00

— CONTAINS —

Part #	Description	O.E. #	Qty.
18-0244	Gasket, Water Pump	6E5-44315-A0-00	1
18-0256	Bolt	97095-08045-00	4
18-3071	Impeller	6E5-44352-01-00	1
18-3173-1	Housing, Water Pump	6E5-44311-00-00	1
18-3302	Key, Impeller	90280-04M05-00	1
18-3333	Cup, Insert	61A-44322-00-00	1
18-3344	Plate, Wear	6E5-44323-00-00	1
18-7483	O-Ring (6G8)	93210-37M67-00	1
18-7485	O-Ring	93210-86M38-00	1
NSS	Pin, Dowel	93606-12019-00	2
NSS	Washer, Bolt	90209-08M02-00	4



**18-3370
WATER PUMP KIT**
Without Housing
Replaces: 692-W0078-00-00,
692-W0078-01-00, 692-W0078-A0-00

— CONTAINS —

Part #	Description	O.E. #	Qty.
18-0239	Gasket, Water Pump	688-44315-A0-00	1
18-0240	Gasket, Water Pump	688-44316-A0-00	1
18-3070	Impeller	688-44352-03-00	1
18-3301	Key, Impeller	90280-04M04-00	1
18-7436	O-Ring	93210-46044-00	1
NSS	Bolt	97395-08070-00	2
NSS	Bolt	97395-08050-00	2
NSS	Cup, Insert	688-44322-00-00	1
NSS	Plate, Wear	688-44323-00-00	1
NSS	Gasket, Water Pump	688-44315-A0-00	1
NSS	Gasket, Water Pump	688-44324-A0-00	1



**18-3371
WATER PUMP KIT** (with Housing)
Replaces: 692-W0078-A0-00

— CONTAINS —

Part #	Description	O.E. #	Qty.
18-3070	Impeller	688-44352-03-00	1
18-3171	Housing, Water Pump	688-44311-01-00	1
18-3301	Key, Impeller	90280-04M04-00	1
18-7436	O-Ring	93210-46044-00	1
NSS	Bolt	97395-08070-00	2
NSS	Bolt	97395-08050-00	2
NSS	Cup, Insert	688-44322-00-00	1
NSS	Plate, Wear	688-44323-00-00	1
NSS	Gasket, Water Pump	688-44315-A0-00	1
NSS	Gasket, Water Pump	688-44324-A0-00	1
NSS	Gasket, Water Pump	688-44316-A0-00	1



**18-3372
WATER PUMP KIT**
With Housing
Replaces: 6E5-W0078-01-00

— CONTAINS —

Part #	Description	O.E. #	Qty.
18-0244	Gasket, Water Pump	6E5-44315-A0-00	1
18-0256	Bolt	97095-08045-00	4
18-3071	Impeller	6E5-44352-01-00	1
18-3302	Key, Impeller	90280-04M05-00	1
18-3344	Plate, Wear	6E5-44323-00-00	1
18-7483	O-Ring	93210-37M67-00	1
18-7485	O-Ring	93210-86M38-00	1
NSS	Pin, Dowel	93606-12019-00	2
NSS	Washer, Bolt	90209-08M02-00	4
NSS	Cup, Insert	6E5-44322-00-00	1



**18-3373
WATER PUMP KIT**
(with Housing)
Replaces: 6E5-W0078-A1-00

— CONTAINS —

Part #	Description	O.E. #	Qty.
18-0244	Gasket, Water Pump	6E5-44315-A0-00	1
18-0256	Bolt	97095-08045-00	4
18-3071	Impeller	6E5-44352-01-00	1
18-3170	Housing, Water Pump	6E5-44311-00-00	1
18-3302	Key, Impeller	90280-04M05-00	1
18-3344	Plate, Wear	6E5-44323-00-00	1
18-7483	O-Ring (6G8)	93210-37M67-00	1
18-7485	O-Ring	93210-86M38-00	1
NSS	Pin, Dowel	93606-12019-00	2
NSS	Washer, Bolt	90209-08M02-00	4
NSS	Cup, Insert	6E5-44322-00-00	1



**18-3395
WATER PUMP KIT**
Without Housing
Replaces: 61A-W0078-01-00

— CONTAINS —

Part #	Description	O.E. #	Qty.
18-0244	Gasket, Water Pump	6E5-44315-A0-00	1
18-0256	Bolt	97095-08045-00	4
18-3071	Impeller	6E5-44352-01-00	1
18-3302	Key, Impeller	90280-04M05-00	1
18-3333	Cup, Insert	61A-44322-00-00	1
18-3345	Plate, Wear	6G5-44323-01-00	1
18-7483	O-Ring (6G8)	93210-37M67-00	1
18-7485	O-Ring	93210-86M38-00	1
NSS	Pin, Dowel	93606-12019-00	2
NSS	Washer, Bolt	90209-08M02-00	4



**18-3396-1
WATER PUMP KIT**
(with Housing)
Replaces: 61A-W0078-A2-00, 61A-W0078-A3-00

— CONTAINS —

Part #	Description	O.E. #	Qty.
18-0244	Gasket, Water Pump	6E5-44315-A0-00	1
18-0256	Bolt	97095-08045-00	4
18-3071	Impeller	6E5-44352-01-00	1
18-3173-1	Housing, Water Pump	6E5-44311-00-00	1
18-3302	Key, Impeller	90280-04M05-00	1
18-3333	Cup, Insert	61A-44322-00-00	1
18-3345	Plate, Wear	6G5-44323-01-00	1
18-7483	O-Ring (6G8)	93210-37M67-00	1
18-7485	O-Ring	93210-86M38-00	1
NSS	Pin, Dowel	93606-12019-00	2
NSS	Washer, Bolt	90209-08M02-00	4

18-3397
WATER PUMP KIT

Without Housing
Replaces: 679-W0078-00-00, 679-W0078-A0-00
— CONTAINS —



Part #	Description	O.E. #	Qty.
18-3088	Impeller	6F5-44352-00-00	1
18-0256	Bolt	97095-08045-00	2
18-3300	Key, Impeller	90280-04M00-00	1
18-3334	Cup, Insert	676-44322-00-00	1
NSS	Gasket, Water Pump	678-44315-A0-00	1
NSS	Gasket, Water Pump	676-44324-A0-00	1
NSS	Gasket, Water Pump	678-44318-A0-00	1
NSS	Plate, Wear	676-44323-00-00	1
NSS	Bolt	97095-08055-00	2
NSS	Seal, Water	663-44366-00-00	1
NSS	Washer, Bolt	92990-08600-00	4

18-3398
WATER PUMP KIT
(with Housing)

Replaces: 6F5-W0078-A0-00, 6F5-W0078-00-00
— CONTAINS —



Part #	Description	O.E. #	Qty.
18-3088	Impeller	6F5-44352-00-00	1
18-0237	Gasket, Water Pump Outer	676-44315-A0-00	1
18-0256	Bolt	97095-08045-00	2
18-3300	Key, Impeller	90280-04M00-00	1
18-3334	Cup, Insert	676-44322-00-00	1
NSS	Gasket, Water Pump	678-44324-A0-00	1
NSS	Gasket, Water Pump	679-44316-A0-00	1
NSS	Plate, Wear	676-44323-00-00	1
NSS	Housing, Water Pump	676-44311-00-00	1
NSS	Bolt	97095-08055-00	2
NSS	Seal, Water	663-44366-00-00	1
NSS	Washer, Bolt	92990-08600-00	4

18-3428-1
WATER PUMP KIT

Without Housing
Replaces: 6H3-W0078-00-00, 6H3-W0078-A0-00
— CONTAINS —



Part #	Description	O.E. #	Qty.
18-0240	Gasket, Water Pump	688-44316-A0-00	1
18-0256	Bolt	97095-08045-00	2
18-0756-1	Gasket, Water Pump	6H3-44315-A0-00	1
18-0757	Gasket, Outer Plate	6H3-44324-A0-00	1
18-3069	Impeller	697-44352-00-00	1
18-3297	Key, Impeller	90280-03M03-00	1
18-3435	Cup, Impeller	663-44322-00-00	1
18-7436	O-Ring	93210-46044-00	1
NSS	Bolt	97095-08055-00	2
NSS	Plate, Wear	63D-44323-00-00	1

18-3461
WATER PUMP KIT
(with Housing)

Replaces: 6H3-W0078-00-00, A0-00, 6H3-44311-00-00
For: 70(1984-91), P60(1991), T50(1996)
— CONTAINS —



Part #	Description	O.E. #	Qty.
NSS	Housing, Water Pump	6H3-44311-00-00	1
18-0240	Gasket, Water Pump	688-44316-A0-00	1
18-0256	Bolt	97095-08045-00	2
18-0756-1	Gasket, Water Pump	6H3-44315-A0-00	1
18-0757	Gasket, Outer Plate	6H3-44324-A0-00	1
18-3069	Impeller	697-44352-00-00	1
18-3297	Key, Impeller	90280-03M03-00	1
18-3435	Cup, Impeller	663-44322-00-00	1
18-7436	O-Ring	93210-46044-00	1
NSS	Bolt	97395-08055-00	2
NSS	Plate, Wear	6H3-44323-00-00	1

18-3429
WATER PUMP KIT

Without Housing
Replaces: 6H4-W0078-00-00, 6H4-W0078-A0-00
— CONTAINS —



Part #	Description	O.E. #	Qty.
18-0256	Bolt	97095-08045-00	2
18-0258	Bolt	97095-08055-00	2
18-0292	Gasket, Wear Plate to Housing	663-44315-A0-00	1
18-0294	Gasket, Wear Plate to Base	663-44324-A0-00	1
18-3068	Impeller	6H4-44352-00-00	1
18-3297	Key, Impeller	90280-03M03-00	1
18-3435	Cup, Insert	663-44322-00-00	1
18-3436	Plate, Wear	663-44323-00-00	1
NSS	Gasket, Water Pump	663-44316-A0-00	1
NSS	Seal	93101-23070-00	1

18-3408
WATER PUMP KIT With Housing

Replaces: 6H4-W0078-00, A0, 663-44311-02
For: 40(1984-87), 50(1984-87), Pro50(1987)
— CONTAINS —



Part #	Description	O.E. #	Qty.
NSS	Housing, Water Pump	638-44311-00-00	1
18-0256	Bolt	97095-08045-00	2
18-0258	Bolt	97395-08055-00	2
18-0292	Gasket, Wear Plate to Housing	663-44315-A0-00	1
18-0294	Gasket, Wear Plate to Base	663-44324-A0-00	1
18-3068	Impeller	6H4-44352-00-00	1
18-3297	Key, Impeller	90280-03M03-00	1
18-3435	Cup, Insert	663-44322-00-00	1
18-3436	Plate, Wear	663-44323-00-00	1
NSS	Gasket, Water Pump	663-44316-00-00	1
NSS	Seal	93101-23070-00	1

18-3433
WATER PUMP KIT

Without Housing
Replaces: 63V-W0078-01-00
Fits: 9.9(1996-04), F15 (1998-04)
— CONTAINS —



Part #	Description	O.E. #	Qty.
18-0256	Bolt	97095-08045-00	4
18-3040	Impeller	63V-44352-01-00	1
18-3195	Plate, Wear	63V-44323-00-00	1
NSS	Key, Impeller	63V-44338-00-00	1
18-3444	Cup, Insert	63V-44322-00-00	1
NSS	Seal, Water	647-44366-00-00	1

18-3412
WATER PUMP KIT
(with Housing)

Replaces: 63V-W0078-01, 63V-44301-00
For: 9.9(1996-09), 15(1996-09), F9.9(2005-06), F15(1998-05), T9.9(2005-06)
— CONTAINS —



Part #	Description	O.E. #	Qty.
18-0256	Bolt	97095-08045-00	4
18-3040	Impeller	63V-44352-01-00	1
18-3195	Plate, Wear	63V-44323-00-00	1
NSS	Key, Impeller	63V-44338-00-00	1
18-3356	Housing, Water Pump	63V-44301-00-00	1
18-3444	Cup, Insert	63V-44322-00-00	1
NSS	Seal, Water	647-44366-00-00	1



18-3434
WATER PUMP KIT
Without Housing
Replaces: 63D-W0078-01-00, 63D-44311-00-00
Fits: 40/50(1995-03), P40(1998), C40 3 cyl(1997-02), C50(1999-01), F40 2.6L(1999), F50(1995-03), P50(1995-96), F60(2002-03)
For kit with housing, order **18-3415**

— CONTAINS —

Part #	Desc.	O.E.#	Qty.
18-0483	Gasket, Pump Case	63D-44316-00-00	1
18-3069	Impeller	697-44352-00-00	1
18-3186	Plate, Wear	63D-44323-00-00	1
18-3297	Key, Impeller	90280-03M03-00	1
18-3449	Cup, Insert	63D-44322-00-00	1
18-8400-9	Bolt (Set of 4)	90119-08M15-00	1
NSS	Cover, Pump Housing	63D-44312-00-00	1
NSS	Washer, Bolt	90209-08M02-00	4
NSS	O-Ring	93210-59MG7-00	1
NSS	Seal, Water	663-44366-00-00	1



18-3415
WATER PUMP KIT
(with Housing)
Replaces: 63D-W0078-01-00, 63D-44311-00-00
Fits: 40/50(1995-03), P40(1998), C40 3 cyl(1997-02), C50(1999-01), F40 2.6L(1999), F50(1995-03), P50(1995-96), F60(2002-03)
For kit w/o housing, order **18-3434**

— CONTAINS —

Part #	Desc.	O.E.#	Qty.
18-0483	Gasket, Water Pump Case	63D-44316-00-00	1
18-3069	Impeller	697-44352-00-00	1
18-3186	Plate, Wear	63D-44323-00-00	1
18-3297	Key, Impeller	90280-03M03-00	1
18-3449	Cup, Insert	63D-44322-00-00	1
18-8400-9	Bolt (Set of 4)	90119-08M15-00	1
NSS	Cover, Water Pump Housing	63D-44312-00-00	1
NSS	Washer, Bolt	90209-08M02-00	4
NSS	O-Ring	93210-59MG7-00	1
NSS	Seal, Water	663-44366-00-00	1
NSS	Housing, Water Pump	63D-44311-00-00	1



18-3440
WATER PUMP KIT
Without Housing
Replaces: 66T-W0078-00-00
Fits: T25 (2001-04), F30 (2001-04), F40 (2000-04)

— CONTAINS —

Part #	Desc.	O.E.#	Qty.
18-0483	Gasket, Pump Case	63D-44316-00-00	1
18-3068	Impeller	6H4-44352-00-00	1
18-3196	Plate, Impeller	66T-44323-00-00	1
18-3297	Key, Impeller	90280-03M03-00	1
18-3449	Cup, Insert	63D-44322-00-00	1
18-8400-9	Bolt (Set of 4)	90119-08M15-00	1
NSS	Cover, Pump Housing	63D-44312-00-00	1
NSS	O-Ring	93210-59MG7-00	1
NSS	Seal, Water	663-44366-00-00	1
NSS	Washer	90209-08M02-00	4



18-3413
WATER PUMP KIT
(with Housing)
Replaces: 66T-W0078-00, 66T-44311-00
For: F30(2001-05), F40(2000-08), T25 (2001-06)
For kit w/o housing, order **18-3440**

— CONTAINS —

Part #	Desc.	O.E.#	Qty.
18-0483	Gasket, Water Pump Case	63D-44316-00-00	1
18-3068	Impeller	6H4-44352-00-00	1
18-3196	Plate, Wear	66T-44323-00-00	1
18-3297	Key, Impeller	90280-03M03-00	1
18-3449	Cup, Insert	63D-44322-00-00	1
18-8400-9	Bolt (Set of 4)	90119-08M15-00	1
NSS	Cover, Water Pump Housing	63D-44312-00-00	1
NSS	O-Ring	93210-59MG7-00	1
NSS	Seal, Water	663-44366-00-00	1
NSS	Washer, Bolt	90209-08M02-00	4
NSS	Housing, Water Pump	66T-44311-00-00	1



18-3442
WATER PUMP REPAIR KIT
Without Housing
Replaces: 68V-W0078-00-00
For: F115 2002-2010 / LF115 2002-2010

— CONTAINS —

Part #	Desc.	O.E.#	Qty.
18-0244	Gasket, Water Pump	6E5-44315-A0-00	2
18-0256	Bolt	97095-08045-00	4
18-3071	Impeller	6E5-44352-01-00	1
18-3302	Key, Impeller	90280-04M05-00	1
18-3519	Cup, Insert	61A-44322-02-00	1
18-3521	Plate, Wear	68V-44323-00-00	1
18-7483	O-Ring (6G8)	93210-37M67-00	1
18-7485	O-Ring	93210-86M38-00	1
NSS	Pin, Dowel	93606-12019-00	2
NSS	Washer	90209-08M02-00	4



18-3523-1
WATER PUMP KIT
(with Housing)
Replaces: 68V-W0078-00, 61A-44311-01
Fits: F115 & LF115 (2002 & Up)

— CONTAINS —

Part #	Desc.	O.E.#	Qty.
18-0244	Gasket, Water Pump	6E5-44315-A0-00	2
18-0256	Bolt	97095-08045-00	4
18-3071	Impeller	6E5-44352-01-00	1
18-3173-1	Housing, Water Pump	61A-44311-01-00	1
18-3302	Key, Impeller	90280-04M05-00	1
18-3519	Cup, Insert	61A-44322-02-00	1
18-3521	Plate, Wear	68V-44323-00-00	1
18-7483	O-Ring (6G8)	93210-37M67-00	1
18-7485	O-Ring	93210-86M38-00	1
NSS	Pin, Dowel	93606-12019-00	2
NSS	Washer, Bolt	90209-08M02-00	4



18-3450
WATER PUMP KIT
Without Housing
Replaces: 68T-W0078-00-00
For: F8, F8 (2001-05)

— CONTAINS —

Part #	Desc.	O.E.#	Qty.
18-0256	Bolt	97095-08045-00	4
18-3142	Plate, Wear	68T-44323-00-00	1
18-3176	Seal, Water Damper	68T-44366-00-00	1
NSS	Key, Impeller	63V-44338-00-00	1
18-3444	Cup, Insert	63V-44322-00-00	1
18-8910	Impeller	68T-44352-00-00	1
NSS	O-Ring	93210-44398-00	1



18-3410
WATER PUMP KIT (with Housing)
Replaces: 68T-W0078-00, 63V-44301-00
For: F6(01-08), F8(01-09), F9.9(07-09)

— CONTAINS —

Part #	Desc.	O.E.#	Qty.
18-0256	Bolt	97095-08045-00	4
18-3142	Plate, Wear	68T-44323-00-00	1
18-3176	Seal, Water Damper	68T-44366-00-00	1
NSS	Key, Impeller	63V-44338-00-00	1
18-3356	Housing, Water Pump	63V-44301-00-00	1
18-3444	Cup, Insert	63V-44322-00-00	1
18-8910	Impeller	68T-44352-00-00	1
NSS	O-Ring	93210-44398-00	1

**18-3451
WATER PUMP KIT**

Replaces: 67F-W0078-00-00
Fits: F75 (2003-06), F80(1999-03), F90(2003-04), F100(1999-02)

— CONTAINS —

Part #	Desc.	O.E.#	Qty.
18-2605	Bolt	90119-08M87-00	2
18-2606	Bolt	90119-08M13-00	2
18-3042	Impeller	67F-44352-00-00	1
18-3143	Plate, Wear	67F-44323-00-00	1
18-3162	Cup, Insert	67F-44322-00-00	1
18-3301	Key, Impeller	90280-04M04-00	1
18-7436	O-Ring	93210-46044-00	1
NSS	Gasket, Water Pump	688-44315-A0-00	1
NSS	Gasket, Water Pump	688-44324-A0-00	1
NSS	Gasket, Water Pump	688-44316-A0-00	1
NSS	Washer, Bolt	90209-08M02-00	4

**18-3409
WATER PUMP KIT (with Housing)**

Replaces: 67F-W0078-00, 67F-44311-01
For: F75(2006-10), F80(1999-03), F90(2006-10), F100(1999-03)

— CONTAINS —

Part #	Desc.	O.E.#	Qty.
18-2605	Bolt	90119-08M87-00	2
18-2606	Bolt	90119-08M13-00	2
18-3042	Impeller	67F-44352-00-00	1
18-3143	Plate, Wear	67F-44323-00-00	1
18-3162	Cup, Insert	67F-44322-00-00	1
18-3301	Key, Impeller	90280-04M04-00	1
18-7436	O-Ring	93210-46044-00	1
NSS	Gasket, Water Pump	688-44315-A0-00	1
NSS	Gasket, Water Pump	688-44324-A0-00	1
NSS	Gasket, Water Pump	688-44316-A0-00	1
NSS	Housing, Water Pump	67F-44311-01-00	1
NSS	Washer, Bolt	90209-08M02-00	4

**18-3465
WATER PUMP KIT
Without Housing**

Replaces: 6H3-W0078-02-00
Fits: T50(1997-05), 60(2001-03), C60(1997-01), C70(2000-01), F60(1997-99), T60(2003-05), 70(1997-03)

— CONTAINS —

Part #	Desc.	O.E.#	Qty.
18-3069	Impeller	697-44352-00-00	1
18-0256	Bolt	97095-08045-00	2
18-0757	Gasket, Water Pump	6H3-44324-A0-00	1
18-3297	Key, Impeller	90280-03M03-00	1
18-3435	Cup, Insert	663-44322-00-00	1
18-7436	O-Ring	93210-46044-00	1
NSS	Plate, Wear	6H3-44323-00-00	1
NSS	Gasket, Water Pump	6H3-44315-A0-00	1
NSS	Gasket, Water Pump	6H3-44324-A0-00	1
NSS	Bolt	97095-08055-00	2
NSS	Washer, Bolt	90209-08M02-00	4

**18-3466
WATER PUMP KIT (with Housing)**

Replaces: 6H3-W0078-01, 6H3-44311-00
For: 70(1992-03), C60(1996-01), E60(1995-96), P60(1992-99), C70(2000-01), T50(1997-10), T60(2003-10)

— CONTAINS —

Part #	Desc.	O.E.#	Qty.
NSS	Housing, Water Pump	6H3-44311-00-00	1
18-0256	Bolt	97095-08045-00	2
18-0757	Gasket, Water Pump	6H3-44324-A0-00	1
18-3069	Impeller	697-44352-00-00	1
18-3297	Key, Impeller	90280-03M03-00	1
18-3435	Cup, Insert	663-44322-00-00	1
18-7436	O-Ring	93210-46044-00	1
NSS	Plate, Wear	6H3-44323-00-00	1
NSS	Gasket, Water Pump	6H3-44315-A0-00	1
NSS	Gasket, Water Pump	688-44316-A0-00	1
NSS	Bolt	97095-08055-00	2
NSS	Washer, Bolt	90209-08M02-00	4

**18-3470
WATER PUMP REPAIR KIT
Without Housing**

Replaces: 6CE-W0078-01
Fits: F225 (2010-15), F250 (2010), F250 (2010-15), F300 (2007-15), F350 (2007-15), FL250 (2010), FL300 (2010), FL350 (2010), LF225 (2010-15), LF250 (2010-15), LF300 (2007-15), LF350 (2007-15), VF250 (2015)

— CONTAINS —

Part #	Desc.	O.E.#	Qty.
18-7471	O-Ring, Outer	93210-94003-00	1
18-0256	Bolt	97095-08045-00	4
18-2091	Seal, Oil	93104-22M07-00	2
18-3302	Key, Impeller	90280-04M05-00	1
18-3457	Cup, Insert	6AW-44322-00-00	1
18-3458	Gasket, Water Pump	6CE-44315-00-00	1
18-3459	Plate, Wear	6CE-44323-01-00	1
18-45617-1	Impeller	6CE-44352-00-00	1
18-7483	O-Ring (6G8)	93210-37M67-00	1
NSS	Washer, Bolt	90209-08M02-00	4
NSS	Pin, Dowel	93606-12019-00	2

**18-3471
WATER PUMP REPAIR KIT
(with Housing)**

Replaces: 6CE-W0078-01 + 6CE-44311-01
Fits: F225 (2010-15), F250 (2010), F250 (2010-15), F300 (2007-15), F350 (2007-15), FL260 (2010), FL300 (2010), FL350 (2010), LF225 (2010-15), LF250 (2010-15), LF300 (2007-15), LF350 (2007-15), VF250 (2015)

— CONTAINS —

Part #	Desc.	O.E.#	Qty.
18-7471	O-Ring, Outer	93210-94003-00	1
18-0256	Bolt	97095-08045-00	4
18-2091	Seal, Oil	93104-22M07-00	2
18-3302	Key, Impeller	90280-04M05-00	1
18-3457	Cup, Insert	6AW-44322-00-00	1
18-3458	Gasket, Water Pump	6CE-44315-00-00	1
18-3459	Plate, Wear	6CE-44323-01-00	1
18-3482	Housing, Water Pump	6CE-44311-01-00	1
18-45617-1	Impeller	6CE-44352-00-00	1
18-7483	O-Ring (6G8)	93210-37M67-00	1
NSS	Washer, Bolt	90209-08M02-00	4
NSS	Pin, Dowel	93606-12019-00	2

**18-3516
WATER PUMP REPAIR KIT
Without Housing**

Replaces: 60X-W0078-00-00
For: VZ200 (3.3L) 2005-2010, VZ225 (3.3L) 2003-2010, VZ250 (3.3L) 2003-2010, VZ300 (3.3L) 2005-2010

— CONTAINS —

Part #	Desc.	O.E.#	Qty.
18-0256	Bolt	97095-08045-00	4
18-3071	Impeller	6E5-44352-01-00	1
18-3302	Key, Impeller	90280-04M05-00	1
18-3519	Cup, Insert	61A-44322-02-00	1
18-3520	Plate, Wear	60X-44323-00-00	1
18-7483	O-Ring (6G8)	93210-37M67-00	1
18-7485	O-Ring	93210-86M38-00	1
18-0406	Gasket, Water Pump	60X-44315-A0-00	1
NSS	Pin, Dowel	93606-12019-00	2
NSS	Washer, Bolt	90209-08M02-00	4

**18-3522-1
WATER PUMP KIT
(with Housing)**

Replaces: 60X-W0078-00, 61A-44311-01
For: VZ200(2005-09), VZ225(2003-09), VZ250(2003-09), VZ300(2004-09)

— CONTAINS —

Part #	Desc.	O.E.#	Qty.
18-0256	Bolt	97095-08045-00	4
18-3071	Impeller	6E5-44352-01-00	1
18-3173-1	Housing, Water Pump	6E5-44311-00-00	1
18-3302	Key, Impeller	90280-04M05-00	1
18-3519	Cup, Insert	61A-44322-02-00	1
18-3520	Plate, Wear	60X-44323-00-00	1
18-7483	O-Ring (6G8)	93210-37M67-00	1
18-7485	O-Ring, Outer	93210-86M38-00	1
NSS	Gasket, Water Pump	60X-44315-A0-00	1
NSS	Pin, Dowel	93606-12019-00	2
NSS	Washer, Bolt	90209-08M02-00	4

18-3425
WATER PUMP KIT

Without Housing

Replaces: 663-W0078-00-00, 663-W0078-A0-00



— CONTAINS —

Part #	Description	O.E.#	Qty.
18-0256	Bolt	97095-08045-00	2
18-0292	Gasket, Water Pump	663-44315-00-00	1
18-0294	Gasket, Water Pump	663-44324-A0-00	1
18-3069	Impeller	697-44352-00-00	1
18-3297	Key, Impeller	90280-03M03-00	1
18-3435	Cup, Insert	663-44322-00-00	1
18-3436	Plate, Wear	663-44323-00-00	1
NSS	Bolt	97095-08055-00	2
NSS	Seal, Water	663-44366-00-00	1

18-3430
WATER PUMP REPAIR KIT
Without Housing

Replaces: 6J8-W0078-A1-00



— CONTAINS —

Part #	Description	O.E.#	Qty.
18-0294	Gasket, Water Pump	663-44324-A0-00	1
18-3068	Impeller	6H4-44352-00-00	1
18-3435	Cup, Insert	663-44322-00-00	1
18-3436	Plate, Wear	663-44323-00-00	1
NSS	Gasket, Water Pump	663-44315-A0-00	1
NSS	Gasket, Water Pump	663-44324-A0-00	1
NSS	Bolt	97395-08050-00	2
NSS	Bolt	97395-08040-00	2
NSS	Washer, Bolt	90209-08M02-00	4

18-3431
WATER PUMP KIT

Without Housing

Replaces: 6L2-W0078-00-00



— CONTAINS —

Part #	Description	O.E.#	Qty.
NSS	Cup, Insert	6L2-44322-00-00	1
18-2607	Bolt	97095-06040-00	4
18-3065	Impeller	6L2-44352-00-00	1
18-7483	O-Ring (6G8)	93210-37M67-00	1
NSS	Plate, Wear	6L2-44323-00-00	1

18-3460
WATER PUMP KIT

Replaces: 6N0-W0078-A0-00, 6G1-W0078-A1-00, 6G1-W0078-01-00

Fits: 6(1986-00), 8(1984-05)



— CONTAINS —

Part #	Desc.	O.E.#	Qty.
18-0753	Gasket, Water Pump	6G1-44315-A0-00	1
18-3066	Impeller	6G1-44352-00-00	1
18-3456	Cup, Insert	6G1-44322-00-00	1
NSS	Plate, Wear	6G1-44323-00-00	1
NSS	Plate, Bolt	6G1-44328-00-00	2
NSS	Bolt	97095-06045-00	4
NSS	Seal, Water	647-44366-00-00	1

18-3462
WATER PUMP KIT

Replaces: 6A1-W0078-02-00

Fits: 2(1988-02)



— CONTAINS —

Part #	Desc.	O.E.#	Qty.
NSS	Protector, Oil Seal	6A1-44325-00-00	1
18-3072	Impeller	646-44352-01-00	1
18-3328	Cup, Insert	646-44322-00-00	1
18-3357	Plate, Wear	646-44323-00-00	1
18-7463	O-Ring	93210-19123-00	1
NSS	Seal, Water	646-44366-01-00	1
NSS	Seal, Oil	93101-11M44-00	2
NSS	Pin, Dowel	93604-09068-00	2
NSS	Bolt	97095-05016-00	2

18-3463
WATER PUMP KIT

Replaces: 6A1-W0078-01-00

Fits: 2(1984-87)



— CONTAINS —

Part #	Desc.	O.E.#	Qty.
NSS	Protector, Oil Seal	6A1-44325-00-00	1
18-3328	Impeller	646-44322-00-00	1
18-3328	Cup, Insert	646-44322-00-00	1
18-3357	Plate, Wear	646-44323-00-00	1
18-7463	O-Ring	93210-19123-00	1
NSS	Seal, Water	646-44366-01-00	1
NSS	Seal, Oil	93103-11051-00	1
NSS	Pin, Dowel	93604-09068-00	2
NSS	Bolt	97095-05016-00	2

18-3515
WATER PUMP REPAIR KIT

Replaces: 6P2-W0078-00-00

For: F225 Produced after 04/2007 / F250 Produced after 4/2006



— CONTAINS —

Part #	Desc.	O.E.#	Qty.
18-0256	Bolt	97095-08045-00	4
18-0406	Gasket, Water Pump	60X-44315-A0-00	1
18-3071	Impeller	6E5-44352-01-00	1
18-3302	Key, Impeller	90280-04M05-00	1
18-3518	Plate, Wear	6P2-44323-00-00	1
18-3519	Cup, Insert	61A-44322-02-00	1
18-7483	O-Ring (6G8)	93210-37M67-00	1
18-7485	O-Ring	93210-86M38-00	1
NSS	Pin, Dowel	93606-12019-00	2
NSS	Washer, Bolt	90209-08M02-00	4

18-3426
WATER PUMP KIT

With Housing

Replaces: 689-W0078-04-00, 689-W0078-A4-00



— CONTAINS —

Part #	Description	O.E.#	Qty.
18-3067	Impeller	689-44352-02-00	1
NSS	Key, Impeller	63V-44338-00-00	1
NSS	Housing, Water Pump	689-44311-03-00	1
NSS	Gasket, Water Pump	689-44324-A0-00	1
NSS	Cup, Insert	689-W4432-02-00	1
NSS	Plate, Wear	689-44323-03-00	1
NSS	Washer, Bolt	90209-08M04-00	3
NSS	Bolt	90101-08M56-00	3
NSS	Grommet	689-44366-00-00	1
NSS	Gasket, Seal Cover	689-44315-01-00	1

18-3432

WATER PUMP KIT

Replaces: 61N-W0078-11-00
Fits: F25(1998-05)



— CONTAINS —

Part #	Desc.	O.E.#	Qty.
18-0191	Plate, Washer	92990-06800-00	4
18-2607	Bolt	97095-06040-00	4
18-3068	Impeller	6H4-44352-00-00	1
18-3185	Housing, Water Pump	61N-44311-01-00	1
18-3194	Plate, Wear	61N-44323-00-00	1
18-3297	Key, Impeller	90280-03M03-00	1
18-3443	Cup, Insert	61N-44322-01-00	1
18-7115	O-Ring	93210-45161-00	1
NSS	Seal, Water	6L2-44367-00-00	1

18-3427

WATER PUMP KIT

With Housing
Replaces: 689-W0078-A6-00



— CONTAINS —

Part #	Description	O.E.#	Qty.
18-3067	Impeller	689-44352-02-00	1
NSS	Key, Impeller	63V-44338-00-00	1
NSS	Gasket, Water Pump	689-44316-A0-00	1
NSS	Plate, Wear	689-44323-03-00	1
NSS	Gasket, Water Pump	689-44324-A0-00	1
NSS	Cup, Insert	689-44352-02-00	1
NSS	Housing, Water Pump	689-44311-03-00	1
NSS	Washer, Bolt	90209-06M04-00	3
NSS	Bolt	90101-06M56-00	3
NSS	Grommet	689-44366-00-00	1

18-48619

COMPLETE WATER PUMP KIT

Replaces: 68D-WG078-00-00
Fits: Yamaha F4(2002-06)



— CONTAINS —

Part #	Desc.	O.E.#	Qty.
18-43263	Housing, Water Pump	68D-G4311-01-00	1
18-3073	Impeller	6E0-44352-00-00	1
18-43531	Cup, Insert	6E0-44322-02-00	1
18-43716	Pin, Impeller	93604-18080-00	1
18-43818	Bolt	97095-06045-00	4
18-60541	Gasket, Water Pump	68X-G4315-01-00	1
NSS	Plate, Wear	6E0-44323-00-00	1
NSS	Tube, Rubber	87D-44366-00-00	1
NSS	Washer, Bolt	N/A	4
NSS	Plate, Bolt	68D-G4328-00-00	2

18-3473

WATER PUMP KIT

With Housing
Replaces: 6EE-W0078-00-00
Fits: F4 (2009-17), F6 (2009-17)



— CONTAINS —

Part #	Description	O.E.#	Qty.
18-3073	Impeller	6E0-44352-00	1
18-4567	Housing, Water Pump	6EE-G4311-00	1
18-60541	Gasket, Water Pump	6EE-G4315-00	1
18-4546	Cup, Insert	6EE-G4322-00	1
18-4573	Plate, Wear	6EE-G4323-00	1
18-1840	Damper, Water Seal 2	6EE-G4366-00	1
18-43716	Pin, Dowel (647)	93604-18080	2
18-0261	Bolt	97080-06045	4

18-3474

WATER PUMP KIT

Without Housing
Replaces: 6CB-W0078-00-00
Fits: VF225, VF250 (2009-18)



— CONTAINS —

Part #	Description	O.E.#	Qty.
18-3919	Cup, Insert	61A-44322-02	1
18-0451	Gasket, Water Pump	6CB-44315-00-00	1
18-4572	Plate, Wear	6CB-44323-00-00	1
18-3071	Impeller	6E5-44352-01	1
NSS	Bolt, With Washer	90119-08M14	4
18-3302	Key, Woodruff	90280-04002	1
18-7483	O-Ring (6G8)	93210-37M67	1
18-7485	O-Ring (6E5)	93210-86M38	1
NSS	Pin, Dowel (614)	93606-12019	2

18-3475

WATER PUMP KIT

Without Housing
Replaces: 69G-W0078-00
Fits: T9.9 (2007-17)



— CONTAINS —

Part #	Description	O.E.#	Qty.
18-3444	Cup, Insert	63V-44322-00	1
18-3040	Impeller	63V-44352-01	1
NSS	Key, Woodruff	664-44338-00	1
18-3142	Plate, Wear	68T-44323-00	1
18-3176	Damper, Water Seal 2	68T-44366-00	1
18-71331	O-Ring (5X)	93210-44704	1
18-0256	Bolt	97095-08045	4

18-3477

WATER PUMP KIT

Without Housing
Replaces: 6AW-W0078-00-00
Fits: F300, LF300 (2007-09)



— CONTAINS —

Part #	Description	O.E.#	Qty.
18-0452	Gasket, Water Pump	6AW-44315-00	1
18-3457	Cup, Insert	6AW-44322-00	1
18-0421	Plate, Wear	6AW-44323-00	1
18-3028	Key, Impeller	6AW-44336-00	1
18-8925	Impeller	6AW-44352-00	1
NSS	Bolt, With Washer	90119-08M14	4
18-7483	O-Ring (6G8)	93210-37M67	1
18-7471	O-Ring (6E8)	93210-94003	1
NSS	Pin, Dowel (614)	93606-12019	2

18-3479

WATER PUMP KIT

With Housing
Replaces: 6AH-W0078-00
Fits: F15C, F20 (2006-17)



— CONTAINS —

Part #	Description	O.E.#	Qty.
18-3444	Cup, Insert	63V-44322-00	1
18-9090	Plate	63V-44328-01	2
18-3040	Impeller	63V-44352-01	1
NSS	Key, Woodruff	664-44338-00	1
18-3142	Plate, Wear	68T-44323-00	1
NSS	Housing, Water Pump	6AH-44311-00	1
18-1836	Damper, Water Seal	6L2-44367-00	1
18-71333	O-Ring (620)	93210-49046	1
18-43717	Pin, Dowel (688)	93604-10M03	2
18-0256	Bolt, Hexagon	97095-08045	4

**18-3490
WATER PUMP KIT**

Without Housing

Replaces: 6BG-W0078-00-00

Fits: F30 (2013-17), F40A (2008-17)



— CONTAINS —

Part #	Description	O.E. #	Qty.
18-9083	Cover, Water Pump Housing	63D-44312-00	1
18-0483	Gasket, Water Pump	63D-44316-00	1
18-3449	Cup, Insert	63D-44322-00	1
18-3186	Plate, Wear	63D-44323-00	1
18-1828	Seal, Water Damper 2	663-44366-00	1
18-3068	Impeller	6H4-44352-02	1
18-8400-9	Bolt, With Washer	90119-08M15	4
18-3297	Key, Woodruff	90280-03M03	1
18-71334	O-Ring	93210-59MG7	1

**18-3494
WATER PUMP KIT**

Without Housing

Replaces: 6CJ-W0078-00-00

Fits: F70A (2010-17)



— CONTAINS —

Part #	Description	O.E. #	Qty.
18-9083	Cover, Water pump Housing	63D-44312-00	1
18-3449	Cup, Insert	63D-44322-00	1
18-1830	Seal, Water Damper 2	663-44366-00	1
18-0448	Gasket, Water Pump	6CJ-44315-00	1
18-0449	Gasket, Water Pump	6CJ-44316-00	1
18-3186	Plate, Wear	6CJ-44323-00	1
18-0450	Gasket, Water Pump	6CJ-44324-00	1
18-3069	Impeller	6H3-44352-00	1
NSS	Bolt, With Washer	90119-08M14	2
18-0260	Bolt, With Washer	90119-08M33	2
18-3297	Key, Woodruff (697)	90280-03M03	1
18-0297	Oil Seal (663)	93101-23070	2
18-7436	O-Ring	93210-46044	1
18-43717	Pin, Dowel (688)	93604-10M03	2

**18-4527
WATER PUMP KIT**

With Housing

Replaces: 6FM-W0078-00-00

Fits: F25C (2016-17)



— CONTAINS —

Part #	Description	O.E. #	Qty.
18-4576	Plate, Wear	6FM-44323-01	1
18-3486	Housing, Water Pump	6L2-44311-01	1
18-4548	Cup, Insert	6L2-44322-00	1
18-9092	Plate	6L2-44328-00	2
18-3065	Impeller	6L2-44352-00	1
18-1837	Seal, Water Damper 3	6L2-44367-10	1
18-3305	Key, Woodruff (662)	90280-03024	1
18-71332	O-Ring	93210-45161	1
18-43717	Pin, Dowel (688)	93604-10M03	2
18-8407	Bolt, With Washer	97595-06540	4

**18-4532
WATER PUMP KIT**

Without Housing

Replaces: 6EG-W0078-00-00

Fits: F2.5 (2015-17)



— CONTAINS —

Part #	Description	O.E. #	Qty.
18-1840	Seal, Water Damper 2	6EE-G4366-00	1
18-99157	Gasket, Water Pump	6EG-G4315-00	1
18-4547	Cup, Insert	6EG-G4322-00	1
18-4574	Plate, Wear	6EG-G4323-00	1
18-9089	Plate	6EG-G4328-00	2
18-8911	Impeller	6L5-44352-00	1
18-43717	Pin, Dowel (688)	93604-10M03	2
18-8406	Bolt W/ Washer	97595-06535	4

**18-4533
WATER PUMP KIT**

Without Housing

Replaces: 65N-W0078-A0-00

Fits: B115 (1998-99), D150 (1997-98), DX150 (1999-05)



— CONTAINS —

Part #	Description	O.E. #	Qty.
18-3519	Cup, Insert	61A-44322-02	1
18-0453	Gasket, Water Pump	65N-44315-A0	1
18-0408	Plate, Wear	65N-44323-00	1
18-3071	Impeller	6E5-44352-01	1
NSS	Bolt, With Washer	90119-08M14	4
18-3302	Key, Woodruff (6E5)	90280-04M05	1
18-7483	O-Ring (6G8)	93210-37M87	1
18-7485	O-Ring (6E5)	93210-86M38	1
NSS	Pin, Dowel (614)	93606-12019	2

**18-4534
WATER PUMP KIT**

Without Housing

Replaces: 69M-WG078-00-00

Fits: F2.5 (2003-15)



— CONTAINS —

Part #	Description	O.E. #	Qty.
18-3166	Seal, Water Damper 2	6E0-44366-00	1
18-7119	O-Ring	93210-33M85	1
18-3164	Cup, Insert	6L5-44322-00	1
18-8911	Impeller	6L5-44352-00	1
18-0409	Plate, Wear	69M-G4323-00	1
18-43718	Pin, Dowel	93604-18080	2
18-71330	O-Ring	93210-05001	1
18-2607	Bolt	97095-06040	4
18-9091	Plate	69M-G4328-00	1

YAMAHA 4-STROKE WATER PUMP APPLICATION CHART

HP Model	Year	Impeller	Cup	Plate	Housing	Damper Seal	Water Pump Cover	Kit without Housing	Kit with Housing
F2.5	2003-15	18-8911	-	18-0409	-	18-3166	-	18-4534	-
F2.5	2016-18	18-8911	18-4547	18-4574	-	18-1840	-	18-4532	-
F4	1984-99	18-3073	-	-	-	-	-	-	-
F4	1999-13	18-3073	-	-	-	-	-	-	-
F4	2014-18	18-3073	18-4546	18-4573	18-4567	18-1840	-	18-3473	-
F6	2001-08	18-8910	18-3444	18-3142	18-3356	18-3176	-	18-3450	18-3410
F6	2009-17	18-3073	18-4546	18-4573	18-4567	-	-	18-3473	-
F8	2001-17	18-8910	18-3444	18-3142	18-3356	18-3176	-	18-3450	18-3410
T8	2001-10	18-3040	18-3444	18-3142	18-3356	18-3176	-	18-3450	18-3410
F9.9	1985-05	18-3074	-	-	-	18-1834	-	18-3148	18-3411
F9.9	2005-06	18-3040	18-3444	18-3195	18-3356	18-1833	-	18-3433	18-3412
F9.9	2007-17	18-8910	18-3444	18-3142	18-3356	18-3176	-	18-3450	18-3410

APPLICATION CONTINUES ON NEXT PAGE

YAMAHA 4-STROKE WATER PUMP APPLICATION CHART

HP Model	Year	Impeller	Cup	Plate	Housing	Damper Seal	Water Pump Cover	Kit without Housing	Kit with Housing
FT9.9	1985-90	18-3074	-	-	-	18-1834	-	18-3148	18-3411
T9.9	1985-05	18-3074	-	-	-	18-1834	-	18-3148	18-3411
T9.9	2005-06	18-3040	18-3444	18-3195	18-3356	18-1833	-	18-3433	18-3412
T9.9	2007-17	18-3040	18-3444	18-3142	18-3356	18-3176	-	18-3475	-
F15	1998-06	18-3040	18-3444	18-3195	18-3356	18-1833	-	18-3433	18-3412
F15C	2006-18	18-3040	18-3444	18-3142	18-3484	18-1836	-	18-3479	-
F20	2006-18	18-3040	18-3444	18-3142	18-3484	18-1836	-	18-3479	-
F25	1998-05	18-3068	18-3443	18-3194	18-3185	-	-	-	18-3432
F25A	2009-17	18-3068	18-3443	18-3194	18-3185	-	-	-	18-3432
F25B	2012-17	18-3068	18-3443	18-3194	18-3185	-	-	-	18-3432
F25C	2016-17	18-3065	18-4548	18-4576	18-3486	18-1837	-	18-4527	-
T25	2001-06, 2009-17	18-3068	18-3449	18-3196	-	-	-	18-3440	18-3413
F30	2001-05	18-3068	18-3449	18-3196	-	-	-	18-3440	18-3413
F30	2013-17	18-3068	18-3449	18-3186	-	18-1828	18-9083	18-3490	18-3413
F40	1999	18-3069	18-3449	18-3186	-	-	-	18-3434	18-3415
F40	2000-06	18-3068	18-3449	18-3196	-	-	-	18-3440	18-3413
F40A	2008-17	18-3068	18-3449	18-3186	-	18-1828	18-9083	18-3490	18-3413
F40B	2007-08	18-3068	18-3449	18-3196	-	-	-	18-3440	18-3413
F50	1995-17	18-3069	18-3449	18-3186	-	-	-	18-3434	18-3415
F50	1996	18-3069	18-3435	-	-	-	-	18-3428-1	18-3461
F50	1997	18-3069	18-3435	-	-	-	-	18-3465	18-3466
T50	1996	18-3069	18-3435	-	-	-	-	18-3428-1	18-3461
T50	1997-17	18-3069	18-3435	-	-	-	-	18-3465	18-3466
F60	2002-17	18-3069	18-3449	18-3186	-	-	-	18-3434	18-3415
T60	2003-17	18-3069	18-3435	-	-	-	-	18-3465	18-3466
F70A	2010-17	18-3069	18-3449	-	18-3485	-	-	18-3494	-
F75A	2003-17	18-3042	18-3162	18-3143	-	18-1830	-	18-3451	18-3409
F75B	2017	18-3071	18-3519	18-3521	18-3173-1	18-1835	18-9081	18-3442	18-3523-1
F80	1999-03	18-3042	18-3162	18-3143	-	18-1830	-	18-3451	18-3409
F90	2003-11	18-3042	18-3162	18-3143	-	18-1830	-	18-3451	18-3409
F90A	2012-17	18-3042	18-3162	18-3143	-	18-1830	-	18-3451	18-3409
F90B	2016-17	18-3071	18-3519	18-3521	18-3173-1	18-1835	18-9081	18-3442	18-3523-1
VF90A	2018	18-3071	18-3519	18-3521	18-3173-1	18-1835	18-9081	18-3442	18-3523-1
F100	1999-03	18-3042	18-3162	18-3143	-	18-1830	-	18-3451	18-3409
F115/LF115	2000-01	18-3071	18-3333	18-3344	18-3173-1	18-1835	18-9081	-	18-3313-1
F115/LF115	2002-17	18-3071	18-3519	18-3521	18-3173-1	18-1835	18-9081	18-3442	18-3523-1
VF115	2015-17	18-3071	18-3519	18-3521	18-3173-1	18-1835	18-9081	18-3442	18-3523-1
F150 / LF150	2004-11	18-3071	18-3519	18-3345	18-3173-1	18-1835	18-9081	18-3395	18-3396-1
F150A / LF150A	2012-14	18-3071	18-3519	18-3345	18-3173-1	18-1835	18-9081	18-3395	18-3396-1
F150B / LF150B	2015-18	18-3071	18-3519	18-3345	18-3173-1	18-1835	18-9081	18-3395	18-3396-1
F150C / LF150C	2017	18-3071	18-3519	18-3345	18-3173-1	18-1835	18-9081	18-3395	18-3396-1
VF150	2013-17	18-3071	18-3519	18-3345	18-3173-1	18-1835	18-9081	18-3395	18-3396-1
VF150A	2018	18-3071	18-3519	18-3345	18-3173-1	18-1835	18-9081	18-3395	18-3396-1
F175A	2014-18	18-3071	18-3519	18-3345	18-3173-1	18-1835	18-9081	18-3395	18-3396-1
F175 / LF175C	2017	18-3071	18-3519	18-3345	18-3173-1	18-1835	18-9081	18-3395	18-3396-1
VF175	2015-18	18-3071	18-3519	18-3345	18-3173-1	18-1835	18-9081	18-3395	18-3396-1
F200/LF200	2002-10	18-3071	18-3519	18-3345	18-3173-1	18-1835	18-9081	18-3395	18-3396-1
F200A/LF200A	2010-17	18-3071	18-3519	18-3345	18-3173-1	18-1835	18-9081	18-3395	18-3396-1
F200B/LF200B	2012-18	18-3071	18-3519	18-3345	18-3173-1	18-1835	18-9081	18-3395	18-3396-1
F200C/LF200C	2013-18	18-3071	18-3519	18-3345	18-3173-1	18-1835	18-9081	18-3395	18-3396-1
VF200	2009-18	18-3071	18-3519	-	18-3173-1	18-1835	18-9081	-	-
F225 / LF225	2002-10	18-3071	18-3519	18-3345	18-3173-1	18-1835	18-9081	18-3395	18-3396-1
F225 / LF225	2007-09	18-3071	18-3519	18-3518	18-3173-1	18-1835	18-9081	18-3515	-
F225A/LF225A (3.3L)	2011-17	18-3071	18-3519	18-3345	18-3173-1	18-1835	18-9081	18-3395	18-3396-1
F225A/LF225A (4.2L)	2010-17	18-45617-1	18-3457	18-3459	18-3482	18-1829	18-9082	18-3470	18-3471
F225B/LF225B (4.2L)	2016-17	18-45617-1	18-3457	18-3459	18-3482	18-1829	18-9082	18-3470	18-3471
F225B/LF225B (3.3L)	2016-17	18-3071	18-3519	18-3345	18-3173-1	18-1835	18-9081	18-3395	18-3396-1

CHART CONTINUED ON NEXT PAGE

YAMAHA 4-STROKE WATER PUMP APPLICATION CHART

HP Model	Year	Impeller	Cup	Plate	Housing	Damper Seal	Water Pump Cover	Kit without Housing	Kit with Housing
VF225 (4.2L)	2009-18	18-3071	18-3519	-	18-3173-1	18-1835	18-9081	18-3474	-
F250 / LF250 (3.3L)	2005	18-3071	18-3519	18-3345	18-3173-1	18-1835	18-9081	18-3395	18-3396-1
F250 / LF250 (3.3L)	2006-11	18-3071	18-3519	18-3518	18-3173-1	18-1835	18-9081	18-3515	-
F250A / LF250A (3.3L)	2010-17	18-3071	18-3519	18-3518	18-3173-1	18-1835	18-9081	18-3515	-
F250A / LF250A (4.2L)	2014-17	18-45617-1	18-3457	18-3459	18-3482	18-1829	18-9082	18-3470	18-3471
F250B / LF250B (3.3L)	2008-09	18-3071	18-3519	18-3518	18-3173-1	18-1835	18-9081	18-3515	-
F250B / LF250B (4.2L)	2016-17	18-45617-1	18-3457	18-3459	18-3482	18-1829	18-9082	18-3470	18-3471
FL250	2010	18-45617-1	18-3457	18-3459	18-3482	18-1829	18-9082	18-3470	18-3471
VF250	2009-18	18-3071	18-3519	-	18-3173-1	18-1835	18-9081	18-3474	-
VF250 (XA Models)	2015-18	18-45617-1	18-3457	18-3459	18-3482	18-1829	18-9082	18-3470	18-3471
F300 / LF300 (5.3L)	2007-09	18-8925	18-3457	18-0421	18-3483	18-1835	18-9081	18-3477	-
F300 / LF300 (4.2L)	2010-18	18-45617-1	18-3457	18-3459	18-3482	18-1829	18-9082	18-3470	18-3471
FL300	2010, 2016	18-45617-1	18-3457	18-3459	18-3482	18-1829	18-9082	18-3470	18-3471
F350 / LF350 (5.3L)	2007-09	18-8925	18-3457	18-0421	18-3483	18-1835	18-9081	18-3477	-
F350A / LF350A (5.3L)	2010-11	18-8925	18-3457	18-0421	18-3483	18-1835	18-9081	18-3477	-
F350B / LF350B (5.3L)	2012-15	18-8925	18-3457	18-0421	18-3483	18-1835	18-9081	18-3477	-
F350C / LF350C (5.3L)	2016-18	18-8925	18-3457	18-0421	18-3483	18-1835	18-9081	18-3477	-
FL350 (5.3L)	2010	18-8925	18-3457	18-0421	18-3483	18-1835	18-9081	18-3477	-

YAMAHA 2-STROKE WATER PUMP APPLICATION CHART

HP Model	Year	Impeller	Cup	Plate	Housing	Damper Seal	Water Pump Cover	Kit without Housing	Kit with Housing
2	1984-87	18-3072	18-3328	18-3357	-	18-3166	-	18-3463	-
2	1988-02	18-3072	18-3328	18-3357	-	18-3166	-	18-3462	-
3	1988-02	18-8911	18-3164	18-3163	-	18-3166	-	-	-
4	1984-99	18-3073	-	-	-	18-3166	-	-	-
5	1984-02	18-3073	-	-	-	18-3166	-	-	-
6	1986-00	18-3066	18-3456	-	-	18-1833	-	18-3460	-
8	1984-09	18-3066	18-3456	-	-	18-1833	-	18-3460	-
9.9	1984-95	18-3074	-	-	-	18-1834	-	18-3148	18-3411
9.9	1996-09	18-3040	18-3444	18-3195	-	18-1833	-	18-3433	18-3412
15	1984-95	18-3074	-	-	-	18-1834	-	18-3148	18-3411
15	1996-09	18-3040	18-3444	18-3195	-	18-1833	-	18-3433	18-3412
20	1996-97	18-3065	-	-	-	-	-	18-3431	-
25	1984-85	18-3067	-	-	-	-	-	-	18-3426
25	1986-87	18-3067	-	-	-	-	-	-	18-3427
25 (2 cyl)	1988-09	18-3065	-	-	-	-	-	18-3431	-
25 (3 cyl)	1997-02	18-3068	-	-	-	-	-	-	-
C25	1981-97	18-3067	-	-	-	-	-	-	18-3427
CV25	1990	18-3067	-	-	-	-	-	-	18-3427
30	1984-85	18-3067	-	-	-	-	-	-	18-3426
30	1986	18-3067	-	-	-	-	-	-	18-3427
30	1987-02	18-3068	18-3435	18-3436	-	-	-	18-3430	-
C30	1991-92	18-3067	-	-	-	-	-	-	18-3427
C30	1993-97	18-3068	18-3443	18-3194	18-3185	BL2-44367-00-00	-	-	18-3432
CV30	1989-90	18-3067	-	-	-	-	-	-	-
40	1984-87	18-3068	18-3435	18-3436	-	-	-	18-3429	18-3408
40	1988-94	18-3068	18-3435	18-3436	-	-	-	18-3429	-
40	1995-05	18-3069	18-3449	18-3186	-	-	-	18-3434	18-3415
C40	1990-91	18-3088	-	-	-	-	-	18-3397	-
C40	1992-97	18-3088	-	-	-	-	-	18-3397	18-3398
C40	1997-03	18-3069	18-3449	18-3186	-	-	-	18-3434	18-3415
P40	1998	18-3069	18-3449	18-3186	-	-	-	18-3434	18-3415
E48	1995-2000	18-3069	-	-	-	-	-	-	-
50	1984-87	18-3068	18-3435	18-3436	-	-	-	18-3429	18-3408
50	1988-94	18-3068	18-3435	18-3436	-	-	-	18-3429	-
50	1995-09	18-3069	18-3449	18-3186	-	-	-	18-3434	18-3415

CHART CONTINUED ON NEXT PAGE

YAMAHA 2-STROKE WATER PUMP APPLICATION CHART

HP Model	Year	Impeller	Cup	Plate	Housing	Damper Seal	Water Pump Cover	Kit without Housing	Kit with Housing
C50	1998-01	18-3069	18-3449	18-3186	-	-	-	18-3434	18-3415
PRO 50	1987	18-3068	18-3435	18-3436	-	-	-	18-3429	18-3408
PRO 50	1988-90	18-3068	18-3435	18-3436	-	-	-	18-3429	-
P50	1991-94	18-3068	18-3435	18-3436	-	-	-	18-3429	-
P50	1995-96	18-3069	18-3449	18-3186	-	-	-	18-3434	-
50 Jet	1986-95	18-3068	-	-	-	-	-	-	-
C55	1991-95	18-3069	18-3435	18-3436	-	-	-	18-3425	-
CV55	1989-90	18-3069	18-3435	18-3436	-	-	-	18-3425	-
60	2001-03	18-3069	18-3435	-	-	-	-	18-3465	-
60	2004-05	18-3070	-	-	18-3171	18-1830	-	18-3370	18-3371
C60	1996-01	18-3069	18-3435	-	-	-	-	18-3465	18-3466
E60	1995-96	18-3069	18-3435	-	-	-	-	18-3465	18-3466
E60	1997-00	18-3069	-	-	-	-	-	-	-
P60	1991	18-3069	18-3435	-	-	-	-	18-3428-1	18-3461
P60	1992-99	18-3069	18-3435	-	-	-	-	18-3465	18-3466
70	1984-91	18-3069	18-3435	-	-	-	-	18-3428-1	18-3481
70	1992-03	18-3069	18-3435	-	-	-	-	18-3465	18-3466
70	2004-09	18-3070	-	-	18-3171	18-1830	-	18-3370	18-3371
C70	2000-01	18-3069	18-3435	-	-	-	-	18-3465	18-3466
C75	1994-99	18-3070	-	-	18-3171	18-1830	-	18-3370	18-3371
E75	1995-00	18-3070	-	-	-	-	-	-	-
P75	1996-99	18-3070	-	-	-	-	-	-	-
C80	1997	18-3070	-	-	-	-	-	-	-
C85	1991-98	18-3070	-	-	18-3171	18-1830	-	18-3370	18-3371
CV85	1989-90	18-3070	-	-	18-3171	18-1830	-	18-3370	18-3371
90	1984-09	18-3070	-	-	18-3171	18-1830	-	18-3370	18-3371
90 Jet	1986-89	18-3070	-	-	-	-	-	-	-
90 Jet	1992-94	18-3071	-	-	-	-	-	-	-
B90	1997-99	18-3070	-	-	-	18-1830	-	-	-
C90	1997-01	18-3070	-	-	18-3171	18-1830	-	18-3370	18-3371
115	2002-09	18-3071	18-3333	18-3344	18-3173-1	18-1835	18-9081	18-3312	18-3313-1
115	1995-01	18-3071	18-3333	18-3344	18-3173-1	18-1835	18-9081	18-3312	18-3313-1
115 (6N6), (6E5)	1984-94	18-3071	-	18-3344	18-3170	18-1835	-	18-3372	18-3373
115 (6N6)	1994	18-3071	18-3333	18-3344	18-3173-1	18-1835	18-9081	18-3312	18-3313-1
B115	1998-99	18-3071	18-3519	18-0408	18-3173-1	18-1835	18-9081	18-4533	-
C115	1991-92	18-3071	-	18-3344	18-3170	18-1835	-	18-3372	18-3373
C115	1993-00	18-3071	18-3333	18-3344	18-3173-1	18-1835	18-9081	18-3312	18-3313-1
P115 (62A)	1993-96	18-3071	18-3333	18-3344	18-3173-1	18-1835	18-9081	18-3312	18-3313-1
S115	1996-99	18-3071	18-3519	18-3344	18-3173-1	18-1835	18-9081	18-3312	18-3313-1
130 (6L1), (6N7)	1988-92	18-3071	-	18-3344	18-3170	18-1835	-	18-3372	18-3373
130 (6N7)	1993-96	18-3071	18-3333	18-3344	18-3173-1	18-1835	18-9081	18-3312	18-3313-1
130	1997-04	18-3071	18-3519	18-3344	18-3173-1	18-1835	18-9081	18-3312	18-3313-1
L130 (6L6), (6N4)	1989-92	18-3071	-	18-3344	18-3170	18-1835	-	18-3372	18-3373
L130 (6N4)	1993-96	18-3071	18-3333	18-3344	18-3173-1	18-1835	18-9081	18-3312	18-3313-1
L130	1997-01	18-3071	18-3519	18-3344	18-3173-1	18-1835	18-9081	18-3312	18-3313-1
S130	1996-99	18-3071	18-3519	18-3344	18-3173-1	18-1835	18-9081	18-3312	18-3313-1
150 (6R2), (6G4)	1984-91	18-3071	-	18-3344	18-3170	18-1835	-	18-3310	18-3311
150 (6R2)	1992-09	18-3071	18-3333	18-3345	18-3173-1	18-1835	18-9081	18-3395	18-3396-1
C150 (6E5)	1996-99	18-3071	18-3333	18-3345	18-3173-1	18-1835	18-9081	18-3395	18-3396-1
D150	1997-98	18-3071	18-3519	18-0408	18-3173-1	18-1835	18-9081	18-4533	-
DX150	1999-05	18-3071	18-3519	18-0408	18-3173-1	18-1835	18-9081	18-4533	-
L150 (6R0), (6K0)	1986-91	18-3071	-	18-3344	18-3170	18-1835	-	18-3310	18-3311
L150 (6R0)	1992-99	18-3071	18-3333	18-3345	18-3173-1	18-1835	18-9081	18-3395	18-3396-1
LX150	1999-01	18-3071	18-3333	18-3345	18-3173-1	18-1835	18-9081	18-3395	18-3396-1
P150	1986-91	18-3071	-	18-3344	18-3170	18-1835	-	18-3310	18-3311
P150	1992-99	18-3071	18-3333	18-3345	18-3173-1	18-1835	18-9081	18-3395	18-3396-1

CHART CONTINUED ON NEXT PAGE

YAMAHA 2-STROKE WATER PUMP APPLICATION CHART

HP Model	Year	Impeller	Cup	Plate	Housing	Damper Seal	Water Pump Cover	Kit without Housing	Kit with Housing
PRO V150 (6J9)	1986-89	18-3071	-	18-3344	18-3170	18-1835	-	18-3310	18-3311
PRO V150D (8N9)	1990	18-3071	-	18-3344	18-3170	18-1835	-	18-3310	18-3311
PX150	1999	18-3071	18-3333	18-3345	18-3173-1	18-1835	18-9081	18-3395	18-3396-1
S150	1996-99	18-3071	18-3333	18-3345	18-3173-1	18-1835	18-9081	18-3395	18-3396-1
SX150	1999-04	18-3071	18-3333	18-3345	18-3173-1	18-1835	18-9081	18-3395	18-3396-1
V150	2000-08	18-3071	18-3333	18-3345	18-3173-1	18-1835	18-9081	18-3395	18-3396-1
VX150	2000-04	18-3071	18-3333	18-3345	18-3173-1	18-1835	18-9081	18-3395	18-3396-1
VZ150	2000-14	18-3071	18-3333	18-3345	18-3173-1	18-1835	18-9081	18-3395	18-3396-1
Z150/LZ150	2000-05	18-3071	18-3333	18-3345	18-3173-1	18-1835	18-9081	18-3395	18-3396-1
175 (6G5)	1984-91	18-3071	-	18-3344	18-3170	18-1835	-	18-3310	18-3311
175 (6R3)	1992-00	18-3071	18-3333	18-3345	18-3173-1	18-1835	18-9081	18-3395	18-3396-1
P175 (62H)	1994-99	18-3071	18-3333	18-3345	18-3173-1	18-1835	18-9081	18-3395	18-3396-1
S175	1996-99	18-3071	18-3333	18-3345	18-3173-1	18-1835	18-9081	18-3395	18-3396-1
V175	2000	18-3071	18-3333	18-3345	18-3173-1	18-1835	18-9081	18-3395	18-3396-1
VZ175	2001-12	18-3071	18-3333	18-3345	18-3173-1	18-1835	18-9081	18-3395	18-3396-1
Z175	2001-05	18-3071	18-3333	18-3345	18-3173-1	18-1835	18-9081	18-3395	18-3396-1
200 (6G6), (6R4)	1984-91	18-3071	-	18-3344	18-3170	18-1835	-	18-3310	18-3311
200 (6R4)	1992-99	18-3071	18-3333	18-3345	18-3173-1	18-1835	18-9081	18-3395	18-3396-1
L200 (6K1), (6R1)	1986-91	18-3071	-	18-3344	18-3170	18-1835	-	18-3310	18-3311
L200	1992-99	18-3071	18-3333	18-3345	18-3173-1	18-1835	18-9081	18-3395	18-3396-1
LX200	1999-01	18-3071	18-3333	18-3345	18-3173-1	18-1835	18-9081	18-3395	18-3396-1
LZ200	2000-12	18-3071	18-3333	18-3345	18-3173-1	18-1835	18-9081	18-3395	18-3396-1
P200	1991-99	18-3071	18-3333	18-3345	18-3173-1	18-1835	18-9081	18-3395	18-3396-1
S200	1996-99	18-3071	18-3333	18-3345	18-3173-1	18-1835	18-9081	18-3395	18-3396-1
SX200	1999-05	18-3071	18-3333	18-3345	18-3173-1	18-1835	18-9081	18-3395	18-3396-1
V200	1996-99	18-3071	18-3333	18-3345	18-3173-1	18-1835	18-9081	18-3395	18-3396-1
VX200	2000-05	18-3071	18-3333	18-3345	18-3173-1	18-1835	18-9081	18-3395	18-3396-1
VZ200	2001-04	18-3071	18-3333	18-3345	18-3173-1	18-1835	18-9081	18-3395	18-3396-1
VZ200	2005-09	18-3071	18-3519	18-3520	18-3173-1	18-1835	18-9081	18-3516	-
Z200	2000-12	18-3071	18-3333	18-3345	18-3173-1	18-1835	18-9081	18-3395	18-3396-1
V6 Special (6G7)	1984-86	18-3071	-	18-3344	18-3170	18-1835	-	18-3310	18-3311
V6 Excel (6K7)	1987-89	18-3071	-	18-3344	18-3170	18-1835	-	18-3310	18-3311
225 (6R5)	1990-91	18-3071	-	18-3344	18-3170	18-1835	-	18-3310	18-3311
225	1992-97	18-3071	18-3333	18-3345	18-3173-1	18-1835	18-9081	18-3395	18-3396-1
L225	1994-99	18-3071	18-3333	18-3345	18-3173-1	18-1835	18-9081	18-3395	18-3396-1
LX225	2000-03	18-3071	18-3333	18-3345	18-3173-1	18-1835	18-9081	18-3395	18-3396-1
S225	1996-99	18-3071	18-3333	18-3345	18-3173-1	18-1835	18-9081	18-3395	18-3396-1
SX225	2000-03	18-3071	18-3333	18-3345	18-3173-1	18-1835	18-9081	18-3395	18-3396-1
V225	1998-99	18-3071	18-3333	18-3345	18-3173-1	18-1835	18-9081	18-3395	18-3396-1
VX225	2000-04	18-3071	18-3333	18-3345	18-3173-1	18-1835	18-9081	18-3395	18-3396-1
VZ225	2003-09	18-3071	18-3519	18-3520	18-3173-1	18-1835	18-9081	18-3516	-
250	1990-95	18-3071	18-3333	18-3345	18-3173-1	18-1835	18-9081	18-3395	18-3396-1
L250	1990-99	18-3071	18-3333	18-3345	18-3173-1	18-1835	18-9081	18-3395	18-3396-1
LX250	2000-03	18-3071	18-3333	18-3345	18-3173-1	18-1835	18-9081	18-3395	18-3396-1
LZ250	2003-05	18-3071	18-3333	18-3345	18-3173-1	18-1835	18-9081	18-3395	18-3396-1
S250	1996-99	18-3071	18-3333	18-3345	18-3173-1	18-1835	18-9081	18-3395	18-3396-1
SX250	2000-03	18-3071	18-3333	18-3345	18-3173-1	18-1835	18-9081	18-3395	18-3396-1
VX250	2002-04	18-3071	18-3333	18-3345	18-3173-1	18-1835	18-9081	18-3395	18-3396-1
VZ250	2003-09	18-3071	18-3519	18-3520	18-3173-1	18-1835	18-9081	18-3516	-
LZ300	2004-06	18-3071	18-3519	-	18-3173-1	18-1835	18-9081	18-3515	-
VZ300	2004-09	18-3071	18-3519	18-3520	18-3173-1	18-1835	18-9081	18-3516	-
Z250	2003-05	18-3071	18-3333	18-3345	18-3173-1	18-1835	18-9081	18-3395	18-3396-1
Z300	2004-06	18-3071	18-3519	-	18-3173-1	18-1835	18-9081	18-3515	-



**18-3524
THERMOSTAT**

Replaces: 6CE-12411-00-00
Fits: F225/LF225 (2010-2016), F250/LF250 (2010-2016), VF250 (2015), F300/LF300 (2010-2016), FL250/FL300 (2010)

50°C



**18-3525
THERMOSTAT**

Replaces: 60V-12411-00
Fits: F115(2005-14), LF115(2005-14), LZ250(2003-05), LZ300(2004-06), VZ200(2005-09), VZ225(2005-09), VZ250(2005-09), VZ300(2005-09), Z250(2003-05), Z300(2004-06)

60°C



**18-3625
THERMOSTAT**
(Seal Included)

Replaces: 6F5-12411-03-00
9.9EL, 9.9ES, 15EL, 15ES (1986-1995), 9.9L, 9.9S, 15L, 15S (1986-1990), 9.9M, 15ML, 15MS, C55EL (1991-1995), C26EL, C40EL (1991-1997), C25ML (1993-1997), C25MS, C40MS, C40PL (1992-1997), C30EL (1991-1992), CV30EL (1989-1990), C40ML (1994-1995), C65TL (1993-1995), CV25EL, CV25EM, CV40EL (1990), CV55EL (1989)

50°C



**18-3623
THERMOSTAT**
(Seal Included)

Replaces: 6E5-12411-02-00
8MSH-0405, 8MSH-0406, 8MSH-0407, 8MSH-0608, 8MSHD-2005

60°C



**18-3632
THERMOSTAT**

Replaces: 67F-12411-01-00
Fits: F75-F250 (2005 & Up)

60°C



**18-3634
THERMOSTAT**

Replaces: 6AW-12411-00-00
Fits: F300/LF300 (2007-09), F350/LF350 (2007-09), F350A/LF350A (2010-11), F350B/LF350B (2012-15), F350C/LF350C (2016-18)



**18-3636
THERMOSTAT**

Replaces: 6DA-12411-01-00
Fits: F150C/LF150C (2017), VF150 (2013-17), VF150A (2018), F175A (2014-18), F175C/LF175C (2017), VF175 (2015-18), F200B/LF200B (2012-18), F200C/LF200C (2013-18)



**18-3637
THERMOSTAT**

Replaces: 6CB-12411-10-00
Fits: VF200LA/VF225LA/VF250LA (2011-18)

60°C



**18-3639
THERMOSTAT**

Replaces: 6EK-12411-00-00
Fits: F115/LF115/VF115 (2014-18)



**18-3641
THERMOSTAT**

Replaces: 6FP-12411-00-00
Fits: F75B (2017-18), F90B (2016-18), VF90A (2018)

50°C



**18-3540
THERMOSTAT**

Replaces: 6E5-12411-30-00
Fits: 9.9-15 (1996-06), 20 (1996-97), 25 (1986-95), 30 3-cyl (1987-91), 40 (1986-05), C40 3-cyl (1998-02), 50 (1986-05), C50 (1989-01), F50 (1987-96), 115 (1984-05), B115 (1998-99), C115 (1991-00), F115 (1993-96), 5115/5130 (1996-98), 130L/130 (1988-05), 150/175/200 (1986-05), C150 (1995-99), D150/DX150 (1997-05), L150/L200 (1986-89), LK150/LX200 (1999-01), P150 (1986-99), PX150 (1999), SX150/SX200 (1999-04), V150 (2000-05), VK150 (2000-05), VZ150/VZ175/VZ200 (2001-05), Z150/Z175/Z200 (2000-05), F200 (1991-93), V200/V225 (1989-99), Vx200/VX225 (2000-05), V6 Special (1984-86), V6 Excel (1987-89), 225 2.6L (1990-97), 250L/250 2.6L (1990-95)
Note: Will not fit 3.1 L

60°C



**18-3541
THERMOSTAT**

Replaces: 66M-12411-01-00
Fits: F6 (2001-05), F8 (2001-05), T8 (2001-05), F9.9 (1985-05), T9.9 (1985-05), T9.9 (1991-05), F15 (1986-05), F25 (1988-05), T25 (2001-05), F30 (2001-05), F40 4-cyl (1999), F40 3-cyl (2000-05), F50 (1995-05), T50 (1996-05), F60 (2002-05), T60 (2003-05), F80 (1999-00), F100 (1999-00)

50°C



**18-3622
THERMOSTAT KIT**

Replaces: 6H3-12411-11-00
60TLR-0405, 70TLR-0405, 70TLR-0406, 70TLR-0407, 70TLR-0408

50°C



**18-3624
THERMOSTAT KIT**

Replaces: 69M-12411-01-00
F2.5MSH-0405, F2.5MSH-0406, F2.5MSH-0407, F2.5MSH0608, F2.5MSHD-2005



18-3608 THERMOSTAT KIT
①18-3608D Display Package
 Fits: 115 (1991-02), C115 (1991-99), P115 (1993-96), S115 (1996-99), 130 (1991-02), L130 (1991-00), S130 (1996-99), 150 (1991-02), C150 (1996-99), L150 (1991-99), P150 (1991-99), S150 (1996-99), V150 (2000-02), Z150 (2001-02), 175 (1991-95, 97), P175 (1994-99), V175 (2000), Z175 (2001-02), 200 (1991-96), L200 (1991-99), P200 (1991-99), S200 (1996-99), V200 (1998-99), Z200 (2001-02), 225 (1991-97), V225 (1998-99)



18-3609 THERMOSTAT KIT
①18-3609D Display Package
 Fits: 25 (1996-98, 2001-02), 40 (1991-99, 01), C40 (1997-02), P40 (1996), 50 (1991-97, 1999-02), C50 (1998-01), P50 (1991-96), L225 (1994-99), S225 (1996-99), 250 (1991-95), L250 (1991-99), S250 (1998-99)

60°C



18-3611 THERMOSTAT KIT
 Fits: 15 (2006), F15 (1998-06), F25 (1999-06), F30 (2001-06), F40 (1999-06), F50 (1996-06), F60 (2002-06), F9.9 (2005-06), T25 (2001-06), T50 (1996-06), T60 (2003-06), T9.9 (2005-06)

— CONTAINS —

Part #	Desc.	O.E. #	Qty.
18-3540	Thermostat	6E5-12411-30-00	1
18-0844	Gasket	688-12414-A1-00	1

— CONTAINS —

Part #	Desc.	O.E. #	Qty.
18-3540	Thermostat	6E5-12411-30-00	1
18-0829	Gasket	61A-12414-A0-00, 6J8-12414-A0-00	1

— CONTAINS —

Part #	Desc.	O.E. #	Qty.
18-3541	Thermostat	68M-12411-01-00	1
18-0835	Gasket	62Y-12414-00-00	1

YAMAHA 2-STROKE THERMOSTAT APPLICATION

HP/Model	Year	Thermostat	Gasket	Thermostat Kit	Qty. Per Engine
4	1986-88	18-3540	—	—	1
4	1989-99	18-3623	—	—	1
5	1995-02	18-3623	—	—	1
6	1986-88	18-3540	—	—	1
6	1989-00	18-3623	—	—	1
8	1986-88	18-3540	—	—	1
8	1989-09	18-3623	—	—	1
9.9	1986-95	18-3625	18-0836	—	1
9.9	1996-09	18-3540	18-0836	—	1
15	1984-85	—	18-0836	—	1
15	1986-95	18-3625	18-0836	—	1
15	1996-09	18-3540	18-0836	—	1
20	1996-97	18-3540	18-0829	18-3609	1
25 (2 cyl)	1984-87	—	18-0232	—	1
25 (2 cyl)	1988-09	18-3540	18-0829	18-3609	1
C25	1991-97	18-3625	18-0232	—	1
CV25	1990	18-3625	18-0232	—	1
30	1984-85	—	18-0232	—	1
30	1986	18-3625	18-0835	—	1
30	1987-88	18-3540	18-0829	18-3609	1
30	1989-91	18-3623	18-0829	—	1
30	1992-02	—	18-0829	—	1
C30	1991-92	18-3625	18-0232	—	1
C30	1993-94, 1996-97	18-3623	18-0232	—	1
40	1984-85	—	18-0829	—	1
40	1986-05	18-3540	18-0829	18-3609	1
C40	1991-97	18-3625	—	—	1
C40	1998-03	18-3540	18-0829	18-3609	1
P40	1996	18-3540	18-0829	18-3609	1
50	1984-85	—	18-0829	—	1
50	1986-09	18-3540	18-0829	18-3609	1
C50	1998-01	18-3540	18-0829	18-3609	1
PRO 50	1987-90	18-3540	18-0829	18-3609	1
P50	1991-96	18-3540	18-0829	18-3609	1
50 Jet	1986-00	18-3540	18-0829	18-3609	1
C55	1991-95	18-3625	—	—	1
CV55	1989-90	18-3625	—	—	1
60	2001-05	Kit Only	18-0835	18-3622	1
C60	1998-01	Kit Only	18-0835	18-3622	1
E60	1995-00	Kit Only	18-0835	18-3622	1
P60	1991-99	Kit Only	18-0835	18-3622	1
70	1984-09	Kit Only	18-0835	18-3622	1

APPLICATION CONTINUED ON NEXT PAGE

YAMAHA 2-STROKE THERMOSTAT APPLICATION

HP/Model	Year	Thermostat	Gasket	Thermostat Kit	Qty. Per Engine
C70	2000-01	Kit Only	18-0835	18-3622	1
C75	1994-99	—	18-0844	—	1
E75	1995-00	—	18-0844	—	1
P75	1996-99	—	18-0844	—	1
C80	1997	—	18-0844	—	1
90	1984-09	—	18-0844	—	1
90 Jet	1986-00	—	18-0844	—	1
B90	1997-99	—	18-0844	—	1
C90	1997-01	—	18-0844	—	1
115	1984-09	18-3540	18-0844	18-3608	2
B115	1998-99	18-3540	18-0844	18-3608	2
C115	1991-00	18-3540	18-0844	18-3608	2
P115	1993-96	18-3540	18-0844	18-3608	2
S115	1996-99	18-3540	18-0844	18-3608	2
130	1988-04	18-3540	18-0844	18-3608	2
L130	1989-01	18-3540	18-0844	18-3608	2
S130	1996-99	18-3540	18-0844	18-3608	2
C150	1996-99	18-3540	18-0844	18-3608	2
150	1984	—	18-0844	—	2
150	1985	18-3623	18-0844	—	2
150	1986-09	18-3540	18-0844	18-3608	2
D150	1997-99	18-3540	18-0844	18-3608	2
DX150	1999-05	18-3540	18-0844	18-3608	2
L150	1988-99	18-3540	18-0844	18-3608	2
LX150	1999-01	18-3540	18-0844	18-3608	2
LZ150	2000-05	18-3540	18-0844	18-3608	2
Z150	2000-05	18-3540	18-0844	18-3608	2
P150	1991-99	18-3540	18-0844	18-3608	2
PX150	1999	18-3540	18-0844	18-3608	2
PRO V150	1986-90	18-3540	18-0844	18-3608	2
S150	1996-99	18-3540	18-0844	18-3608	2
SX150	1999-04	18-3540	18-0844	18-3608	2
V150	2009-08	18-3540	18-0844	18-3608	2
VX150	2000-04	18-3540	18-0844	18-3608	2
VZ150	2000-11	18-3540	18-0844	18-3608	2
175	1984	—	18-0844	—	2
175	1985	18-3623	18-0844	—	2
175	1986-00	18-3540	18-0844	18-3608	2
P175	1994-99	18-3540	18-0844	18-3608	2
S175	1996-99	18-3540	18-0844	18-3608	2
V175	2000	18-3540	18-0844	18-3608	2
VZ175	2001-10	18-3540	18-0844	18-3608	2
Z175	2001-05	18-3540	18-0844	18-3608	2
200	1984	—	18-0844	—	2
200	1985	18-3623	18-0844	—	2
200	1986-98	18-3540	18-0844	18-3608	2
L200	1986-99	18-3540	18-0844	18-3608	2
LX200	1999-01	18-3540	18-0844	18-3608	2
LZ200	2000-11	18-3540	18-0844	18-3608	2
P200	1991-99	18-3540	18-0844	18-3608	2
SX200	1999-05	18-3540	18-0844	18-3608	2
V200	1998-99	18-3540	18-0829	18-3609	2
VX200	2000-05	18-3540	18-0829	18-3609	2
VZ200	2001-04	18-3540	18-0844	18-3608	2
VZ200	2005-09	18-3525	—	—	2
Z200	2000-11	18-3540	18-0844	18-3608	2

APPLICATION CONTINUED ON NEXT PAGE

YAMAHA 2-STROKE THERMOSTAT APPLICATION

HP/Model	Year	Thermostat	Gasket	Thermostat Kit	Qty. Per Engine
V6 Special	1985-86	18-3540	18-0844	18-3608	2
V6 Excel	1987-89	18-3540	18-0844	18-3608	2
225	1990-97	18-3540	18-0844	18-3608	2
L225	1994-99	18-3540	18-0829	18-3609	2
S225	1996-99	18-3540	18-0829	18-3609	2
LX225	2000-03	18-3540	18-0829	18-3609	2
SX225	2000-03	18-3540	18-0829	18-3609	2
V225	1998-99	18-3540	18-0829	18-3609	2
V225	2003-09	18-3525	-	-	2
VX225	2000-04	18-3540	18-0829	18-3609	2
VZ250	2003-09	18-3525	-	-	2
Z50	1990-95	18-3540	18-0829	18-3609	2
L250	1990-99	18-3540	18-0829	18-3609	2
LX250	2000-03	18-3540	18-0829	18-3609	2
S250	1996-99	18-3540	18-0829	18-3609	2
SX250	2000-03	18-3540	18-0829	18-3609	2
VX250	2002-04	18-3540	18-0829	18-3609	2
Z250 / LZ250	2003-05	18-3525	-	-	2
VZ300	2004-09	18-3525	-	-	2
Z300 / LZ300	2004-06	18-3525	-	-	2

YAMAHA 4-STROKE THERMOSTAT APPLICATION

HP/Model	Year	Thermostat	Gasket	Thermostat Kit	Qty. Per Engine
F2.5	2003-17	Kit Only	18-0754	18-3624	1
F4	1999-17	18-3541	18-0754	—	1
F6	2001-08	18-3541	18-99120	—	1
F6	2009-17	18-3541	18-0754	—	1
F6	2001-10	18-3541	18-99120	—	1
F8A	2011-14	18-3541	18-99120	—	1
F8B	2015-18	18-3541	18-99120	—	1
T8	2001-10	18-3541	18-99120	—	1
F9.9	1985-05	18-3541	18-99120	—	1
F9.9 (66N)	2005-06	18-3541	18-0835	18-3611	1
F9.9A	2011-12	18-3541	18-99120	—	1
F9.9B	2013-18	18-3541	18-99120	—	1
F9.9F	2007-10	18-3541	18-99120	—	1
FT9.9	1985-90	18-3541	18-99120	—	1
T9.9	1991-05	18-3541	18-99120	—	1
T9.9 (66R)	2005-06	18-3541	18-0835	18-3611	1
T9.9A	2011-12	18-3541	18-99120	—	1
T9.9B	2013-18	18-3541	18-99120	—	1
T9.9G	2007-10	18-3541	18-99120	—	1
F15	1998-06	18-3541	18-0835	18-3611	1
F25	1998-05	18-3541	18-0835	18-3611	1
F25A	2009-18	18-3541	18-0835	18-3611	1
F25B	2012-18	18-3541	18-0835	18-3611	1
F25	1998-08	18-3541	18-0835	18-3611	1
T25	2001-04	18-3541	18-0835	18-3611	1
T25	2001-08	18-3541	18-0835	18-3611	1
T25	2009-18	18-3541	18-0835	18-3611	1
F30	2001-05	18-3541	18-0835	18-3611	1
F30	2013-18	18-3541	18-0835	18-3611	1
F40	1999-06	18-3541	18-0835	18-3611	1

APPLICATION CONTINUED ON NEXT PAGE

YAMAHA 4-STROKE THERMOSTAT APPLICATION

HP/Model	Year	Thermostat	Gasket	Thermostat Kit	Qty. Per Engine
F40A	2008-18	18-3541	18-0835	18-3611	1
F40B	2007-08	18-3541	18-0835	18-3611	1
F50	1995-18	18-3541	18-0835	18-3611	1
T50	1996-18	18-3541	18-0835	18-3611	1
F60	2002-18	18-3541	18-0835	18-3611	1
T60	2003-18	18-3541	18-0835	18-3611	1
F70A	2010-18	18-3541	18-0835	18-3611	1
F75A	2003-17	18-3632	—	—	1
F75B	2017-18	18-3641	—	—	1
F80	1999-00	18-3541	—	—	1
F80	2001-03	18-3632	—	—	1
F90	2003-11	18-3632	—	—	1
F90A	2012-17	18-3632	—	—	1
F90B	2016-18	18-3641	—	—	1
VF90A	2018	18-3641	—	—	1
F100	1999-00	18-3541	—	—	1
F100	2001-03	18-3632	—	—	1
F115 / LF115	2000-14	18-3525	—	—	1
F115 / LF115	2014-18	18-3639	—	—	1
VF115	2015-18	18-3639	—	—	1
F150 / LF150	2004-11	18-3632	18-99127	—	1
F150A / LF150A	2012-14	18-3632	18-99127	—	1
F150B / LF150B	2015-18	18-3632	18-99127	—	1
F150C / LF150C	2017	18-3636	—	—	1
VF150	2013-17	18-3636	—	—	1
VF150A	2018	18-3636	—	—	1
F175A	2014-18	18-3636	—	—	1
F175C / LF175C	2017	18-3636	—	—	1
VF175	2015-18	18-3636	—	—	1
F200 / LF200	2005-10	18-3632	—	—	2
F200A / LF200A	2011-17	18-3632	—	—	2
F200B / LF200B	2012-18	18-3636	—	—	1
F200C / LF200C	2013-18	18-3636	—	—	1
VF200	2009-10	18-3632	—	—	2
VF200LA	2011-18	18-3637	—	—	2
F225 / LF225	2005-10	18-3632	—	—	2
F225A / LF225A	2011-17	18-3632	—	—	2
F225A / LF225A	2010-17	18-3524	—	—	2
F225B / LF225B	2016-17	18-3524	—	—	2
F225B / LF225B	2008-09	18-3632	—	—	2
VF225	2009-10	18-3632	—	—	2
VF225LA	2011-18	18-3637	—	—	2
F250 / LF250	2005-11	18-3632	—	—	2
F250A / LF250A	2010-17	18-3524	—	—	2
F250B / LF250B	2016-17	18-3524	—	—	2
VF250	2010	18-3632	—	—	2
VF250LA	2011-18	18-3637	—	—	2
VF250XA	2015-17	18-3524	—	—	2
F300 / LF300	2007-09	18-3634	—	—	2
F300A / LF300A	2010-18	18-3524	—	—	2
F350 / LF350	2007-09	18-3634	—	—	2
F350A / LF350A	2010-11	18-3634	—	—	2
F350B / LF350B	2012-15	18-3634	—	—	2
F350C / LF350C	2016-18	18-3634	—	—	2

**ALL PISTONS
ARE SUPPLIED WITH PISTON RINGS, WRIST PIN AND CIRCLIPS**



Piston Rings are available individually.

V-4 & V-6 Pistons and Rings

STANDARD			.25mm O.S.		.50mm O.S.	
18-4128 (Port) Replaces: 6G5-11642-00-93	18-4129 (Stbd.) Replaces: 6G5-11631-00-93		18-4130 (Port)		18-4132 (Port) Replaces: 6G5-11646-01-00	18-4133 (Stbd.) Replaces: 6G5-11636-01-00
— CONTAINS —						
Part #	Rings	O.E. #				
18-3934	Standard	6E5-11610-03-00				

V-6 Loop Charged Engines (1992-2001)

18-4080 (Port) Replaces: 6R5-11642-11-93	18-4081 (Stbd.) Replaces: 6R5-11631-11-93		18-4082 (Port) Replaces: 6R5-11645-11-00	18-4083 (Stbd.) Replaces: 6R5-11635-11-00	18-4084 (Port) Replaces: 6R5-11646-11-00	18-4085 (Stbd.) Replaces: 6R5-11636-11-00
— CONTAINS —						
Part #	Rings	O.E. #				
18-39320	Standard	6R5-11603-00				

★ ★ ★ **Inline Pistons and Rings** ★ ★ ★

STANDARD			.25mm O.S.			.50mm O.S.		
18-4091 Replaces: 6H3-11631-01-96 — CONTAINS —			Part #	Rings	O.E. #	18-4096 Replaces: 6K5-11636-03-00		
Part #	Rings	O.E. #	18-3977	25mm O.S.	682-11610-11-00	18-4146 Replaces: 61N-11636-00-00		
18-3963	Standard	6K5-11601-02-00	18-4142 Replaces: 6H4-11635-01-00			18-4099 Replaces: 6H1-11636-03-00		
18-4135 Replaces: 6E7-11631-00-97 — CONTAINS —			18-4145 Replaces: 61N-11635-00-00 — CONTAINS —					
Part #	Rings	O.E. #	Part #	Rings	O.E. #			
18-3976	Standard	682-11610-01-00	18-3958	25mm O.S.	61N-11604-00-00			
18-4138 Replaces: 689-11631-00-95 — CONTAINS —								
Part #	Rings	O.E. #						
18-3954	Standard	689-11610-01-00						
18-4141 Replaces: 6H4-11631-00-96 — CONTAINS —								
Part #	Rings	O.E. #						
18-3960	Standard	6H4-11610-00-00						
18-4097 Replaces: 6H1-11631-03-95 — CONTAINS —								
Part #	Rings	O.E. #						
18-3969	Standard	688-11603-00-00						

PISTON APPLICATION

HP/Model	Years	PISTON			RINGS		
		Std.	.25mm	.50mm	Std.	.25mm	.50mm
9.9/15	1984-96	18-4135	—	18-4137	18-3976	18-3977	—
9.9/15	1997-2009	18-4135	—	18-4137	18-3976	18-3977	—
25	1985	18-4138	—	—	18-3954	—	—
30	1984-86	18-4138	—	—	18-3954	—	—
C30	1991-92	18-4138	—	—	18-3954	—	—
C30	1993-97	—	18-4145	18-4146	18-3957	—	—
40	1984-88	18-4141	—	—	18-3960	18-3961	18-3962
C40	1997-99,2001-02	—	18-4142	—	18-3960	18-3961	18-3962
P40	1998	—	—	—	18-3960	18-3961	18-3962
E48	1997	18-4097	—	18-4099	18-3969	—	—
50	1984-88	18-4141	—	—	18-3960	18-3961	18-3962
50	1996-97, 1999, 2000,2002-03	18-4141	18-4142	—	18-3960	18-3961	18-3962
C50	1998-99, 2001	—	18-4142	—	18-3960	18-3961	18-3962
P50	1996	—	18-4142	—	18-3960	18-3961	18-3962
Pro50	1987-88	18-4141	—	—	18-3960	—	—
60	2001-05	18-4091	—	—	18-3963	—	—
C60	1996-01	18-4091	—	—	18-3963	—	—
E60 MLH,T,U,V	1995-00	—	—	18-4096	18-3963	—	—
P60	1991-99	18-4091	—	—	18-3963	—	—
70	1984-09	18-4091	—	—	18-3963	—	—
C70	2000-01	18-4091	—	—	18-3963	—	—
75	1994-98	18-4097	—	18-4099	18-3969	—	—
C75	1996	18-4097	—	18-4099	18-3969	—	—

APPLICATION CONTINUED ON NEXT PAGE

PISTON APPLICATION (Cont.)

HP/Model	Years	Std.	PISTON		Std.	RINGS	
			.25mm	.50mm		.25mm	.50mm
C75	1998-99	18-4097	—	18-4099	18-3969	—	—
E75	1996-97	18-4097	—	18-4099	18-3969	—	—
P75	1996-99	18-4097	—	18-4099	18-3969	—	—
C80	1997	18-4097	—	18-4099	18-3969	—	—
C85	1996	18-4097	—	18-4099	18-3969	—	—
90	1994-09	18-4097	—	18-4099	18-3969	—	—
C90	1997-01	18-4097	—	18-4099	18-3969	—	—

V4 & V-6 Engines	Years	PISTON						RINGS	
		Port Std.	Stbd. Std.	Port .25mm	Stbd. .25mm	Port .50mm	Stbd. .50mm	Std.	Std.
115 w/22mm wrist pin	V-4 1984-86	18-4128	18-4129	18-4130	—	18-4132	18-4133	18-3934	18-3936
115 w/22mm wrist pin	V-4 1967-92	18-4128	18-4129	18-4130	—	18-4132	18-4133	18-3934	18-3936
115 w/23mm wrist pin	V-4 1993-03	18-4080	18-4081	18-4082	18-4083	18-4084	18-4085	18-39320	18-3936
130 w/22mm wrist pin	V-4 1984-92	18-4128	18-4129	18-4130	—	18-4132	18-4133	18-3934	18-3936
130 w/23mm wrist pin	V-4 1993-03	18-4080	18-4081	18-4082	18-4083	18-4084	18-4085	18-39320	18-3936
150, 175 w/22mm wrist pin	V-6 1984-92	18-4128	18-4129	18-4130	—	18-4132	18-4133	18-3934	18-3936
150, 175 w/23mm wrist pin	V-6 1993-99	18-4080	18-4081	18-4082	18-4083	18-4084	18-4085	18-39320	18-3936
200, 225 w/22mm wrist pin	V-6 1984-92	18-4128	18-4129	18-4130	—	18-4132	18-4133	18-3934	18-3936
200, 225 w/22mm wrist pin	V-6 1993-99	18-4080	18-4081	18-4082	18-4083	18-4084	18-4085	18-39320	18-3936
SPECIAL J,K,L,N,XN (6G7)	V-6 1984-86	18-4128	18-4129	18-4130	—	18-4132	18-4133	18-3934	18-3936



18-1755 CONNECTING ROD
Replaces: 650-11651-04-00
Fits: 9.9, 15 (1996-97)



18-1756 CONNECTING ROD KIT
Replaces: 688-11650-03-00
Fits: 55 (1991-95), 75 (1994-99), 80 (1997), 85 (1991-96), 90 (1997, 2000-01)



18-1755K CONNECTING ROD KIT
Replaces: 650-11651-04-00
Fits: E336 9.9 (1996-97), 15 (1996-97)



18-4157 CONNECTING ROD
Replaces: 6R5-11650-10-00
For: V6 150/175/200 (1992-03)



18-1410 ROD BEARING
Replaces: 93310-32337-00
Fits: 115 (1983-03), 130 (1983-00, 2002-03), 150 (1992-00, 2002-03), 175 (1992-98, 2000), 200 (1992-98), 225 (1992-93, 1997)



18-1411 ROD BEARING
Replaces: 93310-620V5-00
Fits: 9.9 (1996-97), 15 (1996-97)



18-4077 ROD BEARING
Replaces: 93310-730V8-00
For: 45, 55, 90 HP -3 Cyl.



18-4078 ROD BEARING
Replaces: 93310-836V2-00
For: V4 & V6 (1990 motors)



18-0191 WASHERS
Replaces: 92990-06600-00

18-0192
Replaces: 92990-10600-00, 929-90108-00-00, 92900-10600-00, 92901-10600-00, 92902-10600-00, 92903-10600-00, 92995-10600-00



18-79974 OIL STRAINER
Replaces: 6J8-13411-00
Fits: 20 (1996-97), 25 (1988-01), 30 (1987-02), 40 (1989-05), 50 (1989-09), 60 (2001-05), 70 (1989-09), C30 (1995), P40 (1998), P50 (1991-96), P60 (1991-99), PRO50 (1989-90)



18-79975 OIL STRAINER
Replaces: 6E5-13411-00
Fits: 115 (1988-09), 130 (1988-05), 150 (1989-09), 175 (1989-00), 200 (1989-98), 225 (1990-97), B115 (1998-99), D150 (1997-99), DX150 (1999-05), L130 (1989-01), L150 (1988-99), L200 (1988-99), LX150 (1989-01), LX200 (1989-01), LZ150 (2000-05), LZ200 (1999-12), P115 (1993-96), P150 (1991-99), P175 (1994-99), P200 (1991-99), PRO V150 (1988-90), PX150 (1999), S115 (1996-99), S130 (1996-99), S150 (1996-99), S200 (1996-99), SX150 (1999-04), SX200 (1999-05), V150 (2000-06), V175 (2000), V6 Excel (1988-89), VX150 (2000-04), VZ150 (2000-12), VZ175 (2001-12), VZ200 (2001-04), Z150 (2000-05), Z175 (2001-05), Z200 (2000-12)



18-79976 OIL STRAINER
Replaces: 61A-13411-00
Fits: 225 (1994-95), 250 (1990-95), L225 (1994-99), L250 (1990-99), LX225 (2000-03), LX250 (2000-03), LZ250 (2003-05), LZ300 (2004-06), S225 (1996-99), S250 (1996-99), SX225 (2000-03), SX250 (2000-03), V200 (1998-99), V225 (1998-99), VX200 (2000-05), VX225 (2000-04), VX250 (2002-04), VZ200 (2005-09), VZ225 (2003-09), VZ250 (2003-09), VZ300 (2004-09), Z250 (2003-05), Z300 (2004-06)



18-79971 OIL STRAINER, ELECTRIC
Replaces: 68F-13440-00
Fits: LZ150 (2000-05), LZ200 (2000-12), LZ250 (2003-05), LZ300 (2004-06), VZ150 (2000-12), VZ175 (2001-12), VZ175 (2001-12), VZ200 (2001-09), VZ225 (2003-09), VZ250 (2003-09), VZ300 (2004-09), Z150 (2000-05), Z175 (2001-05), Z200 (2000-12), Z250 (2003-05), Z300 (2004-06)



18-79961 OIL STRAINER
Replaces: 6H1-13411-00
Fits: 90 (1990-01), B90 (1997-99), C90 (2000-01), P75 (1996-99)



18-7911-1 OIL FILTER
Replaces: 5GH-13440-00, 5GH-13440-10, 5GH-13440-30



18-7954 OIL FILTER
Replaces: N26-13440-02-00, N26-13440-00-00
Fits: F350



**18-2456
CRANKCASE OIL
DRAIN PLUG**

Replaces: 90340-14M06-00
Fits: 15-350HP 1995-2018
M14x1.25

**4-CYCLE
OUTBOARD
OIL FILTERS**



**18-8700
OIL FILTER**

Replaces: 5GH-13440-50-00,
5GH-13440-20, 5JW-13400-00-00,
2MB-E3440-00-00,
1WD-E3440-00-00
Fits: F15(2006-12), F20(2006-12),
F25(2009-12), F40(2009-12), F50
(2005-12), F60(2005-12), F70 (2010-
12), T25(2009-12), T50(2005-12), T60
(2005-12)

Make-Model	Years	Replaces	Part No.
F/T8.9	1990-03	6G8-13440-00-00	18-7901
F/T50	1995-99	3FV-13440-20-00, 3FV-13440-00-00	18-7902
F15,F25	1998-99	3FV-13440-20-00, 3FV-13440-00-00	18-7902
F80/F100	1999	3FV-13440-20-00, 3FV-13440-00-00	18-7902
F40	1999-00	3FV-13440-20-00, 3FV-13440-00-00	18-7902
F200/F225	2002-06	69J-13440-00-00, -01-00, -03-00	18-7906-1
F150	2004-06	69J-13440-00-00, -01-00, -03-00	18-7906-1
F250	2005-06	69J-13440-00-00, -01-00, -03-00	18-7906-1
F350	2008-up	N26-13440-02-00, N26-13440-00-00	18-7954



**18-9390
OIL CHANGE KIT**

Replaces: LUB-MRNSM-KT-10
Fits: F30(2001-06), F40(1999-08), F40A(2009 & Up), F50(1995 & Up), T50(1995 & Up), F60(2002 & Up), T60(2003 & Up), F70(2010 & Up)



**18-9391
OIL CHANGE KIT**

Replaces: LUB-MRNM-D-KT-10
Fits: F75(2003 & Up), F80(1999-02), F90(2003 & Up), F100(1999-02), F115(2000 & Up)



**18-9392
OIL CHANGE KIT**

Replaces: LUB-MRNM-D-KT-10
Fits: F150(2004 & Up)



**18-9393
OIL CHANGE KIT**

Replaces: LUB-MRNLG-KT-10
Fits: F200 3.3L(2002 & Up), F225 3.3L(2002 & Up), F225 Sport(2008), F250A 3.3L(2005 & Up), F250B 3.3L (2005 & Up)

TIMING BELTS

FEATURES:

- Neoprene or Nitrile construction for maximum durability based on application
- Positive Slip Proof engagement
- Fiberglass tension member for excellent flex and elongation behavior
- Chemical and Contaminant Resistance for Long Life
- Meets or Exceeds OEM belt specifications
- Modified Curvilinear or Trapezoidal tooth profile for direct OE fitment/replacement
- Recommended periodic maintenance interval of 5 years or 1000 hours of use
(Note: Timing belt should be inspected every 100 hours and replaced as necessary.)
- Inexpensive insurance to prevent catastrophic engine failure



Sierra Timing Belts provide extended durability and smoother performance characteristics required by today's marine engines.

Part No.	Replaces	Fits
18-15130	6C5-46241-00-00	Fits: F25 (2009-2017), T25 (2009-2017), F30 (2013-2017), F40 (2008-2017), F50 (2005-2017), T50 (2005-2010), F60 (2005-2017), T60 (2005-2017), F70 (2010-2017)
18-15131	67F-46241-00-00	Fits: F75 (2003-2011), F80 (1999-2003), F90 (2005-2015), F100 (1999-2003), F115 (2000-2014), LF115 (2000-2014)
18-15132	6P2-46241-02-00	Fits: F200 (2011-2017), LF200 (2011-2017), F225 (2007-2017), F250 (2005-2017), LF250 (2005-2017)
18-15133	6G8-46241-00-00	Fits: F9.9 (1985-2005), FT9.9 (1985-1990), T9.9 (1991-2005)
18-15134	6CB-W4624-00-00	Fits: F225 (2010-2017), LF225 (2010-2017), F250 (2010-2017), FL250 (2010), LF250 (2010-2017), F300 (2010-2017), FL300 (2010), LF300 (2010-2017), VF200 (2009-2017), VF225 (2009-2017), VF250 (2009-2017)
18-15135	65W-46241-00-00	Fits: F25 (1998-2005), T25 (2001-2005), F30 (2001-2005), F40 (2000-2008)
18-15136	6AH-46241-00-00	Fits: F15 (2006-2017), F20 (2006-2017)
18-15137	66M-46241-00-00	Fits: F9.9 (2005-2006), F15 (1998-2005)
18-15138	68T-46241-00-00	Fits: F6 (2001-2008), T6 (2001-2010), F8 (2001-2017), F9.9 (2007-2017), T9.9 (2007-2017)
18-15139	6AW-W4624-00-00	F300/LF300 (5.3L) (2007-09), F350/LF350 (5.3L) (2007-09), F350A/LF350A (5.3L) (2010-11), F350/LF350 (5.3L) (2012-15), F350C/LF350C (2016-18)
18-15140	63P-46241-00-00	F150/LF150 (2004-11), F150/LF150 (2012-14), F150B/LF150B (2015-18)
18-15141	69J-46241-00-00	F200/LF200 (2002-10), F225/LF225 (2002-10)
18-15142	6DA-W4624-00-00	F150C/LF150C (2017-18), VF150 (2013-17), VF150A (2018)
18-15143	60V-46241-00-00	VZ200 (2005-09), VZ225 (2005-09), VZ250 (2005-09), Z250/LZ250 (2003-05), VZ300 (2005-09), Z300/LZ300 (2004-06)
18-15144	62Y-46241-00-00	F40 (1999), F50 (1995-03), T50 (1996-04), F60 (2002-04), T60 (2003-04)
18-15145	68F-46241-10-00	VZ150 (2004-14), Z150/LZ150 (2004-05)

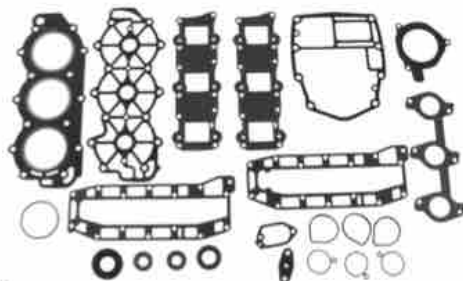

**18-99061
GASKET SET**

Replaces: 63D-W0001-00
Fits: 40(1995-05), 50(1995-06/9), C40(1997-02), C50(1998-01), P40(1998), P50(1995-96)



**18-99073
GASKET SET**

Replaces: 65W-W0001-20
Fits: F25(1998-00)

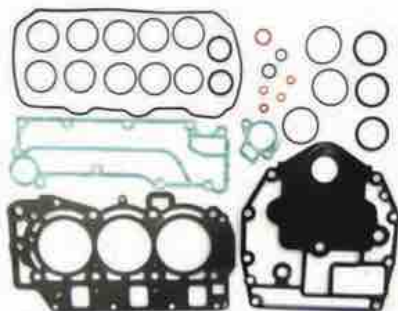

**18-99092
GASKET SET**

Replaces: 67C-W0001-00
Fits: F30(2001), F40(2000-01)



**18-99093
GASKET SET**

Replaces: 67C-W0001-20
Fits: F30(2001), F40(2000-01), T25(2001)

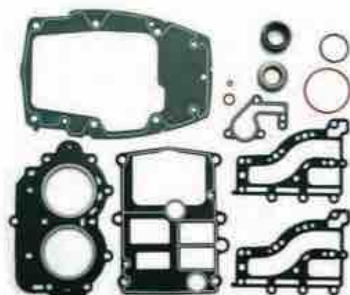

**18-99097
GASKET SET**

Replaces: 682-W0001-06
Fits: 9.9(1994-95), 15(1994-95)



**18-99103
GASKET SET**

Replaces: 68F-W0001-01
Fits: LZ150(2004-05), LZ200(2004-10), VZ150(2004-10),
VZ175(2004-10), VZ200(2004), Z150(2004-05), Z175(2004-05),
Z200(2004-10)



**18-99104
GASKET SET**

Replaces: 6A0-W0001-21
Fits: C40(1992-94)

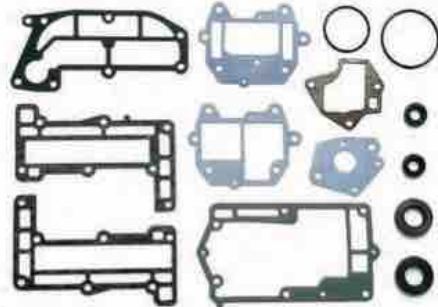

**18-99117
GASKET SET**

Replaces: 6G1-W0001-A2
Fits: 6(1996), 8(1996)

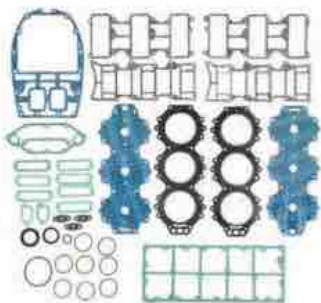

**18-4400
POWERHEAD GASKET SET**

Replaces: 61A-W0001-01-00, 61A-W0001-A1-00
— CONTAINS —

Part #	Desc.	O.E. #	Qty.
18-3891	Head Gasket	61A-11181-00-A0	2
18-0829	O-Ring	61A-12414-A0-00, 6J8-12414-A0-00	2
18-0806	Pressure Control Valve Gasket	6G5-11392-A1-00	1

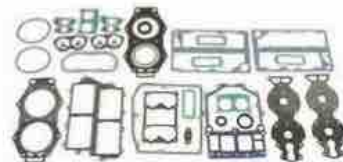

**18-4403
POWERHEAD GASKET SET**

Replaces: 6F3-W0001-04-00, 6F3-W0001-A4-00
— CONTAINS —

Part #	Desc.	O.E. #	Qty.
18-3832	Head Gasket	6E5-11181-02-00	2
18-0844	Thermostat Cover Gasket	688-12414-A1-00	2
18-2079	Oil Seal	93101-22M18-00	1
18-2085	Oil Seal	93102-35M13-00	1
18-7442	O-Ring	93210-74M35-00	1
18-7444	O-Ring	93211-04384-00	2
18-0782	Cover Gasket	6E5-11381-A1-00	2
18-0799	Exhaust Cover Gasket	6E5-41112-A1-00	2
18-0823	Exhaust Manifold Gasket	6E5-13645-A1-00	1
18-0785	Carb Mounting Gasket	6E5-14198-A1-00	2
18-0813	Powerhead Base Gasket	6G5-45113-A0-00	2
18-2592	Float Bowl Gasket	6E5-14384-03-00	1
18-0781	Water Jacket Gasket	6E5-11193-A0-00	2

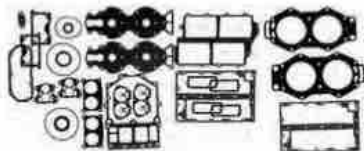

**18-4411
POWERHEAD GASKET SET**

Replaces: 6N6-W0001-03-00, 6N6-W0001-A3-00
— CONTAINS —

Part #	Desc.	O.E. #	Qty.
18-3832	Head Gasket	6E5-11181-02-00	2
18-0844	Thermostat Cover Gasket	688-12414-A1-00	2
18-2079	Oil Seal	93101-22M18-00	1
18-2085	Oil Seal	93102-35M13-00	1
18-7442	O-Ring	93210-74M35-00	1
18-7444	O-Ring	93211-04384-00	2
18-0782	Cover Gasket	6E5-11381-A1-00	1
18-0799	Exhaust Cover Gasket	6E5-41112-A1-00	2
18-0823	Exhaust Manifold Gasket	6E5-13645-A1-00	1
18-0785	Carb Mounting Gasket	6E5-14198-A1-00	2
18-0813	Powerhead Base Gasket	6G5-45113-A0-00	1
18-2592	Float Bowl Gasket	6E5-14384-03-00	2
18-0781	Water Jacket Gasket	6E5-11193-A0-00	2



**18-4405
POWERHEAD GASKET SET**

Replaces: 6H1-W0001-00-00, 6H1-W0001-01-00, 6H1-W0001-A0-00
— CONTAINS —

Part #	Desc.	O.E. #	Qty.
18-3805	Head Gasket	688-11181-02-00	1
18-0840-1	O-Ring	676-14984-00-00	3
18-0844	Thermostat Cover Gasket	688-12414-A1-00	1
18-0847	Exhaust Cover Gasket	688-41112-A0-00	1
18-0826	Drain Screw Gasket	90430-14115-00	1
18-7436	O-Ring	93210-46044-00	3
18-0767	Water Jacket Cover Gasket	688-11193-01-00	1

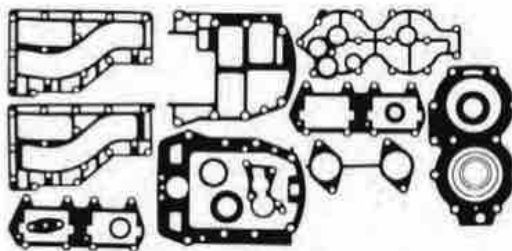

**18-4413
POWERHEAD GASKET SET**

Replaces: 6R6-W0001-01-00

— CONTAINS —

Part #	Desc.	O.E. #	Qty.
19-3892	Head Gasket	676-11181-00-A0	1
18-7126	O-Ring	—	1

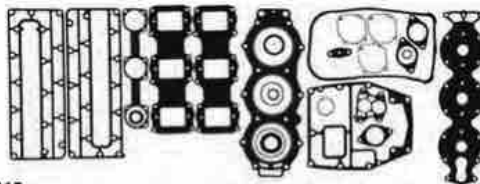

**18-4415
POWERHEAD GASKET SET**

Replaces: 688-W0001-00-00, 688-W0001-A0-00

— CONTAINS —

18-0840	Fuel Bowl Seal	676-14984-00-00	3
18-3805	Head Gasket	688-11181-02-00	1
18-0844	Thermostat Cover Gasket	688-12414-A1-00	1
18-0846	Carburetor Mounting Gasket	688-14198-A1-00	3
18-0847	Exhaust Cover Gasket	688-41112-A0-00	2
18-0826	Drain Screw Gasket	90430-14115-00-00	1
18-0767	Water Jacket Cover Gasket	688-11193-01-00	1
18-0845	Intake Manifold Reed Plate Gasket	688-13621-A1-00	2
18-7441	O-Ring	93210-62269-00	1

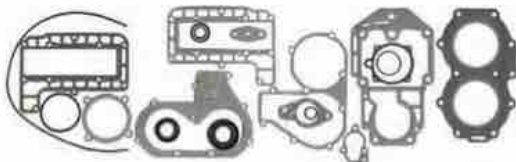

**18-4417
POWERHEAD GASKET SET**

Replaces: 695-W0001-01-00, 695-W0001-02-00, 695-W0001-A2-00

— CONTAINS —

Part #	Desc.	O.E. #	Qty.
18-0231	Packing Gasket	648-13621-A1-00	1
18-0771	Intake Manifold Gasket	648-13645-A0-00	1
18-0775	Carburetor Mounting Gasket	648-14198-A0-00	1
NSS	Bowl Gasket	648-14384-01-00	1
18-0232	Cover Gasket	655-12414-A1-00	1
18-0250	Exhaust Cover Gasket	664-41114-A0-00	2
18-2078	Oil Seal	93101-16M36-00	1
18-0570	Oil Seal	93102-23096-00	1
18-3849	Head Gasket	695-11181-A0-00	1
18-0739	Upper Casing Gasket	689-45113-A1-00	1

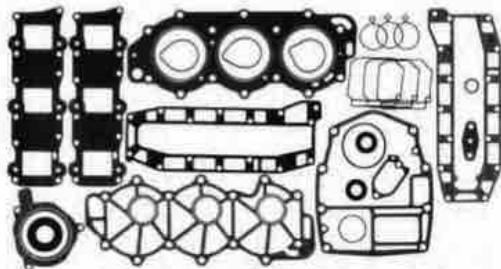

**18-4419
POWERHEAD GASKET SET**

Replaces: 6H4-W0001-02-00, 6H4-W0001-A2-00

— CONTAINS —

Part #	Desc.	O.E. #	Qty.
18-3830	Head Gasket	6H4-11181-00-00	1
18-0826	Drain Screw Gasket	90430-14115-00-00	1



**18-99175
POWERHEAD GASKET SET**

Replaces: 63V-W0001-00, 63V-W0001-01

Fits: 9.9(1996-00), 15(1996-00)

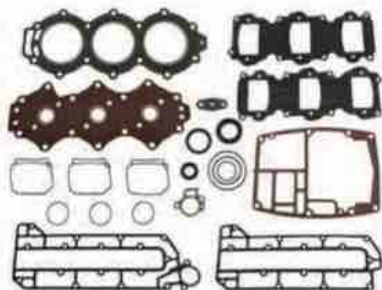

**18-99176
POWERHEAD GASKET SET**

Replaces: 6H3-W0001-02

Fits: 60(2001-05), 70(1994-09), C70(2000-01), P60(1994-99)



**18-4427
POWERHEAD GASKET SET**

Replaces: 6H3-W0001-A0-00

 <p>18-0663 PLENUM GASKET KIT Fits: Yamaha F75 (2003-04), F80 (1999-03), F90 (2003-04), F100 (1999-02)</p>	 <p>18-99048 HEAD GASKET Replaces: 60V-11181-00 Fits: LZ250(2003-05), VZ200(2005-09), VZ225(2003-09), VZ250(2003-09), Z250(2003-05)</p>	 <p>18-99059 HEAD GASKET Replaces: 63D-11193-A0 Fits: 40(1995-05), 50(1995-09), C40(1997-03), C50(1998-01), P40(1998), P50(1995-96)</p>	
 <p>18-99060 HEAD GASKET Replaces: 63D-11181-A1 Fits: 40(1997-05), 50(1997-08), C40(1997-03), C50(1998-01), P40(1998)</p>	 <p>18-99062 HEAD GASKET Replaces: 68F-11181-00 Fits: LZ150(2000-05), LZ200(2000-10), VZ150(2000-10), VZ175(2001-10), VZ200(2001-04), Z150(2000-05), Z175(2001-05), Z200(2000-10)</p>	 <p>18-99094 HEAD GASKET Replaces: 67F-11181-02 Fits: F75(2004-05), F90(2004-05), F115(2004-05), LF115(2004-05)</p>	 <p>18-3804 HEAD GASKET Replaces: 689-11181-02-00, 689-W0001-A1-00</p>
 <p>18-3805 HEAD GASKET Replaces: 688-11181-02-00, 688-11181-A1-00</p>	 <p>18-3827 HEAD GASKET Replaces: 6G8-11181-00-00, 6G8-11181-A1-00</p>	 <p>18-3828 HEAD GASKET Replaces: 6E7-11181-00-00, 6E7-11181-A1-00</p>	 <p>18-3829 HEAD GASKET Replaces: 6J8-11181-00-00, 6J8-11181-A1-001</p>
 <p>18-3830 HEAD GASKET Replaces: 6H4-11181-00-00, 6H4-11181-A1-00</p>	 <p>18-3831 HEAD GASKET Replaces: 6H3-11181-01-00, 6H3-11181-A1-00</p>	 <p>18-3832 HEAD GASKET Replaces: 6E5-11181-02-00, 6E5-11181-A1-00</p>	
 <p>18-3847 HEAD GASKET Replaces: 6L2-11181-A1-00, 6L2-11181-A2-00</p>	 <p>18-3848 HEAD GASKET Replaces: 697-11181-A0-00, 697-11181-A1-00</p>	 <p>18-3849 HEAD GASKET Replaces: 695-11181-A0-00, 695-11181-A1-00</p>	
 <p>18-3891 HEAD GASKET Replaces: 61A-11181-A0-00, 61A-11181-A1-00</p>	 <p>18-3892 HEAD GASKET Replaces: 676-11181-A0-00, 676-11181-A1-00</p>	 <p>18-3894 HEAD GASKET Replaces: 6G5-11181-00-00, 6G5-11181-A0-00</p>	

SEE PAGES 219 FOR OUR COMPLETE LINE OF GASKET SEALANTS
APPLICATION BEGINS ON NEXT PAGE

POWERHEAD GASKET SETS / HEAD GASKETS APPLICATION

HP	Year	Powerhead Gasket Set	Head Gasket	HP	Year	Powerhead Gasket Set	Head Gasket
6	1988-96	18-99117		F80	1999-01		18-99094
8	1984-96	18-99117		F80	2002-03		18-99094
9.9	1984-87		18-3828	C85	1991	18-4415	18-3805
9.9	1988-91		18-3828	C85	1992-93		18-3805
9.9	1992-93		18-3828	C85	1994-96		18-3805
9.9	1994-95		18-3828	CV85	1989-90	18-4415	18-3805
9.9	1996	18-99175		90	1984-93	18-4405	18-3805
9.9	1997-00	18-99175	18-99140	90	1994-09		18-3805
9.9	2001-08		18-99140	B90	1997-99		18-3805
F9.9	1986-89		18-3827	C90	1997-01		18-3805
F9.9	1990-05		18-3827	F90	2003-04		18-99094
FT9.9	1985-87		18-3827	F90	2005-11		18-99094
FT9.9	1988-89		18-3827	F100	1999-01		18-99094
FT9.9	1990		18-3827	F100	2002-03		18-99094
T9.9	1991-05		18-3827	115	1984		18-3832
15	1984-87		18-3828	115	1985		18-3832
15	1988-91		18-3828	115	1986 1		18-3832
15	1992-93		18-3828	115	1988-89 2	18-4403	18-3832
15	1994-95	18-99097		115	1980-99	18-4411	18-3832
15	1996	18-99175		115	2000-01		18-3832
15	1997-00	18-99175	18-99140	115	2002-09		18-3832
15	2001-08		18-99140	B115	1998-99		18-3832
20	1996-97		18-3847	C115	1991-95	18-4403	18-3832
25 (2 cyl)	1984-87		18-3804	C115	1996-99		18-3832
25 (2 cyl)	1988-93		18-3847	C115	2000		18-3832
25 (2 cyl)	1994-09		18-3847	F115	2000-01		18-99094
25 (3 cyl)	1997-02		18-3829	F115	2002-05		18-99094
C25	1991-93	18-4417	18-3849	F115	2006-11		18-99094
C25	1994-97		18-3849	LF115	2000-01		18-99094
CV25	1990	18-4417	18-3849	LF115	2002-05		18-99094
F25	1998-01	18-99073		LF115	2006-11		18-99094
30	1984-86		18-3804	P115	1993-96	18-4411	18-3832
30	1987-94		18-3829	S115	1996-99	18-4411	18-3832
30	1993-02		18-3829	130	1988-99	18-4403	18-3832
C30	1991-92		18-3804	130	2000-01		18-3832
G30	1995-97		18-3829	130	2002-04		18-3832
CV30	1989-90		18-3804	L130	1989	18-4403	18-3832
F30	2000	18-99093		L130	1990-99	18-4411	18-3832
F30	2001-05	18-99092		L130	2000-01		18-3832
40	1984-88		18-3830	S130	1996-99	18-4411	18-3832
40	1989-91	18-4419	18-3830	150	1984-89		18-3894
40	1992-94		18-3830	150	1990-95		18-3894
40	1995-05	18-99061	18-99060	150	1996-03		18-3894
C40 2 Cyl	1991		18-3892	150	2004-09		18-3894
C40 2 Cyl	1992-93	18-4413	18-3892	C150	1996-99		18-3894
C40 2 Cyl	1994-97	18-4414	18-3892	D150	1997-99		18-3894
C40 3 Cyl	1998-03	18-99061	18-99060	DX150	1999-03		18-3894
CV40	1990		18-3892	DX150	2004-05		18-3894
F40	2000-08	18-99092		L150	1986-89		18-3894
P40	1998	18-99061	18-99060	L150	1990-95		18-3894
50	1984-88		18-3830	L150	1996-99		18-3894
50	1989-91	18-4419	18-3830	LX150	1999-01		18-3894
50	1992-94	18-4419	18-3830	LZ150	2000-03		18-99062
50	1995-09	18-99061	18-99060	LZ150	2004-05	18-99103	18-99062
C50	1998-01	18-99061	18-99060	Z150	2000-03		18-99062
PRO 50	1987-88		18-3830	Z150	2004-05	18-99103	18-99062
PRO 50	1989-90	18-4419	18-3830	P150	1991-93		18-3894
P50	1991	18-4419	18-3830	P150	1994-95		18-3894
P50	1992-94		18-3830	P150	1996-99		18-3894
P50	1995-96	18-99061	18-99060	PX150	1999		18-3894
C55	1991		18-3848	PRO V150	1987-89		18-3894
C55	1992-93		18-3848	PRO V150	1990		18-3894
C55	1994-95		18-3848	S150	1996-99		18-3894
CV55	1989-90		18-3848	SX150	1999-03		18-3894
60	2001-05	18-99176	18-3831	SX150	2004		18-3894
C60	1996-01		18-3831	V150	2000-03		18-3894
E60	1995-00		18-3831	V150	2004-08		18-3894
P60	1991	18-4427	18-3831	VX150	2000-03		18-3894
P60	1992-93		18-3831	VX150	2004		18-3894
P60	1994-99	18-99176	18-3831	VZ150	2000-03		18-99062
70	1984-91	18-4427	18-3831	VZ150	2004-11	18-99103	18-99062
70	1992-93		18-3831	175	1984-89		18-3894
70	1994-09	18-99176	18-3831	175	1990-95		18-3894
C70	2000-01	18-99176	18-3831	175	2000		18-3894
C75	1994-96		18-3805	P175	1996-99		18-3894
C75	1998-99		18-3805	S175	1996-99		18-3894
E75	1995-00		18-3805	V175	2000		18-3894
F75	2003-04		18-99094	VZ175	2001-02		18-99062
F75	2005, 2007-11		18-99094	VZ175	2003-11	18-99103	18-99062
F75	2006		18-99094	Z175	2001-03		18-99062
P75	1996-99		18-3805	Z175	2004-05	18-99103	18-99062
C80	1997		18-3805	200	1984-89		18-3894

① LJ-357803/XJ-700843

② 2.6 litre engine

③ LJ: 357804/XJ: 700844

④ 3.1 litre engine

HP	Year	Powerhead Gasket Set	Head Gasket	HP	Year	Powerhead Gasket Set	Head Gasket
200	1990-95		18-3894	L225 ④	1994-96	18-4400	18-3891
200	1996-98		18-3894	L225	1997-99		18-3891
L200	1986-89		18-3894	S225	1996	18-4400	18-3891
L200	1990-95		18-3894	S225	1997-99		18-3891
L200	1996-99		18-3894	LX225	2000-03		18-3891
LX200	1999-01		18-3894	SX225	2000-03		18-3891
LZ200	2000-03		18-99062	V225	1998-99		18-3891
LZ200	2004-11	18-99103	18-99062	VX225	2000-04		18-3891
P200	1991-95		18-3894	VZ225	2003-04		18-99048
P200	1996-99		18-3894	VZ225	2005-09		18-99048
S200	1996-99		18-3894	250	1990-95	18-4400	18-3891
SX200	1999-03		18-3894	L250	1990-96	18-4400	18-3891
SX200	2004-05		18-3894	L250	1997-99		18-3891
V200	1998-99		18-3891	LX250	2000-03		18-3891
VX200	2000-05		18-3891	LZ250	2003-04		18-99048
VZ200	2000-03		18-99062	LZ250	2005		18-99048
VZ200	2004-09	18-99103	18-99062	S250	1996	18-4400	18-3891
Z200	2000-03		18-99062	S250	1997-99		18-3891
Z200	2004-11	18-99103	18-99062	SX250	2000-03		18-3891
V6 Special	1984-86		18-3894	VZ250	2003-04		18-99048
V6 Excel	1987-89		18-3894	VZ250	2005-09		18-99048
225 ②	1990-95		18-3894	Z250	2003-04		18-99048
225	1996-97		18-3894	Z250	2005		18-99048
225 ①	1994-95	18-4400	18-3891				

- ① LJ-357803/XJ-700843
② LJ: 357804/XJ: 700844

- ③ 2.6 litre engine
④ 3.1 litre engine

 <p>18-0406 WATER PUMP GASKET Replaces: 60X-43315-A0-00 Fits: VZ200 (3.3L) 2005-10, VZ225 (3.3L) 2003-10, VZ250 (3.3L) 2003-10, VZ300 (3.3L) 2005-10</p>	 <p>18-0605 EXHAUST MANIFOLD SEAL Replaces: 67F-41138-00-00 Fits: F75 2003-Current; F80 1999-2003; F90 2003-Current; F100 1999-2003; F115 2000-Current.</p>	 <p>18-0617 EXHAUST SEAL Replaces: 67F-45127-00-00 Fits: F75 2003-Current; F80 1999-2003; F90 2003-Current; F100 1999-2003; F115 2000-Current.</p>	 <p>18-0618 EXHAUST MANIFOLD GASKET Replaces: 68V-45123-00-00</p>
 <p>18-0619 EXHAUST TUBE SEAL Replaces: 69J-41138-00-00</p>	 <p>18-0656 EXHAUST TUBE SEAL Replaces: 69J-45123-00-00</p>	 <p>18-0755 CRANKCASE DRAIN GASKET Replaces: 90430-14M09-00, 904-30142-28-00, 90430-14228-00 Fits: Four-Stroke 9.9hp - 300hp / 1999 - Current</p>	 <p>18-0849 FUEL PUMP MOUNTING GASKET Replaces: 650-24431-A0-00</p>
 <p>18-0856-1 GASKET Replaces: 64D-14384-01-00</p>	 <p>18-99000 EXHAUST MANIFOLD GASKET Replaces: 61A-41134-A0 Fits: 225(1994-95), 250(1992-95), L225 (1994-99), L250(1992-99), LX225(2000-03), LX250(2000-03), LZ250(2003-05), LZ300 (2004-05), S225(1996-99), S250(1996-99), SX225(2000-03), SX250(2000-03), V200(1998-99), V225(1998-99), VX200(2000-05), VX250 (2000-04), VZ200(2005), VZ225(2003-05), VZ250(2003-05), VZ300(2004-05), Z250(2003-05), Z300(2004-05)</p>	 <p>18-99001 UPPER CASING GASKET Replaces: 61A-45114-A0 Fits: 225(1994-95), 250(1992-95), L225 (1994-99), L250(1992-99), LX225(2000-03), LX250(2000-03), S225(1996-99), S250 (1996-99), SX225(2000-03), SX250 (2000-03), V200(1998-99), V225(1998-99), VX200(2000-05), VX225(2000-04), VX250(2002-04)</p>	 <p>18-99002 EXHAUST MANIFOLD GASKET Replaces: 62Y-41133-00 Fits: F25(1998-00), F40(1999), F50(1995-00), T50(1996-00)</p>
 <p>18-99003 EXHAUST GASKET Replaces: 62Y-41134-01 Fits: F30(2002-05), F40(2002-09), F50(2002-04), F60(2002-04), T25(2002-05), T50(2002-04)</p>	 <p>18-99004 UPPER CASING GASKET Replaces: 63D-45114-A0 Fits: 40(1995-05), 50(1995-09), C40(1997-03), C50(1998-01), P40(1998), P50(1995-96)</p>	 <p>18-99005 MUFFLER GASKET Replaces: 63D-45123-00 Fits: 40(1995-05), 50(1995-09), C40(1997-03), C50(1998-01), P40(1998), P50(1995-96)</p>	 <p>18-99006 EXHAUST MANIFOLD GASKET Replaces: 63V-41133-A1 Fits: 9.9(1997-09), 15(1997-09)</p>

SEE PAGE 219 FOR OUR COMPLETE LINE OF GASKET SEALANTS



18-99008
EXHAUST
MANIFOLD GASKET
Replaces: 64J-41133-10
Fits: F40(2008-10), F60(2002-04), T25(2009-10), T60(2003-04)



18-99009
MUFFLER GASKET
Replaces: 663-45123-00
Fits: (1985-84), (1984-84), C55(1991-95), CV55(1989-90), E48(1995-00), F40(1999), F50(1995-04), P50(1991-94), PR50(1989), PRO 50(1987-90), T50(1996-04)



18-99010
EXHAUST
MANIFOLD GASKET
Replaces: 664-41134-A0
Fits: C25(1992-97), C30(1992-97)



18-99012
EXHAUST
MANIFOLD GASKET
Replaces: 66M-41133-00
Fits: F15(1996-04)

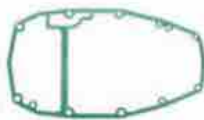

18-99013
UPPER
CASING GASKET
Replaces: 66M-45113-00
Fits: F9.9 (2005-06), F15(1999-05), T9.9(2005-06)



18-99014
EXHAUST
MANIFOLD GASKET
Replaces: 676-41133-A0
Fits: C40(1992-97)

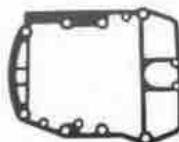

18-99015
UPPER
CASING GASKET
Replaces: 676-45114-A0
Fits: C40(1991-97), CV40(1990)



18-99016
EXHAUST
MANIFOLD GASKET
Replaces: 67C-41133-00
Fits: F25(2001-05, 2009-10), F30(2001-05), F40(2000-08), F50(2001-04), T25(2005-06)



18-99017
MUFFLER GASKET
Replaces: 67C-45123-00
Fits: F30(2001-05), F40(2000-10), F60(2002-04), T25(2001-06, 2009-10), T60(2003-04)



18-99018
EXHAUST
MANIFOLD GASKET
Replaces: 67F-41133-A1
Fits: F75(2003-10), F90(2004-10), F115(2004-10), LF115(2004-10)



18-99019
EXHAUST
MANIFOLD GASKET
Replaces: 67F-41134-A0
Fits: F75(2003-10), F80(1999-03), F90(2003-10), F100(1999-03), F115(2000-10), LF115(2000-10)



18-99020
MUFFLER GASKET
Replaces: 67F-45123-00
Fits: F75(2003-10), F80(1999-03), F90(2003-10), F100(1999-03)



18-99021
EXHAUST
MANIFOLD GASKET
Replaces: 682-41133-A0
Fits: 9.9(1992-95), 15(1992-95)



18-99022
UPPER
CASING GASKET
Replaces: 682-45113-A1
Fits: 9.9(1984-95), 15(1984-95)



18-99023
EXHAUST
MANIFOLD GASKET
Replaces: 688-41133-00
Fits: 90(1984-09), B90(1997-99), C75(1994-96, 98-99), C80(1997), C85(1991-96), C90(1997-01), CV85(1989-90), E75(1995-00), P75(1996-99)

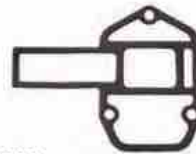

18-99024
EXHAUST
MANIFOLD GASKET
Replaces: 688-41134-A0
Fits: 90(1984-09), B90(1997-99), C75(1994-99), C80(1997), C85(1991-96), C90(1997-01), CV85(1989-90), E75(1995-00), P75(1996-99)

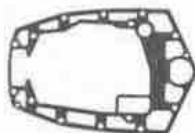

18-99025
UPPER
CASING GASKET
Replaces: 688-45114-A1
Fits: 90(1984-09), B90(1997-99), C75(1994-99), C80(1997), C85(1991-96), C90(1997-01), CV85(1989-90), E75(1995-00), P75(1996-99)





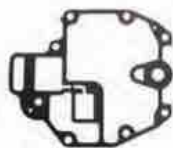



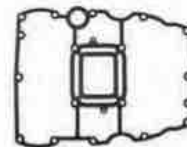





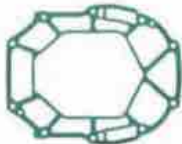





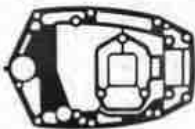

18-99026
MUFFLER GASKET
Replaces: 688-45123-00
Fits: 90(1984-09), B90(1997-99), C75(1994-99), C80(1997), C85(1991-96), C90(1997-01), CV85(1989-90), E75(1995-00), P75(1996-99)



18-99027
OIL PAN GASKET
Replaces: 68T-13475-00
Fits: F8(2001-08), F8(2001-10), F9.9(2007, 2010), T8(2001-10), T8.9(2007-10)



18-99028
OIL PAN GASKET
Replaces: 68V-15312-00
Fits: F75(2003-10), F90(2004-10), F115(2004-10), LF115(2004-10)

 <p>18-99030 UPPER CASING GASKET Replaces: 697-45114-A0 Fits: E48(1995-00), C55(1992-95)</p>	 <p>18-99032 EXHAUST MANIFOLD GASKET Replaces: 69J-41134-A0 Fits: F200(2002-05), F225(2002-05), LF200(2002-05), LF225(2002-05)</p>	 <p>18-99033 EXHAUST MANIFOLD GASKET Replaces: 69J-41135-A0 Fits: F200(2002-10), F225(2002-10), F250(2005-10), LF200(2002-10), LF225(2002-10), LF250(2005-10)</p>	 <p>18-99034 EXHAUST MANIFOLD GASKET Replaces: 69J-41136-A0 Fits: F200(2002-05), F225(2002-05), F250(2005), LF200(2002-05), LF225(2002-05), LF250(2005)</p>	
 <p>18-99037 EXHAUST MANIFOLD GASKET Replaces: 6E5-41134-A0 Fits: 115(1992-09), 130(1992-04), B115(1998-99), C115 (1992-00), L130(1994-01), P115(1993-96), S115(1996-99), S130(1996-99)</p>	 <p>18-99038 EXHAUST MANIFOLD GASKET Replaces: 6E5-41135-A0 Fits: 115(1992-09), 130(1992-04), 150(1992-09), 175(1992-95), 2000, 200 (1992-98), 225(1992-97), B115(1998-99), C115(1992-00), C150(1996-99), D150(1997-99), DX150(1999-05), L150(1992-01), L200(1992-99), LX150 (1999-01), LX200(1999-01), LZ150(2000-05), LZ200(2000-10), P115(1993-96), P150(1992-99), P175(1994-99), P200(1992-99), PX150 (1999), S115 (1996-99), S130(1996-99), S150(1996-99), S175(1996-99), S200(1996-99), SX150(1999-04), SX200(1999-05), V150(2000-08), V175(2000), VX150(2000-04), VZ150(2000-10), VZ175(2001-10), VZ200(2001-04), Z150(2000-05), Z175(2001-05), Z200(2000-10)</p>	 <p>18-99039 EXHAUST MANIFOLD GASKET Replaces: 6G5-41134-A1 Fits: 115(2003-04), 130(2003-04), 150 (2003-09), DX150(2003-05), LZ150(2003-05), LZ200(2003-10), SX150(2003-04), SX200(2003-05), V150(2003-08), VX150 (2003-04), VZ150(2003-10), VZ175(2003-10), VZ200(2003-04), Z150(2003-05), Z175(2003-05), Z200(2003-10)</p>	 <p>18-99040 UPPER CASING GASKET Replaces: 6G5-45114-A1 Fits: 115(2003-09), 130(2003-04), 150(2003-09), DX150(2003-05), LZ150(2003-05), LZ200(2003-10), SX150(2003-04), SX200(2003-05), V150(2003-08), VX150(2003-04), VZ150(2003-10), VZ175(2003-10), VZ200(2003-04), Z150(2003-05), Z175(2003-05), Z200(2003-10)</p>	
 <p>18-99045 UPPER CASING GASKET Replaces: 6G8-45113-A1 Fits: F8.9(1997-05), T8.9(1995-05)</p>	 <p>18-99046 UPPER CASING GASKET Replaces: 6H3-45114-A1 Fits: 60(2002-05), 70(1984-069), C60(1996-01), C70(2001-02), E60(1995-00), P60(1991-99)</p>	 <p>18-99047 MUFFLER GASKET Replaces: 6H3-45123-00 Fits: 60(2001-05), 70(1984-09), C60(1996-01), C70(2000-01), E60(1995-00), P60(1991-99)</p>	 <p>18-99049 REED GASKET Replaces: 60V-13621-A0 Fits: LZ250(2003-05), LZ300(2004-06), VZ200(2005-09), VZ225(2003-09), VZ250(2003-09), VZ300(2004-09), Z250(2003-05), Z300(2004-06)</p>	 <p>18-99050 INTAKE GASKET Replaces: 60V-13645-00 Fits: LZ250(2003-05), LZ300 (2004-06), VZ200(2005-09), VZ225(2003-09), VZ300(2004-09), Z250(2003-05), Z300(2004-06)</p>
 <p>18-99051 VALVE COVER GASKET Replaces: 61A-11193-A1 Fits: L225(1996-99), L250(1996-99), LX225(2000-03), LX250(2000-03), S225(1996-99), S250(1996-99), SX225(2000-03), SX250(2000-03), V200(1998-99), V225(1998-99), V200(1998-99), V225(1998-99), VX200(2000-05), VX225(2000-04), VX250(2000-04)</p>	 <p>18-99052 SIDE COVER GASKET Replaces: 61A-11381-A0 Fits: 225(1994-95), 250(1992-95), L225(1994-99), L250(1992-99), LX225(2000-03), LX250(2000-03), S225(1996-99), S250(1996-99), SX225(2000-03), SX250(2000-03), V200(1998-99), V225(1998-99), VX200(2000-05), VX225(2000-04), VX250(2002-04)</p>	 <p>18-99053 INTAKE GASKET Replaces: 61A-13621-A0 Fits: 225(1994-95), 250(1992-95), DX150(1999-05), L225(1994-99), L250(1992-99), LX150(1999-01), LX225(2000-03), LX250(2000-03), LX150(1999-01), LX225(2000-03), LX250(2000-03), LX150(2000-05), LZ200(2000-10), PX150(1999), S225(1996-99), S250(1996-99), SX150(1999-04), SX200(1999-05), SX225(2000-03), SX250(2000-03), V200(1998-99), V225(1998-99), VX150(2000-04), VX200(2000-05), VX225(2000-04), VX250(2002-04), VZ150(2000-10), VZ175(2001-10), VZ200(2001-04), Z150(2000-05), Z175(2001-05), Z200(2000-10)</p>	 <p>18-99054 INTAKE GASKET Replaces: 61A-13645-00 Fits: 225(1994-95), 250(1990-95), L225(1994-96), L250(1990-96), S225(1996), S250(1996)</p>	
 <p>18-99055 MANIFOLD GASKET Replaces: 61A-13646-00 Fits: 225(1994-95), 250(1990-95), L225(1994-96), L250(1990-96), S225(1996), S250(1996)</p>	 <p>18-99056 BASE GASKET Replaces: 61A-45113-A0 Fits: 225(1994-95), 250(1990-95), L225(1994-99), L250(1990-99), LX225(2000-03), LX250(2000-03), S225(1996-99), S250(1996-99), SX225(2000-03), SX250(2000-03), V200(1998-99), V225(1998-99), VX200(2000-05), VX225(2000-04), VX250(2002-04)</p>	 <p>18-99057 VALVE COVER GASKET Replaces: 61T-11193-A1 Fits: C30(1993-97)</p>	 <p>18-0242 VALVE SEAT GASKET Replaces: 663-13622-00-00, 663-13622-A0-00</p>	



18-99064
INTAKE GASKET

Replaces: 64E-13645-A0
Fits: 150(1996-99), 200(1996-98), 225(1996-97), D150(1997-99), L150(1996-99), L200(1996-99), P150(1996-99), P175(1996-99), P200(1996-99), S150(1996-99), S175(1996-99), V150(2000-08), V175(2000)



18-99066
INTAKE GASKET

Replaces: 65L-13645-00
Fits: DX150(1999-05), L225(1997-99), L250(1997-99), LX150(1999-01), LX200(1999-01), LX225(2000-03), LX250(2000-03), LZ150(2000-05), LZ200(2000-10), PX150(1999), S225(1997-99), S250(1997-99), SX150(1999-04), SX200(1999-05), SX225(2000-03), SX250(2000-03), V200(1998-99), V225(1998-99), VX150(2000-04), VX200(2000-05), VX225(2000-04), VX250(2002-04), VZ150(2000-10), VZ175(2001-10), VZ200(2001-04), Z150(2000-05), Z175(2001-05), Z200(2000-10)



18-99067
INTAKE GASKET

Replaces: 65L-13646-00
Fits: DX150(1999-05), L225(1997-99), L250(1997-99), LX150(1999-01), LX200(1999-01), LX225(2000-03), LX250(2000-03), LZ150(2000-05), LZ200(2000-10), PX150(1999), S225(1997-99), S250(1997-99), SX150(1999-04), SX200(1999-05), SX225(2000-03), SX250(2000-03), V200(1998-99), V225(1998-99), VX150(2000-04), VX200(2000-05), VX225(2000-04), VX250(2002-04), VZ150(2000-10), VZ175(2001-10), VZ200(2001-04), Z150(2000-05), Z175(2001-05), Z200(2000-10)



18-99063
LOWER CASING GASKET

Replaces: 63V-45315-A0
Fits: 9.9(1996-09), 15(1996-09), F9.9(2005-06), F15(1998-05), T9.9(2005-06)



18-99068
BREATHER COVER GASKET

Replaces: 65W-11169-00
Fits: F25(1998-01), T25(2001)



18-99069
BASE GASKET

Replaces: 65W-11351-00
Fits: F25(1998-02), T25(2001-02)

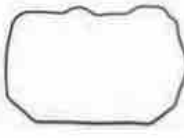

18-99070
CRANKCASE GASKET

Replaces: 65W-11356-00
Fits: F25(1998-05), T25(2001-06)



18-99071
GASKET

Replaces: 65W-14457-10
Fits: F25(1999-05), T25(2001-06)

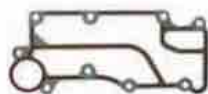

18-99072
EXHAUST GASKET

Replaces: 65W-41114-00
Fits: F25(1998-05), T25(2001-06)



18-99074
BASE GASKET

Replaces: 66M-11351-10
Fits: F9.9(2005-06), F15(2005), T9.9(2005-06)



18-99075
CYLINDER COVER GASKET

Replaces: 66M-11356-00
Fits: F9.9(2005-06), F15(1998-05), T9.9(2005-06)



18-99076
WATER PUMP GASKET

Replaces: 66M-13329-10
Fits: F9.9(2005-06), F15(2001-05), T9.9(2005-06)



18-99078
GASKET

Replaces: 66M-41138-00
Fits: F15(1998-04)



18-99079
UPPER CASING GASKET

Replaces: 66M-45115-00
Fits: F9.9(2005-06), F15(1998-05), T9.9(2005-06)



18-99080
INTAKE GASKET

Replaces: 676-13646-A0
Fits: C40(1991-97), CV40(1990)



18-99082
WATER PUMP GASKET

Replaces: 676-44315-A1
Fits: C40(1991-97), CV40(1990)



18-99083
WATER PUMP GASKET

Replaces: 676-44324-A0
Fits: C40(1991-97), CV40(1990)



18-99084
EXHAUST GASKET

Replaces: 676-45127-00
Fits: C40(1991-97), CV40(1990)



18-99085
EXHAUST GASKET

Replaces: 676-45128-00
Fits: C40(1991-97), CV40(1990)



18-99086
WATER PUMP GASKET

Replaces: 679-44316-A0
Fits: C40(1991-97), CV40(1990)







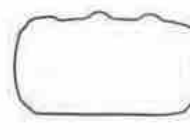













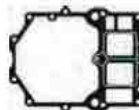

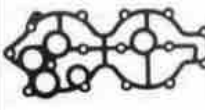
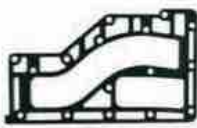

18-99087
LOWER CASING GASKET

Replaces: 679-45315-A0
Fits: C40(1991-94), CV40(1990)

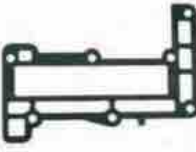

18-99088
CYLINDER COVER GASKET

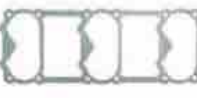
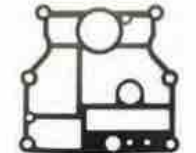
Replaces: 67C-11356-00
Fits: F30(2001-05), F40(2000-08)

 <p>18-99089 EXHAUST GASKET Replaces: 67C-41114-00 Fits: F30(2001), F40(2000-01)</p>	 <p>18-99091 GASKET Replaces: 67C-45113-00 Fits: F25(2001), F30(2001), F40(2000-01), I25(2001)</p>	 <p>18-99095 BASE GASKET Replaces: 682-11351-A0 Fits: 9.9(1984-95), 15(1984-95)</p>	 <p>18-99096 GASKET Replaces: 682-41112-A1 Fits: 9.9(1984-95), 15(1984-95)</p>	 <p>18-60508 THERMOSTAT GASKET Replaces: 60V-12414-A0-00 Fits: Yamaha LZ250(2003-05), LZ300(2004-06), VZ200(2005-09), VZ225(2003-09), VZ250(2003-09), VZ300(2004-09), Z250(2003-05), Z300(2004-06)</p>
 <p>18-99098 INTAKE GASKET Replaces: 688-13621-A1 Fits: 90(1992-09), B90(1997-99), C75(1994-99), C80(1997), C85(1992-96), C90(1997-01), E75(1995-00), P75(1996-99)</p>	 <p>18-99099 VALVE COVER GASKET Replaces: 68F-11193-01 Fits: LZ150(2000-05), LZ200(2000-08), VZ150(2000-08), VZ175(2001-08), VZ200(2001-04), Z150(2000-05), Z175(2001-05), Z200(2000-08)</p>	 <p>18-99100 GASKET Replaces: 68F-11381-00 Fits: LZ150(2000-05), LZ200(2000-10), VZ150(2000-10), VZ175(2001-10), VZ200(2001-04), Z150(2000-05), Z175(2001-05), Z200(2000-10)</p>	 <p>18-99101 EXHAUST GASKET Replaces: 68F-41114-00 Fits: LZ150(2000-05), LZ200(2000-10), VZ150(2000-10), VZ175(2001-10), VZ200(2001-04), Z150(2000-05), Z175(2001-05), Z200(2000-10)</p>	 <p>18-99102 BASE GASKET Replaces: 68F-45113-00 Fits: 150(2004-08), DX150(2004-05), LZ150(2000-05), LZ200(2000-08), SX150(2004), SX200(2004-05), V150(2004-08), VX150(2004), VZ150(2000-08), VZ175(2001-08), VZ200(2001-04), Z150(2000-05), Z175(2001-05), Z200(2000-08)</p>
 <p>18-99105 INTAKE GASKET Replaces: 6E5-13621-A1 Fits: 115(1992-09), 130(1992-04), 150(1992-09), 175(1992-95, 2000), 200(1992-98), B115(1998-99), C115(1992-00), C150(1996-99), L130(1992-01), L150(1992-99), L200(1992-98), P115(1993-96), P150(1993), S115(1996-99), S130(1996-99), S150(1996-99), S175(1996-99), S200(1996-99)</p>	 <p>18-99106 VALVE COVER GASKET Replaces: 6E9-11193-A0 Fits: C40(1991-97), CV40(1990)</p>	 <p>18-99107 EXHAUST GASKET Replaces: 6E9-41114-A0 Fits: C40(1992-97)</p>	 <p>18-99108 VALVE COVER GASKET Replaces: 6G1-11193-A1 Fits: 6(1986-00), 8(1984-09)</p>	 <p>18-99109 REED GASKET Replaces: 6G1-13621-A1 Fits: 6(1991-00), 8(1991-09)</p>
 <p>18-99110 INTAKE GASKET Replaces: 6G1-13645-A1 Fits: 6(1991-00), 8(1991-09)</p>	 <p>18-99111 INTAKE GASKET Replaces: 6G1-14198-A1 Fits: 6(1986-00), 8(1984-09)</p>	 <p>18-99112 EXHAUST GASKET Replaces: 6G1-41112-A1 Fits: 6(1986-00), 8(1984-09)</p>	 <p>18-99113 EXHAUST GASKET Replaces: 6G1-41114-A0 Fits: 6(1991-00), 8(1991-09)</p>	 <p>18-99114 EXHAUST GASKET Replaces: 6G1-41133-A0 Fits: 6(1992-00), 8(1992-09)</p>
 <p>18-99115 BASE GASKET Replaces: 6G1-45113-A1 Fits: 6(1986-00), 8(1984-09)</p>	 <p>18-99116 WATER PUMP GASKET Replaces: 6G1-45315-A0 Fits: 6(1986-00), 8(1984-09)</p>	 <p>18-99118 CARBURETOR GASKET Replaces: 6G5-14483-A1 Fits: C150(1996-99)</p>	 <p>18-99119 BASE GASKET Replaces: 6G8-11351-A0 Fits: F9.9(1985-05), FT9.9(1985-90), T9.9(1991-05)</p>	 <p>18-99120 THERMOSTAT GASKET Replaces: 6G8-12414-A0 Fits: F6(2001-04), F8(2001-04), F9.9(1985-05, 2007, 2010), FT9.9(1985-90), T8(2001-04), T9.9(1991-05, 2007-10)</p>

SEE PAGE 219 FOR OUR COMPLETE LINE OF GASKET SEALANTS



**18-99121
INTAKE GASKET**
Replaces: 6G8-13646-A0
Fits: F9.9(1985-05), FT9.9(1985-90), T9.9(1991-05)



**18-99122
INTAKE GASKET**
Replaces: 6G8-14198-A0
Fits: F9.9(1992-05), T9.9(1992-05)



**18-99123
GASKET**
Replaces: 6G8-15374-00
Fits: F9.9(1985-05), FT9.9(1985-90), T9.9(1991-05)



**18-99124
THERMOSTAT GASKET**
Replaces: 6H3-12414-A1
Fits: 60(2001-05), 70(1984-09), C60(1996-01), C70(2000-01), E60(1995-00), P60(1991-99)



**18-99125
INTAKE GASKET**
Replaces: 6H3-13622-00
Fits: 70(1985-91), P60(1991)



**18-99126
INTAKE GASKET**
Replaces: 6H3-14198-01
Fits: 70(1984-91), P60(1991)



**18-99128
EXHAUST GASKET**
Replaces: 6H3-41114-A0
Fits: 60(2001-05), 70(1992-09), C60(1996-01), C70(2000-01), E60(1995-00), P60(1992-99)

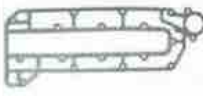

**18-99129
EXHAUST GASKET**
Replaces: 6H3-41112-A0
Fits: 60(2001-05), 70(1986-09), C60(1996-01), C70(2000-01), E60(1995-00), P60(1991-99)



**18-99130
EXHAUST GASKET**
Replaces: 6H3-45113-A0
Fits: 60(2001-025), 70(1984-09), C60(1996-01), C70(2000-01), E60(1995-00), P60(1991-99)



**18-99132
REED GASKET**
Replaces: 6H4-13621-A1
Fits: 40(1984-05), 50(1984-09), C40(1997-03), C50(1998-01), P40(1998), P50(1991-96), PR50(1989), Pro 50(1987-90)

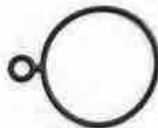

**18-99133
GASKET**
Replaces: 6H4-14198-01
Fits: 40(1989-05), 50(1989-09), C40(1997-03), C50(1998-01), P40(1998), P50(1991-96), PR50(1989), Pro 50(1989-90)



**18-99134
END CAP GASKET**
Replaces: 6H4-15369-A1
Fits: 40(1984-01), 50(1984-09), C40(1997-03), C50(1998-01), P40(1998), P50(1991-96), PR50(1989), Pro 50(1987-90)



**18-99135
EXHAUST GASKET**
Replaces: 6H4-41112-A0
Fits: 40(1992-05), 50(1992-09), C40(1997-03), C50(1998-01), P40(1998), P50(1992-96)



**18-99136
INTAKE GASKET**
Replaces: 6K7-13646-A1
Fits: 225(1990-95), P150(1994-95), P175(1994-95), P200(1992-95), V6 Excel(1987-89)



**18-99137
EXHAUST GASKET**
Replaces: 6L2-41133-A2
Fits: 25(2004-08)



**18-99138
WATER PUMP GASKET**
Replaces: 6L2-45315-A0
Fits: 20(1996-97), 25(1992-09)



**18-99139
INTAKE GASKET**
Replaces: 6OV-13646-00
Fits: LZ250(2003-05), LZ300(2004-06), VZ200(2005-09), VZ225(2003-09), VZ250(2003-09), VZ300(2004-09), Z250(2003-05), Z300(2004-05)



**18-99140
HEAD GASKET**
Replaces: 63V-11181-A1, 63V-11181-A2
Fits: 9.9(1997-08), 15(1997-08)



**18-99141
COVER GASKET**
Replaces: 6H3-11193-A1
Fits: 60(2001-05), 70(1984-09), C60(1996-01), C70(2000-01), E60(1995-00), P60(1991-99)



**18-99142
THERMOSTAT GASKET**
Replaces: 6E9-12414-A0, 6E9-12414-A1
Fits: C40(1992-97)



**18-99143
VALVE SEAL GASKET**
Replaces: 6H3-13621-A1
Fits: 60(2001-05), 70(1992-09), C60(1996-01), C70(2000-01), E60(1995-00), P60(1992-99)



**18-99144
MIXING COVER GASKET**
Replaces: 6E7-14227-00
Fits: 9.9(1984-95), 15(1984-95)







**18-99145
CARBURETOR GASKET**
Replaces: 677-14198-00, 677-14198-A1
Fits: 9.9(1984-91), 15(1984-91)

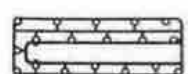

**18-99147
FUEL PUMP GASKET**
Replaces: 6G1-24431-01
Fits: 3(1990-02), 6(1990-00), 8(1990-09), 9.9(1996-09), 15(1996-09)

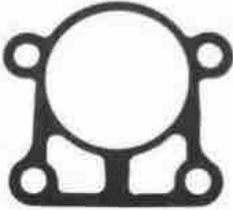

**18-99148
OUTER EXHAUST COVER GASKET**
Replaces: 688-41114-A0
Fits: 90(1992-09), 90(1998-99), C75(1994-99), C80(1997), C85(1992-96), C90(1997-01), E75(1995-00), P75(1996-99)

 <p>18-99149 WATER PUMP GASKET Replaces: 663-44316-A0 Fits: 25(1997-02), 30(1992-01), 40(1992-94), 50(1992-94), C30(1995), C55(1992-95), E48(1995-00), P50(1992-94)</p>	 <p>18-99150 UPPER CASING GASKET Replaces: 63V-45113-A1 Fits: 9.9(1997-09), 15(1997-09)</p>	 <p>18-99151 UPPER CASING GASKET Replaces: 688-45113-A0 Fits: 90(1984-09), B90(1997-99), C75(1994-99), C80(1997), C85(1991-96), C90(1997-01), C85(1989-90), E75(1995-00), P75(1996-99)</p>	
 <p>18-99152 LOWER CASING GASKET Replaces: 683-45315-A0 Fits: 9.9(1984-95), 15(1984-95), F9.9(1986-05)</p>	 <p>18-0765 FLOAT CHAMBER GASKET Replaces: 6L2-14384-00-00</p>	<p>PKG. OF 2</p>  <p>18-0775 18-0775-9Ⓢ CARB MOUNTING GASKET Replaces: 648-14198-A0-00</p>	 <p>18-0785 CARB MOUNTING GASKET Replaces: 6E5-14198-A1-00</p>
 <p>18-0786 FLOAT CHAMBER GASKET Replaces: 6E5-14384-02-00</p>	 <p>18-2592 FLOAT BOWL GASKET Replaces: 6E5-14384-03-00 For: V-4 Outboards: 115, 130, 150, 175, 200, 225 (1986-96) V-6 Special & Excel (1986-89)</p>	 <p>18-0840-1 FLOAT CHAMBER GASKET Replaces: 676-14984-00-00</p>	 <p>18-0807-1 REED PLATE GASKET Replaces: 6K7-13645-A1-00</p>
 <p>18-0809 REED BLOCK GASKET Replaces: 6G5-13645-A1-00</p>	 <p>18-64415 O: SENSOR KIT Replaces: 68F-W1135-00-00 Fits: Yamaha DX150(2001-05), LX150(2001), LX200(2001), LX225(2001-02), LX250(2001-02), LZ150(2000-05), LZ200(2000-12), SX150(2001-04), SX200(2001-05), SX225(2001-02), SX250(2001-02), VX150(2001-04), VX200(2001-02), VX225(2001-02), VZ150(2000-14), VZ175(2001-12), VZ200(2001-04), Z150(2000-05), Z175(2001-05), Z200(2000-12)</p>	 <p>18-0808 PRESSURE CONTROL VALVE GASKET Replaces: 6G5-11382-A1-00</p>	

SEE PAGE 219 FOR OUR COMPLETE LINE OF GASKET SEALANTS

Ⓢ Priced per Package

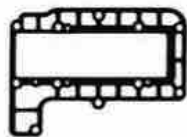

18-0250
EXHAUST COVER GASKET
Replaces: 664-41114-A0-00

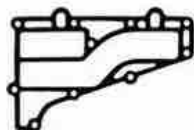

18-0743
INNER EXHAUST COVER GASKET
Replaces: 6L2-41112-A1-00

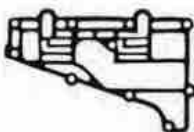

18-0744
OUTER EXHAUST COVER GASKET
Replaces: 6L2-41114-A1-00

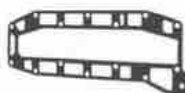

18-0798
EXHAUST COVER GASKET
Replaces: 6H4-41114-A0-00



18-0799
EXHAUST COVER GASKET
Replaces: 6E5-41112-A1-00



18-0812
EXHAUST COVER GASKET
Replaces: 6G5-41112-A1-00



18-0823
EXHAUST MANIFOLD GASKET
Replaces: 6E5-13645-A1-00



18-0847
EXHAUST COVER GASKET
Replaces: 688-41112-A0-00
Fits: 90 HP



18-0739
UPPER CASING GASKET
Replaces: 689-45113-A1-00



18-0813
POWERHEAD BASE GASKET
Replaces: 6G5-45113-A0-00



18-0232
COVER GASKET
Replaces: 655-12414-A1-00



18-0782
COVER GASKET
Replaces: 6E5-11381-A1-00



18-0829
COVER GASKET
Replaces: 61A-12414-A0-00
6J8-12414-A0-00



18-99127
THERMOSTAT GASKET
Replaces: 63P-12414-00-00
Fits: F150/LF150 (2004-11), F150A/LF150A (2012-14), F150B/LF150B (2015-16)



18-0754
THERMOSTAT GASKET
Replaces: 68D-E2414-A0-00
Fits: F2.5MSH-0405, F2.5MSH-0406, F2.5MSH-0407, F2.5MSH0609, F2.5MSHD-2007



18-0835
THERMOSTAT GASKET
Replaces: 62Y-12414-00-00
Fits: F 9.9, T9.9 (2005-06), 15 (2006), F15, F25 (1998-06), T25, F30 (2001-06), F40 4cyl (1999), F40 3cyl (2000-06), F50 (1999-06), T50 (1996-06), F80 (2002-06), T60 (2003-06)



18-0836
THERMOSTAT GASKET
Replaces: 682-12414-A1-00
Fits: 9.9, 15 (1984-06)



18-0844
THERMOSTAT GASKET
Replaces: 688-12414-A1-00
Fits: 90 HP V-4, V-6



18-0767
WATER JACKET GASKET
Replaces: 688-11193-01-00
Fits: 90 HP



18-0779
WATER JACKET GASKET
Replaces: 6G5-11193-A0-00



18-0781
WATER JACKET GASKET
Replaces: 6E5-11193-A0-00

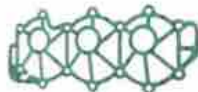

18-0815
WATER JACKET GASKET
Replaces: 6H4-11193-A1-00

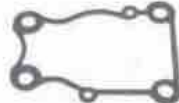









18-0483
PUMP CASE GASKET
Replaces: 63D-44316-00-00
Fits: 40 (1995-04), 50 (1995-97, 1999-04)

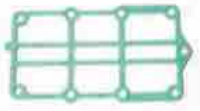
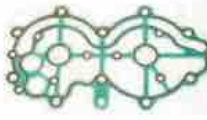

18-0753
WATER PUMP GASKET
Replaces: 6G1-44315-A0-00
Fits: 6 (1986-00), 8 (1984-05)



18-0239
WATER PUMP GASKET
Replaces: 688-44315-A0-00

 <p>18-3458 WATER PUMP GASKET Replaces: 6CE-44315-00-00 Fits: F225 (2010-15), F250 (2010), F250 (2010-15), F300 (2007-15), F350 (2007-15), FL250 (2010), FL300 (2010), FL350 (2010), LF225 (2010-15), LF250 (2010-15), LF300 (2007-15), LF350 (2007-15), VF250 (2015)</p>	 <p>18-60512 BREATHER GASKET Replaces: 68D-E1169-A0-00 Fits: Yamaha F4(2002-08)</p>	 <p>18-60521 CYLINDER COVER GASKET Replaces: 69M-11196-A0-00 Fits: Yamaha F2.5(2003-14), F4(1999-14), F6(2009-14)</p>	 <p>18-60529 EXHAUST MANIFOLD GASKET Replaces: 66T-41133-A0-00 Fits: Yamaha T40/T30 Enduro Series</p>	 <p>18-63966 CYLINDER HEAD GASKET Replaces: 66M-11181-10-00 Fits: Yamaha F9.9(2005-06), F15(2005-06), T9.9(2005-06)</p>
 <p>18-60522 CYLINDER COVER GASKET Replaces: 66T-11181-A0-00 Fits: Yamaha F2.5(2003-14), F4(1999-14), F6(2009-14)</p>	 <p>18-60518 CRANKCASE GASKET Replaces: 68D-11351-A0-00 Fits: Yamaha F4(2002-08)</p>	 <p>18-60519 CRANKCASE GASKET Replaces: 68D-E1193-A0-00 Fits: Yamaha F4(2002-08)</p>	 <p>18-60530 EXHAUST OUTER COVER GASKET Replaces: 66M-41114-01-00 Fits: Yamaha F9.9(2005-06), F15(2005-06), T9.9(2005-06)</p>	 <p>18-60523 CYLINDER COVER GASKET Replaces: 69M-11181-00-00 Fits: Yamaha F2.5(2003 & Up)</p>
 <p>18-60527 ENGINE GASKET Replaces: 67D-45113-A0-00 Fits: Yamaha F4(1999-08)</p>	 <p>18-60532 EXHAUST OUTER COVER GASKET Replaces: 66T-41114-A0-00 Fits: Yamaha T40/T30 Enduro Series</p>	 <p>18-60520 CYLINDER COVER GASKET Replaces: 66T-11193-A0-00 Fits: Yamaha T40/T30 Enduro Series</p>	 <p>18-60528 ENGINE GASKET Replaces: 66T-45113-A0-00 Fits: Yamaha T40/T30 Enduro Series</p>	 <p>18-60534 MANIFOLD GASKET Replaces: 66M-13645-00-00 Fits: Yamaha F9.9(2005-06), F15(1998-06), T9.9(2005-06)</p>
 <p>18-60535 MANIFOLD GASKET Replaces: 65W-13645-00-00 Fits: F25(1998-05), T25(2001-06)</p>	 <p>18-60540 THERMOSTAT GASKET Replaces: 676-12414-A0-00 For: Yamaha T40/T30 Enduro Series</p>	 <p>18-60541 WATER PUMP COVER GASKET Replaces: 6BX-G4315-01-00 Fits: F4(2009-14), F6(2009-14)</p>	 <p>18-0240 WATER PUMP GASKET Replaces: 688-44316-A0-00</p>	
 <p>18-0244 WATER PUMP GASKET Replaces: 6E5-44315-A0-00</p>	 <p>18-0292 WEAR PLATE TO PUMP HOUSING GASKET Replaces: 663-44315-A0-00</p>	<p>PKG. OF 2</p>  <p>18-0294 18-0294-9① WEAR PLATE TO PUMP BASE GASKET Replaces: 663-44324-A0-00</p>	 <p>18-0756-1 WATER PUMP GASKET Replaces: 6H3-44315-A0-00</p>	



18-60513
BREATHER GASKET
Replaces: 66M-11357-00-00
Fits: Yamaha F9.9(2005-06), F15(1998-06), T9.9(2005-06)



18-0757
OUTER PLATE GASKET
Replaces: 6H3-44324-A0-00

PKG. OF 2



18-0768
18-0768-9[Ⓢ]
WEAR PLATE GASKET
Replaces: 682-44315-A0-00



18-0826
DRAIN SCREW GASKET
Replaces: 90430-14115-00
Fits: 40-90 HP

SEE PAGES 201-202 FOR OUR COMPLETE LINE OF GASKET SEALANTS



18-4274
PROP SPACER
Replaces: 688-45997-01-00



18-2448
LOWER UNIT FILL/DRAIN KIT
M8 - 1.25 thread
Fits: Yamaha, Nissan/Tohatsu, & Honda Lower Units



18-4698
18-46981-9[Ⓢ]
(PKG. OF 50) DRAIN FILL WASHER
Replaces: 90430-08020-00



18-2371
18-23711-9[Ⓢ]
(PKG. OF 50) DRAIN SCREW
M8 - 1.25 thread
Replaces: 90340-08002-00, 90340-08M04-00
Uses Gasket 18-4698



18-2374
MAGNETIC DRAIN SCREW
M8 - 1.25 thread
Replaces: 688-45341-00-00, 688-45341-10-00
Uses Gasket 18-4698



18-2388
PROP SHAFT
Replaces: 688-45611-00-00
For: F40 (1999) F50(1999-00) C60/C70/C90 (2000-01) C75 (1994) C85 (1991-94)



18-2385
PROP SHAFT
Replaces: 6E5-45611-01-00
For: 115/130HP

RECOIL STARTER SPRINGS



18-51001
Replaces: 63V-15713-00-00
Fits: 9.9(1996-09), 15(1996-09), F6(2001-08), F8(2001-14), F9.9(2005-14), F15(1998-14), F20(2006-14), T8(2002-10), T9.9(2007-14)

18-51002
Replaces: 67D-15713-00-00
Fits: F2.5(2009-14), F4(1999-14), F6(2009-14)

18-51003
Replaces: 66T-15713-00-00
Fits: F25(2009-14), F30(2001-05), F40(2001-08)

Model	Year	Part #	Model	Year	Part #
40EJRP - 50TLHS	1984-1997	N/A	F115TLR	2006 & UP	18-2385
50ETSN - 50TLHS	1984-1994	N/A	F115TLRA - F115TLRZ	2001-2005	18-2385
T50TLRY - C90TLRZ	1989-2001	18-2388	F115TXR	2006 & UP	18-2385
50ETSK	1984-2001	18-2385	F115TXRA -200ETXN	1984-2004	18-2385
115TLR	2006 & UP	18-2385	V-6 SPECIAL	1985-1986	18-2385
115TLRA - 115TRR	1991-2005	18-2385	V-6 SPECIAL L	1984-1986	18-2385
115TXR	2006 & UP	18-2385	V-6 SPECIAL LK	1985	18-2385
115TXRA - 115TXRA	1991-2005	18-2385	V-6 SPECIAL X	1984-1986	18-2385
F115TJR	2006 & UP	18-2385	V-6 SPECIAL XK	1985	18-2385
F115TJRA - F115TJRD	2002-2005	18-2385			







18-2773
CARRIER BEARING
Replaces: 663-45331-00-94
For: E48 (1995, 1997-00) / C55 (1991-95)



18-2782
CARRIER BEARING
Replaces: 688-45331-00-94
For: F40 (1999) F50/T50 (1996-00) 60 (2002-03) C60 (1996-01) E60 (1995-99) P60 (1991-99) 70 (1984-03) C70 (2000-01) C75 (1994-96 / 1998-99) E75 (1995-00) P75 (1996-99) C80 (1997) C85 (1991-96)

Zinc is for saltwater only applications.
 Magnesium is for fresh water only applications.
 Aluminum is for brackish water, or if boat is used in both fresh and salt environments.

 <p>18-6118A① CYLINDER BLOCK ANODE Replaces: 68V-11325-01-00 Fits: F75-F250 / 2004 through April 2006 Production</p>	 <p>18-6119A① 18-6119Z③ TRIM TAB ANODE Replaces: 61A-45371-00-00</p>	 <p>18-6120A① 18-6120Z③ GEARCASE ANODE Replaces: 61N-45251-01-00</p>	 <p>18-6121A① 18-6121Z③ TRIM TAB ANODE Replaces: 6K1-45371-02-00 Fits: FL150 (2004-2005); L150 - L200 (1987-2002)</p>	 <p>18-6122A① 18-6122Z③ TRIM TAB ANODE Replaces: 69L-45371-00-00 Fits: VZ200 - VZ300 / 3.3L (2005-Current), VX225 - VX250 / 2.6L (2002-2005), Z250 - Z300 / 3.3L (2004-Current)</p>												
 <p>18-6246 TRIM TAB BOLT Replaces: 90105-10M00-00 M10 - 1.25 x 45mm thread</p>	 <p>③ 18-6034 ANODE Replaces: 6K1-45371-00-00 For use on lower drive 150,200 HP (1986)</p>	 <p>② 18-6112 ③ 18-6035 ANODE Replaces: 6J9-45371-01-00 For: 150-200 HP</p>	 <p>② 18-6111 ③ 18-6070 ANODE Replaces: 688-45371-02-00 For use on lower casing drive For: 60, 70, 90HP (1984-04), C60, C75, C85, C90 (1994-01), E60, E75 (1995-00), F50 (1996-00), P60, P75 (1991-99), T50 (1996-00)</p>	 <p>③ 18-6090 ANODE Replaces: 6G5-45251-01-00 For use on transom bracket For: 115-225HP (1988-02)</p>												
 <p>③ 18-6091 ANODE Replaces: 6H1-45251-02-00 For: 40-90 HP</p>	 <p>③ 18-6096 ANODE Replaces: 664-45371-01-00 For: 20-50 HP</p>	 <p>③ 18-6097 ANODE Replaces: 6E5-45371-01-00 For use on lower casing drive For: 115, 130 HP (1984-04), V6 Special (1985-86)</p>	 <p>① 18-6132A ② 18-6132M ANODE For: Yamaha 200-250 Outboards</p>	 <p>① 18-6133A ② 18-6133M ANODE Fits: Yamaha 150-200 Outboards</p>												
 <p>18-6162A① 18-6162M② ANODE KIT Fits: Yamaha 60-90HP Engines</p>	 <p>COTTER PINS</p> <table border="1"> <thead> <tr> <th>Part #</th> <th>O.E. #</th> <th>Pkg of</th> </tr> </thead> <tbody> <tr> <td>18-2380</td> <td>91490-30030-00, 91401-30030-00, 91401-30028-00, 91402-30028-09, 91402-30028-00, 91402-30022-09, 91402-30022-00</td> <td>10</td> </tr> <tr> <td>18-3735</td> <td>91490-40030-00</td> <td>10</td> </tr> <tr> <td>18-3748</td> <td>91490-30045-00</td> <td>5</td> </tr> </tbody> </table>		Part #	O.E. #	Pkg of	18-2380	91490-30030-00, 91401-30030-00, 91401-30028-00, 91402-30028-09, 91402-30028-00, 91402-30022-09, 91402-30022-00	10	18-3735	91490-40030-00	10	18-3748	91490-30045-00	5	 <p>18-73891 PROP SPACER Replaces: 68D-G5987-00-00 Fits: Yamaha F2.5(2001 & Up), F4(2001 & Up), F6(2006 & Up)</p>	 <p>18-73914 PROP SPACER Replaces: 670-45997-02-00 Fits: Yamaha 40-50(1984-05)</p>
Part #	O.E. #	Pkg of														
18-2380	91490-30030-00, 91401-30030-00, 91401-30028-00, 91402-30028-09, 91402-30028-00, 91402-30022-09, 91402-30022-00	10														
18-3735	91490-40030-00	10														
18-3748	91490-30045-00	5														
 <p>18-73918 PROP THRUST WASHER Replaces: 63P-45987-00-00, 6E5-45987-01-00 Fits: Yamaha F115-F200(2004-14)</p>	 <p>18-73979 PROP THRUST WASHER Replaces: 6L2-45987-01-00 Fits: Yamaha 25(1988-09), 30(1990-02), C30(1994-97), F25(1998-14)</p>	 <p>18-73978 PROP NUT WASHER Replaces: 90201-08M54-00 Fits: Yamaha Multiple Applications</p>	 <p>18-73990 PROP NUT KIT Fits: Yamaha 40(1984-01), 50(1984-05), C65, F40-F50(1995-00)</p>	 <p>18-73994 PROP NUT KIT Fits: Yamaha F2.5/F4(2001 & Up), F6(2006 & Up)</p>												
<p>① Aluminum ② Magnesium ③ Zinc</p>																



**18-73892
PROP NUT**
Replaces: 6L5-45616-00-00
Fits: Yamaha 2.5-6(1988 & Up)

NEW



**18-73995
PROP NUT KIT**
Replaces: 66T-W4599-00-00
Fits: *F30 (2001-05, 2013-19), F40 (2000-19), F50 (2001-19), F60 (2002-19)
Replacing propeller nuts and tab washers is always good practice when replacing a propeller.
Keep a kit with your spare prop in the event of an unexpected propeller change.
Propeller nut features a nylon insert securing the propeller under extreme conditions.

NEW



**18-73996
PROP NUT KIT**
Replaces: 67F-W4599-00-00
Fits: T50 (2001-18), T60 (2003-18), 60 (2004-05), 70 (2004-09), 90 (2004-09), F70 (2010-18), F75 (2003-17), F80 (1999-03), F90 (2003-17), F100 (1999-03), T50 (2001-18), T60 (2003-18)
Replacing propeller nuts and tab washers is always good practice when replacing a propeller.
Keep a kit with your spare prop in the event of an unexpected propeller change.
Propeller nut features a nylon insert securing the propeller under extreme conditions.



**18-73907
PROP NUT**
Replaces: 90171-14056-00
Fits: Yamaha 20-30 HP (1980 & up)

①18-3781D



Display Package

**18-3781
PROP NUT KIT**
Replaces: 6H1-W4599-00-00
For: T50, C60, E60, P60, 70, C75, C80, C85, 90
— CONTAINS —

Part #	O.E. #	Desc.
18-3732	90171-18011-00	Prop Nut
18-4274	688-45997-01	Spacer
18-2380	91490-30030	Cotter Pin

①18-3782D



Display Package

**18-3782
PROP NUT KIT**
Replaces: 6G5-W4599-00-00
— CONTAINS —

Part #	O.E. #	Desc.
18-3726	90171-18M04	Prop Nut
18-4274	688-45997-01	Spacer
18-3735	91490-40030	Cotter Pin
ALL V-4 & V-6 (Except D150)		

**18-3771
PROP NUT KIT**
Replaces: 689-W4599-00

Part #	O.E. #	Desc.
18-3791	689-45997-00	Spacer
18-3792	90171-14013-00	Prop Nut
18-2380	91490-30030-00	Cotter Pin



**18-3709
PROP NUT**
Replaces: 647-45616-02
Fits: 4(1984-91), 5(1984-85)



**18-3726
PROP NUT**
Replaces: 90171-18M04
For: All V-4 & V-6 (Except D150)



**18-3732
PROP NUT**
Replaces: 90171-16011-00
95307-16900-00
Fits: Yamaha 20-30 hp(1980 & Up)



**18-3773
PROP NUT**
Replaces: 90171-10M01
Fits: 6(1986-00), 8(1986-09), 9,9(1984-09), 15(1984-09), F6(2001-08), F8(2001-12), F9,9(1985-12), F15(1988-13), F20(2006-13)



**18-3791
SPACER**
Replaces: 689-45997-00



**18-3792
PROP NUT**
Replaces: 90171-14013-00, 90171-14056-00



**18-79989
TRAILERING STICKS**
Fits: Most outboards over 150hp with three ram integral tilt/trim.

HP/Model	Years	Nut #	Spacer #	Cotter Pin #	Kit #
2(GA1)	1984-95	—	—	18-3748	—
4(GE0)	1984-90	—	—	18-3748	—
4(GE0)	1991	—	—	18-2380	—
5	1984-85	—	—	18-3748	—
9,9(GGB)	1984-85	—	—	18-3748	—
20	1995-97	18-3792	18-3791	18-2380	18-3771
25(GH7)(GL2)	1984-09	18-3792	18-3791	18-2380	18-3771
C25(G95)	1991-97	18-3792	18-3791	18-2380	18-3771
CV24	1990	18-3792	18-3791	18-2380	18-3771
F25	1999-05, 2009-10	18-3792	18-3791	18-2380	18-3771
30(GR9)(GJ8)	1984-02	18-3792	18-3791	18-2380	18-3771
C30(G89)(GLT)	1991-97	18-3792	18-3791	18-2380	18-3771
CV30	1990	18-3792	18-3791	18-2380	18-3771
40(GH4)(G3B,C,D)	1984-05	18-3792	—	18-2380	—
C40(GF8)	1990-03	18-3792	—	18-2380/18-3748	—
50(GH5)(G2X)	1984-09	18-3792	—	18-2380/18-3748	—
PRO50(GH5)(G2X)	1987-90	18-3792	—	—	—
T30	2001-10	18-3792	18-3789	18-3735	18-3772
C55(G97)	1991-95	18-3792	—	18-2380	—
80	2004-05	18-3792	18-3789	18-3735	18-3772
P60(GH2)	1991-99	18-3792	18-4274	18-3735	18-3781
T60	2003-10	18-3792	18-3789	18-3735	18-3772
70(GH3)	1984-03	18-3792	18-4274	18-3735	18-3781
T70	2004-09	18-3792	18-3789	18-3735	18-3772
F70	2010	18-3792	18-3789	18-3735	18-3772
C75(G92)	1994-99	18-3792	18-4274	18-3735	18-3781
F75	2003-10	18-3792	18-3789	18-3735	18-3772
F80	1999-03	18-3792	18-3789	18-3735	18-3772
C85(G88)	1991-99	18-3792	18-4274	18-3735	18-3781
90(GH1)	1984-03	18-3792	18-4274	18-3735	18-3781
90	2004-09	18-3792	18-3789	18-3735	18-3772
F90	2003-10	18-3792	18-3789	18-3735	18-3772
F100	1999-03	18-3792	18-3789	18-3735	18-3772
115(GE5)(GN6)	1984-09	18-3792	18-4274	18-3735	18-3781
G115(GE5)	1991-00	18-3792	18-4274	18-3735	18-3781
P115(G2A)	1993-96	18-3792	18-4274	18-3735	18-3781
130(BL1)(GN7)	1988-04	18-3792	18-4274	18-3735	18-3781
L130(GL8)(GN4)	1989-01	18-3792	18-4274	18-3735	18-3781
150(GG4)(GR2)	1984-09	18-3792	18-4274	18-3735	18-3781
PRO V 150 (GJ9)(GN9)	1986-90	18-3792	18-4274	18-3735	18-3781
P150(GN9)	1991-99	18-3792	18-4274	18-3735	18-3781
L150(GR0)	1985-92	18-3792	18-4274	18-3735	18-3781
175(GG5)(GR3)	1984-00	18-3792	18-4274	18-3735	18-3781
P175(G2H)	1994-99	18-3792	18-4274	18-3735	18-3781
200(GG6)(GR4)	1984-85	18-3792	18-4274	18-3735	18-3781
L200(GK1)(GR1)	1987-99	18-3792	18-4274	18-3735	18-3781
P200(G1H)	1991-99	18-3792	18-4274	18-3735	18-3781
225(GR5)(G2J)	1990-97	18-3792	18-4274	18-3735	18-3781
L225(G2K)	1994-02	18-3792	18-4274	18-3735	18-3781
250(G1A)	1990-95	18-3792	18-4274	18-3735	18-3781
L250(G1B)	1990-92	18-3792	18-4274	18-3735	18-3781
V6 SPECIAL(GG7)	1984-86	18-3792	18-4274	18-3735	18-3781
V6 EXCEL(GK7)	1987-89	18-3792	18-4274	18-3735	18-3781

① Items ending in "D" are Display Packaged - Regular number is Non-Display

② This product is priced per piece. To order price per package, please add -9 to the part number.



QUALITY is ASSURED



Shields Marine manufactures a wide variety of hoses for applications onboard pleasure craft. Serving as conduits for fluids, air or exhaust, each Shields hose is designed for a specific application and meets strict standards set by the USCG, ABYC and other regulatory agencies.

Three of our marine exhaust hoses have qualified for Lloyd's Register Type Approval, meeting the highest standards of production quality.

See pages 63-109 for product offering.



The Very Best Parts of Boating

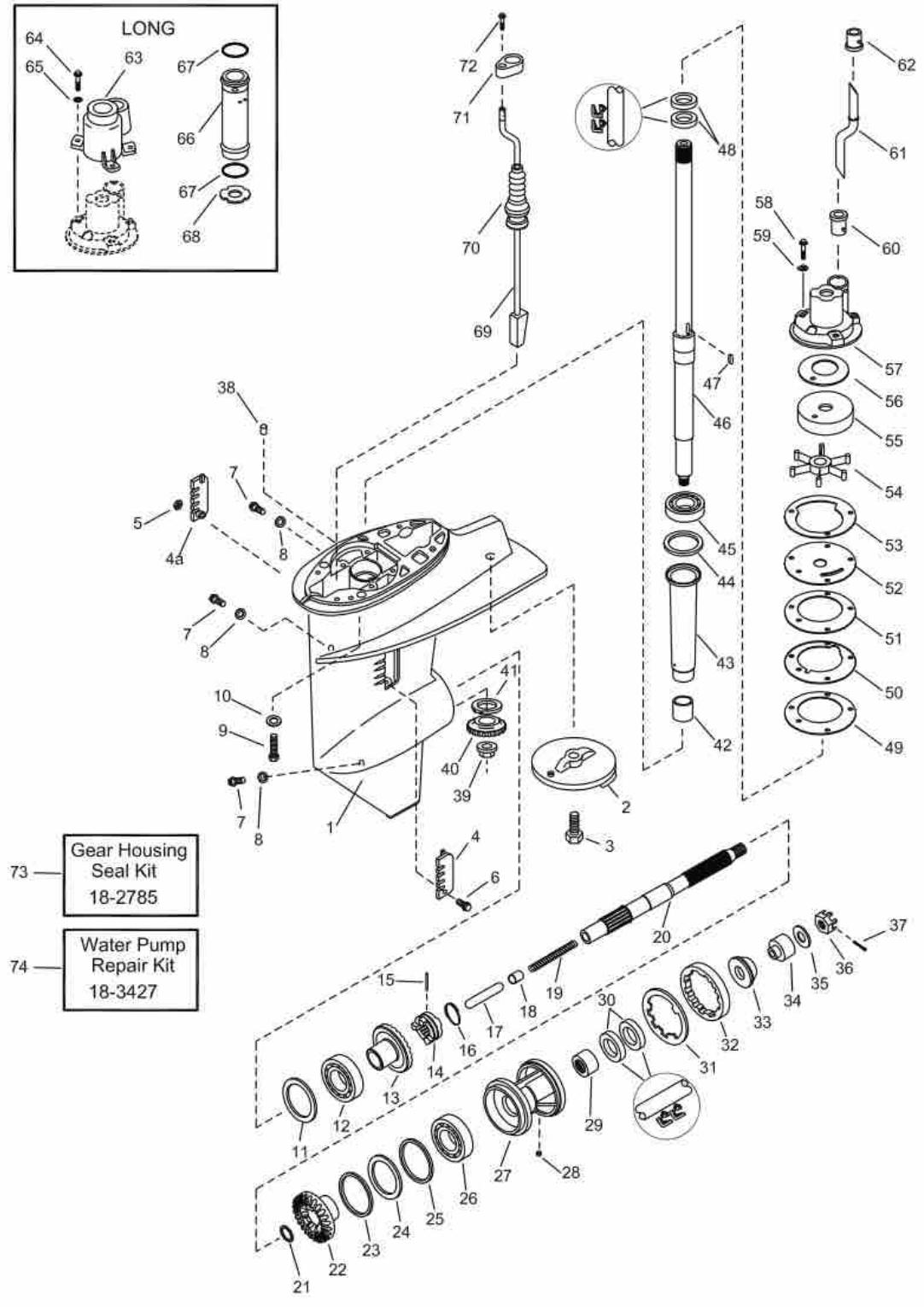
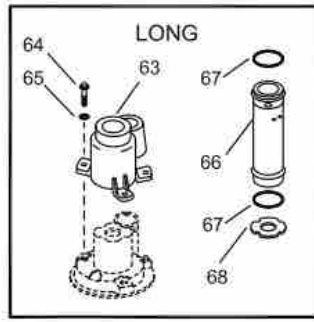

73 — Gear Housing Seal Kit 18-2785

74 — Water Pump Repair Kit 18-3427

Figure #	Description	Part #	O.E.M. #	Qty.	Figure #	Description	Part #	O.E.M. #	Qty.
1	Housing, Gearcase	—	689-45311-04-EK3	1	37	Cotter Pin	18-2380	91490-30030-00	
2	Trim Tab	18-6096A, 18-6113	664-45371-01-00	1	38	Pin, Dowel	—	93606-12019-00	2
					39	Nut, Pinion	—	90179-09M02-00	2
3	Bolt, Trim Tab	—	90105-08M02-00	1	40	Gear, Pinion	—	689-45551-00-00	1
4	Cover, Water Inlet (port)	—	689-45214-01-01	1	41	Bearing, Thrust	—	664-45552-09-00	1
4a	Cover, Water Inlet (stbd)	—	689-45215-01-00	1	42	Bearing, Pinion	—	93315-017U4-00	1
5	Nut, Nylock	—	90185-05904-00	1	43	Sleeve, Drive Shaft	—	689-45536-00-00	1
6	Bolt, Water Inlet	—	98680-05525-00	1	44	Shim Pinion Gear (0.5mm)	—	664-45587-00-05	AR
7	Plug, Drain & Vent	—	90340-08M04-00	3		Shim Pinion Gear (0.8mm)	—	664-45587-00-08	AR
8	Gasket, Plug	—	90430-08020-00	3		Shim Pinion Gear (0.12mm)	—	664-45587-01-12	AR
9	Bolt, Gearcase Mounting	—	90105-10059-00	2		Shim Pinion Gear (0.30mm)	—	664-45587-01-30	AR
10	Washer, Gearcase Mounting	—	92990-10600-00	4		Shim Pinion Gear (0.50mm)	—	664-45587-01-50	AR
11	Shim Forward Gear (0.5mm)	—	664-45567-00-05	AR	45	Bearing, Drive Shaft	—	93332-000U4-00	1
	Shim Forward Gear (0.8mm)	—	664-45567-00-08	AR	46	Drive Shaft (long)	—	689-45501-10-00	1
	Shim Forward Gear (0.12mm)	—	664-45567-01-12	AR	47	Key, Impeller	—	664-44338-00-00	1
	Shim Forward Gear (0.30mm)	—	664-45567-01-30	AR	48	Oil Seal, Pump Base	18-0296	93101-22067-00	2
	Shim Forward Gear (0.50mm)	—	664-45567-01-50	AR	49	Gasket, Base	18-0773	689-44316-A0-00	1
12	Bearing, Forward Gear	—	93332-00005-00	1	50	Base, Water Pump	—	689-44325-02-5B	1
13	Gear, Forward	—	689-45560-00-00	1	51	Gasket, Base	18-0773	689-44316-A0-00	1
14	Clutch, Dog	—	664-45631-01-00	1	52	Impeller Plate	—	689-44323-03-00	1
15	Pin, Clutch Dog	—	90250-05010-00	1	53	Gasket, Impeller Plate	—	689-44324-A0-00	1
16	Ring, Cross Pin	—	648-45633-00-00	1	54	Impeller	18-3067	689-44352-02-00	1
17	Plunger, Shift	—	648-45635-00-00	1	55	Insert Cup	18-3439	689-W4432-02-00	1
18	Slide, Shift	—	648-45634-00-00	1	56	Damper, Water Seal	—	689-44367-01-00	1
19	Spring, Compression	—	90501-10065-00	1	57	Housing, Water Pump	—	689-44311-03-00	1
20	Shaft, Propeller	—	689-45611-00-00	1	58	Bolt, Pump Housing	—	90101-06M56-00	3
21	Thrust, Washer, Prop Shaft	—	90201-20417-00	1	59	Washer, Housing (short shaft)	—	90209-06M04-00	3
22	Gear, Reverse	—	689-45571-00-00	1	60	Seal, Lower Water Tube	—	626-44365-01-00	1
23	Shim Reverse Gear (0.5mm)	—	664-45577-00-05	AR	61	Water Tube (long shaft)	—	689-44361-10-00	1
	Shim Reverse Gear (0.8mm)	—	664-45577-00-08	AR	62	Seal, Upper Water Tube	18-0552	689-44366-00-00	1
	Shim Reverse Gear (0.12mm)	—	664-45577-01-12	AR	63	Extension, Housing (long shaft)	—	689-44312-00-5B	1
	Shim Reverse Gear (0.30mm)	—	664-45577-01-30	AR	64	Bolt, Extension (long shaft)	—	97080-06035-00	3
	Shim Reverse Gear (0.50mm)	—	664-45577-01-50	AR	65	Washer, Bolt (long shaft)	—	92990-06600-00	3
24	Washer Thrust	—	664-45576-00-00	1	66	Extension Tube (long shaft)	—	689-44362-00-94	1
25	O-Ring, Bearing Carrier	—	93210-30MA3-00	1	67	O-Ring, Extension Tube	—	93210-26240-00	2
26	Bearing, Reverse Gear	—	93306-00612-00	1	68	Plate (long shaft)	—	689-44328-03-00	1
27	Bearing, Carrier	—	689-45331-01-94	1	69	Shift Cam Assembly (short shaft)	—	664-44150-01-00	1
28	Key, Bearing Carrier	—	90282-04010-00	1	69	Shift Cam Assembly (long shaft)	—	664-44150-11-00	1
29	Bearing, Prop Shaft	—	93315-22004-00	1	70	Boot, Shift Rod	—	664-44147-00-00	1
30	Seal, Prop Shaft	18-0554	93101-20M07-00	2	71	Bracket, Shift Shaft	—	689-44176-01-00	1
31	Tab Washer	—	90214-45M02-00	1	72	Screw, Bracket	—	97780-50610-00	1
32	Nut, Cover	—	664-45384-00-00	1	73	Gear Housing Seal Kit	18-2785	689-W0001-22-00	1
33	Prop Spacer (fore)	—	664-45987-01-00	1	74	Water Pump Repair Kit	18-3427	689-W0078-A6-00	1
34	Prop Spacer (aft)	—	689-45997-00-00	1					
35	Washer, Prop Mounting	—	92990-14200-00	1					
36	Nut, Propeller	—	90171-14013-00	1					

AR As required

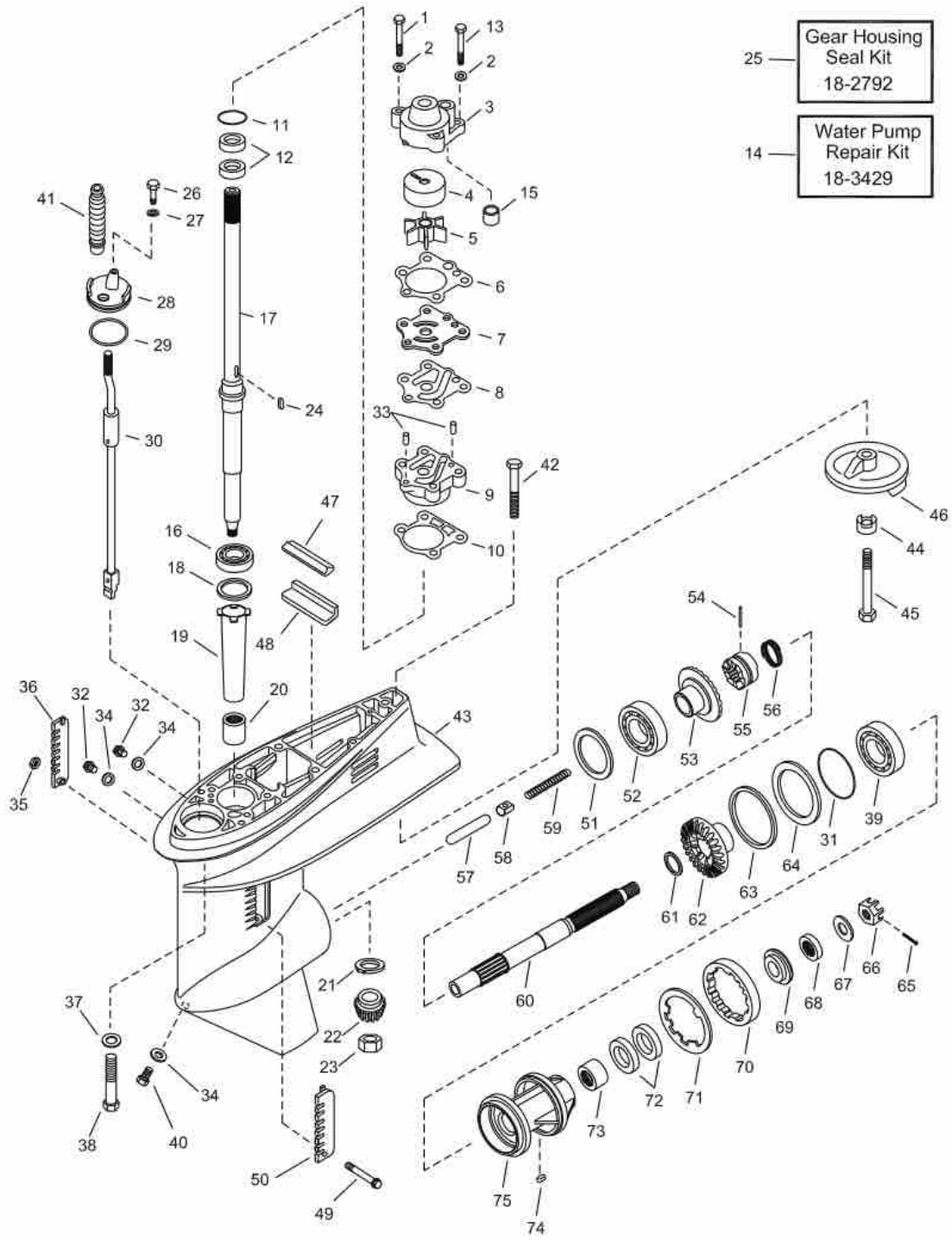
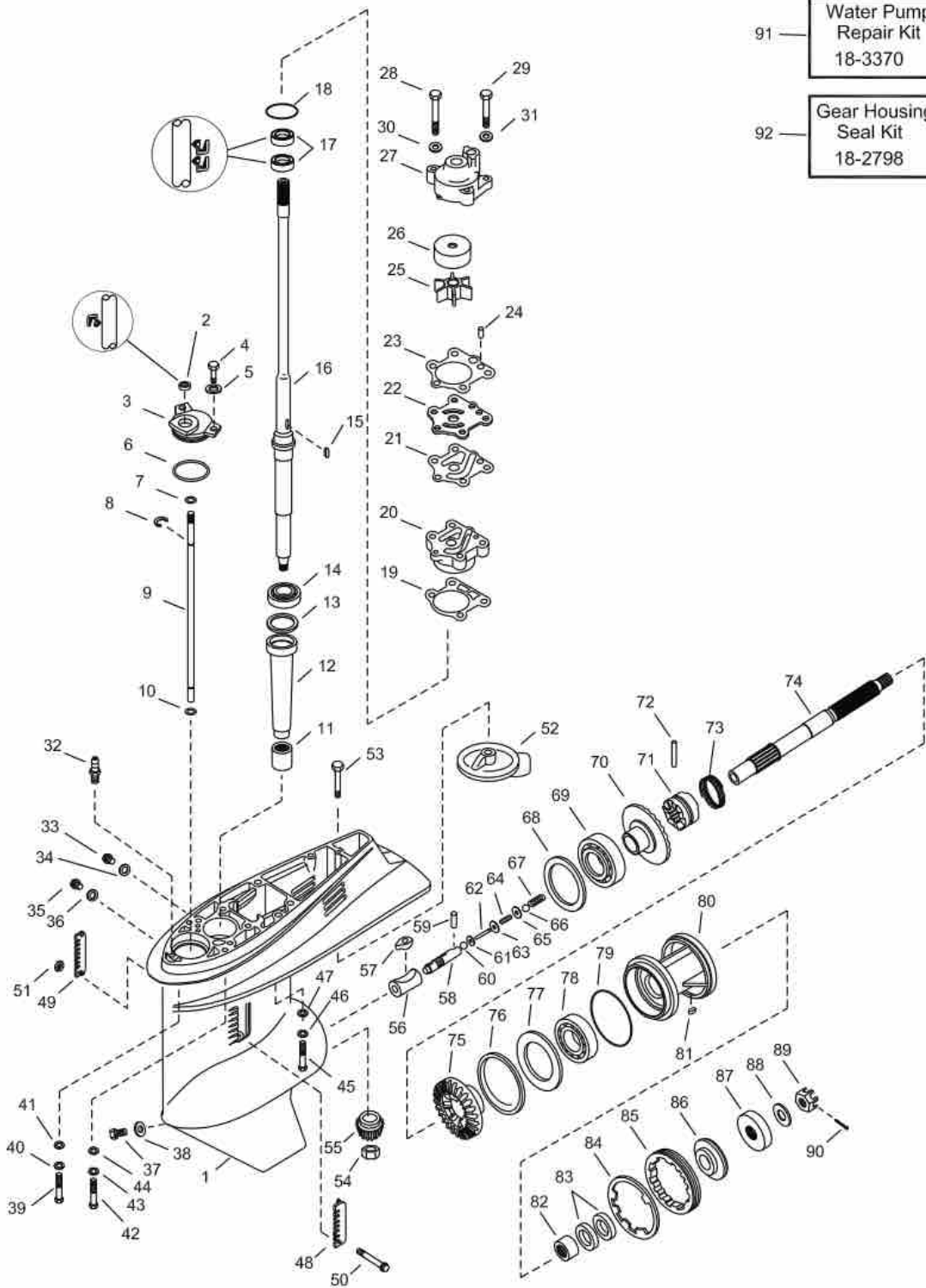

Figure #	Description	Part #	O.E.M. #	Qty.	Figure #	Description	Part #	O.E.M. #	Qty.
1	Bolt, Water Pump Housing	—	97395-08055-00	2	39	Bearing, Ball	—	93306-00702-00	1
2	Washer, Water Pump Housing	—	92990-08600-00	4	40	Plug, Drain	18-2374	688-45341-00-00	1
3	Housing, Water Pump	—	663-44311-02-00	1	41	Propeller	—	various	1
4	Insert, Water Pump	18-3435	663-44322-00-00	1	42	Bolt, Trim Tab	—	97575-08675-00	1
5	Impeller	18-3068	6H4-44352-02-00	1	43	Casing, Lower	—	6H4-45301-01-EK	1
6	Gasket, Wear Plate to Water Pump	18-0292	663-44315-A0-00	1	44	Washer, Locking	—	92990-08100-00	1
					45	Bolt, Lower Casing	—	97095-08085-00	1
7	Wear Plate, Water Pump	18-3436	663-44323-00-00	1	46	Tab, Trim	18-6096A	664-45371-01-00	1
8	Gasket, Wear Plate to Water Pump	18-0294	663-44324-A0-00	1	47	Seal Rubber	—	688-45375-00-00	1
					48	Guide, Seal Rubber	—	663-45376-00-94	1
9	Base, Water Pump	—	663-44341-00-94	1	49	Screw Ovalhead	—	98780-05535-00	1
10	Gasket, Pump Base	—	663-44316-A0-00	1	50	Cover, Water Inlet (port)	—	668-45214,02-00	1
11	O-Ring, Pump Base	18-0298	93210-41042-00	1	51	Shim Forward Gear (0.5mm)	—	6H4-45567-00-05	1
12	Oil Seal, Pump Base	18-0297	93101-23070-00	2		Shim Forward Gear (0.8mm)	—	6H4-45567-00-08	AR
13	Bolt, Water Pump Housing	18-0256	97095-08045-00	2		Shim Forward Gear (0.12mm)	—	6H4-45567-01-12	AR
14	Water Pump Repair Kit	18-3429	6H4-W0078-00-00	1		Shim Forward Gear (0.30mm)	—	6H4-45567-01-30	AR
15	Water Seal	—	663-44366-00-00	1		Shim Forward Gear (0.50mm)	—	6H4-45567-01-50	AR
16	Bearing, Tapered Roller	—	93332-00079-00	1	52	Bearing, Tapered Roller	—	93332-000V4-00	1
17	Drive Shaft (Short)	—	6H4-45501-00-00	1	53	Gear, Forward	—	6H4-45560-00-00	1
17	Drive Shaft (Long)	—	6H4-45501-10-01	1	54	Pin, Cross (clutch dog)	—	90250-06023-00	1
18	Shim (0.5mm)	—	663-45587-00-05	AR	55	Clutch, Sliding	—	663-45631-01-00	1
	Shim (0.8mm)	—	663-45587-00-08	AR	56	Retainer Ring, Cross Pin	—	663-45633-00-00	1
	Shim (0.12mm)	—	663-45587-01-12	AR	57	Plunger, Shift	—	676-45635-00-00	1
	Shim (0.30mm)	—	663-45587-01-30	AR	58	Slide, Shift	—	663-45634-00-00	1
	Shim (0.50mm)	—	663-45587-01-50	AR	59	Spring, Compression	—	60501-16M01-00	1
19	Sleeve, Drive Shaft	—	6H4-45536-00-0	1	60	Shaft, Propeller	—	679-45611-01-00	1
20	Bearing, Needle	—	93315-32224-00	1	61	Washer, Plate	—	90201-22429-00	1
21	Bearing (not used 1988 & later)	—	663-45552-00-00	1	62	Gear, Reverse	—	6H4-45571-00-00	1
22	Gear, Pinion	—	6H4-45551-00-00	1	63	Shim Reverse Gear (0.5mm)	—	663-45577-00-05	AR
23	Nut, Pinion Gear	—	90170-12138-00	1		Shim Reverse Gear (0.8mm)	—	663-45577-00-08	AR
24	Key, Woodruff	18-3305	90280-03024-00	1		Shim Reverse Gear (0.12mm)	—	663-45577-01-12	AR
25	Gearcase Seal Kit	18-2792	6H4-W0001-20-00	1		Shim Reverse Gear (0.30mm)	—	663-45577-01-30	AR
26	Bolt, Plate	—	97095-06016-00	1		Shim Reverse Gear (0.50mm)	—	663-45577-01-50	AR
27	Washer, Plate	—	92990-06600-00	1	64	Washer, Thrust	—	663-45576-00-00	1
28	Plate	—	6H4-45321-01-00	1	65	Pin, Cotter	18-2380	91490-30030-00	1
29	O-Ring, Plate	—	93210-49046-00	1	66	Nut, Castle	18-3732	90171-16011-11	1
30	Shift Cam Assembly (short shaft)	—	6H4-44150-01-00	1	67	Washer	—	92990-16200-00	1
	Shift Cam Assembly (long shaft)	—	6H4-44150-12-01	1	68	Spacer, Prop Mounting (aft)	—	670-45997-02-00	1
31	O-Ring, Bearing Housing	18-0299	93210-66M98-00	1	69	Spacer, Prop Mounting (fore)	—	663-45987-02-00	1
32	Plug, Vent	—	90340-08M04-00	2	70	Nut, Cover	—	697-45385-00-00	1
33	Pin, Dowel	—	93604-08062-00	2	71	Washer, Tab	—	90214-48M03-00	1
34	Gasket, Drain Plug	—	90430-08020-00	3	72	Oil Seal, Bearing Housing	18-0296	93101-22067-00	2
35	Nut, Nylock	—	90185-05904-00	1	73	Bearing, Needle	—	93317-22204-00	1
36	Cover, Water Inlet (stbd)	—	688-45215-02-00	1	74	Key, Bearing Housing	—	90282-04010-00	1
37	Washer, Locking	—	92990-10100-00	4	75	Housing, Bearing	—	679-45331-00-94	1
38	Bolt	—	97078-10040-00	4					

AR As required



- 91 — Water Pump Repair Kit 18-3370
- 92 — Gear Housing Seal Kit 18-2798

Figure #	Description	Part #	O.E.M. #	Qty.	Figure #	Description	Part #	O.E.M. #	Qty.
1	Gearcase	—	6H1-45301-04-EK	1	50	Screw, Water Inlet	—	98680-05545-00	1
2	Oil Seal, Shift Shaft	18-0267	93106-09014-00	1	51	Nut, Water Inlet	—	90185-05002-00	1
3	Plate, Shift Rod	—	688-45321-00-00	1	52	Trim Tab	18-6070	988-45371-02-00	1
4	Bolt, Shift Rod Retainer	—	97395-06016-00	2	53	Bolt, Anode Mounting	—	90105-10M00-00	1
5	Washer	—	92990-06600-00	2	54	Nut, Pinion	—	90170-16M01-00	1
6	O-Ring	—	93210-49046-00	1	55	Gear, Pinion	—	688-45551-01-00	1
7	O-Ring	—	93210-07540-01	1	56	Shifter	—	6H1-45641-01-00	1
8	Circlip	—	99001-08600-00	1	57	Shift Cam	—	6H1-44151-00-00	1
9	Rod, Shift	—	6H1-44144-00-00	1	58	Shift Slide	—	6H1-45634-02-00	1
10	Circlip	—	93450-07M00-00	1	59	Pin	—	93603-12M11-00	1
11	Bearing, Pinion	—	93315-325V1-00	1	60	Nut, Spring	—	90183-02M03-00	1
12	Sleeve, Drive shaft	—	688-45536-01-00	1	61	Shift Plunger	—	6H1-45635-00-00	1
13	Shim Drive Shaft (0.10mm)	—	688-45587-01-10	AR	62	Shaft	—	6H1-45688-00-00	1
	Shim Drive Shaft (0.12mm)	—	688-45587-01-12	AR	63	Shift Plunger	—	6H1-45635-00-00	1
	Shim Drive Shaft (0.15mm)	—	688-45587-01-15	AR	64	Spring, Compression	—	90501-12M48-00	1
	Shim Drive Shaft (0.18mm)	—	688-45587-01-30	AR	65	Washer, Plate	—	90201-03313-00	1
	Shim Drive Shaft (0.30mm)	—	688-45587-01-40	AR	66	Nut, Spring	—	90183-02M03-00	1
	Shim Drive Shaft (0.40mm)	—	688-45587-01-50	AR	67	Spring, Compression	—	90501-16M65-00	1
	Shim Drive Shaft (0.50mm)	—	688-45587-01-16	AR	68	Shim Forward Gear (0.10mm)	—	688-45567-01-10	AR
14	Bearing, Upper Drive Shaft	—	93332-000U3-00	1		Shim Forward Gear (0.12mm)	—	688-45567-01-12	AR
15	Key, Impeller	18-3301	90280-04M04-00	1		Shim Forward Gear (0.15mm)	—	688-45567-01-15	AR
16	Drive Shaft	—	6H1-45501-11-00	1		Shim Forward Gear (0.18mm)	—	688-45567-01-18	AR
17	Oil Seal, Pump Base	18-0587	93101-25M03-00	2		Shim Forward Gear (0.30mm)	—	688-45567-01-30	AR
18	O-Ring, Base	18-7436	9321-46044-00	1		Shim Forward Gear (0.40mm)	—	688-45567-01-40	AR
19	Gasket, Base	18-0240	688-44316-A0-00	1		Shim Forward Gear (0.50mm)	—	688-45567-01-50	AR
20	Base, Water Pump	—	688-44341-01-94	1	69	Bearing, Forward Gear	—	93332-000W7-00	1
21	Gasket, Wear Plate to Base	—	688-44324-A0-00	1	70	Gear, Forward	—	688-45560-00-00	1
22	Wear Plate	18-3341	688-44323-00-00	1	71	Clutch, Dog	—	6H1-45631-01-00	1
23	Gasket, Wear Plate to Housing	18-0239	688-44315-A0-00	1	72	Pin, Cross	—	90250-07M02-00	1
24	Pin	—	93604-10M03-00	1	73	Spring, Cross Pin	—	688-45633-00-00	1
25	Impeller	18-3070	688-44352-03-00	1	74	Shaft, Propeller	—	6H1-45611-01-00	1
26	Insert, Water Pump	—	688-44322-00-00	1	75	Gear, Reverse	—	6H1-45571-00-00	1
27	Housing, Water Pump	18-3171	688-44311-01-00	1	76	Shim Reverse Gear (0.10mm)	—	688-45577-01-10	AR
28	Bolt, Water Pump	—	97395-08070-00	2		Shim Reverse Gear (0.12mm)	—	688-45577-01-12	AR
29	Bolt, Water Pump	—	97395-08050-00	2		Shim Reverse Gear (0.15mm)	—	688-45577-01-15	AR
30 &						Shim Reverse Gear (0.18mm)	—	688-45577-01-18	AR
31	Washer, Water Pump	—	90209-08M02-00	4		Shim Reverse Gear (0.30mm)	—	688-45577-01-30	AR
32	Nipple, Hose	—	6E5-45378-00-00	1		Shim Reverse Gear (0.40mm)	—	688-45577-01-40	AR
33	Plug, Drain	18-2371	90340-08M04-00	1		Shim Reverse Gear (0.50mm)	—	688-45577-01-50	AR
34	Gasket, Vent & Drain Plugs	18-46981-9	90430-08020-00	1	77	Washer, Thrust	—	688-45576-00-00	1
35	Plug, Drain	18-2371	90340-08M04-00	1	78	Bearing, Reverse Gear	—	93306-207U0-00	1
36	Gasket, Vent & Drain Plugs	18-46981-9	90430-08020-00	1	79	O-Ring, Bearing Housing	—	93210-85M97-00	1
37	Plug, Drain	18-2374	688-45341-00-00	1	80	Housing, Bearing	18-2782	688-45331-00-94	1
38	Gasket, Vent & Drain Plugs	18-46981-9	90430-08020-00	1	81	Key	—	90282-04010-00	1
39	Bolt	—	97395-10040-00	2	82	Bearing, Needle	—	93317-325U0-00	1
40	Washer, Lock	—	92990-10100-00	2	83	Oil Seal	18-0587	93101-25M03-00	2
41	Washer, Flat	—	92990-10600-00	2	84	Washer, Tab	—	688-45383-02-00	1
42	Bolt	—	97395-10040-00	2	85	Nut, Cover	—	688-45384-00-00	1
43	Washer, Lock	—	92990-10100-00	2	86	Spacer, Forward	—	688-45987-01-00	1
44	Washer, Flat	—	92990-10600-00	2	87	Spacer	18-4274	688-45997-01-00	1
45	Bolt	—	97395-08060-00	1	88	Washer, Propeller	—	90201-17M00-00	1
46	Washer, Lock	—	92990-08100-00	1	89	Nut, Castle	18-3732	90171-16011-00	1
47	Washer, Lock	—	92990-08100-00	1	90	Pin, Cotter	18-3735	91490-40030-00	1
48	Cover, Water Inlet (Port)	—	688-45214-02-00	1	91	Water Pump Repair Kit	18-3370	692-W0078-00-00	1
49	Cover, Water Inlet (Stbd)	—	688-45215-02-00	1	92	Gear Housing Seal Kit	18-2798	688-W0001-20-00	1

AR As required

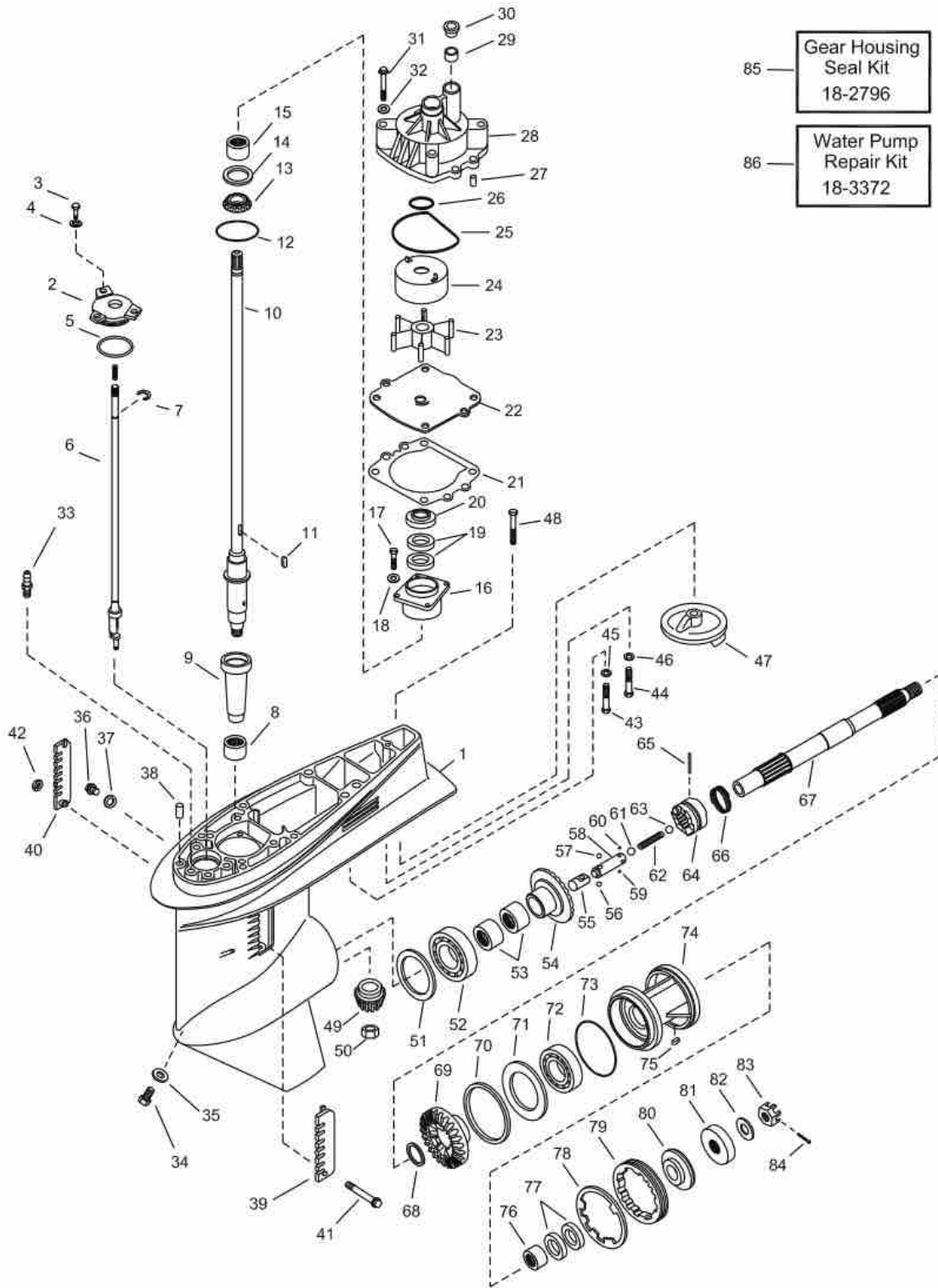

Figure #	Description	Part #	O.E.M. #	Qty.	Figure #	Description	Part #	O.E.M. #	Qty.
1	Housing, Gearcase	—	6E5-45301-03Ek	1	47	Trim Tab	18-6097A	6E5-45371-01-00	1
2	Plate, Shift Rod Cover	—	6E5-45321-00-00	1	48	Bolt, Trim Tab	—	90105-10M00-00	1
3	Bolt, Shift Rod Cover	—	97395-06020-00	3	49	Gear Pinion	—	6E5-45551-02-00	1
4	Washer	—	90209-06M04-00	3	50	Nut, Pinion	—	90170-16M01-00	1
5	O-Ring, Plate	—	93210-5867-00	1	51	Shim (0.10mm)	—	6E5-45567-01-10	AR
6	Shift Rod Assembly	—	6E5-44150-01-00	1		Shim (0.12mm)	—	6E5-45567-01-12	AR
7	Circlip	—	99001-08600-00	1		Shim (0.15mm)	—	6E5-45567-01-15	AR
8	Bearing, Needle	—	93315-628U9-00	1		Shim (0.18mm)	—	6E5-45567-01-18	AR
9	Sleeve, Drive Shaft	—	6E5-45536-00-00	1		Shim (0.30mm)	—	6E5-45567-01-30	AR
10	Drive Shaft (long)	—	6E5-45501-01-00	1		Shim (0.40mm)	—	6E5-45567-01-40	AR
	Drive Shaft (x-long)	—	6E5-45501-21-00	1		Shim (0.50mm)	—	6E5-45567-01-50	AR
11	Key, Impeller	—	90280-04M05-00	1	52	Bearing, Forward Gear	—	93332-000U7-00	1
12	O-Ring, Housing	—	93210-54534-00	1	53	Bearing, Needle	—	93315-425U7-00	2
13	Bearing, Tapered	—	93341-930U0-00	1	54	Gear, Forward	—	6E5-45560-01-00	1
14	Shim (0.10mm)	—	6E5-45587-01-10	AR	55	Shifter	—	6E5-45641-01-00	1
	Shim (0.12mm)	—	6E5-45587-01-12	AR	56	Ball, Detent	—	93507-32031-00	1
	Shim (0.15mm)	—	6E5-45587-01-15	AR	57	Ball, Detent	—	93507-32031-00	1
	Shim (0.18mm)	—	6E5-45587-01-18	AR	58	Slide, Shift	—	6E5-45634-01-00	1
	Shim (0.30mm)	—	6E5-45587-01-30	AR	59	Ball, Detent	—	93503-16010-00	1
	Shim (0.40mm)	—	6E5-45587-01-40	AR	60	Ball, Detent	—	93503-16010-00	1
	Shim (0.50mm)	—	6E5-45587-01-50	AR	61	Ball, Detent	—	93511-32027-00	1
15	Bearing, Needle	—	93315-430V5-00	1	62	Spring, Compression	—	90501-16M37-00	1
16	Housing, Bearing	—	6E5-45331-0094	1	63	Ball, Detent	—	93511-32027-00	1
17	Bolt, Bearing Housing	—	97395-08025-00	4	64	Clutch, Dog	—	6R5-45631-01-00	1
18	Washer	—	92990-08600-00	4	65	Cross Pin, Clutch	—	90250-08M07-00	1
19	Seal, Drive Shaft	18-0265	93101-28M16-00	2	66	Retainer, Cross Pin	—	6E5-45631-01-00	1
20	Cover, Oil Seal	—	6E5-45344-00-00	1	67	Shaft, Propeller	18-2385	6E5-45611-01-00	1
21	Gasket, Wear Plate	18-0244	6E5-44315-A0-00	1	68	Washer, Thrust	—	90201-30M92-00	1
22	Wear Plate	18-3344	6G5-44323-00-00	1	69	Gear, Reverse	—	6E5-45571-04-00	1
23	Impeller	18-3071	6E5-44352-00-00	1	70	Shim (0.10mm)	—	6L6-45577-00-10	AR
24	Insert, Water Pump	—	6E5-44322-00-00	1		Shim (0.12mm)	—	6L6-45577-00-12	AR
25	O-Ring, Water Pump	18-7485	93210-86M38-00	1		Shim (0.15mm)	—	6L6-45577-00-15	AR
26	O-Ring, Water Pump	18-7483	93210-37M67-00	1		Shim (0.18mm)	—	6L6-45577-00-18	AR
27	Pin, Water Pump Housing	—	93606-12019-00	2		Shim (0.30mm)	—	6L6-45577-00-30	AR
28	Housing, Water Pump	18-3170	6E5-44311-00-00	1		Shim (0.40mm)	—	6L6-45577-00-40	AR
29	Damper, Water Seal	—	6E5-44365-00-00	1		Shim (0.50mm)	—	6L6-45577-00-50	AR
30	Cover, Pump Housing	—	6E5-44312-00-0	1	71	Washer, Thrust	—	6E5-45576-00-00	1
31	Bolt, Water Pump	—	97080-08045-00	4	72	Bearing, Reverse Gear	—	93306-208U0-00	1
32	Washer	—	90209-08M02-00	4	73	O-Ring, Bearing Housing	—	93210-86M39-00	1
33	Nipple, Hose	—	6E5-45378-00-00	1	74	Housing, Bearing	—	6E5-45332-00-94	1
34	Drain, Plug Lower	18-2374	688-45341-00-00	1	75	Key, Bearing Housing	—	90282-04010-00	1
35	Gasket, Drain Plug	18-4698	90430-08020-00	1	76	Bearing, Needle	—	93315-430U8-00	1
36	Drain Plug Upper	—	90340-08M04-00	1	77	Seal, Prop Shaft	18-0266	93101-30M17-00	2
37	Gasket, Drain Plug	18-4698	90430-08020-00	1	78	Washer, Tab	—	688-45383-02-00	1
38	Pin, Locating	—	93608-12M05-00	2	79	Nut, Cover	—	688-45384-00-00	1
39	Cover, Water Inlet (Port)	—	688-45214-02-00	1	80	Washer, Thrust	—	6E5-45987-01-00	1
40	Cover, Water Inlet (Stbd)	—	688-45215-02-00	1	81	Spacer, Prop	18-4274	688-45997-01-00	1
41	Screw, Water Inlet	—	90142-05M03-00	1	82	Washer, Prop	—	92990-18200-00	1
42	Nut, Water Inlet	—	90185-05002-00	1	83	Nut, Prop	18-3726	90171-18M04-00	1
43	Bolt	—	97395-10070-00	1	84	Pin, Cotter	18-3735	91490-40030-00	1
44	Bolt	—	97395-10070-00	1	85	Gear Housing Seal Kit	18-2796	6E5-W0001-51-00	1
45	Washer	—	92990-10100-00	1	86	Water Pump Repair Kit	18-3372	6E5-W0078-00-00	1
46	Washer	—	92990-10100-00	1					

AR As required

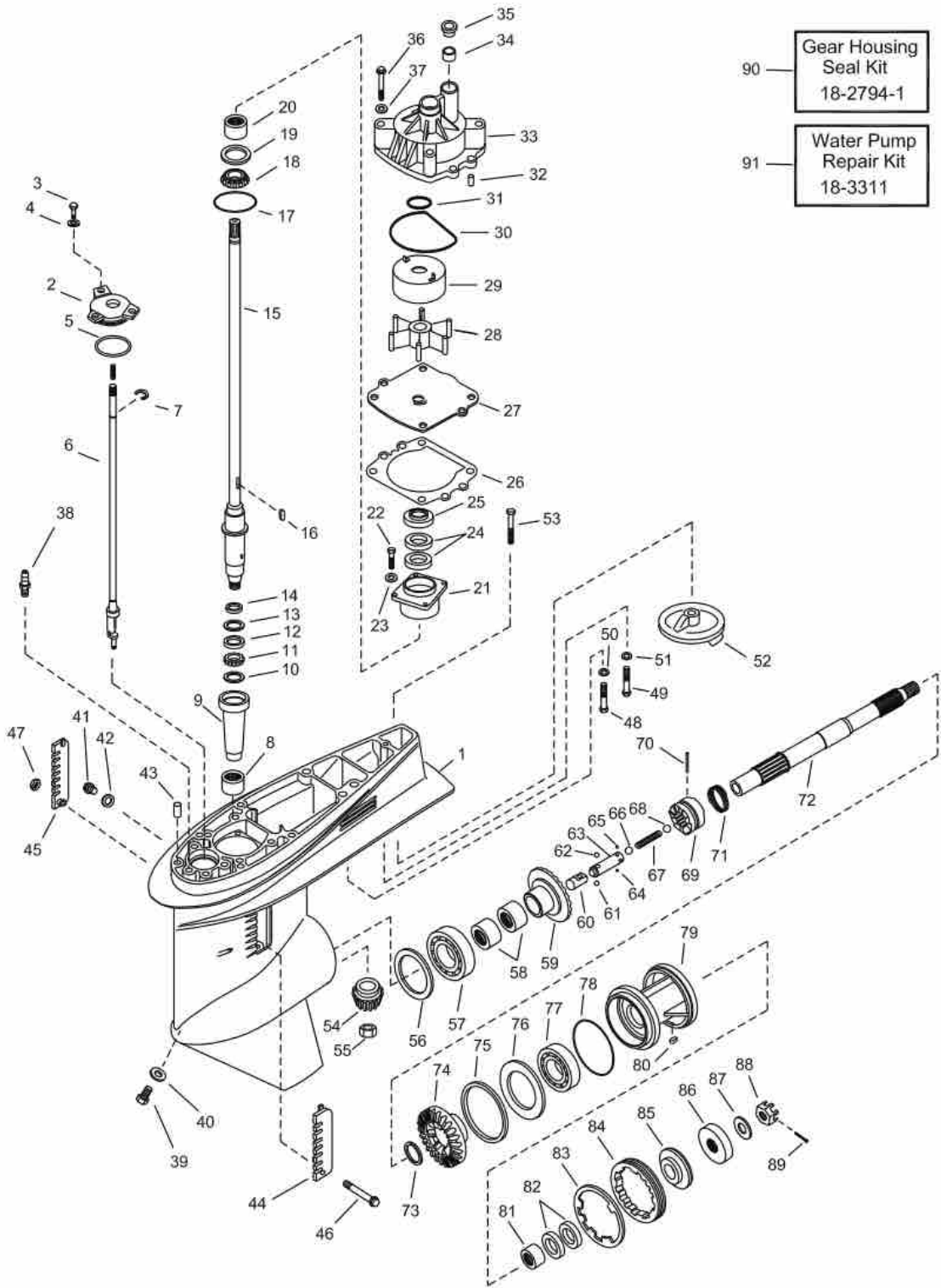

Figure #	Description	Part #	O.E.M. #	Qty.	Figure #	Description	Part #	O.E.M. #	Qty.
1	Housing, Gearcase	—	6J9-45301-02-Ek	1	49	Bolt	—	97395-10070-00	1
2	Plate, Shift Rod Cover	—	6E5-45321-00-00	1	50	Washer	—	92990-10100-00	1
3	Bolt, Shift Rod Cover	—	97395-06020-00	3	51	Washer	—	92990-10100-00	1
4	Washer	—	90209-08M04-00	3	52	Trim Tab	18-6035	6J9-45371-01-00	1
5	O-Ring, Plate	—	93210-58677-00	1	53	Bolt, Trim Tab	—	90105-10M00-00	1
6	Shift Rod Assembly	—	6G5-44150-01-00	1	54	Gear Pinion	—	6G5-45551-01-00	1
7	Circlip	—	99001-08600-00	1	55	Nut, Pinion	—	90170-16M01-00	1
8	Bearing, Needle	—	90250-08M07-00	1	56	Shim (0.10mm)	—	6G5-45567-01-10	AR
9	Sleeve, Drive Shaft	—	6G5-45536-01-00	1		Shim (0.12mm)	—	6G5-45567-01-12	AR
10	Washer	—	90209-33M13-00	1		Shim (0.15mm)	—	6G5-45567-01-15	AR
11	Spring, Compression	—	90501-05M64-00	AR		Shim (0.18mm)	—	6G5-45567-01-30	AR
12	Collar	—	90387-33M00-00	1		Shim (0.30mm)	—	6G5-45567-01-40	AR
13	Washer	—	90209-33M13-00	1		Shim (0.40mm)	—	6G5-45567-01-50	AR
14	Washer	—	90209-33M12-00	1		Shim (0.50mm)	—	6G5-45567-01-10	AR
15	Drive Shaft (long)	—	6G5-45501-01-00	1	57	Bearing, Forward Gear	—	93332-00V3-00	1
	Drive Shaft (x-long)	—	6G5-45501-21-00	1	58	Bearing, Needle	—	93315-425V3-00	2
16	Key, Impeller	—	90280-04M05-00	1	59	Gear, Forward	—	6G5-45631-00-00	1
17	O-Ring, Housing	—	93210-54534-00	1	60	Shifter	—	6E5-45641-01-00	1
18	Bearing, Tapered	—	93341-930U0-00	1	61	Ball, Detent	—	93507-32031-00	1
19	Shim (0.10mm)	—	6E5-45587-01-10	AR	62	Ball, Detent	—	93507-32031-00	1
	Shim (0.12mm)	—	6E5-45587-01-12	AR	63	Slide, Shift	—	6E5-45634-01-00	1
	Shim (0.15mm)	—	6E5-45587-01-15	AR	64	Ball, Detent	—	93503-16010-00	1
	Shim (0.18mm)	—	6E5-45587-01-18	AR	65	Ball, Detent	—	93503-16010-00	1
	Shim (0.30mm)	—	6E5-45587-01-30	AR	66	Ball, Detent	—	93511-32027-00	1
	Shim (0.40mm)	—	6E5-45587-01-40	AR	67	Spring, Compression	—	90501-16M37-00	1
	Shim (0.50mm)	—	6E5-45587-01-50	AR	68	Ball, Detent	—	93511-32027-00	1
20	Bearing, Needle	—	93315-430V5-00	1	69	Clutch, Dog	—	6E5-45633-01-00	1
21	Housing, Bearing	—	6E5-45331-00-94	1	70	Cross Pin, Clutch	—	90250-08M07-00	1
22	Bolt, Bearing Housing	—	97395-08025-00	4	71	Retainer, Cross Pin	—	6E5-45633-01-00	1
23	Washer	—	92990-08600-00	4	72	Shaft, Propeller	—	6J9-45611-01-00	1
24	Seal, Drive Shaft	18-0265	93101-28M16-00	2	73	Washer, Thrust	—	90201-30M92-00	1
25	Cover, Oil Seal	—	6E5-45344-00-00	1	74	Gear, Reverse	—	6G5-45571-02-00	1
26	Gasket, Wear Plate	18-0244	6E5-44315-A0-00	1	75	Shim (0.10mm)	—	6G5-45577-02-10	AR
27	Wear Plate	18-3345	6G5-44323-00-00	1		Shim (0.12mm)	—	6G5-45577-02-12	AR
28	Impeller	18-3071	6E5-44352-00-00	1		Shim (0.15mm)	—	6G5-45577-02-15	AR
29	Insert, Water Pump	—	6E5-44322-00-00	1		Shim (0.18mm)	—	6G5-45577-02-18	AR
30	O-Ring, Water Pump	18-7485	93210-86M38-00	1		Shim (0.30mm)	—	6G5-45577-02-30	AR
31	O-Ring, Water Pump	18-7483	93210-37M67-00	1		Shim (0.40mm)	—	6G5-45577-02-40	AR
32	Pin, Water Pump Housing	—	93606-12019-00	2		Shim (0.50mm)	—	6G5-45577-02-50	AR
33	Housing, Water Pump	18-3170	6E5-44311-00-00	1	76	Washer, Thrust	—	6G5-45576-00-00	1
34	Damper, Water Seal	—	6E5-44365-00-00	1	77	Bearing, Reverse Gear	—	93306-209U0-00	1
35	Cover, Pump Housing	—	6E5-44312-00-00	1	78	O-Ring, Bearing Housing	18-0275	93210-97M55-00	1
36	Bolt, Water Pump	—	97080-08045-00	4	79	Bearing Housing Assembly	—	6J9-45332-00-94	1
37	Washer	—	90209-08M02-00	4	80	Key, Bearing Housing	—	90282-04010-00	1
38	Nipple, Hose	—	6E5-45378-00-00	1	81	Bearing, Needle	—	93315-430U8-00	1
39	Drain, Plug Lower	18-2374	688-45341-00-00	1	82	Seal, Prop Shaft	18-0266	93101-30M17-00	2
40	Gasket, Drain Plugs	—	90430-08020-00	2	83	Washer, Tab	—	9G5-45383-01-00	1
41	Drain Plug Upper	—	90340-08M04-00	1	84	Nut, Cover	—	6G5-45384-00-00	1
42	Gasket, Drain Plugs	—	90430-08020-00	2	85	Washer, Thrust	—	6E5-45987-00-00	1
43	Pin, Locating	—	93608-12M05-00	2	86	Spacer, Prop	18-4274	688-45997-01-00	1
44	Cover, Water Inlet (Port)	—	6J9-45214-00-00	1	87	Washer, Prop	—	92990-18200-00	1
45	Cover, Water Inlet (Std)	—	6J9-45215-00-00	1	88	Nut, Prop	18-3726	90171-18M04-00	1
46	Screw, Water Inlet	—	90142-05M04-00	1	89	Pin, Cotter	18-3735	91490-40030-00	1
47	Nut, Water Inlet	—	90185-05002-00	1	90	Gear Housing Seal Kit	18-2794-1	6G5-W0001-21-00	1
48	Bolt	—	97395-10070-00	1	91	Water Pump Repair Kit	18-3311	6G5-W0078-00-00	1

AR As required



18-0021
GEAR HOUSING SEAL KIT

Replaces: 688-W0001-22-00
For: C75 (1994-99) / E75 (1995-00) / P75 (1996-99)
C80 (1997) / C85 (1992-96) / 90 (1992-02) B90(1998-99) / C90 (1997-01)

— CONTAINS —

Part #	Desc.	O.E.#	Qty.
18-0239	Gasket	688-44315-A0	1
18-0240	Gasket	688-44316-A0	1
18-7436	O-Ring	93210-46044-00-00	2
18-0267	Oil Seal	93106-09014	1
18-0587	Oil Seal	93101-25M03	4
18-4698	Plug, Drain	90430-08020	2



18-0022
GEAR HOUSING SEAL KIT

Replaces: 689-W0001-23-00
For: C25 (1992-97) / C30 (1992)

— CONTAINS —

Part #	Desc.	O.E.#	Qty.
18-99010	Exhaust Manifold Gasket	664-41134-A0-00	1
18-0296	Seal, Propshaft	93101-22067	2
18-0554	Seal	93101-20M07	2
18-0773	Gasket	689-44316-A0	1
18-4698	Plug, Drain	90430-08020	3



18-0023
GEAR HOUSING SEAL KIT

Replaces: 689-W0001-C2-00
For: C25 (1986-87) C25 (1990-91) 30 (1986) C30 (1990-91)

— CONTAINS —

Part #	Desc.	O.E.#	Qty.
18-99010	Exhaust Manifold Gasket	664-41134-A0-00	1
18-0554	Seal	93101-20M07	2
18-4698	Plug, Drain	90430-08020	3

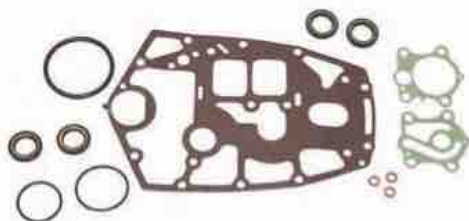

18-0024
GEAR HOUSING SEAL KIT

Replaces: 698-W0001-21-00
For: E48 (1995-00) / C55 (1989-94)

— CONTAINS —

Part #	Desc.	O.E.#	Qty.
18-0292	Gasket	663-44315-A0	1
18-0294	Gasket	663-44324-A0	1
18-0297	Seal, Drive Shaft	93101-23070	2
18-0296	Seal, Propshaft	93101-22067	2
18-0288	O-Ring	93210-41042	1
18-7160	O-Ring	93210-66M98	1
18-4698	Plug, Drain	90430-08020	3



18-0025
GEAR HOUSING SEAL KIT

Replaces: 69G-W0001-20-00
For: T8 (2001-04)

— CONTAINS —

Part #	Desc.	O.E.#	Qty.
18-7442	O-Ring	93210-74M68	1
18-4698	Plug, Drain	90430-08020	2



18-0026
GEAR HOUSING SEAL KIT
 Replaces: 6A1-W0001-22-00
 For: 2HP (1986-88)

— CONTAINS —

Part #	Desc.	O.E.#	Qty.
18-4698	Plug, Drain	90430-08020	2



18-0027
GEAR HOUSING SEAL KIT
 Replaces: 6A1-W0001-23-00
 For: 2HP (1989-02)

— CONTAINS —

Part #	Desc.	O.E.#	Qty.
18-4698	Plug, Drain	90430-08020	2



18-0028
GEAR HOUSING SEAL KIT
 Replaces: 6E0-W0001-C1-00
 For: 4HP (1984-99) / F4 (1999-02) / 5HP (1984-02)

— CONTAINS —

Part #	Desc.	O.E.#	Qty.
18-4698	Plug, Drain	90430-08020	3



18-0029
GEAR HOUSING SEAL KIT
 Replaces: 6G1-W0001-C1-00
 For: 8HP (1986-96) 8HP (1984-96)

— CONTAINS —

Part #	Desc.	O.E.#	Qty.
18-4698	Plug, Drain	90430-08020	3



18-0030
GEAR HOUSING SEAL KIT
 Replaces: 6L2-W0001-C3-00
 For: 20HP (1996-97) 25HP (1988-02) 2 cyl model

— CONTAINS —

Part #	Desc.	O.E.#	Qty.
18-0554	Seal	93101-20M07	2
18-4698	Plug, Drain	90430-08020	2



18-0031
GEAR HOUSING SEAL KIT
 Replaces: 6N0-W0001-C0-00
 For: 8HP (1997-00), 8HP (1997-04)

— CONTAINS —

Part #	Desc.	O.E.#	Qty.
18-4698	Plug, Drain	90430-08020	3



18-2785
GEAR HOUSING SEAL KIT
 Replaces: 689-W0001-21-00, 689-W0001-C1-00

— CONTAINS —

Part #	Desc.	O.E.#	Qty.
18-0776	Grommet	682-44365-00-00	1
18-0552	Grommet	689-44366-00-00	1
18-4698	Drain or Fill Washer Gasket	YSG-14090-90-8G	3
18-0554	Oil Seal	93101-20M07-00	1
18-0296	Oil Seal	93101-22067-00	2
18-7405	O-Ring	93210-40M10-00	1
18-0766	Exhaust Tube Gasket	684-41134-A0-00	1
18-0773	Wear Plate Gasket	689-44318-A0-00	1



18-2787
GEAR HOUSING SEAL KIT
 Replaces: 698-W0001-20-00, 698-W0001-C0-00

— CONTAINS —

Part #	Desc.	O.E.#	Qty.
18-4698	Drain or Fill Washer Gasket	YSG-14090-90-8G	3
18-0296	Oil Seal	93101-22067-00	2
18-0297	Oil Seal	93101-23070-00	2
18-0298	O-Ring	93210-41042-00	1
18-0299	O-Ring	93210-66M98-00	1
18-0292	Wear Plate to Pump Housing Gasket	663-44315-A0-00	1
18-0267	Oil Seal	93109-09014-00	1
18-0294	Wear Plate to Pump Base Gasket	663-44324-A0-00	1

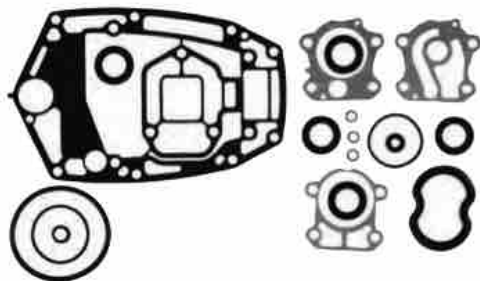

18-2788

LOWER UNIT SEAL KIT

Replaces: 6H3-W0001-21-00, 6H3-W0001-C1-00

— CONTAINS —

Part #	Desc.	O.E. #	Qty.
18-0240	Wear Plate to Gear Case Mounting Gasket	688-44316-A0-00	1
18-0756-1	Water Pump Gasket	6H3-44315-A0-00	1
18-0757	Outer Plate Gasket	6H3-44324-A0-00	1
18-4698	Drain or Fill Washer	YSG-14090-90-8G	3
18-0297	Oil Seal	93101-23070-00	2
18-0267	Oil Seal	93106-09014-00	1
18-7436	O-Ring	93210-46044-00	1

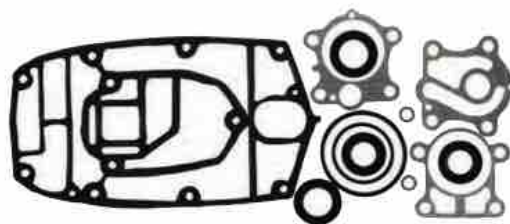

18-2789

LOWER UNIT SEAL KIT

Replaces: 6J8-W0001-21-00, 6J8-W0001-C2-00

— CONTAINS —

Part #	Desc.	O.E. #	Qty.
18-0292	Wear Plate to Pump Housing Gasket	663-44315-A0-00	1
18-0294	Wear Plate to Pump Base Gasket	663-44324-A0-00	1
18-4698	Drain or Fill Washer	YSG-14090-90-8G	2
18-0554	Oil Seal	93101-20M07-00	2
18-0297	Oil Seal	93101-23070-00	2
18-0298	O-Ring	93210-41042-00	1

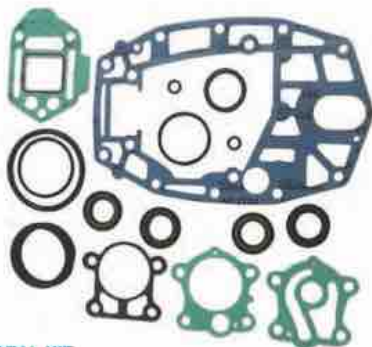

18-2792

LOWER UNIT SEAL KIT

Replaces: 6H4-W0001-21-00, 6H4-W0001-20-00

— CONTAINS —

Part #	Desc.	O.E. #	Qty.
18-0292	Wear Plate to Pump Housing Gasket	663-44315-A0-00	1
18-0294	Wear Plate to Pump Base Gasket	663-44324-A0-00	1
18-4698	Drain or Fill Washer Gasket	YSG-14090-90-8G	2
18-0296	Oil Seal	93101-22067-00	2
18-0297	Oil Seal	93101-23070-00	2
18-0298	O-Ring	93210-41042-00	1
18-0299	O-Ring	93210-86M98-00	1
18-0293	Pump Base to Gearcase Gasket	663-44316-A0-00	1



18-2794-1

LOWER UNIT SEAL KIT

Replaces: 6F3-W0001-21-00, 6F3-W0001-C1-00

6E5-W0001-51-00, 6E5-W0001-F1-00

6G5-W0001-21-00, 6G5-W0001-C1-00

— CONTAINS —

Part #	Desc.	O.E. #	Qty.
18-0244	Water Pump Gasket	6E5-44315-A0-00	1
18-4698	Drain or Fill Washer Gasket	YSG-14090-90-8G	2
18-0265	Oil Seal	93101-28M16-00	2
18-0266	Oil Seal	93101-30M17-00	2
18-0267	Oil Seal	93106-09014-00	1
18-7483	O-Ring	93210-37M67-00	1
18-7485	O-Ring	93210-86M38-00	1
18-0275	O-Ring	93210-97M55-00	1



18-2798

LOWER UNIT SEAL KIT

Replaces: 688-W0001-20-00, 688-W0001-C0-00

— CONTAINS —

Part #	Desc.	O.E. #	Qty.
18-0240	Wear Plate to Gear Case Mounting Gasket	688-44316-A0-00	1
18-4698	Drain or Fill Washer Gasket	YSG-14040-90-8G	3
18-7436	O-Ring	93210-46044-00	1
18-0239	Wear Plate to Pump Housing Gasket	688-44315-A0-00	1
18-0267	Oil Seal	93106-09014-00	1

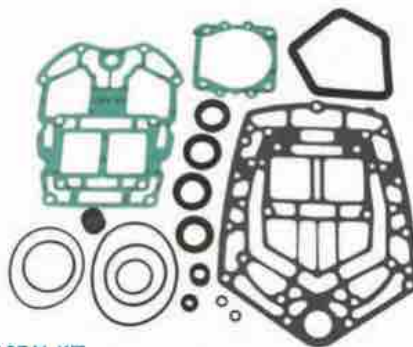

18-2799

LOWER UNIT SEAL KIT

Replaces: 61A-W0001-21-00, 61A-W0001-C1-00

— CONTAINS —

Part #	Desc.	O.E. #	Qty.
18-0244	Water Pump Gasket	6E5-44315-A0-00	1
18-4698	Drain or Fill Washer Gasket	YSG-14040-90-8G	2
18-0265	Oil Seal	93101-28M16-00	2
18-0266	Oil Seal	93101-30M17-00	1
18-0267	Oil Seal	93106-09014-00	1
18-7483	O-Ring	93210-37M67-00	1
18-7485	O-Ring	93210-86M38-00	1
18-7444	O-Ring	93210-04384-00	1



18-74501
GEAR HOUSING SEAL KIT
 Replaces: 683-W0001-C1-00
 Fits: Yamaha 9.9/15(1984-91)



18-74504
GEAR HOUSING SEAL KIT
 Replaces: 6H3-W0001-22-00
 Fits: Yamaha 60(2002), C60(1996-01),
 E60(1995-00), P60(1982-99), 70(1992-02)



18-74507
GEAR HOUSING SEAL KIT
 Replaces: 63V-W0001-21-00
 Fits: Yamaha 9.9(1997-00), 15(1997-00)



18-74510
GEAR HOUSING SEAL KIT
 Replaces: 65L-W0001-C0-00
 Fits: Yamaha 225/L225(1997-99), 3.1L, 250/
 L250(1997-99), SX225/SX250(2000-02),
 LX225/LX250(2000-02)



18-74512
GEAR HOUSING SEAL KIT
 Replaces: 66K-W0001-20-00
 Fits: Yamaha V200/V225(1998-99),
 VX200/VX225(2000-02), VX250(2002)



18-74515
GEAR HOUSING SEAL KIT
 Replaces: 68V-W0001-20-00
 Fits: Yamaha F115/LF115(2000-05)



18-74527
GEAR HOUSING SEAL KIT
 Replaces: 6G9-W0001-C6-00
 Fits: Yamaha F9.9(1997-05)



18-74535
GEAR HOUSING SEAL KIT
 Replaces: 67F-W0001-20-00
 Fits: Yamaha F75/F90(2003-05), F80/F100(1999-02)



18-74540
SEAL KIT
 Replaces: 62Y-W0001-20-00
 Fits: Yamaha F40 4cyl(1999), F50(1995-00)



18-74544
GEAR HOUSING SEAL KIT
 Replaces: 68T-W0001-20-00
 Fits: Yamaha F6/F8(2001-03)



18-74546
GEAR HOUSING SEAL KIT
 Fits: Yamaha T40/T30 Enduro International Series

GEAR HOUSING SEAL KIT APPLICATION

Model #	Year	Lower Unit Gasket Kit	Model #	Year	Lower Unit Gasket Kit	Model #	Year	Lower Unit Gasket Kit
2	1986-88	18-0026	70	1984-85, 1988-91	18-2788	VZ150	2000-11	18-2794-1
2	1989-02	18-0027	C75	1994-99	18-0021	175	1984-00	18-2794-1
4	1984-99	18-0028	E75	1995-00	18-0021	P175	1994-99	18-2794-1
F4	1999-08	18-0028	P75	1996-99	18-0021	S175	1996-99	18-2794-1
5	1984-02	18-0028	C80	1997	18-0021	V175	2000	18-2794-1
6	1988-96	18-0029	C85	1991	18-2798	VZ175	2001-11	18-2794-1
6	1997-00	18-0031	C85	1992-96	18-0021	Z175	2001-05	18-2794-1
8	1984-96	18-0029	CV85	1989-90	18-2798	200	1984-98	18-2794-1
8	1997-09	18-0031	90	1984-91	18-2798	L200	1986-99	18-2794-1
T8	2001-10	18-0025	90	1992-09	18-0021	LX200	1999-01	18-2794-1
20	1996-97	18-0030	B90	1997-99	18-0021	LZ200	2000-11	18-2794-1
25 ①	1984-85	18-2785	C90	1997-	18-0021	P200	1991-99	18-2794-1
25 ①	1986-87	18-0023	115	1986-09	18-2794-1	S200	1996-99	18-2794-1
25 ①	1988-09	18-0030	C115	1992-00	18-2794-1	SX200	1999-05	18-2794-1
25 ②	1997-02	18-2789	P115	1993-96	18-2794-1	VZ200	2001-04	18-2794-1
C25	1991	18-0023	S115	1996-99	18-2794-1	Z200	2000-11	18-2794-1
C25 ①	1992-97	18-0022	130	1988-04	18-2794-1	V6 Special	1984-86	18-2794-1
CV25	1990	18-0023	L130	1989-01	18-2794-1	V6 Excel	1987-89	18-2794-1
30	1984-85	18-2785	S130	1996-99	18-2794-1	225 ③	1990-97	18-2794-1
30	1986	18-0023	150	1984-09	18-2794-1	225 ④	1994-96	18-2799
30	1987-02	18-2789	C150	1996-99	18-2794-1	L225 ④	1994-96	18-2799
C30	1991	18-0023	L150	1986-99	18-2794-1	S225	1996	18-2799
C30	1992	18-0022	LX150	1999-01	18-2794-1	250	1990-95	18-2799
40	1984-94	18-2792	LZ150	2000-05	18-2794-1	L250	1990-96	18-2799
C40	1992-94	18-99104	Z150	2000-05	18-2794-1	S250	1996	18-2799
50	1986-94	18-2792	P150	1991-99	18-2794-1			
PRO 50	1987-90	18-2792	PX150	1999	18-2794-1			
P50	1992-94	18-2792	PRO V150	1987-90	18-2794-1			
C55	1991	18-2787	S150	1996-99	18-2794-1			
C55	1992-95	18-0024	SX150	1999-04	18-2794-1			
CV55	1989-90	18-2787	V150	2000-08	18-2794-1			
P60	1991	18-2788	VX150	2000-04	18-2794-1			

① 2 cylinder model

② 3 cylinder model

④ 3.1 liter engine

③ 2.6 liter engine



OIL SEALS

Part #	OE#	Dimensions		
		I.D.	O.D.	Width
18-0265	93101-28M18-00	27	43.25	7
18-0266	93101-30M17-00	28.5	45.25	7
18-0267	93106-09014-00	8.75	19.2	5.25
18-0296	93101-22067-00	23	36.25	6
18-0297	93101-23070-00	22.75	37.25	6
18-0554	93101-20M07-00	21.5	34	6.25
18-0570	93102-23096-00	22.75	38.25	7
18-0587	93101-25M03-00	24	40.25	6
18-0588	93102-25M28-00	24.5	48.4	8
18-2079	93101-22M15-00	21.75	35.2	6
18-2085	93102-35M13-00	34	52.25	8
18-2087	93102-40M36-00	39.5	58.25	8.5
18-2091	93104-22M07-00	22	29.25	5

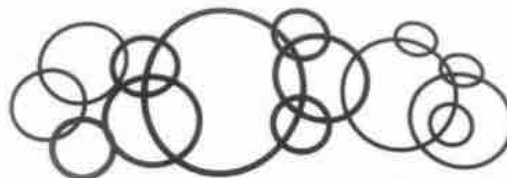

O-RINGS

Part #	Std. Pkg.	O.E.#	Part #	Std. Pkg.	O.E.#
18-0275	1	93210-97M55-00	18-7470	1	65W-43865-00-00
18-0298	1	93210-41042-00	18-7471	1	93210-94003-00
18-0299	1	93210-66M98-00	18-7483	1	93210-37M67-00
18-7119	1	93210-33M85-00	18-7485	1	93210-86M38-00
18-7432 ⑤	2	93210-32738-00	18-7511-9	5	93210-16716-00
18-7436	1	93210-46044-00	18-76689	1	65W-14198-00-00
18-7439-9	5	93210-54M54-00	18-76690	1	93210-48M16-00
18-7442	1	93210-74M35-00	18-76691	1	93210-27ME3-00
18-7444	1	93211-04384-00	18-76692	1	93210-75M51-00
18-7463	1	93210-19123-00	18-76693	1	93210-31MJ5-00
18-7468	1	6G5-43864-00-00	18-76694	1	93210-24M79
18-7469	1	64E-43869-00-00			

⑤ This product is priced per piece. To order priced per package, please add -9 to the part number.

 <p>18-6859 SOLENOID Replaces: Sea-Doo 278-001-376, 278-001-802 Sea-Doo PWC</p>	 <p>18-6860 SOLENOID PLUG Replaces: Sea-Doo Used on Sea-Doo 1995 and UP</p>	 <p>18-6862 STARTER Replaces: Yamaha 6M6-81800-10-00, 64X-81800-00-00</p>	
 <p>18-6866 STARTER Replaces: Sea-Doo 278-000-576, 278-000-577, 278-001-038, 278-001-301</p>	 <p>18-6867 STARTER Replaces: Sea-Doo 278-000-484, 278-000-485, 278-001-300, 278-001-935 Denso 228000-4550</p>	 <p>18-6868 STARTER Replaces: Sea-Doo 278-000-186, 311, 316 Denso 395435, 128000-4860, 61, 62, 63, 64</p>	
 <p>18-6869 STARTER Replaces: Sea-Doo 278-001-497, 278-001-936</p>	 <p>18-6873 STARTER Replaces: Kawasaki 21163-3715, 21163-3719 Denso 428000-0081 99-2005 JH1200 Ultra 150 w/1176cc, 2002-05 JT1200 STX-R w/1176cc</p>	 <p>18-6877 STARTER Replaces: Honda PWC 31200-HW1-671</p>	
 <p>18-6904 STARTER Replaces: Kawasaki 21163-3720, 21163-3721</p>	 <p>18-6905 STARTER Replaces: Sea-Doo 290-888-993, 999, 420-888-9933, -994, -996</p>	 <p>18-6906 STARTER Replaces: Yamaha PWC 64X-81800-00-00</p>	 <p>18-6907 STARTER Replaces: Yamaha PWC 6D3-81800-00-00 2005-08 VX1100 Wave Runner w/1100cc</p>



18-6908
STARTER

Replaces:
Yamaha PWC 63M-81800-00-00



18-6909
STARTER

Replaces:
Yamaha PWC 6S5-81800-00-00



18-6919
STARTER

Replaces: Arctic Cat PWC 3008-093,
3008-327, 3008-462, 3008-536



18-6921
STARTER

Replaces:
Yamaha PWC 60E-81800-00-00



18-6871
TRIM MOTOR

Replaces: Sea-Doo 278-001-292



18-6875
TRIM MOTOR

Replaces:
Kawasaki PWC 21174-3703
Super Sport 750,900,110 ZXI, STX, XI



18-6650
VOLTAGE REGULATOR

Replaces: 6M6-81960-A0-00
Fits: Most models 1990-2014



18-6651
VOLTAGE REGULATOR

Replaces: 66V-81960-00-00
Fits: GP1200 (2000-02); XL,
XLT1200 (1999-05)



18-6652
VOLTAGE REGULATOR

Replaces: 6K8-81960-A0-00
Fits: Waverunner 500 (1987-93)



18-6857
VOLTAGE REGULATOR

Replaces:
Yamaha PWC 63M-81960-00-00
800 1998-05; 1100 WR 1995-96; 1100
WV 1997



18-6858
VOLTAGE REGULATOR

Replaces:
Yamaha PWC 6H2-81960-00-00
GP1200 1997-99



18-6874
VOLTAGE REGULATOR

Replaces: Sea-Doo 278-001-581
GTX 4-Tec 2003-04



18-6876
VOLTAGE REGULATOR

Replaces: Sea-Doo 278-001-554



18-6878
VOLTAGE REGULATOR

Replaces: Sea-Doo 278-000-123



18-6879
VOLTAGE REGULATOR

Replaces: Sea-Doo 278-001-239



18-5129
COIL, IGNITION

Replaces: 62L-85570-00-00
Fits: 1994-1995 FX-1 FX700S, T



18-5146
COIL, LIGHTING

Replaces: 62T-85533-00-00
Fits: Wave Venture WVT700 (95-98);
Wave Raider RA700 (94-97); Wave Raider
Deluxe RA700 (1995); Wave Blaster
WB700, WB760 (96-97); Wave Runner
III WRA650 (1996); Wave Runner III
WRA700 (1997); Waverunner GP760
97-00; Wave Runner XP760 (98-99);
Wave Runner XL700 (99-04); Super Jet
SJ700 (96-11)



18-5147
CHARGE COIL

Replaces:
Yamaha 62T-85520-00-00;
62T-85520-01-00
Fits: Wave Raider RA700 (94-97); Wave
Raider Deluxe (1995); Wave Venture
WVT700 (95-98); Wave Runner III WRA650
(1996); Wave Runner III WRA700 (1997);
Super Jet SJ700 (96-06); Wave Runner
XL700 (99-04)



18-15080
IDLER GEAR ASSEMBLY

Replaces: Polaris 3240120
Yamaha 6M6-8183E00-00
Use with **18-6908**, **18-6862** Yamaha
Starters, fits some Kawasaki, Polaris,
Sea-Doo and Tiger Shark PWC's.



18-8880
OIL FILTER

Replaces: BRP 420956741
For: SeaDoo & 4 Stroke

Model	Year	Starter	Trim Motor	Voltage Regulator	Model	Year	Starter	Trim Motor	Voltage Regulator
YAMAHA					SEA-DOO (CONT.)				
EXS1200 Exciter	98-99	18-6908			GTI w/ 718cc	1996-97	18-6867		18-6878
EXT1100 Exciter	96-98	18-6908			GTI w/ 718cc	98-04	18-6867		18-6879
EXT1200 Exciter	98-99	18-6908			GTI w/ 718cc	2005	18-6867		
FX700 FX1 w/ 701cc	94-95	18-6862			GTI LE w/ 718cc	2002	18-6867		18-6879
FX1000 Wave Runner w/ 998cc	2002-05	18-6921			GTI LE w/ 718cc	2003	18-6867		
FX1100 Wave Runner w/ 1100cc	2004-05	18-6921			GTI LE w/ 718cc	2004	18-6867		
FX1800 FX Waverunner w/ 1812cc	2008	18-6909			GTI LE w/ 782cc	2005	18-6869		
GP760 Wave Runner w/ 760cc	97-00	18-6906			GTI LE RFI	2004			18-6876
GP800 Wave Runner w/ 784cc	98-05	18-6908		18-6857	GTI w/ 1494cc	2008-08	18-6905		
GP1200 Wave Runner w/ 1176cc	97-99	18-6908		18-6858	GTI RFI	2004			18-6876
GP1200 Wave Runner w/ 1176cc	2000-02	18-6908			GTI SE w/ 1494cc	2006-07	18-6905		
GP1300 Wave Runner w/ 1300cc	2003-08	18-6908			GTS w/ 581cc	92-94	18-6868		
LST1200	99-05	18-6908			GTS w/ 718cc	97-00	18-6867		18-6878
RA700 Wave Raider w/701cc	94-97	18-6862			GTS w/ 718cc	2001	18-6867		18-6879
RA760 Wave Raider w/ 760cc	1996	18-6906			GTS - 2 passenger w/ 581cc	1995	18-6867		
RA1100 Wave Raider w/ 1100cc	95-96	18-6908			GTS - 3 passenger w/ 581cc	95-96	18-6867		
SJ650 Super Jet w/ 650cc	90-93	18-6862			GTX w/ 581cc	1992	18-6868		
SJ700 Super Jet w/ 701cc	94-11	18-6862			GTX w/ 650cc	93-94	18-6868		
SRT1000	2003-05	18-6921			GTX - 2 passenger w/ 650cc	1995	18-6867		
SRT1100	2005	18-6921			GTX - 3 passenger w/ 650cc	1995	18-6867		
SUV 1200 w/1176cc	99-04	18-6908			GTX w/ 782cc	96-97	18-6866		
Wave Runner 1100cc	1995-96			18-6857	GTX DI	2000-03			18-6876
WB700 Wave Blaster w/ 701cc	93-96	18-6862			GTX RFI w/ 782cc	1998	18-6866		
WR650 Wave Runner LX w/ 650cc	90-94	18-6862			GTX RFI	2000-02			18-6876
WB760 Wave Blaster w/ 760cc	96-97	18-6906			GTX 155 w/ 1494cc	2008	18-6905		
WRA650 Wave Runner III w/650cc	90-96	18-6862			GTX 215 w/ 1494cc	2008	18-6905		
WRA700 Wave Runner III w/ 701cc	94-97	18-6862			GTX 4-Tec w/ 1494cc	2002	18-6905		
WRB650 Wave Runner w/ 650cc	91-95	18-6862			GTX 4-Tec w/ 1494cc	2003-04	18-6905		18-6874
WRB700 Wave Runner w/ 700cc	93-94	18-6862			GTX 4-Tec w/ 1494cc	2005-08	18-6905		
WVT700 Wave Vent w/ 701cc	95-98	18-6862			GTX Wake w/ 1494cc	2005-07	18-6905		
WVT760 Wave Venture w/ 760cc	1997	18-6906			GTX Wake 155 w/ 1494cc	2005-08	18-6905		
WVT1100 Wave Vent w/ 1100cc	1996	18-6908			GTX Wake 215 w/ 1494cc	2008	18-6905		
WVT1100 Wave Vent w/ 1100cc	1997	18-6908		18-6857	HX w/ 718cc	1995	18-6867		
VX1100 Wave Runner w/ 1100cc	2005-08	18-6907			HX w/ 718cc	96-97	18-6867		18-6878
XL700 Wave Runner w/ 701cc	99-04	18-6862			LRV DI	2002			18-6876
XL760 Wave Runner w/ 760cc	1997	18-6906			RX	2001-02		18-6871	
XL800 Wave Runner w/ 784cc	00-01	18-6908			RX DI	00-03		18-6871	18-6876
XL1200 Wave Runner w/ 1176cc	98-00	18-6908			RX limited	2000		18-6871	
XLT800 Wave Runner w/ 784cc	2002-04	18-6908			RXP w/ 1494cc	2004-05	18-6905	18-6871	
XLT1200 Wave Runner w/ 1176cc	2001-05	18-6908			RXP w/ 1494cc	2006-07	18-6905		
XRT1200	00-01	18-6908			RXP 155 w/ 1494cc	2008	18-6905		
SEA-DOO					RXP 215 w/ 1494cc	2008	18-6905		
3D DI w/ 782cc	2004-05	18-6869			RXP X 255 w/ 1494cc	2008	18-6905		
3D DI w/ 1494cc	2007	18-6905			RXT w/ 1494cc	2005-07	18-6905		
Explorer	93-94	18-6868			RXT 215 w/ 1494cc	2008	18-6905		
Explorer	95-97	18-6867			RXT 255 w/ 1494cc	2008	18-6905		
GS w/ 718cc	97-01	18-6867		18-6879	SP w/ 581cc	92-94	18-6868		
GSI w/ 718cc	1997	18-6867	18-6871	18-6879	SP w/ 581cc	1995	18-6867		
GSX RFI w/ 782cc	1999	18-6869			SP w/ 581cc	1996	18-6867		18-6878
GSX RFI w/ 782cc	2000	18-6869		18-6876	SP w/ 718cc	1997	18-6867		
GSX RFI w/ 782cc	2001	18-6869			SP1 w/ 581cc	93-94	18-6868		
GSX w/ 782cc	1996	18-6866	18-6871		SPI w/ 581cc	1995	18-6867		
GSX w/ 782cc	1997	18-6866	18-6871	18-6879	SPI w/ 581cc	1996	18-6867		18-6878
GSX limited	1998		18-6871		SPX w/ 581cc	1993	18-6868		

APPLICATION CONTINUED ON NEXT PAGE

Model	Year	Starter	Trim Motor	Voltage Regulator	Model	Year	Starter	Trim Motor	Voltage Regulator
SEA-DOO (CONT.)					ARCTIC CAT (Cont.)				
SPX w/ 650cc	1994	18-6868			Monte Carlo 640 w/ 639cc	94-97	18-6919		
SPX w/ 650cc	1995	18-6867			Monte Carlo 770 w/ 768cc	96-97	18-6919		
SPX w/ 718cc	1996	18-6867	18-6871	18-6878	Monte Carlo 900 w/ 900cc	1996	18-6919		
SPX w/ 782cc	1997	18-6867	18-6871		Monte Carlo 1000 w/ 999cc	1997	18-6919		
SPX w/ 782cc	98-99	18-6866	18-6871		Montego 640 w/ 639cc	94-97	18-6919		
XP w/ 581cc	1992	18-6868			Montego Dix 640 w/639cc	94-97	18-6919		
XP w/ 650cc	93-94	18-6868			Tigershark 640 w/639cc	1993	18-6919		
XP w/ 718cc	1995	18-6867	18-6871		Tigershark 900 w/900cc	1995	18-6919		
XP w/ 782cc	96-97	18-6866	18-6871		TS640 w/639cc	1993	18-6919		
XP	2002		18-6871		TS770, 770L, 770R w/ 768cc	98-99	18-6919		
XP800	ALL but '95			18-6878	TS900L w/ 900cc	1999	18-6919		
XP800	1995		18-6871		TS1000L, R w/ 999cc	1998	18-6919		
XP DI	2003-04			18-6876	TS1100Li, R w/ 1100cc	1999	18-6919		
XP Limited VTS motor	98-05		18-6871		KAWASAKI				
Challenger	1998	18-6867			JH1200 Ultra 150 w/ 1176cc	99-05	18-6873		
Challenger	96-99	18-6866			JT1200 STX-R w/ 1176cc	2002-05	18-6873		
Challenger	2004-07	18-6905			JT1200 STX-12F w/1199cc	2003-07		18-6904	
Challenger 180, 230	2008	18-6905			JT1500 STX-15F w/1498cc	2004-09		18-6904	
Islandia	2004-08	18-6905			JT1500 Ultra 250X w/ 1498cc	2007-09		18-6904	
Speedster	98-99	18-6866			JT1500 Ultra LX w/ 1498cc	2007-09		18-6904	
Speedster	95-99	18-6867			Super Sport 750	ALL		18-6875	
Speedster	2004-07	18-6905			Super Sport 900	ALL		18-6875	
Speedster 150, 200	2008	18-6905			Super Sport 110	ALL		18-6875	
Speedster Wake	2008	18-6905			Super Sport ZXI	ALL		18-6875	
Sportster	95-99	18-6867			Super Sport STX	ALL		18-6875	
Sportster	2003-06	18-6905			Super Sport XI	ALL		18-6875	
Utopia	2004-08	18-6905			HONDA				
ARCTIC CAT					Aquatrax F-12 w/ 1235cc	2002-07	18-6877		
Barracuda 639cc	94-95	18-6919			Aquatrax F-12X w/ 1235cc	2002-07	18-6877		
Daytona w/ 639cc	93-95	18-6919			Aquatrax F-12X GPSC w/ 1235cc	2005-07	18-6877		
Daytona 770 w/ 768cc	96-97	18-6919			Aquatrax R-12 w/ 1235cc	2004-06	18-6877		
Daytona 1000 w/ 999cc	1997	18-6919			Aquatrax R-12X w/ 1235cc	2003-07	18-6877		



IMPELLERS/IMPELLER KITS FOR JABSCO

 <p>18-3275 IMPELLER KIT Replaces: Jabco 17935-0001 For: TAMD74A, A-A, A-B (2000-05); TAMD74C-A, C-B (2000-05); TAMD74L-A, B (1999-2005); TAM-D74P-A, P-B (1998-2005); TAMD75P-A (1998-2005); TAMD71B (1989-2000); TAMD73P-A (1997-98); TAMD73WJ-A (1997-99)</p>	 <p>18-3304 IMPELLER KIT Replaces: Jabco 6760-0001 For: F9B Pumps DIA. 3 3/4" SIDE WIDTH 3 1/4" (Neoprene)</p>	 <p>18-3076 IMPELLER KIT Includes: Impeller & Gaskets Replaces: Jabco 22405-0001</p>	
 <p>18-3306 IMPELLER KIT Replaces: Jabco 13554-0001 Yanmar 119773-42600-00 DIA 2 1/2" SIDE WIDTH 1 1/16" (Neoprene)</p>	 <p>18-3036 IMPELLER KIT Replaces: Jabco 673-0003 (Nitrile)</p>	 <p>18-3038 IMPELLER KIT Replaces: Jabco 920-0003, 17937-0003 (Nitrile)</p>	
 <p>18-3077 IMPELLER KIT Replaces: Jabco 920-0001 12 SPLINES 8 FINS (Neoprene)</p>	 <p>18-3046 IMPELLER KIT Replaces: Jabco 18838-0001</p>	 <p>18-3047 IMPELLER KIT Replaces: Jabco 18948-0001</p>	
 <p>18-3081 IMPELLER KIT Replaces: Jabco 1210-0001 12 SPLINES 12 FINS</p>	 <p>18-3080 IMPELLER KIT Replaces: Jabco 673-0001 Diameter 2" • Side Width 1/2" (Neoprene)</p>	 <p>18-3078 IMPELLER KIT Replaces: Jabco 836-0001 Cummins 160596, 166758, 556540, 556850, 21601R Diameter 3 1/4" • Side Width 2 1/4" (Neoprene)</p>	
 <p>18-3079 IMPELLER KIT Replaces: Jabco 4528-0001 Diameter 1 1/2" • Side Width 1/2" (Neoprene)</p>	 <p>18-3075 IMPELLER KIT Replaces: Jabco 4568-0001, 2877-0001, 14510-46090, 124310-46090 Diameter 2 1/2" • Side Width 1 1/4" (Neoprene)</p>	 <p>18-3037 IMPELLER KIT Replaces: Jabco 836-0003 Diameter 3 1/2" • Side Width 2 1/2" (Nitrile)</p>	 <p>18-45713 IMPELLER KIT Replaces: Jabco 18653-0001 Fits: F4B Pump</p>

① Items ending in "D" are Display Packaged - Regular number is Non-Display



**18-3020
IMPELLER**
Replaces:
Jabsco 1210-0003
(Nitrile)



**18-2021
IMPELLER**
Replaces:
Jabsco 4598-0001
Diameter 2 9/16" • Side Width 2"
(Neoprene)



**18-45712
IMPELLER**
Replaces:
Jabsco 17636-0001,
21676-0001
Fits: F9B-9 Pump

PKG. OF 2



**18-3125
18-3125-9①**
WATER PUMP GASKET
Replaces: Jabsco 3101-0000



**18-2005
SEAL**
Replaces:
Jabsco 92700-0060

JABSCO COMPONENT APPLICATIONS

Pump Model	Impeller Kit	Oil Seal	Pump Model	Impeller Kit	Oil Seal	Pump Model	Impeller Kit	Oil Seal
777-0001	18-3077	18-2005	1673-9051	18-3081	—	3890-9011	18-3077	—
777-0003	18-3077	—	2300-9001	18-3077	—	5330-9001	18-3077	—
777-9003	18-3077	—	2300-9003	18-3077	—	5330-9101	18-3077	—
777-9004	18-3077	—	2300-9004	18-3077	—	5660-0001	18-3077	18-2005
777-9005	18-3077	—	2300-9005	18-3077	—	5660-0001	18-3077	18-2005
777-9051	18-3077	—	3270-0001	18-3081	18-2005	5850-0001	18-3081	18-2005
1673-0001	18-3081	18-2005	3270-0003	18-3081	18-2005	7120-9001	18-3077	—
1673-0003	18-3081	18-2005	3290-9001	18-3081	—	7320-9001	18-3077	—
1673-1001	18-3081	18-2005	3380-0001	18-3081	18-2005	8170-9001	18-3077	—
1637-1003	18-3081	18-2005	3480-9002	18-3081	—	17120-0001	18-3079	18-2005
1673-9001	18-3081	—	3480-9011	18-3081	—	22740-0301	—	18-2005
1673-9003	18-3081	—	3590-9001	18-3079	—	22740-0351	—	18-2005

IMPELLERS/IMPELLER KITS FOR JOHNSON PUMP



**18-3275
IMPELLER KIT**
Replaces: Johnson Pump 09-819B
For: TAMD74A, A-A, A-B (2000-05); TAMD74C-A, C-B (2000-05); TAMD74L-A, B (1999-2005); TAMD74P-A, P-B (1998-2005); TAMD75P-A (1998-2005); TAMD71B (1989-2000); TAMD73P-A (1997-98); TAMD73WJ-A (1997-99)



**18-3080
IMPELLER KIT**
Replaces: Johnson Pump 09-1026B
Diameter 2" • Side Width 1 1/4"
(Neoprene)



**18-3077
IMPELLER KIT**
Replaces: Johnson Pump 09-1028B
Yanmar 127610-42200 Cummins 650607
12 SPLINES 8 FINS



**18-3081
IMPELLER KIT**
Replaces: Johnson Pump 09-1027B
12 SPLINES 12 FINS



**18-3075
IMPELLER KIT**
Replaces: Johnson Pump 09-801B
Diameter 2 1/8" • Side Width 1 1/8"
For: Johnson Pump # F4B-8007
(Neoprene)



**18-3079
IMPELLER KIT**
Replaces: Johnson Pump 09-806B,
Yanmar 104211-42070
Diameter 1 9/16" • Side Width 3/4"
(Neoprene)



**18-3037
IMPELLER KIT**
Replaces: Johnson Pump 09-1029B-9
(Nitrile)



**18-3306
IMPELLER KIT**
Replaces: Johnson Pump 09-812B



**18-3036
IMPELLER KIT**
Replaces: Johnson Pump 09-1026B-9
(Nitrile)

① Priced per Package

② Items ending in "D" are Display Packaged - Regular number is Non-Display

 <p>18-3038 IMPELLER KIT Replaces: Johnson 09-1028B-9 (Nitrile)</p>	 <p>18-3076 IMPELLER KIT Includes: Impeller & Gaskets Replaces: Johnson Pump 09-808B, 09-45589</p>	 <p>18-3089 WATER PUMP KIT Includes: Impeller, Seal, Gasket, End & Cover Screws Replaces: Johnson Pump 09-45825 Use with 18-3587-1 Pump</p>	 <p>18-3510 WATER PUMP KIT Includes: Neoprene Impeller, Seal, Gasket, End & Cover Screws Replaces: Johnson Pump 09-45589 For: F35B-8 Pumps</p>
---	--	---	--

 <p>18-3020 IMPELLER Replaces: Johnson Pump 09-1027B-9 (Nitrile)</p>	 <p>18-45712 IMPELLER Replaces: Johnson Pump 09814B Fits: F9B-9 Pump</p>	 <p>18-45713 IMPELLER Replaces: Johnson Pump 09-810B Fits: F4B Pump</p>	 <p>18-45714 IMPELLER Replaces: Johnson Pump 09-821B Fits: F75B Pump</p>
--	--	--	--

<p>PKG. OF 2</p>  <p>18-3125 18-3125-9③ WATER PUMP GASKET Replaces: 3298-0000</p>	 <p>18-3303 COVER PLATE GASKET Replaces: Johnson Pump 01-42401 For: Johnson Pump JN-F6</p>	 <p>18-3586-1 WATER PUMP Replaces: Johnson Pump 10-24228-1 For Impeller Repair Kit use 18-3081 Use replacement Impeller 18-3020</p>	 <p>18-3587-1 WATER PUMP Replaces: Johnson Pump 10-24232-1 For Impeller Repair Kit use 18-3089</p>
---	--	--	--

IMPELLERS FOR OBERDORFER PUMPS

 <p>18-3061 IMPELLER Replaces: Oberdorfer 8922 Sherwood 10615 12 FINS For: GM engines with V-Belt</p>	 <p>②18-3075D Display Package</p> <p>18-3075 IMPELLER KIT Replaces: Oberdorfer B6620 12 FINS</p>	 <p>18-3077 IMPELLER KIT Replaces: Oberdorfer C7441 Sherwood 18200 12 SPLINES 8 FINS</p>
---	---	--

 <p>18-3078 IMPELLER KIT Replaces: Oberdorfer 7054 12 SPLINES 9 FINS</p>	 <p>①18-3046D Display Package</p> <p>18-3046 IMPELLER KIT Replaces: Sherwood 9959K with 18-3060 Impeller Replaces: Sherwood 9959</p>	 <p>18-3047 IMPELLER KIT Replaces: Sherwood 10615K with 18-3061 Impeller Replaces: Sherwood 10615</p>
--	---	--

① Priced per Package
② Items ending in "D" are Display Packaged - Regular number is Non-Display



**18-3060
IMPELLER**

Replaces: Sherwood 9959
Onan 132-0317
12 FINS



**18-3021
IMPELLER**

Replaces:
Oberdorfer 6603
Diameter 2 1/4" • Side width 2"
(Neoprene)



PKG. OF 2

**18-3140
18-3140-9**
WATER PUMP GASKET
Replaces: Sherwood 10931

SHERWOOD COMPONENT APPLICATIONS

Pump #	Impeller Kit	Impeller	Seal & Seat Assembly	Pump #	Impeller Kit	Impeller	Seal & Seat Assembly	Pump #	Impeller Kit	Impeller	Seal & Seat Assembly
A-03	—	18-3060	—	G-50	18-3047	18-3061	—	N-10410G	18-3046	18-3060	—
B-04	18-3047	18-3061	—	G-55-2	—	18-3061	—	N-10460	—	18-3060	—
C-03	18-3047	18-3061	—	G-56	—	18-3061	—	N-10470	—	18-3060	—
D-05	—	18-3061	—	G-85	18-3047	18-3061	—	N-10510G	18-3046	18-3060	—
D-65	18-3046/18-3047	18-3060/18-3061	—	G-1004	—	18-3061	—	P-101	—	18-3061	—
D-60	18-3046	18-3060	—	G-1005	—	18-3061	—	P-102	—	18-3061	—
D-65	18-3046	18-3060	—	G-1006	—	18-3061	—	P-105	18-3047	18-3061	—
D-75	18-3046	18-3060	—	G-85106	—	18-3061	—	P-10550G	18-3046/18-3047	18-3060/18-3061	—
E-35	—	18-3061	—	H-85	—	18-3061	—	P-10560G	18-3046	18-3060	—
F-10	18-3047	18-3061	—	J-70	—	18-3060	—	P-10610G	18-3046	18-3060	—
F-75	18-3047	18-3061	—	K-90	—	18-3061	—	P-10650G	18-3046	18-3060	—
F-95	—	18-3061	—	L-10	—	18-3061	18-3069	P-10710G	18-3046	18-3060	—
G-3	—	18-3061	—	L-10B	—	18-3061	—	Q-10770G	18-3046	18-3060	—
G-4	—	18-3061	—	L-80	—	18-3061	—	Q-10755G	—	18-3060	—
G-5	18-3047	18-3061	—	L-90	—	18-3061	—	Q-10855G	18-3046	18-3060	—
G-5-1	—	18-3061	—	L-9930G	18-3046	18-3060	—	R-40G	18-3046	18-3060	—
G-7	—	18-3061	—	M-70	—	18-3061	—	R-101	—	18-3061	—
G-8	—	18-3061	—	M-71	—	18-3061	—	R-102	—	18-3060	—
G-7B	—	18-3061	—	M-10065G	—	18-3060	—	R-10670G	18-3046	18-3060	—
G-15	—	18-3060	—	M-10180G	18-3046	18-3060	—	R-10920G	18-3046	18-3060	—
G-26	—	18-3061	—	M-10210G	18-3046	18-3060	—	R-10930G	18-3046	18-3060	—
G-30-2	—	18-3060	—	M-10263G	18-3046	18-3060	—	R-10935G	18-3046	18-3060	—
G-30-2B	—	18-3060	—	M-10264G	18-3046	18-3060	—	R-10970G	18-3046	18-3060	—
G-45-1	—	18-3061	—	M-10270G	18-3046	18-3060	—	RP-B-C	—	18-3061	—
G-45-2	—	18-3061	—	M-10280G	18-3046	18-3060	—	S-11040G	18-3046	18-3061	—
G-46	—	18-3061	—	N-10390G	18-3046	18-3060	—	S-11095G	—	18-3061	—



**18-2434
FLYWHEEL BELL HOUSING**

Replaces:
Crusader 96938
Marine Power 0100-000
Mercruiser 814309A1
Pleasurecraft R142006
Volvo Penta 3857846-4
GM V-8's Big & Small Block Inboard/Ski models.



**18-2589
TRANSMISSION OIL COOLER**

- 1" Water Hose Connection
- 8" Tube Bundle Overall Length
- Approximately 12"
- Oil-6 GPM MAX Water 25 GPM MAX
- Shipped bare metal, ready for primer and factory paint finish.



**18-2587
TRANSMISSION OIL COOLER**
Replaces: Mercruiser 99356A2

- Replacement Power Steering Cooler for Mercruiser
- Power Steering Fluid-4 GPM MAX Water 25 GPM MAX
- 6" tube bundle, overall length 8", 1 1/4" water inlet and outlet
- Shipped bare metal, ready for primer and factory paint finish.



**18-2588
TRANSMISSION OIL COOLER**

- 1 1/2" Water Hose Connection
- 9" x 2" and 1/2" NPT Inlet/Outlet Oil Fitting
- Oil-6 GPM MAX Water 25 GPM MAX
- 10" tube bundle, overall length 12", 1 1/4" water inlet and outlet
- Shipped bare metal, ready for primer and factory paint finish.

TRANSMISSION REPAIR KITS

18-2590 SEAL KIT

Replaces: Borg Warner A4876HA
 * Service kit for Borg-Warner Velvet Drive 71 and 72 series transmission



18-2591 OVERHAUL KIT

Includes: Gaskets, Seals, Sealing Rings, Bronze and Steel Plates
 * Service kit for Borg-Warner Velvet Drive 71 and 72 series transmission



ANODES

SHAFT ANODES

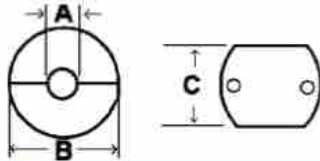

ZINC ANODES		NOMINAL DIMENSIONS			
Part #	Nom. Weight LBS. (KG)	A-Diameter IN. (MM)	Dimension B IN. (MM)	Dimension C IN. (MM)	
18-6040	.90 (.40)	1 1/8 (29)	2 1/8 (54)	2 1/8 (54)	
18-6041-1	1.65 (.75)	1 1/4 (33)	2 5/8 (67)	2 1/2 (64)	
18-6043-1	1.45 (.65)	1 1/2 (38)	2 1/2 (64)	2 1/2 (64)	

RUDDER ANODES

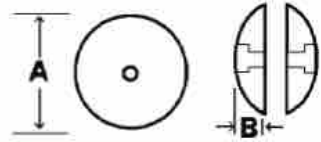

ZINC ANODES		NOMINAL DIMENSIONS		
Part #	Nom. Weight LBS. (KG)	A-Diameter IN. (MM)	Dimension B IN. (MM)	
18-6045	.20 (.09)	1 7/8 (47)	1/4 (6)	
18-6046	.90 (.40)	2 13/16 (71)	1/2 (13)	
18-6047	1.40 (.64)	3 3/4 (95)	1/2 (13)	
18-6107	-	5 (127)	5/8 (16)	
18-6108	4.63 (2.10)	5 1/8 (130)	7/8 (22)	
18-6109	9.32 (4.22)	6 1/2 (165)	7/8 (22)	

COMPLETE ENGINE ANODES (with Brass Plug)

ZINC ANODES		NOMINAL DIMENSIONS			Replacement Anode Only
Part #	Nom. Weight LBS. (KG)	A-Length IN. (MM)	B-Diameter IN. (MM)	Plugs (pis) IN. (MM)	
18-6134	.12 (.05)	2-0 (50)	1/4 (6)	1/8 (3)	18-6050
18-6059	.10 (.05)	1 3/4 (44)	3/8 (10)	1/4 (6)	18-6135
18-6060	.20 (.09)	2-0 (50)	1/2 (13)	3/8 (10)	18-6052
18-6136	.20 (.09)	2-0 (50)	3/8 (10)	3/8 (10)	18-6053
18-6062	.30 (.14)	2-0 (50)	5/8 (16)	1/2 (13)	18-6137
18-6063	.45 (.20)	2-0 (50)	3/4 (19)	3/4 (19)	-

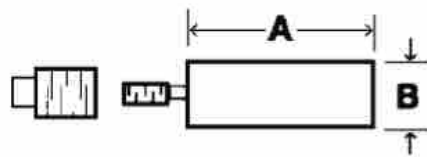

PACKING (* All 3 foot packing comes in display packaging)

PREMIUM SQUARE MARINE TEFLON PACKAGING					PREMIUM SQUARE MARINE LUBRICATED FLAX PACKAGING				
AP#	Diameter	Length*	Wt. (lbs.)	Pkg.	AP#	Diameter	Length*	Wt. (lbs.)	Pkg.
4720	1/8"	3 ft.	—	1	4701	3/16"	3 ft.	—	1
4730	1/8"	—	1	1	4711	3/16"	—	1	1
4721	3/16"	3 ft.	—	1	4702	1/4"	3 ft.	—	1
4731	3/16"	—	1	1	4712	1/4"	—	1	1
4722	1/4"	3 ft.	—	1	4703	5/16"	3 ft.	—	1
4732	1/4"	—	1	1	4713	5/16"	—	1	1
4723	5/16"	3 ft.	—	1	4714	3/8"	—	1	1
4733	5/16"	—	1	1	4705	1/2"	3 ft.	—	1
4724	3/8"	3 ft.	—	1	4715	1/2"	—	1	1
4734	3/8"	—	1	1					
4725	1/2"	3 ft.	—	1					
4735	1/2"	—	1	1					

18-6140 ZINC ANODE

Replaces: 301068
 For: 5424, M-30, M-35, M3-20, M3-20A, M4-30, M4-30A, M-35A



18-6141 ZINC ANODE







Replaces: 301069
 For: 5416, M-12, M-18, M-20, M-25, M-25XP, M-25XPA, M-30, M2-12



SHAFT KEY

Part #	Shaft Dimensions
18-2334	2 1/8" x 1/4"



<p>①18-5250D </p>  <p>18-5250 TUNE-UP KIT</p> <p>—CONTAINS—</p> <table border="1"> <thead> <tr> <th>Part #</th> <th>O.E. #</th> <th>Description</th> </tr> </thead> <tbody> <tr> <td>18-5311</td> <td>16.69-00049</td> <td>Contact Set</td> </tr> <tr> <td>18-5345</td> <td>16.69-00050</td> <td>Condenser</td> </tr> <tr> <td>18-5418</td> <td>16.69-00051</td> <td>Rotor</td> </tr> </tbody> </table> <p>Delco 4 & 6 cyl.</p>	Part #	O.E. #	Description	18-5311	16.69-00049	Contact Set	18-5345	16.69-00050	Condenser	18-5418	16.69-00051	Rotor	<p>①18-5251D </p>  <p>18-5251 TUNE-UP KIT</p> <p>—CONTAINS—</p> <table border="1"> <thead> <tr> <th>Part #</th> <th>O.E. #</th> <th>Description</th> </tr> </thead> <tbody> <tr> <td>18-5314</td> <td>16.69-00039</td> <td>Contact Set</td> </tr> <tr> <td>18-5338</td> <td>16.69-00040</td> <td>Condenser</td> </tr> <tr> <td>18-5404-1</td> <td>16.69-00149</td> <td>Rotor</td> </tr> </tbody> </table> <p>Mallory 8 cyl. Tall Cap</p>	Part #	O.E. #	Description	18-5314	16.69-00039	Contact Set	18-5338	16.69-00040	Condenser	18-5404-1	16.69-00149	Rotor	 <p>18-5252 TUNE-UP KIT</p> <p>—CONTAINS—</p> <table border="1"> <thead> <tr> <th>Part #</th> <th>Description</th> </tr> </thead> <tbody> <tr> <td>18-5310</td> <td>Contact Set</td> </tr> <tr> <td>18-5344</td> <td>Condenser</td> </tr> <tr> <td>-</td> <td>Rotor</td> </tr> </tbody> </table> <p>Delco 8 cyl.</p>	Part #	Description	18-5310	Contact Set	18-5344	Condenser	-	Rotor	<p>①18-5255D </p>  <p>18-5255 TUNE-UP KIT</p> <p>—CONTAINS—</p> <table border="1"> <thead> <tr> <th>Part #</th> <th>Description</th> </tr> </thead> <tbody> <tr> <td>18-5303</td> <td>Contact Set</td> </tr> <tr> <td>18-5345</td> <td>Condenser</td> </tr> <tr> <td>18-5407</td> <td>Rotor</td> </tr> </tbody> </table> <p>Prestolite 8 cyl.</p>	Part #	Description	18-5303	Contact Set	18-5345	Condenser	18-5407	Rotor				
Part #	O.E. #	Description																																													
18-5311	16.69-00049	Contact Set																																													
18-5345	16.69-00050	Condenser																																													
18-5418	16.69-00051	Rotor																																													
Part #	O.E. #	Description																																													
18-5314	16.69-00039	Contact Set																																													
18-5338	16.69-00040	Condenser																																													
18-5404-1	16.69-00149	Rotor																																													
Part #	Description																																														
18-5310	Contact Set																																														
18-5344	Condenser																																														
-	Rotor																																														
Part #	Description																																														
18-5303	Contact Set																																														
18-5345	Condenser																																														
18-5407	Rotor																																														
 <p>18-5256 TUNE-UP KIT</p> <p>—CONTAINS—</p> <table border="1"> <thead> <tr> <th>Part #</th> <th>O.E. #</th> <th>Description</th> </tr> </thead> <tbody> <tr> <td>18-5314</td> <td>16.69-00039</td> <td>Contact Set</td> </tr> <tr> <td>18-5338</td> <td>16.69-00040</td> <td>Condenser</td> </tr> <tr> <td>18-5411</td> <td>16.69-00042</td> <td>Rotor</td> </tr> </tbody> </table> <p>Mallory 8 cyl. Flat Cap</p>	Part #	O.E. #	Description	18-5314	16.69-00039	Contact Set	18-5338	16.69-00040	Condenser	18-5411	16.69-00042	Rotor	<p>①18-5258D </p>  <p>18-5258 TUNE-UP KIT</p> <p>—CONTAINS—</p> <table border="1"> <thead> <tr> <th>Part #</th> <th>Description</th> </tr> </thead> <tbody> <tr> <td>18-5303</td> <td>Contact Set</td> </tr> <tr> <td>18-5347</td> <td>Condenser</td> </tr> <tr> <td>18-5407</td> <td>Rotor</td> </tr> </tbody> </table> <p>Prestolite 8 cyl.</p>	Part #	Description	18-5303	Contact Set	18-5347	Condenser	18-5407	Rotor	 <p>18-5259 TUNE-UP KIT</p> <p>—CONTAINS—</p> <table border="1"> <thead> <tr> <th>Part #</th> <th>Description</th> </tr> </thead> <tbody> <tr> <td>18-5303</td> <td>Contact Set</td> </tr> <tr> <td>18-5347</td> <td>Condenser</td> </tr> <tr> <td>18-5429</td> <td>Rotor</td> </tr> </tbody> </table> <p>Prestolite 6 & 8 cyl.</p>	Part #	Description	18-5303	Contact Set	18-5347	Condenser	18-5429	Rotor																	
Part #	O.E. #	Description																																													
18-5314	16.69-00039	Contact Set																																													
18-5338	16.69-00040	Condenser																																													
18-5411	16.69-00042	Rotor																																													
Part #	Description																																														
18-5303	Contact Set																																														
18-5347	Condenser																																														
18-5407	Rotor																																														
Part #	Description																																														
18-5303	Contact Set																																														
18-5347	Condenser																																														
18-5429	Rotor																																														
<p>①18-5260D </p>  <p>18-5260 TUNE-UP KIT</p> <p>—CONTAINS—</p> <table border="1"> <thead> <tr> <th>Part #</th> <th>Description</th> </tr> </thead> <tbody> <tr> <td>18-5303</td> <td>Contact Set</td> </tr> <tr> <td>18-5345</td> <td>Condenser</td> </tr> <tr> <td>18-5403</td> <td>Rotor</td> </tr> </tbody> </table>	Part #	Description	18-5303	Contact Set	18-5345	Condenser	18-5403	Rotor	 <p>18-5266 TUNE-UP KIT</p> <p>Flame Thrower</p> <p>Fits: Flame Thrower Distributors 18-5481, 18-5482, 18-5483, 18-5477, 18-5478 and 18-5479</p>	<p>①18-5268D </p>  <p>18-5268 TUNE-UP KIT</p> <p>—CONTAINS—</p> <table border="1"> <thead> <tr> <th>Part #</th> <th>O.E. #</th> <th>Description</th> </tr> </thead> <tbody> <tr> <td>18-5311</td> <td>16.69-00049</td> <td>Contact Set</td> </tr> <tr> <td>18-5345</td> <td>16.69-00050</td> <td>Condenser</td> </tr> <tr> <td>18-5418</td> <td>16.69-00051</td> <td>Rotor</td> </tr> <tr> <td>18-5385</td> <td>16.69-00052</td> <td>Distributor Cap</td> </tr> </tbody> </table> <p>GM 4 Cyl. • Single Point</p>	Part #	O.E. #	Description	18-5311	16.69-00049	Contact Set	18-5345	16.69-00050	Condenser	18-5418	16.69-00051	Rotor	18-5385	16.69-00052	Distributor Cap																						
Part #	Description																																														
18-5303	Contact Set																																														
18-5345	Condenser																																														
18-5403	Rotor																																														
Part #	O.E. #	Description																																													
18-5311	16.69-00049	Contact Set																																													
18-5345	16.69-00050	Condenser																																													
18-5418	16.69-00051	Rotor																																													
18-5385	16.69-00052	Distributor Cap																																													
 <p>18-5269 TUNE-UP KIT</p> <p>—CONTAINS—</p> <table border="1"> <thead> <tr> <th>Part #</th> <th>O.E. #</th> <th>Description</th> </tr> </thead> <tbody> <tr> <td>18-5311</td> <td>16.69-00049</td> <td>Contact Set</td> </tr> <tr> <td>18-5345</td> <td>16.69-00050</td> <td>Condenser</td> </tr> <tr> <td>18-5418</td> <td>16.69-00051</td> <td>Rotor</td> </tr> <tr> <td>18-5386</td> <td>-</td> <td>Distributor Cap.</td> </tr> </tbody> </table> <p>GM V-6 • Single Point</p>	Part #	O.E. #	Description	18-5311	16.69-00049	Contact Set	18-5345	16.69-00050	Condenser	18-5418	16.69-00051	Rotor	18-5386	-	Distributor Cap.	<p>①18-5271D </p>  <p>18-5271 TUNE-UP KIT</p> <p>—CONTAINS—</p> <table border="1"> <thead> <tr> <th>Part #</th> <th>O.E. #</th> <th>Description</th> </tr> </thead> <tbody> <tr> <td>18-5314</td> <td>16.69-00039</td> <td>Contact Set</td> </tr> <tr> <td>18-5338</td> <td>16.69-00040</td> <td>Condenser</td> </tr> <tr> <td>18-5376</td> <td>16.69-00148</td> <td>Distributor Cap</td> </tr> <tr> <td>18-5404-1</td> <td>16.69-00149</td> <td>Rotor</td> </tr> </tbody> </table> <p>Mallory Tall • V-8 • Single Point</p>	Part #	O.E. #	Description	18-5314	16.69-00039	Contact Set	18-5338	16.69-00040	Condenser	18-5376	16.69-00148	Distributor Cap	18-5404-1	16.69-00149	Rotor	<p>①18-5272D </p>  <p>18-5272 TUNE-UP KIT</p> <p>—CONTAINS—</p> <table border="1"> <thead> <tr> <th>Part #</th> <th>O.E. #</th> <th>Description</th> </tr> </thead> <tbody> <tr> <td>18-5314</td> <td>16.69-00039</td> <td>Contact Set</td> </tr> <tr> <td>18-5338</td> <td>16.69-00040</td> <td>Condenser</td> </tr> <tr> <td>18-5375</td> <td>16.69-00100, F6900165</td> <td>Distributor Cap</td> </tr> <tr> <td>18-5411</td> <td>16.69-00042</td> <td>Rotor</td> </tr> </tbody> </table> <p>Mallory Flat • V-8 • Single Point</p>	Part #	O.E. #	Description	18-5314	16.69-00039	Contact Set	18-5338	16.69-00040	Condenser	18-5375	16.69-00100, F6900165	Distributor Cap	18-5411	16.69-00042	Rotor
Part #	O.E. #	Description																																													
18-5311	16.69-00049	Contact Set																																													
18-5345	16.69-00050	Condenser																																													
18-5418	16.69-00051	Rotor																																													
18-5386	-	Distributor Cap.																																													
Part #	O.E. #	Description																																													
18-5314	16.69-00039	Contact Set																																													
18-5338	16.69-00040	Condenser																																													
18-5376	16.69-00148	Distributor Cap																																													
18-5404-1	16.69-00149	Rotor																																													
Part #	O.E. #	Description																																													
18-5314	16.69-00039	Contact Set																																													
18-5338	16.69-00040	Condenser																																													
18-5375	16.69-00100, F6900165	Distributor Cap																																													
18-5411	16.69-00042	Rotor																																													
 <p>18-5275 TUNE-UP KIT</p> <p>—CONTAINS—</p> <table border="1"> <thead> <tr> <th>Part #</th> <th>Description</th> </tr> </thead> <tbody> <tr> <td>18-5303</td> <td>Contact Set</td> </tr> <tr> <td>18-5347</td> <td>Condenser</td> </tr> <tr> <td>18-5352</td> <td>Distributor Cap</td> </tr> <tr> <td>18-5403</td> <td>Rotor</td> </tr> </tbody> </table> <p>Single Point • Screw Cap • V-8</p>	Part #	Description	18-5303	Contact Set	18-5347	Condenser	18-5352	Distributor Cap	18-5403	Rotor	<p>①18-5277D </p>  <p>18-5277 TUNE-UP KIT</p> <p>—CONTAINS—</p> <table border="1"> <thead> <tr> <th>Part #</th> <th>Description</th> </tr> </thead> <tbody> <tr> <td>18-5303</td> <td>Contact Set</td> </tr> <tr> <td>18-5347</td> <td>Condenser</td> </tr> <tr> <td>18-5369</td> <td>Distributor Cap</td> </tr> <tr> <td>18-5407</td> <td>Rotor</td> </tr> </tbody> </table> <p>Single Point • Clip Cap • V-8</p>	Part #	Description	18-5303	Contact Set	18-5347	Condenser	18-5369	Distributor Cap	18-5407	Rotor	 <p>18-5303 CONTACT SET</p>	 <p>18-5307 CONTACT SET</p>																								
Part #	Description																																														
18-5303	Contact Set																																														
18-5347	Condenser																																														
18-5352	Distributor Cap																																														
18-5403	Rotor																																														
Part #	Description																																														
18-5303	Contact Set																																														
18-5347	Condenser																																														
18-5369	Distributor Cap																																														
18-5407	Rotor																																														

APPLICATION BEGINS ON PAGE 583

① Items ending in "D" are Display Packaged - Regular number is Non-Display

 <p>18-5310 CONTACT SET</p>	 <p>18-5311 CONTACT SET Replaces: 16.69-00049</p>	 <p>18-5314 CONTACT SET Replaces: 16.69-00039</p>	 <p>18-5338 CONDENSER Replaces: 16.69-00040</p>	 <p>18-5344 CONDENSER</p>
 <p>18-5345 CONDENSER Replaces: 16.69-00050</p>	 <p>18-5346 CONDENSER Replaces: 1869704</p>	 <p>18-5347 CONDENSER</p>	 <p>18-5300 ROTOR Fits: Flamethrower Distributors</p>	
 <p>18-5403 ROTOR</p>	 <p>18-5404-1 ROTOR Replaces: 16.69-00149</p>	 <p>18-5407 ROTOR</p>	 <p>18-5411 ROTOR Replaces: 16.69-00042</p>	
 <p>18-5418 ROTOR Replaces: 16.69-00051</p>	 <p>18-5419 ROTOR</p>	 <p>18-5427 ROTOR Replaces: 16.69-0022</p>	 <p>18-5429 ROTOR</p>	
 <p>18-5352 DISTRIBUTOR CAP Prestolite</p>	 <p>18-5359 DISTRIBUTOR CAP</p>	 <p>18-5369 DISTRIBUTOR CAP Prestolite W/Gasket 18-5399</p>	 <p>18-5375 DISTRIBUTOR CAP Replaces: 16.69-00100, FI 6900165 Mallory</p>	
 <p>18-5376 DISTRIBUTOR CAP Replaces: 16.69-00148 Mallory</p>	 <p>18-5385 DISTRIBUTOR CAP Replaces: 16.69-00052 Delco</p>	 <p>18-5386 DISTRIBUTOR CAP Delco</p>	 <p>18-5301 TUNE-UP KIT Fits: male cap v-8 flamethrower distributors</p>	

APPLICATION BEGINS ON PAGE 583



**18-5302
TUNE-UP KIT**
Fits: male cap v-8 flamethrower distributors



**18-5226
IGNITION WIRE**
Metallic Core
100' Spool • 7mm Hypalon



PKG. OF 10
**18-5224
18-5224-9**
SPARK PLUG WIRE TERMINAL
Replaces: Mercury 20121
OMC 510364



**18-5225
SPARK PLUG WIRE KIT**
Replaces: Mercury 84-99215A26,
84-813706A26

Kit includes 25 ft. Roll of 7 MM Hypalon Ignition Wire With a Metallic Core and a Large Assortment of Three Different End Fittings.



PKG. OF 10
**18-5750
18-5750-9**
UNIVERSAL SPARK PLUG BOOTS
Supplied complete w/Terminal Connector
Replaces: OMC 581027, 580339



**18-5752
UNIVERSAL
SPARK PLUG BOOTS**
8mm

PREMIUM MARINE SPARK PLUG WIRE LEADS

Sierra's MAGFORCE Ignition Wires are "Electronics Friendly" protecting all of your electronic devices and electronic engine controls from RFI and EMI while delivering the maximum amount of voltage. Exact fit design ensures easy installation and years of trouble - free service.



CHRIS-CRAFT

Engine	Cyl.	Distributor	Year Start	Year Stop	Plug Wire Set
181 CID (3.0L)	4	Conventional	ALL	ALL	18-8800-1
302	8	Conventional	ALL	ALL	18-28044
351	8	Conventional	ALL	ALL	18-28044
460	8	Conventional	ALL	ALL	18-28044
350	8	Conventional	1970	1990	18-8803-2
350	8	Conventional	1970	1990	18-8823-1
454	8	Conventional	ALL	ALL	18-8817-1
502	8	Conventional	ALL	ALL	18-8817-1

● Models designed with Mallory side terminals



FEATURES

- Senses current levels in the coil and adjusts the dwell to maintain peak energy throughout the entire RPM range.
- Develops, on average, 4 times more available energy between 3000 and 5000 RPM's and twice as much plug voltage as point-type systems.
- Ignition energy is sustained and coil life is increased when peak current level is reached just prior to spark.
- More stable timing.
- Use with 18-5472 "Flame Thrower II" Coil for optimum performance



18-5288
HI-PERFORMANCE ELECTRONIC CONVERSION KIT
Fits: Most Prestolite V-8 with snap down cap



18-5289
HI-PERFORMANCE ELECTRONIC CONVERSION KIT
Fits: Most Prestolite V-8 Distributors with screw down cap



18-5290
HI-PERFORMANCE ELECTRONIC CONVERSION KIT
Fits: Most Mallory YL or YD 8 cylinder Distributors with clockwise and counter clockwise rotation



FEATURES



Conventional wiring system



Ignitor wiring system

- Replaces points & condensers for true solid state ignition.
- Uses standard coil, cap and rotor.
- Easy to install, one-piece, 2-wire hook-up.
- Accurate to within 1/4° timing accuracy 0 to 6000 RPM range.
- Can be used with Flame Thrower coils 18-5466 & 18-5469.



18-5294
ELECTRONIC CONVERSION KIT
Fits: 6 cyl. Delco distributors



18-5295
ELECTRONIC CONVERSION KIT
Fits most 4 cyl. Prestolite distributors. (Except IBM 7026)
For: Onan, Universal, Waukesha, Wisconsin



18-5298
ELECTRONIC CONVERSION KIT
(with snap down cap)
For: Most Prestolite V-8 Distributors



18-5296-2D Display Package
18-5296-2
ELECTRONIC CONVERSION KIT
Fits: Most Mallory V-8 YL & YD 8 cyl. Distributors with clockwise or counter-clockwise rotation



18-5299
ELECTRONIC CONVERSION KIT
(with screw down cap)
For: Most Prestolite V-8 Distributors
Use with 18-5403 style rotor



18-9801
MULTI METER/DVA TESTER
Tests electrical and ignition systems. Consists of a VOA meter with built-in direct voltage adapter.



18-9802
TIMING LIGHT
Self-powered accurate up to 10,000 RPM's

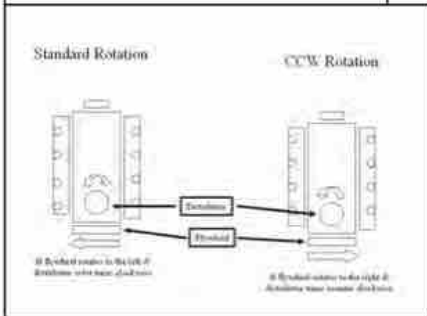

18-5483
HI-PERFORMANCE ELECTRONIC DISTRIBUTOR
Fits: Chevrolet Marine Small and Big Block engines (Standard Deck Height)

- Distributors feature the Ignitor II ignition module with adaptive dwell control adjusts the spark timing over the entire RPM range to maximize performance
- Upper roller bearing and oil impregnated bronze sintered bottom bushing are installed and aligned bored for accuracy for maximum durability
- Machined heat treated gear with tight tolerances insures durability and consistent timing to maximize and performance. Complete with high dielectric strength cap and rotor for years of performance
- Replacement cap/rotor kit: 18-5266

APPLICATION BEGINS ON PAGE 583
① Items ending in "D" are Display Packaged - Regular number is Non-Display

**18-5313-1
DISTRIBUTOR**

Replaces: Mallory YL624MW
For most GM V-8 Engrs. (small & large blocks)
Uses: 18-5251 TUNE-UP KIT

- **CONTAINS** —
- | | |
|---------------|--------------|
| Part # | Desc. |
| 18-5314 | Contact Set |
| 18-5338 | Condenser |
| 18-5404-1 | Rotor |
- And 18-5376 CAP



**18-5494-2
ELECTRONIC DISTRIBUTOR**

U.L. Approved Conventional Rotation
For: Chevrolet All V8 (exc. 348, 409 & Tall Deck Big Block) includes 482, 502, 540 CID
USES:

Part #	Description
18-5376	Distributor Cap
18-5404-1	Rotor
18-5488	Module



**18-5480
COMPLETE IGNITION
CONVERSION KIT**

Fits: GM SB & BB with Standard Deck Height

- **CONTAINS** —
- | | |
|---------------|--------------------|
| Part # | Description |
| 18-5472 | Coil |
| 18-8803-2 | Wire Set |
| 18-5483 | Distributor |



**18-5433
IGNITION COIL
(Uses External Resistor)**



**18-5435
IGNITION COIL
(Has Internal Resistor)**



FEATURES

- Oil filled for better cooling and long life
- Low resistance and improved turn ratios produces the higher voltage needed to run larger spark plug gaps for added power and better fuel economy
- More windings maximize energy and reliability over the full RPM range
- Fits existing brackets for easy installation

**18-5466
HI-PERFORMANCE
IGNITION COIL**

1.5 ohm (oil filled), black - 8 cylinder;

- Flame-Thrower 40,000 volt coil.
- Designed for use with the original Ignitor Electronic Conversion Kits
- Can be used with other inductive ignition systems



**18-5469
HI-PERFORMANCE
IGNITION COIL**

3.0 ohm (oil filled), black - 4 & 6 cylinder; Flame-Thrower 40,000 volt coil.

- Designed for use with the original Ignitor Electronic Conversion Kits
- Can be used with other inductive ignition systems



**18-5472
HI-PERFORMANCE
IGNITION COIL**

0.6 ohm (oil filled), black - 4, 6, & 8 cylinder; Flame-Thrower 45,000 volt coil.

- Super low 0.6 ohm resistance coil designed for use with the Ignitor II Hi Performance Electronic Conversion Kits
- Compatible with capacitive discharge systems



Part No.	Description	Recommended Coil	Resistance Ohms	Part No.	Description	Recommended Coil	Resistance Ohms
18-5294	Electronic Conversion Kit	18-5469	3	18-5288	Hi Performance Electronic Conversion Kit	18-5472	0.6
18-5295	Electronic Conversion Kit	18-5469	3	18-5289	Hi Performance Electronic Conversion Kit	18-5472	0.6
18-5296-2	Electronic Conversion Kit	18-5466	1.5	18-5290	Hi Performance Electronic Conversion Kit	18-5472	0.6
18-5298	Electronic Conversion Kit	18-5466	1.5	18-5483	Flame-Thrower Distributor	18-5472	0.6
18-5299	Electronic Conversion Kit	18-5466	1.5				

**18-5450
COIL RESISTOR
1.5 OHM**



IGNITION/ELECTRICAL SYSTEMS APPLICATION

Year	Cyl.	Model	Distributor No.	Contact Set	Condenser	Rotor	Dist. Cap	Tune-Up Kit	Distributor	Elect. Conv. Kit
1946-62	4	B,BR,BR3	IGW-4152, C	—	—	—	18-5359	—	—	—
1946-68	4	A,B,BR,BR3	IAY-4010	18-5307	18-5345 ①	18-5427	—	—	—	—
1975-80	4	FL153,181	—	18-5311	18-5338	18-5418	18-5385	—	—	—
1947-60	6	M,ML,MLO,MO, K,KL,KLO,KO	IAY-4009	18-5307	—	18-5427	—	—	—	—
1947-63	6	KS,KSO,KR, W,WO	IAY-4009	18-5307	—	18-5427	—	—	—	—
1947-63	6	W,WO	IGC-4279B	—	18-5345 ①	—	—	—	—	—
1967-71	6	225B, BVC	1110342	18-5310	18-5346	18-5419	—	—	—	—
1958-67	8	283, 283-0 Corvette Eng.	IBB-4109A	18-5303	18-5345 ①	18-5404-1	—	—	18-5313-1 ② 18-5494-2 ③	18-5296-1
1963-71	8	283F, 327F Corvette Eng.	IBM-4115, 4116	18-5303	18-5345 ①	18-5429	—	18-5259	18-5494-2 ③	—
1958-67	8	Dual Contact	IBB-4201A, B	18-5303 ②	18-5345 ①	18-5404-1	—	—	—	18-5296-1
1958-68	8	Dual Contact	IBB-4301A, B	18-5303 ②	18-5345 ①	18-5407	18-5369	18-5255 ⑤	—	18-5298
1958-67	8	Dual Contact	1110630	—	18-5346	—	—	—	—	—
1979-90	8	ALL	IBM-7011	18-5303	18-5345 ①	18-5407	18-5369	18-5255 ⑤	—	18-5298
1981-85	8	ALL	IBM-7013	18-5303	18-5345 ①	18-5403	18-5352	18-5260 ⑥	—	18-5299

① For Strap Type Condenser, Use 18-5347
 ② Two Required

③ Contact Controlled Distributor
 ④ Electronic Ignition Distributor

⑤ 18-5277 Kit with distributor cap
 ⑥ 18-5275 Kit with distributor cap



**18-6835
STARTER**
Replaces: GM Engines Universal
 Used on all GM Engines with either 14 1/4" or 12 3/4" flywheels.



**18-5911
STARTER**
 Replacement Solenoid: 18-5837
(Heavy-Duty) (No Core)
 For: GM Engines, Bottom Mount Straight Across Bolt Pattern, Standard Rotation, Clockwise
Replaces: 16.61-00042
SAEJ1171

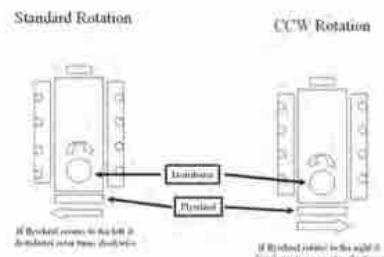

Standard Rotation CCW Rotation

If flywheel covers to the left of distributor pole piece direction

If flywheel rotates to the right of distributor pole piece direction

BATTERY CABLES
 Gauge cable with soldered lug terminals on each end to accept a 3/8" stud.



Part #	Size	Color	Gauge	Part #	Size	Color	Gauge
BC88523	2'	red	4	BC88563	6'	red	2
BC88533	2'	black	4	BC88573	6'	black	2
BC88543	4'	red	2	BC88583	8'	red	1
BC88553	4'	black	2	BC88593	8'	black	1



**18-5838
SOLENOID**
 Delco



**18-5717
STARTER BRUSH SET**
 Delco



**18-5840
SOLENOID**
 Prestolite 15-78, SAW4201, SAW4207, SAW4210



**18-5710
VOLTAGE REGULATOR**
 Prestolite VSH-6201JY

APPLICATION ON NEXT PAGE

VOLTAGE REGULATOR, BRUSH SET, STARTER SWITCH APPLICATION

Year	Model	Volt	Original Alt. or Gen.	Volt Reg.	Original Starter No.	Brush Set	Starter Switch
1979-85	ALL	12	—	—	—	—	18-5840
1967-78	283,F,305,307,327,F,350,454	12	ALE-6207AY,Y,YS & ALE-6221AY,Y	—	MHA,MDY,MDU 1108366,417	— 18-5717	18-5840 18-5838
1961-78	283,O,F,307,327,F,Q,427,F 430,H,430-0,430-HO	12 12 12	ALD-5006 ALE-5202,B,Y ALE-5203	— — —	MDY-6007,8 MDU-7032,3,4,5 MHA-7005,6,9 10,12,13	— — —	18-5840 18-5840 18-5840
1947-66	K,KR,KRO,KS,KSO,KO,M,ML MLO,MO,W,WO Series	12 12 12	— GFW — —	— — — —	MAS-4011, 2 MAU MBG MDL	— — — —	18-5840 18-5840 18-5840 —
1961-65	430H,430,HO	12	GHW-4807, 8	—	MDL-6007	—	18-5840



18-7019
CARB KIT



18-7022
CARB KIT



18-7023
CARB KIT



18-7025
CARB KIT



18-7070
CARB KIT



18-7072
CARB KIT



18-7095
CARB KIT



18-7732
CARB KIT



18-7200
FLOAT
(ALCOHOL RESISTANT)
Plastic



18-7201
FLOAT
(ALCOHOL RESISTANT)
Brass

APPLICATION ON NEXT PAGE

CARBURETOR KIT/FLOAT APPLICATION

Cyl.	Eng./Model	Mfg. Code	Carb. Model	Carburetor	Float Number	Car Kit. ①
4	A & B (1942-55)	Z-1	63M2E10	8963, A-J	—	18-7732
4	K (1939-55)	Z-1	63M2AWEII	8983, A-H	—	18-7732
4	B (1947-Up)	Z-1	63M2E10	12206	—	18-7732
4	K (1956-62)	Z-1	63M2E11	12091, A	—	18-7732
4	153" (2.5L), 181" (3.0L)	R-2	2GC	7041187, 7042181, 17059055	18-7200	18-7070
6	225" (3.7L)	R-2	2GC	7025181, 189	—	18-7070
6	283" (4.6L)	R-2	2GC	7019082	18-7200	18-7070
8	283" (4.6L)	R-4	4GC	7013071, 7015090	—	18-7019
8	283" (4.6L)	C-4	WCFB	2669, 3205	—	18-7025
8	283" (4.6L), 307" (5.0L), 327" (5.3L)	C-4	AFB	3660, 6310	—	18-7022
8	305" (5.0L), 350" (5.7L)	R-4	4MC	17056287, 17056280	18-7201	18-7072
8	305" (5.0L), 350" (5.7L), 454" (7.4L)	R-4	4MV	17059294, 17059295, 17059296	18-7201	18-7095
8	307" (5.0L), 327" (5.3L), 350" (5.7L)	C-4	AVS	4695, 6117	—	18-7023
8	307" (5.0L), 454" (7.4L)	R-4	4MV	7044283, 7044288, 7044289	18-7201	18-7072

① Does not include metering rods

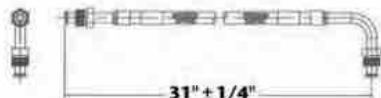

**18-8114
FUEL LINE HOSE
UNIVERSAL**

For fuel pump to carburetor connection. Replaces copper or steel tubing 3/8" X 31" PTFE composite hose with 5/8"-18 male inverted flare straight one end, 5/8"-18 90° one end. SAE J1527 type A1

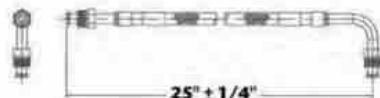

**18-8115
FUEL LINE HOSE
UNIVERSAL**

For fuel pump to carburetor connection. Replaces copper or steel tubing 3/8" X 25" PTFE composite hose with 5/8"-18 male inverted flare straight one end, 5/8"-18 90° one end. SAE J1527 type A1



**18-7260
FUEL PUMP**

(Flange I.D. #40155, M3120)
For: GM (V-8) 283, 307, 327, 350, 400



**18-7265
FUEL PUMP**

Replaces: 16.83-08758, F18308762
(Flange I.D. #41412)
For: GM (V-8) 305, 350, 400



**18-7272
FUEL PUMP**

(Flange I.D. #41419, M73020)
For: GM (V-8) 283, 305, 350, 400



**18-7278
FUEL PUMP**

(Flange I.D. #60032)
For: GM (4 & 6 Cyl.) 153, 191, 250, 224, 225
Uses replacement filter 18-7660 & 18-0889 gasket

ALL SIERRA FUEL PUMPS INCLUDE MOUNTING GASKET

FUEL WATER SEPARATORS



Sierra offers a complete line of 10 and 21 micron fuel water separating filters including drainable bowl filters to protect your carbureted and fuel injected engine.

Refer to pages 153-158 for a complete listing of OEM and universal applications.

Sierra fuel water separators remove over 99.8% of emulsified water from your gasoline. Sierra's 10 micron filters are over 90% efficient at removing particles as small as 10 micron. All filters flow @ 90 GPH to feed even the hungriest motor. Sierra 10 micron filters are recommended to prevent damage to sensitive inboard and outboard fuel injection systems.

* Display Packaged

Sierra #	Chris-Craft #	Description	
18-7860	16.83-90006	Fuel Filter	
18-7964-1	—	Transmission Filter	
② 18-4456D Display Package  18-4456 EXHAUST PROTECTOR VALVE Includes Stainless Steel Clamp 3"	② 18-4457D Display Package  18-4457 EXHAUST PROTECTOR VALVE Includes Stainless Steel Clamp 4"	② 18-4458D Display Package  18-4458 EXHAUST PROTECTOR VALVE Includes Stainless Steel Clamp 5" & 6" (5" requires two 45° cuts)	PKG. OF 8  FREEZE PLUGS 18-5961 18-5961-9① 1 3/8"
① Priced per Package ② Items ending in "D" are Display Packaged - Regular number is Non-Display			



SIERRA MANIFOLDS ARE PAINTED, PACKAGED AND LEAK TESTED

**18-1997-1
MANIFOLD**
Port & Starboard

Replaces: Barr CHV-1-83
Universal Center Riser Manifold
FITS:
Chriscraft 283, 302, 307 and 350 CID engines
Crusader 283 and 327 CID engines thru 1964; 305, 307 and 350 CID engines 1965 and later
Daytona 200-283 and 300-327
Flagship 283, 327 and 350 CID engines
Pacer 305, 307 and 350 CID engines 1965 and later
Mercury 190, 198, 225, 250, 270, 228, 898, 260, 255 and 280 models
OMC 283, 305, 307 and 350 CID engines 1968-1980
Volvo 307 and 350 CID engines
Use 18-0604 Exhaust Manifold Gasket Set



**18-1998-1
MANIFOLD**
Port & Starboard

Replaces: Barr FM-1-83
Universal Center Riser Manifold
FITS:
Crusader 302 and 351 CID engines
Interceptor 221, 260 and 289 CID engines
Commander, Mercury, OMC, Palmer, Pleasurecraft & Waukesha
Comes with 18-4363 Mounting Package
Use 18-0603 Exhaust Manifold Gasket Set
*For Exploded View - See Pages 640-641



**18-1898
MANIFOLD**
Port & Starboard

Replaces: Barr CHVA-1-84
Marine Power 0991-110
Fits: 454 cu.in. GM big block V8 engines
Use with:
Exhaust Gasket: 18-0418
Riser Gasket: 18-2854-1 open or 18-0476-1 blocked
*For Exploded View - See Pages 636-637



**18-1999
ELBOW**
(3" exhaust)

Replaces: Barr 20-0082
Comes with 18-4364 open Mounting Package
If blocked mounting kit is required use 18-8535
Use with:
Manifold: 18-1997-1 or 18-1998-1
Riser Gasket 18-2854-1 open or 18-0476-1 blocked



**18-1907
RISER**

Replaces: Barr 20-0102
Indmar 53-2009, 53-2018
Barr and Indmar Ford Small Block V8 302-351cu.in.
Use with:
Manifolds: 18-1997-1 or 18-1998-1
Riser Gasket: 18-2854-1 open or 18-0476-1 blocked
Mounting Kit: 18-4364 open or 18-8535 blocked



**18-1939
RISER**
(4" exhaust)

Replaces: Barr 20-0100,
Marine Power 0992-593
Barr, Indmar and Marine Power Ford
Small Block V8 302-351cu.in., GM Small Block V8 305-350cu.in., GM Big Block
V8 454cu.in.
Used with:
Manifolds: 18-1898 or 18-1997-1 or 18-1998-1
Riser Gasket: 18-2854-1 open or 18-0476-1 blocked
Mounting Kit: 18-4364 open or 18-8535 blocked



**18-1991
ELBOW ADAPTER**

Barr 200089P
For: 3" I.D. Exhaust Hose
Use with:
Manifold Riser: 18-1999
30°



**18-1992-1
EXHAUST ELBOW**

Barr 200087P
For: 3" I.D. Exhaust Hose
(As used in 18-1987 Exhaust Manifold Conversion Kit)
80°



**18-1949
MANIFOLD SPACER (3")**

Barr CM 20-0097
Barr, Indmar and Marine Power Ford Small Block V8 302-351cu.in., GM Small Block V8 305-350cu.in., GM Big Block V8 454cu.in.
Used with:
Manifolds: 18-1998-1, 18-1997-1 and 18-1898





PIPE PLUGS

PART NO.	Thread Size	PART NO.	Thread Size
18-4256	1/4"	18-4263	1/8" - 27 NPT
18-4257	1/4"	18-4264	3/8" - 18 NPT
18-4258	3/4"		



18-4461
HOSE BARB
 3/4" - 14 NPT x 1" Hose
 Corrosion Resistant Brass Fitting

①18-4218D



18-4218
DRAIN TAP
 Used with:
 Most O.E.M. Manifolds
18-3223-9 Bulk Pack of 12
 1/4"



18-4363
EXHAUST ELBOW KIT
 Replaces: Barr FM-1-83-P
 Use with:
Manifold: 18-1998-1



18-4364 (Open)
EXHAUST ELBOW KIT
 Replaces: Barr 20-0082-P
 Use with:
Riser: 18-1999, 18-1907, 18-1939



18-8516
EXHAUST MANIFOLD MOUNTING KIT
 Chris Craft GM Small Block V8 283-350cu.in.
 Use with Chris Craft 7056, 7686



18-8535
EXHAUST MANIFOLD MOUNTING KIT
 Barr, Indmar and Marine Power Ford Small Block V8 302-351 cu.in., GM Small Block V8 305-350 cu.in., GM Big Block V8 454cu.in.
 Used with:
Risers: 18-1939, 18-1999, and 18-1907 (Blocked)



18-8536
EXHAUST ELBOW MOUNTING KIT
 Barr, Indmar and Marine Power
 GM Small Block V8 305-350cu.in.
 Used with:
Manifold: 18-1997-1



18-8538
EXHAUST MOUNTING KIT
 Barr and Indmar Ford Small Block V8
 302-351cu.in.
 Used with:
Manifold: 18-1998-1



18-0603
EXHAUST MANIFOLD GASKET SET
 Use with:
Manifold: 18-1998-1
 For: FORD 302/351 CID Engines

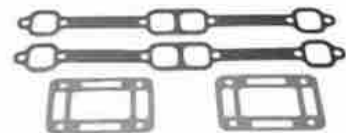

18-0604
EXHAUST MANIFOLD GASKET SET
 Use with:
Manifold: 18-1997-1
 For: GM 305/350 CID Engines

① Items ending in "D" are Display Packaged - Regular number is Non-Display



18-0868
INTAKE MANIFOLD
GASKET SET
 Replaces: 16.50-00232



18-0476-1
RISER BLOCKOFF GASKET
 Barr, Indmar & Marine Power
 Ford Small Block V8
 302-351 cu.in.
Used with:
 Risers: 18-1939, 18-1999
 and 18-1907
 Blocked

PKG. OF 2



18-2854-1 (Open)
18-2854-9
EXHAUST ELBOW GASKET
 Replaces: Barr 01-0107
Use with:
 Riser: 18-1999, 18-1939, 18-1907

PKG. OF 2



18-2949
18-2949-9
EXHAUST MANIFOLD
GASKET
Replaces:
 Barr CHV-47-000
Use with:
 Manifold: 18-1997-1

MARINE OIL FILTERS



18-7824-2
 (Short)
 GM 153, 181, 250
Replaces: 16.81-08746
 For models 307G, 305K, 307K

18-7875
 FORD 302, 351
 (Long)
Replaces:
 16.81-06536

18-7876-1
 (Long)
 GM 283, 305, 307,
 350, 454

SEE PAGES 200-202 & 1165-1190 FOR ADDITIONAL INFORMATION



18-2946
HEAD GASKET
Replaces: 16.50-00204
For: GM 181 CID Eng. (3.0L)



18-3876
HEAD GASKET
Replaces: 16.50-00250
For: GM 305/350 CID Eng.
 (5.0L and 5.7L)



18-3877
HEAD GASKET
Replaces: 16.50-00259
For: GM 454 CID Eng. (7.4L)

PKG. OF 2



18-0874
18-0874-9
DISTRIBUTOR
GASKET
Replaces: 16.50-00162
 GM V-67 V-8

PKG. OF 2



18-0876
18-0876-9
FUEL PUMP
GASKET
Replaces: 16.50-05756

PKG. OF 2



18-0889
18-0889-9
FUEL PUMP
GASKET
Replaces: 16.50-00074

PKG. OF 2

























18-0891
18-0891-9
WATER PUMP
GASKET
Replaces: 16.50-00078



18-2845
VALVE COVER GASKET
Replaces: 16.11-01236
 V-8

SEE PAGES 219 FOR OUR COMPLETE LINE OF GASKET SEALANTS

① Priced per Package

<p>①18-5251D Display Package</p>  <p>18-5251 TUNE-UP KIT —CONTAINS—</p> <table border="0"> <tr> <td>Part #</td> <td>Description</td> </tr> <tr> <td>18-5314</td> <td>Contact Set</td> </tr> <tr> <td>18-5338</td> <td>Condenser</td> </tr> <tr> <td>18-5404</td> <td>Rotor</td> </tr> </table> <p>Mallory 8 cyl. Tall Cap</p>	Part #	Description	18-5314	Contact Set	18-5338	Condenser	18-5404	Rotor	<p>Display Package</p>  <p>18-5255 TUNE-UP KIT —CONTAINS—</p> <table border="0"> <tr> <td>Part #</td> <td>Description</td> </tr> <tr> <td>18-5303</td> <td>Contact Set</td> </tr> <tr> <td>18-5345</td> <td>Condenser</td> </tr> <tr> <td>18-5407</td> <td>Rotor</td> </tr> </table> <p>Prestolite 8 cyl.</p>	Part #	Description	18-5303	Contact Set	18-5345	Condenser	18-5407	Rotor	<p>①18-5258D Display Package</p>  <p>18-5258 TUNE-UP KIT —CONTAINS—</p> <table border="0"> <tr> <td>Part #</td> <td>Description</td> </tr> <tr> <td>18-5303</td> <td>Contact Set</td> </tr> <tr> <td>18-5347</td> <td>Condenser</td> </tr> <tr> <td>18-5407</td> <td>Rotor</td> </tr> </table> <p>Prestolite 8 cyl.</p>	Part #	Description	18-5303	Contact Set	18-5347	Condenser	18-5407	Rotor	 <p>18-5259 TUNE-UP KIT —CONTAINS—</p> <table border="0"> <tr> <td>Part #</td> <td>Description</td> </tr> <tr> <td>18-5303</td> <td>Contact Set</td> </tr> <tr> <td>18-5347</td> <td>Condenser</td> </tr> <tr> <td>18-5429</td> <td>Rotor</td> </tr> </table> <p>Prestolite 6 & 8 cyl.</p>	Part #	Description	18-5303	Contact Set	18-5347	Condenser	18-5429	Rotor
Part #	Description																																		
18-5314	Contact Set																																		
18-5338	Condenser																																		
18-5404	Rotor																																		
Part #	Description																																		
18-5303	Contact Set																																		
18-5345	Condenser																																		
18-5407	Rotor																																		
Part #	Description																																		
18-5303	Contact Set																																		
18-5347	Condenser																																		
18-5407	Rotor																																		
Part #	Description																																		
18-5303	Contact Set																																		
18-5347	Condenser																																		
18-5429	Rotor																																		
<p>①18-5260D Display Package</p>  <p>18-5260 TUNE-UP KIT —CONTAINS—</p> <table border="0"> <tr> <td>Part #</td> <td>Description</td> </tr> <tr> <td>18-5303</td> <td>Contact Set</td> </tr> <tr> <td>18-5345</td> <td>Condenser</td> </tr> <tr> <td>18-5403</td> <td>Rotor</td> </tr> </table> <p>Prestolite 8 cyl.</p>	Part #	Description	18-5303	Contact Set	18-5345	Condenser	18-5403	Rotor	 <p>18-5303 CONTACT SET Replaces: 2421173, 2808870</p>	 <p>18-5307 CONTACT SET Replaces: 2084074, 1274092, 2421178</p>	 <p>18-5314 CONTACT SET Replaces: 2421820</p>																								
Part #	Description																																		
18-5303	Contact Set																																		
18-5345	Condenser																																		
18-5403	Rotor																																		
 <p>18-5338 CONDENSER</p>	 <p>18-5345 CONDENSER Replaces: 2098058, 2279949</p>	 <p>18-5347 CONDENSER Replaces: 1818757, 3420600</p>	 <p>18-5403 ROTOR</p>																																
 <p>18-5404-1 ROTOR Replaces: 868096</p>	 <p>18-5407 ROTOR Replaces: 1658535</p>	 <p>18-5429 ROTOR Replaces: 2098611</p>	 <p>18-5430 ROTOR Replaces: 868095</p>	 <p>18-5300 ROTOR Fits: Flamethrower Distributors</p>																															
 <p>18-5352 DISTRIBUTOR CAP Replaces: 4142817 Prestolite</p>	 <p>18-5369 DISTRIBUTOR CAP (With Gasket 18-5399) Replaces: 4142408 Prestolite</p>	 <p>18-5376 DISTRIBUTOR CAP Mallory</p>	 <p>18-5473 DISTRIBUTOR CAP Black Distributor Cap with Male Terminals for Flamethrower Distributors</p>	 <p>18-5474 DISTRIBUTOR CAP Red Distributor Cap with Male Terminals for Flamethrower Distributors</p>																															

① Items ending in "D" are Display Packaged - Regular number is Non-Display



**18-5301
TUNE-UP KIT**
Replaces:
Fits: male cap v-8 flamethrower distributors



**18-5302
TUNE-UP KIT**
Replaces:
Fits: male cap v-8 flamethrower distributors

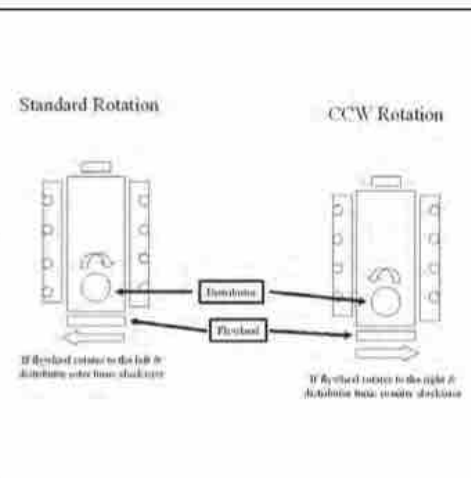

**18-5497-2
ELECTRONIC DISTRIBUTOR**
U.L. Approved • Conventional Rotation
For: Chrysler V-8 273, 318 (1967-Up), 340, 360 CID
"LA" Engines

USES:

Part #	Description
18-5376	Distributor Cap
18-5404-1	Rotor
18-5491	Reluctor
18-5488	Module

PREMIUM MARINE SPARK PLUG WIRE LEADS

Sierra's MAGFORCE Ignition Wires are "Electronics Friendly" protecting all of your electronic devices and electronic engine controls from RFI and EMI while delivering the maximum amount of voltage. Exact fit design ensures easy installation and years of trouble - free service.



CHRYSLER MARINE IGNITION WIRES APPLICATION					
Engine	Cyl.	Distributor	Years	Year Stop	Plug Wire Set
M273	8	Conventional & Electronic	1968-1974	1974	18-8826-1
LM318	8	Conventional & Electronic	1968-1985	1985	18-8826-1
M340	8	Conventional & Electronic	1968-1985	1985	18-8826-1
M360	8	Conventional & Electronic	1975-1985	1985	18-8826-1
361	8	Conventional & Electronic	1968-1985	1985	18-8827-1
383	8	Conventional & Electronic	1960-1988	1988	18-8827-1
400	8	Conventional & Electronic	1968-1985	1985	18-8827-1
440	8	Conventional & Electronic	1968-1985	1985	18-8827-1

FEATURES



- Senses current levels in the coil and adjusts the dwell to maintain peak energy throughout the entire RPM range.
- Develops, on average, 4 times more available energy between 3000 and 5000 RPM's and twice as much plug voltage as point-type systems.
- Ignition energy is sustained and coil life is increased when peak current level is reached just prior to spark.
- More stable timing.
- Use with 18-5472 "Flame Thrower II" Coil for optimum performance



FEATURES

- ★ Replaces points & condensers for true solid state ignition.
- ★ Uses standard coil, cap and rotor.
- ★ Easy to install, one-piece, 2-wire hook-up.
- ★ Accurate to within 1/4° timing accuracy 0 to 6000 RPM range.
- ★ Can be used with Flame Thrower Coil 18-5469

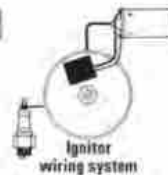

18-5294
ELECTRONIC CONVERSION KIT
Fits: 6 cyl. Delco distributors



18-5295
ELECTRONIC CONVERSION KIT

Fits: most 4 cyl. Prestolite distributors. (Except IBM 7026)
For: Onan, Universal, Waukesha, Wisconsin



18-5433
IGNITION COIL
Replaces: 201522, 2495531
Uses External Resistor



18-5435
IGNITION COIL
4.0 OHM
Replaces: 200691
Has Internal Resistor



FEATURES

- Oil filled for better cooling and long life
- Low resistance and improved turn ratios produces the higher voltage needed to run larger spark plug gaps for added power and better fuel economy
- More windings maximize energy and reliability over the full RPM range
- Fits existing brackets for easy installation

18-5469
HI-PERFORMANCE IGNITION COIL

3.0 ohm (oil filled), black - 4 & 6 cylinder.
Flame-Thrower 40,000 volt coil.
• Designed for use with the original Ignitor Electronic Conversion Kits
• Can be used with other inductive ignition systems.



18-5472
HI-PERFORMANCE IGNITION COIL

0.6 ohm (oil filled), black - 4, 6, & 8 cylinder.
Flame-Thrower 45,000 volt coil.
• Super low 0.6 ohm resistance coil designed for use with the Ignitor II Hi Performance Electronic Conversion Kits
• Compatible with capacitive discharge systems



Sierra Part #	Description	Recommended Coil	Resistance Ohms
18-5294	Electronic Conversion Kit	18-5469	3.0
18-5295	Electronic Conversion Kit	18-5469	3.0

18-5450
COIL RESISTOR
15. OHM
Replaces: 4106140



18-5451
COIL RESISTOR
1.5 OHM & 3.0 OHM
Replaces: 3674767



18-5102
RELECTOR
Replaces: 3656017



PKG. OF 10



18-5224
18-5224-9①
SPARK PLUG WIRE TERMINAL
 Replaces: Mercury 20121
 OMC 510364

PKG. OF 10



18-5750
18-5750-9①
UNIVERSAL SPARK PLUG BOOTS
 Supplied complete w/Terminal Connector
 Replaces: OMC 581027, 580339



18-5752
UNIVERSAL SPARK PLUG BOOT
 8mm



18-5840
SOLENOID
 Replaces: Prestolite 15-79,
 SAW4201, SAW4207, SAW4210



18-5841
SOLENOID
 Replaces: 1692658
 Prestolite



BATTERY CABLES
 Gauge cable with soldered lug terminals
 on each end to accept a 3/8" stud.

Part #	Size	Color	Gauge	Part #	Size	Color	Gauge
BC88523	2'	red	4	BC88583	6'	red	2
BC88533	2'	black	4	BC88573	6'	black	2
BC88543	4'	red	2	BC88583	8'	red	1
BC88553	4'	black	2	BC88593	8'	black	1

① Priced per Package

BRUSH SET/STARTER SWITCH APPLICATION

Year/Model	Volt	Original Starter No.	Starter Switch
1960-88 LM318X,340X,M80A, 81,170A,M225A, X,M251X, 265X,273X,M318,A,B,C, X,M383BX,M413,B,D,E, X,M426B,D,E,X,M440, X,M155,200,225,250,260,300,335,375	12 12 12 12 12 12 12 12	MCL-6115 MDT-6010,11 MDT-7001,10 MDT-7002,14 MDT-7021,22 MDU-6003,10 MDU-7001	— 18-5840 18-5841 18-5840 — 18-5841 18-5841
1961-69 M225,MH225,M273,A,B, LM318,B,M318A,B,C, M383,B,X,M413,E,M426 B,D,X,M426 Hemi	12 12 12 12 12 12 12 12 6 & 12	MDT-6010,11 MDT-7002,14 2095150 1779955 2,095,393,509 2095509 MDT-7002,14 MDT-7001,10 MDT-7001,10	18-5841 18-5841 18-5841 18-5841 18-5841 18-5841 18-5841 18-5841 18-5841
1959-69	12 12 12	MDU-6003,10 MDT-7001,10 MDT-7002	18-5841 18-5841 18-5841
1961-68	12	MDT-6010,11	18-5840
1961-65	12	MDU-7001	18-5841
1955-71 M26,46,46-4 (Ace),M27, 47,47-4, (Crown),M28, 36,37,38,44,44-3,48 (Royal)M45(Imperial), M45-3,46-3,47-3,M49	6 6 12 12 12 12	MCL-6102,M,07 MCL-6127,28,M MCL-6020M MCL-6115 MDT-6010,11M MDU-7013	— — — — 18-5840 —



18-9802
TIMING LIGHT
 Self-powered accurate up to 10,000 RPM's



18-5710
VOLTAGE REGULATOR
 Replaces: 2847527, 2098300 Prestolite
 VSH-6201JY

Year/Model	Volt	Original Alt/Gen. No.
1970-88 M273X,LM318X	12	ANE-5201S,2S,2YS
1972-77 225,318X,340,X,400,440	12	3527502

18-5723
VOLTAGE
REGULATOR
(Field Relay)
Replaces: 2095946
 (Use with 18-5710)



Year/Model	Volt	Original Alt/Gen. No.
1961-70		
B,D,X, M426 Hemi	12	2095860

Standard Rotation

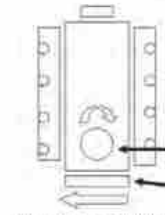

If flywheel rotates to the left & distributor rotor turns clockwise

CCW Rotation

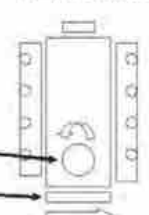

If flywheel rotates to the right & distributor rotor counts clockwise

18-6270
PERMANENT MAGNET
I/O STARTER
 Heavy Duty - 12 Volt
 2 Bolt Mount - 1 Threaded Hole - CW Rotation
Fits: Ford 460
 Permanent Magnet I/O



18-6835
STARTER
Replaces: GM Engines Universal
 Used on all GM Engines with either 14 1/4" or 12 3/4" flywheels



18-5954
ALTERNATOR
Replaces: 3527501, 3527502, 3744870
 61 Amps



18-7089
CARB KIT



18-7091
CARB KIT



18-7095
CARB KIT



18-7726
CARB KIT



18-7201
FLOAT
 (Alcohol Resistant)
 Brass



CARBURETOR KIT / FLOAT APPLICATION

Years	Cyl.	Model or Engine Displacement	Mfg. Code	Carb. Model	Carburetor Number	Float	Carb. Kit ①
1965 -Up	8	M-273-B,LM-318-B, M-340-B, M-360-B,M383-B,M-440-B	C-4	AFB	3980, 6130, 6212	—	18-7089
1965-69	8	M-318-B,M-363, M-413,M-426, M-440	C-4	AFB	3213, 3214, 3392, 3543, 4476, 4699, 9263, 9264	—	18-7091
—	8	318" (5.2L), 360" (5.9L)	R-4	4MV	17084001, 17086115, 17086116	18-7201	18-7095
—	6	M-225, M-225D, MH-225	C-2	BBD	3389, 3390, 4268	—	18-7726
—	8	M273A, M318A, M318G	C-2	BBD	3212, 3979, 3981	—	18-7726

① Does not include Metering Rods.

ALL SIERRA FUEL PUMPS INCLUDE MOUNTING GASKET



**18-8114
FUEL LINE HOSE
UNIVERSAL**

For fuel pump to carburetor connection. Replaces copper or steel tubing 3/8" X 31" PTFE composite hose with 5/8"-18 male inverted flare straight one end, 5/8"-18 90° one end. SAE J1527 type A1



**18-8115
FUEL LINE HOSE
UNIVERSAL**

For fuel pump to carburetor connection. Replaces copper or steel tubing 3/8" X 25" PTFE composite hose with 5/8"-18 male inverted flare straight one end, 5/8"-18 90° one end. SAE J1527 type A1



FUEL WATER SEPARATORS















Sierra offers a complete line of 10 and 21 micron fuel water separating filters including drainable bowl filters to protect your carbureted and fuel injected engine.

Refer to pages 153-158 for a complete listing of OEM and universal applications.

Sierra fuel water separators remove over 99.8% of emulsified water from your gasoline. Sierra's 10 micron filters are over 90% efficient at removing particles as small as 10 micron. All filters flow @ 90 GPH to feed even the hungriest motor. Sierra 10 micron filters are recommended to prevent damage to sensitive inboard and outboard fuel injection systems.

Sierra #	Chrysler #	Description
18-7964-1	—	Transmission Filter
 <p>18-7230 FLAME ARRESTOR Replaces: 4142886 Ht. 2.250 Element 1.470 Throat 5.050 1 Vent Tube</p>	 <p>18-7254 FUEL PUMP Replaces: 3745414 (Flange I.D. #6766, M6766) For: (V-8) 318,360</p>	 <p>18-7255 FUEL PUMP Replaces: 3745415 (Flange I.D. #6767, M6767) For: (V-8) 361, 400, 413, 440</p>
 <p>18-7264 FUEL PUMP Replaces: 2279913, 1736073 (Flange I.D. #40781, M6866) For: (V-8) 273, 318, 340, 360</p>	 <p>18-3551 THERMOSTAT Replaces: 4142885 142° 2.125 O.D. x 1.500 H</p>	 <p>18-3645 THERMOSTAT Replaces: 2463441 For: 318 & 360 CID Engines 160°</p>

 <p>18-3047 IMPELLER KIT Contains: 18-3061 Impeller</p>	 <p>18-3060 IMPELLER Replaces: Sherwood 9959</p>	 <p>Ⓛ18-3046D Display Package</p> <p>18-3046 IMPELLER KIT Replaces: Sherwood 9959K Contains: 18-3060 Impeller</p>									
 <p>18-3061 IMPELLER Replaces: Sherwood 10615 For: GM engines with V-Belt</p>	 <p>18-3581 CIRCULATING WATER PUMP (Bi-Directional) Replaces: 3004886, 3745985, 3619542, 4417905 For: Engine Models 318, 340 & 360</p>	 <p>18-3582 CIRCULATING WATER PUMP Replaces: 3619859 For: 383,400,440</p>									
 <p>Ⓛ18-4456D Display Package</p> <p>18-4456 EXHAUST PROTECTOR VALVE Includes Stainless Steel Clamp 3"</p>	 <p>Ⓛ18-4457D Display Package</p> <p>18-4457 EXHAUST PROTECTOR VALVE Includes Stainless Steel Clamp 4"</p>	 <p>Ⓛ18-4458D Display Package</p> <p>18-4458 EXHAUST PROTECTOR VALVE Includes Stainless Steel Clamp 5" & 6" (5" requires two 45° cuts)</p>									
<p style="text-align: center;">OIL FILTERS</p> <table border="1" data-bbox="187 1164 572 1310"> <thead> <tr> <th>Part #</th> <th>Replaces:</th> </tr> </thead> <tbody> <tr> <td>18-7875</td> <td>1851658, 56874, F724002 (Long)</td> </tr> <tr> <td>18-7878-1</td> <td>L-19, L-1008, 3549957 (Short)</td> </tr> <tr> <td>18-7879-1</td> <td>L-319</td> </tr> </tbody> </table> <p style="text-align: center;">SEE PAGES 200-202 & 1165-1190 FOR ADDITIONAL INFORMATION</p>			Part #	Replaces:	18-7875	1851658, 56874, F724002 (Long)	18-7878-1	L-19, L-1008, 3549957 (Short)	18-7879-1	L-319	 <p>18-3878 HEAD GASKET Replaces: 4417375</p>
Part #	Replaces:										
18-7875	1851658, 56874, F724002 (Long)										
18-7878-1	L-19, L-1008, 3549957 (Short)										
18-7879-1	L-319										
 <p>18-3860 HEAD GASKET Replaces: 4142880 For: 318 CID Engines</p>	 <p>18-0609 VALVE COVER GASKET Replaces: 4273129 For: 318/340/360 CID</p>	<p>PKG. OF 2</p>  <p>18-0499 18-0499-9 WATER PUMP PLATE GASKET Replaces: 10612</p>									
<p style="text-align: center;">① Priced per Package ② Items ending in "D" are Display Packaged - Regular number is Non-Display</p>											

Fits Chrysler Small Block V8 318-360 cu. in. All Models 1966 & up with Fixed Exhaust

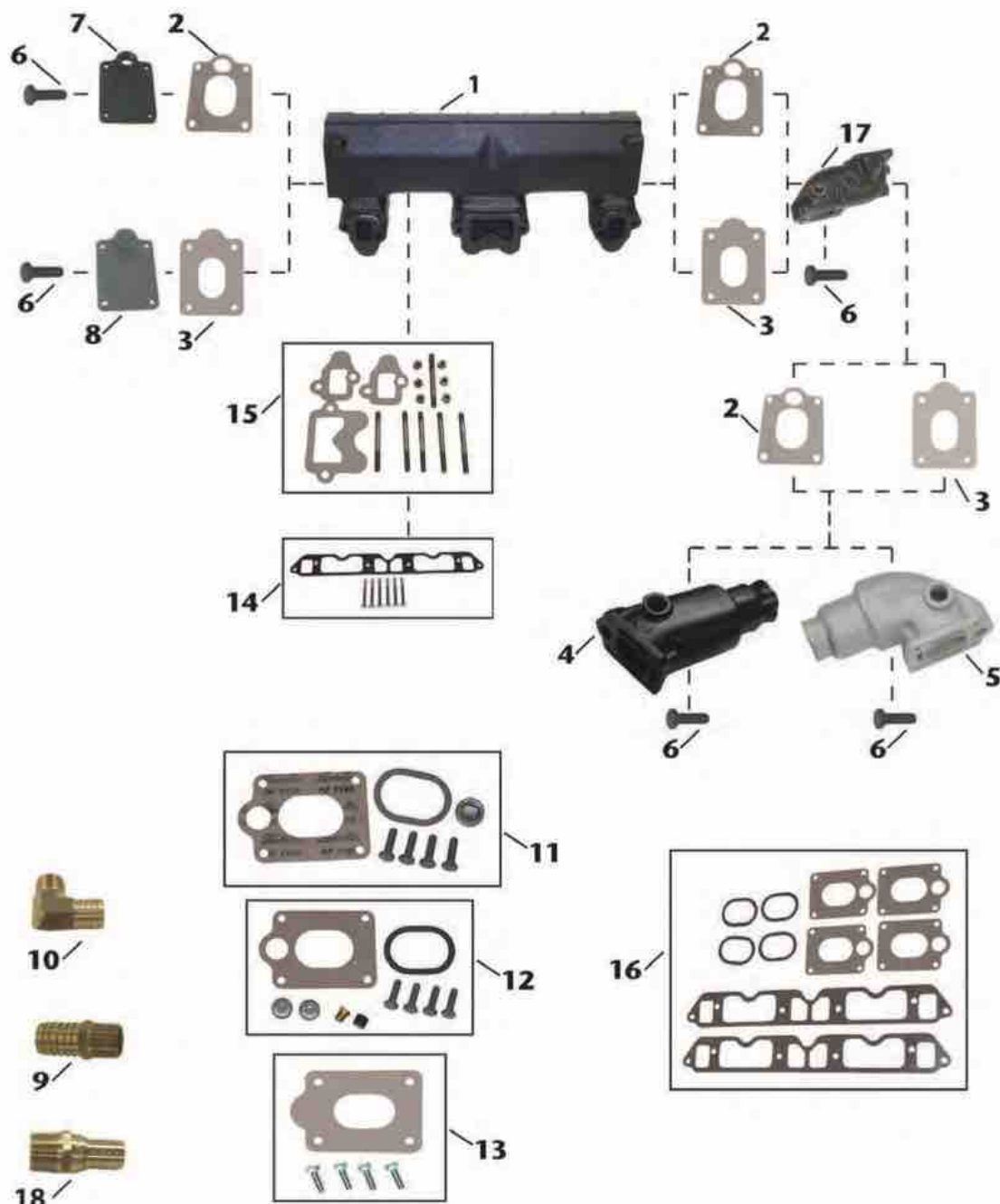

Item No.	Description	OE No.	Application	
1	18-1940	MANIFOLD	4142322, 3675826	Chrysler Models 318-360CID Engines (1966 & Up); Use manifold mounting kit 18-8526 or 18-8527 (stainless).
2	18-2941	END CAP GASKET (OPEN)	2847480, 2469559	Fits: End Caps of Manifold (Starboard & Port) 18-1940; Risers: 18-1945; Elbows: 18-1946 & 18-1913
3	18-0472-1	END CAP GASKET (BLOCKED)	N/A	Fits: End Caps of Manifold (Starboard & Port) 18-1940; Risers: 18-1945; Elbows: 18-1946 & 18-1913
4	18-1946	MANIFOLD ELBOW	3527794	Use in conjunction with 18-1945. 3" exhaust outlet & a 20° down angle.
5	18-1913	MANIFOLD ELBOW	2469639, 2847405	Use in conjunction with 18-1945. 3" exhaust outlet & a 90° down angle.
6	NSS	MOUNTING BOLT	N/A	Included in 18-4360, 18-4361, & 18-8506 mounting kits.
7	18-1942	MANIFOLD END PLATE (OPEN)	2846106	Use with End Plate Gasket: 18-2941 (Open); Mounting Kit: 18-4360 (Open) or 18-4361 (Open); (Port & Starboard) Manifold: 18-1940
8	18-1941	MANIFOLD END PLATE (BLOCKED)	2469556, 3675826	Use with End Plate Gasket: 18-2941; Mounting Kit: 18-4360 or 18-4361; (Port & Starboard) Manifold: 18-1940
9	18-4461	HOSE FITTING	N/A	3/4" - 14NPT X 1" Hose (Corrosion Resistant Brass Fitting)
10	18-8216	HOSE FITTING	N/A	3/4" - 14 NPT x 1" Hose (Corrosion Resistant Brass Fitting)
11	18-4360	MOUNTING PACKAGE (OPEN GASKET)	N/A	Use with End Plates: 18-1942 (open) or 18-1941 (Blocked); Riser/Elbow: 18-1945, 18-1946, 18-1913
12	18-4361	MOUNTING PACKAGE (OPEN GASKET)	N/A	Use with End Plates: 18-1942 (open) or 18-1941 (Blocked); Riser/Elbow: 18-1945, 18-1946, 18-1913
13	18-8506	MOUNTING KIT (BLOCKED GASKET)	N/A	Use with Riser/Elbow: 18-1945, 18-1946, 18-1913; End Plate: 18-1941 (Blocked)
14	18-8526	MOUNTING KIT	N/A	Use with Manifold: 18-1940
15	18-8527	MOUNTING KIT (STAINLESS STEEL)	N/A	Use with Manifold: 18-1940 (Kit has stainless steel studs and nuts)
16	18-4346	EXHAUST MANIFOLD GASKET SET	3745220	318 CID Engines (1969-85)
17	18-1945	MANIFOLD RISER	2846689	Use with Manifold: 18-1940; Riser Gasket: 18-2941 (Open) or 18-0472-1 (Closed); Mounting Kit: 18-4361 (Open) or 18-4360 (Open) or 18-8506 (Blocked)
18	18-8215	HOSE FITTING	N/A	3/4" - 14NPT X 3/4" Hose (Corrosion Resistant Brass Fitting)



**Fits Chrysler Big Block V8 383-440 cu. in.
All Models Except 413 "E" with Staggered Bolt Pattern**

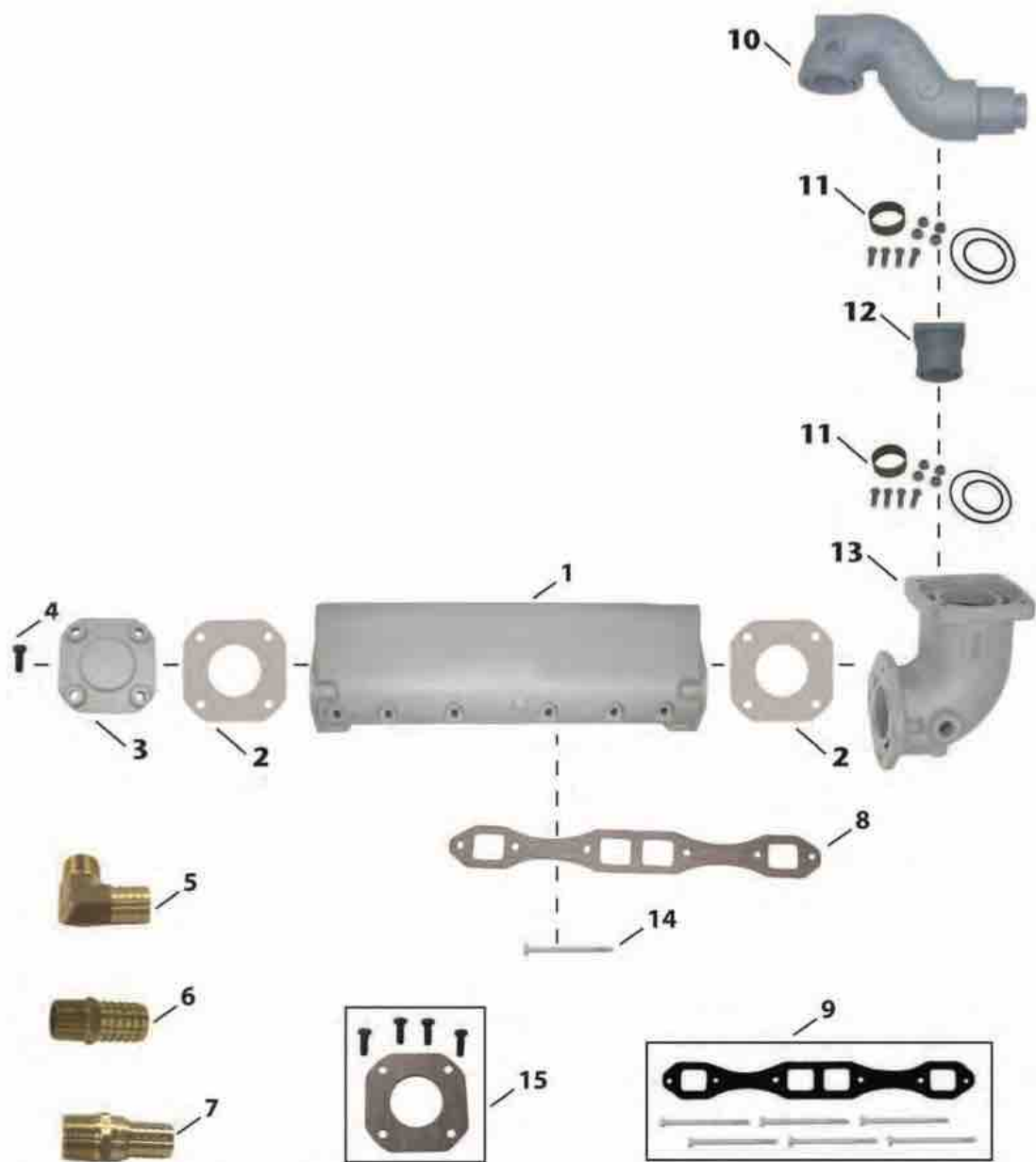

Item No.	Description	OE No.	Application
1	NSS MANIFOLD	E7081M, 3619659	Chrysler Models 383-440 cu.in. (V8 Big Block). Use with Front Plate: 18-1911
2	18-0471 ELBOW GASKET	N/A	Gasket for Elbow:18-1948 ; End Plate: 18-1911
3	18-1911 END/FRONT PLATE	N/A	Use with Elbow Gasket: 18-0471
4	NSS MOUNTING BOLT	N/A	
5	18-8216 HOSE FITTING	N/A	3/4" - 14 NPT x 1" Hose (Corrosion Resistant Brass Fitting)
6	18-4461 HOSE FITTING	N/A	3/4" - 14NPT X 1" Hose (Corrosion Resistant Brass Fitting)
7	18-8215 HOSE FITTING	N/A	3/4" - 14NPT X 3/4" Hose (Corrosion Resistant Brass Fitting)
8	NSS MANIFOLD GASKET	N/A	
9	NSS MOUNTING KIT	N/A	Big Block (V8) 383-440 cu.in. (All models except 413"E" with offset bolt pattern) Includes Manifold Gasket.
10	18-1944 RISER	2847404, 2847623, 3745639, E9923M	Use with Manifold: 18-1940; Mounting Kit: 18-8518
11	18-8518 MOUNTING KIT	N/A	Use with Riser: 18-1944.
12	N/A EXTENSION	N/A	Use in conjunction with 18-1948. Use mounting kit: 18-8518.
13	18-1948 RISER	E9234M	
14	NSS MOUNTING BOLT	N/A	



Fits Chrysler Small Block V8 318-360 cu. in. All Models 1966 & up with Swivel Exhaust

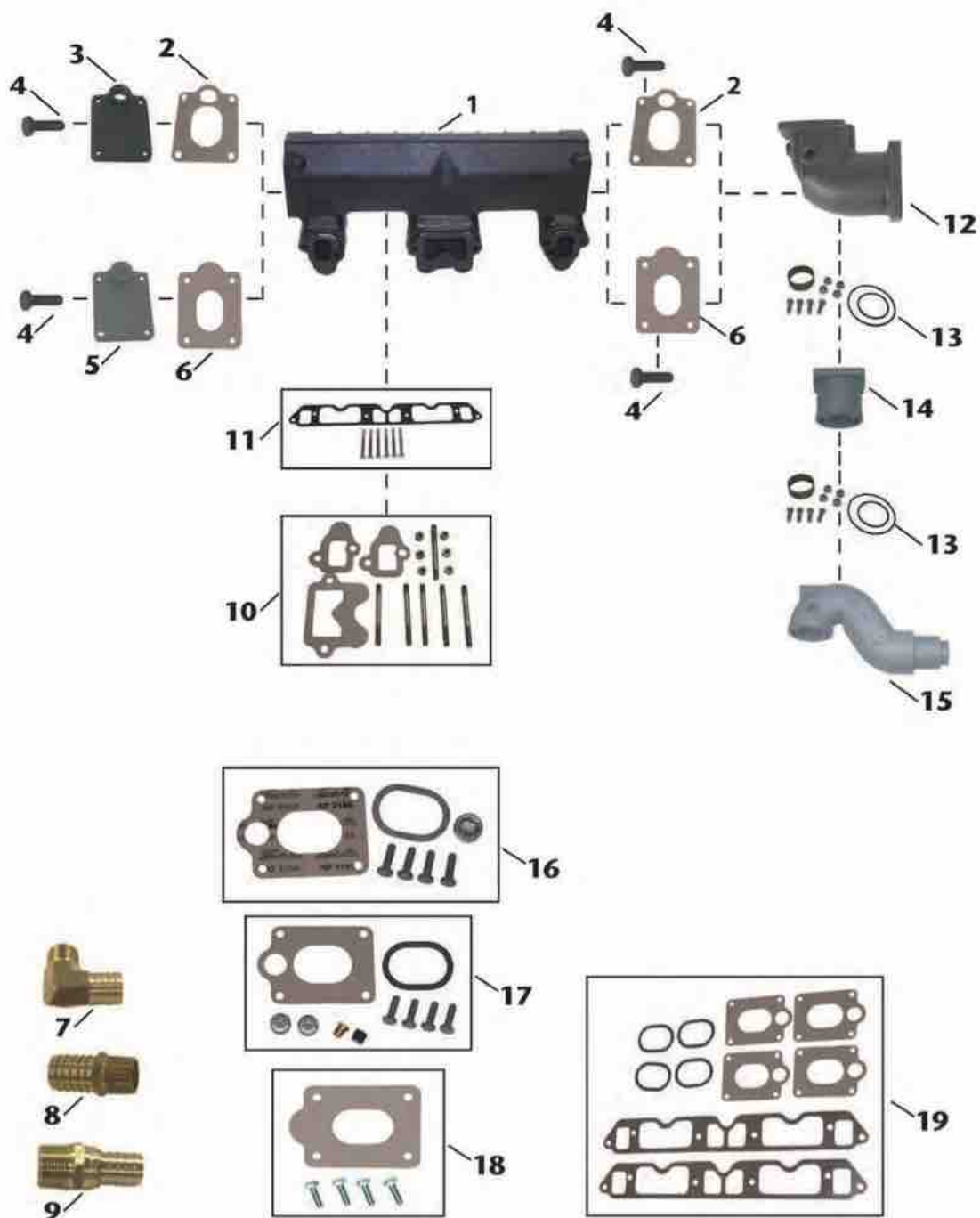

Item No.	Description	OE No.	Application
1	18-1940 MANIFOLD	4142322, 3675826	Chrysler Models 318-360CID Engines (1966 & Up); Use manifold mounting kit 18-8526 or 18-8527
2	18-2941 END CAP GASKET (OPEN)	2847480, 2469559	Fits: End Caps of Manifold (Starboard & Port) 18-1940. Included in 18-4360, & 18-4361 mounting kits.
3	18-1942 MANIFOLD END PLATE	2469556, 3675826	Use with End Plate Gasket: 18-2941; Mounting Kit: 18-4360 or 18-4361
4	NSS MOUNTING BOLT	N/A	Included in 18-4360, 18-4361, & 18-8506 mounting kits.
5	18-1941 MANIFOLD END PLATE	2846106	Use with End Plate Gasket: 18-0472-1 ; Mounting Kit: 18-8506
6	18-0472-1 END CAP GASKET (BLOCKED)	N/A	Fits: End Caps of Manifold (Starboard & Port) 18-1940. Included in 18-8506 mounting kit.
7	18-8216 HOSE FITTING	N/A	3/4" - 14 NPT x 1" Hose (Corrosion Resistant Brass Fitting)
8	18-4461 HOSE FITTING	N/A	3/4" - 14NPT X 1" Hose (Corrosion Resistant Brass Fitting)
9	18-8215 HOSE FITTING	N/A	3/4" - 14NPT X 3/4" Hose (Corrosion Resistant Brass Fitting)
10	18-8527 MOUNTING KIT (STAINLESS STEEL)	N/A	Use with Manifold: 18-1940 (Kit has stainless steel studs and nuts)
11	18-8526 MOUNTING KIT	N/A	Use with Manifold: 18-1940
12	N/A ELBOW	2600402	Use with Manifold: 18-1940. Use mounting kit 18-4360, 18-4361, or 18-8506.
13	18-8518 MOUNTING KIT	N/A	Use with Riser: 18-1944
14	N/A EXTENSION	N/A	Use mounting kit: 18-8518.
15	18-1944 RISER	N/A	Use with Manifold: 18-1940. Use with mounting kit: 18-8518
16	18-4360 MOUNTING PACKAGE (OPEN GASKET)	N/A	Use with End Plates: 18-1942 (open) or 18-1941 (Blocked).
17	18-4361 MOUNTING PACKAGE (OPEN GASKET)	N/A	Use with End Plates: 18-1942 (open) or 18-1941 (Blocked).
18	18-8506 MOUNTING KIT (BLOCKED GASKET)	N/A	Use with End Plate: 18-1941 (Blocked).
19	18-4346 EXHAUST MANIFOLD GASKET SET	3745220	318 CID Engines (1969-85)



ALL SIERRA MANIFOLDS ARE PAINTED, PACKAGED AND LEAK TESTED

18-1940

MANIFOLD
Port & Starboard

Replaces: 4142322, 3675826

Barr CM-1-6677A

Fits: Chrysler Model 273, 318, 340 & 360
CID engines (1973-1986)

Use with:

End Cap Gasket: 18-2941 Open or 18-0472-1 Blocked

Mounting Kit: 18-4360 Open or 18-4361 Open or 18-8506 Blocked

End Plate: 18-1941 Blocked or 18-1942 Open

Note: If using a blocked end plate either gasket will work. If using an open end plate use only an open gasket.



18-1997-1

MANIFOLD
Port & Starboard

Replaces: Barr CHV-1-83

Universal Center Riser Manifold

FITS:

Chrysler 283, 302, 307 and 350 CID engines

Crusader 283 and 327 CID engines thru 1964; 305, 307 and 350 CID
engines 1965 and later.

Daytona 200-283 and 300-327

Flagship 283, 327 and 350 CID engines

Pacer 305, 307 and 350 CID engines 1965 and later.

Mercury 190, 198, 225, 250, 270, 228, 898, 260, 255 and 280 models

OMC 283, 305, 307 and 350 CID engines 1968-1980

Volvo 307 and 350 CID engines

Use 18-0604 Exhaust Manifold Gasket Set

***For Exploded View - See Pages 656-657**



18-1898

MANIFOLD
Port & Starboard

Replaces: Barr CHVA-1-84, Marine Power 0991-110

Fits: 454 cu.in. GM big block V8 engines

Use with:

Exhaust Manifold Gasket: 18-0418

***For Exploded View - See Pages 636-637**



18-1945

RISER

Replaces: 2846689, Barr CM-20-6674

Fits: Chrysler Model 273, 318,

340 & 360 CID engines (1966-1986)

Use with:

Manifold: 18-1940

Riser Gasket: 18-2941 open or 18-0472-1 blocked

Mounting Kit: 18-4361 open or 18-4360 open or 18-8506 blocked



18-1939

RISER

Replaces: Barr 20-0100, Marine Power 0992-593

Barr, Indmar and Marine Power Ford Small Block V8 302-351 cu.in., GM Small Block
V8 305-350cu.in., GM Big Block V8 454cu.in.

Use with:

Manifold: 18-1997-1 or 18-1998-1 or 18-1898

Riser Gasket: 18-2854-1 open or 18-0476-1 blocked

Mounting Kit: 18-4364 open or 18-8535 blocked



18-1944

RISER

Replaces: 2847404, 2847623,

3745639, E9923M

Barr CM-20-414211

Chrysler Small Block V8 318-360cu.in.

(All models 1966 and up with swivel exhaust),

Big Block V8 383-440cu.in. (All models except

413" E" with offset bolt pattern)

Use with:

Manifold: 18-1940

Mounting Kit: 18-8518



18-1907

RISER

Replaces: Barr 20-0102, Indmar 53-2009, 53-2018

Barr and Indmar Ford Small Block V8 302-351cu.in.

Use with:

Manifold: 18-1997-1 or 18-1998-1

Riser Gasket: 18-2854-1 open or 18-0476-1 blocked

Mounting Kit: 18-4364 open or 18-8535 blocked



18-1946

ELBOW

Replaces: 3527794

Barr CM-20-6672

Fits: Chrysler Model 273, 318,

340 & 360 CID engines (1966-1986)

will work in conjunction with 18-1945

Use with:

Manifold: 18-1940

Elbow Gasket: 18-2941 open or 18-0472-1 blocked

Mounting Kit: 18-4360 open or 18-4361 open or 18-8506 blocked

20"

 <p>18-1913 ELBOW</p> <p>Replaces: Chrysler 2469556, 2469639, 2647405 Chrysler Small Block V8 318-360 cu.in. (All Models 1966 and up with fixed exhaust) For: 18-1940 Manifold will work in conjunction with 18-1945</p> <p>Use with: Elbow Gasket: 18-2941 open or 18-0472-1 blocked Mounting Kit: 18-4360 open or 18-4361 open or 18-8506 blocked</p>	 <p>18-1948 ELBOW</p> <p>Replaces: Chrysler E9234M Barr CM-20-9234 Chrysler Big Block V8 383-440cu.in. (All Models except 413"E" with offset bolt pattern)</p> <p>Use with: Elbow Gasket: 18-0471 Mounting Kit: 18-8501</p>
 <p>18-1911 MANIFOLD END PLATE</p> <p>Chrysler Big Block V8 383-440cu.in. (All Models except 413"E" w/offset bolt pattern)</p> <p>Used with: Front/End Plate Gasket: 18-0471 Mounting Kit: 18-8501</p>	 <p>18-1941 MANIFOLD END PLATE</p> <p>Replaces: 2846106 Barr CM-1-6672-B</p> <p>Use with: End Plate Gasket: 18-2941 open or 18-0472-1 blocked Mounting Kit: 18-4360 open or 18-4361 open or 18-8506 blocked</p>
 <p>18-1942 MANIFOLD END PLATE with hole</p> <p>Replaces: 24695566, 3675826 Barr CM-1-6672-H</p> <p>Use with: End Plate Gasket: 18-2941 Mounting Kit: 18-4360 or 18-4361</p> <p>Fits: 18-1940 Manifold</p>	 <p>18-0607 INTAKE MANIFOLD GASKET SET</p> <p>Replaces: 3745217 For: 318 CID Engines (1969-82)</p>
 <p>18-4346 EXHAUST MANIFOLD GASKET SET</p> <p>Replaces: 3745220 For: 318 CID Engines (1969-85)</p>	 <p>18-0956-1 EXHAUST MANIFOLD GASKET</p> <p>Replaces: 118-614 For: 460 CID</p>
 <p>18-0471 ELBOW GASKET</p> <p>Used with: Elbow: 18-1948 End Plate: 18-1911</p>	 <p>18-0472-1 (Blocked) ELBOW GASKET</p> <p>Used with: Riser/Elbow: 18-1945, 18-1946, 18-1913 End Plate: 18-1941</p>
 <p>18-4360 (Open) EXHAUST ELBOW MOUNTING KIT</p> <p>Barr CM206672JP Use with: Exhaust Elbow: 18-1946, 18-1913, 18-1945 End Plate: 18-1942 open or 18-1941 blocked</p>	 <p>18-4361 (Open) EXHAUST ELBOW MOUNTING KIT</p> <p>Barr CM-20-6674P Use with: End Plate: 18-1942 open or 18-1941 blocked Riser: 18-1945 Elbow: 18-1946, 18-1913</p>



18-4364 (Open)
EXHAUST ELBOW KIT
 Replaces: Barr 20-0082-P
 Use with:
 Riser: 18-1999, 18-1907, 18-1939

PKG. OF 2



18-2941 (Open)
18-2941-9
END CAP GASKET
 Replaces:
 2847480, 2469559
 Use with:
 End Plate: 18-1941, 18-1942
 Riser/Elbow: 18-1945, 18-1946, 18-1913
 For: 318CID Engines



18-8506
EXHAUST ELBOW MOUNTING KIT
 Replaces: Barr CM-20-6674JP
 Chrysler Small Block V8 318-360 cu.in. (All models 1966 and up with swivel and fixed exhaust)
 Used with:
 Riser: 18-1945
 Elbow: 18-1946, 18-1913
 End Plate: 18-1941 blocked



18-8518
EXHAUST ELBOW MOUNTING KIT
 Replaces: Barr CM-20-9232P
 Chrysler Small Block V8 318-360cu.in. (All models 1966 and up with swivel exhaust), Big Block V8 383-440cu.in. (All models except 413 "E" with offset bolt pattern)
 Used with:
 Riser: 18-1944



18-8526
EXHAUST MANIFOLD MOUNTING KIT
 Chrysler Small Block V8 318-360cu.in.
 (All models 1966 and up with swivel and fixed exhaust)
 Used with:
 Manifold: 18-1940



18-8527
EXHAUST MANIFOLD MOUNTING KIT
 Replaces: Barr CM-1-6677SS P
 Chrysler Small Block V8 318-360cu.in.
 (All models 1966 and up with swivel and fixed exhaust)
 Used with:
 Manifold: 18-1940
 (Kit has stainless steel studs and nuts)



18-8535
EXHAUST ELBOW MOUNTING KIT
 Barr, Indmar and Marine Power
 Ford Small Block V8 302-351cu.in.,
 GM Small Block V8 305-350cu.in.,
 GM Big Block V8 454cu.in.
 Used with:
 Risers: 18-1939, 18-1999, and 18-1907



18-8536
EXHAUST ELBOW MOUNTING KIT
 Barr, Indmar and Marine Power GM Small Block V8 305-350cu.in.
 Used with:
 Manifold: 18-1997-1



PIPE PLUGS

Part #	Thread Size	Part #	Thread Size
18-4256	1/4"	18-4263	1/8" - 27 NPT
18-4257	1/4"	18-4264	3/8" - 18 NPT
18-4258	3/4"		



18-4218D



18-4218
BRASS DRAIN COCK (1/4")
 Used with:
 Most O.E.M. Manifolds
18-3223-9 (Bulk Pack of 12)



18-8538
EXHAUST MANIFOLD MOUNTING KIT
 Barr and Indmar Ford Small Block V8 302-351cu.in.
 Used with:
 Manifold: 18-1998-1

PKG. OF 8



FREEZE PLUGS

18-5961 **18-5962**
18-5961-9 **18-5962-9**
 1 5/8" 1 3/4"
 BRONZE



18-4461
HOSE BARB
 3/4" - 14 NPT x 1" Hose
 Corrosion Resistant Brass Fitting



18-8215
HOSE BARB
 Fits: Chrysler V8



18-8216
HOSE BARB
 Fits: Chrysler-Small Block V8 (318-360ci), Big Block V8(383-440)

CRUSADER MODEL IDENTIFICATION

MODEL C X L X H F L 245 M SERIAL 631254

- 1st Space: **MANUFACTURER**
C - Crusader
- 2nd Space: **FACTORY FRESHWATER / CLOSED COOLING**
X - Freshwater Cooled
(Space Omitted If Raw Water Cooled)
- 3rd Space: **ENGINE ROTATION**
L - Rotation, Left-Hand from Rear
R - Rotation, Right-Hand from Rear
- 4th Space: **ENGINE TYPE**
A = 5.7L (350 CID HO) (GM)
G = 5.0L (305 CID) (GM)
Q = 6.0L (364 CID) (GM)
X = 8.1L (496 CID STD) (GM)
Z = 8.1L (496 CID HO) (GM)
- 5th Space: **DRIVE MANUFACTURER**
W - Borg-Warner
H - Hurth
T - Walters
V - Velvet Drive (cast iron units specify 71c or 72c)
- 6th Space: **DRIVE FUNCTION / APPLICATION**
R - Reverse / Reduction
V - Vee Drive / Reversed Risers
F - Full Reversing
- 7th Space: **PROPELLER SHAFT ROTATION**
L - Left-Hand Rotation
R - Right-Hand Rotation

8th 9th 10th Spaces: **DRIVE GEAR RATIO OR REDUCTION**
The drive gear ratio will appear in these spaces which identifies the production gear specs. The example gear number shown is a (2.45:1). If the gear being identified does not have 3 digits, a "0" will appear in 10th space.
Example: (2.0:1) will appear as 200
(1.5:1) will appear as 150

***MODELS ENDING WITH "000000" IN PLACE OF DRIVE I.D. ARE BOBTAIL ENGINES.**

11th Space: **IGNITION / FUEL TYPE USED**
D - DISTRIBUTOR (Carb)
E - THROTTLE BODY INJECTION
M - MULTI-PORT FUEL INJECTION

SERIAL NUMBER I.D.
1st DIGIT INDICATES DECADE ENGINE WAS MANUFACTURED (5 = 1990, 6 = 2000, 7 = 2010)
2nd DIGIT INDICATES YEAR ENGINE WAS MANUFACTURED.

<p style="text-align: center;">①18-5250D Display Package</p>  <p>18-5250 TUNE-UP KIT</p> <table style="width: 100%; border-collapse: collapse;"> <thead> <tr> <th style="width: 20%;">Part #</th> <th style="width: 40%;">Description</th> <th style="width: 40%;">O.E. #</th> </tr> </thead> <tbody> <tr> <td>18-5311</td> <td>Contact Set</td> <td></td> </tr> <tr> <td>18-5345</td> <td>Condenser</td> <td></td> </tr> <tr> <td>18-5418</td> <td>Rotor</td> <td></td> </tr> </tbody> </table> <p style="text-align: center;">Delco 4 & 6 cyl.</p>	Part #	Description	O.E. #	18-5311	Contact Set		18-5345	Condenser		18-5418	Rotor		<p style="text-align: center;">①18-5251D Display Package</p>  <p>18-5251 TUNE-UP KIT</p> <table style="width: 100%; border-collapse: collapse;"> <thead> <tr> <th style="width: 20%;">Part #</th> <th style="width: 40%;">Description</th> <th style="width: 40%;">O.E. #</th> </tr> </thead> <tbody> <tr> <td>18-5314</td> <td>Contact Set</td> <td>20117</td> </tr> <tr> <td>18-5338</td> <td>Condenser</td> <td>12530</td> </tr> <tr> <td>18-5404-1</td> <td>Rotor</td> <td>20223</td> </tr> </tbody> </table> <p style="text-align: center;">Mallory 8 cyl. Tall Cap</p>	Part #	Description	O.E. #	18-5314	Contact Set	20117	18-5338	Condenser	12530	18-5404-1	Rotor	20223
Part #	Description	O.E. #																							
18-5311	Contact Set																								
18-5345	Condenser																								
18-5418	Rotor																								
Part #	Description	O.E. #																							
18-5314	Contact Set	20117																							
18-5338	Condenser	12530																							
18-5404-1	Rotor	20223																							
<p style="text-align: center;">①18-5252D Display Package</p>  <p>18-5252 TUNE-UP KIT</p> <table style="width: 100%; border-collapse: collapse;"> <thead> <tr> <th style="width: 20%;">Part #</th> <th style="width: 40%;">Description</th> <th style="width: 40%;">O.E. #</th> </tr> </thead> <tbody> <tr> <td>18-5310</td> <td>Contact Set</td> <td></td> </tr> <tr> <td>18-5344</td> <td>Condenser</td> <td></td> </tr> <tr> <td>-</td> <td>Rotor</td> <td></td> </tr> </tbody> </table> <p style="text-align: center;">Delco 8 cyl.</p>	Part #	Description	O.E. #	18-5310	Contact Set		18-5344	Condenser		-	Rotor		<p style="text-align: center;">①18-5255D Display Package</p>  <p>18-5255 TUNE-UP KIT</p> <table style="width: 100%; border-collapse: collapse;"> <thead> <tr> <th style="width: 20%;">Part #</th> <th style="width: 40%;">Description</th> <th style="width: 40%;">O.E. #</th> </tr> </thead> <tbody> <tr> <td>18-5303</td> <td>Contact Set</td> <td>41058</td> </tr> <tr> <td>18-5345</td> <td>Condenser</td> <td>41057, 705787</td> </tr> <tr> <td>18-5407</td> <td>Rotor</td> <td>41059</td> </tr> </tbody> </table> <p style="text-align: center;">Prestolite 8 cyl.</p>	Part #	Description	O.E. #	18-5303	Contact Set	41058	18-5345	Condenser	41057, 705787	18-5407	Rotor	41059
Part #	Description	O.E. #																							
18-5310	Contact Set																								
18-5344	Condenser																								
-	Rotor																								
Part #	Description	O.E. #																							
18-5303	Contact Set	41058																							
18-5345	Condenser	41057, 705787																							
18-5407	Rotor	41059																							
<p style="text-align: center;">①18-5256D Display Package</p>  <p>18-5256 TUNE-UP KIT</p> <table style="width: 100%; border-collapse: collapse;"> <thead> <tr> <th style="width: 20%;">Part #</th> <th style="width: 40%;">Description</th> <th style="width: 40%;">O.E. #</th> </tr> </thead> <tbody> <tr> <td>18-5314</td> <td>Contact Set</td> <td>20117</td> </tr> <tr> <td>18-5338</td> <td>Condenser</td> <td>12530</td> </tr> <tr> <td>18-5411</td> <td>Rotor</td> <td>12531</td> </tr> </tbody> </table> <p style="text-align: center;">Mallory 8 cyl. Flat Cap</p>	Part #	Description	O.E. #	18-5314	Contact Set	20117	18-5338	Condenser	12530	18-5411	Rotor	12531													
Part #	Description	O.E. #																							
18-5314	Contact Set	20117																							
18-5338	Condenser	12530																							
18-5411	Rotor	12531																							

① Items ending in "D" are Display Packaged - Regular number is Non-Display

①18-5258D



**18-5258
TUNE-UP KIT**

Part #
18-5303
18-5347
18-5407

—CONTAINS—
O.E. #
41058
41059

Description
Contact Set
Condenser
Rotor



**18-5259
TUNE-UP KIT**

Part #
18-5303
18-5347
18-5429

—CONTAINS—
O.E. #
41058
—

Description
Contact Set
Condenser
Rotor

①18-5260D



**18-5260
TUNE-UP KIT**

Part #
18-5303
18-5345
18-5403

—CONTAINS—
O.E. #
41058
41057, 705787

Description
Contact Set
Condenser
Rotor



**18-5266
TUNE-UP KIT**

Fits: Flame Thrower Distributors 18-5481, 18-5482, 18-5483, 18-5477, 18-5478, 18-5479

**18-5269
TUNE-UP KIT**



Part #
18-5311
18-5345
18-5418
18-5386

—CONTAINS—

Description
Contact Set
Condenser
Rotor
Distributor Cap

GM V-6 — Single Point



**18-5271
TUNE-UP KIT**

Part #
18-5314
18-5338
18-5404-1
18-5376

—CONTAINS—
O.E. #
20117
12530
20223
20222

Description
Contact Set
Condenser
Rotor
Distributor Cap

Mallory V-8 Tall Cap — Single Point



**18-5272
TUNE-UP KIT**



Part #
18-5314
18-5338
18-5411
18-5375

—CONTAINS—
O.E. #
20117
12530
12531

Description
Contact Set
Condenser
Rotor
Distributor Cap

1003317, 12532
Mallory V-8 Flat Cap — Single Point - Side



**18-5275
TUNE-UP KIT**

Part #
18-5303
18-5347
18-5403
18-5352

—CONTAINS—
O.E. #
41058
41069, 41074
41076

Description
Contact Set
Condenser
Rotor
Distributor Cap

Prestolite V-8 - Single Point - Screw Down Cap



**18-5276
TUNE-UP KIT**

Part #
18-5303
18-5347
18-5403
18-5363

—CONTAINS—
O.E. #
41058
41089, 41074
41089

Description
Contact Set
Condenser
Rotor
Distributor Cap

Prestolite V-6 - Single Point - Screw Down Cap



**18-5277
TUNE-UP KIT**

Part #
18-5303
18-5347
18-5407
18-5369

—CONTAINS—
O.E. #
41058
—
41059
41052





Description
Contact Set
Condenser
Rotor
Distributor Cap

Prestolite V-8 - Single Point - Clip Down Cap



APPLICATION BEGINS ON PAGE 615

Items ending in "D" are Display Packaged - Regular number is Non-Display

 <p>18-5278 TUNE-UP KIT Delco EST - V-6</p>	 <p>18-5279 TUNE-UP KIT Prestolite Electronic - V-8</p> <p style="text-align: center;">—CONTAINS—</p> <table border="1"> <thead> <tr> <th>Part #</th> <th>Description</th> <th>O.E. #</th> <th>Qty.</th> </tr> </thead> <tbody> <tr> <td>18-5352</td> <td>Distributor Cap</td> <td>392-9766</td> <td>1</td> </tr> <tr> <td>18-5403</td> <td>Rotor</td> <td>392-9089</td> <td>1</td> </tr> </tbody> </table>		Part #	Description	O.E. #	Qty.	18-5352	Distributor Cap	392-9766	1	18-5403	Rotor	392-9089	1								
Part #	Description	O.E. #	Qty.																			
18-5352	Distributor Cap	392-9766	1																			
18-5403	Rotor	392-9089	1																			
 <p>18-5280 TUNE-UP KIT Delco EST - In-Line 4</p> <p style="text-align: center;">—CONTAINS—</p> <table border="1"> <thead> <tr> <th>Part #</th> <th>Description</th> <th>O.E. #</th> <th>Qty.</th> </tr> </thead> <tbody> <tr> <td>18-5361</td> <td>Distributor Cap</td> <td>986643</td> <td>1</td> </tr> <tr> <td>18-5406</td> <td>Rotor, Delco</td> <td>986651</td> <td>1</td> </tr> </tbody> </table>	Part #	Description	O.E. #	Qty.	18-5361	Distributor Cap	986643	1	18-5406	Rotor, Delco	986651	1	 <p>18-5281 TUNE-UP KIT Delco EST - V-8</p> <p style="text-align: center;">—CONTAINS—</p> <table border="1"> <thead> <tr> <th>Part #</th> <th>Description</th> <th>O.E. #</th> <th>Qty.</th> </tr> </thead> <tbody> <tr> <td>18-5354</td> <td>Distributor Cap</td> <td>808483</td> <td>1</td> </tr> </tbody> </table>	Part #	Description	O.E. #	Qty.	18-5354	Distributor Cap	808483	1	 <p>18-5301 TUNE-UP KIT</p> <p>Replaces: Fits: male cap v-8 flamethrower distributors</p>
Part #	Description	O.E. #	Qty.																			
18-5361	Distributor Cap	986643	1																			
18-5406	Rotor, Delco	986651	1																			
Part #	Description	O.E. #	Qty.																			
18-5354	Distributor Cap	808483	1																			
 <p>18-5302 TUNE-UP KIT</p> <p>Replaces: Fits: male cap v-8 flamethrower distributors</p>	 <p>18-5303 CONTACT SET</p> <p>Replaces: 41058</p>	 <p>18-5307 CONTACT SET</p> <p>Replaces: 705788</p>	 <p>18-5310 CONTACT SET</p> <p>Replaces: 12525</p>																			
 <p>18-5311 CONTACT SET</p>	 <p>18-5314 CONTACT SET</p> <p>Replaces: 20117</p>	 <p>18-5318 CONTACT SET</p> <p>Replaces: 3000124</p>	 <p>18-5338 CONDENSER</p> <p>Replaces: 12530</p>																			
 <p>18-5344 CONDENSER</p> <p>Replaces: 12526</p>	 <p>18-5345 CONDENSER</p> <p>Replaces: 41057, 705787</p>	 <p>18-5347 CONDENSER</p>	 <p>18-5403 ROTOR</p> <p>Replaces: 41089, 41074</p>																			

APPLICATION BEGINS ON PAGE 615



**18-5404-1
ROTOR**
Replaces: 20223



**18-5405
ROTOR**
Replaces: 38071
Use with 18-5354 Distributor Cap
Fits: New GM style "Module in Cap"
distributors - V-8 application



**18-5406
ROTOR**
Use with 18-5361 Distributor Cap



**18-5407
ROTOR**
Replaces: 41059



**18-5408
ROTOR**
Use with 18-5362 Distributor Cap
Fits: New GM Style "Module in Cap"
Distributors
V6 Applications



**18-5411
ROTOR**
Replaces:
12531,1003318



**18-5418
ROTOR**



**18-5300
ROTOR**
Fits: Flamethrower Distributors



**18-5420
ROTOR**
Replaces: 3000122



**18-5427
ROTOR**
Replaces: 705786



**18-5429
ROTOR**



**18-5301
TUNE-UP KIT**
Replaces:
Fits: Male cap v-8 flamethrower distributors



**18-5302
TUNE-UP KIT**
Replaces:
Fits: Male cap v-8 flamethrower distributors



**18-5352
DISTRIBUTOR CAP**
Replaces: 41076
Prestolite



**18-5353
DISTRIBUTOR CAP**
Replaces: 41069
Prestolite



**18-5354
DISTRIBUTOR CAP**
Replaces: 38070
Fits: New GM style "Module in Cap"
Distributors - V-8 applications
Use 18-5405 Rotor



**18-5361
DISTRIBUTOR CAP**
Fits: New GM style "Module in Cap"
Distributors - 4 cyl.
applications Use 18-5406 Rotor



**18-5362
DISTRIBUTOR CAP**
Fits: New GM Style "Module in Cap"
Distributors - V6
Applications Use 18-5408 Rotor



**18-5369
DISTRIBUTOR CAP**
Includes Gasket: 18-5399
Replaces: 41052
Prestolite



**18-5473
DISTRIBUTOR CAP**
Black Distributor Cap with Male
Terminals for Flamethrower
Distributors

 <p>18-5474 DISTRIBUTOR CAP Red Distributor Cap with Male Terminals for Flamethrower Distributors</p>	 <p>18-5375 DISTRIBUTOR CAP Replaces: 12532, 1003317</p>	 <p>18-5376 DISTRIBUTOR CAP Replaces: 20222</p>	 <p>18-5384 DISTRIBUTOR CAP Replaces: 12528</p>
 <p>18-5386 DISTRIBUTOR CAP</p>	 <p>18-5389 DISTRIBUTOR CAP Replaces: 3000121</p>	<p>PKG. OF 2</p>  <p>18-5399 18-5399-9 DISTRIBUTOR CAP GASKET Replaces: 41061</p>	



FEATURES

- Senses current levels in the coil and adjusts the dwell to maintain peak energy throughout the entire RPM range.
- Develops, on average, 4 times more available energy between 3000 and 5000 RPM's and twice as much plug voltage as point-type systems.
- Ignition energy is sustained and coil life is increased when peak current level is reached just prior to spark.
- More stable timing.
- Use with 18-5472 "Flame Thrower II" Coil for optimum performance.

18-5288
HI-PERFORMANCE
ELECTRONIC CONVERSION KIT
Fits: Most Prestolite V-8
Distributors with snap down cap



18-5289
HI-PERFORMANCE
ELECTRONIC CONVERSION KIT
Fits: Most Prestolite V-8
Distributors with screw down cap



18-5290
HI-PERFORMANCE
ELECTRONIC CONVERSION KIT
Fits: Most Mallory YL or YD 8 cylinder
Distributors with clockwise and counter clockwise rotation





FEATURES

- Replaces points & condensers for true solid state ignition.
- Uses standard coil, cap and rotor.
- Easy to install, one-piece, 2-wire hook-up.
- Accurate to within 1/4° timing accuracy 0 to 6000 RPM range.
- Can be used with Flame Thrower Coils 18-5466 & 18-5469.

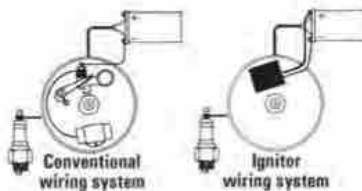

18-5294
ELECTRONIC CONVERSION KIT
Fits: 6 Cyl. Delco distributors



18-5295
ELECTRONIC CONVERSION KIT
Fits: Most 4 Cyl. Prestolite distributors (except IBM 7026)
For: Onan, Universal, Waukesha, Wisconsin



18-5296-2D
ELECTRONIC CONVERSION KIT
Fits: Most Mallory YL & YD 8 cyl. Distributors with clockwise and counter clockwise rotation



18-5298
ELECTRONIC CONVERSION KIT
With snap down cap
For: Most Prestolite V-8 Distributors



18-5299D
ELECTRONIC CONVERSION KIT
With screw down cap
For: Most Prestolite V-8 Distributors
Use with 18-5403 style rotor

PREMIUM MARINE SPARK PLUG WIRE LEADS

Sierra's MAGFORCE Ignition Wires are "Electronics Friendly" protecting all of your electronic devices and electronic engine controls from RFI and EMI while delivering the maximum amount of voltage. Exact fit design ensures easy installation and years of trouble - free service.



CRUSADER MARINE IGNITION WIRES APPLICATION

Engine	Cyl.	Distributor	Years	Plug Wire Set
220 (305 CID 5.0L)	8	Mallory/Prestolite	1987-1992	18-8803-2
270 (350 CID 5.7L)	8	Mallory/Prestolite	Up to 1987	18-8803-2
270 (350 CID 5.7L)	8	Mallory/Prestolite	1987-1992	18-8803-2
TB350	8	Delco EST	1992 & Up	18-8824-1
5.7L Classic	8	Mallory	1999 & Up	18-8803-2
5.7L MPI Classic	8	Delco HVS	2007 & Up	18-8828-1
MP5.0L Captain's Choice	8	Delco HVS	2002-2005	18-8828-1
MP5.7L Captain's Choice	8	Delco HVS	2002-2005	18-8828-1
MP6.0L	8	Distributorless	2002 & Up	18-8838-1
350 (454 CID 7.4L)	8	Mallory	Up to 1991	18-8803-2
454XL (454 CID 7.4L)	8	Delco EST	1991 & Up	18-8824-1
CM454HO (454 CID 7.4L)	8	Delco EST	1991 & Up	18-8824-1
454XL (454 CID 7.4L)	8	Delco EST	1993 & Up	18-8824-1
MP8.1L	8	Distributorless	ALL	18-8838-1
502 (502 CID 8.2L)	8	Prestolite	Up to 1991	18-8803-2
502 (502 CID 8.2L)	8	Delco EST	Up to 1991	18-8824-1
502XL (502 CID 8.2L)	8	Delco EST	1991 & Up	18-8824-1
TB502XL (502 CID 8.2L)	8	Delco EST	1994 & Up	18-8824-1

CRUSADER MARINE IGNITION WIRES APPLICATION

Engine	Cyl.	Distributor	Years	Plug Wire Set
262 CID 4.3L	6	Prestolite	ALL	18-8801-1
262 CID 4.3L	6	Delco EST	ALL	18-8810-1
262 CID 4.3L	6	Delco HVS	ALL	18-8829-1
220 (305 CID 5.0L)	8	Mallory/Prestolite	Up to 1987	18-8803-2

- Serial Number up to 68702
- Serial Number 68703-90232
- Serial Number 90232 & 100000
- Serial Number up to 88710
- Serial Number 88710 & Up
- Serial Number 92882 & Up
- Serial Number 94268 & Up

APPLICATION BEGINS ON PAGE 615

Items ending in "D" are Display Packaged - Regular number is Non-Display

BATTERY CABLES

Gauge cable with soldered lug terminals on each end to accept 3/8" stud.



PART NO.	SIZE	COLOR	GAUGE	PART NO.	SIZE	COLOR	GAUGE
BC88523	2'	red	4	BC88563	6'	red	2
BC88533	2'	black	4	BC88573	6'	black	2
BC88543	4'	red	2	BC88583	8'	red	1
BC88553	4'	black	2	BC88593	8'	black	1

18-5225 SPARK PLUG WIRE KIT

Replaces: Mercury 84-99215A26, 84-813706A26
Kit includes 25 ft. Roll of 7 MM Hypalon Ignition Wire With a Metallic Core and a Large Assortment of Three Different End Fittings.



**18-5226
IGNITION WIRE**
Metallic Core
100' Spool • 7mm Hypalon

PKG. OF 10



**18-5224
18-5224-9[Ⓢ]
SPARK PLUG WIRE
TERMINAL**
Replaces: Mercury 20121
OMC 510364

PKG. OF 10



**18-5750
18-5750-9[Ⓢ]
UNIVERSAL SPARK
PLUG BOOTS**
Supplied complete w/Terminal Connector
Replaces:
OMC 581027, 580339



**18-5752
UNIVERSAL SPARK PLUG
BOOTS**
8mm

FEATURES

- Distributors feature the Ignitor II Ignition module with adaptive dwell control adjusts the spark timing over the entire RPM range to maximize performance
- Upper roller bearing and oil impregnated bronze sintered bottom bushing are installed and aligned bored for accuracy for maximum durability
- Machined heat treated gear with tight tolerances insures durability and consistent timing to maximize horsepower and performance. Complete with high dielectric strength cap and rotor for years of performance

Standard Rotation:

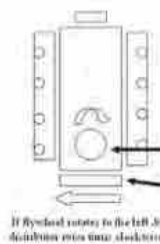

CCW Rotation:

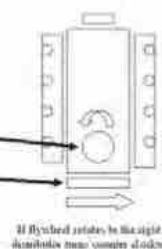

18-5483 HI-PERFORMANCE ELECTRONIC DISTRIBUTOR

Fits: Chevrolet Marine Small and Big Block engines (Standard Deck Height)
Replacement cap/rotor kit 18-5266



**18-5309-1
DISTRIBUTOR**
Replaces: Mallory YL512CV
For most Ford 302 CID V-8 Eng.
Tune-Up Kit 18-5251

— CONTAINS —
Part # 18-5314 Desc. Contact Set
18-5338 Condenser
18-5404-1 Rotor



18-5313-1 DISTRIBUTOR

Replaces:
Crusader 37061
Mallory YL624MW
For most GM V-8 Eng. small & large block Mallory Tall Cap
Tune-Up Kit 18-5251



— CONTAINS —
Part # 18-5314 Desc. Contact Set
18-5338 Condenser
18-5404-1 Rotor

ELECTRONIC DISTRIBUTORS U.L. Approved

Part No.	Rotation	Application
18-5494-2	Conventional	Chevrolet All V8 (exc. 348,409 & Tall Deck Big Block)
18-5495-2	Conventional	Ford V-8, 302 CID

*Older reverse rotation engines with reverse cut camshaft gear

USES:			
Part #	Description	Part #	Description
18-5376	Distributor Cap	18-5488	Module
18-5404-1	Rotor		

Ⓢ Priced per Package

**18-5484-1
ELECTRONIC
DISTRIBUTOR**

Conventional Rotation

Replaces: RA107039E

Late Model HEI

For V8 — 262-454 & 502 except

384/409 and tall block engines

• Designed as a plug-in replacement
for GM-style fuel injection system
distributors



—CONTAINS—

Description	Part #
Distributor Cap	18-5354
Rotor	18-5405



**18-5480
COMPLETE IGNITION
CONVERSION KIT**

Fits: GM SB & BB with Standard Deck Height

—CONTAINS—

Part #	Description
18-5472	Coil
18-8803-2	Wire Set
18-5483	Distributor



**18-26812
HEI COIL GRAY CONNECTOR**



**18-26813
HEI COIL BLACK CONNECTOR**



**18-5108
PICKUP COIL
SENSOR**



**18-5107-1
IGNITION MODULE**
4/6/8 cyl.
Replaces: 7243110



**18-26810
GM HEI 4 TERMINAL
PIGTAIL**
Fits: GM HEI Distributors
w/4 terminals



**18-26811
GM HEI 2 TERMINAL
PIGTAIL**
Fits: GM HEI Distributors
w/2 terminals

FEATURES

- Oil filled for better cooling and long life
- Low resistance and improved turn ratios produces the higher voltage needed to run larger spark plug gaps for added power and better fuel economy
- More windings maximize energy and reliability over the full RPM range
- Fits existing brackets for easy installation

**18-5466
HI-PERFORMANCE
IGNITION COIL**

1.5 ohm (oil filled), black - 8
cylinder; Flame-Thrower 40,000
volt coil.

- ★ Designed for use with the original
Ignitor Electronic Conversion Kits
- ★ Can be used with other inductive
ignition systems



**18-5469
HI-PERFORMANCE
IGNITION COIL**

3.0 ohm (oil filled), black - 4 & 6 cylin-
der; Flame-Thrower 40,000 volt coil.

- ★ Designed for use with the original
Ignitor Electronic Conversion Kits
- ★ Can be used with other inductive
ignition systems



**18-5472
HI-PERFORMANCE
IGNITION COIL**

0.6 ohm (oil filled), black - 4, 6, &
8 cylinder; Flame-Thrower 45,000
volt coil.

- ★ Super low 0.6 ohm resistance coil
designed for use with the Ignitor II
Hi Performance Electronic
Conversion Kits
- ★ Compatible with capacitive
discharge systems



Part #	Description	Recommended Coil	Resistance Ohms	Part #	Description	Recommended Coil	Resistance Ohms
18-5294	Electronic Conversion Kit	18-5469	3.0	18-5288	Hi Performance Electronic Conversion Kit	18-5472	0.6
18-5295	Electronic Conversion Kit	18-5469	3.0	18-5289	Hi Performance Electronic Conversion Kit	18-5472	0.6
18-5296-2	Electronic Conversion Kit	18-5466	1.5	18-5290	Hi Performance Electronic Conversion Kit	18-5472	0.6
18-5298	Electronic Conversion Kit	18-5466	1.5	18-5483	Flame-Thrower Distributor	18-5472	0.6
18-5299	Electronic Conversion Kit	18-5466	1.5				

**18-5433
IGNITION COIL**
Replaces: 37068, 51080
Uses External Resistor



**18-5435
IGNITION COIL**
4.0 OHM
Replaces: 41080
Has Internal Resistor



**18-5436
IGNITION COIL**
3.0 OHM
Has Internal Resistor
(For Mallory Applications)



**18-5438
IGNITION COIL**
Replaces: 37068
HEI



**18-5443
IGNITION COIL**
Replaces: 7243200
4cyl./V-8
For: 3.0L (1991 & up) 5.7 & 7.4 EFI
(1995 & up)



**18-5450
COIL RESISTOR**
1.5 OHM



IGNITION / ELECTRICAL SYSTEMS APPLICATION

Cyl.	Model Engine	Year	Distributor No.	Contact Set	Condenser	Rotor	Dist. Cap	Tune-Up Kit	Distributor	Elect. Con. Kit
4	153	1961-69	YL486C,D	18-5314	18-5338	18-5427	—	—	—	—
4	IH60,M60, PH45,134	1971-75	IAY4010A	18-5307	18-5345	18-5427	—	—	—	—
6	230,292 Chevy	1961-69	YL486A,B	18-5314	18-5338	18-5427	—	—	—	—
6	229,3.8L	1980-82	IBM7014,A	18-5303	18-5345	18-5403	18-5353	18-5260, 18-5276	—	—
6	229,262	1983-88	IBM7018	18-5303	18-5345	18-5403	18-5353	18-5260	—	—
6	229,262	1983-88	IBM7021	18-5303	18-5345	18-5403	18-5353	18-5260, 18-5276	—	—
8	185,230, 250, 280	1962	IBM4110	18-5303	18-5345	18-5429	—	18-5259	—	—
8	283,327,348	1961-69	YL487A	18-5314	18-5338	18-5404-1	18-5376	18-5251, 18-5271	18-5494-2 18-5498-1 18-5313-1	18-5296
8	185,220,230	1961-69	ZD431A, YL431A	18-5314	18-5338	18-5411	18-5375	18-5256	—	—
8	170,220,225HP, 275CAD	1961-69	ZD345A,B, ZD345A,B	18-5314	18-5338	18-5404-1	18-5376	18-5251, 18-5271	18-5494-2 18-5498-1 18-5313-1	18-5296
8	283,327,409,427	1965-71	1111161	18-5310	18-5344	—	18-5384	18-5252, 18-5270	18-5494-2 18-5498-1 18-5313-1	18-5296
8	302,351	1971-75	—	18-5318	—	18-5420	18-5389	—	18-5495-2 18-5309-1	—
8	302	1975-78	IBM7007,A	18-5303	18-5345	18-5407	18-5369	18-5258, 18-5277	18-5495-2 18-5309-1	18-5298
8	305,350,454	1977-82	IBM7011,D	18-5303	18-5345	18-5407	18-5369	18-5258, 18-5277	18-5495-2 18-5309-1	18-5298
8	305,350,454	1977-82	IBM7013	18-5303	18-5345	18-5403	18-5352	18-5260, 18-5275	18-5494-2 18-5498-1 18-5313-1	18-5299
8	305,350,454	1983-87	Mallory	18-5314	18-5338	18-5404-1	18-5376	18-5251, 18-5271	18-5494-2 18-5498-1 18-5313-1	18-5296
8	ALL	1987-88	IDU78018,C B.I.D.Elec. Ign.	N/A	N/A	18-5403	18-5352	N/A	—	—

① Electronic Distributor (Standard Rotation)
② Electronic Distributor (Counter Rotation)

Ⓢ Contact Controlled Distributor (Standard Rotation)
Ⓢ Mallory Ignition Only

Ⓢ For Strap Type Condenser, use 18-5347
Ⓢ Tune-Up Kit with Distributor Cap

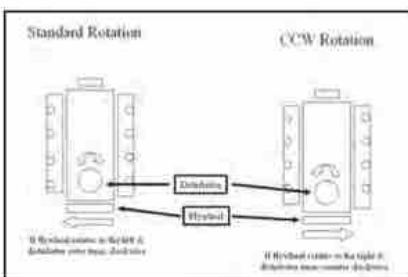

**18-5907
STARTER**
(Heavy Duty) (No Core) Clockwise
Top Mount Rear Entry Starter
Will not replace non-starter mounted solenoids.
For: Opposite Rotation GM & Ford Engines.
Replaces: 42090
Replacement Solenoid: **18-5837**
SAEJ1171

**18-5908
STARTER**
(Heavy Duty) (No Core)
Counter-Clockwise
Top Mount Rear Entry Starter
For: Standard Rotation GM & Ford Engines.
Replaces: 42091
Replacement Solenoid: **18-5837**
SAEJ1171

**18-6835
STARTER**
Replaces: GM Engines Universal
Used on all GM Engines with either 14 1/4" or 12 3/4" flywheels

**18-6834
STARTER**
Replaces: GM Engines Universal
Used on all GM Engines with either 14 1/4" or 12 3/4" flywheels

**18-9802
TIMING LIGHT**
Self-powered accurate up to 10,000 RPM's

**18-15214
RELAY, SHROUDED**
Replaces: R130012
For: Fuel Pump on Crusader MEFI systems

**18-5717
STARTER BRUSH SET**
Replaces: 42001, 707125
Delco

**18-5838
SOLENOID**
Delco

**18-5840
SOLENOID**
Prestolite 15-79,
SAW4201, SAW4207,
SAW4210

**18-2434
FLYWHEEL
BELL HOUSING**
Replaces: 96938









BRUSH SET / STARTER SWITCH APPLICATION

Year	Voltage	Original Starter No.	Brush Set	Starter Switch
1960-75	12	MDU-7015, 16	—	18-5840
1975-81	12	MEO-7044, 05	—	18-5840
1972-UP	12	96077, 96078 42031, 420036 1107710, 54, 63, 889	18-5717	18-5838

 18-5710 VOLTAGE REGULATOR Prestolite VSH-6201JY	PKG. OF 8  FREEZE PLUGS 18-5961 18-5962 18-5961-9[Ⓢ] 18-5962-9[Ⓢ] 1 5/8" 1 3/4"	 18-7600 TEMPERATURE SENSOR Replaces: 47002	 18-7630 THROTTLE POSITION SENSOR Replaces: 47032	 18-7632-1 IDLE AIR CONTROL MOTOR Replaces: 47033
--	---	---	---	---

VOLTAGE REGULATOR APPLICATION

Year	Model	Voltage	Original Alt./Gen. No.	Voltage Regulator
1966-75	Conqueror 190, 220, 250, 320	12	ALE-5204,S	18-5710
1966-75	150, 165, 185, 190, 230, 250, 280, 320	12	ALF-5201-1, A-1,S	—
		12	ALE-5202,S	—
		12	ALK-6204A	—
		12	ALE-5204,S	18-5710

 18-7607-1 CARBURETOR (REMANUFACTURED) Replaces: Rochester 17082403 For: Rochester Carb: Crusader 454	 18-7019 CARB KIT	 18-7022 CARB KIT
 18-7070 CARB KIT	 18-7072 CARB KIT	 18-7078 CARB KIT
 18-7086 CARB KIT	 18-7095 CARB KIT Replaces: 45334	

Ⓢ Priced per Package

CARBURETOR KIT APPLICATION ON NEXT PAGE



18-7200
FLOAT
Replaces: 45303
(Alcohol Resistant)
Plastic



18-7201
FLOAT
(Alcohol Resistant)
Brass



18-7202
FLOAT
(Alcohol Resistant)
Brass

CARBURETOR KIT AND FLOAT APPLICATION

Cyl.	Model or Eng. Displacement	Mfg. Code	Carb. Model	Carburetor Number	Carb. Kit ①	Float
4	153" (2.5L)	R-2	2GC	7025082, 7028086	18-7070	18-7200
6	225" (3.7L)	R-2	2GC	7025181	18-7070	—
8	283" (4.6L), 327 (5.3L)	R-2	2GC	7024185	18-7070	—
8	305" (5.0L)	R-2	2GV	17057134	18-7086	18-7202
8	327" (5.3L), 409 (6.6L)	R-4	4GC	7020084, 085	18-7019	—
8	327" (5.3L), 409 (6.6L)	R-4	4GC	7023084, 085, 089	18-7078	—
6	348" (5.7L)	C-4	AFB	2955	18-7022	—
8	350" (5.7L), 454 (7.4L)	R-4	4MV	17059293, 17082403	18-7095	18-7201
8	427" (7.0L)	R-4	4MV	7027081, 7028282	18-7072	18-7201

① Does Not Include Metering Rods

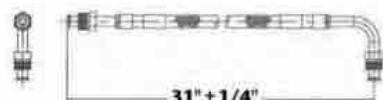

18-8114
FUEL LINE HOSE
UNIVERSAL
For fuel pump to carburetor connection. Replaces copper or steel tubing 3/8" X 31" PTFE composite hose with 5/8"-18 male inverted flare straight one end, 5/8"-18 90° one end. SAE J1527 type A1

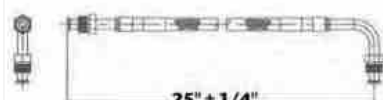

18-8115
FUEL LINE HOSE
UNIVERSAL
For fuel pump to carburetor connection. Replaces copper or steel tubing 3/8" X 25" PTFE composite hose with 5/8"-18 male inverted flare straight one end, 5/8"-18 90° one end. SAE J1527 type A1



18-7231
FLAME ARRESTOR
Replaces: 97595, 97214
V-8



18-7232
FLAME ARRESTOR
Replaces: 33628
Hi-Performance



18-7256
FUEL PUMP
Replaces: 32722
(Flange I.D. #6790, M3530)
For: GM (4 & 6 Cyl.) 153, 230, 250, 292



18-7260
FUEL PUMP
(Flange I.D. #40155)
For: GM (V-8) 283, 307, 327, 350, 409



18-7267
FUEL PUMP
(Flange I.D. #41414)
For: Ford (V-8) 302



18-7268
FUEL PUMP
(Flange I.D. #41415, M6948)
For: GM (V-8) 305, 307, 350, 400
(5.25 - 6.5 PSI)
Dual Diaphragm - Requires Sight Glass

18-7270
FUEL PUMP
 (Flange I.D. #41417, M73019)
 For: GM (V-8) 305, 350, 400
 (5.75 - 7 PSI)
Replaces: 21140
 (Gasket included)



18-7272
FUEL PUMP
 (Flange I.D. #41419, M73020)
 For: GM (V-8) 283, 305, 350, 400
 (5.75 - 6.5 PSI)
Replaces: 97039



FUEL WATER SEPARATORS



Sierra offers a complete line of 10 and 21 micron fuel water separating filters including drainable bowl filters to protect your carbureted and fuel injected engine.

**Refer to pages 153-158 for a complete listing of
 OEM and universal applications.**

Sierra fuel water separators remove over 99.8% of emulsified water from your gasoline. Sierra's 10 micron filters are over 90% efficient at removing particles as small as 10 micron. All filters flow @ 90 GPH to feed even the hungriest motor. Sierra 10 micron filters are recommended to prevent damage to sensitive inboard and outboard fuel injection systems.

Sierra #	Crusader #	Description
18-7852-1	22697	Fuel Water Separator Kit
18-7846	98041	Fuel Filter
18-7862	91606	Fuel Filter
18-7964-1		Fuel Filter
18-7717		Fuel Element (For: Rochester 2bb1 & 4bb1 Carburetors)



18-3060
IMPELLER
Replaces: 1003026, 22212
 For: Ford



18-3061
IMPELLER
Replaces: 20300
 For: GM engines with V-Belt



18-8926
IMPELLER
Replaces: RP061022
 Fits: Crusader 5.7 & 6.0L w/ Serpentine Belt

PKG. OF 2



18-3140
18-3140-9
WATER PUMP GASKET
Replaces: 20502
 For: Early 262, 305, 350
 (ID) 454, 502



① **18-3046D**



18-3046
IMPELLER KIT
Replaces: 1003062
 Contains: 18-3060 Impeller
 Diameter 2 7/16" • Side Width 1 1/4"
 Use with Sherwood Pumps



18-3047
IMPELLER KIT
 Includes 18-3061 Impeller

① Priced per Package



18-3577-2
CIRCULATING WATER PUMP
 (Bi-Directional)
Replaces: 67859, 17670, 811573, 30103
For: Big block GM engines with stamped steel timing covers



18-3599-2
CIRCULATING WATER PUMP
Replaces: 20318, 7142520
For: GM V-8 & small block V-8 engines
 Uses gasket **18-0981** (included)



18-3551
THERMOSTAT
Replaces: 96319
 142°
For:

Model No.	Cubic Inch
CH190	305
CH220	305
CH270	350
CH350	454



18-3552
THERMOSTAT
Replaces: 96358
 Fresh Water Cooling Only
 160°
For:

Model No.	Cubic Inch
165	229
CH190/CH220	305
CH270	350
CH350	454



18-3671
THERMOSTAT KIT
Replaces: 97361
 Includes Thermostat 18-3551 and 18-0875 Gasket
 142°
FOR:

Model No.	Cubic Inch
CH190	305
CH220	305
CH270	350
CH350	454



18-3649
THERMOSTAT
Replaces: 97895
 16°
 Fresh Water Cooling
 Use with 18-2917 Gasket



18-5898
SENDER
Replaces: 700427
 1/2" — 14 NPT



18-5899
OIL PRESSURE SENDER
Replaces: 700425



18-4456
EXHAUST PROTECTOR VALVE
 Includes Stainless Steel Clamp
 3"



18-4457
EXHAUST PROTECTOR VALVE
 Includes Stainless Steel Clamp
 4"



18-4458
EXHAUST PROTECTOR VALVE
 Includes Stainless Steel Clamp
 5" & 6" (5" requires two 45° cuts)

① Items ending in "D" are Display Packaged - Regular number is Non-Display

**Fits GM Big Block V8 454 cu. in.
Models CH350 & 454XL**

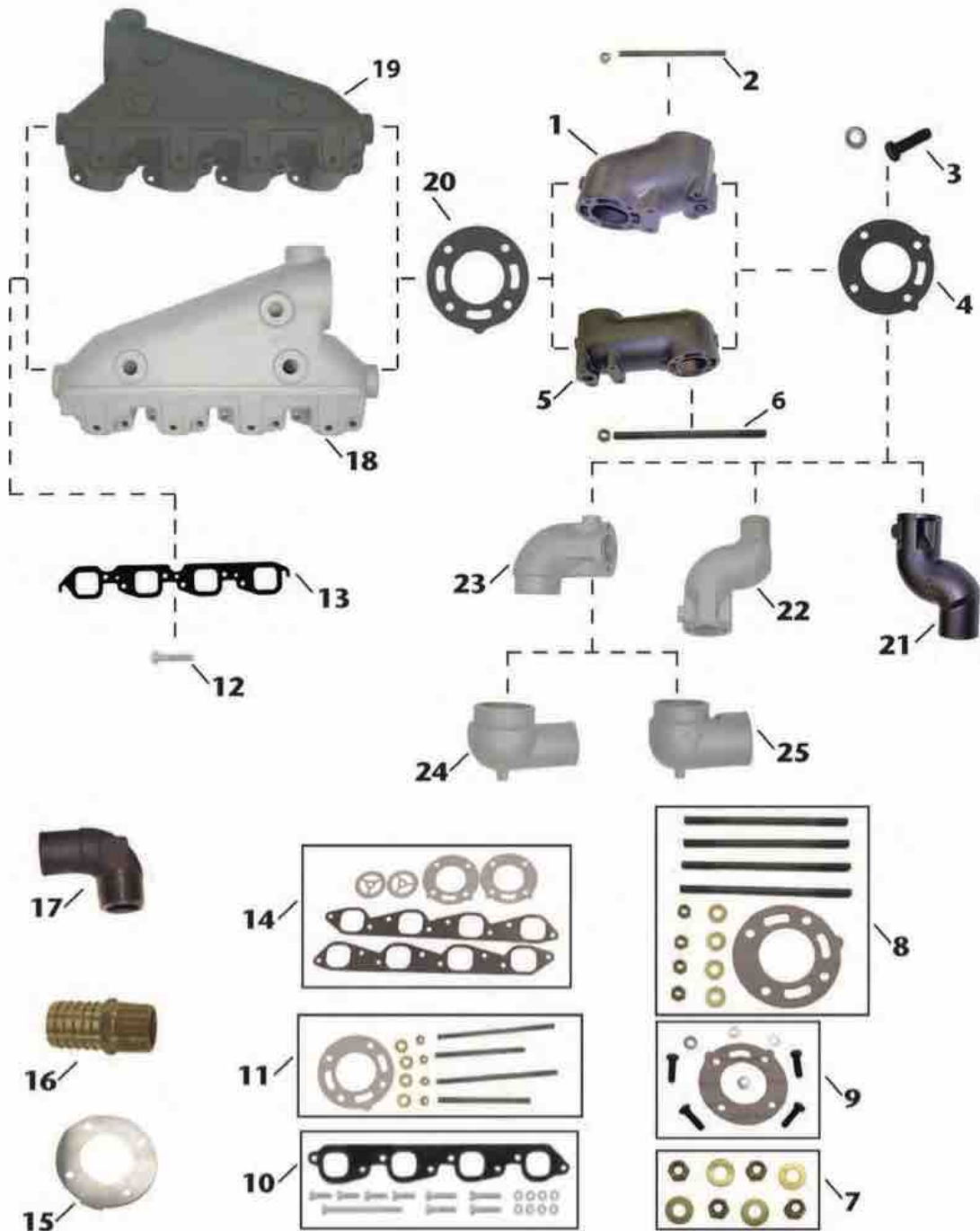

Item No.	Description	OE No.	Application
1	18-1927 4" RISER	97772	Use with Manifolds: 18-1933, & 18-1929; Elbow Gasket: 18-0309-1; Mounting Kit: 18-8523
2	NSS MOUNTING HARDWARE	N/A	Included in 18-8523 mounting kit.
3	NSS MOUNTING HARDWARE	N/A	Included in 18-8515 mounting kit.
4	18-0309-1 ELBOW GASKET	96562	Use with Exhaust Elbow: 18-1928, 18-1934, & 18-1918
5	18-1916 8" RISER	97169	Use with Manifolds: 18-1933, & 18-1929; Elbow Gasket: 18-0309-1; Mounting Kit: 18-8519
6	NSS MOUNTING HARDWARE	N/A	Included in 18-8519 mounting kit.
7	NSS WASHER & NUT KIT	N/A	Used in mounting kits: 18-8515, 18-8523, & 18-8519
8	18-8519 MOUNTING KIT	N/A	Use with Riser: 18-1916
9	18-8515 MOUNTING KIT	N/A	Use with Elbows: 18-1934, 18-1928, 18-1918
10	18-8524 MOUNTING KIT	N/A	Use with Manifolds: 18-1929 & 18-1933
11	18-8523 MOUNTING KIT	N/A	Use with Riser: 18-1927
12	NSS MOUNTING BOLT	N/A	Included in 18-8524 mounting kit.
13	18-0418 MANIFOLD GASKET	96653	Use with Manifold: 18-1929, 18-1933
14	18-0601 EXHAUST MANIFOLD GASKET SET	N/A	For: "CH" Model Big Block (V8) Chevy 454 CID (7.4L); Use with Manifolds: 18-1929, & 18-1933
15	18-1917 BLOCK OFF PLATE (STAIN-LESS)	97296	Use with Elbow/Riser Gasket: 18-0309-1, 18-0305-1
16	18-4461 HOSE FITTING	N/A	3/4" - 14NPT X 1" Hose (Corrosion Resistant Brass Fitting)
17	18-8112 HOSE FITTING	97296; 97854	90 degree fitting. Thread Size: 1" NPT X 1 1/4" Hose Barb
18	18-1929 MANIFOLD (STARBOARD)	97992, 97114	GM Big Block (V8) 454 cu.in. (Models CH350 & 454XL)(Starboard); Use with Manifold Gasket: 18-0418; Mounting Kit: 18-8524
19	18-1933 MANIFOLD (PORT)	97993, 97115	GM Big Block (V8) 454 cu.in. (Models CH350 & 454XL)(Port); Use with Manifold Gasket: 18-0418; Mounting Kit: 18-8524
20	18-0305-1 ELBOW GASKET	96108	Use with Exhaust Manifold: 18-1929, & 18-1933. Included in 18-8515 mounting kit.
21	18-1928 ELBOW W/ 4" OUTLET	97924	Use with Riser: 18-1927 or 18-1916; Elbow Gasket: 18-0309-1; Mounting Kit: 18-8515
22	18-1934 ELBOW W/ 3" OUTLET	98068	Use with Riser: 18-1927 or 18-1916; Elbow Gasket: 18-0309-1; Mounting Kit: 18-8515
23	18-1918 ELBOW W/ 2 1/2" INLET	97386	Use with Riser: 18-1927 or 18-1916; Elbow Gasket: 18-0309-1; Mounting Kit: 18-8515
24	18-1919 RE-DIRECTION ELBOW W/ 3" OUTLET	97387	Use with Elbow: 18-1918
25	18-1924 RE-DIRECTION ELBOW W/ 4" OUTLET	97624	Use with Elbow: 18-1918



Fits GM Big Block V8 454 cu. in. Models 454XL & 502XL

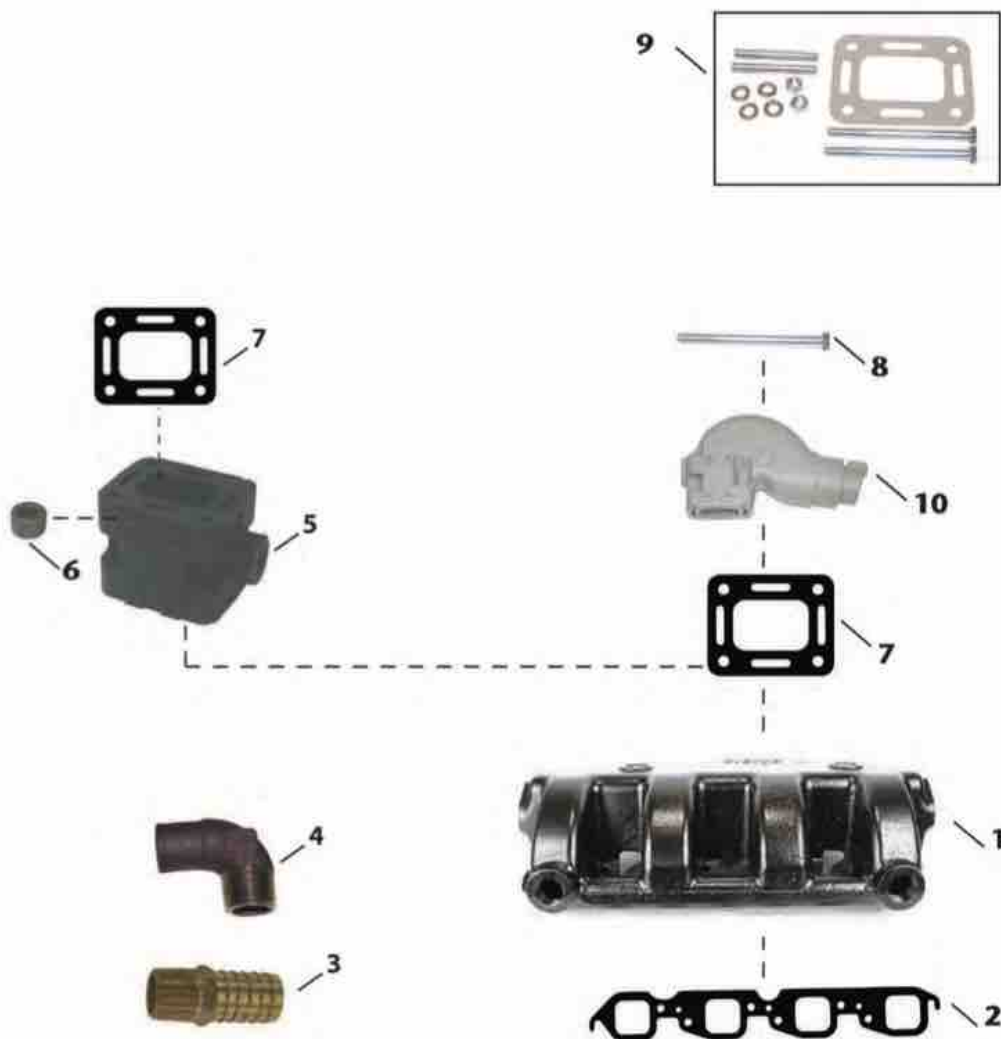

Item No.	Description	OE No.	Application	
1	18-1982	MANIFOLD	98125	GM Big Block (V8) 454-502 cu.in. (Port & Starboard); Use with Manifold Gasket: 18-0418
2	18-0418	MANIFOLD GASKET	96653	Use with Manifold: 18-1982.
3	18-4461	HOSE FITTING	N/A	3/4" - 14NPT X 1" Hose (Corrosion Resistant Brass Fitting)
4	18-8112	HOSE FITTING	97296; 97854	90 degree fitting. Thread Size: 1" NPT X 1 1/4"
5	18-1984	MANIFOLD SPACER	98128	Use with Elbow Gasket: 18-0475-1
6	18-4258	BLACKSTEEL PLUG	113186	Thread Size: 3/4" NPT X 1". Use with Spacer: 18-1984
7	18-0475-1	ELBOW GASKET (OPEN)	98127	Open gasket for universal elbow; Use with Riser: 18-1938
8	NSS	MOUNTING BOLT	N/A	Included in 18-8547 mounting kit.
9	18-8547	MOUNTING KIT	N/A	Use with Riser: 18-1938. Includes 18-0475-1 gasket.
10	18-1938	RISER	98126	Use with Manifold: 18-1982; Riser Gasket: 18-0475-1; Mounting Kit 18-8547

**Fits GM Small Block V8 305-350 cu. in.
Models 220 & 270**

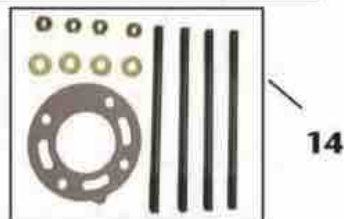
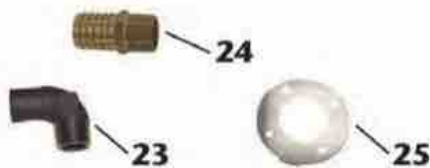
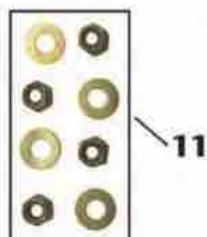
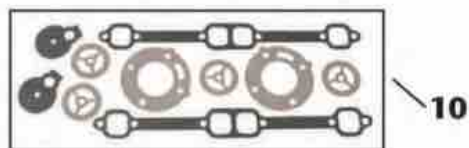
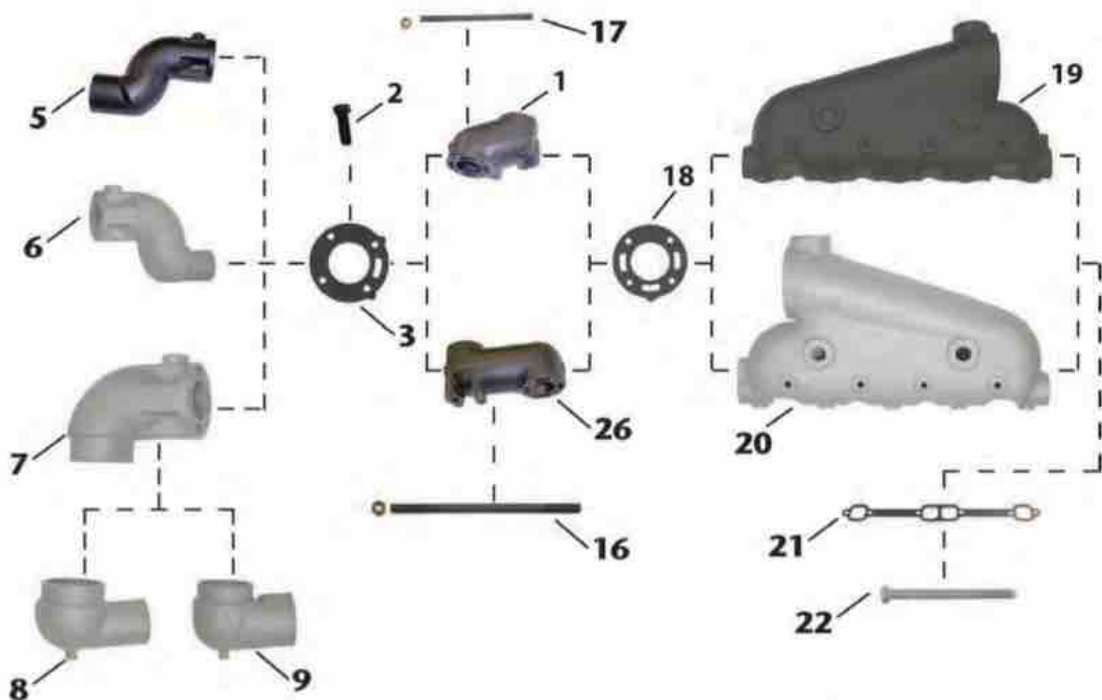

SEE NEXT PAGE FOR APPLICATION CHART

Item No.	Description	OE No.	Application	
1	18-1927	4" RISER	97772	Use with Manifold: 18-1925, 18-1926, 18-1933, & 18-1929; Elbow Gasket: 18-0309-1; Mounting Kit: 18-8523
2	NSS	MOUNTING BOLT	N/A	Included in 18-8515 mounting kit.
3	18-0309-1	ELBOW GASKET	96562	Use with Exhaust Elbow: 18-1927, or 18-1916. Included in 18-8515 mounting kit.
4	—	MOUNTING KIT	N/A	Use with Manifold: 18-1926 w/ alternator bracket
5	18-1928	ELBOW W/ 4" OUTLET	97924	Use with Manifold: 18-1925, 18-1926; Elbow Gasket: 18-0309-1; Mounting Kit: 18-8515
6	18-1934	ELBOW W/ 3" OUTLET	98068	Use with Manifold: 18-1925, 18-1926; Elbow Gasket: 18-0309-1; Mounting Kit: 18-8515
7	18-1918	ELBOW W/ 2 1/2" INLET	97386	Use with Manifold: 18-1925, 18-1926; Elbow Gasket: 18-0309-1; Mounting Kit: 18-8515
8	18-1919	RE-DIRECTION ELBOW W/ 3" OUTLET	97387	Use with Elbow: 18-1918
9	18-1924	RE-DIRECTION ELBOW W/ 4" OUTLET	97624	Use with Elbow: 18-1918
10	18-0602-1	EXHAUST MANIFOLD GASKET SET	N/A	For: "CH" Model Small Block (V8) Chevy 305 CID (5.0L) & 350 CID (5.7L)
11	NSS	WASHER & NUT KIT	N/A	Used in mounting kits: 18-8515, 18-8523, & 18-8519
12	18-8515	MOUNTING KIT	N/A	Use with Elbows: 18-1934, 18-1928, 18-1918
13	18-8523	MOUNTING KIT	N/A	Use with Riser: 18-1927
14	18-8519	MOUNTING KIT	N/A	Use with Riser: 18-1916
15	18-8521	MOUNTING KIT	N/A	Use with Manifold: 18-1925 & 18-1926
16	NSS	MOUNTING STUD	N/A	Included in 18-8519 mounting kit
17	NSS	MOUNTING STUD	N/A	Included in 18-8523 mounting kit
18	18-0305-1	ELBOW GASKET	96108	Use with Exhaust Manifolds: 18-1925 & 18-1926
19	18-1926	MANIFOLD (PORT)	97753, 96121	GM Small Block (V8) 305-351 cu.in. (Models: 220 & 270) (Port); Use with Manifold Gasket: 18-2949; Mounting Kit: 18-8521 (if manifold has alternator bracket)
20	18-1925	MANIFOLD (STARBOARD)	97752, 96120	GM Small Block (V8) 305-351 cu.in. (Models: 220 & 270) (Starboard); Use with Manifold Gasket: 18-2949; Mounting Kit: 18-8521
21	18-2949	MANIFOLD GASKET	96306	Use with Manifolds: 18-1925 & 18-1926
22	NSS	MOUNTING BOLT	N/A	Included in 18-8521 mounting kits
23	18-8112	HOSE FITTING	97296; 97854	90 degree fitting. Thread Size: 1" NPT X 1 1/4"
24	18-4461	HOSE FITTING	N/A	3/4" - 14NPT X 1" Hose (Corrosion Resistant Brass Fitting)
25	18-1917	BLOCK OFF PLATE (STAINLESS)	97296	Use with Elbow/Riser Gaskets: 18-0309-1, 18-0305-1
26	18-1916	8" RISER	97169	Use with Manifolds: 18-1925, 18-1926; Elbow Gasket: 18-0309-1;



SIERRA MANIFOLDS ARE PAINTED, PACKAGED & LEAK TESTED

**18-1997-1
MANIFOLD
Port & Starboard**

Replaces: Barr CHV-1-83

Universal Center Riser Manifold

FITS:

263 and 327 CID engines thru 1964; 305, 307 and 350 CID engines 1965 and later

Use with:

Exhaust Manifold Gasket Set: 18-0604

***For Exploded View - See Pages 656-657**



**18-1998-1
MANIFOLD
Port & Starboard**

Replaces: Barr FM-1-83

Universal Center Riser Manifold

FITS:

302 and 351 CID engines
Comes with 18-4363 Mounting Package

Use with:

Exhaust Manifold Gasket Set: 18-0603

***For Exploded View - See Pages 658-659**



**18-1999
ELBOW**

Replaces: Barr 20-0082

Comes with 18-4364 open

If blocked mounting kit is required use 18-8535

Use with:

Manifold: 18-1997-1 or 18-1998-1 or 18-1898

Riser Gasket: 18-2854-1 open



**18-1982
MANIFOLD
Port & Starboard**

Replaces: Crusader 98125

Use:

Exhaust Manifold Gasket: 18-0418

For: GM Big Block V-8 454-502 ci.



**18-1929
MANIFOLD
Starboard**

Replaces: Crusader 97992, 97114

Crusader GM Big Block V8 454cu.in.
(Models: CH350 and 454XL)

Use with:

Exhaust Manifold Gasket: 18-0418

Mounting Kit: 18-8524



**18-1933
MANIFOLD
Port**

Replaces: Crusader 97993, 97115

Crusader GM Big Block V8 454cu.in.
(Models: CH350 and 454XL)

Use with:

Exhaust Manifold Gasket: 18-0418

Mounting Kit: 18-8524



**18-1925
MANIFOLD
Starboard**

Replaces: Crusader 97752, 96120

Crusader GM Small Block V8 305-350cu.in.
(Models: 220 and 270)

Use with:

Exhaust Manifold Gasket: 18-2949

Mounting Kit: 18-8521



**18-1926
MANIFOLD
Port**

Replaces: Crusader 97753, 96121

Crusader GM Small Block V8 305-350cu.in.
(Models: 220 and 270)

Use with:

Exhaust Manifold Gasket: 18-2949

Mounting Kit: 18-8521 (if manifold has alternator bracket)



**18-1898
MANIFOLD
Port & Starboard**

Replaces: Barr CHVA-1-84

Marine Power 0991-110

Fits: 454 cu.in. GM big block V8 engines

Use with:

Exhaust Manifold Gasket: 18-0418

Riser Gasket: 18-2854-1 open or 18-0476-1 blocked



***For Exploded View - See Pages 654-655**



18-1991

ELBOW ADAPTER

Replaces: Barr 200089P

For: 3" I.D. Exhaust Hose

Use with:

Manifold Riser: 18-1999
30°



18-1992-1

ELBOW ADAPTER

Replaces: Barr 200087P

For: 3" I.D. Exhaust Hose

(As used in 18-1987 Exhaust Manifold Conversion Kit)
80°



18-1919

RE-DIRECTION ELBOW W/ 3" OUTLET

Replaces: Crusader 97387

Crusader GM Small Block V8 305-350-cu.in.

(Models: 220 and 270), GM Big Block V8 454cu.in.

(Models: CH350 and 454XL)

Use with:

Elbow: 18-1918



18-1924

RE-DIRECTION ELBOW W/ 4" OUTLET

Replaces: Crusader 97624

Crusader GM Small Block V8 305-350-cu.in.

(Models: 220 and 270), GM Big Block V8 454cu.in.

(Models: CH350 and 454XL)

Use with:

Elbow: 18-1918



18-1928

ELBOW W/ 4" OUTLET

Replaces: Crusader 97924

Crusader GM Small Block V8 305-350cu.in. (Models: 220 and 270), GM Big Block V8

454cu.in.(Models: CH350 and 454XL)

4" Hose

Use with:

Manifold: 18-1925, 18-1926, 18-1933, 18-1929

Elbow Gasket: 18-0309-1

Mounting Kit: 18-8515



18-1934

ELBOW W/ 3" OUTLET

Replaces: Crusader 98068

Crusader GM Small Block V8

305-350cu.in.(Models 220 and 270),

GM Big Block V8 454cu.in.(Models: CH350 and 454XL)

3" Hose

Use with:

Manifold: 18-1925, 18-1926, 18-1933, 18-1929

Elbow Gasket: 18-0309-1

Mounting Kit: 18-8515



18-1918

ELBOW

Replaces: Crusader 97386

Crusader GM Small Block

V8 305-350-cu.in.

(Models: 220 and 270), GM Big Block V8 454cu.in.

(Models: CH350 and 454XL)

2 1/2" Inlet

Use with:

Manifold: 18-1925, 18-1926, 18-1933, 18-1929

Elbow Gasket: 18-0309-1

Mounting Kit: 18-8515

Re-direction Elbow: 18-1919, 18-1924



18-1916

8" RISER

Replaces: Crusader 97169

Crusader Small Block

V8 305-350-cu.in.

(Models: 220 and 270),

GM Big Block V8 454cu.in.

(Models: CH350 and 454XL).

Use with:

Manifold: 18-1925, 18-1926, 18-1933, 18-1929

Riser Gasket: 18-0305-1

Mounting Kit: 18-8519



18-1927

4" RISER

Replaces: Crusader 97772

Crusader Small Block V8

305-350-cu.in.

(Models: 220 and 270),

GM Big Block V8 454cu.in.

(Models: CH350 and 454XL).

Use with:

Manifold: 18-1925, 18-1926, 18-1933, 18-1929

Riser Gasket: 18-0305-1

Mounting Kit: 18-8523



18-1938

RISER

Replaces: Crusader 98126, RO29015

Crusader GM Small Block V8 305-350cu.in.(Models:

CM305, CM350XL and CM350HT), GM Big Block

V8 454cu.in.(Models: 454XL and 502XL)

Use with:

Manifold: 18-1982, Crusader 98243

Riser Gasket: 18-0475-1

Mounting Kit: 18-8547



**18-1907
RISER (3")**

Replaces: Barr 20-0102
Barr and Indmar Ford Small Block V8 302-351cu.in.
Indmar 53-2009 and 53-2018

Use with:
Manifold: 18-1997-1, 18-1998-1
Riser Gasket: 18-2854-1 open or 18-0476-1 blocked
Mounting Kit: 18-4364 open or 18-8535 blocked



**18-1939
RISER (4")**

Replaces: Barr 20-0100, Marine Power 0992-593
Barr, Indmar and Marine Power Ford Small Block
V8 302-351cu.in., GM Small Block V8 305-350cu.in.,
GM Big Block V8 454cu.in.

Use with:
Manifold: 18-1997-1, 18-1998-1, 18-1898
Riser Gasket: 18-2854-1 open or 18-0476-1 blocked
Mounting Kit: 18-4364 open or 18-8535 blocked



**18-8112
HOSE FITTING (90°)**

Replaces: Crusader 97854
GM Small Block V8 305-350cu.in. (Models: 220,
270, CM305, CM350XL, CM350HT), GM Big Block
V8 454 cu.in. (Models: 454XL, 502XL, CH350, 454XL)

Thread size: 1" NPT x 1 1/4" hose barb
Use with:
Manifold: 18-1997-1, 18-1998-1, 18-1982, Crusader 98243,
18-1929, 18-1933, 18-1925, 18-1926, 18-1898

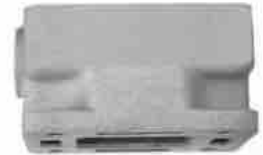

**18-1949
MANIFOLD SPACER (3")**

Barr CM 20-0097
Barr, Indmar and Marine Power Ford Small Block
V8 302-351cu.in., GM Small Block V8 305-350cu.in.,
GM Big Block V8 454cu.in.

Use with:
Manifolds: 18-1998-1, 18-1997-1 and 18-1898



**18-1984
MANIFOLD SPACER**

Replaces: 98128
For: GM Small Block V8 305-350 cu.in., GM Big Block V8



**18-4363
EXHAUST ELBOW MOUNTING KIT**

Replaces: Barr FM-1-83-P
Use with:
Manifold: 18-1998-1



**18-4364 (Open)
EXHAUST ELBOW MOUNTING KIT**

Replaces: Barr 20-0082-P
Use with:
Risers: 18-1999, 18-1907, 18-1939



**18-8515
EXHAUST MANIFOLD MOUNTING KIT**

Crusader GM Small Block V8 305-350cu.in. (Models: 220, 270), GM Big Block
V8 454cu.in. (Models: CH350, 454XL)
Used with:
Elbows: 18-1934, 18-1928, 18-1918



**18-8519
EXHAUST MOUNTING KIT**

Crusader GM Small Block V8 305-350cu.
in. (Models: 220, 270), GM Big Block V8
454cu.in.
(Models: CH350, 454XL)
Used with:
Riser: 18-1916



**18-8521
EXHAUST MANIFOLD MOUNTING KIT**

Crusader GM Small Block V8 305-350cu.in. (Models: 220, 270)
Used with:
Manifold: 18-1925 & 18-1926

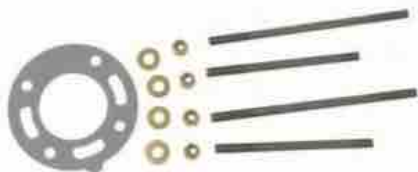

18-8523
EXHAUST ELBOW MOUNTING KIT
 Crusader GM Small Block V8 305-350cu.in. (Models: 220, 270), GM Big Block V8 454cu.in. (Models: CH350, 454XL)
Used with:
Riser: 18-1927



18-8524
EXHAUST MANIFOLD MOUNTING KIT
 Crusader GM Big Block V8 454cu.in. (Models: CH350 and 454XL)
Used with:
Manifolds: 18-1929 and 18-1933



18-8535
(CLOSED)
EXHAUST ELBOW MOUNTING KIT
 Barr, Indmar and Marine Power Ford Small Block V8 302-351cu.in., GM Small Block V8 305-350cu.in., GM Big Block V8 454cu.in.
Used with:
Risers: 18-1939, 18-1999, and 18-1907 Blocked



18-8536
EXHAUST ELBOW MOUNTING KIT
 Barr, Indmar and Marine Power GM Small Block V8 305-350cu.in.
Used with:
Manifold: 18-1997-1



18-8538
EXHAUST MANIFOLD MOUNTING KIT
 Barr and Indmar Ford Small Block V8 302-351cu.in.
Used with:
Manifold: 18-1996-1



18-8547
EXHAUST ELBOW MOUNTING KIT
 For: GM SB V8 305-350cu.in. GM BB V8 454 cu. in.
Used with:
Riser: 18-1938



PIPE PLUGS

Part #	Thread Size	Part #	Thread Size
18-4256	1/4"	18-4263	1/8" - 27 NPT
18-4257	1/4"	18-4264	3/8" - 18 NPT
18-4258	3/4"		



18-4461
HOSE BARB
 3/4" - 14 NPT x 1" Hose
 Corrosion Resistant Brass Fitting

①18-4218D



18-4218
DRAIN TAP
Used with:
 Most O.E.M. Manifolds
18-3223-9 Bulk Pack of 12
 1/4" Brass



18-0601
EXHAUST MANIFOLD GASKET SET
 For: "CH" Model Big Block V-8 Chevy. 454 CID (7.4L)
Use with:
Manifolds: 18-1929, 18-1933



18-0602-1
EXHAUST MANIFOLD GASKET SET
 For: "CH" Model Small Block V-8 Chevy 305 CID (5.0L) & 350 CID (5.7L)

① Items ending in "D" are Display Packaged - Regular number is Non-Display

 <p>18-0603 EXHAUST MANIFOLD GASKET SET For: Ford 302/351 CID Engines Use with: Manifold: 18-1998-1</p>	 <p>18-0604 EXHAUST MANIFOLD GASKET SET For: GM 305/350 CID Engines Use with: Manifold: 18-1997-1</p>	
 <p>18-0183-1 EXHAUST MANIFOLD GASKET Used with: Manifold: 18-1998-1</p>	 <p>18-0305-1 EXHAUST ELBOW GASKET Replaces: 96108 Use with: Exhaust Manifold: 18-1929</p>	 <p>18-0309-1 EXHAUST ELBOW GASKET Replaces: 96562 Use with: Exhaust Elbow: 18-1928 V-6/V-8</p>
 <p>18-0418 EXHAUST MANIFOLD GASKET Replaces: 96653 Used with: Manifold: 18-1957-2, 18-1982, 18-1929, 18-1933, 18-1896</p>	 <p>18-0475-1 EXHAUST ELBOW GASKET Used with: Riser: 18-1938 Manifold: Crusader 98243</p>	 <p>18-0476-1 BLOCK OFF GASKET Barr, Indmar & MarinePower Ford Small Block V8 302-351cu.in. Used with: Risers: 18-1939, 18-1999 and 18-1907 Blocked</p>
 <p>18-1917 MANIFOLD BLOCK OFF PLATE (STAINLESS) Replaces: 97296 Crusader Small Block V8 305-350 cu.in. (Models: 220 and 270), GM Big Block V8 454cu.in. (Models: CH350 and 454XL) Use with: Elbow/Riser Gasket: 18-0309-1, 18-0305-1</p>	<p>PKG. OF 2</p>  <p>18-2854-1 (Open) 18-2854-9 ⓘ EXHAUST RISER GASKET Replaces: Barr 01-0107 Used with: Riser: 18-1999, 18-1907, 18-1939</p>	<p>PKG. OF 2</p>  <p>18-2909 18-2909-9 ⓘ EXHAUST MANIFOLD GASKET Replaces: 97498 For: GM V-6 Used with: Manifold: 18-1952-1, 18-1932</p>
<p>PKG. OF 2</p>  <p>18-2949 18-2949-9 ⓘ EXHAUST MANIFOLD GASKET Replaces: 96306 Barr CHV-47-000 Use with: 18-1997-1</p>	 <p>18-4408 INTAKE MANIFOLD GASKET SET Replaces: 33393 For: 222 CID</p>	 <p>18-0306-1 ELBOW AND CUP GASKET Replaces: 96216 V-6/V-8</p>

ⓘ Priced per Package



OIL FILTERS

Part #	Replaces:	
18-7824-2 (Short)	201104	GM Engines + SS330 Remote Mount
18-7875 (Long)	9002514	Ford Engines
18-7876-1 (Long)	201104	GM Engines + SS330 Remote Mount
18-7878-1 (Short)	—	220, 300, 320, 325 Remote Mount

SEE PAGES 200-202 & 1165-1190 FOR ADDITIONAL INFORMATION



18-0311
262 CID
VALVE COVER GASKET
Replaces: 97686



PKG. OF 2

18-0875
18-0875-9 ⓘ
THERMOSTAT GASKET



PKG. OF 2

18-0976
18-0976-9 ⓘ
TIMING CHAIN COVER GASKET
Replaces: 20129



18-2845
VALVE COVER GASKET
Replaces: 91351
V-8



18-3874
HEAD GASKET
Replaces: 31137
For: (8.2L) 502 CID/7.4L



18-3876
HEAD GASKET
Replaces: 7057500
For: GM 305 (5.0L)/350 (5.7L) CID Eng.



18-3877
HEAD GASKET
Replaces: 30266
For: GM 454 (7.4L) CID Eng.



18-3879
HEAD GASKET
Replaces: 33408



18-3887
HEAD GASKET
Replaces: 31136
For: (7.4L) 454 CID GEN V

 <p>18-5303 CONTACT SET Replaces: 751007</p>	 <p>18-5345 CONDENSER Replaces: 755017</p>	 <p>18-5407 ROTOR</p>
--	---	--

PARTS FOR CONTACT CONTROLLED DISTRIBUTORS

Year	Cyl.	Model / Engine	Distributor	Contact Set	Condenser	Rotor
1979	8	All	IBM-7010	—	18-5345	18-5407
			IBM-7011	18-5303	18-5345	18-5407

 <p>18-5268 TUNE-UP KIT</p>	 <p>18-5271 TUNE-UP KIT</p>	 <p>18-5275 TUNE-UP KIT</p>
--	--	--

 <p>18-5276 TUNE-UP KIT</p>	 <p>18-5277 TUNE-UP KIT Replaces: 755021</p>	 <p>18-5278 TUNE-UP KIT</p>
---	--	---

 <p>18-5279 TUNE-UP KIT</p>	 <p>18-5280 TUNE-UP KIT</p>	 <p>18-5281 TUNE-UP KIT</p>	 <p>18-5283 TUNE-UP KIT</p>
--	--	---	--

PARTS FOR IGNITION - TUNE-UP KITS

Cyl.	Ignition System	Tune-Up Kit	Cyl.	Ignition System	Tune-Up Kit
In-Line 4	Delco Single Point	18-5268	In-Line 4	Delco EST	18-5280
V-8	Mallory Single Point	18-5271	V-6	Delco EST	18-5278
V-8	Prestolite Single Point - Screw Down Cap	18-5275	V-8	Delco EST	18-5281
V-6	Prestolite Single Point - Screw Down Cap	18-5276	In-Line 4	Mallory Single Point	18-5283
V-8	Prestolite Single Point - Clip Down Cap	18-5277	V-8	Prestolite Electronic	18-5279

PREMIUM MARINE IGNITION WIRES

Sierra's MAGFORCE Ignition Wires are "Electronics Friendly" protecting all of your electronic devices and electronic engine controls from RFI and EMI while delivering the maximum amount of voltage. Exact fit design ensures easy installation and years of trouble - free service.



INDMAR MARINE IGNITION WIRES APPLICATION

Engine	Cyl.	Distributor	Year Start	Year Stop	Plug Wire Set
140	8	Prestolite	Up to	1993	18-8803-2
200	8	Prestolite	Up to	1993	18-8803-2
225	8	Prestolite	Up to	1993	18-8803-2
250	8	Prestolite	Up to	1993	18-8803-2
275	8	Prestolite/Mallory	Up to	1993	18-8803-2
300	8	Prestolite/Mallory	Up to	1993	18-8803-2
350	8	Prestolite/Mallory	Up to	1993	18-8803-2
400	8	Prestolite/Mallory	Up to	1993	18-8803-2
5.7L EFI	8	Delco EST	1994	2009	18-8836-1
5.7L EFI	8	Delco HVS	2007	& Up	18-8828-1
6.0L EFI	8	Distributorless	2003	& Up	18-8838-1
6.2L EFI	8	Distributorless	2010	& Up	18-8838-1
454 Carbureted (7.4L)	8	Delco EST	1994	2011	18-8824-1
8.1L Vortec	8	Distributorless	2003	2011	18-8838-1
502 Carbureted (8.2L)	8	Delco EST	1994	2011	18-8824-1



18-5480
COMPLETE IGNITION CONVERSION KIT
 Fits: GM SB & BB with Standard Deck Height

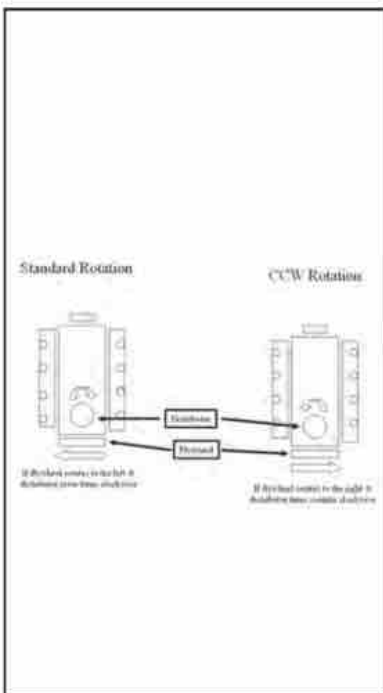

COIL AND RESISTOR

Year	Model or Engine	Service Coil	Resistor
1979	12 Volt w/ 2-Prong Resistor	18-5433	18-5450

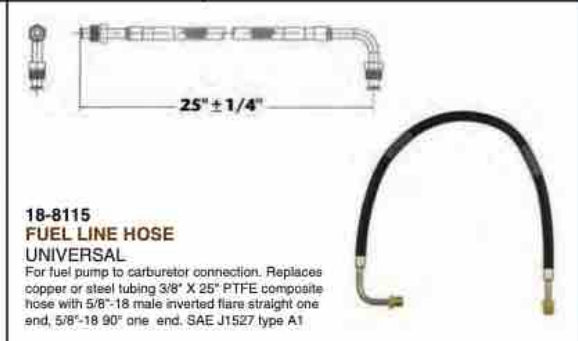

FUEL WATER SEPARATORS



Sierra offers a complete line of 10 and 21 micron fuel water separating filters including drainable bowl filters to protect your carbureted and fuel injected engine.

Refer to pages 153-158 for a complete listing of OEM and universal applications.

Sierra fuel water separators remove over 99.8% of emulsified water from your gasoline. Sierra's 10 micron filters are over 90% efficient at removing particles as small as 10 micron. All filters flow @ 90 GPH to feed even the hungriest motor. Sierra 10 micron filters are recommended to prevent damage to sensitive inboard and outboard fuel injection systems.

			
<p>18-8215 HOSE BARB Fits: Chrysler V8</p>	<p>18-3304 IMPELLER Replaces: Johnson Pump 09-802-B Dia 3 3/4" Side Width 3 1/2" Neoprene</p>	<p>18-3586-1 WATER PUMP Replaces: Indmar 685011 Use Impeller Repair Kit: 18-3061</p>	<p>18-3587-1 WATER PUMP Replaces: Indmar 685001 Use Impeller Repair Kit: 18-3089</p>
			
<p>18-42608 WATER CIRCULATING PUMP Replaces: Indmar S556050 Fits: Indmar/PCM 6.0L</p>	<p>18-43017 THERMOSTAT Replaces: Indmar S985009 Fits: Mercruiser 496 Mag & HO, 8.1L MIE & HO</p>	<p>18-0603 EXHAUST MANIFOLD GASKET SET</p>	<p>18-0604 EXHAUST MANIFOLD GASKET SET</p>
<p>PKG. OF 2</p> <div style="text-align: center;">  </div> <p>18-0665 18-0665-9^① THERMOSTAT GASKET Replaces: 98-5006</p>			<p>18-8779 OIL FILTER Replaces: Indmar 872025 Fits: 6.2L Ford Engines 2015-2016</p>
<p>18-0665 18-0665-9^① THERMOSTAT GASKET Replaces: 98-5006</p>	<p>18-0476-1 RISER BLOCKOFF GASKET Replaces: Barr 1-0105</p>	<p>18-8779 OIL FILTER Replaces: Indmar 872025 Fits: 6.2L Ford Engines 2015-2016</p>	

MISCELLANEOUS GASKETS

Model or Engine	Gasket Set	Type	O.E. #	Gasket
Ford 302/350 CID Engines	18-0603	Thermostat	98-5006	18-0665
GM 305/350 CID Engines	18-0604	Block Off (For: Small block GM & Ford V-8 (Use with 18-1999 Manifold)	Barr 1-0105	18-0476-1

① Priced per Package

PREMIUM MARINE IGNITION WIRES

Sierra's MAGFORCE Ignition Wires are "Electronics Friendly" protecting all of your electronic devices and electronic engine controls from RFI and EMI while delivering the maximum amount of voltage. Exact fit design ensures easy installation and years of trouble - free service.



MARINE POWER IGNITION WIRES APPLICATION

Engine	Cyl.	Distributor	Year Start	Year Stop	Plug Wire Set
181	4	Delco	1986	1992	18-8800-1
262	6	Prestolite Ⓢ	1986	1992	18-8801-1
350	6	Prestolite Ⓢ	1986	1992	18-8802-1
350	8	Mallory	1986	1992	18-8802-1
3.0L	4	Delco EST	1993	& Up	18-8833-1
4.3L	6	Delco EST	1993	& Up	18-8835-1
4.3L	6	Delco HVS	2005	& Up	18-8829-1
5.0L	8	Delco EST	1993	2005	18-8822-1
5.0L	8	Delco HVS	2005	& Up	18-8828-1
5.7L	8	Delco EST	1993	2005	18-8822-1
5.7L	8	Delco HVS	2005	& Up	18-8828-1
7.4L	8	Delco EST	1993	2000	18-8832-1
8.2L	8	Delco EST	1993	2000	18-8832-1

Ⓢ Screw down cap



Standard Rotation

CCW Rotation

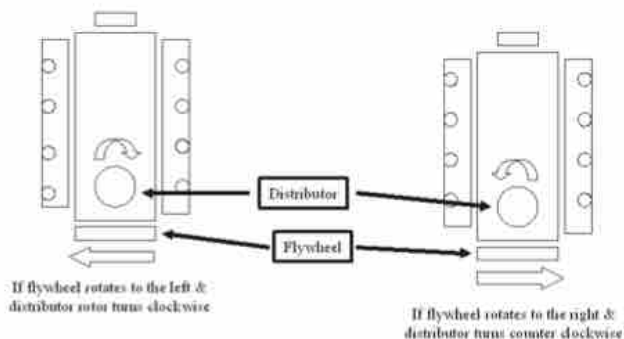

18-6299
ALTERNATOR
Replaces: 402001
75I/70 amp, Spool Mount, Larger 2 Groove Pulley



18-5603-1
STARTER
Replaces: 0170-000
Noiseless CCW Top mount rear entry starter for standard rotation GM & Ford engines. Can be used in place of 18-5908



18-0476-1
RISER BLOCK-OFF GASKET
Replaces: Barr 1-0105

PKG. OF 2



18-2909
18-2909-9^①
EXHAUST MANIFOLD GASKET
For: GM V-6



18-8535
EXHAUST ELBOW MOUNTING KIT



18-8536
EXHAUST ELBOW MOUNTING KIT



18-4364 (Open)
EXHAUST ELBOW MOUNTING KIT
Replaces: Barr 20-0082-P
Use with:
Risers: 18-1999, 18-1907, 18-1939

EXHAUST MANIFOLD HARDWARE MOUNTING KITS

EXHAUST ELBOW HARDWARE MOUNTING KITS

Exhaust Manifold	Elbow O.E. No.	Gasket Set
18-1997-1	Barr CHV-1-83 Indmar 53-1027 Marine Power 0994-000	18-8536

Exhaust Elbow	Elbow O.E. No.	Closed Cooling Kit	Raw Water Cooling Kit
18-1999	Barr 20-0082	18-8535	18-4364
18-1939	Barr 20-0100	18-8535	18-4364

① Priced per Package

PLEASURECRAFT MODEL IDENTIFICATION

MODEL 02-600V-01 SERIAL 460000

1st - 2nd Space: **MANUFACTURING CODE**

3rd - 5th Space: **ENGINE CODE**

810 = 8.1L	(496 CID MPI)	(GM)
811 = 8.1L	(496 CID H.O. MPI)	(GM)
600 = 6.0L	(364 CID MPI)	(GM)
570 = 5.7L	(350 CID LH MPI)	(GM)
571 = 5.7L	(350 CID RH MPI)	(GM)
572 = 5.7L	(350 CID LH Carburetor)	(GM)
573 = 5.7L	(350 CID RH Carburetor)	(GM)
500 = 5.0L	(305 CID LH MPI)	(GM)
501 = 5.0L	(305 CID RH MPI)	(GM)
502 = 5.0L	(305 CID LH Carburetor)	(GM)
503 = 5.0L	(305 CID RH Carburetor)	(GM)

SERIAL NUMBER I.D.

1st DIGIT INDICATES DECADE ENGINE WAS MANUFACTURED (3 = 1990, 4 = 2000, 5 = 2010)
2nd DIGIT INDICATES YEAR ENGINE WAS MANUFACTURED.

6th Space: **DRIVE CONFIGURATION**

blank - Direct Drive
V - V-Drive

7th - 8th Space: **SPECIFICATION CODE**

18-5251 TUNE-UP KIT

Part #
18-5314
18-5338
18-5404



①18-5251D



-CONTAINS-

O.E. #
R114001, R114004
R115001
R103001

Description
Contact Set
Condenser
Rotor

Mallory 8 cyl. Tall Cap

18-5255 TUNE-UP KIT

Part #
18-5303
18-5345
18-5407



-CONTAINS-

O.E. #
R114002
R115002
R103003

Description
Contact Set
Condenser
Rotor

18-5260 TUNE-UP KIT

Part #
18-5303
18-5345
18-5403



①18-5260D



-CONTAINS-

O.E. #
R114002
R115002
R103004

Description
Contact Set
Condenser
Rotor

18-5266 TUNE-UP KIT

Fits: Flame Thrower Distributors 18-5481, 18-5482, 18-5483, 18-5477, 18-5478, 18-5479



18-5271 TUNE-UP KIT

Part #
18-5314
18-5338
18-5404-1
18-5376



-CONTAINS-

O.E. #
R114001, R114004
R115001
R103001
R109001

Description
Contact Set
Condenser
Rotor
Distributor Cap

Mallory V-8 Tall Cap

18-5275 TUNE-UP KIT

Part #
18-5303
18-5347
18-5403
18-5352



-CONTAINS-

O.E. #
R114002
—
R103004
RA108003

Description
Contact Set
Condenser
Rotor
Distributor Cap

Prestolite V-8 Screw Down Cap

APPLICATION ON PAGE 642

① Items ending in "D" are Display Packaged - Regular number is Non-Display



Display Package

**18-5276
TUNE-UP KIT**
-CONTAINS-
Part # O.E. # Description
18-5303 R114002 Contact Set
18-5347 — Condenser
18-5403 R103004 Rotor
18-5353 — Distributor Cap
Prestolite V-6 Screw Down Cap



Display Package

**18-5277
TUNE-UP KIT**
-CONTAINS-
Part # O.E. # Description
18-5303 R114002 Contact Set
18-5347 — Condenser
18-5407 R103003 Rotor
18-5369 RA109002 Distributor Cap
Prestolite V-8 Clip Down Cap



**18-5301
TUNE-UP KIT**
Fits: Male cap v-8 flamethrower distributors



**18-5302
TUNE-UP KIT**
Fits: Male cap v-8 flamethrower distributors



**18-5278
TUNE-UP KIT**
Delco EST · V-6



**18-5281
TUNE-UP KIT**
Delco EST · V-8



**18-5303
CONTACT SET**
Replaces: R114002



**18-5314
CONTACT SET**
Replaces: R114001,
R114004



**18-5317
CONTACT SET**



**18-5338
CONDENSER**
Replaces: R115001



**18-5345
CONDENSER**
Replaces: R115002



**18-5346
CONDENSER**



**18-5347
CONDENSER**



**18-29322
CAP & ROTOR KIT**
Fits: Ford HEI Distributors



**18-5245
ROTOR**
Replaces: R103011
For: Models MP 5.0L and 5.7L
(2002-05)



**18-5403
ROTOR**
Replaces: R103004



**18-5404-1
ROTOR**
Replaces: R103001



**18-5407
ROTOR**
Replaces: R103003



**18-5300
ROTOR**
Fits: Flamethrower Distributors



**18-5474
DISTRIBUTOR CAP**
Red Distributor Cap with Male
Terminals for Flamethrower
Distributors

 <p>18-5473 DISTRIBUTOR CAP Black Distributor Cap with Male Terminals for Flamethrower Distributors</p>	 <p>18-5244 DISTRIBUTOR CAP Replaces: RA108009 For: Models MP 5.0L and 5.7L (2002-05)</p>	 <p>18-5352 DISTRIBUTOR CAP Replaces: RA108003</p>	 <p>18-5353 DISTRIBUTOR CAP</p>
 <p>18-5359 DISTRIBUTOR CAP</p>	 <p>18-5369 DISTRIBUTOR CAP Replaces: RA108002 Includes: 18-5399 Gasket</p>	 <p>18-5376 DISTRIBUTOR CAP Replaces: R108001</p>	 <p>18-5389 DISTRIBUTOR CAP</p>



FEATURES

- Senses current levels in the coil and adjusts the dwell to maintain peak energy throughout the entire RPM range.
- Develops, on average, 4 times more available energy between 3000 and 5000 RPM's and twice as much plug voltage as point-type systems.
- Ignition energy is sustained and coil life is increased when peak current level is reached just prior to spark.
- More stable timing.
- Use with 18-5472 "Flame Thrower II" Coil for optimum performance

 <p>18-5288 HI-PERFORMANCE ELECTRONIC CONVERSION KIT Fits: Most Prestolite V-8 Distributors with snap down cap</p>	 <p>18-5289 HI-PERFORMANCE ELECTRONIC CONVERSION KIT Fits: Most Prestolite V-8 Distributors with screw down cap</p>	 <p>18-5290 HI-PERFORMANCE ELECTRONIC CONVERSION KIT Fits: Most Mallory YL or YD 8 cylinder Distributors with clockwise and counter clockwise rotation</p>
--	---	--



FEATURES

- Replaces points & condensers for true solid state ignition.
- Uses standard coil, cap and rotor.
- Easy to install, one-piece, 2-wire hook-up.
- Accurate to within 1/4" timing accuracy 0 to 6000 RPM range.
- Can be used with Flame Thrower Coils 18-5466 & 18-5469.

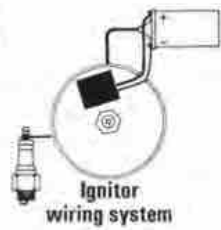

 <p>18-5294 ELECTRONIC CONVERSION KIT Fits: 6 Cyl. Delco distributors</p>	 <p>18-5295 ELECTRONIC CONVERSION KIT Fits: Most 4 Cyl. Prestolite distributors (Except IBM 7026) For: Onan, Universal, Waukesha, Wisconsin</p>	 <p>18-5296-2 ELECTRONIC CONVERSION KIT Fits: Most Mallory V-8 YL & YD 8 cyl. Distributors with clockwise and counter clockwise rotation</p> <p style="text-align: right;">① 18-5296-2D Display Package</p>
--	--	--

APPLICATION ON PAGE 642

① Items ending in "D" are Display Packaged - Regular number is Non-Display



18-5298
ELECTRONIC
CONVERSION KIT
 (with snap down cap)
 For: Most Prestolite V-8 Distributors

① 18-5299D



18-5299
ELECTRONIC CONVERSION KIT
 (with screw down cap)
 For: Most Prestolite V-8 Distributors
 Use with 18-5403 Style Rotor



Standard Rotation

CCW Rotation

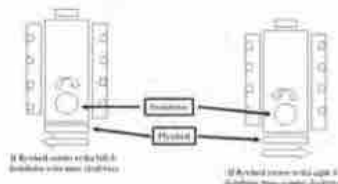

18-5309-1
DISTRIBUTOR
 Replaces: RA107001
 Mallory YL512CV
 For most Ford 302 CID V-8 Eng.
 Uses: 18-5251 TUNE-UP KIT

Part #	Desc.
18-5314	Contact Set
18-5338	Condenser
18-5404-1	Rotor
18-5376	Cap



18-5312-1
DISTRIBUTOR
 Replaces: Mallory YL554CV
 For most Ford 351 CID V-8 Eng.
 Uses: 18-5251 TUNE-UP KIT

Part #	Desc.
18-5314	Contact Set
18-5338	Condenser
18-5404-1	Rotor
18-5376	Cap



18-5313-1
DISTRIBUTOR
 Replaces: Mallory YL624MW
 For most GM V-8 Engs.
 (small & large blocks)
 Uses: 18-5251 TUNE-UP KIT

Part #	Desc.
18-5314	Contact Set
18-5338	Condenser
18-5404-1	Rotor
18-5376	Cap



FEATURES

- Distributors feature the Ignitor II ignition module with adaptive dwell control adjusts the spark timing over the entire RPM range to maximize performance
- Upper roller bearing and oil impregnated bronze sintered bottom bushing are installed and aligned bored for accuracy for maximum durability
- Machined heat treated gear with tight tolerances insures durability and consistent timing to maximize horsepower and performance. Complete with high dielectric strength cap and rotor for years of performance



18-5481
HI-PERFORMANCE
ELECTRONIC DISTRIBUTOR
 Fits: Ford V-8 351 Windsor
 Replacement cap/rotor kit 18-5266



18-5482
HI-PERFORMANCE
ELECTRONIC DISTRIBUTOR
 Fits: Ford V-8 351 Cleveland, 351M, 400, 429 & 460 engines
 Replacement cap/rotor kit 18-5266



18-5483
HI-PERFORMANCE
ELECTRONIC DISTRIBUTOR
 Fits: Chevrolet Marine Small and Big Block engines
 (Standard Deck Height)
 Replacement cap/rotor kit 18-5266



18-5477
ELECTRONIC DISTRIBUTOR
 Ford 302 V-8 engines
 Replacement Cap/Rotor Kit 18-5266



18-5478
ELECTRONIC DISTRIBUTOR
 Chrysler LA series V-8 engines
 Replacement Cap/Rotor Kit 18-5266



18-5479
ELECTRONIC DISTRIBUTOR
 GM V-8 engines-reverse rotation
 Replacement Cap/Rotor Kit 18-5266

APPLICATION ON PAGE 642

① Items ending in "D" are Display Packaged - Regular number is Non-Display



**18-5480
COMPLETE IGNITION
CONVERSION KIT**
Fits: GM SB & BB with Standard Deck Height

—CONTAINS—

Part #	Description
18-5472	Coil
18-8803-2	Wire Set
18-5483	Distributor

**18-5484-1
ELECTRONIC DISTRIBUTOR
Conventional Rotation**
Replaces: RA107039E
Late Model HEI
For V8 — 262-454 & 502 except 384/409 and tall block engines
• Designed as a plug-in replacement for GM-style fuel injection system distributors



—CONTAINS—

Description	Part #
Distributor Cap	18-5354
Rotor	18-5405
Tune-Up Kit	18-5281

**18-5489-2
ELECTRONIC DISTRIBUTOR
Conventional Rotation**
For Ford V-8 351W CID



—CONTAINS—

Part #	Description	Part #	Description
18-5376	Distributor Cap	18-5404-1	Rotor
18-5488	Module		

**18-5494-2
ELECTRONIC DISTRIBUTOR
Conventional Rotation**
For Chevrolet all V8 includes 482, 502, 540 CID (Except 348, 409 & Tall Deck Big Block)



—CONTAINS—

Part #	Description	Part #	Description
18-5376	Distributor Cap	18-5404-1	Rotor
18-5488	Module		

**18-5495-2
ELECTRONIC DISTRIBUTOR**
Replaces: Mallory YLM512CV
Conventional Rotation
For Ford V-8 302 CID



—CONTAINS—

Part #	Description	Part #	Description
18-5376	Distributor Cap	18-5404-1	Rotor
18-5488	Module		

**18-5496-2
ELECTRONIC DISTRIBUTOR
Conventional Rotation**
For Ford V-8 351C — 460 CID



—CONTAINS—

Part #	Description	Part #	Description
18-5376	Distributor Cap	18-5404-1	Rotor
18-5488	Module		

PREMIUM MARINE IGNITION WIRES

Sierra's MAGFORCE Ignition Wires are "Electronics Friendly" protecting all of your electronic devices and electronic engine controls from RFI and EMI while delivering the maximum amount of voltage. Exact fit design ensures easy installation and years of trouble-free service.



Engine	Cyl.	Distributor	Years	Plug Wire Set
262 CID 4.3L	6	Prestolite	ALL	18-8801-1
262 CID 4.3L	6	Delco EST	ALL	18-8810-1
262 CID 4.3L	6	Delco HVS	ALL	18-8829-1
220 (305 CID 5.0L)	8	Mallory/Prestolite	Up to 1987	18-8803-2

Engine	Cyl.	Distributor	Years	Plug Wire Set
220 (305 CID 5.0L)	8	Mallory/Prestolite	1987-1992	18-8803-2
270 (350 CID 5.7L)	8	Mallory/Prestolite	Up to 1987	18-8803-2
270 (350 CID 5.7L)	8	Mallory/Prestolite	1987-1992	18-8803-2
TB350	8	Delco EST	1992 & Up	18-8824-1
5.7L Classic	8	Mallory	1999 & Up	18-8803-2
5.7L MPI Classic	8	Delco HVS	2007 & Up	18-8828-1
MP5.0L Captain's Choice	8	Delco HVS	2002-2005	18-8828-1
MP5.7L Captain's Choice	8	Delco HVS	2002-2005	18-8828-1
MP6.0L	8	Distributorless	2002 & Up	18-8838-1
350 (454 CID 7.4L)	8	Mallory	Up to 1991	18-8803-2
454XL (454 CID 7.4L)	8	Delco EST	1991 & Up	18-8824-1
CM454HO (454 CID 7.4L)	8	Delco EST	1991 & Up	18-8824-1
454XL (454 CID 7.4L)	8	Delco EST	1993 & Up	18-8824-1
MP8.1L	8	Distributorless	ALL	18-8838-1
502 (502 CID 8.2L)	8	Prestolite	Up to 1991	18-8803-2
502 (502 CID 8.2L)	8	Delco EST	Up to 1991	18-8824-1
502XL (502 CID 8.2L)	8	Delco EST	1991 & Up	18-8824-1
TB502XL (502 CID 8.2L)	8	Delco EST	1994 & Up	18-8824-1

● Serial Number up to 68702 ● Serial Number 68703-90232 ● Serial Number 90232 & UP
 ● Serial Number up to 88710 ● Serial Number 88710 & Up ● Serial Number 92882 & UP
 ● Serial Number 94268 & Up



**18-5225
SPARK PLUG WIRE KIT**

Replaces: Mercury 84-99215A26, 84-813706A26
Kit includes 25 ft. Roll of 7 MM Hypalon Ignition Wire With a Metallic Core and a Large Assortment of Three Different End Fittings.

**18-5226
IGNITION WIRE
Metallic Core**

100' Spool • 7mm Hypalon



PKG. OF 10



**18-5224
18-5224-9®
SPARK PLUG WIRE
TERMINAL**

Replaces: Mercury 20121
OMC 510364



BATTERY CABLES

Gauge cable with soldered lug terminals on each end to accept 3/8" stud.

PART NO.	SIZE	COLOR	GAUGE	PART NO.	SIZE	COLOR	GAUGE
BC88523	2'	red	4	BC88563	6'	red	2
BC88533	2'	black	4	BC88573	6'	black	2
BC88543	4'	red	2	BC88583	8'	red	1
BC88553	4'	black	2	BC88593	8'	black	1

PKG. OF 10



**18-5750
18-5750-9®
UNIVERSAL SPARK
PLUG BOOTS**

Supplied complete w/Terminal Connector
Replaces: OMC 581027, 580339



**18-5752
UNIVERSAL
SPARK PLUG BOOT**
8mm

IGNITION / ELECTRICAL SYSTEMS APPLICATION

Years	Cyl.	Model/Engine	Distributor No.	Contact Set	Condenser	Dist. Cap	Rotor	Tune-Up Kit	Coil	Distributor	Elect. Conv. Kit
1959-72	4	1C	IGW-4118A	—	18-5345	18-5369	—	—	18-5435	—	—
1959-73	4	1C	IGW-4301	—	18-5345	—	—	—	18-5435	—	—
1984-88	6	3.6L Eng.	IBM-7014A	18-5303	18-5345 ④	18-5353	18-5403	18-5260, 18-5276 ⑥	18-5433 ⑦ ⑧	—	—
1973-74	8	Mercury Dist.	B64025A2	18-5317	18-5346 ④	18-5369	—	—	18-5433 ⑦	—	—
1976-82	8	305,350, 454 Eng.	IBM-7011	18-5303	18-5345 ④	18-5352	18-5403	18-5260, 18-5275 ⑥	18-5433 ⑦ ⑧	18-5494-2 ① 18-5498-1 ② 18-5313-1 ③	18-5299
1983-88	8	305, 350, 454 Eng.	IBM-7013	18-5303	18-5345 ④	18-5352	18-5403	18-5260, 18-5275 ⑥	18-5433 ⑦ ⑧	18-5494-2 ① 18-5498-1 ② 18-5313-1 ③	18-5299
1975-86	8	Ford 302 Eng.	IBM-7007, A	18-5303	18-5345 ④	18-5369	18-5407	18-5255, 18-5277 ⑥	18-5433 ⑦ ⑧	18-5495-2 ① 18-5309-1 ②	18-5298
1975-86	8	Ford 351, 460 Eng.	IBM-7008, A, B, C	18-5303	18-5345 ④	18-5369	18-5407	18-5255, 18-5277 ⑥	18-5433 ⑦ ⑧	18-5496-2 ① 18-5312-1 ③	18-5298
1986-UP	8	Ford 302 Eng.	Prestolite	N/A	N/A	18-5352	18-5403	N/A	18-5433 ⑦ ⑧	18-5495-2 ① 18-5309-1 ②	18-5299
1987	8	—	Prestolite	18-5303	18-5345 ④	18-5352	18-5403	18-5260, 18-5275 ⑥	18-5433 ⑦ ⑧	—	—
ALL	8	—	Mallory	18-5314	18-5338	18-5376	18-5404-1	18-5251, 18-5271 ⑥	18-5433 ⑦ ⑧	—	18-5296-2

① Electronic Distributor (Standard Rotation)

② Electronic Distributor (Counter Rotation)

③ Contact Controlled Distributor (Standard Rotation)

④ For strap type, use 18-5347

⑤ For applications requiring internal resistor use 18-5436

⑥ For applications requiring internal resistor use 18-5435

⑦ Use 18-5450 coil resistor

⑧ With distributor cap

FEATURES

- Oil filled for better cooling and long life
- Low resistance and improved turn ratios produces the higher voltage needed to run larger spark plug gaps for added power and better fuel economy
- More windings maximize energy and reliability over the full RPM range
- Fits existing brackets for easy installation

**18-5466
HI-PERFORMANCE
IGNITION COIL**

1.5 ohm (oil filled), black - 8 cylinder.
Flame-Thrower 40,000 volt coil.

- Designed for use with the original Ignitor Electronic Conversion Kits
- Can be used with other inductive ignition systems



**18-5469
HI-PERFORMANCE
IGNITION COIL**

3.0 ohm (oil filled), black - 4 & 6 cylinder.
Flame-Thrower 40,000 volt coil.

- Designed for use with the original Ignitor Electronic Conversion Kits
- Can be used with other inductive ignition systems



**18-5472
HI-PERFORMANCE
IGNITION COIL**

0.6 ohm (oil filled), black - 4, 6, & 8 cylinder.
Flame-Thrower 45,000 volt coil.

- Super low 0.6 ohm resistance coil designed for use with the Ignitor II Hi Performance Electronic Conversion Kits
- Compatible with capacitive discharge systems



Part #	Description	Recommended Resistance		Part #	Description	Recommended Resistance	
		Coil	Ohms			Coil	Ohms
18-5294	Electronic Conversion Kit	18-5469	3.0	18-5288	Hi Performance Electronic Conversion Kit	18-5472	0.6
18-5295	Electronic Conversion Kit	18-5469	3.0	18-5289	Hi Performance Electronic Conversion Kit	18-5472	0.6
18-5296-2	Electronic Conversion Kit	18-5466	1.5	18-5290	Hi Performance Electronic Conversion Kit	18-5472	0.6
18-5298	Electronic Conversion Kit	18-5466	1.5	18-5483	Flame-Thrower Distributor	18-5472	0.6
18-5299	Electronic Conversion Kit	18-5466	1.5	18-5483	Flame-Thrower Distributor	18-5472	0.6
				18-5483	Flame-Thrower Distributor	18-5472	0.6

⑨ Priced per Package

 <p>18-7648 IGNITION COIL Replaces: R117012</p>	 <p>18-5433 IGNITION COIL Replaces: R117001 Uses External Resistor</p>	 <p>18-5435 IGNITION COIL 4.0 OHM Has Internal Resistor</p>	 <p>18-5436 IGNITION COIL 3.0 OHM Has Internal Resistor</p>	 <p>18-5450 COIL RESISTOR 1.5 OHM Replaces: R119001</p>
--	---	--	---	--



 <p>18-9802 TIMING LIGHT Self-powered accurate up to 10,000 RPM's</p>	 <p>18-26810 GM HEI 4 TERMINAL PIGTAIL Fits: GM HEI Distributors w/4 terminals</p>	 <p>18-26811 GM HEI 2 TERMINAL PIGTAIL Fits: GM HEI Distributors w/2 terminals</p>	 <p>18-26812 HEI COIL GRAY CONNECTOR</p>	 <p>18-26813 HEI COIL BLACK CONNECTOR</p>
--	---	---	--	--



18-5603
STARTER
Replaces: RA122009
Noseless:CCW Top mount rear entry starter for standard rotation GM & Ford engines. Can be used in place of 18-5908

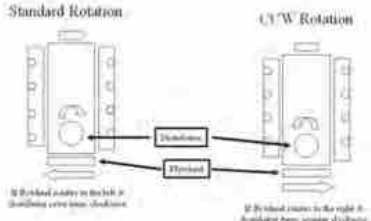

18-6443
STARTER
Replaces: RA122019
PG260, CW that fits GM 6.0L

 <p>18-5907 STARTER (Heavy-Duty) (No Core) Clockwise Replaces: RA122008 Replacement Solenoid: 18-5837 Will not replace non-starter mounted solenoids. Top mount rear entry started for opposite rotation GM & FORD engines. SAEJ1171</p>	 <p>Standard Rotation CCW Rotation</p> <p>If the solenoid is on the left it... If the solenoid is on the right it...</p>	 <p>18-5908 STARTER (Heavy-Duty) (No Core) Counter-Clockwise Replaces: RA122009 Replacement Solenoid: 18-5837 Top mount rear entry started for standard rotation GM & FORD engines. SAEJ1171</p>
--	--	--



18-5903
STARTER
 (No Core) Clockwise
 Replaces: RA122001
 Replacement Solenoid: 18-5801
 Bottom mount, two bolt pattern for standard rotation FORD engines.



18-5920
STARTER
 Replaces: 987811, RK122014, RA122001
 For: 5.0 & 5.8 litre Ford engines.



18-5801D Display Package
SOLENOID
 Replaces: R130001
 For all engines with flat solenoid bracket



18-5957
ALTERNATOR
 (3-Wire) (68 amp)
 Replaces: RA097002, RA097003, RA097006
 Replaces Mando, Motorols and original equipment Delco. Uses same electrical connections and mounting method. Equipped with fan and drive pulley. SAEJ1171



18-5984
ALTERNATOR
 Replaces: RA097007B
 75/70 amp, spool mount, 2 5/8" OD, 6 groove serpentine pulley Clockwise position, 65mm



18-6451
ALTERNATOR
 Fits: Gm LS Series



18-6288
ALTERNATOR
 Replaces: RA097007B
 75/70 amp, spool mount, single groove V-belt pulley



18-6452
ALTERNATOR
 Replaces: RA097009
 115/95 amp spool mount, serpentine pulley



18-6453
ALTERNATOR
 Replaces: RA097007C
 75/70 amp spool mount, serpentine pulley



18-7227
CHOKE THERMOSTAT
 Replaces: RN0067
 For: Holley Carburetors



18-15214
RELAY, SHROUDED
 Replaces: R130012
 For: Fuel Pump on Crusader MEFI systems



18-7206
FLOAT
 Nitrophyt



**18-7017
CARB KIT**
(Contains non-adjustable needles & seats)
Replaces: RN0118-1, RN0120-1



**18-7081
CARB KIT**
Replaces: RN0116, RN0116-2



**18-7096
CARB KIT**
Replaces: RN0118, RN0120

CARBURETOR KIT AND FLOAT APPLICATION

Engine/Model	Cyl.	Mfg. Code	Carb. Model	Carburetor No.	Float	Carb Kit ①
155, 165, 175, 185 w/302" (5.0L)	8	H-2	2300	R-6150A, R-6317A, R-6317-1A, R-7036A (D1JJ-9510-B, D3JL-9510-S)	18-7206	18-7081
215, 255, 215 w/302" (5.0L) 351" (5.8L)	8	H-4	4160	R-4473A, R-4473AAS, R-4608A, R-4608AAS, R-6151A, R-6151AAA, R-6152A, R-6152AAA, R-6407A, R-6576A (C9FF-9510-E, D2JL-9510E)	18-7206	18-7096
215, 255 w/302" (5.0L) 351" (5.8L)	8	H-4	4160	R-7159A, R-7163A, D4JL-9510-F, D4JL-9510-G	—	18-7017

① Does not include metering rods.



**18-7646
CAMSHAFT SENSOR**
Replaces: R020035A



**18-7677
KNOCK SENSOR**
Replaces: R020027



**18-7697
IAC MOTOR**
Replaces: R084003



**18-32150
O2 SENSOR**
Replaces: Idmar, Pleasurecraft, Mastercraft
Fits: GM New Generation Ls Series Small Block



**18-32151
O2 SENSOR**
Replaces: Idmar, Pleasurecraft, Mastercraft
Fits: GM New Generation Ls Series Small Block

FUEL WATER SEPARATORS



Sierra offers a complete line of 10 and 21 micron fuel water separating filters including drainable bowl filters to protect your carbureted and fuel injected engine.

Refer to pages 153-158 for a complete listing of OEM and universal applications.

Sierra fuel water separators remove over 99.8% of emulsified water from your gasoline. Sierra's 10 micron filters are over 90% efficient at removing particles as small as 10 micron. All filters flow @ 90 GPH to feed even the hungriest motor. Sierra 10 micron filters are recommended to prevent damage to sensitive inboard and outboard fuel injection systems.

Sierra #	Pleasurecraft #	Description
18-7964-1		Fuel Filter



18-8127
FUEL FILTER
Replaces: RP080026
For: 1996 & Up EFI Engines



18-7267
FUEL PUMP
Flange I.D. #41414
For: Ford (V-8) 302



18-3577-2
CIRCULATING WATER PUMP (Bi-Directional)
Replaces: RA057019
Fits: GM Big Block



18-3584
CIRCULATING WATER PUMP (Bi-Directional)
Replaces: RA057004
Includes 18-0147 gasket
Fits: Ford 302 & 351w



18-42608
CIRCULATING WATER PUMP
Replaces: RA057036
Fits: Indmar/PCM 6.0L



18-3599-2
CIRCULATING WATER PUMP
Replaces: RA057018
For: GM V-6 & small block V-8 engines
Uses gasket 18-0981 (included)



18-3586-1
WATER PUMP
Replaces: RA057023
Use Impeller Repair Kit: 18-3081



18-3587-1
WATER PUMP
Replaces: RA057024



18-5899
OIL PRESSURE SENDER
Replaces: RO20001



18-3551
THERMOSTAT
Replaces: R026002E
142"
For: FORD 302/351 CID Engines
Raw Water Cooled



18-3671
THERMOSTAT KIT
Replaces: RP026002E
For: Ford 302/351 CID Engines
Includes:
18-3551 Thermostat and
18-0875 Gasket
Raw Water Cooled

PKG. OF 8



FREEZE PLUGS
18-5961 1 5/8"
18-5961-9^①
18-5962 1 3/4"
18-5962-9^①



18-3060
IMPELLER
Replaces: RP061015
Sherwood 9959
For: Ford Engines



18-3061
IMPELLER
Replaces: RP061017
Sherwood 10615
For: GM Engines
With V-Belt



18-3081
IMPELLER REPAIR KIT

PKG. OF 2

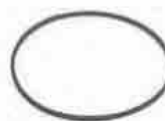

18-7480
18-7480-9^①
O-RING
Replaces: R047111
For use with 18-3060 & 18-3061 Impeller

^① Priced per Package

^② Items ending in "D" are Display Packaged - Regular number is Non-Display

Fits Ford Small Block V8 302 & 351 cu. in.

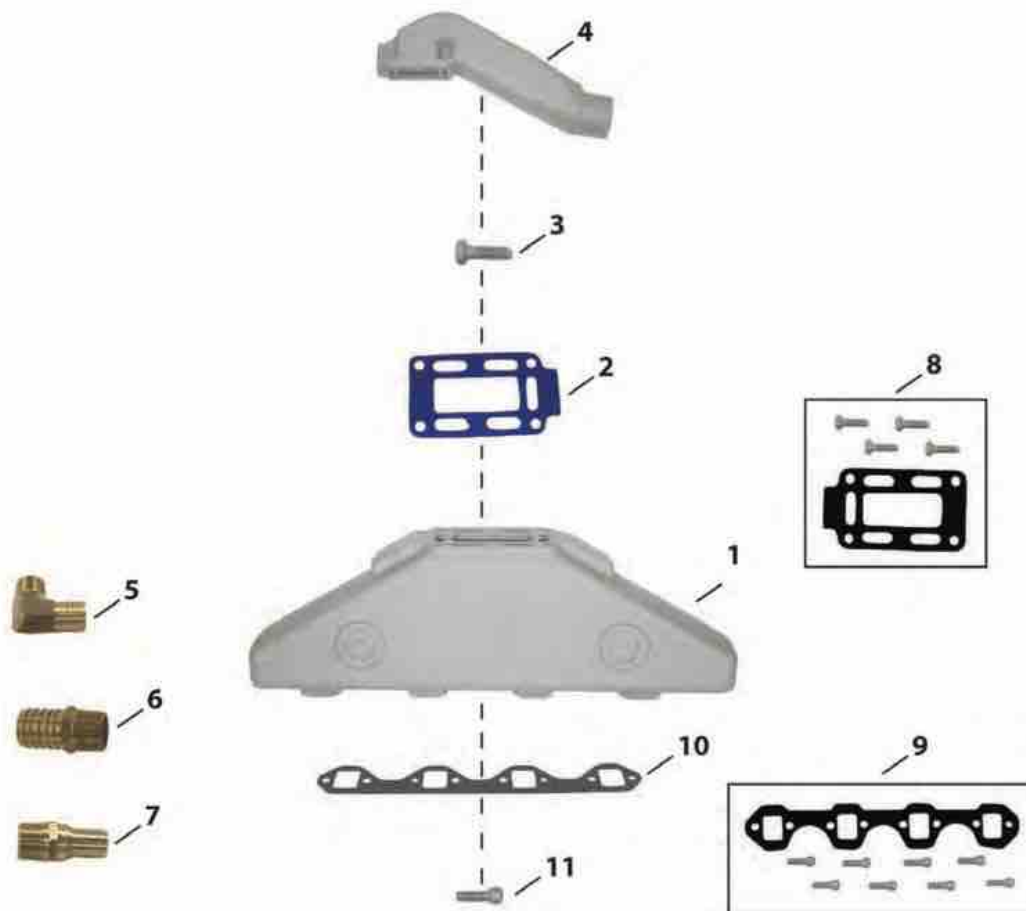

Item No.	Description	OE No.	Application
1	18-1996 MANIFOLD	RO28001	Ford Small Block (V8) 302-351 cu.in.; Use with Manifold Gasket: 18-0183-1; Mounting Kit: 18-8503
2	18-0677-1 GASKET	RM0002	Use with Riser: 18-1899; Included in 18-8504 mounting kit.
3	NSS MOUNTING BOLT	N/A	Included in 18-8504 mounting kit.
4	18-1899 RISER W/ 3" OUTLET	RO29001	Use with Manifold: 18-1996; Riser Gasket: 18-0677-1; Mounting Kit: 18-8504
5	18-8216 HOSE FITTING	N/A	3/4" - 14NPT X 1" Hose (Corrosion Resistant Brass Fitting)
6	18-4461 HOSE FITTING	N/A	3/4" - 14NPT X 1" Hose (Corrosion Resistant Brass Fitting)
7	18-8215 HOSE FITTING	N/A	3/4" - 14NPT X 3/4" Hose (Corrosion Resistant Brass Fitting)
8	18-8504 MOUNTING KIT	N/A	Use with Manifold: 18-1899. Includes 18-0677-1 gasket.
9	18-8503 MOUNTING KIT	N/A	Use with Manifold: 18-1996. Includes 18-0183-1 gasket.
10	18-0183-1 MANIFOLD GASKET	RM0007	Use with Manifold: 18-1996; Included in 18-8503 mounting kit.
11	NSS MOUNTING BOLT	N/A	Included in 18-8503 mounting kit.

SIERRA MANIFOLDS ARE PAINTED, PACKAGED AND LEAK TESTED



**18-1997-1
MANIFOLD**
Port & Starboard
Replaces: Barr CHV-1-83
Universal Center Riser Manifold
FITS: GM 283, 305, 307 and 350 CID engines
Use 18-0604 Exhaust Manifold Gasket Set
***For Exploded View - See Pages 656-657**



**18-1996
MANIFOLD**
Port & Starboard
Replaces: Pleasurecraft RO28001, Barr FM-1-83
Pleasurecraft Ford Small Block V8 302 and 351 cu. in.
Used with:
Exhaust Manifold Gasket: 18-0183-1 (included)
Mounting Kit: 18-8503



**18-1998-1
MANIFOLD**
Port & Starboard
Replaces: Barr FM-1-83
Universal Center Riser Manifold
FITS: Ford 302 and 351 CID engines
Use 18-0603 Exhaust Manifold Gasket Set
***For Exploded View - See Pages 658-659**



**18-1991
ELBOW ADAPTER**
Replaces: Barr 200089P
For: 3" I.D. Exhaust Hose
Use 18-1999 Manifold Riser 30"



**18-1992-1
ELBOW ADAPTER**
Replaces: Barr 200087P
For: 3" I.D. Exhaust Hose
(As used in 18-1987 Exhaust Manifold Conversion Kit)
80"



**18-1899
RISER**
Replaces: Pleasurecraft RO29001
FITS: Small block 302/351cu.in, Ford with 3" outlet.
FITS: 18-1996 Manifold
Used with:
Manifold: 18-1996
Riser Gasket: 18-0677-1
Mounting Kit: 18-8504



**18-1999
ELBOW**
Replaces: Barr 20-0082
Comes with 18-4364 open Mounting Package
If blocked mounting kit is required use 18-8535
Use 18-2854-1 open, 18-0475-1 blocked Riser Gasket
Use with:
Manifold: 18-1997 or 18-1998-1



**18-4363
EXHAUST ELBOW MOUNTING KIT**
Replaces: Barr FM-1-83-P
Use with:
Manifold: 18-1998-1



**18-4364
EXHAUST ELBOW MOUNTING KIT**
Replaces: Barr 20-0082-P
Use with:
Riser: 18-1999, 18-1907, 18-1939















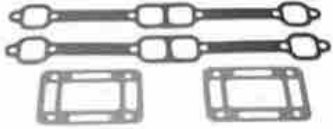

**18-8503
EXHAUST MANIFOLD MOUNTING KIT**
Pleasurecraft Ford Small Block
V8 302 and 351cu.in.
Used with:
Manifold: 18-1996



**18-8504
EXHAUST ELBOW MOUNTING KIT**
Pleasurecraft Ford Small Block
V8 302 and 351cu.in.
Used with:
Riser: 18-1899



**18-8535
EXHAUST ELBOW MOUNTING KIT**
Barr, Indmar and Marine Power Ford Small Block V8
302-351cu.in., GM Small Block V8 305-350cu.in., GM Big
Block V8 454cu.in.
Used with:
Risers: 18-1939, 18-1999, and 18-1907

 <p>18-8536 EXHAUST ELBOW MOUNTING KIT Barr, Indmar and Marina Power GM Small Block V8 305-350cu.in. Use with: Manifold: 18-1997-1</p>	 <p>18-8538 EXHAUST MANIFOLD MOUNTING KIT Barr and Indmar Ford Small Block V8 302-351cu.in. Use with: Manifold: 18-1998-1</p>	 <p>18-0603 EXHAUST MANIFOLD GASKET SET For: Ford 302/351 CID Engines Use with: Manifold: 18-1998-1</p>																
 <p>18-0604 EXHAUST MANIFOLD GASKET SET For: GM 305/350 CID Engines Use with: Manifold: 18-1997-1</p>	 <p>18-0183-1 EXHAUST MANIFOLD GASKET Replaces: RM0007 Use with: Manifold: 18-1998-1</p>	 <p>PIPE PLUGS</p> <table border="1"> <thead> <tr> <th>Part #</th> <th>Thread Size</th> <th>Part #</th> <th>Thread Size</th> </tr> </thead> <tbody> <tr> <td>18-4256</td> <td>1/4"</td> <td>18-4263</td> <td>1/8" - 27 NPT</td> </tr> <tr> <td>18-4257</td> <td>1/4"</td> <td>18-4264</td> <td>3/8" - 18 NPT</td> </tr> <tr> <td>18-4258</td> <td>3/4"</td> <td></td> <td></td> </tr> </tbody> </table>	Part #	Thread Size	Part #	Thread Size	18-4256	1/4"	18-4263	1/8" - 27 NPT	18-4257	1/4"	18-4264	3/8" - 18 NPT	18-4258	3/4"		
Part #	Thread Size	Part #	Thread Size															
18-4256	1/4"	18-4263	1/8" - 27 NPT															
18-4257	1/4"	18-4264	3/8" - 18 NPT															
18-4258	3/4"																	
 <p>18-0676-1 EXHAUST ELBOW GASKET Replaces: RM0099</p>	<p>PKG. OF 2</p>  <p>18-0677-1 18-0677-9Ⓛ EXHAUST ELBOW GASKET Replaces: RM0002 Use with: Mounting Kit: 18-8504 Riser: 18-1899</p>	<p>PKG. OF 2</p>  <p>18-2854-1 18-2854-9Ⓛ EXHAUST ELBOW GASKET Use with: Riser: 18-1999, 18-1907, 18-1939</p>																
<p>PKG. OF 2</p>  <p>18-2949 18-2949-9Ⓛ EXHAUST MANIFOLD GASKET Replaces: Barr CHV-47-000 Use with: Manifold: 18-1997-1</p>	 <p>18-0898 OIL PUMP MOUNTING GASKET Replaces: 27-56859 For: Ford Engines</p>	<p>Ⓛ18-4218D </p>  <p>18-4218 DRAIN TAP Used with most O.E.M. Manifolds 18-3223-9 Bulk Pack of 12 1/4" Brass</p>																
<p>PKG. OF 2</p>  <p>18-0875 18-0875-9Ⓛ THERMOSTAT GASKET</p>	<p>PKG. OF 2</p>  <p>18-0878 18-0878-9Ⓛ THERMOSTAT GASKET Replaces: RM0003</p>	<p>PKG. OF 2</p>  <p>18-0889 18-0889-9Ⓛ FUEL PUMP GASKET Replaces: 3705042</p>																

Ⓛ Priced per Package

Ⓛ Items ending in "D" are Display Packaged - Regular number is Non-Display

OIL FILTERS



Display Package

Part #	Replaces:	Application
18-7824-2	R077002	GM Engines (Short)
18-7875	R077001	Ford Engines (Long)
18-7876-1	—	GM Engines (Long)
18-7878-1	—	Ford Engines (Short)

SEE PAGES 200-202 & 1165-1190 FOR ADDITIONAL INFORMATION



18-3876 HEAD GASKET
 Replaces: GM 6269577
 For: GM 305/350 CID Engines

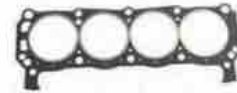

18-3883 HEAD GASKET
 Replaces: RM0032
 For Ford 302 and 351 CID Engines



18-4461 HOSE BARB
 3/4" - 14 NPT x 1" Hose
 Corrosion Resistant Brass Fitting



18-8215 HOSE BARB



18-2434 FLYWHEEL BELL HOUSING
 Replaces: R142006
 For: GM Blocks



18-2103 POWER TRIM HOSE
 Replaces: RO85035



18-2702-1 POWER TRIM BUSHING
 Replaces: R094020A



18-4220 THRUST WASHER
 Replaces: R096116



18-4214 LOCKING WASHER
 Replaces: RO96081



18-3701 PROP NUT KIT
 -CONTAINS-

Part #	O.E.#	Desc.
18-3200	R096117	Tab Washer
18-3700	R017086	Prop Nut



18-3700 PROP NUT
 Replaces: R017086



18-3200 TAB WASHER
 Replaces: R096117



18-4446 PROP WRENCH KIT
 - CONTAINS -

Part #	Desc.	O.E.#	Qty.
18-3200	Tab Washer	R096117	2
18-3700	Prop Nut	R017086	1
18-4444	Prop Wrench	—	1



18-4444 PROP WRENCH



18-4456 EXHAUST PROTECTOR VALVE
 Includes Stainless Steel Clamp
 3"



18-4457 EXHAUST PROTECTOR VALVE
 Includes Stainless Steel Clamp
 4"



18-4458 EXHAUST PROTECTOR VALVE
 Includes Stainless Steel Clamp
 5" & 6" (5" requires two 45° cuts)

① Priced per Package

② Items ending in "D" are Display Packaged - Regular number is Non-Display

UNIVERSAL



18-5307
CONTACT SET



18-5310
CONTACT SET



18-5311
CONTACT SET



18-5345
CONDENSER



18-5347
CONDENSER



18-5268
TUNE-UP KIT



18-5354
DISTRIBUTOR CAP



18-5359
DISTRIBUTOR CAP



18-5385
DISTRIBUTOR CAP



18-5418
ROTOR



18-5427
ROTOR



18-5419
ROTOR



18-5430
ROTOR



18-5433
IGNITION COIL
Requires external resistor
For: Atomic Four w/resistor (1969-70),
Super Sabre (1948-70)



18-28100
COIL LEAD
12" long w/90 degree male Dist end
and 90 degree female coil end



18-28101
COIL LEAD
12" long w/90 degree female Dist end
and 90 degree female coil end



18-28102
COIL LEAD
12" long w/90 degree male Dist end
and 180 degree male coil end

PARTS FOR CONTACT CONTROLLED DISTRIBUTORS

Year	Cyl.	Model / Engine	Distributor	Contact Set	Condenser	Cap	Tune-Up Kit	Rotor
1969-70	4	Atomic Four	DELCO	18-5311	18-5345	18-5385	18-5268	18-5418
1961-70	4	Unimite Four, HF (Herc. IXB), LSG Super Four, BFA, BN Utility Four, BR, FA, UJ Atomic Four, UJ64	IGW	—	—	18-5354	—	—
	6	Arrow, Bluefin, Economy, Bullet, Knight, Marlin, Tarpon	IGC-5501A	18-5307	18-5347①	—	—	18-5430
1954-68	6	Explorer Master, OK, QL, Z, Super Six	IAY-4009-1, IA	18-5307	—	—	—	18-5427
1963-65	6	Super Sabre	1110322	18-5310	—	—	—	18-5419
1945-60	4	HF, UJ, Atomic Four, BFA, BFS, BN, BR, EA, LSG, Racing 4, Super 4	IGW	—	—	18-5359	—	—
1955-57	6	HCS, LHS	IGW-6002B	18-5307	—	—	—	18-5430

① For lead type, use 18-5345

Standard Rotation

CCW Rotation

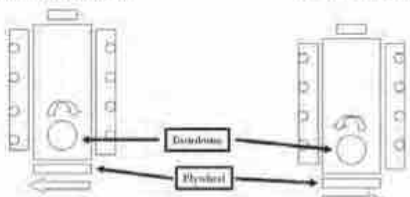

If Pulley rotates to the left it distributes from main clockwise.

If Pulley rotates to the right it distributes from main counter clockwise.



18-6264
RELAY
Arco R036
32-36 Volt, 85 Amp
Used with many winch motors



18-6263
ALTERNATOR
Replaces: 288182, 288759
12 Volt, 51 Amp, Integral Regulator,
Negative Ground, Single Groove Pulley
For: Universal and others
(I/O)



18-6284
ALTERNATOR
Hitachi Marine, Arco 84135
12 Volt, 35 Amp, Integral Regulator,
Single Groove Pulley
Fits: Yanmar Diesel
(Inboard)



18-5804
SOLENOID



18-5840
SOLENOID

PARTS FOR CHARGING SYSTEMS				PARTS FOR STARTING SYSTEMS			
Year	Model	Volt	Alt. or Gen. No	Voltage Regulator	Volt	Starter No.	Starter Switch Kit
1961-68	Explorer, Master, Super Six Unimite Four, Atomic Four, Utility Four, Blue Jacket Twin	—	—	—	12	MAU-4046	18-5840
		12	ALE-5202	—	—	—	—
		12	ALE-5204S	18-5710	12	MAU-4006, 47	18-5840
		12	ALK-6204	—	12	MBG-4129, 31	18-5840
1955-68	Knight, Tarpon, Marlin, Bullet, Arrow, Bluefin	—	—	—	6	MAU-4046, 47	18-5840
1954-68	OK, OL, Z Superb, Z Series	—	—	—	6	MAU-4046, 47	18-5840
1961-64	11694 Super Sabre V-6	12	1100619, 54	—	12	1107260	18-5804
1955-57	AMS, HCS, LHS	—	—	—	12	MAB-4116	18-5840

**18-7070
CARB KIT**

For: 198(3.3L), 225(3.7L) E, 6Cyl.
Carb Type and Model: R-2, 2GC
Carb No:7029081,7025181



**18-7071
CARB KIT**

For: 225(3.7L) Eng., 6Cyl.
Carb Type and Model: R-1, BC
Carb No:7024083



FUEL WATER SEPARATORS



Sierra offers a complete line of 10 and 21 micron fuel water separating filters including drainable bowl filters to protect your carbureted and fuel injected engine.

Refer to pages 153-158 for a complete listing of OEM and universal applications.

Sierra fuel water separators remove over 99.8% of emulsified water from your gasoline. Sierra's 10 micron filters are over 90% efficient at removing particles as small as 10 micron. All filters flow @ 90 GPH to feed even the hungriest motor. Sierra 10 micron filters are recommended to prevent damage to sensitive inboard and outboard fuel injection systems.

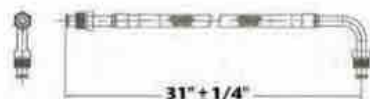

**18-8114
FUEL LINE HOSE**

For fuel pump to carburetor connection. Replaces copper or steel tubing 3/8" X 31" PTFE composite hose with 5/8"-18 male inverted flare straight one end, 5/8"-18 90° one end. SAE J1527 type A1.

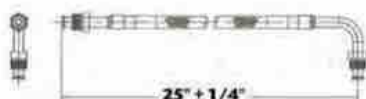

**18-8115
FUEL LINE HOSE**

For fuel pump to carburetor connection. Replaces copper or steel tubing 3/8" X 25" PTFE composite hose with 5/8"-18 male inverted flare straight one end, 5/8"-18 90° one end. SAE J1527 type A1.

Fits GM 454/502 CID V8 Big Block

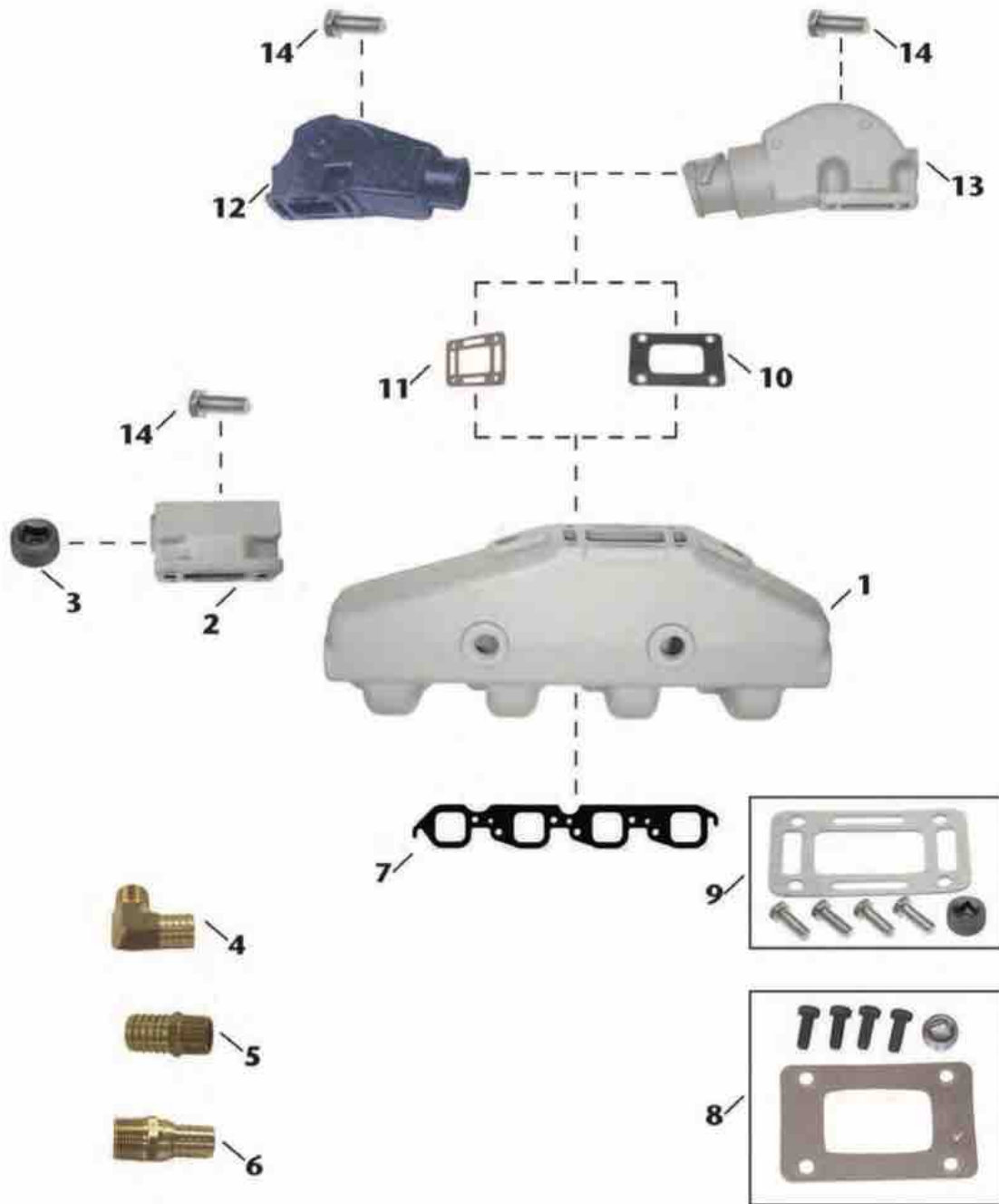

Item No.	Description	OE No.	Application
1	18-1898 MANIFOLD	BARR CHVA-1-84, MARINE POWER 0991-110	Fits 454/502 cu. in. GM Big Block V8 engines. Used with Manifold Gasket: 18-0418.
2	18-1949 MANIFOLD SPACER	N/A	Use with Manifold: 18-1898.
3	18-4258 BLACKSTEEL PLUG	N/A	Thread Size: 3/4". Use with Manifold Spacer: 18-1949.
4	18-8216 HOSE FITTING	N/A	3/4" - 14NPT X 1" Hose (Corrosion Resistant Brass Fitting)
5	18-4461 HOSE FITTING	N/A	3/4" - 14NPT X 1" Hose (Corrosion Resistant Brass Fitting)
6	18-8215 HOSE FITTING	N/A	3/4" - 14NPT X 3/4" Hose (Corrosion Resistant Brass Fitting)
7	18-0418 MANIFOLD GASKET	CRUSADER 96653	Use with Manifold: 18-1898
8	18-8535 MOUNTING KIT (BLOCKED GASKET)	N/A	Use with Risers: 18-1939, 18-1999, 18-1907. Includes 18-0476-1 elbow gasket. (Use with a closed cooling system)
9	18-4364 MOUNTING KIT (OPEN GASKET)	BARR 20-0082-P	Use with Risers: 18-1999, 18-1907, & 18-1939. Includes 18-2854-1 elbow gasket.
10	18-0476-1 ELBOW GASKET (BLOCKED)	BARR 01-0105	Used with Risers: 18-1939, 18-1999. Included in 18-8535 mounting kit.
11	18-2854-1 3" ELBOW GASKET (OPEN)	BARR 01-0107	Used with Risers: 18-1939, 18-1999. Included in 18-4364 mounting kit.
12	18-1999 3 1/2" MANIFOLD ELBOW	BARR 20-0082	Comes with 18-4364 (open) mounting package. If blocked mounting kit is required use 18-8535 mounting kit. Use with Manifold: 18-1898; Riser Gasket: 18-2854-1 (open) or 18-0476-1 (blocked)
13	18-1939 4" MANIFOLD ELBOW	BARR 20-0100, MARINE POWER 0992-593	Use with Manifold: 18-1898; Riser Gasket: 18-2854-1 (open) or 18-0476-1 (blocked); Mounting Kit: 18-4364 (open) or 18-8535 (blocked)
14	NSS MOUNTING BOLT	N/A	Included in 18-4364 & 18-8535 mounting kits.



Fits GM 305/350 CID V8 Small Block

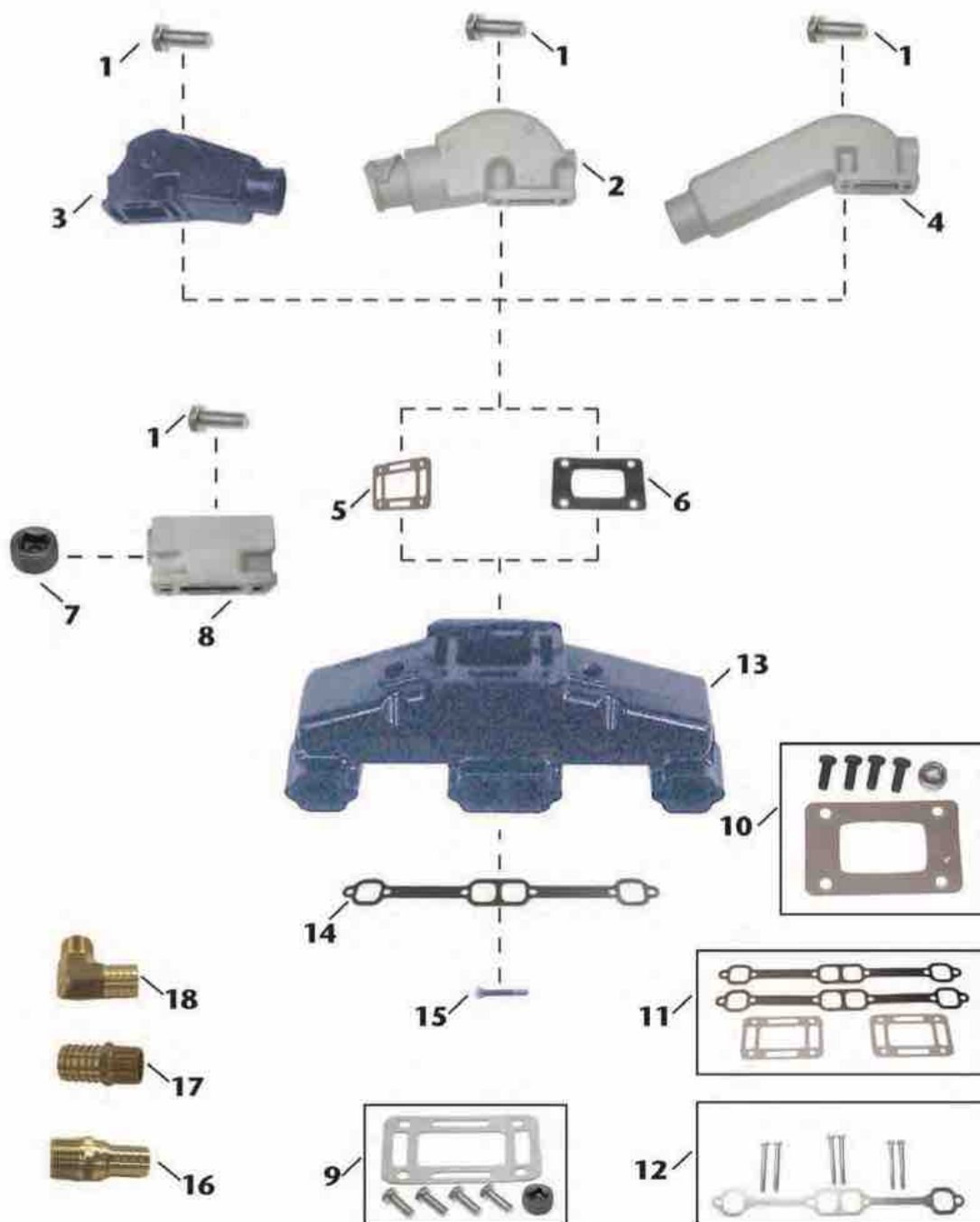

Item No.	Description	OE No.	Application
1	NSS MOUNTING BOLT	N/A	Included in 18-4364 & 18-8535 mounting kits.
2	18-1939 MANIFOLD ELBOW (4" hose, 7° down angle)	BARR 20-0100, MARINE POWER 0992-593	Use with Manifold: 18-1997-1; Riser Gasket: 18-2854-1 (open) or 18-0476-1 (blocked); Mounting Kit: 18-4364 (open) or 18-8535 (blocked)
3	18-1999 MANIFOLD ELBOW (3" hose, 15° down angle)	BARR 20-0082	Comes with 18-4364 (open) mounting package. If blocked mounting kit is required use 18-8535 mounting kit. Use with Manifolds: 18-1997-1; Riser Gasket: 18-2854-1 (open) or 18-0476-1 (blocked)
4	18-1907 MANIFOLD ELBOW (3" hose)	BARR 20-0100, INDMAR 53-2009, 53-2018	Use with Manifold: 18-1997-1; Riser Gasket: 18-2854-1 (open) or 18-0476-1 (blocked); Mounting Kit: 18-4364 (open) or 18-8535 (blocked)
5	18-2854-1 ELBOW GASKET (OPEN)	BARR 01-0107	Used with Risers: 18-1939, 18-1999, 18-1907. Included in 18-4364 mounting kit.
6	18-0476-1 ELBOW GASKET (BLOCKED)	BARR 01-0105	Used with Risers: 18-1939, 18-1999, 18-1907. Included in 18-8535 mounting kit.
7	18-4258 BLACKSTEEL PLUG	N/A	Thread Size: 3/4". Use with Manifold Spacer: 18-1949.
8	18-1949 MANIFOLD SPACER	N/A	Use with Manifold: 18-1997-1.
9	18-4364 MOUNTING KIT (OPEN GASKET)	BARR 20-0082-P	Use with Risers: 18-1999, 18-1907, & 18-1939. Includes 18-2854-1 elbow gasket.
10	18-8535 MOUNTING KIT (BLOCKED GASKET)	N/A	Use with Risers: 18-1939, 18-1999, 18-1907. Includes 18-0476-1 elbow gasket. (Use with a closed cooling system)
11	18-0604 EXHAUST MANIFOLD GASKET SET	N/A	GM 305-350 CID Engines; Use with Manifold: 18-1997-1
12	18-8536 MOUNTING KIT	N/A	Use with Manifold: 18-1997-1. Includes 18-2949 mounting kit.
13	18-1997-1 or 18-1964 MANIFOLD	BARR CHV-1-83	GM Small Block (V8) 305-350 cu.in. Use with Manifold Gasket 18-2949. Mounting Kit: 18-8536.
14	18-2949 MANIFOLD GASKET	BARR CHV-47-000	Use with Manifold: 18-1997-1. Included in 18-8536 mounting kit.
15	NSS MOUNTING BOLT	N/A	Included in 18-8536 mounting kit.
16	18-8215 HOSE FITTING	N/A	3/4" - 14NPT X 3/4" Hose (Corrosion Resistant Brass Fitting)
17	18-4461 HOSE FITTING	N/A	3/4" - 14NPT X 1" Hose (Corrosion Resistant Brass Fitting)
18	18-8216 HOSE FITTING	N/A	3/4" - 14NPT X 1" Hose (Corrosion Resistant Brass Fitting)



**Fits Ford 5.0L/5.8L
302/351 CID V8**

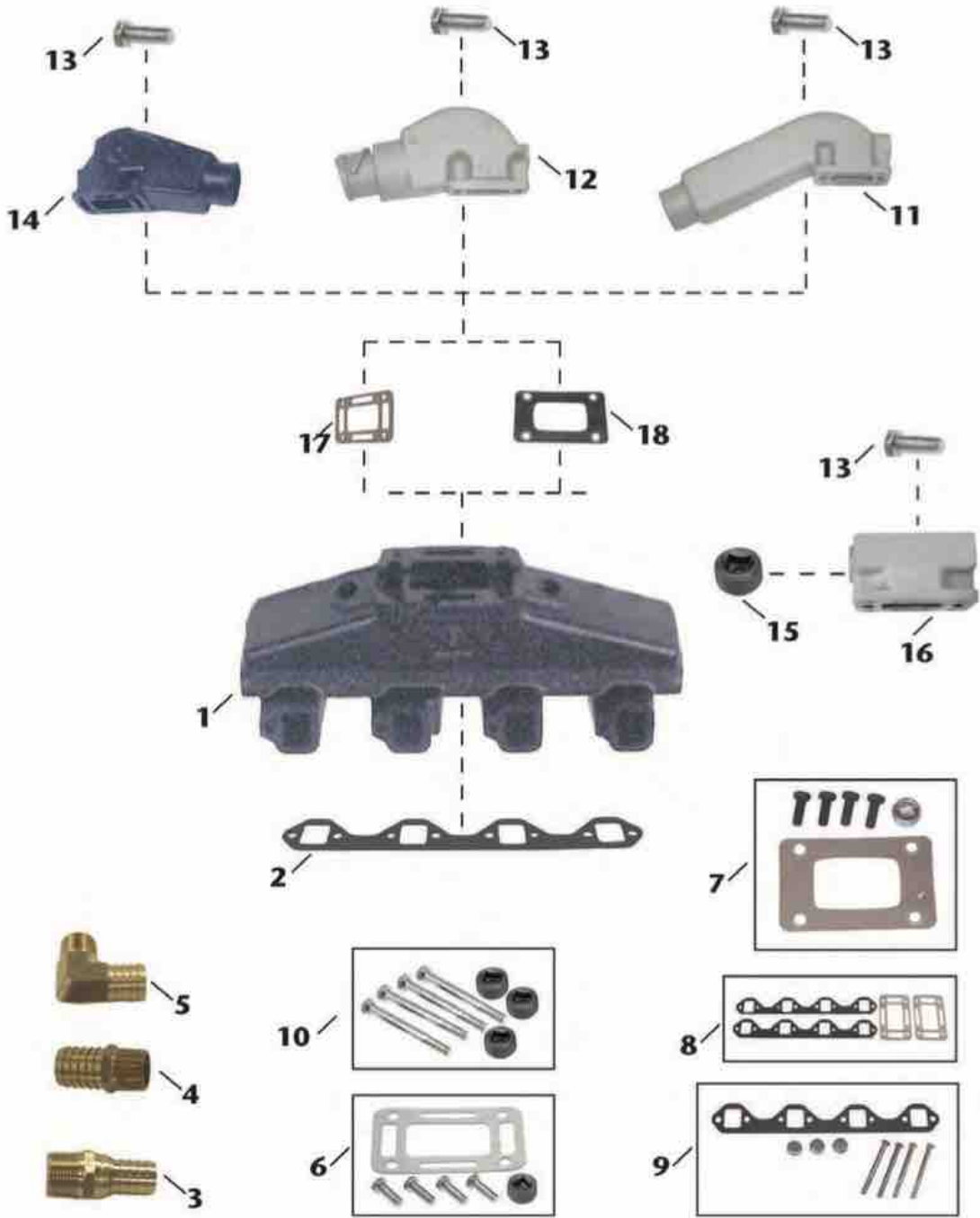

Item No.	Description	OE No.	Application
1	18-1998-1 MANIFOLD	BARR FM-1-83	Ford 302-351 (V8) CID Engines. Use with Manifold Gasket: 18-0183-1; Mounting Kit: 18-8538
2	18-0183-1 MANIFOLD GASKET	PLEASURECRAFT RM0007	Use with Manifold: 18-1998-1. Included in 18-8538 mounting kit.
3	18-8216 HOSE FITTING	N/A	3/4" - 14NPT X 1" Hose (Corrosion Resistant Brass Fitting)
4	18-4461 HOSE FITTING	N/A	3/4" - 14NPT X 1" Hose (Corrosion Resistant Brass Fitting)
5	18-8215 HOSE FITTING	N/A	3/4" - 14NPT X 3/4" Hose (Corrosion Resistant Brass Fitting)
6	18-4364 MOUNTING KIT (OPEN GASKET)	BARR 20-0082-P	Use with Risers: 18-1999, 18-1907, & 18-1939. Includes 18-2854-1 elbow gasket.
7	18-8535 MOUNTING KIT (BLOCKED GASKET)	N/A	Use with Risers: 18-1939, 18-1999, 18-1907. Includes 18-0476-1 elbow gasket. (Use with a closed cooling system)
8	18-0603 EXHAUST MANIFOLD GASKET SET	N/A	Ford 302-351 CID Engines; Use with Manifold: 18-1998-1.
9	18-8538 MOUNTING KIT	N/A	Use with Manifold: 18-1998-1. Includes 18-0183-1 manifold gasket.
10	18-4363 HARDWARE KIT	BARR FM-1-83-P	Hardware Only for Manifold: 18-1998-1
11	18-1907 ELBOW (3" hose)	BARR 20-0100, INDMAR 53-2009, 53-2018	Use with Manifold: 18-1998-1; Riser Gasket: 18-2854-1 (open) or 18-0476-1 (blocked); Mounting Kit: 18-4364 (open) or 18-8535 (blocked)
12	18-1939 ELBOW (7° down angle, 4" hose)	BARR 20-0100, MARINE POWER 0992-593	Use with Manifold: 18-1998-1; Riser Gasket: 18-2854-1 (open) or 18-0476-1 (blocked); Mounting Kit: 18-4364 (open) or 18-8535 (blocked)
13	NSS MOUNTING BOLT	N/A	Included in 18-4364 & 18-8535 mounting kits.
14	18-1999 MANIFOLD ELBOW (15° down angle, 3" hose)	BARR 20-0082	Comes with 18-4364 (open) mounting package. If blocked mounting kit is required use 18-8535 mounting kit. Use with Manifold: 18-1998-1; Riser Gasket: 18-2854-1 (open) or 18-0476-1 (blocked)
15	18-4258 BLACKSTEEL PLUG	N/A	Thread Size: 3/4". Use with Manifold Spacer: 18-1949
16	18-1949 MANIFOLD SPACER	N/A	Use with Manifold: 18-1998-1
17	18-2854-1 ELBOW GASKET (OPEN)	BARR 01-0107	Used with Risers: 18-1939, 18-1999, 18-1907. Included in 18-4364 mounting kit.
18	18-0476-1 ELBOW GASKET (BLOCKED)	BARR	Used with Risers: 18-1939, 18-1999, 18-1907. Included in 18-8535 mounting kit.



MOST MANIFOLDS ARE PAINTED, PACKAGED & LEAK TESTED



**18-1998-1
MANIFOLD**

Port & Starboard

Replaces: Barr FM-1-83

Universal Center Riser Manifold

FITS: Ford 302 and 351 CID engines

Comes with 18-4363 Mounting Package - **Replaces:** Barr FM 1-83-P

Use with:

Exhaust Manifold Gasket Set: 18-0603



**18-1997-1
MANIFOLD**

Port & Starboard

Replaces: Barr CHV-1-83

Universal Center Riser Manifold

FITS: GM 283, 305, 307 and 350 CID engines

Use with:

Exhaust Manifold Gasket Set: 18-0604



**18-1999
ELBOW (3" HOSE)**

Replaces: Barr 20-0082

Comes with 18-4364 open Mounting Package

Use with:

Manifold: 18-1997-1 or 18-1998-1 or 18-1898

Riser Gasket: 18-2854-1 open or 18-0476-1 blocked

Mounting Kit: 18-4364 open or 18-8535 blocked



**18-1898
MANIFOLD**

Port & Starboard

Replaces: Barr CHVA-1-84, Marine Power 0991-110

Fits: 454 cu.in. GM big block V8 engines

Use with:

Exhaust Gasket: 18-0418

Riser Gasket: 18-2854-1 open or 18-0476-1 blocked



**18-1907
RISER (3" HOSE)**

Replaces: Barr 20-0100, Indmar 53-2009, 53-2018

Barr and Indmar Ford Small Block V8 302-351cu.in.

Use with:

Manifolds: 18-1997-1 or 18-1998-1

Riser Gasket: 18-2854-1 open or 18-0476-1 blocked

Mounting Kit: 18-4364 open or 18-8535 blocked



**18-1939
RISER (4" HOSE)**

Replaces: Barr 20-0100, Marine Power 0992-593

Barr, Indmar and Marine Power Ford Small Block V8 302-351cu. in. GM

Small Block V8 305-350cu. in., GM Big Block V8 454cu. in.

Use with:

Manifold: 18-1997-1, 18-1998-1

Riser Gasket: 18-2854-1 open or 18-0476-1 blocked

Mounting Kit: 18-4364 open or 18-8535 blocked



**18-1949
MANIFOLD SPACER (3")**

Barr CM 20-0097

Barr, Indmar and Marine Power Ford Small Block V8

302-351cu.in., GM Small Block V8 305-350cu.in.,

GM Big Block V8 454cu.in.

Used with:

Manifolds: 18-1998-1, 18-1997-1 and 18-1898



**18-4363
EXHAUST ELBOW KIT**

Replaces: Barr FM-1-83-P

Use with:

Manifold: 18-1998-1













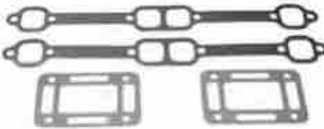

**18-4364 (Open)
EXHAUST ELBOW KIT**

Replaces:

Barr 20-0082-P

Use with:

Riser: 18-1999, 18-1907, 18-1939

 <p>18-8535 (Blocked) EXHAUST MANIFOLD MOUNTING KIT Barr, Indmar and Marine Power Ford Small Block V8 302-351cu.in., GM Small Block V8 305-350cu.in., GM Big Block V8 454cu.in. Used with: Risers: 18-1939, 18-1999, and 18-1907</p>	 <p>18-8536 EXHAUST ELBOW MOUNTING KIT Barr, Indmar and Marine Power GM Small Block V8 305-350cu.in. Used with: Manifold: 18-1997-1</p>	 <p>18-8538 EXHAUST MANIFOLD MOUNTING KIT Barr and Indmar Ford Small Block V8 302-351cu.in. Used with: Manifold: 18-1998-1</p>
 <p>18-0603 EXHAUST MANIFOLD GASKET SET For: Ford 302/351 CID Engines For use with 18-1998-1</p>	 <p>18-0604 EXHAUST MANIFOLD GASKET SET For: GM 305/350 CID Engines For use with 18-1997-1</p>	 <p>18-0183-1 EXHAUST MANIFOLD GASKET Replaces: Mercruiser 27-73866, 27-54566 Volvo 3853742, 3852455 OMC 908717 Used with: Manifold: 18-1962-1, 18-1938, 18-1999-1, 18-1996, 18-1979</p>
 <p>18-0418 EXHAUST MANIFOLD GASKET Replaces: Mercruiser 27-46820 Use with: Manifolds: 18-1957-2, 18-1982, 18-1929, 18-1933, 18-1898</p>	 <p>18-0476-1 RISER BLOCKOFF GASKET Replaces: Barr 01-0105 Indmar & Marine Power Ford Small Block V8 302-351cu.in. Used with: Risers: 18-1939, 18-1999, 18-1907</p>	<p>PKG. OF 2</p>  <p>18-2854-1 (Open) 18-2854-9 EXHAUST ELBOW GASKET Replaces: Barr 01-0107 Use with: Riser: 18-1999, 18-1939, 18-1907</p>
<p>PKG. OF 2</p>  <p>18-2949 18-2949-9 EXHAUST MANIFOLD GASKET Replaces: Barr CHV-47-000 Use with: Manifold: 18-1997-1</p>	 <p>18-4461 HOSE BARB Replaces: Mercruiser 22-807155 3/4" - 14 NPT x 1" Hose Corrosion Resistant Brass Fitting</p>	 <p>18-4258 PIPE PLUG Replaces: Mercruiser 22-33198, 22-33198A1, 22-41622, 22-46754 3/4" Thread size Blacksteel</p>

① Priced per Package

Sierra[®]

High Performance

18-5466 HI-PERFORMANCE IGNITION COIL

1.5 ohm (oil filled), black - 8 cylinder:
Flame-Thrower 40,000 volt coil.

- Designed for use with the original Ignitor Electronic Conversion Kits
- Can be used with other inductive ignition systems



18-5469 HI-PERFORMANCE IGNITION COIL

3.0 ohm (oil filled), black - 4 & 6 cylinder:
Flame-Thrower 40,000 volt coil.

- Designed for use with the original Ignitor Electronic Conversion Kits
- Can be used with other inductive ignition systems



18-5472 HI-PERFORMANCE IGNITION COIL

0.6 ohm (oil filled), black - 4, 6, & 8
cylinder: Flame-Thrower 45,000 volt coil.

- Super low 0.6 ohm resistance coil designed for use with the Ignitor II Hi Performance Electronic Conversion Kits
- Compatible with capacitive discharge systems



18-8898 COIL

High performance coil HV for Ignitor or points



18-8899 COIL

High performance coil HV for Ignitor II or Flamethrower



18-29716 CHROME HIGH OUTPUT COIL

Replaces: Mallory 29716
Fits: Mallory 8 cylinder



18-29717 CHROME COIL

Replaces: Mallory 29217
Fits: Breaker Point Ignition systems



18-28150 WIRE SEPARATOR / BLUE



18-28151 WIRE SEPARATOR / BLACK

PROMASTER[®] SERIES IGNITION COILS



18-29720

Replaces: Mallory 29440M
For use with Mallory UNILITE Ignition, Magnetic Breakerless Ignition and /or Electronic Advance Computer. Effective to 8000 RPM's. (External Resistor required)



18-29723

For use with Mallory UNILITE Ignition, Magnetic Breakerless Ignition and /or Electronic Advance Computer. Effective to 8000 RPM's. (Internally Resisted)

Our PROMASTER[®] Coil delivers higher performance through faster rise time and longer spark duration. A rugged, glass-filled polyester case and oil-filled construction ensure long life with no energy loss from arcing. All PROMASTER[®] Coils include threaded brass contact terminals and spark plug type secondary post for better coil wire retention. For use with Mallory UNILITE[®] Ignition, Magnetic Breakerless Ignition, and/or Electronic Advance Computer. Effective to 8000 RPM.

Sierra[®] High Performance



18-28175
WIRE MARKERS



18-5285
**HI-PERFORMANCE
ELECTRONIC CONVERSION KIT**
Fits: 4 Cylinder Delco Distributors



18-5288
**HI-PERFORMANCE
ELECTRONIC CONVERSION KIT**
Fits: Most Prestolite V-8 Distributors with snap down cap



18-5289
**HI-PERFORMANCE
ELECTRONIC CONVERSION KIT**
Fits: Most Prestolite Distributors with screw down cap



18-5290
**HI-PERFORMANCE
ELECTRONIC CONVERSION KIT**
Fits: Most Mallory YL or YD 8 cylinder Distributors with clockwise and counter clockwise rotation



18-5477
ELECTRONIC DISTRIBUTOR
Fits: Ford 302 V-8 engines
Replacement Cap/Rotor Kit **18-5266**



18-5478
ELECTRONIC DISTRIBUTOR
Fits: Chrysler LA series V-8 engines



18-5479
ELECTRONIC DISTRIBUTOR
Fits: GM V-8 engines-reverse rotation



18-5480
**COMPLETE IGNITION
CONVERSION KIT**
Fits: GM SB & BB with Standard Deck Height



18-5481
**HI-PERFORMANCE
ELECTRONIC DISTRIBUTOR**
Fits: Ford V-8 351 Windsor
Replacement cap/rotor kit: **18-5266**



18-5482
**HI-PERFORMANCE
ELECTRONIC DISTRIBUTOR**
Fits: Ford V-8 351 Cleveland, 351M, 400, 429 and 460 engines. Replacement cap/rotor kit: **18-5266**

Sierra[®] High Performance



18-5483
HI-PERFORMANCE ELECTRONIC DISTRIBUTOR
Fits: Chevrolet marine small and big block engines (standard deck height). Replacement cap/rotor kit: 18-5266



18-5473
DISTRIBUTOR CAP
Black Distributor Cap with Male Terminals for Flamethrower Distributors



18-5474
DISTRIBUTOR CAP
Red Distributor Cap with Male Terminals for Flamethrower Distributors



18-6842
ALTERNATOR
Replaces: 983424, 836, 247
For: 37-63A Marine Applications

18-6975
ALTERNATOR (Universal)
Fits: High amp 160A alternator, universal mounting pattern based on Delco CS1300 design, v-belt and 6 groove serpentine pulley included



18-6834
STARTER
Replaces: GM Engines Universal
Used on all GM Engines with either 14 1/4" or 12 3/4" flywheels



18-6835
STARTER
Replaces: GM Engines Universal
3 terminal
Used on all GM Engines with either 14 1/4" or 12 3/4" flywheels



18-7751
CARB KIT
Replaces: Mercruiser 13220
Fits: GM 420 V8 454 (1987-89), GM 425 V8 454 (1990-93), GM 425 (Gen V) V8 454 (1992-93), 440 TRS GM 454 (1983-86), GM 450 V8 454(1995-96), 460 TRS V8 482 (1983-86), GM 465 V8 502 (1990-92), GM 465 (Gen V) V8 502 (1992-94), 500 (Gen+) GM 502 V8 (1999), 500 (Gen V) 502 V8 (1994-98), 500 Bulldog 540 V8 (1990-01)



18-7637
CARBURETOR (REMANUFACTURED)
(Gasket included)
600 CFM Holley 4V



18-7638
CARBURETOR (REMANUFACTURED)
600 CFM Holley 4V-side inlet



18-7775
FILTER BRACKET
3/8" Aluminum



18-7776
FILTER BRACKET
3/8" Stainless Steel



18-7232
FLAME ARRESTOR
Replaces: Crusader 33628
Mercruiser 57882, 57882T

Sierra[®]

High Performance



18-7790
FUEL FILTER KIT
Complete Kit Contains: Housing, Replaceable Element & Fittings for 1/4", 3/8", & 1/2" Fuel Lines
Uses Filter 18-7791



18-7945C
FUEL WATER SEPARATER FILTER (Chrome)
Replaces: Mercury 35-802893Q
Yamaha ABB-FUELF-IL-TR



18-7824C-2
OIL FILTER (Chrome)
Short GM
Replaces:
Chris-Craft 16.81-08746
Crusader 201104, Indmar: 50-1001
Mercruiser 35-802885Q, 32716, 866340Q02, Q03, 866340K01
Mercruiser Vazer, OMC 173232, 502902
Pleasurecraft R077002
Volvo-Penta 835440
Yamaha YSC-10231-20-0C
Thread Spec: 13/16" x 16NPT



18-7866
FUEL FILTER
Replaces: Yamaha MAR-FUELF-IL-TR
High Capacity - 6" 10 Micron



18-8114
FUEL LINE HOSE
For fuel pump to carburetor connection. Replaces copper or steel tubing 3/8" X 31" PTFE composite hose with 5/8"-18 male inverted flare straight one end, 5/8"-18 90° one end. SAE J1527 type A1



18-8115
FUEL LINE HOSE
For fuel pump to carburetor connection. Replaces copper or steel tubing 3/8" X 25" PTFE composite hose with 5/8"-18 male inverted flare straight one end, 5/8"-18 90° one end. SAE J1527 type A1



18-34110
ELECTRIC FUEL PUMP
Replaces: Mallory 4110M
110GPH MARINE



18-34120
ELECTRIC FUEL PUMP
Replaces: Mallory 5110MF1
INJ 110GPH



18-34140
ELECTRIC FUEL PUMP
Replaces: Mallory 4140M
140GPH MARINE



18-35102
FUEL PUMP BLOCK-OFF PLATE BB CHEV
Replaces: Mallory 5422
For: Chevrolet 396-502 & Ford 289-351W



18-7332
ELECTRIC FUEL PUMP
Includes bracket and mounting hardware
43 GPH - 7 PSI Max - 1/4 NPSF for 3/8 hose
- operates with both gasoline and diesel fuel - 24 Volt only



18-35435
ELECTRIC FUEL PUMP

Universal - 12V 2.5-4.5 psi @ 16.8 gph 1/8"
Female Pipe Thread



18-35436
ELECTRIC FUEL PUMP

Universal - 12V 5-9 psi @ 16.8 gph 1/8"
Female Pipe Thread



18-7628
INTAKE MANIFOLD

Small-block GM with vortec cylinder heads
Brass lined water jackets for salt water
applications



18-7489
WEBER 750 CARBURETOR

- Universal square flange mounting pattern
- High-luster polished exterior
- Electric choke
- Calibrated and flow-tested for mid to high range performance improvement and throttle response.



18-1989
THERMOSTAT HOUSING

Replaces: *MerCruiser* 8M0061381, 861006A1

Stainless Steel

Use **18-1989K** Thermostat Service Kit
for replacement parts



18-1989K
THERMOSTAT SERVICE KIT

Service Kit for **18-1989** Thermostat Housing



18-4506
GUIDE PLATES

Big-Block GM with 5/16" pushrods



18-4507
ROCKER ARM KIT (4 VALVES)

Big-Block GM

18-4492
ROCKER ARM ASSEMBLY

Replaces: *MerCruiser* 35329, F3746241, F11100014, F11100495
Fits: MCM/MIE Gm V6 & V8(283, 305 & 350 cid) engines



CYLINDER HEAD ASSEMBLIES

*All cylinder heads are new castings and complete assemblies with new stainless steel valves, hardened steel exhaust seats, valve springs, valve locks and retainers.
All GM cylinder heads utilize high performance screw-in rocker arm studs in place of factory press in rocker arm studs.*



18-4485HP CYLINDER HEAD ASSEMBLY

Fits: Mid GM small block 5.7L high performance.
Completely assembled with revised runner and combustion chambers. Add 30hp to stock motor with no additional modifications.



18-4486HP CYLINDER HEAD ASSEMBLY

Fits: Vortec GM small block 5.7L high performance.
Completely assembled with revised runner and combustion chambers. Add 30hp to stock motor with no additional modifications.



18-4484HP CYLINDER HEAD ASSEMBLY

Fits: Early GM small block 5.7L high-performance.
Completely assembled with revised runner and combustion chambers. Add 30hp to stock motor with no additional modifications.



18-4493HP CYLINDER HEAD

Fits: Big-block GM cast iron performance.



18-4501HP CYLINDER HEAD

Fits: Vortec GM small block 5.0L
Completely assembled with revised runner and combustion chambers. Add 30hp to stock motor with no additional modifications.



18-4503 CYLINDER HEAD (HIGH PERFORMANCE)

- Up to 60 HP increase over OE cylinder heads
- 5 angle valve seat out
- Double drilled intake mounting
- For either standard 12 bolt GM intake or late-model 8 bolt Vortec intake
- Accepts both perimeter or center bolt valve covers.
- Fits 5.7 & 6.2L small block GM V-8 applications
- OE lock
- Corrosion resistance heavy-duty cast iron castings suitable for saltwater usage
- Intake Runner: 185cc
- Exhaust Runner: 62cc
- Combustion Chambers: 72cc
- Intake Stainless Steel Valves: 2.02
- Exhaust Stainless Steel Valves: 1.60
- Cast Iron Cylinder Heads: Sold in pairs only



18-4735 INTAKE VALVE (2.02")

Fits: GM V-6 & V-8 engines



18-4497 TIMING COVER

For: Small block GM-(1986-1995)



18-4516 RING GEAR-FLYWHEEL

14" GM flywheel w/ 168 teeth



18-4517 RING GEAR-FLYWHEEL

12" GM flywheel w/ 153 teeth



18-4518 FLYWHEEL

14" 4.3L V-6, 1 piece main 1987 and up.
Bottom mount starter (Block mounted)
applications.



18-4519 FLYWHEEL

14" 5.0/5.7L, 1 piece main 1987 and UP.
Bottom mount starter (Block mounted)
applications.



18-4521 FLYWHEEL

14" small-block GM, 2 piece main, pre 1987.
Bottom mount starter (Block mounted)
applications.



18-4522 FLYWHEEL

14" 454, Gen IV w/ 2 piece rear main.
Bottom mount starter (Block mounted)
applications.



18-4523 FLYWHEEL

14" 454, Gen V & VI w/ 1 piece rear main.
Bottom mount starter (Block mounted)
applications.



18-4737
ROCKER ARM STUD
Fits: GM V-6 & V-8 engines



18-8962
VALVE COVER SET
For: 4.3L V-6 (1986 & Up) metal



18-8963
VALVE COVER SET
For: Small block GM (1986 & up)



BRASS FREEZE PLUG KITS
Eliminate any chance of rusted out freeze plugs with our Brass Freeze Plug Kits. Designed for marine applications. Kit includes all plugs needed for a complete engine.

Part No.	
18-56481	Chevrolet 265-400

A MARINE PARTS SELECTION THAT'S SECOND TO NONE



Quality products backed by an industry-leading warranty.

ENGINE & DRIVE PARTS **INSTRUMENTATION** **SWITCHES**
ENGINE DIAGNOSTICS **SHIELDS HOSE** **OILS & LUBRICANTS**
TOOLS & ACCESSORIES

THE VERY BEST PARTS OF BOATING

EDELbrock® CARBURETORS



18-34080
600 CFM CARBURETOR
 Fits: V-6 and small V-8 engines



18-34081
750 CFM CARBURETOR
 Fits: Small and big-block GM engines



EDELbrock® INTAKE MANIFOLDS



18-34082
BRASS WATER INTAKE
MANIFOLD
 Fits: Small block GM, 1955-1986



18-34083
BRASS WATER INTAKE
MANIFOLD
 Fits: Small block GM, 1967-1995



18-34084
BRASS WATER INTAKE
MANIFOLD
 Fits: Big-block GM with oval port cylinder heads



EASY TO USE MODULAR GASKET KITS FOR FORD & CHEVROLET MARINE ENGINES

- For most popular marine versions of: Chevrolet In-line 4 & 6 cylinder V6 & V8 Engines and Ford 5.0 L & 5.8L V8 Engines
- Minimizes inventory investment to cover most major engine applications
- Maximizes inventory utilizations via mix and match system
- Utilizes generic type gasket kits common among all engine brands., (i.e. a 350CID (5.7L) Crusader & Mercruiser would use the same short block & valve grind gasket sets, but would use different exhaust manifold gasket kits)

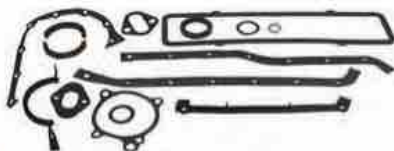
CHEVY 4 cyl. 153/2.5L 1965-88 ③**CHEVY 4 cyl. 181/3.0L 1973-84 ③****CHEVY 4 cyl. 181/3.0L 1985-89 (4 cyl. 181/3.0L HO 1990-98 ③)****18-1271 ① ②
SHORT BLOCK
GASKET SET**

— CONTAINS —

Description	Part #
Oil Pan Gasket	18-0466
Forward Crankshaft Seals	18-1213
Rear Crankshaft Seals	18-1211
Push Rod Cover	18-2815
Water Pump Gasket	18-0327
Fuel Pump Mounting Gasket	18-0889
Fuel Pump Mounting Gasket	NSS
Cam Gear Cover Gasket	18-0887
Distributor Mounting Gasket	18-0948
Distributor Mounting Gasket	18-0874

**18-1274
HEAD GASKET SET**

— CONTAINS —

Description	Part #
Head Gasket	18-2946
Mercarb Mounting Gasket	18-0994
Carb. Mounting Gasket	18-0356
Thermostat Housing Gasket	18-0164
Valve Cover Gasket	18-0347
Valve Stem Seals (8)	18-0518

GM 4 cyl. 3.0L**18-1206
SHORT BLOCK GASKET SET**

— CONTAINS —

Description	Part #
Front Crankshaft Seal	18-1213
Rear Crankshaft Seal	18-0519
Fuel Pump Mounting Gasket	18-0889
Fuel Pump Mounting Gasket	NSS
Push Rod Cover Gasket	18-2815
Distributor Mounting Gasket	18-0874
Distributor Mounting Gasket	18-0948
Timing Cover Gasket	18-0887
Water Pump Gasket	18-0327

**4 cyl. 3.7L Mercruiser 470****18-1276
SHORT BLOCK GASKET SET**

— CONTAINS —

Description	Part #
Oil Seal	18-2014
Mounting Gasket	NSS
Distributor Mounting Gasket	18-0874
Fuel Pump Mounting Gasket	18-0889
O-Ring	NSS
Water Pump Seal	18-0172
O-Ring	18-7145
Oil Pan Gasket	18-4366
Water Pump Timer Cover Gasket	NSS
Timing Chain Gasket Set	18-4380

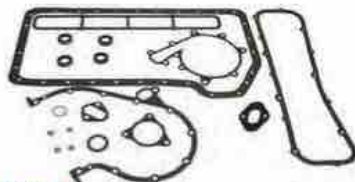
**18-1277
HEAD GASKET SET**

— CONTAINS —

Description	Part #
Intake Gasket	18-0158
Quadrajel Gasket	18-2848
Valve Grind Cover Gasket	18-0685
Head Gasket	18-3878
Exhaust Manifold Mounting Gasket	18-0956-1
Valve Seal	18-4023



① Except models with cast push rod cover
 ② Does not include intake and/or exhaust manifold gaskets

③ For models with 1 piece rear main seal use 18-1206
 NSS Not Sold Separately

CHEVY 6 Cyl. 250/4.1L

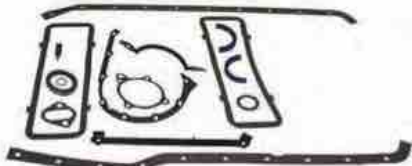

18-1255

SHORT BLOCK GASKET SET

(24 Bolt Pan Only)

— CONTAINS —

Description	Part #
Oil Pan Gasket	18-0340
Forward Crankshaft Seals	18-1213
Rear Crankshaft Seals	18-1211
Push Rod Cover	18-0329
Water Pump Gasket	18-0327
Fuel Pump Mounting Gasket	18-0889
Timing Gear Cover Gasket	18-0887
Distributor Mounting Gasket	18-0874

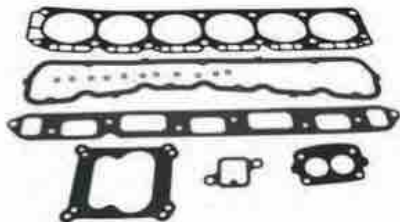

18-1264

HEAD GASKET SET

— CONTAINS —

Description	Part #
Head Gasket	18-3881
4BBL Carb Mounting Gasket	18-0463
2BBL Carb Mounting Gasket	18-0356
Exhaust Manifold Gasket	18-2830-1
T-Stat Hsg. Mounting Gasket	18-0164
Valve Cover Gasket	18-0346
Valve Stem Seals (8)	18-0518

CHEVY V-6 229/3.8L AND 4.3L (thru 1985)

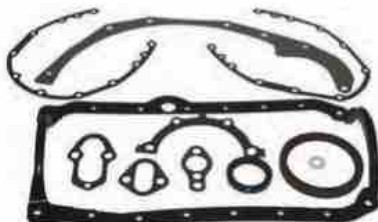

18-1270 *

SHORT BLOCK GASKET SET

— CONTAINS —

Description	Part #
Oil Pan Gasket	18-0405
Oil Drain Screw Gasket	18-0905
Forward Crankshaft Seals	18-1213
Rear Crankshaft Seal	18-0519
Crankshaft Seal Retainer	18-0322
Water Pump Mounting Gasket	18-0891
Fuel Pump Plate Gasket	NSS
Fuel Pump Mounting Gasket	18-0889
Timing Chain Cover Gasket	18-0976
Timing Chain Cover Gasket	18-0468

* Requires Rear Crankshaft Seal
(Not Included) in addition to short block kit

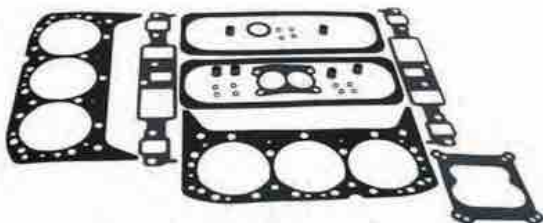

18-1275 ①

HEAD GASKET SET

— CONTAINS —

Description	Part #
Head Gasket	18-3879
2BBL Carb Mounting Gasket	18-0994
4BBL Carb Mounting Gasket	18-0463
Intake Manifold Gasket	18-4408
Valve Cover Gasket	18-0311
Valve Stem Seals (6)	18-4024
Valve Stem Seals (12)	18-0518
Distributor Mounting Gasket	18-0874

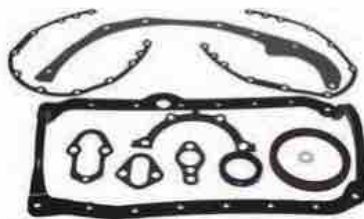
CHEVY V-6 262/4.3L - 1 Piece Rear Seal
CHEVY V-6 262/4.3L GEN II - 1 Piece Rear Seal
1986-1995

18-1270

SHORT BLOCK GASKET SET

— CONTAINS —

Description	Part #
Oil Pan Gasket	18-0405
Oil Drain Screw Gasket	18-0905
Forward Crankshaft Seals	18-1213
Rear Crankshaft Seal	18-0519
Crankshaft Seal Retainer	18-0322
Water Pump Mounting Gasket	18-0891
Fuel Pump Plate Gasket	NSSFuel Pump
Mounting Gasket	18-0889
Timing Chain Cover Gasket	18-0976
Timing Chain Cover Gasket	NSS

* Requires Rear Crankshaft Seal
(Not Included) in addition to short block kit



18-1278

HEAD GASKET SET

— CONTAINS —

Description	Part #
Head Gasket	18-3879
2BBL Carb Mounting Gasket	18-0994
4BBL Carb Mounting Gasket	18-0463
Valve Stem Seals (6)	18-4024
Valve Stem Seals (12)	18-0518
Distributor Mounting Gasket	18-0874
Intake Gasket Set	18-1238
Valve Cover Gasket (2)	18-0311

CHEVY V-8 305/5.0L
2 Piece Rear Seal
thru 1985



18-1265

SHORT BLOCK GASKET SET
Port Dip Stick Models ONLY
Left Hand (Standard Rotation)

— CONTAINS —

Description	Part #
Oil Pan Gasket	18-0153
Oil Drain Screw Gasket	18-0905
Oil Filter Gasket	18-0185
Forward Crankshaft Seal	18-1213
Rear Crankshaft Seal	18-1211
Water Pump Mounting Gasket	18-0891
Water Pump Plate Gasket	18-0893
Fuel Pump Plate Gasket	18-0876
Fuel Pump Mounting Gasket	18-0889
Timing Chain Cover Gasket	18-0976
Vent Adapter Gasket	NSS

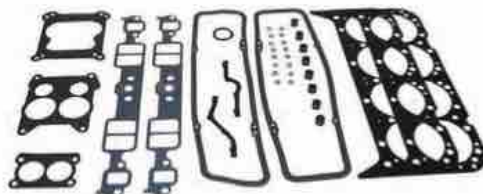

18-1266 ②

HEAD GASKET SET

— CONTAINS —

Description	Part #
Head Gasket	18-3876
2BBL Carb Mounting Gasket	18-0994
4BBL Carb Mounting Gasket	18-0463
4BBL Carb Mounting Gasket	18-0462
Intake Manifold Gasket	18-0868
Valve Cover Gasket (2)	18-2845
Valve Stem Seals (8)	18-4024
Valve Stem Seals (16)	18-0518
Distributor Mounting Gasket	18-0874

CHEVY V-8 305/5.0L (Right Hand Rotation)
2 Piece Rear Seal
thru 1985

18-1266 ②

HEAD GASKET SET

— CONTAINS —

Description	Part #
Head Gasket	18-3876
2BBL Carb Mounting Gasket	18-0994
4BBL Carb Mounting Gasket	18-0463
4BBL Carb Mounting Gasket	18-0462
Intake Manifold Gasket	18-0868
Valve Cover Gasket (2)	18-2845
Valve Stem Seals (8)	18-4024
Valve Stem Seals (16)	18-0518



CHEVY V-8 305/5.0L GEN II
1 Piece Rear Seal
1986-1995

18-1267 ②

HEAD GASKET SET

— CONTAINS —

Description	Part #
Head Gasket	18-3876
2BBL Carb Mounting Gasket	18-0994
4BBL Carb Mounting Gasket	18-0463
4BBL Carb Mounting Gasket	18-0462
Intake Manifold Gasket Set	18-0868
Valve Cover Gasket (2)	18-0664
Valve Stem Seals (8)	18-4024
Valve Stem Seals (16)	18-0518



① Does not include oil pan gasket

② Does not include intake and/or exhaust manifold gaskets

NSS Not Sold Separately

**CHEVY V-8 305/5.0L GEN II (Right Hand Rotation)
1 Piece Rear Seal
1986-1995**



18-1263 ①

SHORT BLOCK GASKET SET

— CONTAINS —

Description	Part #
Oil Drain Screw Gasket	18-0905
Oil Filter Gasket	18-0185
Forward Crankshaft Seal	18-1213
Rear Main Bearing Gasket	18-0322
Water Pump Mounting Gasket	18-0891
Water Pump Backing Plate Gasket	18-0893
Water Pump Plate Gasket	NSS
Fuel Pump Plate Gasket	18-0876
Fuel Pump Mounting Gasket	18-0889
Timing Chain Cover Gasket	18-0976



18-1267 ②

HEAD GASKET SET

— CONTAINS —

Description	Part #
Head Gasket	18-3876
2BBL Carb Mounting Gasket	18-0994
4BBL Carb Mounting Gasket	18-0463
4BBL Carb Mounting Gasket	18-0462
Intake Manifold Gasket Set	18-0868
Valve Cover Gasket (2)	18-0664
Valve Stem Seals (8)	18-4024
Valve Stem Seals (16)	18-0518

**CHEVY V-8 350/5.7L
2 Piece Rear Seal
thru 1985**



18-1265 *

SHORT BLOCK GASKET SET

Port Dip Stick Models ONLY
Left Hand (Standard Rotation)

— CONTAINS —

Description	Part #
Oil Pan Gasket	18-0153
Oil Drain Screw Gasket	18-0905
Oil Filter Gasket	18-0185
Forward Crankshaft Seal	18-1213
Rear Crankshaft Seal	18-1211
Water Pump Mounting Gasket	18-0891
Water Pump Plate Gasket	18-0893
Fuel Pump Plate Gasket	18-0876
Fuel Pump Mounting Gasket	18-0889
Timing Chain Cover Gasket	18-0976
Vent Adapter Gasket	NSS

* Except Std Dip Stick models

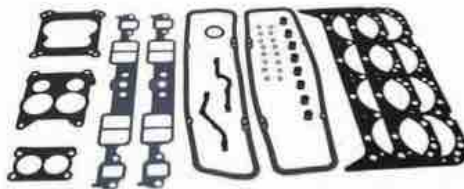

18-1266 ②

HEAD GASKET SET

— CONTAINS —

Description	Part #
Head Gasket	18-3876
2BBL Carb Mounting Gasket	18-0994
4BBL Carb Mounting Gasket	18-0463
4BBL Carb Mounting Gasket	18-0462
Intake Manifold Gasket	18-0868
Valve Cover Gasket (2)	18-2845
Valve Stem Seals (8)	18-4024
Valve Stem Seals (16)	18-0518
Distributor Mounting Gasket	18-0874

**CHEVY V-8 350/5.7L (Right Hand Rotation)
2 Piece Rear Seal
thru 1985**

18-1266 ②

HEAD GASKET SET

— CONTAINS —

Description	Part #
Head Gasket	18-3876
2BBL Carb Mounting Gasket	18-0994
4BBL Carb Mounting Gasket	18-0463
4BBL Carb Mounting Gasket	18-0462
Intake Manifold Gasket	18-0868
Valve Cover Gasket (2)	18-2845
Valve Stem Seals (8)	18-4024
Valve Stem Seals (16)	18-0518

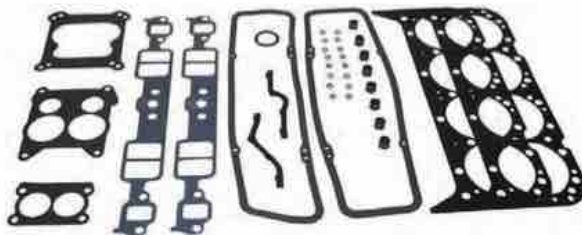

CHEVY V-8 350/5.7L GEN II
1 Piece Rear Seal
1986-1995



18-1267 ②

HEAD GASKET SET

— CONTAINS —

Description	Part #
Head Gasket	18-3876
2BBL Carb Mounting Gasket	18-0994
4BBL Carb Mounting Gasket	18-0463
4BBL Carb Mounting Gasket	18-0462
Intake Manifold Gasket Set	18-0868
Valve Cover Gasket (2)	18-0664
Valve Stem Seals (8)	18-4024
Valve Stem Seals (16)	18-0518
Distributor Mounting Gasket	18-0874

CHEVY V-8 350/5.7L GEN II (Right Hand Rotation)
1 Piece Rear Seal
1986-1995



18-1263 ①

SHORT BLOCK GASKET SET

— CONTAINS —

Description	Part #
Oil Drain Screw Gasket	18-0905
Oil Filter Gasket	18-0185
Forward Crankshaft Seal	18-1213
Rear Main Bearing Gasket	18-0322
Water Pump Mounting Gasket	18-0891
Water Pump Plate Gasket	NSS
Fuel Pump Plate Gasket	18-0876
Fuel Pump Mounting Gasket	18-0889
Timing Chain Cover Gasket	18-0468



18-1267 ②

HEAD GASKET SET

— CONTAINS —

Description	Part #
Head Gasket	18-3876
2BBL Carb Mounting Gasket	18-0994
4BBL Carb Mounting Gasket	18-0463
4BBL Carb Mounting Gasket	18-0462
Intake Manifold Gasket Set	18-0868
Valve Cover Gasket (2)	18-0664
Valve Stem Seals (8)	18-4024
Valve Stem Seals (16)	18-0518
Distributor Mounting Gasket	18-0874

CHEVY V-8 454/7.4L

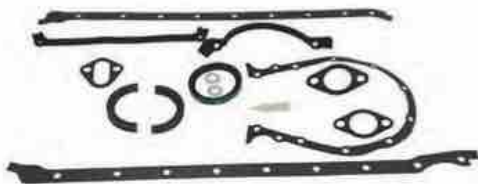

18-1256 *

SHORT BLOCK GASKET SET

— CONTAINS —

Description	Part #
Oil Pan Gasket	18-0348
Oil Drain Screw Gasket	18-0905
Forward Crankshaft Seal	18-1233
Rear Crankshaft Seal	18-0520
Water Pump Mounting Gasket	18-0903
Fuel Pump Mounting Gasket	18-0889
Timing Cover Gasket	18-0980

* Right Hand Rotation
Engines Require

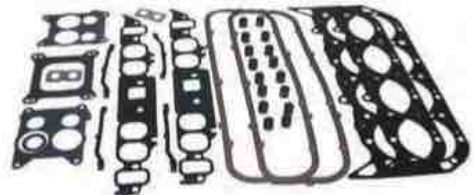

18-1257 ②

VALUE GRIND GASKET SET

— CONTAINS —

Description	Part #
Head Gasket	18-3877
Carb Mounting Gasket	18-0462
Carb Mounting Gasket	18-0463
Carb Mounting Gasket	18-0467
Intake Manifold Gasket Set	18-0465
Valve Cover Gasket (2)	18-0464
Valve Stem Seals (16)	18-0422
Distributor Mounting Gasket	18-0874

① Does not include oil pan gasket

② Does not include intake and/or exhaust manifold gaskets

NSS Not Sold Separately

CHEVY V-8 454/7.4L w/Square Ports

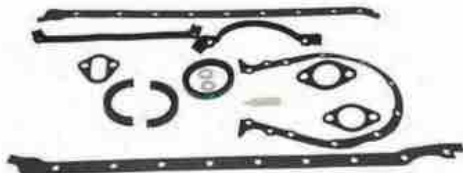

18-1256 *

SHORT BLOCK GASKET SET

— CONTAINS —

Description	Part #
Oil Pan Gasket	18-0348
Oil Drain Screw Gasket	18-0905
Forward Crankshaft Seal	18-1233
Rear Crankshaft Seal	18-0520
Water Pump Mounting Gasket	18-0903
Fuel Pump Mounting Gasket	18-0889
Timing Cover Gasket	18-0980

* Right Hand Rotation
Engines Require



18-1259 ②

HEAD GASKET SET

— CONTAINS —

Description	Part #
Head Gasket	18-3877
Carb Mounting Gasket	18-0467
Carb Mounting Gasket	18-0463
Carb Mounting Gasket	18-0462
Intake Manifold Gasket Set	18-1231
Valve Cover Gasket (2)	18-0464
Valve Stem Seals (16)	18-4024
Distributor Mounting Gasket	18-0874

CHEVY V-8 454/7.4L GEN V
CHEVY V-8 454/7.4L GEN V (w/square ports)
CHEVY V-8 502/8.2L GEN V



18-1261 ①

TIMING CHAIN GASKET SET

— CONTAINS —

Description	Part #
Oil Drain Screw Gasket	18-0905
Forward Crankshaft Seals	18-1233
Rear Crankshaft Seals	18-1234
Water Pump Mounting Gasket	18-0903
Timing Cover Gasket	18-0468



18-1258 ②

VALVE GRIND GASKET SET

— CONTAINS —

Description	Part #
Head Gasket	18-3874
Carb Mounting Gasket	18-0467
Carb Mounting Gasket	18-0463
Carb Mounting Gasket	18-0462
Intake Manifold Gasket Set	NSS
Valve Stem Seals (16)	NSS
Distributor Mounting Gasket	18-0874

CHEVY V-8 502/8.2L



18-1256 *

SHORT BLOCK GASKET SET

— CONTAINS —

Description	Part #
Oil Pan Gasket	18-0348
Oil Drain Screw Gasket	18-0905
Forward Crankshaft Seal	18-1233
Rear Crankshaft Seal	18-0520
Water Pump Mounting Gasket	18-0903
Fuel Pump Mounting Gasket	18-0889
Timing Cover Gasket	18-0980

* Right Hand Rotation
Engines Require



18-1259 ②

HEAD GASKET SET

— CONTAINS —

Description	Part #
Head Gasket	NSS
Carb Mounting Gasket	18-0467
Carb Mounting Gasket	18-0463
Carb Mounting Gasket	18-0462
Intake Manifold Gasket Set	18-1231
Valve Cover Gasket (2)	18-0464
Valve Stem Seals (16)	18-4024
Distributor Mounting Gasket	18-0874

FORD V-8 302/5.0L 1977-93

18-1273 ②

HEAD GASKET SET

— CONTAINS —

Description	Part #
Head Gasket (2)	18-3883
4BBL Carb Mounting Gasket	18-0357
2BBL Carb Mounting Gasket	18-0360
Intake Manifold Gasket Set	18-0410
Valve Cover Gasket (2)	18-0352
Valve Stem Seals (16)	18-4023



FORD V-8 351/5.8L 1977-93

18-1273 ②

HEAD GASKET SET

— CONTAINS —

Description	Part #
Head Gasket (2)	18-3883
4BBL Carb Mounting Gasket	18-0357
2BBL Carb Mounting Gasket	18-0360
Intake Manifold Gasket Set	18-0410
Valve Cover Gasket (2)	18-0352
Valve Stem Seals (16)	18-4023

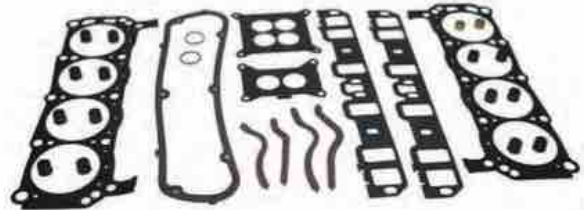

① Does not include oil pan gasket

② Does not include intake and/or exhaust manifold gaskets

NSS Not Sold Separately

MODULAR GASKET APPLICATION

Engine/Model	Years	Serial No.	Short Block	Valve Grind Kit
Chevy 153-2.5L	1965-85	3377341-6229717 ⑤ ②	18-1271	18-1274
Chevy 153/2.5L	1986-88	6229718 & Up ⑤ ②	18-1271	18-1274
Chevy 181/3.0L	1973-84	3332137-6229717 ⑤ ② ③	18-1271	18-1274
Chevy 181/3.0L	1985-96	6229718 & Later ⑤ ② ③	N/A	18-1274
Chevy 181/3.0LX	1990-97	C856559 & Later ① ⑤ ②	N/A	18-1274
Mercuriser 165/3.7L (4 Cyl.)	1987-89	6916779 & Later ⑦ ④	18-1276	18-1277
Mercuriser 170 (4 Cyl.)	1985-86	6916779 & Later ④	18-1276	18-1277
Mercuriser 180/3.7L-LX (4 Cyl.)	1987-89	6916779 & Later ④	18-1276	18-1277
Mercuriser 190 (4 Cyl.)	1985-86	6916779 & Later ④	18-1276	18-1277
Mercuriser 470	1976-82	4208730-6218036 ④	18-1276	18-1277
Mercuriser 470	1983-84	6218037-6916778 ④	18-1276	18-1277
Mercuriser 485	1980-82	5685394-6218036 ④	18-1276	18-1277
Mercuriser 488	1983-84	6170297-6916778 ④	18-1276	18-1277
Chevy 229/3.8L	1983-84	6330183-6919655 ② ⑤	18-1270	18-1275
Chevy L6 250/4.1L	1970-81	2770032-5813433 ⑤	18-1255	18-1264
Chevy 262/4.3L (2Pc. Rm Seal)	1985	6919656-B455459 ⑤	N/A	18-1275
Chevy 262/4.3L (2Pc. Rm Seal)	1986-92	A483581 ① ⑤	18-1270	18-1275

① Full circle rear crankshaft seal, one piece oil pan gasket

② 3.8L models require 18-1211 rear crank seal and 18-0362 oil pan gasket

③ Starboard dip stick models require 18-0411 oil pan gasket set

④ Four piece oil pan set

⑤ Head & valve cover gaskets included in valve grind kit

⑦ Intake/exhaust manifold gasket included in kit

⑧ Rear main crankshaft seal also required

⑨ Crankshaft seals also required

⑩ Models with cast push rod cover require 18-0328

⑪ Crankshaft seals not included in short block kit

⑫ Use 18-4349 for serial no.6218462-B525981

⑬ For models with one piece rear main seal use 18-1206 kit

MODULAR GASKET APPLICATION

Engine/Model	Years	Serial No.	Short Block	Valve Grind Kit
Chevy 262/4.3L Gen II	1992	D714370-F802999 ① ⑤	18-1270	18-1278
Chevy 262/4.3L Gen II	1993-96	D714370-F802999 ① ⑤	18-1270	18-1278
Chevy 305/5.0L	1977-85	4762210-B525981 ③ ⑤	18-1265	18-1266
Chevy 305/5.0L (Rev. Rota.)	1977-85	4762210-B525981 ③ ⑤	—	18-1266
Chevy 305/5.0L (1 Pc. Rm Seal)	1986	A482027-B525981 ① ⑤	18-1258	18-1266
Chevy 305/5.0L (Rev. Rota.) (1 Pc. Rm Seal)	1986	A482027-B525981 ① ⑤	18-1263	18-1266
Chevy 305/5.0L	1987-95	B525982 & Later ① ⑤ ⑧	—	18-1267
Chevy 305/5.0L Inboard	1987-95	B522506 & Later ① ⑤ ⑧	—	18-1267
Chevy 305/5.0L (Rev.Rota) Inboard	1987-95	B522506 & Later ① ⑤	18-1263	18-1267
Chevy 350/5.7L	1975-86	4175500-B525982 ③ ⑤ ⑥	18-1265	18-1266
Chevy 350/5.7 Inboard	1975-86	4498701-B522506 ③ ⑤	18-1265	18-1266
Chevy 350/5.7 (Rev.Rota) Inboard	1975-86	4498701-B522506 ③ ⑤	—	18-1266
Chevy 350/5.7L (1Pc. Rm Seal)	1986	6218462-B522506 ① ⑤	—	18-1266
Chevy 350/5.7L (1Pc. Rm Seal) Inboard	1986	A492879-B522506 ① ⑤	—	18-1266
Chevy 350/5.7L (Rev.Rota)(1 Pc. Rm Seal)	1986	A492879-B522506 ① ⑤	18-1263	18-1266
Chevy 350/5.7L	1987-95	B525982 & Later ① ⑤ ⑧	—	18-1267
Chevy 350/5.7L	1996-97	B525982 & Later ① ⑤ ⑧	—	18-1267
Chevy 350/5.7L Inboard	1987-95	B522506 & Later ① ⑤	18-1263	18-1267
Chevy 350/5.7L Inboard	1996-97	B522506 & Later ① ⑤	18-1263	18-1267
Chevy 350/5.7L (Rev.Rota.) Inboard	1987-95	B522506 & Later ① ⑤	18-1263	18-1267
Chevy 350/5.7L (Rev. Rota.) Inboard	1996-97	B522506 & Later ① ⑤	18-1263	18-1267
Chevy 454/7.4L	1977-92	4623115-D937001 ⑤	18-1256	18-1257
Chevy 454/7.4L Inboard	1977-92	4623110 & Later ⑤	18-1256	18-1257
Chevy 454/7.4L (Rev.Rota.) Inboard	1977-92	4623110 & Later ⑤ ⑥	18-1256	18-1257
Chevy 454/7.4L (Sq. Ports)	1988-91	B721206-D805068 ⑤	18-1256	18-1259
Chevy 454/7.4L Gen V	1992-94	D603118 & Later ⑤	18-1261	18-1258
Chevy 454/7.4L Gen V	1995-97	D603118 & Later ⑤	18-1261	18-1258
Chevy 454/7.4L Gen V Inboard	1992-94	D715494 & Later ⑤	18-1261	18-1258
Chevy 454/7.4L Gen V Inboard	1995-97	D715494 & Later ⑤	18-1261	18-1258
Chevy 454/7.4L Gen V (Sq. Ports)	1992-94	D805069 & Later ⑤	18-1261	—
Chevy 454/7.4L Gen V (Sq. Ports)	1995-97	D805069 & Later ⑤	18-1261	—
Chevy 502/8.2L	1990-92	C84992-F213244 ⑤	18-1256	18-1259
Chevy 502/8.2L Inboard	1990-92	C878221-D857199 ⑤	18-1256	18-1259
Chevy 502/8.2L Gen V	1993-97	D824589 & Later ⑤	18-1261	—
Chevy 502/8.2L Gen V Inboard	1993-97	D857200 & Later ⑤	18-1261	—
Ford 302/5.0L	1971-77	3108723-4887829 ② ⑤	—	18-1273
Ford 351/5.8L	1975-77	4173000-4902304 ④ ⑤	—	18-1273
Ford 351/5.8L (Rev. Rota.)	1975-77	4173000-4902304 ② ⑤ ⑥	—	18-1273

- ① Full circle rear crankshaft seal, one piece oil pan gasket
 ② 3.8L models require 18-1211 rear crank seal and 18-0362 oil pan gasket
 ③ Starboard dip stick models require 18-0411 oil pan gasket set
 ④ Four piece oil pan set
 ⑤ Head & valve cover gaskets included in valve grind kit

- ⑦ Intake/exhaust manifold gasket included in kit
 ⑧ Rear main crankshaft seal also required
 ⑨ Crankshaft seals also required
 ⑩ Models with cast push rod cover require 18-0328
 ⑪ Crankshaft seals not included in short block kit
 ⑫ Use 18-4349 for serial no.6218462-B525981
 ⑬ For models with one piece rear main seal use 18-1206 kit

 <p>18-5982 ALTERNATOR Replaces: Cummins 216040, 3604234RX Fits: Cummins Diesel Marine</p>	 <p>18-6846 ALTERNATOR Replaces: Volvo Penta 1502272, 3803270-2, 5001677, 845940, 72021, 872022, 872757, 873635, 873757, 873757-9, 873771</p>	 <p>18-6849 ALTERNATOR Replaces: Yanmar 119773-77200 Denso 101211-9940 Fits: Yanmar Engines</p>
 <p>18-6925 ALTERNATOR Replaces: Yanmar 128270-77200 Hitachi LR135-105 Fits: Yanmar Marine 3GM Engines</p>	 <p>18-6926 ALTERNATOR Replaces: Yanmar 119836-77200, -2, -3, 129612-77230 Fits: 3TNE84 3cyl diesel, 3TNE88 3cyl diesel, 4TNE84 4cyl, 1.995L, 4TNE88 4cyl, 2.190L</p>	 <p>18-6927 ALTERNATOR Replaces: Yanmar 128171-77200 Fits: Yanmar GM Engines</p>
 <p>18-6928 ALTERNATOR Replaces: Yanmar 128170-77200, 77201, 77202 Hitachi LR135-74, 74B Fits: 3HM, 3HMF models</p>	 <p>18-6929 ALTERNATOR Replaces: Yanmar 119573-77200, 77201, 129470-77200 Hitachi LR180-03A, B, C Fits: Yanmar LH Engines</p>	 <p>18-6952 ALTERNATOR Replaces: Cummins 214169, 3603853RX, 3920618, 10459244 Delco 1100077, 93, 1100211, 74, 1105474, 75, 76</p>
 <p>18-6953 ALTERNATOR Replaces: Volvo 3803645, 8602629, 8602710, 14 8678496, 98, 8678499 Fits: Diesel D3 Models</p>	 <p>18-6955 ALTERNATOR Replaces: Caterpillar 3001117, 10-258 Prestolite 110-258, 110-258A Volvo B49748-9 Fits: Volvo Diesel 6 cylinder models</p>	 <p>18-6970 ALTERNATOR Replaces: Yanmar 129470-77200 Fits: 2GM series, 3HM Series & 4JM engines</p>
 <p>18-6971 ALTERNATOR High Amp version of 18-6970 (120A)</p>	 <p>18-6948 ALTERNATOR Replaces: Mercury 882571 Fits: CMD 1.7 MI 120 V/L4, CMD 1.7 MS 120 V/L4, D1.7L DTI</p>	 <p>18-5975 ALTERNATOR Replaces: Perkins 2871A651 Valeo 2939590, Motorola 9AR3959G, 3855G, 6000G, 510-845, -860, -864 28 Volt 45 AMP For: Perkins Marine Engine: 6-354-4, SAEJ1171</p>



**18-6880
STARTER**
3 Bolt Flange
Replaces: Yanmar 123500-77010,
124610-77010, -77019 424610-77010
Hitachi S114-257, 257G, 483, 483A



**18-6930
STARTER**
Replaces: Yanmar 104211-77010, 77011



**18-6931
STARTER**
Replaces: Yanmar 119209-77010, 121120-77010,
77011, 77012, 124520-77010, 77011
Fits: 3 TNV-84-T engines



**18-6932
STARTER**
Replaces: Yanmar 121370-77010,
129242-77010, 129698-77010
Fits: 2QM, 3JH3, 3JH3E, 3JH3E-YEU, 3QM, 3QM30,
3QM30F, 3QM30H, 4JH3E



**18-6934
STARTER**
2 Bolt Flange
Replaces: Yanmar 129573-77010, 171008-77010
Hitachi S13-68, 68A, 68C, 86
Fits: Engine Model 2TR16, 2TR19



**18-6935
STARTER**
Replaces: Yanmar 119225-77010, 77011,
119226-77010
Fits: 3TN63, 3TN66, 3TN68



**18-6936
STARTER**
Replaces: Yanmar 114361-77011,
114362-77010, 77011, 114399-77010
Fits: L40S, L60S



**18-6937
STARTER**
2 Bolt Flange
Replaces: Yanmar 128170-77010,
77010D Hitachi S114-303, 303A
Fits: GM, GM2, GM3, GM10, GM20/2-
20F, GM30, GMF, 1GM, 2GM, 3GM



**18-6938
STARTER**
Replaces: Yanmar 119773-77010
Fits: 6LP-DTE, 6LP-STE Diesel models



**18-6872
STARTER**
12 Volt
Replaces: Volvo 233991, 240501,
837924, 842775, 843511, 847306-8,
881681
Fits: TAMD, MD, AQD Models



**18-6939
STARTER**
Replaces:
Yanmar 121254-77010, 77011,
77012, 77019, 129429-77010, 77011



**18-6944
STARTER**
Replaces:
Bosch 0-001-109-035
Caterpillar 163-3361
Perkins 185086600
Volvo 21323043, 3583555
Fits: 2001-07 D2-55A, B, C, 2003-07 D2-
75A, 4 cyl 134.2cu in. 2.2L



**18-6947
STARTER**
Replaces:
Mer cruiser 50-805991
Fits: 7.3L (BRAVO & MIE) DIESEL NAV
444 V-8 1994-1996



**18-6870
STARTER**
Replaces: Mercury 50-805833, T
Fits: D7.3L D-tronic 260-LD, 300 1999 year



**18-6949
STARTER**
Replaces:
Mer cruiser 50-831001562,
50-831001961
Fits: WOACTA (150 HP) HINO 234 I/L4,
WO4CTI (210 HP) HINO 234 I/L4



**18-6954
STARTER**
Replaces:
Mercury 50-831001671, 672,
50-831002050, 051, 052
Fits: EH700 (175/220HP) HINO 393 I/L6,
HINO Diesel (See Mer cruiser)



**18-6957
STARTER**
Replaces:
Mer cruiser 50-801333980,
50-854178, 50-855507



**18-6958
STARTER**
24 Volt
Replaces:
Volvo 847308-4, 870998,
881682
Fits: MD, TMD, TAMD Models

CATERPILLAR ALTERNATOR/STARTER APPLICATION

Model	Year	Starter	Alternator	Amps
D2-55 A, B, C	2001-2007	1B-6944	—	—
D2-75 A	2003-2007	1B-6944	—	—

CUMMINS ALTERNATOR/STARTER APPLICATION

Model	Year	Starter	Alternator	Amps
6BT 5.9L	1985-UP	1B-6947	—	—
6C	ALL	—	1B-6952	65
6L8.9	ALL	—	1B-6952	65
C8.3	ALL	—	1B-6952	65
C8.3G	ALL	—	1B-6952	65
CM556	ALL	—	1B-6952	65
C8.3	ALL	—	1B-6952	65
GT48.3 CM558	ALL	—	1B-6952	65
ISC CM2150	ALL	—	1B-6952	65
ISC CM554	ALL	—	1B-6952	65
ISC CM850	ALL	—	1B-6952	65
ISC8.9 CM2250	ALL	—	1B-6952	65
ISL CM2150 SN	ALL	—	1B-6952	65
ISL CM554	ALL	—	1B-6952	65
ISL CM850	ALL	—	1B-6952	65
ISL G CM2250	ALL	—	1B-6952	65
ISL9 CM2250	ALL	—	1B-6952	65
QSC8.3 CM2250	ALL	—	1B-6952	65
QSC8.3 CM554	ALL	—	1B-6952	65
QSC8.3 CM850	ALL	—	1B-6952	65
QSL9 CM2250	ALL	—	1B-6952	65
QSL9 CM554	ALL	—	1B-6952	65
QSL9 CM850	ALL	—	1B-6952	65
QSL9 G CM558	ALL	—	1B-6952	65

MERCURISER ALTERNATOR/STARTER APPLICATION

Model	Year	Starter	Alternator	Amps
530D-TA (Bravo & MIE)	1989-1993	1B-6957	—	—
636D-TA (Bravo & MIE)	1989-1993	1B-6957	—	—
6BTA5.9-M	1989-UP	1B-6947	—	—
7.3L (Bravo & MIE)	1994-1998	1B-6947	—	—
D183 Turbo AC (Bravo & MIE)	1990-1993	1B-6957	—	—
D2.8L D-Tronic (Bravo & MIE)	1997-1999	1B-6957	—	—
D219 Turbo AC (Bravo & MIE)	1990-1993	1B-6957	—	—
D254 Turbo AC (Bravo & MIE)	1990-1993	1B-6957	—	—
D3.0L Bravo	1994-1997	1B-6957	—	—
D3.0L MIE	1994-1995	1B-6957	—	—
D3.6L (Bravo & MIE)	1994-1996	1B-6957	—	—
D3.6L W Bravo (Export)	1996-UP	1B-6957	—	—
D4.2L (Bravo & MIE)	1994-1995	1B-6957	—	—
D4.2L/ 250 D-Tronic	1997-1999	1B-6957	—	—
E1 185	2004-2005	1B-6957	—	—
E1 200	2004-2005	1B-6957	—	—
E1 250	2004-2005	1B-6957	—	—
E1 300	2004-2005	1B-6957	—	—
ES 165	2004-2005	1B-6957	—	—
ES 250	2004-2005	1B-6957	—	—
ES300	2004-2005	1B-6957	—	—
MI 200	2004-2005	1B-6957	—	—
MS 200	2004-2005	1B-6957	—	—
WO4CTA HINO 234 (150HP)	1990-1997	1B-6949	—	—
WO4CTI HINO 234 (210HP)	1990-1997	1B-6949	—	—
WO6DTA HINO 351 (310HP)	1990-1997	1B-6949	—	—
WO6DTI HINO 351 (250HP)	1990-1997	1B-6949	—	—

APPLICATION CONTINUED ON NEXT PAGE

VOLVO ALTERNATOR/STARTER APPLICATION

Model	Year	Starter	Alternator	Amps	Valeo Part No.
2001	1983-1993	—	18-5943	50	—
2002, T	1983-1993	18-6839	18-5943	50	—
2003, T	1983-1993	18-6839	18-5943	50	—
AD290	ALL	—	18-5943	50	—
AD31 A, B, D, L, P, X	1986-2004	—	18-6846	60	—
AD31 A, B, D, L, P, X	1986-2004	—	18-5943	50	—
AD41D	ALL	—	18-5943	50	—
AQAD30A	1983-1986	—	18-5943	50	A13N259
AQAD30A	1983-1986	—	18-59700	50	A13N234
AQAD31A	1986-1989	—	18-5943	50	A13N259
AQAD31A	1986-1989	—	18-59700	50	A13N234
AQAD40A, B	1980-1986	—	18-5943	50	A13N259 OR A13N1M
AQAD40A, B	1980-1986	—	18-59700	50	—
AQAD41	ALL	—	18-5943	50	A13N259
AQAD41	ALL	—	18-59700	50	A13N234
AQAD41A, B, C	1986-1994	—	18-5943	50	A13N259 OR A13N1M
AQAD41A, B, C	1986-1994	—	18-59700	50	A13N234
AQD32A	1969-1977	—	18-5943	50	A13N1M
AQD32A	1969-1977	—	18-59700	50	A13N234
AQD40A, B	1977-1986	—	18-5943	50	A13N259
AQD40A, B	1977-1986	—	18-59700	50	A13N234
AQD41	ALL	—	18-5943	50	A13N259
AQD41	ALL	—	18-59700	50	A13N234
AQD41A	1986-1989	—	18-5943	50	A13N259
AQD41A	1986-1989	—	18-59700	50	A13N234
AQD70B, BL, C, CL, D	1971-1982	18-6872	18-6846	55	—
B21	ALL	—	18-5943	50	A13N2M
B21	ALL	—	18-59700	50	—
B23	ALL	—	18-5943	50	A13N2M
B23	ALL	—	18-59700	50	—
D12-650	2006-2007	—	18-6846	60	—
D12-715	2002-2004	—	18-6846	60	—
D12C	1999-2004	—	18-6846	60	—
D12-MH	2005-2007	—	18-6846	60	—
D2-55A	ALL	—	18-6839	50	—
D25A	ALL	—	18-5959	50	—
D30A	ALL	—	18-5959	50	—
D3-110	2003-2007	—	18-6953	140	—
D3-130	2003-2007	—	18-6953	140	—
D3-160	2003-2007	—	18-6953	140	—
D3-190	2003-2007	—	18-6953	140	—
D41D	ALL	—	18-5943	50	—
D49A	ALL	—	18-5959	50	—
D63	ALL	—	18-5939	50	—
D71, D	ALL	—	18-5939	50	—
D73	ALL	—	18-5939	50	—
KAD32P	1996-2005	—	18-6846	60	—
KAD42A, B, P	1991-2001	—	18-5943	50	A13N259
KAD42A, B, P	1991-2001	—	18-59700	50	A13N234
KAMD42A B, P	1991-1997	—	18-5943	50	A13N259
KAMD42A B, P	1991-1997	—	18-59700	50	A13N234
MD100	ALL	—	18-6846	55	—
MD100A, B	1965-1984	—	18-6846	60	—
MD11	ALL	—	18-59700	50	A13N234

APPLICATION CONTINUED ON NEXT PAGE

VOLVO ALTERNATOR/STARTER APPLICATION

Model	Year	Starter	Alternator	Amps	Valeo Part No.
MD11C	1975-1981	—	18-5943	50	A13N57M OR A13N11M
MD11C	1975-1981	—	18-59700	50	—
MD12B	ALL	—	18-6846	55	—
MD120A	1970-1980	—	18-6846	60	—
MD17	1975-1981	—	18-5943	50	A13N2M
MD17	1975-1981	—	18-59700	50	A13N234
MD17C	1975-1984	—	18-5943	50	A13N2M
MD17C	1975-1984	—	18-59700	50	A13N234
MD17D	1975-1984	—	18-5943	50	A13N147M OR A13N11M
MD17D	1975-1984	—	18-59700	50	A13N234
MD18	ALL	—	18-5943	50	A13N147M
MD18	ALL	—	18-59700	50	—
MD21	1968-1979	—	18-5943	50	A13N147M OR A13N11M
MD21	1968-1979	—	18-59700	50	—
MD21A	1968-1979	—	18-5943	50	A13N11M
MD21A	1968-1979	—	18-59700	50	—
MD2B	1964-1975	—	18-5943	50	A13N11M
MD2B	1964-1975	—	18-59700	50	A13N234
MD2BHY	1964-1975	—	18-5943	50	A13N11M
MD2BHY	1964-1975	—	18-59700	50	—
MD30	1983-1986	—	18-5943	50	A13N147M OR A13N11M
MD30	1983-1986	—	18-59700	50	A13N234
MD30A	1983-1986	—	18-5943	50	A13N259
MD30A	1983-1986	—	18-59700	50	A13N234
MD31A	1986-1994	—	18-5943	50	A13N259
MD31A	1986-1994	—	18-59700	50	—
MD32A	1969-1977	—	18-5943	50	A13N11M
MD32A	1969-1977	—	18-59700	50	A13N234
MD3B	1971-1975	—	18-5943	50	A13N11M
MD3B	1971-1975	—	18-59700	50	A13N234
MD40A	1976-1985	—	18-5943	50	A13N259
MD40A	1976-1985	—	18-59700	50	A13N234
MD42A	1970-1979	18-5872	—	—	—
MD5	ALL	—	18-5943	50	A13N2M OR A13N147M
MD5	ALL	—	18-59700	50	—
MD5A, B, C	1975-1982	—	18-5943	50	A13N11M
MD5A, B, C	1975-1982	—	18-59700	50	—
MD6A	1971-1976	—	18-5943	35	A13N57M
MD6A	1971-1976	—	18-59700	35	A13N234
MD7	ALL	—	18-5943	50	A13N147M OR A13N2M
MD7	ALL	—	18-59700	50	A13N234
MD70B, C	1970-1985	18-6872	—	—	—
MD70B, C	1965-1985	18-6958	18-6846	60	—
MD7A, B	1976-1983	—	18-5943	50	A13N11M OR A13N259
MD7A, B	1976-1983	—	18-59700	50	A13N234
MD11	ALL	—	18-5943	50	A13N2M
TAMD 120	ALL	—	18-6955	120	—
TAMD 120 A, B	1973-1982	—	18-6955	175	—
TAMD 162 A, B, C	1988-2001	—	18-6955	175	—
TAMD102 A, D	1991-2000	—	18-6846	60	—
TAMD103A	2000-2004	—	18-6846	60	—
TAMD120	ALL	—	18-6846	55	—
TAMD120A, B	1972-1983	18-6958	18-6846	60	—
TAMD121 C, D	1983-1988	18-6958	18-6846	60	—

APPLICATION CONTINUED ON NEXT PAGE

VOLVO ALTERNATOR/STARTER APPLICATION

Model	Year	Starter	Alternator	Amps	Valeo Part No.
TAMD121 C, D	1983-1988	18-6958	18-6846	55	—
TAMD122 A, C, D, P	1988-2002	18-6958	18-6846	60	—
TAMD162 A, B, C	1988-2001	—	18-6846	60	—
TAMD163 A, P	1994-2001	—	18-6846	60	—
TAMD163 A, P	1994-2001	—	18-6846	55	—
TAMD165A, C, P	2002-2005	—	18-6846	60	—
TAMD30, A, B, C	1983-1986	—	18-5943	50	A13N1M
TAMD30, A, B, C	1983-1986	—	18-59700	50	A13N234
TAMD31A, B, D, L, M, P, S, X	1985-2004	—	18-5943	50	A13N259
TAMD31A, B, D, L, M, P, S, X	1985-2004	—	18-59700	50	A13N234
TAMD31A, B, D, L, M, P, S, X	1985-2004	—	18-6846	60	—
TAMD40A, B, C	1979-1986	—	18-5943	50	A13N259
TAMD40A, B, C	1979-1986	—	18-59700	50	A13C234
TAMD41A	1986-1989	—	18-5943	50	A13N259 OR A13N1M
TAMD41A	1986-1989	—	18-59700	50	A13N234
TAMD60 A, B, C	1976-1987	18-6872	18-6846	60	—
TAMD61A	1986-1995	18-6872	18-6846	60	—
TAMD62A	1992-1994	18-6872	18-6846	60	—
TAMD63L, P	1994-2005	18-6872	—	—	—
TAMD70	ALL	—	18-5943	50	A13N259
TAMD70	ALL	—	18-59700	50	—
TAMD70	ALL	—	18-6846	55	—
TAMD70B, C, D	1970-1987	18-6872	18-6846	60	—
TAMD70E	1983-1987	—	18-5943	50	A13N1M
TAMD70E	1983-1987	18-6872	18-59700	50	—
TAMD70E	1983-1987	18-6872	18-6846	60	—
TAMD71A, B	1986-2000	18-6872	18-6846	60	—
TAMD72A, P, W, J	1991-1997	18-6872	18-6846	60	—
TAMD73P, W, J	1997-1999	18-6872	18-6846	60	—
TAMD74A, C, L, P	1998-2005	18-6872	18-6846	60	—
TAMD75P	1998-2005	18-6872	18-6846	60	—
THAMD70B, C	1972-1979	18-6872	18-6846	60	—
TMD 100	ALL	—	18-6955	120	—
TMD 100 B, C	1965-1988	—	18-6955	175	—
TMD100A	ALL	—	18-6846	55	—
TMD100B, C	1965-1988	—	18-6846	60	—
TMD102A	1988-2000	—	18-6846	60	—
TMD120	ALL	—	18-6955	120	—
TMD120-A,B	1970-1984	18-6958	18-6955	175	—
TMD120A, B	1970-1984	18-6958	18-6846	60	—
TMD121C	1983-1988	18-6958	18-6846	60	—
TMD122A	1988-2000	18-6958	18-6846	60	—
TMD122A	1988-2000	18-6958	18-6846	55	—
TMD30A, B	1983-1986	—	18-5943	50	A13N147M
TMD30A, B	1983-1986	—	18-59700	50	A13N234
TMD31A, B, D, L	1986-1997	—	18-5943	50	A13N259
TMD31A, B, D, L	1986-1997	—	18-59700	50	A13N234
TMD40	ALL	—	18-5943	50	A13N147M
TMD40	ALL	—	18-59700	50	A13N1M
TMD40A, B, C	1976-1986	—	18-5943	50	A13N259
TMD40A, B, C	1976-1986	—	18-59700	50	A13N234
TMD41A, B, D, L	1986-1997	—	18-5943	50	A13N259
TMD41A, B, D, L	1986-1997	—	18-59700	50	A13N234
TMD70B, C	1972-1985	18-6872	18-6846	60	—

APPLICATION CONTINUED ON NEXT PAGE

YANMAR ALTERNATOR/STARTER APPLICATION

Model	Year	Starter	Alternator	Amps	
1GM	1980-1984	18-6937	18-6925 ⑥	35	
1GM	1980-1984	18-6937	18-6928 ③ ④ ⑤ ⑥	35	
1GM10	1980-1981	18-6937	18-6928	35	
1GM10	1982-UP	18-6937	18-6925 ⑥	35	
1GM10	1982-UP	18-6937	18-6927 ⑥	35	
1GM10C	1982-1984	18-6937	18-6925	35	
1GM10L	1982-UP	—	18-6927 ⑥	35	
1GM10L	1982-UP	—	18-6925 ⑥	35	
1GM10VE	1985-UP	—	18-6927	35	
1GML	1982-UP	—	18-6927	35	
1GML	1982-UP	—	18-6925	35	
1GMY	1982-UP	—	18-6925 ⑥	35	
1GMY	1982-UP	—	18-6927 ⑥	35	
2GM	1980-1984	18-6937	18-6925 ⑥	35	
2GM	1980-1984	18-6937	18-6928 ③ ④ ⑤ ⑥	35	
2GM20	1982-UP	18-6937	18-6925	35	
2GMF	1980-1984	18-6937	18-6925 ⑥	35	
2GMF	1980-1984	—	18-6928 ③ ④ ⑤ ⑥	35	
2GMFL	ALL	—	18-6925	35	
2GMFY(E)-E	ALL	—	18-6925	35	
2GML	ALL	—	18-6925	35	
2GMYE-EC	ALL	—	18-6925	35	
2GMZ	ALL	—	18-6925	35	
2QM15	1977-1980	—	18-6925 ⑥	35	
2QM15	1977-1980	—	18-6928 ③ ④ ⑤ ⑥	35	
2QM20	1975-1980	—	18-6928	35	
2TD	1982-UP	—	18-6925	35	
2TM	1982-UP	—	18-6925	35	
3GM	1980-1984	18-6937	18-6925	35	
3GM	1980-1984	18-6937	18-6928 ③ ④ ⑤ ⑥	35	
3GMD	1982-UP	18-6937	18-6925 ⑥	35	
3GMD	1982-UP	18-6937	18-6928 ③ ④ ⑤ ⑥	35	
3GMF	1982-UP	18-6937	18-6925 ⑥	35	
3GMF	1982-UP	18-6937	18-6928 ③ ④ ⑤ ⑥	35	
3GMFY-E	1982-UP	—	18-6925	35	
3GMLE	1982-UP	—	18-6927	35	
3HM	1980-1984	—	18-6925 ⑥	35	
3HM	1980-1984	—	18-6928 ③ ④ ⑤ ⑥	35	
3HMF	1980-1984	—	18-6925 ⑥	35	
3HMF	1980-1984	—	18-6928 ③ ④ ⑤ ⑥	35	
3JH2	1991-1999	18-6880	18-6925	35	
3JH2	1991-1999	18-6880	18-6929	80	
3JH2BE	1991-1999	18-6880	18-6929	80	
3JH2E	1991-1999	18-6880	18-6929	80	
3JH3	1999-2003	—	18-6925	35	
3JH3	1999-2003	—	18-6929	80	
3JH3E	ALL	—	18-6929	80	
3JH3E-YEU	ALL	18-6880	—	—	
3JH3Z	ALL	—	18-6925	35	
3JH4E	2003-UP	—	18-6929	80	
3TM20	2004-UP	—	18-6929	80	
3YM30	● Hitachi S114-303 ⑤ S/N 3691-Up	① Hitachi S114-483A ④ W/ 2 Pin Regulator Hookup	① Hitachi LR135-105 ⑦ W/O 2 Pin Regulator Hookup	② Hitachi LR135-120 ⑧ W/O Plastic Cover	③ Hitachi LR135-74B ⑧ ④ S/N 3690-Below

APPLICATION CONTINUED ON NEXT PAGE

YANMAR ALTERNATOR/STARTER APPLICATION

Model	Year	Starter	Alternator	Amps
3TN63	1990-UP	18-6935	—	—
3TN66	1985-UP	18-6935	—	—
3TN68	1995-UP	18-6935	—	—
3TNE84	1982-UP	18-6880	18-6926	40
3TNE88	1982-UP	18-6880	18-6926	40
3TNV-84-T	ALL	18-6931	—	—
4GM	1985-UP	—	18-6925	35
4JH	1982-UP	18-6880	18-6925	35
4JH2-CE	1988-UP	18-6880	18-6929	80
4JH2-DTE	1988-UP	18-6880	18-6929	80
4JH2-E	1988-UP	18-6880	18-6929	80
4JH2-HTE	1988-UP	18-6880	18-6929	80
4JH2L-HTNE	1988-UP	18-6880	18-6925	35
4JH2L-TNE	1988-UP	18-6880	18-6925	35
4JH2-TE	1988-UP	18-6880	18-6929	80
4JH2-UTE	1988-UP	18-6880	18-6925	35
4JH3-CE	1994-2003	18-6880	18-6929	80
4JH3-DTE	1994-2003	18-6880	18-6929	80
4JH3E	1994-2003	18-6880	18-6929	80
4JH3-HTE	1994-2003	18-6880	18-6929	80
4JH3-TCE	1994-2003	18-6880	18-6929	80
4JH3-TE	1994-2003	18-6880	18-6929	80
4JH3-TE-YEU	1994-2003	18-6880	—	—
4JH3ZA	1994-2003	18-6880	18-6925	35
4JHE	ALL	—	18-6929	80
4JH-HT	1982-UP	—	18-6925	35
4JH-HT-Z	1982-UP	18-6880	18-6925	35
4JH-T	1982-UP	18-6880	18-6925	35
4JH-TE	1982-UP	—	18-6929	80
4JH-TZ	1982-UP	18-6880	18-6925	35
4JHZ	ALL	18-6880	18-6925	35
4LHA-DTE	ALL	18-6939	18-6929	80
4LHA-DTZ	ALL	18-6939	18-6929	80
4LHA-HTE	ALL	18-6939	18-6929	80
4LHA-HTZE	ALL	18-6939	18-6929	80
4LHA-STE	ALL	18-6939	18-6929	80
4LHA-STZE	ALL	18-6939	18-6929	80
4LH-DTE	1987-UP	18-6939	18-6929	80
4LH-HTE	1987-UP	18-6939	18-6929	80
4LH-STE	1987-UP	18-6939	18-6929	80
4LH-TE	ALL	18-6939	18-6929	80
4TD	1982-UP	—	18-6925	35
4TM	1982-UP	—	18-6925	35
4TNE84	1989-UP	18-6880	18-6926	40
4TNE88	1989-UP	18-6880	18-6926	40
6LP-DT	1997-UP	—	18-6849	80
6LP-DTE	1997-UP	18-6938	18-6849	80
6LP-DTZE	1997-UP	—	18-6849	80
6LP-DTZE1	1997-UP	—	18-6849	80
6LP-DTZY	1997-UP	—	18-6849	80
6LP-ST	1997-UP	—	18-6849	80

Ⓢ Hitachi S114-303 Ⓢ Hitachi S114-483A Ⓢ Hitachi LR135-105 Ⓢ Hitachi LR135-126 Ⓢ Hitachi LR135-74B Ⓢ S/N 3690-Below
 Ⓢ S/N 3691-Up Ⓢ W/ 2 Pin Regulator Hookup Ⓢ W/O 2 Pin Regulator Hookup Ⓢ W/O Plastic Cover

APPLICATION CONTINUED ON NEXT PAGE

YANMAR ALTERNATOR/STARTER APPLICATION

Model	Year	Starter	Alternator	Amps
6LP-STE	1997-UP	18-6938	18-6849	80
6LP-STZE	1997-UP	—	18-6849	80
6LY2-STE	1992-UP	18-6934	18-6929	80
6LYA-STE	1992-UP	18-6934	18-6929	80
6LYA-UTE	1992-UP	18-6934	18-6929	80
6LYM-STE	1992-UP	18-6934	18-6929	80
6LYM-UTE	1992-UP	18-6934	18-6929	80
6LY-ST	1992-UP	18-6934	18-6929	80
6LY-STE	1992-UP	18-6934	18-6929	80
6LY-STM	1992-UP	18-6934	18-6929	80
6LY-STZY	1992-UP	18-6934	18-6929	80
6LY-UT	1992-UP	18-6934	18-6929	80
6LY-UTE	1992-UP	18-6934	18-6929	80
6LY-UTM	1992-UP	18-6934	18-6929	80
6LY-UTZY	1992-UP	18-6934	18-6929	80
KBW-20	ALL	—	18-6929	80
KBW-21	ALL	—	18-6929	80
6PH	1982-UP	18-6934	—	—
6PH-HTZY	1982-UP	18-6934	—	—
6PH-M-HTE	1982-UP	18-6934	—	—
6PHM-HTZ	1982-UP	18-6934	—	—
6PHM-TZ	1982-UP	18-6934	—	—
6PHS-HTPS	1982-UP	18-6934	—	—
6PHS-TPS	1982-UP	18-6934	—	—
KM2A	ALL	18-6937	18-6925 ①	35
KM2A	ALL	18-6937	18-6927 ②	35
KM2C	ALL	18-6937	—	—
KM2P	ALL	18-6937	18-6925 ①	35
KM2P	ALL	18-6937	18-6927 ②	35
KM3A	ALL	18-6937 ●	18-6929	80
KM3A	ALL	18-6880 ●	18-6929	80
KM3P	ALL	18-6937	—	—
KM3V	ALL	18-6937	18-6925 ①	35
KM3V	ALL	18-6937	18-6927 ②	35
KM5A	ALL	18-6939	18-6929	80
L40S	1984-1999	18-6936	—	—
L60S	1984-1999	18-6936	—	—
SB12	1976-1980	18-6930	—	—
SB8	1976-1980	18-6930	—	—
SVE12	1974-1976	18-6930	—	—
SVE8	1974-1976	18-6930	—	—
UJH2E	ALL	18-6880	18-6929	80
Y-5M	ALL	—	18-6925 ①	35
Y-5M	ALL	—	18-6927 ②	35
YC	1971-UP	18-6930	—	—
YSB12	1976-1977	18-6930	—	—
YSB8	1976-1977	18-6930	—	—
YSE12	1974-1976	18-6930	—	—
YSE8	1974-1976	18-6930	—	—
YSM12	1977-1980	18-6930	—	—
YSM8	1977-1980	18-6930	—	—

● Hitachi S114-303 ● Hitachi S114-483A ① Hitachi LR135-105 ② Hitachi LR135-126 ③ Hitachi LR135-74B ④ S/N 3690-Below
 ⑤ S/N 3691-Up ⑥ W/ 2 Pin Regulator Hookup ⑦ W/O 2 Pin Regulator Hookup ⑧ W/O Plastic Cover

DIESEL FUEL FILTERS

20 MICRON



18-7935

Replaces:

Fram CCS 1136

Fram FCS 1136 Filter Bracket

20 MICRON

18-7942

Replaces:

Volvo 466987, 3825133

For: MD100A, TMD100A, MD100B, MD120A, TMD120A, TAMMD120A, MD120B, TMD120B, TAMMD120B, MD70B, TMD70B, TAMMD70B, THAMD70B, AQAD70B, MD70C, TMD70C, TAMMD70C, AQD70C, TAMMD60A, TAMMD60B, TAMMD60C, D5/D7 MARINE GENSET, D5A-T, D5A-1A, D7A-T, D7A-1A, D7C-TA, D83 MARINE, D7173 MARINE, KAD32P, TAMMD42WJ, KAD43P/44P/300, KAMD43P/44P/300, TAMMD103A, TAMMD61A, TAMMD62A, TAMMD71A, TAMMD72A, TAMMD72P, TAMMD72WJ, TAMMD74, TAMMD75 MARINE, TMD102A, TAMMD102A, TAMMD102D, TMD122A, TAMMD122A, TAMMD122P, TMD31L, TAMMD31P/L/M/S, AD31P/L, TMD41L, TAMMD41P/L/M/H



18-79960

FUEL FILTER ELEMENT

Replaces: Yanmar 104500-55710

Fits: All GM Series, YM Series, HM Series, QM Series

20 MICRON



18-7858

Replaces: Volvo 858201

For: CAV Type Unit
For: AQ120B, 125A, B, 131A, 140A, 145A, B, 151, BB, 140, 145A.



18-7873

Replaces:

Mercruiser 35-808275
For models: D7.3/270 Bravo & MIE Diesel Engines (1994-95)



18-8124

Replaces: Volvo 829913

For: 2001, 2001B, 2002, 2002B, 2003, 2003B/TTB, AQD2B, MD11C/D, MD17C/D, MD1B, MD2B, MD3B, MD5A/B/C, MD7/B

20 MICRON



18-7931

Replaces: Detroit Diesel 5574508

FOR: 8V-92, 8V-71



18-8125

Replaces: Volvo 3583443

For: D4-180-B, D4-180-C, D4-210A-A, D4-210A-B, D4-210-A, D4-210-B, D4-225A-B, D4-225A-C, D4-225-B, D4-225-C, D4-260A-A, D4-260A-B, D4-260A-C, D4-260D-B, D4-260D-C, D4-260-A, D4-260-B, D4-260-C, D4-300A-A, D4-300A-C, D4-300D-A, D4-300D-C, D4-300-A, D4-300-C, D6-280A-A, D6-280A-B, D6-280-A, D6-280-B, D6-310A-A, D6-310A-B, D6-310D-A, D6-310D-B, D6-310-A, D6-310-B, D6-330A-B, D6-330A-C, D6-330D-B, D6-330D-C, D6-330-B, D6-330-C, D6-350A-A, D6-350A-B, D6-370A-B, D6-370A-C, D6-370D-A, D6-370D-B, D6-370D-C, D6-370-A, D6-370-B, D6-370-C, D6-435D-A, D6-435D-C, D6-435-A, D6-435-C



18-8126

Replaces: Volvo 861477

For: D1-13 A, D1-13 B, D1-20 A, D1-20 B, D1-30 A, D1-30 B, D2-40 A, D2-40 B, D2-55 A, D2-55 B, D2-55 C, D2-55 D, D2-55 E, D2-55F, D2-75 A, D2-75 B, D2-75 C, D2-75F, MD2010A, MD2010B, MD2020A, MD2020B, MD2030A, MD2030B, MD2040A, MD2040B



18-35443

FUEL PUMP

Replaces: Volvo 3582310

Fits: Volvo D30, D40, D31, D41, D42 Diesel Engines



18-35444

FUEL PUMP

Replaces: Volvo 858459

Fits: Volvo Older D21 and D32 Diesel Engines



18-57703

AIR FILTER

Replaces:

Yanmar 128270-12540

Fits: Yanmar 2GM & 3GM30











18-57704

AIR FILTER

Replaces:

Yanmar 128171-12540

Fits: Yanmar 1GM10

<p>New</p>  <p>18-31605 SEA WATER PUMP Replaces: Yanmar 128397-42500 For: GMF, 2YM3GMF, 3HM, 3HMF, 3YM</p>	 <p>18-8950 IMPELLER Replaces: Yanmar 124223-42092 For: 2GM20F, 2GMF, 2QM, 2QM20, 3GM30F, 3GMF, 3HM, 3HM35, 3HM35F, 3HMF, 3QM30, 3QM30F</p>	 <p>18-8951 IMPELLER Replaces: Yanmar 128176-42071 For: 1GM, 1GM10</p>
 <p>18-8952 IMPELLER Replaces: Yanmar 104211-42071 For: 2GM, 2QM, 3GM, 3QM, YSB8, YSB12, YSM12, SB12 engines</p>	 <p>18-45714 F75B IMPELLER Replaces: Yanmar 119574-42550, 119574-42552 Fits: F75B Pump and 6LY Engines</p>	 <p>18-55500 POWER HEAD GASKET Replaces: Yanmar 728170-92600 For: 1GM (7hp)</p>
 <p>18-55501 POWER HEAD GASKET Replaces: Yanmar 728171-92601 For: 1GM10 (9hp)</p>	 <p>18-55502 POWER HEAD GASKET Replaces: Yanmar 728271-92605 For: 2GM20 (18hp), 2GM20B, 2GM20C, 2GM20F (18hp)</p>	 <p>18-55503 POWER HEAD GASKET Replaces: Yanmar 728374-92605 For: 3GM30 (27hp), 3GM30 EU (27hp), 3GM30F (27hp), 3GM30F EU (27hp)</p>
 <p>18-56000 BONNET COVER GASKET Replaces: Yanmar 128170-11310 For: 1GM, 1GM10</p>	 <p>18-56601 THERMOSTAT GASKET Replaces: Yanmar 104211-49160 For: 1GM, 1GM10</p>	 <p>18-56602 WATER PUMP GASKET Replaces: Yanmar 128170-42090 For: 1GM, 1GM10</p>
 <p>18-55600 HEAD GASKET Replaces: Yanmar 128170-01331 For: 1GM (7hp)</p>	 <p>18-55601 HEAD GASKET Replaces: Yanmar 128171-01911 For: 1GM10 (9hp)</p>	 <p>18-55602 HEAD GASKET Replaces: Yanmar 128271-01911 For: 2GM20 (18hp), 2GM20B, 2GM20C, 2GM20F (18hp)</p>



**18-55603
HEAD GASKET**

Replaces:
Yanmar 128374-01911
For: 3GM30 (27hp), 3GM30
EU (27hp), 3GM30F (27hp),
3GM30F EU (27hp)



**18-6200
ANODE**

Replaces:
Yanmar 27210-200200
Fits: 1GM, 1GM10, 6LY3



**18-6201
ANODE**

Replaces:
Yanmar 27210-200300
Fits: 2GM, 3GM, 2GMF, 3GMF,
2GM20, 3GM30, 3HM, 3HM35,
2QM15, 2QM, 3QM, 2QM20,
3QM30, YSB8, YSB12, YSM8,
YSM12

OIL FILTERS

Sierra oil filters are engineered with premium grade materials that will not only withstand but excel in the extreme environment of the Marine world. Sierra ensures the excellent performance of their filters by:

- Epoxy coating all canisters for corrosion resistance.
- Using a heavy-wall steel canister for further corrosion protection.
- Using high-efficiency filter media that meets or exceeds the OE's filtration.
- Backed by Sierra's industry leading warranty.

DIESEL OIL FILTERS



18-0032
Replaces:
Volvo 847741



18-0033
Replaces:
Volvo 21707133



18-0034
Replaces:
Volvo 477556



18-0035
Replaces:
Volvo 3582732
Full Flow



18-0036
Replaces:
Volvo 3582733
Bypass



18-7871
Replaces:
Mercuriser 35-805809



18-7880
Replaces:
Caterpillar 1R-0658
Volvo-Penta 466634



***18-7884**
Replaces:
Universal 299381
Volvo-Penta 834337
Thread Spec: 3/4" x 16NPT



***18-7886**
Replaces:
Perkins 2654403
Thread Spec: 3/4" x 16NPT

DIESEL OIL FILTERS (Cont.)



***18-7910-1**

Replaces:

Westerbeke 30220
Yanmar 124450-35100, 119350-35150,
119350-35151

Thread Spec: 20mm x 1.5



***18-7917**

Replaces:

Yanmar 124450-35110, 124550-35110, 171056-
35110, 171056-35111, 124085-35113

Thread Spec: 20mm x 1.5



***18-7925**

Replaces:

Westerbeke 21235
Thread Spec: 3/4" x 16NPT



***18-7926**

Replaces:

Volvo 423135, 4785974

Thread Spec: 1" x 12NPT



18-7927

Replaces:

Caterpillar 1R-0714

Thread Spec: 1 1/8" x 16NPT

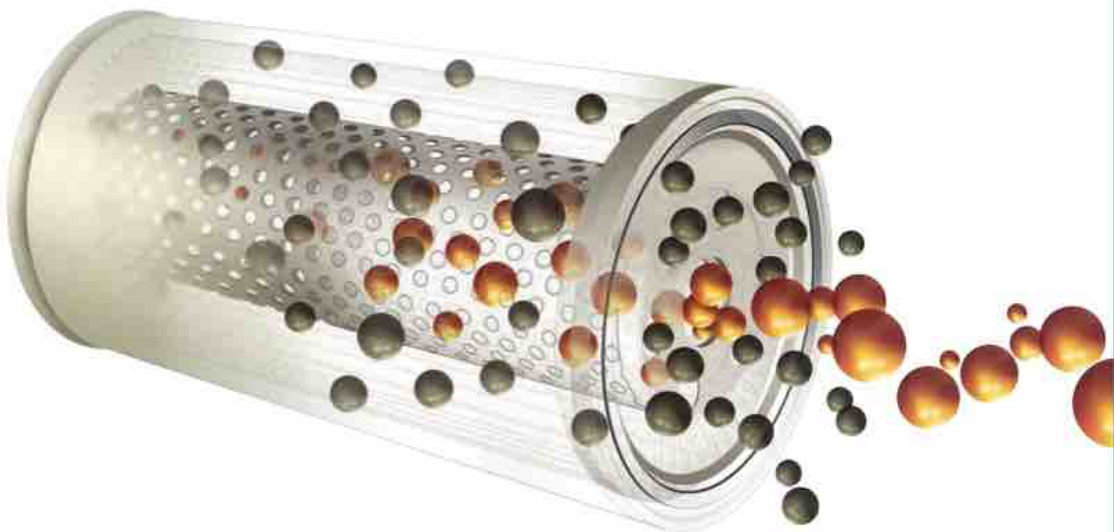

* Anti-Drain-Back Valve

Valve eliminates dry starts, prevents oil from draining back into crankcase during engine shutdown.

SEA RAY

MODEL NO.	S/N	YEAR
3.0L	B787205-B917529	1988
4.3L	B785483-B921276	1988
4.3LX	B785981-B922330	1988
5.7L	B784799-B917017	1988
SRX5.7L, 350 Mag	B785241-B919012	1988
SRX7.4L, 454 Mag Alpha	B785149-B924857	1988
SRX7.4L-H, 454 Mag Bravo	B721206-B919343	1988

STERN DRIVES

MODEL NO.	S/N	YEAR
SRX7.4L, Alpha	B803866-C348032	1988
SRX7.4L-H, Bravo	B803872-B999972	1988

INBOARD ENGINES

MODEL NO.	S/N	YEAR
5.7L	B788204-B919356	1988
7.4L	B788179-B913769	1988

RENAULT 4 CYLINDER (STERN DRIVE)

MODEL	S/N	YEAR
60	1887079-2049044	1965-68
80	2049045-2851423	1966-69
90	2851424-3226957	1970-72

GM 4 CYLINDER (STERN DRIVE)

MODEL	S/N	YEAR
110	1537370-2044033	1963-66
120	1666601-3377340	1964-72
120	3377341-3770649	1972-73
120	3770650-4952700	1974-77
120	4952701-5192048	1978
120	5192049-6229717	1979-82
120	6229718-6853913	1983-84
120	6853914-B531853	1985-86
120(2.5L)	B531854-C853255	1987-89
140	2508261-6229717	1968-82
140(3.0L)	6229718-C856558	1982-89
3.0L/LX	C856559-UP	1990-UP

MERCURY MARINE 4 CYLINDER (STERN DRIVE)

MODEL	S/N	YEAR
470 (2bbl.)	4208730-5520114	1976-79
470 (2bbl.)	5520115-6218036	1980-82
470 (2bbl.)	6218037-6916778	1983-84
170 (2bbl.)	6916779-UP	1985-86
165(3.7L (2bbl.))	6916779-UP	1987-89
485 (2bbl.)	5685394-6218036	1980-82
488 (4bbl.)	6170297-6916778	1983-84
190 (4bbl.)	6916779-UP	1985-86
180(3.7LX (4bbl.))	6916779-UP	1987-89

GM INLINE 6 CYLINDER (STERN DRIVE)

MODEL	S/N	YEAR
140	1538930-1725960	1963
150	1666495-2048046	1964-66
160	2048022-2770031	1967-69
165	2770032-5178958	1970-78
165	5178959-5813433	1979-81
200	2453769-2712072	1969

GM V6 (STERN DRIVE)

MODEL	S/N	YEAR
185 (4bbl.)	6330183-6919655	1983-84
185 (2bbl.)	A331455-B527954	1985-87
175(4.3L (2bbl.))	B527955-D714106	1987-92
4.3L (GEN II)(2bbl.)	D714107-F000877	1992-93
4.3L (GEN II)(2bbl.)	F000878-F601126	1993-95
4.3L (GEN II)(2bbl.)	F601127-F000878	1996
4.3LX (GEN+)(2bbl.)	F803000-K999999	1996-97
4.3L (GEN+)(2bbl.)	L010044-UP	1998-UP
4.3L EFI (GEN+)(TBI)	L012009-UP	1998-UP
205 (4bbl.)	A331455-B527954	1985-87
205(4.3LX (4bbl.))	B527955-D714369	1987-91
4.3LX (GEN II)(4bbl.)	D714370-F001219	1992-93
4.3LX (GEN II)(4bbl.)	F001220-F601126	1993-95
4.3LX (GEN II)(4bbl.)	F601127-F802999	1996
4.3LXH (GEN+)(4bbl.)	F803114-UP	1996-97
4.3LH(GEN+)(4bbl.)	L010044-UP	1998
262 Mag. (TBI)(GEN+)	F803800-K999999	1996-97

FORD V8 (STERN DRIVE)

MODEL	S/N	YEAR
888 (2bbl.)	3108723-4887829	1971-77
215 (4bbl.)	2781153-3385720	1970-72
225 (4bbl.)	3385721-4166999	1973-74

FORD V8 (STERN DRIVE) Cont.

MODEL	S/N	YEAR
225-S (4bbl.)	3385721-4166999	1973-74
233	4173000-4902304	1975-77
255	3258728-4175499	1971-74

GM V8 283, 327, 305 & 350 CID

MODEL	S/N	YEAR
190	1564539-1730903	1963-64
898 (2bbl.)	4762210-6218461	1977-82
898 (2bbl.)	6218462-B525981	1983-84
200(5.0L (2bbl.))	6218462-F600999	1985-95
5.0L (2bbl.)	L015751-UP	1998-UP
5.0L EFI	L012052-L340000	1998-99
228 (4bbl.)	4765100-5170008	1977-78
228 (4bbl.)	5170009-6218461	1979-82
228 (4bbl.)	6218462-B525981	1982-84
230 (4bbl.)	6218462-B525981	1985-86
230(5.0LX (4bbl.))	B525982-F600999	1987-95
225	1539620-2694014	1963-69
250	2314301-2639854	1968-69
255	4175500-4767999	1975-76
250	4768000-4908849	1977
260(5.7L)	4908850-6218461	1978-82
260(5.7L)	621462-B525981	1982-86
260(5.7L)	B525982-F600999	1987-95
5.7L (2bbl.)	F601000-UP	1996-98
5.7L EFI	F225560-UP	1995-UP
5.7LX (4bbl.)	F601000-K999999	1996-97
5.7LX EFI	F752400-K999999	1996-97
5.7LX Bravo EFI	F800300-K999999	1996-97
350 Mag. Alpha	A635178-B525981	1986-87
350 Mag. Alpha	B525982-F600999	1987-95
350 Mag. Alpha	F601000-K001526	1996
350 Mag. Alpha	K001527-K999999	1997
350 Mag. Alpha EFI	F800300-K999999	1996-97
350 Mag. Bravo MPI	F415189-K999999	1995-97
350 Mag. Bravo MPI (GEN +)	F602000-K999999	1996-97
350 Mag. MPI (GEN+)	L010019-UP	1998-UP
270	2851074-3385720	1969-72
280TRS	4176250-4770199	1975-76
300 Tempest	6668677-B430367	1985-86
320 (EFI)	A543604-C622418	1987-89

GM V8 427, 454, 502, 540 & 572 (STERN DRIVE)

MODEL	S/N	YEAR
325	2278747-3780449	1969-72
330	4623115-6083144	1977-81
330	6083145-B816450	1982-87
7.4L Bravo	B771113-D603117	1988-91
7.4L Bravo (Gen.V)	D603118-F800699	1992-96
7.4L Bravo (Gen.VI)	F800700-K999999	1996-97
7.4LX Bravo (MPI)(Gen.V)	F602010-F801999	1996
7.4LX Bravo (MPI)(Gen.VI)	F802000-K999999	1996-97
7.4L MPI (Gen.VI)	L010003-UP	1998
7.4LX Bravo (TBI)(Gen.VI)	F820000-K999999	1996-97
454 Mag. Alpha	A631894-UP	1986-88
454 Mag. Bravo (Gen.V)	D805069-F304999	1992-94
454 Mag. Bravo (Gen.V)	F305000-F801699	1995-96
454 Mag. Bravo (Gen.VI)	F801700-K999999	1996-97
454 EFI (Gen.V)	F115700-F802349	1994-96
454 Mag. MPI (Gen.VI)	F802350-K999999	1996-97
454 Mag. MPI (Gen.VI)	L010029-L085399	1998
454 Mag. MPI (Gen.VI)	L085400-UP	1999-UP
370 TRS	4179554-6721527	1978-85
370 TRS	6721528-B714586	1985-87
400 TRS	4179554-B457644	1980-86
420	A398941-D937011	1987-89
425	A398941-D937011	1990-93
440 TRS	4179554-B485220	1983-86
450 (Gen.V)	F347100-F347277	1995-96
525 SC	D456000-F348963	1991-92
525 SC (Gen.V)	D456000-F348963	1992-95
525 SC (Gen.V)	F615814-F745215	1996
525 SC (Gen.VI)	F745260-UP	1996-97
390	2781129-3042731	1969-70
460 TRS	4719554-6181046	1983-86
465	C849992-F213244	1990-92
465 (Gen.V)	C849992-F213244	1992-94
500 (Gen.V)	F213293-F745159	1994-96

GM V8 427, 454, 502, 540 & 572 (STERN DRIVE) Cont.

MODEL	S/N	YEAR
500 (Gen.VI)	F745195-L001772	1997-98
502 Mag. Bravo	C878221-D824588	1990-92
502 Mag. Bravo (Gen.V)	D824589-F114528	1992-93
502 EFI (Gen.V)	D840650-F802599	1993-96
502 Mag.MPI (Gen.VI)	F802600-K999999	1996-97
500 EFI	L001477-UP	1999-UP
502 Mag.MPI (Gen.VI)	L085433-UP	1998
600 SC	D456489-F877642	1991-92
600 SC (Gen.V)	D456489-F877642	1992-96
600 SC (Gen.VI)	K000227-UP	1997
500 Bulldog	C577254-F745405	1990-96
500 Bulldog	K000248-UP	1997
575	A677429-D763716	1986-92
800 SC (Gen.V)	D763836-UP	1993-96

MCM 4,5,6 & V8 CYLINDER DIESEL STERN DRIVE ENGINE

MODEL	HP	S/N	YEAR
Rover	60	3140000F-UP	1965-67
530 D-TA	150	B993000-B993492	1989
636 D-TA	180	B993500-C696047	1989
D183	140	B993493-D725149	1990-93
D219	170	C696048-D850124	1990-93
D254	200	C849484-D554729	1990-93
D3.0L	140	D725150-UP	1994-UP
D3.6L	170	D850125-UP	1994-UP
D4.2L	200	D554730-UP	1994-UP
D7.3L	238	F060000-UP	1994-UP

MERCURY MARINE MIE 4 CYLINDER (INBOARD)

MODEL	S/N	YEAR
470	5520115-6218036	1980-81

FORD MIE V8 (INBOARD)

MODEL	S/N	YEAR
215	2781153-3563181	1970-72
225	3385721-4176999	1970-72
233	4173000-4775784	1975-76
255	3258728-4178299	1973-74

GM MIE V8 305,327,350 CID (INBOARD)

MODEL	S/N	YEAR
198	4762210-6218461	1977
228	4765100-5170008	1977-78
228	5170009-5907057	1979-80
230/5.0L (4bbl.)	5907058-B788151	1981-87
225	2278647-2694014	1968
250	2314301-2639854	1968-69
255	4175500-5907057	1975-80
260/5.7L	5907058-F024999	1981-93
270	2851074-3077735	1969-72
5.7L	F025000-K999999	1994-97
5.7L (Gen+)	L002003-UP	1998
5.7L MPI	K040300-K999999	1997
350 Mag. MPI (Gen+)	L002008-L304499	1998
350 Mag. MPI (Gen+)	L304500-UP	1999
350 Horizon	L304700-UP	1999-UP
5.7L Ski	A338533-B514626	1985-87
5.7L Competition Ski	B514627-F775199	1987-95
5.7L Competition Ski	F775200-K040003	1996
5.7L Competition Ski	K040004-K999999	1997
5.7L Competition Ski (Gen+)	L002005-UP	1998-UP
350 Mag. Ski	D505450-K999999	1991-97
350 Mag. EFI Ski	F215561-K999999	1994-97
350 Mag. MPI Ski	F350583-F799999	1995-98
Black Scorpion Ski	F800000-UP	1996-98

GM MIE V8 427, 454, 482 & 502 CID (INBOARD)

MODEL	S/N	YEAR
325	2278747-3780449	1968-74
330	4623115-5889913	1977-80
340/7.4L w/B/W MK4	5889914-UP	1981-92
7.4L w/Hurth (LH) MK4	C391564-D715493	1989-92
7.4L (LH)	D715494-K999999	1992-97
7.4L MPI (LH)	F563052-K999999	1995-97
7.4L MPI (L29) Gen VI	L002006-UP	1998
7.4L TBI (LH) Gen VI	F874815-K999999	1996-97
454 Mag. MPI Horizon	L002200-L086049	1998-99
454 EFI (SKJ) (Gen.V)	F215800-F820099	1995-96
454 Mag. MPI (SKJ)(Gen.VI)	F820100-K999999	1996-97
350	9780450-4623109	1974-76
390	2781129-2825059	1969-70
8.2L w/ Hurth	C878221-D857199	1990-92
8.2L (Gen.V)	D857200-F819619	1993-96
8.2L MPI (LH) Gen VI	F819620-K999999	1996-97

GM MIE V8 427, 454, 482 & 502 CID (INBOARD)

MODEL	S/N	YEAR
8.2L MPI (LH) Gen VI	L002450-L0086012	1998
8.2L MPI (LH) Gen VI	L0086013-UP	1999

MIE 5, 6 & V8 CYLINDER DIESEL INBOARD ENGINES

MODEL	HP	S/N	YEAR
530 D-TA	150	B999002-C539258	1989
636 D-TA	180	B993750-C696011	1989
D183	150	C539259-D725149	1990-93
D219	180	C696012-D850124	1990-93
D254	210	C849461-D554729	1990-93
D3.0L	150	D725150-UP	1994-UP
D3.6L	180	D850125-UP	1994-UP
D4.2L	210	D554730-UP	1994-UP
D7.3L	262	F060000-UP	1994-UP

MC 60, 80 & 90 STERN DRIVES & TRANSOM PLATES

MODEL	S/N	YEAR
60 (O)	1830753-2063740	1965-66
80	2063741-2898029	1966-69
90	2898030-3225967	1970-72

MC I, II & III

MODEL	S/N	YEAR
I	1534570-1684187	1963
II (1.33:1)	1474909-2278488	1962-67

MC I, II & III Cont.

MODEL	S/N	YEAR
II (1.78:1)	2398798-2671321	1968-69
III	2373127-3002613	1968-72
III	5128065-UP	1978-UP

MC 1A, 1B & 1C

MODEL	S/N	YEAR
1A, 1B & 1C	1684188-1777798	1964
1A, 1B & 1C (E-Z Shift)	1776349-2065189	1965-66

MC 120, 140, 160 & 165

MODEL	S/N	YEAR
120/140	2062141-378049	1967-73
120/140	3780850-4893634	1974-77
120/140	4893635-6225576	1978-82
160	2065190-2763441	1967-69
165	2763442-3780849	1970-73
165	3780849-4890459	1974-77
165	4890460-6268064	1978-82

MC470 & 485

MODEL	S/N	YEAR
470	4208730-4893834	1976-77
470	4893835-6225576	1978-82
485	5487437-6225576	1980-82

MC 888, 225S & 233

MODEL	S/N	YEAR
888	3106717-3784374	1971-73
888	3784375-4782329	1974-77
225S	3856268-4200499	1974
233	4200500-4782329	1975-77

MC 898, 228, 250 & 260

MODEL	S/N	YEAR
898/228	4782330-4898729	1977
898/228	4898730-6229157	1978-82
250	4791300-4898729	1977
260	4898730-6229157	1978-82

MC R, MR, ALPHA ONE, ALPHA ONE SS & ALPHA ONE GEN II

MODEL	S/N	YEAR
R	6152230-6847029	1983-84
MR	6810538-A479506	1985
Alpha One	A470165-UP	1986-90
Alpha One SS	A545004-UP	1986-89
Alpha One Gen II	D469859-UP	1991-UP

MC BRAVO & BLACKHAWK

MODEL	S/N	YEAR
Bravo One	B664190-UP	1988-UP
Bravo Two	C564952-UP	1989-UP
Bravo Three	D763691-UP	1993-UP
Blackhawk	F186717-UP	1994-UP

MC 215E & 215H

MODEL	S/N	YEAR
215H	2782203-2909034	1970
215E	2782203-2909034	1970-72

MC TR & TRS

MODEL	S/N	YEAR
TR	3377316-3787239	1973
TR	3787240-4794899	1974-76
TR	4794900-5009866	1977
TR	5009867-UP	1978-UP
TRS	3787240-4203749	1974-75
TRS	4203750-4795399	1976
TRS	4795400-UP	1977-UP



**18-5291
TUNE-UP KIT**

Replaces: 808483K2
GM V-8 engines w/Delco HEI-1998 and newer
(except MPI engines with 555 ECM)
Includes 18-5354 cap & 18-5402 rotor



**18-5246
TUNE-UP KIT**

Replaces: 898253T28
For: Late model V-6, 4.3L (Alpha/Bravo)



**18-5247
TUNE-UP KIT**

Replaces: 898253T29, 8M0061335, 8M0060495
For: Late model V-8 (Alpha/Bravo 350
Mag, 5.0L & MX 6.2L)



① 18-5250D Display Package

**18-5250
TUNE-UP KIT**

Replaces: 34235T1, 34235Q1

—CONTAINS—		
Part #	O.E. #	Description
18-5311	34235	Contact Set
18-5345	33662	Condenser
18-5418	58217	Rotor

Delco 4 & 6 cyl.



① 18-5251D Display Package

**18-5251
TUNE-UP KIT**

—CONTAINS—		
Part #	O.E. #	Description
18-5314	391-5090	Contact Set
18-5338	391-5092	Condenser
18-5404-1	391-7057	Rotor

Mallory 8 cyl. Tall Cap



**18-5252
TUNE-UP KIT**

—CONTAINS—		
Part #	O.E. #	Description
18-5310		Contact Set
18-5344		Condenser
-		Rotor

Delco 8 cyl.



**18-5253
TUNE-UP KIT**

—CONTAINS—		
Part #	O.E. #	Description
18-5318	58033	Contact Set
18-5346	58034, 81-64851	Condenser
18-5420	65864	Rotor

Autolite 8 cyl.



① 18-5254D Display Package

**18-5254
TUNE-UP KIT**

—CONTAINS—		
Part #	O.E. #	Description
18-5317	64850, 87-71831	Contact Set
18-5346	58034, 81-64851	Condenser
18-5420	65864, 78016	Rotor

Mercury 8 cyl.



① 18-5258D Display Package

**18-5258
TUNE-UP KIT**

—CONTAINS—		
Part #	O.E. #	Description
18-5303	392-6325	Contact Set
18-5347	392-6324	Condenser
18-5407	392-6326	Rotor

Prestolite 8 cyl.



① 18-5260D Display Package

**18-5260
TUNE-UP KIT**

—CONTAINS—		
Part #	O.E. #	Description
18-5303	392-6325	Contact Set
18-5345	392-6324	Condenser
18-5403	392-9767	Rotor

Prestolite 8 cyl.



**18-5266
TUNE-UP KIT**

Fits: Flame Thrower Distributors 18-5481, 18-5482,
18-5483, 18-5477, 18-5478 and 18-5479
Includes 18-5300 rotor



① 18-5267D Display Package

**18-5267
TUNE-UP KIT**

—CONTAINS—		
Part #	O.E. #	Description
18-5318	58033	Contact Set
18-5346	58034, 81-64851	Condenser
18-5420	65864, 78016	Rotor
18-5389	393-4988T	Distributor Cap

Autolite V-8 - Single Point



**18-5268
TUNE-UP KIT**

—CONTAINS—		
Part #	O.E. #	Description
18-5311	34235	Contact Set
18-5345	33662	Condenser
18-5418	58217	Rotor
18-5385	393-9459	Distributor Cap

Delco In-Line 4 - Single Point





















① 18-5269D Display Package

**18-5269
TUNE-UP KIT**

—CONTAINS—		
Part #	O.E. #	Description
18-5311	34235	Contact Set
18-5345	33662	Condenser
18-5418	58217	Rotor
18-5386	33765	Distributor Cap

Delco In-Line 6 - Single Point

① Items ending in "D" are Display Packaged - Regular number is Non-Display

 <p>18-5271 TUNE-UP KIT</p> <p>—CONTAINS—</p> <table border="1"> <thead> <tr> <th>Part #</th> <th>O.E. #</th> <th>Description</th> </tr> </thead> <tbody> <tr> <td>18-5314</td> <td>391-5090</td> <td>Contact Set</td> </tr> <tr> <td>18-5338</td> <td>391-5092</td> <td>Condenser</td> </tr> <tr> <td>18-5404-1</td> <td>391-7057, 391-5088</td> <td>Rotor</td> </tr> <tr> <td>18-5378</td> <td>391-5075</td> <td>Distributor Cap</td> </tr> </tbody> </table> <p>Mallory V-8 - Single Point - Top Terminal</p>	Part #	O.E. #	Description	18-5314	391-5090	Contact Set	18-5338	391-5092	Condenser	18-5404-1	391-7057, 391-5088	Rotor	18-5378	391-5075	Distributor Cap	 <p>18-5273 TUNE-UP KIT</p> <p>—CONTAINS—</p> <p>Replaces: 805759T3 / 805759Q3</p> <table border="1"> <thead> <tr> <th>Part #</th> <th>O.E. #</th> <th>Description</th> </tr> </thead> <tbody> <tr> <td>18-5431</td> <td>13524A5</td> <td>Rotor</td> </tr> <tr> <td>18-5395</td> <td>16457A4</td> <td>Distributor Cap</td> </tr> </tbody> </table> <p>Mercury Thunderbolt HEI - V-8</p>	Part #	O.E. #	Description	18-5431	13524A5	Rotor	18-5395	16457A4	Distributor Cap	 <p>18-5274 TUNE-UP KIT</p> <p>—CONTAINS—</p> <table border="1"> <thead> <tr> <th>Part #</th> <th>O.E. #</th> <th>Description</th> </tr> </thead> <tbody> <tr> <td>18-5432</td> <td>13524A6</td> <td>Rotor</td> </tr> <tr> <td>18-5396</td> <td>13753A2</td> <td>Distributor Cap</td> </tr> </tbody> </table> <p>Mercury Thunderbolt HEI - V-6</p>	Part #	O.E. #	Description	18-5432	13524A6	Rotor	18-5396	13753A2	Distributor Cap												
Part #	O.E. #	Description																																													
18-5314	391-5090	Contact Set																																													
18-5338	391-5092	Condenser																																													
18-5404-1	391-7057, 391-5088	Rotor																																													
18-5378	391-5075	Distributor Cap																																													
Part #	O.E. #	Description																																													
18-5431	13524A5	Rotor																																													
18-5395	16457A4	Distributor Cap																																													
Part #	O.E. #	Description																																													
18-5432	13524A6	Rotor																																													
18-5396	13753A2	Distributor Cap																																													
 <p>18-5275 TUNE-UP KIT</p> <p>—CONTAINS—</p> <table border="1"> <thead> <tr> <th>Part #</th> <th>O.E. #</th> <th>Description</th> </tr> </thead> <tbody> <tr> <td>18-5303</td> <td>392-6325</td> <td>Contact Set</td> </tr> <tr> <td>18-5347</td> <td>392-6324</td> <td>Condenser</td> </tr> <tr> <td>18-5403</td> <td>392-9089</td> <td>Rotor</td> </tr> <tr> <td>18-5352</td> <td>392-9766</td> <td>Distributor Cap</td> </tr> </tbody> </table> <p>Prestolite V-8 - Single Point - Screw Cap</p>	Part #	O.E. #	Description	18-5303	392-6325	Contact Set	18-5347	392-6324	Condenser	18-5403	392-9089	Rotor	18-5352	392-9766	Distributor Cap	 <p>18-5276 TUNE-UP KIT</p> <p>—CONTAINS—</p> <table border="1"> <thead> <tr> <th>Part #</th> <th>O.E. #</th> <th>Description</th> </tr> </thead> <tbody> <tr> <td>18-5303</td> <td>392-6325</td> <td>Contact Set</td> </tr> <tr> <td>18-5347</td> <td>392-6324</td> <td>Condenser</td> </tr> <tr> <td>18-5403</td> <td>392-9089</td> <td>Rotor</td> </tr> <tr> <td>18-5353</td> <td>392-9066</td> <td>Distributor Cap</td> </tr> </tbody> </table> <p>Prestolite V-6 - Single Point - Screw Cap</p>	Part #	O.E. #	Description	18-5303	392-6325	Contact Set	18-5347	392-6324	Condenser	18-5403	392-9089	Rotor	18-5353	392-9066	Distributor Cap	 <p>18-5277 TUNE-UP KIT</p> <p>—CONTAINS—</p> <table border="1"> <thead> <tr> <th>Part #</th> <th>O.E. #</th> <th>Description</th> </tr> </thead> <tbody> <tr> <td>18-5303</td> <td>392-6325</td> <td>Contact Set</td> </tr> <tr> <td>18-5347</td> <td>392-6324</td> <td>Condenser</td> </tr> <tr> <td>18-5407</td> <td>392-6326</td> <td>Rotor</td> </tr> <tr> <td>18-5369</td> <td>392-6318</td> <td>Distributor Cap</td> </tr> </tbody> </table> <p>Prestolite V-8 - Single Point - Clip Cap</p>	Part #	O.E. #	Description	18-5303	392-6325	Contact Set	18-5347	392-6324	Condenser	18-5407	392-6326	Rotor	18-5369	392-6318	Distributor Cap
Part #	O.E. #	Description																																													
18-5303	392-6325	Contact Set																																													
18-5347	392-6324	Condenser																																													
18-5403	392-9089	Rotor																																													
18-5352	392-9766	Distributor Cap																																													
Part #	O.E. #	Description																																													
18-5303	392-6325	Contact Set																																													
18-5347	392-6324	Condenser																																													
18-5403	392-9089	Rotor																																													
18-5353	392-9066	Distributor Cap																																													
Part #	O.E. #	Description																																													
18-5303	392-6325	Contact Set																																													
18-5347	392-6324	Condenser																																													
18-5407	392-6326	Rotor																																													
18-5369	392-6318	Distributor Cap																																													
 <p>18-5278 TUNE-UP KIT</p> <p>Replaces: 850484T3 Delco EST - V-6</p> <p>—CONTAINS—</p> <table border="1"> <thead> <tr> <th>Part #</th> <th>Description</th> <th>O.E. #</th> </tr> </thead> <tbody> <tr> <td>18-5362</td> <td>Distributor Cap</td> <td>850484</td> </tr> <tr> <td>18-5408</td> <td>Rotor</td> <td>850485</td> </tr> </tbody> </table>	Part #	Description	O.E. #	18-5362	Distributor Cap	850484	18-5408	Rotor	850485	 <p>18-5280 TUNE-UP KIT</p> <p>Replaces: 811635Q2 Delco EST - In-Line 4</p> <p>—CONTAINS—</p> <table border="1"> <thead> <tr> <th>Part #</th> <th>Description</th> <th>O.E. #</th> <th>Qty.</th> </tr> </thead> <tbody> <tr> <td>18-5361</td> <td>Distributor Cap</td> <td>811635, T3</td> <td>1</td> </tr> <tr> <td>18-5406</td> <td>Rotor</td> <td>811636, 1</td> <td>1</td> </tr> </tbody> </table>	Part #	Description	O.E. #	Qty.	18-5361	Distributor Cap	811635, T3	1	18-5406	Rotor	811636, 1	1	 <p>18-5281 TUNE-UP KIT</p> <p>Replaces: 808483Q2 Delco EST - V-8</p> <p>—CONTAINS—</p> <table border="1"> <thead> <tr> <th>Part #</th> <th>Description</th> <th>O.E. #</th> <th>Qty.</th> </tr> </thead> <tbody> <tr> <td>18-5354</td> <td>Distributor Cap</td> <td>808483, 1</td> <td>1</td> </tr> <tr> <td>18-5405</td> <td>Rotor</td> <td>808484, 1, 898253010</td> <td>1</td> </tr> </tbody> </table>	Part #	Description	O.E. #	Qty.	18-5354	Distributor Cap	808483, 1	1	18-5405	Rotor	808484, 1, 898253010	1												
Part #	Description	O.E. #																																													
18-5362	Distributor Cap	850484																																													
18-5408	Rotor	850485																																													
Part #	Description	O.E. #	Qty.																																												
18-5361	Distributor Cap	811635, T3	1																																												
18-5406	Rotor	811636, 1	1																																												
Part #	Description	O.E. #	Qty.																																												
18-5354	Distributor Cap	808483, 1	1																																												
18-5405	Rotor	808484, 1, 898253010	1																																												
 <p>18-5282 TUNE-UP KIT</p> <p>Holley, Mercury Marine - Single Point V-8</p> <p>—CONTAINS—</p> <table border="1"> <thead> <tr> <th>Part #</th> <th>Description</th> <th>O.E. #</th> </tr> </thead> <tbody> <tr> <td>18-5389</td> <td>Dist. Cap</td> <td>393-498RT, 2</td> </tr> <tr> <td>18-5420</td> <td>Rotor</td> <td>65864, 78018</td> </tr> <tr> <td>18-5317</td> <td>Contact Set</td> <td>64850, 87-71831</td> </tr> <tr> <td>18-5346</td> <td>Condenser</td> <td>58034, 81-64851</td> </tr> </tbody> </table>	Part #	Description	O.E. #	18-5389	Dist. Cap	393-498RT, 2	18-5420	Rotor	65864, 78018	18-5317	Contact Set	64850, 87-71831	18-5346	Condenser	58034, 81-64851	 <p>18-5283 TUNE-UP KIT</p> <p>For: Mallory Single Point In-Line 4</p> <p>—CONTAINS—</p> <table border="1"> <thead> <tr> <th>Part #</th> <th>Description</th> <th>O.E. #</th> </tr> </thead> <tbody> <tr> <td>18-5397</td> <td>Distributor Cap -</td> <td></td> </tr> <tr> <td>18-5404-1</td> <td>Rotor</td> <td>391-7057</td> </tr> <tr> <td>18-5314</td> <td>Contact Set</td> <td>391-5090</td> </tr> <tr> <td>18-5338</td> <td>Condenser</td> <td>391-5092</td> </tr> </tbody> </table>	Part #	Description	O.E. #	18-5397	Distributor Cap -		18-5404-1	Rotor	391-7057	18-5314	Contact Set	391-5090	18-5338	Condenser	391-5092	 <p>18-5301 TUNE-UP KIT</p> <p>Fits: Male cap v-8 flamethrower distributors</p>	 <p>18-5302 TUNE-UP KIT</p> <p>Fits: Male cap v-8 flamethrower distributors</p>	 <p>18-5303 CONTACT SET</p> <p>Replaces: 392-898253005, 392-6325, 8M6001219, F16900031</p>													
Part #	Description	O.E. #																																													
18-5389	Dist. Cap	393-498RT, 2																																													
18-5420	Rotor	65864, 78018																																													
18-5317	Contact Set	64850, 87-71831																																													
18-5346	Condenser	58034, 81-64851																																													
Part #	Description	O.E. #																																													
18-5397	Distributor Cap -																																														
18-5404-1	Rotor	391-7057																																													
18-5314	Contact Set	391-5090																																													
18-5338	Condenser	391-5092																																													
 <p>18-5310 CONTACT SET</p> <p>Replaces: 33700</p>	 <p>18-5311 CONTACT SET</p> <p>Replaces: 34235, 34235T</p>	 <p>18-5314 CONTACT SET</p> <p>Replaces: 391-5090, 391-898253004, 8M6001250</p>	 <p>18-5317 CONTACT SET</p> <p>Replaces: 64850, 87-71831</p>	 <p>18-5318 CONTACT SET</p> <p>Replaces: 58033, 898253007</p>																																											



**18-5338
CONDENSER**
Replaces: 391-5092,
391-898253001, 391-5093,
391-5092, 8M6001217,
F16900040



**18-5344
CONDENSER**
Replaces: 33706



**18-5345
CONDENSER**
Replaces: 33662,
898253003, 898253005,
33662Q, 6325, 8M6001218,
F16900031



**18-5346
CONDENSER**
Replaces: 58034,
81-64851



**18-5347
CONDENSER**
Replaces: 392-6324,
392-898253002, 8M6001249,
F16900023, F16900032,
F16900083, F16900189



**18-5402
ROTOR**
Replaces: 898253009
GM V-8 engines w/Delco HEI-
1998 and newer (except MPI
engines with 555 ECM)



**18-5245
ROTOR**
Replaces: 884790,
898253013
For: Late model V-6, V-8 (Alpha/
Bravo 350 Mag, 5.0L, & MX 6.2L)



**18-5403
ROTOR**
Replaces: 392-9089,
392-9089T, 392-9767, 392-
9089Q, F16900186
F16900190



**18-5404-1
ROTOR**
Replaces: 391-7057,
391-5086, 391-7057T, 391-
898253029, 8M6001224,
F16901224



**18-5405
ROTOR**
Replaces: 808484,
808484 1, 898253010
Use with 18-5354 Distributor Cap
Fits new GM style "Module in
Cap" distributors - V-6 application



**18-5406
ROTOR**
Replaces: 811636,
811636 1, 898253011
Use with 18-5361 Distributor Cap
3.0L LX



**18-5407
ROTOR**
Replaces: 392-6326,
392-6326T, F16900044



**18-5300
ROTOR**
Replaces: 33707
Fits: Flamethrower Distributors



**18-5408
ROTOR**
Replaces: 850485,
8504851, 898253012,
8M0062084, 804424
Use with 18-5362 Distributor Cap
Fits new GM Style "Module in
Cap" Distributors V6 Applications



**18-5418
ROTOR**
Replaces: 58217,
898253008, 58217Q



**18-5420
ROTOR**
Replaces: 65864, 78016



18-5431D 
ROTOR ASSEMBLY
Replaces: 13524A5, T1
V-8



**18-5432
ROTOR ASSEMBLY**
Replaces: 13524A6,
13524Q06, 13524A4,
19405A4, 90576A4
V-6



**18-5243
DISTRIBUTOR CAP**
Replaces: 888731,
898253T23
For: Late model V-6 (4.3L Alpha/
Bravo)



**18-5244
DISTRIBUTOR CAP**
Replaces: 884792,
898253T22
For: Late model V-8 (Alpha/Bravo
350 Mag, 5.0L, & MX 6.2L)



**18-5352
DISTRIBUTOR CAP**
Replaces: 392-9768,
392-9766Q1, 392-9766T,
F16900185
Prestolite



**18-5353
DISTRIBUTOR CAP**
Replaces: 392-9086,
392-9086T



**18-5354
DISTRIBUTOR CAP**
Replaces: 808483,
808483T3, 804483T
8044 18
Fits new GM style "Module in
Cap" Distributors—V-8
applications. Use 18-5405 Rotor.



**18-5361
DISTRIBUTOR CAP**
Replaces: 811635, 811635T3
Use 18-5406 Rotor
3.0L LX



**18-5362
DISTRIBUTOR CAP**
Replaces: 850484, 850484T,
850484T2
Fits new GM Style "Module in
Cap" Distributors—V6
Applications Use 18-5408 Rotor

 <p>18-5369 DISTRIBUTOR CAP Replaces: 392-6318, 392-6318T, F16900184 Prestolite with gasket 18-5399</p>	 <p>18-5376 DISTRIBUTOR CAP Replaces: 391-5075, 391-5075Q1, F16900148 Mallory</p>	 <p>18-5384 DISTRIBUTOR CAP Replaces: 33708</p>	 <p>18-5385 DISTRIBUTOR CAP Replaces: 393-9459, 393-9459Q1, 393-9459T, 33667, F16900052</p>
 <p>18-5386 DISTRIBUTOR CAP Replaces: 33765, 33765T</p>	 <p>18-5389 DISTRIBUTOR CAP Replaces: 393-4988T, 393-4988T2, 393-4988, 393-3230</p>	 <p>18-5395 DISTRIBUTOR CAP Replaces: 16457A4, 805759T2, 805759T1, 805759A5, 805759A2, 805759A1, 90746A1, 43557A1, 43557 V-8</p>	 <p>18-5396 DISTRIBUTOR CAP Replaces: 13753A2, 815407A2 V-6</p>
 <p>18-5397 DISTRIBUTOR CAP Replaces: Mallory 9-29418 Fits: Ford 2.3L w/Mallory Distributor (87-90)</p>	 <p>18-5473 DISTRIBUTOR CAP Black Distributor Cap with Male Terminals for Flamethrower Distributors</p>	 <p>18-5474 DISTRIBUTOR CAP Red Distributor Cap with Male Terminals for Flamethrower Distributors</p>	<p>PKG OF 2</p>  <p>18-5399 18-5399-9① DISTRIBUTOR CAP GASKET Replaces: 392-6329</p>

FEATURES

- Oil filled for better cooling and long life
- Low resistance and improved turn ratio produces the higher voltage needed to run larger spark plug gaps for added power and better fuel economy
- More windings maximize energy and reliability over the full RPM range
- Fits existing brackets for easy installation

 <p>18-5466 HI-PERFORMANCE IGNITION COIL 1.5 ohm (oil filled), black - 8 cylinder- Flame-Thrower 40,000 volt coil.</p> <ul style="list-style-type: none"> • Designed for use with the original Ignitor Electronic Conversion Kits • Can be used with other inductive ignition systems 	 <p>18-5469 HI-PERFORMANCE IGNITION COIL 3.0 ohm (oil filled), black - 4 & 6 cylinder- Flame-Thrower 40,000 volt coil.</p> <ul style="list-style-type: none"> • Designed for use with the original Ignitor Electronic Conversion Kits • Can be used with other inductive ignition systems 	 <p>18-5472 HI-PERFORMANCE IGNITION COIL 0.6 ohm (oil filled), black - 4, 6, & 8 cylinder-Flame-Thrower 45,000 volt coil.</p> <ul style="list-style-type: none"> • Super low 0.6 ohm resistance coil designed for use with the Ignitor II Hi Performance Electronic Conversion Kits • Compatible with capacitive discharge systems
---	---	--

Part No.	Description	Recommended Coil	Resistance Ohms	Part No.	Description	Recommended Coil	Resistance Ohms
18-5294	Electronic Conversion Kit	18-5469	3	18-5288	Hi Performance Electronic Conversion Kit	18-5472	0.6
18-5295	Electronic Conversion Kit	18-5469	3	18-5289	Hi Performance Electronic Conversion Kit	18-5472	0.6
18-5296-2	Electronic Conversion Kit	18-5466	1.5	18-5290	Hi Performance Electronic Conversion Kit	18-5472	0.6
18-5297	Electronic Conversion Kit	18-5469	3	18-5481	Flame-Thrower Distributor	18-5472	0.6
18-5298	Electronic Conversion Kit	18-5466	1.5	18-5482	Flame-Thrower Distributor	18-5472	0.6
18-5299	Electronic Conversion Kit	18-5466	1.5	18-5483	Flame-Thrower Distributor	18-5472	0.6
18-5285	Hi Performance Electronic Conversion Kit	18-5472	0.6				

① Priced per Package

CAP APPLICATION BEGINS ON PAGE 704



18-5433
IGNITION COIL
Replaces: 38547, 32193A2,
392-806529A1, 898253T24
DELCO 1115202
(Uses External Resistor)

Display Package



18-5438
IGNITION COIL
Replaces: 392-7803A4,
392-805570A2
HEI
Thunderbolt Ignition



18-5465
IGNITION COIL
Replaces: 392-863704T,
8M0054588
2001 and newer 4.3L, 5.0L, 5.7L
& 6.2L with 535 ECM (OM300000
and up)



18-7493
COIL
Replaces: 392889925
For: 8.1L & 496 Mag OM915053
& UP



18-7648
IGNITION COIL
Replaces: 392-881732



18-5442
IGNITION COIL
Replaces: 806673T, T1



18-5443
IGNITION COIL
Replaces: 817378T,
817378, 898253T27



18-5117
IGNITION MODULE
Replaces: GM 10482803
Fits: MCM MIE 4.3L MPI, 5.0L
MPI, 350 Mag MPI and MX 6.2L
MPI engines with ECM555 (2001 &
Up) S/N OM300000 & Up



18-5107-1
IGNITION MODULE
4/6/8 cyl.
Replaces: 811637001,
811637002, 811637T,
811637, 850487, 804412,
802464
Delco EST



18-5488
IGNITION MODULE
Replacement module for
Mallory electronic distributors



18-5108
PICK-UP
COIL SENSOR
Replaces: 811639, T
V4/V6/V8
Delco EST



18-5116-1
IGNITION SENSOR KIT
Replaces: 87-861780A2, Q4,
87-892150A02
For: V-6 & V-8 with Thunderbolt
ignition (1981-1997) nut connectors



18-7556
CRANKSHAFT SENSOR
Replaces: 864297001
Fits: Mercury 5.0L, 6.2L, 1998-2010



18-7642
PICK-UP ASSEMBLY
Replaces: 898141
Fits: Engines equipped w/
Delco HVS distributor



18-26810
GM HEI 4 TERMINAL
PIGTAIL
Fits: GM HEI Distributors w/4
terminals



18-26811
GM HEI 2 TERMINAL
PIGTAIL
Fits: GM HEI Distributors w/2
terminals



18-26812
HEI COIL GRAY
CONNECTOR



18-26813
HEI COIL BLACK
CONNECTOR



18-61051
SCREW KIT (4 PER PKG)
Fits: Mercruiser V6 & V8 Thunderbolt
Distributor Caps

Ignitor® II
ELECTRONIC IGNITION

FEATURES

- Senses current levels in the coil & adjusts the dwell to maintain peak energy throughout entire RPM range.
- Develops, on average, 4 times more available energy between 3000 and 5000 RPM's and twice as much plug voltage as point-type systems.
- Ignition energy is sustained and coil life is increased when peak current level is reached just prior to spark.
- More stable timing.
- Use with 18-5472 "Flame Thrower II" Coil for optimum performance

18-5285
HI-PERFORMANCE
ELECTRONIC
CONVERSION KIT
 Fits: 4 Cylinder Delco Distributors



18-5288
HI-PERFORMANCE
ELECTRONIC CONVERSION KIT
 Fits: Most Prestolite V-8 Distributors with snap down cap



18-5289
HI-PERFORMANCE
ELECTRONIC CONVERSION KIT
 Fits: Most Prestolite Distributors with screw down cap



18-5290
HI-PERFORMANCE
ELECTRONIC CONVERSION KIT
 Fits: Most Mallory YL or YD 8-cylinder Distributors with clockwise and counter clockwise rotation



FEATURES

- Replaces point & condensers for true solid state ignition.
- Uses standard coil, cap and rotor.
- Easy to install, one-piece, 2-wire hook-up.
- Accurate to within 1/4° timing accuracy 0 to 6000 RPM range.
- Can be used with Flame Thrower 18-5466 & 18-5469.

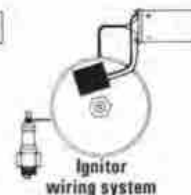

18-5294
ELECTRONIC CONVERSION KIT
 Fits: 6 Cyl. Delco Distributors



18-5295
ELECTRONIC CONVERSION KIT
 Fits: Most 4 Cyl. Prestolite Distributors (Except IBM7026)
 For: Onan, Universal, Waukesha, Wisconsin



18-5296-2
ELECTRONIC CONVERSION KIT
 Fits: Most Mallory YL or YD 8 cyl. Distributors with clockwise or counter clockwise rotation



Ⓛ 18-5296-2D Display Package

18-5297
ELECTRONIC CONVERSION KIT
 For: 4 Cyl. GM



Ⓛ 18-5297D Display Package

18-5298
ELECTRONIC CONVERSION KIT
 (with snap down cap)
 For: Most Prestolite V-8 Distributors



18-5299
ELECTRONIC CONVERSION KIT
 (with screw down cap)
 For: Most Prestolite V-8 Distributors
 Use with 18-5403 Style Rotor



Ⓛ 18-5299D Display Package

APPLICATION BEGINS ON PAGE 704

Ⓛ Items ending in "D" are Display Packaged - Regular number is Non-Display



FEATURES

- Distributors feature the Ignitor II ignition module with adaptive dwell control adjusts the spark timing over the entire RPM range to maximize performance
- Upper roller bearing and oil impregnated bronze sintered bottom bushing are installed and aligned bored for accuracy for maximum durability
- Machined heat treated gear with tight tolerances insures durability and consistent timing to maximize horsepower and performance. Complete with high dielectric strength cap and rotor for years of performance

Standard Rotation

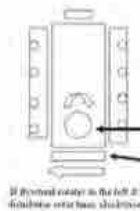

If flywheel pointer is on the left, distributor rotor turns clockwise

CCW Rotation

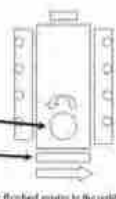

If flywheel pointer is on the right, distributor rotor turns counter clockwise



18-5481
HI-PERFORMANCE
ELECTRONIC DISTRIBUTOR

Fits: Ford V-8 351 Windsor
Replacement cap/rotor kit: 18-5266



18-5482
HI-PERFORMANCE
ELECTRONIC DISTRIBUTOR

Fits: Ford V-8 351 Cleveland, 351M, 400, 429 and 460 engines
Replacement cap/rotor kit: 18-5266



18-5483
HI-PERFORMANCE
ELECTRONIC DISTRIBUTOR

Fits: Chevrolet marine small and big block engines (standard deck height)
Replacement cap/rotor kit: 18-5266



18-5477
ELECTRONIC DISTRIBUTOR

Fits: Ford 302 V-8 engines
Replacement Cap/Rotor Kit 18-5266



18-5478
ELECTRONIC DISTRIBUTOR

Fits: Chrysler LA series V-8 engines
Replacement Cap/Rotor Kit 18-5266



18-5479
ELECTRONIC DISTRIBUTOR

Fits: GM V-8 engines-reverse rotation
Replacement Cap/Rotor Kit 18-5266



18-5480
COMPLETE IGNITION
CONVERSION KIT

Fits: GM SB & BB with Standard Deck Height
—CONTAINS—

Part #	Description
18-5472	Coil
18-8803-2	Wire Set
18-5483	Distributor

**18-26002-1
IGNITION SYSTEM KIT**

Fits: GM 4.3L/262 CID Even Fire Engines



**18-5470
THUNDERBOLT IV V-8 DISTRIBUTOR**

Replaces: 805185A36
Fits: GM V-8 engines
Tune-Up Kit 18-5273



**18-5471
THUNDERBOLT IV V-6 DISTRIBUTOR**

Replaces: 805185A37
GM V-6 engines
Tune-Up Kit 18-5274



**18-5350
DISTRIBUTOR**

Replaces: 888751A03, 888751A02, 888751A1
Fits: Vortec V-6 4.3L MPI (2002-UP) (S/N OM300000 and UP)



**18-5351
DISTRIBUTOR**

Replaces: 884794A02, 884794A1
Fits: Vortec V-8 2001 and up 5.0L/ 5.7L/ 6.2L MPI engines (S/N OM300000 and up)



**18-5475
DISTRIBUTOR**

Replaces: 817377, 817377T
Fits: 4 Cyl. GM w/ Delco EST Ignition
Tune-Up Kit 18-5280



**18-5476
DISTRIBUTOR**

Replaces: 807964A1, 907964A1
Fits: GM V-6 engines with Delco EST Ignition HEI
Tune-Up Kit 18-5278



**18-5484-1
ELECTRONIC
DISTRIBUTOR
Conventional Rotation**

Replaces: 805222A1
Late Model HEI
For: V8 — 262-454 & 502 except
384/ 409 and tall block engines
• Designed as a plug-in replacement for
GM-style fuel injection system distributors

—CONTAINS—

Description	Part #
Distributor Cap	18-5354
Rotor	18-5405

Tune-Up Kit 18-5281



**18-26111-1
DISTRIBUTOR**

Replaces: Mallory YL648AV
Fits: Mercruiser 3.7L L4/LH



**18-5486-2
ELECTRONIC
DISTRIBUTOR
Conventional Rotation**

For: Chevrolet L4, 153 & 181 CID

—CONTAINS—

Part #	Description
18-5397	Distributor Cap
18-5488	Module
18-5404-1	Rotor



18-5487-2
ELECTRONIC DISTRIBUTOR
 Conventional Rotation
 Replaces: 9-26309, Mallory YLM676AV
 For: GM L6, 194, 230, 250, 292 CID



—CONTAINS—

Part #	Description
18-5488	Module
18-5404-1	Rotor

18-5489-2
ELECTRONIC DISTRIBUTOR
 Conventional Rotation
 For: Ford V8 351W CID



—CONTAINS—

Part #	Description
18-5376	Distributor Cap
18-5488	Module
18-5404-1	Rotor

18-5494-2
ELECTRONIC DISTRIBUTOR
 Conventional Rotation
 For: Chevrolet all V8 includes 482, 502, 540 CID (Except 348, 409 & Tall Deck Big Block)



—CONTAINS—

Part #	Description
18-5376	Distributor Cap
18-5488	Module
18-5404-1	Rotor

18-5495-2
ELECTRONIC DISTRIBUTOR
 Conventional Rotation
 For: Ford V8 302 CID



—CONTAINS—

Part #	Description
18-5376	Distributor Cap
18-5488	Module
18-5404-1	Rotor

18-5496-2
ELECTRONIC DISTRIBUTOR
 Replaces: YLM567CV
 Conventional Rotation
 For: Ford V8 351C — 460 CID



—CONTAINS—

Part #	Description
18-5376	Distributor Cap
18-5488	Module
18-5404-1	Rotor

18-5497-2
ELECTRONIC DISTRIBUTOR
 Replaces: YLM579AV
 Conventional Rotation
 For: Chrysler V8 273, 318 (67 & UP) 340, 380 CID "LA" engines



—CONTAINS—

Part #	Description
18-5376	Distributor Cap
18-5488	Module
18-5404-1	Rotor

18-5309-1
DISTRIBUTOR
 Contact Controlled (Standard Rotation)
 Replaces: Mallory YL512CV
 For: Most Ford 302 CID V-8 Eng.
 Tune-Up Kit 18-5251



—CONTAINS—

Part #	Description
18-5314	Contact Set
18-5338	Condenser
18-5404-1	Rotor

18-5312-1
DISTRIBUTOR (Contact Controlled)
 Replaces: Mallory YL554CV
 For: Most Ford 351 CID V-8 Eng.
 Tune-Up Kit 18-5251



18-5313-1
DISTRIBUTOR
 Contact Controlled (Standard Rotation)
 Replaces: 17177A1, 91823A3, 816148A1, 74905A3, 68521A4, 68521A3, 13447A1
 Mallory YL624AV
 For: Most GM V-8 Engs. (small & large blocks) Mallory Tall Cap
 Tune-Up Kit 18-5251



—CONTAINS—

Part #	Description
18-5314	Contact Set
18-5338	Condenser
18-5404-1	Rotor

18-5315-1
DISTRIBUTOR
 Contact Controlled (Standard Rotation)
 Replaces: 87581, 87581T, 62424, 58231, 52352, 33266, 195141
 Mallory YL673AV
 For: Most GM 4 Cyl. Engs. (120 & 140 HP)
 Tune-Up Kit 18-5251



—CONTAINS—

Part #	Description
18-5314	Contact Set
18-5338	Condenser
18-5404-1	Rotor

 <p>18-5498-2 ELECTRONIC DISTRIBUTOR Replaces: 9-26307; Mallory YLM624BV For: GM V8, 482, 502, 540 CID (Except 348, 409 & Tall Deck Big Block) (Reverse Rotation)</p>	 <p>18-5316-1 DISTRIBUTOR Replaces: Mallory YL624BV Fits: Most GM V8 (Reverse Rotation)</p>	 <p>18-5339-1 DISTRIBUTOR Replaces: 9-26103; Mallory YL566AV For: GM V8 327</p>
 <p>18-26110-1 DISTRIBUTOR Replaces: 9-26110; Mallory YL579AV For: Chrysler V8, 273, 318 (1967 & Up), 340 and 360 "LA" Engines</p>	 <p>18-26104-1 DISTRIBUTOR Replaces: 9-26104; Mallory YL567EV For: Ford V8 351C</p>	 <p>18-26112-1 DISTRIBUTOR Replaces: 9-26112; Mallory YL676AV Fits: GM L6, 194, 230, 250, 292 CID (Conventional Rotation)</p>
 <p>18-5512 V-4 DELCO EST CONVERSION KIT Description: Converts 4 Cylinder GM Engines to Electronic Includes: Distributor, Coil, Ignition Wires, and Harnesses</p>	 <p>18-5513 V-6 DELCO EST CONVERSION KIT Description: Converts 6 Cylinder GM Engines to Electronic Includes: Distributor, Coil, Ignition Wires, and Harnesses</p>	
 <p>18-5514 V-8 DELCO EST CONVERSION KIT Description: Converts 8 Cylinder GM Engines to Electronic Includes: Distributor, Coil, Ignition Wires, and Harnesses</p>	 <p>18-5518 V-4 SIERRA ELECTRONIC DISTRIBUTOR CONVERSION KIT Description: Converts 4 Cylinder GM Engines to Electronic Includes: Distributor, Coil, Ignition Wires, and Harnesses</p>	
 <p>18-5519 V-6 SIERRA ELECTRONIC DISTRIBUTOR CONVERSION KIT Description: Converts 6 Cylinder GM Engines to Electronic Includes: Distributor, Coil, Ignition Wires, and Harnesses</p>	 <p>18-5520 V-8 SIERRA ELECTRONIC DISTRIBUTOR CONVERSION KIT Description: Converts 8 Cylinder GM Engines to Electronic Includes: Distributor, Coil, Ignition Wires, and Harnesses</p>	

APPLICATION BEGINS ON NEXT PAGE

MODEL	Cyl.	Ignition Type	Year	Serial #	Tune-Up Kit	Contact Set	Rotor	Dist. Cap	Coil	Distributor	Spark Plug Wires
110	153/4	⊕	1963-1966	1537370-2044032	18-5250 *	18-5311	18-5418	18-5385	18-5433	18-5315-1	18-8800-1
					18-5268 =						
120	153/4	⊕	1964-1966	1666601 - 8531853	18-5250 *	18-5311	18-5418	18-5385	18-5433	18-5315-1	18-8800-1
					18-5268 =						
2.5L	153/4	⊕	1967-1969	8531854 - C853255	18-5250	18-5311			18-5433		
PRESTOLITE REPLC IGN	4 CYL	⊕	1963-1969	1537370 - C853255		18-5303	18-5403				
140	181/4	⊕	1966-1966	2508261 - B450800	18-5250 *	18-5311	18-5418	18-5385	18-5433	18-5315-1	18-8800-1
					18-5268 =						
3.0L	181/4	⊕	1967-1969	B450801 - C856558	18-5250	18-5311			18-5433		
3.0L	181/4	⊕	1990-1991	C856559 - D504541		18-5303	18-5403		18-5433		
3.0L	181/4	⊕	1990-1991	C856559 - D504541							18-8811-1
3.0L	181/4	⊕	1991-1994	D504542 - F603999				18-5361	18-5443		18-8833-1
3.0L	181/4	⊕	1998-2010	L010042 - & UP				18-5361	18-5443		18-8833-1
3.0L MPI	181/4	⊕	2008-2010	A072812 - & UP				18-5361	18-5443		18-8833-1
3.0LX	181/4	⊕	1990-1991	C856559 - D504541							18-8811-1
3.0LX	181/4	⊕	1991-1997	D504542 - K999999				18-5361	18-5443		18-8833-1
3.0L/ LX	L4		1990-1995	C856559 - F603999	18-5262	18-5303	18-5403		18-5433	18-5315-1	18-8800-1
3.0L/ LX	L4		1990-1995	C856559 - F603999							18-8811-1
3.0L/LX	L4		1996 & UP	F604000 & Up	18-5260		18-5406	18-5361	18-5443		18-8833-1
PRESTOLITE REPLC IGN	4 CYL	⊕	1968-1991	2508261 - D504541		18-5303	18-5403				
165	224/4	⊕	1967	B434941 - B774251	18-5250	18-5311			18-5433		
170	224/4	⊕	1985-1986	6915779 - B434940	18-5250	18-5311			18-5433		
180	224/4	⊕	1967	B436391 - B775248	18-5250	18-5311			18-5433		
180	224/4	⊕	1967-1969	B436391 - B775248		18-5303	18-5403		18-5433		
190	224/4	⊕	1985-1986	6916779 - B436390	18-5250	18-5311			18-5433		
3.7L	224/4	⊕	1988-1989	B774252 - & UP	18-5250	18-5311			18-5433		
3.7LX	224/4	⊕	1986-1989	B775249 - & UP	18-5250	18-5311			18-5433		
3.7LX	224/4	⊕	1988-1989	B775249 - & UP		18-5303	18-5403		18-5433		
470	224/4	⊕	1976-1984	4206730 - 6910778	18-5250 *	18-5311	18-5418	18-5385	18-5433		18-8808-2
165, 170, 190 (234CID)	L4		1985-1989	6916779 & UP	18-5250 *	18-5311	18-5418	18-5385	18-5433		18-8808-2
					18-5268 =						
180LX	L4		1987-1989	B436391 & UP	18-5250 *	18-5311	18-5418	18-5385	18-5433		18-8808-2
					18-5268 =						
180LX	L4		1967-1969	B436391 & UP	18-5262	18-5303	18-5403		18-5433		18-8808-2
160, 165(250cid)	L6		1967-1981	2048022-5813433	18-5250 *	18-5311	18-5418	18-5386	18-5433		18-8809-1
					18-5269 =						
485	224/4	⊕	1980-1982	5885394 - 6218036	18-5250	18-5311			18-5433		
488	224/4	⊕	1983-1984	6170287 - 6910778	18-5250	18-5311			18-5433		
PRESTOLITE REPLC IGN	4 CYL	⊕	2010			18-5303	18-5403				
140	194/L6	⊕	1963	1538930 - T725960	18-5250 *	18-5311	18-5418	18-5386		18-5312-1	18-8809-1
					18-5269 =						
150	230/L6	⊕	1964-1966	1666495 - 2048046	18-5250 *	18-5311	18-5418	18-5386			18-8809-1
					18-5269 =						
160	250/L6	⊕	1967-1970	2048022 - 2771483	18-5250	18-5311		18-5386	18-5433		
165	250/L6	⊕	1971-1981	2771484 - 5813433	18-5250	18-5311		18-5386	18-5433		
200	292/L6	⊕	1968	2453769 - 2712072	18-5250 *	18-5311	18-5418	18-5386	18-5433	18-5487-2	18-8809-1
					18-5269 =						
PRESTOLITE REPLC IGN	6 CYL	⊕	2010			18-5303	18-5403	18-5353	18-5433		
185 (4 bb)	229/V-6	⊕	1963-1984	6330163 - 6919655	18-5262 *	18-5303	18-5403	18-5353	18-5433		18-8801-1
					18-5276 =						
175	262/V-6	⊕	1967	8527955 - B773242			18-5432	18-5396	18-5438		
175, 185, 4.3	262/V-6	⊕	1985-1993	6919656 - F000877	18-5274		18-5432	18-5396	18-5438		18-8810-1
185 (2bb)	262/V-6	⊕	1985-1987	6919656 - 8527954			18-5432	18-5396	18-5438		
205	282/V-6	⊕	1985-1987	A331455 - 8775129			18-5432	18-5396	18-5438		

- ⊕ Mallory Ignition
- ⊕ Prestolite
- ⊕ Autolite
- ⊕ Mercury Ignition
- ⊕ Holley
- ⊕ Thunderbolt IV

- ⊕ With screw down cap
- ⊕ Delco
- ⊕ Electronic dist. (std rotation) excluding Thunderbolt Ignition
- ⊕ Delco EST
- ⊕ Delco digital system
- * With out dist cap

- ⊕ With dist cap
- ⊕ Mercury HEI
- ⊕ Delco HEI
- ⊕ Thunderbolt V
- ⊕ Prestolite with clip down dist cap
- ⊕ Contact controlled dist. (Std. Rotation) excl. Thunderbolt ign.

MODEL	Cyl.	Ignition Type	Year	Serial #	Tune-Up Kit	Contact Set	Rotor	Dist. Cap	Coil	Distributor	Spark Plug Wires
205, 4.3LX 4bbi	262/V-6		1985-1999b	A331455 - F802999	18-5274		18-5432	18-5396	18-5438		18-8810-1
262 TBI (GEN +)	262/V-6	☉	1996-1997	F803800 - K999999					18-5443		18-8835-1
4.3L (2bbi)	262/V-6	☉	1986-1996	B773243 - F802999			18-5432	18-5396	18-5438		
4.3L (2bbi) (GEN +)	262/V-6	☉	1998-2010	L010044 & UP			18-5432	18-5396			
4.3L EFI (GEN +) (TBI)	262/V-6	☉	1998	L012009 - L359999					18-5438		18-8835-1
4.3L EFI (GEN +) (TBI)	262/V-6	☉	1999-2001	L360000 - M299999			18-5432	18-5396	18-5438		
4.3L MPI	262/V-6	☉	2002-2010	M300000 & UP	18-5246		18-5245	18-5243	18-5465	18-5350	18-8829-1
4.3LH (GEN +) (4bbi)	262/V-6	☉	1996-2002	L010044 - M614999			18-5432	18-5396	18-5438		
4.3LX (4bbi)	262/V-6	☉	1988-1996	B775130 - F802999			18-5432	18-5396	18-5438		
4.3LX (GEN +) (2bbi)	262/V-6	☉	1996-1997	F803000 - K999999			18-5432	18-5396	18-5438		
4.3L/LH/LX/LXH	V6		1996-2001	F803000 & UP	18-5274		18-5432	18-5396	18-5438		18-8810-1
Alpha(Gen+)											
4.3L/LH/LX/LXH	V6		1996-2001	F803000 & UP	18-5274		18-5432	18-5396	18-5438		18-8810-1
Bravo(Gen+)											
4.3L EFI,262	V6		1996-1998	F803000 - L359999	18-5276		18-5408	18-5362	18-5443		18-8810-1
Mag(TBI)(Gen+)											
4.3L EFI(TBI)	V6		1996 & up	L012009 - L359999	18-5278		18-5408	18-5362	18-5443	18-5476	18-8835-1
(Gen+)				L360000 & UP	18-5274		18-5432	18-5396	18-5438		18-8835-1
4.3L EFI(TBI)	V6		1999-2001	L360000 & UP	18-5274		18-5432	18-5396	18-5438		18-8810-1
215 MCM & MIE (FORD)	302/V-8	☉	1970-1972	2781153 - 3563181	18-5253 *	18-5318	18-5402	18-5389	18-5433	18-5495-2 ☉	18-8803-2
					18-5267 ☉						18-5309-1 ☉
215 MCM & MIE (FORD)	302/V-8	☉	1970-1972	2781153 - 3563181	18-5251 *	18-5314	18-5404-1	18-5376	18-5433	18-5495-2 ☉	18-8803-2
					18-5271 ☉						18-5309-1 ☉
225 MCM & MIE (FORD)	302/V-8	☉	1973-1974	3385721 - 4166999	18-5253 *	18-5318	18-5420	18-5389	18-5433	18-5495-2 ☉	18-8803-2
Ford(302cid)					18-5267 ☉						18-5309-1 ☉
225 MCM & MIE (FORD)	302/V-8	☉	1973-1974	3385721 - 4166999	18-5251 *	18-5314	18-5404-1	18-5376	18-5433	18-5495-2 ☉	18-8803-2
					18-5271 ☉						18-5309-1 ☉
225 MCM & MIE (FORD)	302/V-8	☉	1973-1974	3385721 - 4166999	18-5254 *	18-5317	18-5420	18-5389	18-5433	18-5495-2 ☉	18-8803-2
					18-5267 ☉						18-5309-1 ☉
886 (FORD)	302/V-8	☉	1971-1977	3108723 - 4887829	18-5254 *	18-5317	18-5420	18-5389	18-5433	18-5495-2 ☉	18-8803-2
											18-5309-1 ☉
888 (FORD)	302/V-8	☉	1971-1977	3108723 - 4887829	18-5253 *	18-5318	18-5420	18-5389	18-5433	18-5495-2 ☉	18-8803-2
888 (FORD)	302/V-8	☉	1971-1977	3108723 - 4887829	18-5258 *	18-5303	18-5407	18-5369	18-5433	18-5495-2 ☉	
					18-5277 ☉						18-5309-1 ☉
886 (FORD)	302/V-8	☉	1971-1977	3108723 - 4887829	18-5251 *	18-5314	18-5404-1	18-5376	18-5433	18-5495-2 ☉	18-8803-2
					18-5271 ☉						18-5309-1 ☉
190 (GM 263)	283/V-8	☉	1963-1964	1564539 - 1730903	18-5252	18-5310	18-5417	18-5384	18-5438	18-5498-1 ☉	
											18-5498-2 ☉
											18-5313-1 ☉
196 MIE	305/V-8	☉	1977	4776402 - 4931099		18-5314	18-5404-1		18-5433		
200 (5.0L)	305/V-8	☉	1985-1995	6899058 - F800999			18-5431	18-5395	18-5438		
228	305/V-8	☉	1977-1982	4765100 - 6218461		18-5314	18-5401-1		18-5433		
228	305/V-8	☉	1982-1984	6218462 - 6899268			18-5431	18-5395	18-5438		
226 MIE	305/V-8	☉	1977-1980	4765100 - 5907057		18-5314	18-5401-1		18-5433		
228 MCM & MIE	305/V-8		1977-1984	4765100 - 6218461	18-5251 *	18-5314	18-5404-1	18-5376	18-5433		18-8803-2
					18-5271 ☉						18-5498-1 ☉
228	305/V-8		1985-1986	6218462 - 6899268	18-5273		18-5431	18-5395	18-5438	18-5494-2 ☉	18-8804-1
											18-5495-1 ☉
230, 5.0L/LX MIE	305/V-8		1981-1995	5907058 - F600999	18-5273		18-5431	18-5395	18-5438	18-5494-2 ☉	18-8804-1
											18-5498-1 ☉
198, 898 MCM &	305/V-8		1977-1982	4776402 - 6218461	18-5251 *	18-5314	18-5404-1	18-5376	18-5433	18-5494-2 ☉	18-8803-2
					18-5271 ☉						18-5498-1 ☉
230	305/V-8	☉	1985-1987	6899269 - M8773739			18-5431	18-5395	18-5438		
230 MIE	305/V-8	☉	1981-1987	5907058 - B788151			18-5431	18-5395	18-5438		

- ☉ Mallory Ignition
- ☉ Prestolite
- ☉ Autolite
- ☉ Mercury Ignition
- ☉ Holley
- ☉ Thunderbolt IV

- ☉ With screw down cap
- ☉ Delco
- ☉ Electronic dist. (std rotation) excluding Thunderbolt ignition
- ☉ Delco EST
- ☉ Delco digital system
- ☉ With out dist cap

- ☉ With dist cap
- ☉ Mercury HEI
- ☉ Delco HEI
- ☉ Thunderbolt V
- ☉ Prestolite with clip down dist cap
- ☉ Contact controlled dist. (Std. Rotation) excl. Thunderbolt ign.

MODEL	Cyl.	Ignition Type	Year	Serial #	Tune-Up Kit	Contact Set	Rotor	Dist. Cap	Coil	Distributor	Spark Plug Wires
5.0L (GEN +)	305/V-8	+	1998-2010	L015751 & UP			18-5431	18-5395	18-5438		
5.0L EFI (Gen+)	305/V-8	™	1998	L012052 - L331630	18-5261		18-5405	18-5354	18-5442	18-5404-2	18-8836-1
										18-5498-1	
5.0L EFI (GEN +)	305/V-8	™	1998	L331651 - L339999					18-5442		
5.0L EFI (GEN +)	305/V-8	™	1999	L331631 - L331650			18-5431		18-5438		
5.0L MPI	305/V-8	™	2002-2010	M300000 & UP							18-8828-1
5.0L MIE	305/V-8	®	1988	B788152 - C396832			18-5431	18-5395	18-5438		
5.0LX	305/V-8	®	1988-1985	B773740 - F600999			18-5431	18-5395			
898	305/V-8	®	1977-1982	4762210 - 621461	18-5314		18-5404-1		18-5433		
898	305/V-8	®	1983-1984	6218462 - 6890057			18-5431	18-5395	18-5438		
350MAG MPI	V8		1998-2001	L302200 & UP	18-5273		18-5431	18-5395	18-5438	18-5494-2	
(Gen+) &										18-5498-1	
MIE(Gen+)											
350 MAG MPI	V8		2001-2004	M300000 & UP	18-5247		18-5245	18-5244	18-5465	18-5351	
350 MAG MPI					18-5247		18-5245	18-5244			
HORIZON											
350 MAG	V8		1999-2001	L304700 & UP	18-5273		18-5431	18-5395	18-5438	18-5494-2	
HORIZON MIE										18-5498-1	
350 MAG HORIZON	V8		2001-2004	M300000 & Up	18-5247		18-5245	18-5244	18-5465	18-5351	
MIE											
350MAG MPI	V8		1999-2001	L304600 & up	18-5273		18-5431	18-5395	18-5438	18-5494-2	
SKI(Gen+)										18-5498-1	
350MAG SKI	V8		1991-1996	D505450 - K040399	18-5273		18-5431	18-5395	18-5438	18-5494-2	
										18-5498-1	
350MAG SKI	V8		1991-1996	D505450 - K040399	18-5273		18-5431	18-5395	18-5438	18-5494-2	
										18-5498-1	
350MAG SKI	V8		1991-1997	D505450 - K999999	18-5273		18-5431	18-5395	18-5438	18-5494-2	
										18-5498-1	
225 (GM)	327/V-8	®	1963-1969	1539620 - 2694014	18-5252 *	18-5310	18-5417	18-5384	18-5433	18-5494-2	18-8803-2
										18-5498-1	
										18-5313-1	
225 MIE (GM)	327/V-8	+	1968	2278647 - 2694014	18-5282		18-5420	18-5389		18-5494-2	18-8803-2
										18-5498-1	
250 MCM & MIE	327/V-8	+	1968-1969	2314301 - 2639854	18-5282		18-5420	18-5389		18-5494-2	18-8803-2
										18-5498-1	
250	350/V-8	®	1977	4768000 - 4908949	18-5251 *	18-5314	18-5404-1	18-5376	18-5433	18-5494-2	18-8803-2
					18-5271					18-5498-1	
250 MCM & MIE (GM)	350/V-8	®	1975-1978	3258729 - 4521254		18-5317	18-5420	18-5389	18-5433		
255 MCM (GM)	350/V-8	®	1976	4498701 - 4767999		18-5314	18-5404-1		18-5433		
255 MIE	350/V-8	®	1976-1980	4498701 - 5907057		18-5314	18-5404-1				
260	350/V-8	®	1978-1982	4908850 - 6218461		18-5314	18-5404-1		18-5433		
270 MCM & MIE	350/V-8	+	1969-1972	2951074 - 3385720	18-5282		18-5420	18-5389	332-4895A II	18-5494-2	18-8803-2
										18-5498-1	
280 TRS	350/V-8	®	1975	4176250 - 4499390		18-5317	18-5420	18-5389	18-5433		
280 TRS	350/V-8	®	1976	4499391 - 4770199	18-5251 *	18-5314	18-5404-1	18-5376	18-5433	18-5494-2	18-8803-2
					18-5271					18-5498-1	
										18-5313-1	
300	350/V-8	®	1985-1988	6668677 - 8430367			18-5431	18-5395	18-5438		
320 EFI	350/V-8	®	1987-1989	A543604 - C022418			18-5431	18-5395	18-5438		
350 MAG ALPHA	350/V-8	® *	1986-1997	A635178 - K999999			18-5431	18-5395	18-5438		
360 MAGALPHA EFI (GEN +)	350/V-8	™	1996-1997	F800300 - K999999	18-5281		18-5405	18-5354	18-5442	18-5494-2	18-8836-1
350 MAG BRAVO MPI	350/V-8	™	1995-1997	F415189 - K999999				18-5354	18-5443	18-5498-1	18-8836-1
350 MAG EFI SKI	350/V-8	™	1994-1997	F215561 - K999999				18-5354	18-5443		18-8832-1
350 MAG MPI (GEN +)	350/V-8	™	1998	L010019 - L325962	18-5281		18-5405	18-5354	18-5442	18-5494-2	18-8832-1
										18-5498-1	

- ® Mallory ignition
- ® Prestolite
- ® Autolite
- ® Mercury Ignition
- ® Holley
- ® Thunderbolt IV

- ® With screw down cap
- ® Delco
- ® Electronic dist. (std rotation) excluding Thunderbolt ignition
- ® Delco EST
- ♦ Delco digital system
- ★ With out dist cap

- ® With dist cap
- ™ Mercury HEI
- ™ Delco HEI
- ® Thunderbolt V
- ▼ Prestolite with clip down dist cap
- ⚡ Contact controlled dist. (Std. Rotation) excl. Thunderbolt ign.

MODEL	Cyl.	Ignition Type	Year	Serial #	Tune-Up Kit	Contact Set	Rotor	Dist. Cap	Gen	Distributor	Spark Plug Wires
350 MAG MPI (GEN +)	350V-8	☛	1999-2001	L325953 - M999999			18-5431	18-5395	18-5438		
350 MAG MPI	350V-8	**	2002-2010	M300000 & UP				18-5244			
350 MAG MPI HORIZON	350V-8	**	2002-2007	M300000 - A299999				18-5244			
350 MAG MPI HORIZON MIE	350V-8	☛	1999-2001	L304700 - M299999			18-5431	18-5395	18-5438		
350 MAG MPI HORIZON MIE	350V-8	**	2002-2007	M300000 - A089999				18-5244			
350 MAG MPI MIE (GEN +)	350V-8	**	1998	L002008 - L302199	18-5281		18-5405	18-5354	18-5443	18-5494-2 ☐	18-8832-1
										18-5498-1 ☐	
350 MAG MPI MIE (GEN +)	350V-8	☛	1998-2001	L302200 - M299999	18-5273		18-5431	18-5395	18-5438		18-8834-1
350 MAG MPI MIE	350V-8	**	2002-2007	M300000 - A089999				18-5244			
350 MAG MPI SKI	350V-8	**	1995-1998	F350583 - L304599	18-5281		18-5405	18-5354	18-5443	18-5494-2 ☐	18-8836-1
										18-5498-1 ☐	
350 MAG MPI SKI (GEN +)	350V-8	☛	1999-2001	L304600 - M2999999			18-5431	18-5395	18-5438		
350 MAG MPI SKI	350V-8	**	2002-2007	M300000 - A089999				18-5244			
350 MAG SKI	350V-8	☐, *	1991-1997	D505450 - K999999			18-5431	18-5395	392-805570A 2		
350MAG BRAVO	V8		1995-1998	F415189 - L325952	18-5281		18-5405	18-5354	18-5443	18-5494-2 ☐	18-8836-1
MPI & (Gen+)										18-5498-1 ☐	
350MAG EFI SKI	V8		1996-1997	F820707 - K999999	18-5281		18-5405	18-5354	18-5443	18-5494-2 ☐	18-8832-1
& (Gen+)										18-5498-1 ☐	
5.0L Alpha &	V8		1998-2001	L015751 & up	18-5273		18-5431	18-5395	18-5438	18-5494-2 ☐	18-8821-1
Bravo (Gen+)										18-5498-1 ☐	
5.0L EFI (Gen +)	V8		1999-2001	L331631 & up	18-5273		18-5431	18-5395	18-5438	18-5494-2 ☐	18-8834-1
										18-5498-1 ☐	
5.0L MCM/MIE MPI	V8		2001 & up	M300000 & UP	18-5247		18-5245	18-5244	18-5405	18-5351	
198, 898, 5.0L GM (305cid)	V8		1983-1984	6218462 - 6899057	18-5273		18-5431	18-5395	18-5438	18-5494-2	18-8804-1
										18-5498-1	
200, 5.0L GM (305cid)	V8		1985-1995	6218462 - F600999	18-5273		18-5431	18-5395	18-5438	18-5494-2	18-8804-1
										18-5498-1	18-8834-1
200, 5.0L GM (305cid)	V8		1987-1995	B525982 - F600999	18-5273		18-5431	18-5395	18-5438	18-5494-2	
										18-5498-1	
5.7L	350V-8	☐, *	1988-2010	6218462 & UP			18-5431	18-5395			18-8828-1
5.7L EFI	350V-8	**	1995-1997	F225560 - K999999				18-5354			18-8828-1
5.7L EFI (GEN +)	350V-8	**	1998	L010035 - L325976				18-5354	18-5442		
5.7L EFI (GEN +)	350V-8	**	1998	L329000 - L331598				18-5354	18-5442		
5.7L EFI (GEN +)	350V-8	**	1998	L336000 - L339999				18-5354	18-5442		
5.7L EFI (GEN +)	350V-8	☛	1999	L325977 - L325999			18-5431	18-5395	18-5438		
5.7L EFI (GEN +)	350V-8	☛	1999	L331599 - L331991			18-5431	18-5395	18-5438		
5.7L EFI (GEN +)	350V-8	☛	1999	L335716 - L335999			18-5431	18-5395	18-5438		
5.7L EFI (GEN +)	350V-8	☛	1999-2001	L340000 - M299999			18-5431	18-5395	18-5438		
5.7L EFI MIE (GEN +)	350V-8	☛	1997	X040300 - K999999					18-5442		
5.7L MIE	350V-8	☐, *	1988-2010	B788152 & UP			18-5431	18-5395			
5.7L MPI HORIZON MIE	350V-8	**	2008-2010	A090000 & UP				18-5244			
5.7L MPI MIE	350V-8	**	2008-2010	A090000 & UP				18-5244			
5.7L MPI SKI	350V-8	**	2008-2010	A090000 & UP				18-5244	18-5433		
5.7L SKI	350V-8	☐	1985-1995	A338553 - F775199	18-5251 *	18-5314	18-5404-1	18-5376	18-5433	18-5494-2 ☐	18-8802-1
					18-5271 ☐					18-5498-1 ☐	
5.7L SKI	350V-8	☐	1985-1996	A338553 - F775199	18-5262 *	18-5303	18-5403	18-5352	18-5433	18-5494-2 ☐	18-8802-1
					18-5275 ☐					18-5498-1 ☐	
5.7L SKI	350V-8	☐, *	1987-2010	B514627 & UP			18-5431	18-5395			
5.7LX	350V-8	*	1995-1997	F601000 - K999999			18-5433	18-5395	18-5438		
5.7LX BRAVO EFI (GEN +)	350V-8	**	1996-1997	F800300 - K999999				18-5354			
5.7LX EFI	350V-8	**	1996-1997	F752400 - K999999	18-5281		18-5405	18-5354	18-5442	18-5494-2 ☐	18-8836-1
										18-5498-1 ☐	
5.7L MIE & SKI	V8		1998 & up	L002003 & up	18-5273 *		18-5431	18-5395	18-5438		18-8830-1
5.7L EFI & (Gen+)	V8		1995-1998	F225560-L339999	18-5281 ☐		18-5405	18-5354	18-5442	18-5494-2 ☐	18-8836-1

- ☐ Mallory Ignition
- ☐ Prestolite
- ☐ Autolite
- ☐ Mercury Ignition
- ☐ Holley
- ☐ Thunderbolt IV

- ☐ With screw down cap
- ☐ Delco
- ☐ Electronic dist. (std rotation) excluding Thunderbolt ignition
- ☐ Delco EST
- ☐ Delco digital system
- * With out dist cap

- ☐ With dist cap
- ☐ Mercury HEI
- ☐ Delco HEI
- ☐ Thunderbolt V
- ☐ Prestolite with clip down dist cap
- ☐ Contact controlled dist. (Std. Rotation) excl. Thunderbolt ign.

MODEL	Cyl.	Ignition Type	Year	Serial #	Tune-Up Kit	Contact Set	Rotor	Dist. Cap	Coil	Distributor	Spark Plug Wires
5.7L EFI & (Gen+)	V8		1999-2001	L325977 & UP	18-5273		18-5431	18-5395	18-5438	18-5494-1 ⓐ	18-8834-1
										18-5498-1 ⓐ	
5.7L SKI	V8		1987-1997	8514627 - K999999	18-5273		18-5431	18-5395	18-5438	18-5494-2 ⓐ	18-8821-1
										18-5498-1 ⓐ	
5.7L SKI	V8		1987-1995	8514627 - F775199	18-5273		18-5431	18-5395	18-5433	18-5494-2 ⓐ	18-8821-1
										18-5498-1 ⓐ	
5.7L SKI	V8		1998-2001	L002005 & up	18-5273		18-5431	18-5395	18-5438	18-5494-2 ⓐ	18-8821-1
										18-5498-1 ⓐ	
260, 350MAG 5.7L SKI/ALPHA/ BRAVO(350cid)	V8		1987-1995	8525982 - F800999	18-5273		18-5431	18-5395	18-5438	18-5494-2	18-8804-1
										18-5498-1	
260, 350MAG, 5.7L ALPHA/ BRAVO(350cid)	V8		1987-1995	8525982 - F800999	18-5273		18-5431	18-5395	18-5438	18-5494-2	18-8821-1
										18-5498-1	
350MAG, 5.7L/ LX ALPHA &	V8		1994-2001	F353525 & UP	18-5273		18-5431	18-5395	18-5438	18-5494-2	18-8821-1
										18-5498-1	
BLACK SCORPION SKI (GEN+)	350/V-8	ⓐ	1996-2003	F800000 - M391599				18-5354	18-5443		18-8832-1
BLACK SCORPION SKI (GEN+)	350/V-8	ⓐ	2003-2007	M391600 - W699432				18-5395			
SCORPION 350	350/V-8	ⓐ	2008-2010	W699433 & UP				18-5395			
BLACK SCORPION	V8		1998	F800000 - K040000	18-5281		18-5405	18-5354	18-5443	18-5494-2	18-8832-1
SKI(Gen+) (350cid)											18-5498-1
BLACK SCORPION	V8		1987-1988	K040001 - L050600	18-5281		18-5405	18-5354	18-5443	18-5494-2	18-8824-1
SKI(Gen+) (350cid)											18-5498-1
BLACK SCORPION	V8		1998-2002	L005601 - M381599	18-5281		18-5405	18-5354	18-5443	18-5494-2	18-8822-1
SKI(Gen+) (350cid)											18-5498-1
233 MCM & MIE (FORD)	351/V-8	ⓐ	1975-1977	4173000 - 4902304	18-5280 ⓐ	18-5303	18-5409	18-5352	18-5433	18-5489-2 ⓐ	18-8803-2
					18-5275 ⓐ						18-5312-1 ⓐ
233 MCM & MIE (FORD)	351/V-8	ⓐ	1975-1977	4173000 - 4902304	18-5288 ⓐ	18-5303	18-5407	18-5389	18-5433	18-5489-2 ⓐ	18-8803-2
					18-5277 ⓐ						18-5312-1 ⓐ
233 MCM & MIE (FORD)	351/V-8	ⓐ	1975-1977	4173000 - 4902304	18-5254	18-5317	18-5420	18-5389	18-5433	18-5489-2 ⓐ	18-8803-2
											18-5312-1 ⓐ
255 MCM & MIE	351/V-8		1973-1974	3385721 - 4186999	18-5254	18-5317	18-5420	18-5389	18-5433	18-5489-2	18-8803-2
											18-5312-1
255 MCM & MIE	351/V-8		1973-1974	3385721 - 4186999	18-5251	18-5314	18-5404-1	18-5376	18-5433	18-5489-2	18-8803-2
					18-5271						18-5312-1
255 MIE & MCM (FORD)	351/V-8	ⓐ	1973-1980	3258728 - 5907057		18-5314	18-5404-1		18-5433		
255 MIE & MCM (FORD)	351/V-8	ⓐ	1973-1980	3258728 - 5907057			18-5420	18-5389	18-5433		
255, 280MCM & MIE(350cid)	V8		1975-1982	3258728 - 6218461	18-5251	18-5314	18-5404-1	18-5376	18-5433	18-5489-2 ⓐ	18-8803-2
					18-5271						18-5498-1 ⓐ
											18-5313-1 ⓐ
255MCM & MIE (350cid)	V8		1975-1980	4498701 - 5907057	18-5254	18-5317	18-5420	18-5389	18-5433	18-5494-2 ⓐ	18-8803-2
											18-5498-1 ⓐ
											18-5313-1 ⓐ
260,350MAG,	V8		1982-1994	8218462 - F800999	18-5273		18-5431	18-5395	18-5438	18-5494-2 ⓐ	18-8804-1
											18-5498-1 ⓐ
											18-5313-1 ⓐ
300, 320EFI	350/V-8		1985-1989	A543604 - C622418	18-5273		18-5431	18-5395	18-5438	18-5494-2 ⓐ	18-8804-1
											18-5498-1 ⓐ
377 MAG	377/V-8	ⓐ	2008-2010	A300000 & UP				18-5244			
377 SCORPION MCM	377/V-8	ⓐ	1999-2005	L415146 - M907201	18-5281		18-5405	18-5354	18-5443	18-5494-2 ⓐ	
											18-5498-1 ⓐ
377 SCORPION SKI	377/V-8		1997-1998	K000656 - L00314	18-5281		18-5405	18-5354	18-5443	18-5494-2 ⓐ	
											18-5498-1 ⓐ
MX 6.2L MPI	377/V-8	ⓐ	2000-2001	L680003 - M299999	18-5273		18-5431	18-5395	18-5438	18-5494-2 ⓐ	18-8834-1

- | | | |
|--|--|---|
| <ul style="list-style-type: none"> ⓐ Mallory Ignition ⓑ Prestolite ⓒ Autolite ⓓ Mercury Ignition ⓔ Holley ⓕ Thunderbolt IV | <ul style="list-style-type: none"> ⓖ With screw down cap ⓗ Delco ⓓ Electronic dist. (std rotation) excluding Thunderbolt ignition ⓑ Delco EST ⓔ Delco digital system ⓕ With out dist cap | <ul style="list-style-type: none"> ⓖ With dist cap ⓗ Mercury HEI ⓓ Delco HEI ⓑ Thunderbolt V ⓔ Prestolite with clip down dist cap ⓕ Contact controlled dist. (Std. Rotation) excl. Thunderbolt ign. |
|--|--|---|

MODEL	Cyl.	Ignition Type	Year	Serial #	Tune-Up Kit	Contact Set	Rotor	Dist. Cap	Coil	Distributor	Spark Plug Wires
MX 6.2L MPI (377CID)	377/V-6	**	2002-2007	M300000 - A299999	18-5247		18-5245	18-5244		18-5408-1 ⓐ	
MX 6.2L MPI	377/V-6		2001-2004	M300000 & UP	18-5247		18-5245	18-5244	18-5465	18-5351	
MX 6.2L MPI HORIZON	377/V-6	**	2002-2007	M300000 - A299999	18-5247		18-5245	18-5244	18-5465	18-5351	
MX 6.2L MPI HORIZON ME	377/V-6	**	2002-2010	M300000 & UP	18-5247		18-5245	18-5244	18-5465	18-5351	
MX 6.2L MPI MIE	377/V-6	**	2000-2001	L670000 - M299999			18-5431	18-5395	18-5438		
MX 6.2L MPI MIE	377/V-6	**	2002-2010	M300000 & UP				18-5244			
MX 6.2L MPI SKI	377/V-6	**	2002-2007	M317000 - A099999	18-5247		18-5245	18-5244			
MX 6.2L BLACK SCORPION 90	377/V-6	**	2001-2003	F800000 - M391599				18-5354			N/A
MX 6.2L BLACK SCORPION 90	377/V-6	**	2003-2007	M391600 - W696432				18-5395			
SCORPION 377	377/V-6	**	2008-2010	W696433 & UP				18-5395			
325 MCM & MIE	427/V-6	*	1969-1974	2278747 & UP	18-5282		18-5420	18-5369		18-5404-2 ⓐ	18-8803-2
										18-5408-1 ⓐ	
330 MCM & MIE	454/V-6	ⓐ	1977-1981	4623115-6083144	18-5251 *	18-5314	18-5404-1	18-5378	18-5433	18-5404-2 ⓐ	18-8803-2
					18-5271 =					18-5408-1 ⓐ	
										18-5313-1 ⓐ	
330 MCM & MIE	454/V-6	*	1977-1981	4623115-6083144	18-5282		18-5420	18-5389		18-5404-2 ⓐ	18-8803-2
										18-5408-1 ⓐ	
										18-5313-1 ⓐ	
330	454/V-6	ⓐ	1982-1987	6083145 - B816540			18-5431	18-5395	18-5438		
330, 340, 7.4L	454/V-6		1981-1992	5889914 - D715493	18-5273		18-5431	18-5395	18-5438	18-5404-2 ⓐ	18-8804-1
MCM & MIE(454cid)										18-5408-1 ⓐ	
340 MIE	454/V-6	ⓐ	1981-1987	5889914 - B788365			18-5431	18-5395	18-5438		
350 MIE	454/V-6	*	1974-1976	3780450 - 4623109	18-5282		18-5420	18-5369		18-5404-2 ⓐ	18-8803-2
										18-5408-1 ⓐ	
370 TRS	454/V-6	ⓐ	1978-1985	4179554 - 6721527	18-5251 *	18-5314	18-5404-1	18-5378	18-5433	18-5404-2 ⓐ	18-8803-2
					18-5271 =					18-5408-1 ⓐ	
										18-5313-1 ⓐ	
370 TRS	454/V-6	ⓐ	1978-1985	4883520 - 6721527	18-5254	18-5317	18-5420	18-5369	18-5433	18-5404-2 ⓐ	18-8803-2
										18-5408-1 ⓐ	
										18-5313-1 ⓐ	
370 TRS	454/V-6	ⓐ	1985-1987	6721528 - B714586	18-5273		18-5431	18-5395	18-5433	18-5404-2 ⓐ	18-8804-1
										18-5408-1 ⓐ	
400 TRS	454/V-6	ⓐ	1980-1986	5668232 - B457644		18-5314	18-5404-1		18-5433		
400 TRS	454/V-6	ⓐ	1980-1986	5668232 - B457644		18-5317		18-5369	18-5433		
420	454/V-6	ⓐ	1987-1989	A398941 - B622416	18-5273		18-5431	18-5395	18-5438	18-5404-2 ⓐ	18-8837-1
										18-5408-1 ⓐ	
425	454/V-6	ⓐ	1990-1993	B622419 - D937011			18-5431	18-5395	18-5438		18-1837-1
440 TRS	454/V-6	ⓐ	1983-1986	6181070 - B485220		18-5314	18-5404-1		18-5433		
450	454/V-6	ⓐ	1985-1986	F347100 - F347277	18-5273		18-5431	18-5395	18-5438	18-5404-2 ⓐ	
										18-5408-1 ⓐ	
454 MAG ALPHA	454/V-6	ⓐ	1986-1997	A631894 - B785148	18-5273		18-5431	18-5395	18-5438	18-5404-2 ⓐ	18-8804-1
										18-5408-1 ⓐ	
454 MAG BRAVO	454/V-6	ⓐ, *	1986-1997	B721206 - K999999			18-5431	18-5395	18-5438		
454 MAG EFI	454/V-6	**	1994-1996	F115700 - F802349				18-5354	18-5443		18-8832-1
454 MAG MPI	454/V-6	**	1996-1998	F802350 - L085008				18-5354	18-5443		18-8832-1
454 MAG MPI	454/V-6	**	1998-2001	L085010 - M024999				18-5354	18-5443		18-8832-1
454 MAG MPI HORIZON MIE	454/V-6	**	1998-2001	L002200 - L674000	18-5281		18-5405	18-5354	18-5443	18-5404-2 ⓐ	
										18-5408-1 ⓐ	
454-EFI-MAG MPI	454/V-6		1994-2001	F115700 & UP	18-5281		18-5405	18-5354	18-5443	18-5404-2 ⓐ	18-8832-1
HORIZON MIE										18-5408-1 ⓐ	
454 MAG MPI	454/V-6		1999-2001	L086001 - L674000	18-5281		18-5405	18-5354	18-5443	18-5404-2 ⓐ	18-8832-1
HORIZON MIE										18-5408-1 ⓐ	
454 MAG MPI SKI	454/V-6	**	1995-1997	F215800 - K999999				18-5354	18-5443		18-8832-1
525 SC	454/V-6	ⓐ, *	1991-1999	D456000 - L415623			18-5431	18-5395			

- ⓐ Mallory Ignition
- ⓑ Prestolite
- ⓒ Autolite
- ⓓ Mercury Ignition
- ⓔ Holley
- ⓕ Thunderbolt IV

- ⓖ With screw down cap
- ⓗ Delco
- ⓓ Electronic dist. (std rotation) excluding Thunderbolt Ignition
- ⓔ Delco EST
- ⓕ Delco digital system
- * With out dist cap

- ⓖ With dist cap
- ⓗ Mercury HEI
- ⓓ Delco HEI
- ⓔ Thunderbolt V
- ⓕ Prestolite with clip down dist cap
- ⓖ Contact controlled dist. (Std. Rotation) excl. Thunderbolt Ign.

MODEL	Cyl.	Ignition Type	Year	Serial #	Tune-Up Kit	Contact Set	Rotor	Dist. Cap	Coil	Distributor	Spark Plug Wires
7.4L BRAVO	454/V-8	⊖, *	1988-1997	B771113 - K999999			18-5431	18-5395			
7.4L MIE	454/V-8	⊖, *	1988-1997	B788366 - K999999			18-5431	18-5395			
7.4L MPI (L29)	454/V-8	**	1998-2001	L010003 - M024330				18-5354	18-5443		18-8832-1
7.4L MPI MIE	454/V-8	**	1995-1997	F563052 - K999999				18-5354	18-5443		18-8832-1
7.4L MPI MIE (L29)	454/V-8	**	1998-2001	L002006 - L674613				18-5354	18-5443		18-8832-1
7.4L TBI MIE	454/V-8	**	1996-1997	F874815 - K999999				18-5354			N/A
7.4LX BRAVO EFI	454/V-8	**	1996-1997	F620000 - K999999				18-5354	18-5443		18-8832-1
7.4LX BRAVO MPI	454/V-8	**	1996-1997	F602010 - K999999				18-5354	18-5443		18-8832-1
390	482/V-8	*	1989-197079	2781129 - 2825059	18-5282		18-5420	18-5369			18-8803-2
460 TRS	482/V-8	⊖	1983-1988	6180970 - 6181046	18-5251	18-5314	18-5404-1	18-5376	18-5433	18-5494-2 ⊖	18-8803-2
											18-5406-1 ⊖
											18-5313-1 ⊖
460 TRS	482/V-8	⊖	1983-1988	6180970 - 6181046	18-5254	18-5317	18-5420	18-5369	18-5433	18-5494-2 ⊖	18-8803-2
											18-5406-1 ⊖
											18-5313-1 ⊖
465	V8		1992-1994	D763732 - F213244	18-5273		18-5431	18-5395	18-5438		18-8837-1
496 / 8.1L	V8		2000 & Up	M025000 & UP			N/A				18-8838-1
500	502/V-8	⊖, *	1994-1999	F213293 - L601036	18-5273		18-5431	18-5395	18-5438		18-8837-1
500 EFI	502/V-8	**	1998-2005	L001477 - M007127				18-5354	18-5443		
502 MAG	502/V-8	⊖	1990-1993	C878221 - F114528	18-5273		18-5431	18-5395	18-5438		18-8804-1
502 MAG EFI	502/V-8	**	1993-1996	D640650 - F802599				18-5354	18-5443		18-8832-1
502 MAG MPI	502/V-8	**	1996-1998	F802800 - L085000				18-5354	18-5443		18-8832-1
500(Gen+)	502/V-8		1999	L414639 - L601036	18-5273		18-5431	18-5395	18-5438		18-8837-1
500GM EFI	502/V-8		1998-2000	L001477 & up	18-5281		18-5405	18-5354	18-5443		
502 MAG MPI	502/V-8		1993-1998	D640650 - L085000	18-5281		18-5405	18-5354	18-5443		18-8832-1
502GM MAG	502/V-8		1998-2001	L085001 & up	18-5281		18-5405	18-5354	18-5443		18-8832-1
8.2L GM MPI MIE	502/V-8		1996-2001	F819620 & up	18-5281		18-5405	18-5354	18-5443		18-8832-1
8.2L GM MPI MIE	502/V-8		1990-1996	C878221 - F819619	18-5273		18-5431	18-5395	18-5438		18-8804-1
525 SC	502/V-8		1991-1995	00456000-0F877734	18-5273		18-5431	18-5395	18-5438		18-8804-1
525 SC	502/V-8		1996-1999	0K000012 & up	18-5273		18-5431	18-5395	18-5438		18-8837-1
575 SCI	502/V-8	**	2000-2005	L306696 - M950526				18-5354	18-5443		
575 SCI	502/V-8		2000-2005	L306696 & UP	18-5281		18-5405	18-5354	18-5443		
600 SC	502/V-8	⊖, *	1991-2000	D456489 - L301186			18-5431	18-5395	18-5438		
600 SC	502/V-8		1991-1993	D456489 - D763875	18-5273		18-5431	18-5305	18-5438		18-8837-1
600 SC	502/V-8		1993-2001	D763876 & UP	18-5273		18-5431	18-5395	18-5438		18-8837-1
8.2L MIE	502/V-8	⊖, *	1990-1996	C878221 - F819619			13524T 1	18-5385	18-5438		
8.2L MPI MIE	502/V-8	**	1996-1998	F819620 - L086012				18-5354	18-5443		
8.2L MPI MIE	502/V-8	**	1998-2001	L086013 - L674200				18-5354	18-5443		
500 BULLDOG	540/V-8	⊖, *	1990-2001	C577903 - M050281	18-5273		18-5431	18-5395	18-5438		18-8837-1
575	540/V-8	⊖	1986-1992	A677429 - D763716			18-5431	18-5395	18-5438		
800 SC	572/V-8	⊖, *	1993-1998	D763836 & UP	18-5273		18-5431	18-5395	18-5438		18-8837-1

- ⊖ Mallory Ignition
- ⊖ Prestolite
- ⊖ Autolite
- ⊖ Mercury Ignition
- ⊖ Holley
- ⊖ Thunderbolt IV
- ⊖ With screw down cap
- ⊖ Delco
- ⊖ Electronic dist. (std rotation) excluding Thunderbolt ignition
- ⊖ Delco EST
- ⊖ Delco digital system
- ★ With out dist cap
- ⊖ With dist cap
- ⊖ Mercury HEI
- ⊖ Delco HEI
- ⊖ Thunderbolt V
- ⊖ Prestolite with clip down dist cap
- ⊖ Contact controlled dist. (Std. Rotation) excl. Thunderbolt ign.

PREMIUM MARINE IGNITION WIRES

Sierra's MAGFORCE Ignition Wires are "Electronics Friendly" protecting all of your electronic devices and electronic engine controls from RFI and EMI while delivering the maximum amount of voltage. Exact fit design ensures easy installation and years of trouble - free service.



MERCURISER MARINE IGNITION WIRES APPLICATION

Model	Cyl.	Distributor	Year Start	Year Stop	Serial # Start	Serial # End	Plug Wire Set
110	4	Delco	1963	1966	1537370	2044033	18-8800-1
120	4	Delco	1964	1986	1666601	0B531853	18-8800-1
2.5L	4	Delco	1987	1989	0B531854	0C853255	18-8800-1
140	4	Delco	1968	1986	2508261	0B450800	18-8800-1
3.0L	4	Delco	1987	1989	0B450801	0C856558	18-8800-1
3.0L, LX	4	Prestolite	1990	1991	0C856559	0D504541	18-8800-1
3.0L, LX	4	Delco Digital	1990	1991	0C856559	0D504541	18-8811-1
3.0L	4	Delco EST	1991	& Up	0D504542	& Up	18-8833-1
3.0LX	4	Delco EST	1991	1997	0D504542	0K999999	18-8833-1
3.0L MPI	4	Delco EST	2012	& Up	1A072812	& Up	18-8833-1
165	4	Delco	1987	1987	0B434940	0B774251	18-8808-2
170	4	Delco	1985	1986	6916779	0B434940	18-8808-2
180	4	Prestolite	1987	1987	0B436391	0B775248	18-8800-1
190	4	Delco	1985	1986	6916779	0B436390	18-8808-2
3.7L	4	Delco	1988	1989	0B774252	& Up	18-8808-2
3.7LX	4	Delco	1988	1989	0B775249	& Up	18-8808-2
3.7LX	4	Prestolite	1988	1989	0B775249	& Up	18-8800-1
470	4	Delco	1976	1984	4208370	6916778	18-8808-2
485	4	Delco	1980	1982	5685394	6218036	18-8808-2
488	4	Delco	1981	1984	6170297	6916778	18-8808-2
140	L6	Delco	1963	1963	1538930	1725960	18-8809-1
150	L6	Delco	1964	1966	1666495	2048046	18-8809-1
160	L6	Delco	1967	1969	2048022	2770031	18-8809-1
165	L6	Delco	1970	1981	2770032	5813433	18-8809-1
200	L6	Delco	1969	1969	2453769	2712072	18-8809-1
185	6	Prestolite	1983	1984	6330183	6919655	18-8801-1
175	6	Thunderbolt IV	1987	1987	0B527955	0B773242	18-8810-1

APPLICATION CONTINUED ON NEXT PAGE

MERCURISER MARINE IGNITION WIRES APPLICATION

Model	Cyl.	Distributor	Year Start	Year Stop	Serial # Start	Serial # End	Plug Wire Set
185	6	Thunderbolt IV	1985	1987	6919656	0B527954	18-8810-1
205	6	Thunderbolt IV	1985	1987	0A331445	0B775129	18-8810-1
262 Mag	6	Delco EST	1996	1997	0F803800	0K999999	18-8835-1
4.3L	6	Thunderbolt IV	1988	1996	0B773243	0F802999	18-8810-1
4.3L Alpha	6	Thunderbolt V	1998	& Up	0L010044	& Up	18-8810-1
4.3L Bravo	6	Thunderbolt V	1998	& Up	0L010044	& Up	18-8810-1
4.3L EFI	6	Delco EST	1998	1998	0L012009	0L359999	18-8835-1
4.3L EFI	6	Thunderbolt V	1999	2004	0L360000	&Up	18-8810-1
4.3L MPI	6	Delco HVS	2001	& Up	0M300000	& Up	18-8829-1
4.3LH Alpha	6	Thunderbolt V	1998	2004	0L010044	& Up	18-8810-1
4.3LH Bravo	6	Thunderbolt V	1998	2004	0L010044	& Up	18-8810-1
4.3LX, LXH	6	Thunderbolt IV	1988	1997	0B775130	0K999999	18-8810-1
215 MCM & MIE (Ford)	8	AutoLite/Mallory	1970	1972	2781153	3563181	18-8803-2
225 MCM & MIE (Ford)	8	AutoLite/Mallory/Mercury	1973	1974	3385721	4166999	18-8803-2
888 (Ford)	8	AutoLite/Mallory	1971	1977	3106723	4887829	18-8803-2
190 (GM)	8	Delco	1963	1964	1564539	1730903	18-8803-2
198 MIE	8	Mallory	1977	1977	4776402	4931099	18-8803-2
200	8	Thunderbolt IV	1985	1987	6899058	8774444	18-8821-1
228	8	Mallory	1977	1982	4765100	6218461	18-8803-2
228	8	Thunderbolt IV	1983	1984	6218462	6899268	18-8821-1
228 MIE	8	Mallory	1977	1980	4765100	5907057	18-8803-2
230	8	Thunderbolt IV	1985	1987	6899269	0B773739	18-8821-1
230 MIE (LH)	8	Thunderbolt IV	1981	1987	5907058	0B788151	18-8821-1
230 MIE (RH)	8	Thunderbolt IV	1981	1987	5907058	0B788151	18-8821-1
5.0L	8	Thunderbolt IV	1988	1995	0B774445	0F600999	18-8821-1
5.0L Alpha	8	Thunderbolt V	1998	& Up	0L015751	& Up	18-8821-1
5.0L Bravo	8	Thunderbolt V	1998	& Up	0L015751	& Up	18-8821-1
5.0L EFI	8	Delco EST	1998	1998	0L012052	0L339999	18-8822-1
5.0L MIE (LH)	8	Thunderbolt IV	1988	1988	0B788152	0C396832	18-8821-1
5.0L MIE (RH)	8	Thunderbolt IV	1988	1988	0B788152	0C396832	18-8821-1
5.0L MPI Alpha	8	Delco HVS	2001	& Up	0M300000	& Up	18-8828-1
5.0LX	8	Thunderbolt IV	1988	1995	0B773740	0F600999	18-8821-1
898	8	Mallory	1977	1982	4762210	6218461	18-8803-2
898	8	Thunderbolt IV	1983	1984	6218462	6899057	18-8821-1
225 (GM)	8	Delco	1963	1969	1539620	2694014	18-8803-2
225 MIE (GM)	8	Thunderbolt	1968	1968	2278647	2694014	18-8803-2
250 MCM & MIE	8	Thunderbolt	1968	1969	2314301	2639854	18-8803-2
250	8	Mallory	1977	1977	4768000	4908849	18-8803-2
255 MCM & MIE	8	Mallory	1975	1976	3258728	4501254	18-8803-2
255 MCM & MIE	8	Mercury	1976	1976	4498701	4787999	18-8803-2
255 MIE	8	Mercury	1977	1980	4768000	5907057	18-8803-2
260	8	Mallory	1978	1982	4908850	6218461	18-8803-2
260	8	Thunderbolt IV	1982	1987	6218462	0B773304	18-8821-1
260 MIE (LH)	8	Thunderbolt IV	1981	1986	5907058	0B788151	18-8821-1
260 MIE (RH)	8	Thunderbolt IV	1981	1986	5907058	0B788151	18-8821-1
270 MCM & MIE	8	Thunderbolt	1969	1972	2851074	3385720	18-8803-2
280 TRS	8	Mercury/Mallory	1975	1975	4176250	4499390	18-8803-2
300	8	Thunderbolt IV	1985	1986	6668677	0B430367	18-8821-1
320 EFI	8	Thunderbolt IV	1987	1989	0A543604	0C622418	18-8821-1
350 Mag Alpha	8	Thunderbolt IV	1986	1994	0A635178	0F353690	18-8821-1
350 Mag Alpha	8	Thunderbolt V	1995	1997	0F353691	0K999999	18-8821-1
350 Mag Alpha EFI	8	Delco EST	1996	1997	0F800300	0K999999	18-8822-1

APPLICATION CONTINUED ON NEXT PAGE

MERCURUISER MARINE IGNITION WIRES APPLICATION

Model	Cyl.	Distributor	Year Start	Year Stop	Serial # Start	Serial # End	Plug Wire Set
350 Mag Bravo MPI	8	Delco EST	1995	1996	0F415189	0K999999	18-8822-1
350 Mag EFI Ski	8	Delco EST	1994	1997	0F215561	0K999999	18-8822-1
350 Mag MPI	8	Delco EST	1998	1998	0L010019	0L325952	18-8822-1
350 Mag MPI Alpha	8	Delco HVS	2001	& Up	0M300000	& Up	18-8828-1
350 Mag MPI Bravo	8	Delco HVS	2001	& Up	0M300000	& Up	18-8828-1
350 Mag MPI Horizon	8	Delco HVS	2001	& Up	0M300000	& Up	18-8828-1
350 Mag MPI Horizon MIE	8	Delco HVS	2001	& Up	0M300000	& Up	18-8828-1
350 Mag MPI MIE	8	Delco HVS	2001	& Up	0M300000	& Up	18-8828-1
350 Mag MPI Ski	8	Thunderbolt IV	1991	1996	0D505450	0K40399	18-8821-1
350 Mag MPI Ski	8	Thunderbolt V	1991	1997	0D505450	0K999999	18-8821-1
5.7L Alpha	8	Thunderbolt IV	1988	1995	0B773305	0F600999	18-8821-1
5.7L Alpha	8	Thunderbolt V	1996	1997	0F601000	& Up	18-8821-1
5.7L Bravo	8	Thunderbolt IV	1988	1993	0B773305	0F353524	18-8821-1
5.7L Bravo	8	Thunderbolt V	1994	& Up	0F353525	& Up	18-8821-1
5.7L EFI	8	Delco EST	1995	1998	0F225560	0L339999	18-8822-1
5.7L EFI MIE	8	Delco EST	1997	1997	0K040300	0K999999	18-8822-1
5.7L MIE	8	Thunderbolt IV	1988	1995	0B788152	0F746099	18-8821-1
5.7L MIE	8	Thunderbolt V	1996	1997	0F622100	0K999999	18-8821-1
5.7L MIE	8	Thunderbolt V	1998	& Up	0L002003	& Up	18-8821-1
5.7L Ski	8	Mallory/Prestolite	1985	1995	0A338553	0F775199	18-8802-1
5.7L Ski	8	Thunderbolt IV	1987	1995	0B514627	0F775199	18-8821-1
5.7L Ski	8	Thunderbolt V	1996	1997	0F775200	0K999999	18-8821-1
5.7L Ski	8	Thunderbolt V	1998	& Up	0L002005	& Up	18-8821-1
5.7LX Alpha & Bravo	8	Thunderbolt V	1996	1997	0F601000	0K999999	18-8821-1
5.7LX Bravo & EFI	8	Delco EST	1996	1997	0F752400	0K999999	18-8822-1
233 MCM & MIE (Ford)	8	Mercury/Prestolite	1975	1977	4173000	4902304	18-8803-2
255 MCM & MIE (Ford)	8	Mercury/Mallory	1973	1980	3258728	5907057	18-8803-2
MX 6.2L MPI	8	Delco HVS	2001	& Up	0M300000	& Up	18-8828-1
MX 6.2L MPI Horizon	8	Delco HVS	2001	& Up	0M300000	& Up	18-8828-1
MX 6.2L MPI Horizon MIE	8	Delco HVS	2001	& Up	0M300000	& Up	18-8828-1
MX 6.2L MPI MIE	8	Delco HVS	2001	& Up	0M300000	& Up	18-8828-1
377 MAG MPI BRAVO	8	Delco HVS	ALL	ALL	1A300000	& Up	18-8828-1
325 MCM & MIE	8	Thunderbolt	1969	1974	2278747	& Up	18-8803-2
325 MCM & MIE	8	Mallory	1969	1972	2278747	& Up	18-8803-2
390	8	Mallory	1968	1970	ALL		18-8803-2
330	8	Mallory	1977	1981	4623115	6083144	18-8803-2
330	8	Thunderbolt	1977	1981	4623115	6083144	18-8803-2
330	8	Thunderbolt IV	1982	1987	6083145	0B816540	18-8821-1
340 MIE	8	Thunderbolt IV	1981	1987	5889914	0B788365	18-8821-1
350 MIE	8	Thunderbolt	1974	1976	3780450	4623109	18-8803-2
370 TRS	8	Mallory/Holley	1978	1985	4179554	6721527	18-8803-2
370 TRS	8	Thunderbolt IV	1985	1987	6721528	0B714586	18-8821-1
400 TRS	8	Mallory/Holley	1980	1986	5688232	0B457644	18-8803-2
440 TRS	8	Mallory/Holley	1983	1986	6181070	0B485220	18-8803-2
450	8	Thunderbolt IV	1995	1996	0F347100	0F347277	18-8821-1
454 Mag Alpha	8	Thunderbolt IV	1986	1988	0A631894	0B785148	18-8821-1
454 Mag Bravo	8	Thunderbolt IV	1988	1997	0B721206	0K999999	18-8821-1
454 Mag EFI	8	Delco EST	1994	1996	0F115700	0F802349	18-8822-1
454 Mag MPI	8	Delco EST	1996	2001	0F802350	M024999	18-8822-1
454 Mag MPI Horizon MIE	8	Delco EST	1999	2001	0L002200	0L674000	18-8822-1

APPLICATION CONTINUED ON NEXT PAGE

MERCURUISER MARINE IGNITION WIRES APPLICATION

Model	Cyl.	Distributor	Year Start	Year Stop	Serial # Start	Serial # End	Plug Wire Set
454 Mag MPI Ski	8	Delco EST	1995	1997	0F215800	0K999999	18-8822-1
7.4L Bravo I, II, III	8	Thunderbolt IV	1988	1997	0B771113	0K999999	18-8821-1
7.4L Bravo III	8	Thunderbolt V	1992	1997	603118	0K999999	18-8821-1
7.4L EFI MIE	8	Thunderbolt IV	1988	1996	0B788366	0F820141	18-8821-1
7.4L MIE	8	Thunderbolt IV	1988	1996	0B788366	0F820141	18-8821-1
7.4L MIE	8	Thunderbolt V	1992	1997	0D715494	0K999999	18-8821-1
7.4L MPI (L29)	8	Delco EST	1998	2001	0L010003	0M024330	18-8822-1
7.4L MPI MIE	8	Delco EST	1995	2001	0F563052	0M025999	18-8822-1
7.4LX Bravo EFI & MPI	8	Delco EST	1996	1997	0F602010	0K999999	18-8822-1
390	8	Thunderbolt	1969	1970	2781129	2825059	18-8803-2
460 TRS	8	Mallory/Holley	1983	1986	6180970	6181046	18-8803-2
460 Cyclone	8	ALL	1983	1985	ALL		18-8803-2
496 Mag & Mag HO	8	Delco (coil over plug)	2000	& Up	0M025000	& Up	18-8838-1
6.1 MIE & HO MIE	8	Delco (coil over plug)	2000	& Up	0M025000	& Up	18-8838-1
502 Mag Bravo	8	Thunderbolt IV	1980	1993	0G678221	0F114528	18-8821-1
502 Mag EFI	8	Delco EST	1993	1996	0B40650	0F802599	18-8822-1
502 Mag MPI	8	Delco EST	1996	2001	0F802600	0M024999	18-8822-1
525 SC	8	Thunderbolt IV	1991	1995	0D456000	0F877734	18-8821-1
8.2L MIE	8	Thunderbolt IV	1990	1996	0C878221	0F819619	18-8821-1
8.2L MPI MIE	8	Delco EST	1996	2001	0F819620	0L674200	18-8822-1



**18-5225
SPARK PLUG WIRE KIT**
Replaces: Mercury 84-99215A26,
84-813706A26, 84-93475A26,
84-93212A1, 84-90816A26
Kit includes 25 ft. roll of 7 MM
hypalon ignition wire with a metallic
core and a large assortment of three
different end fittings.



**18-5226
IGNITION WIRE**
Metallic Core
100' Spool
7mm Hypalon



BATTERY CABLES

Part No.	Size	Color	Gauge	Part No.	Size	Color	Gauge
BC88523	2'	red	4	BC88573	6'	black	2
BC88533	2'	black	4	BC88583	8'	red	1
BC88543	4'	red	2	BC88593	6'	black	1
BC88553	4'	black	2				
BC88563	6'	red	2				

Gauge cable with soldered lug terminals on each end to accept a 3/8" stud

PKG. OF 10



**18-5224
18-5224-9①
SPARK PLUG WIRE
TERMINAL**
Replaces: 20121, 8M0084600

PKG. OF 10



**18-5750
18-5750-9①
UNIVERSAL SPARK
PLUG BOOTS**
Supplied complete w/Terminal Connector



**18-5752
UNIVERSAL
SPARK PLUG BOOT**
8mm

Standard Rotation

CCW Rotation

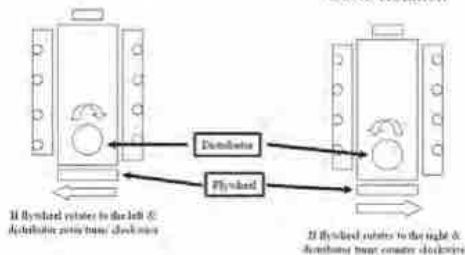

**18-5603-1
STARTER**
Replaces: 50-808011A4
Noiseless:CCW Top mount rear entry starter for
standard rotation GM & Ford engines. Can be
used in place of 18-5908.

NEW

CE



18-55510

INBOARD STARTER

Replaces: 8M0095471

Fits: 4.5L and 6.2L Non-GM Engines

18-6275-1

STARTER

Replaces:

50-807904A1, 50-863007A1, 50-864340A2, 50-806964A4,
50-806964A3, 50-806964A2, 50-812604A2, 50-812428A3,
50-812428A3, 50-12177A2, 50-12121A2, 50-822330A2, 814472,
50-99418A2, 50-77328A3, 50-77328A1

- Permanent Magnet Gear Reduction Starter
- Inboard
- 2 Long Bolt Offset Pattern
- CW Rotation • SAE J1171
- Use w/ Late Model 3.0L Engines with 14" Flywheel

Fits: Volvo Penta, Mercruiser, Marine Power

Uses Solenoid **18-5811**



18-5920

STARTER

PMGR Replacement for 18-5903;

302CID, 351CID Ford Engines



CE

18-5911
STARTER

(Heavy-Duty) (No Core) (Clockwise) (9 tooth) For GM engines, bottom mount straight across bolt pattern. Standard rotation.

Replaces: 50-76965A4, 50-99417A2, 50-99419A3, 50-17251A3

Replacement Solenoid: 18-5837

SAEJ1171



CE

18-5907

STARTER

(Heavy-Duty) (No Core) (Clockwise) (9 tooth) Top mount rear entry starter for opposite rotation GM & Ford engines. Will also replace bottom mount standard rotation. Will not replace non-starter mounted solenoids.

Mercruiser built 4 cyl. 165/170/180/190/470/485/488

Replaces: 50-72550A2, 50-79604A3, 50-97499A2, 50-97499R4, 50-72550R2, 50-97499R3

Replacement Solenoid: **18-5837**

SAEJ1171

18-5913-1**STARTER
(Clockwise)**

Delco permanent magnet gear reduction 2 bolt starter

12V - 11 Tooth - Offset Bolt Pattern

For: Late model GM - 14" Flywheel

Replaces: 50-812428A3, 50-812604A2,
50-822330A2, 50-864340A2

Includes 18-8402-1 (2) bolts

SAEJ1171

For: 4.3L (1996 & UP); 5.0 & 5.7L (1998 & UP)



CE

18-5919-1**STARTER**

Permanent magnet I/O starter, 11 Tooth

Replaces: 50-806963A4, 50-806965A2, 50-806965A4

Includes one 18-8402-1 bolt and one 18-8404 bolt

Fits: Chevy Engines with 12 1/2" flywheels

Straight across bolt pattern

SN-OF803000AN/OF803114AN 4.3LX/LXH Alpha/Bravo 262 CID

SN-355305AN/22560AN 5.7L Alpha (EFI)/5.7L Bravo (EFI)

SAEJ1171



CE

**18-5910****STARTER**

(Heavy-Duty) (No Core) (Clockwise) (9 tooth) Small block V-6 & V-8 GM engine with 14 1/4" flywheel and bottom mount, offset bolt pattern. For standard rotation engines.

Replaces: 50-12177A2, 50-99418A2

**18-5908****STARTER**

(Heavy-Duty) (No Core) (Counter-Clockwise) (9 tooth)

Top mount rear entry starter for standard rotation GM & Ford engines. Front mount reverse rotation.

Replaces: 50-76965A3, 50-808011A1, 50-808011A05, 50-808011A4, 50-808011A3, 50-99419A3, 50-76967A4, 50-76967A1
50-65784A1, 50-47455, 50-17251A3, 50-17251A2

Replacement Solenoid: 18-5837

SEAJ1171



CE



**18-5903
STARTER**
(No Core) (Clockwise) Bottom mount, two bolt pattern for standard rotation Ford engines.
Replaces: 50-69865A1, 50-12872, 50-56886
Replacement Solenoid: 18-5801
*For PMGR style order 18-5920



**18-6870
STARTER**
Replaces: Mercury 50-805833, T
Fits: D7.3L D-tronic 260 LD, 300 1999 year



**18-6946
STARTER**
Replaces: 50-8m8021116
Fits: High Performance 11 Tooth Starter for 6.2L & 8.9L Scorpion HO applications



**18-6947
STARTER**
Replaces: Mercruiser 50-805991
Fits: 7.3L (BRAVO & MIE) DIESEL NAV 444 V-8 1994-1996



**18-6949
STARTER**
Replaces: Mercruiser 50-831001562, 50-831001961
Fits: W04CTA (150 HP) HINO 234 I/L4, W04CTI (210 HP) HINO 234 I/L4



**18-6957
STARTER**
Replaces: Mercruiser 50-801333980, 50-854178, 50-855507



**18-8412
STARTER STUD EXTENDER**
Extends the solenoid stud on PMGR starters for applications that require more accessory wire connections.
Threads: Female M8x1.25, Male 3/8"x16 UNC



**18-2434
FLYWHEEL BELL HOUSING**
Replaces: 814309A1
For: GM V-8's Big & Small Blocks Inboard/Ski Models

STARTER BOLTS



Description	Mercruiser #	Part #
Starter Bolt 3/8 - 16 - 4 3/8 Long	10-8053432	18-8402-1
Starter Bolt 3/8 - 16 - 1 11/16 Long	10-8083434	18-8404-1



**18-5717
STARTER
BRUSH SET**
Replaces: 33270

**18-5804
SOLENOID**
Replaces: 13037
Delco



**18-5837
SOLENOID**
Replaces: 89-18080
Delco



**18-5838
SOLENOID**
Replaces: 33261, 33316,
60687, 89902, 89-99253
Delco



**18-5840
SOLENOID**
Prestolite 15-79,
SAW 4201, SAW4207, SAW4210



BRUSH SET/STARTER SWITCH APPLICATION

Years	Volt.	Starter No.	Brush Set	Starter Switch	Years	Volt.	Starter No.	Brush Set	Starter Switch
1977-82	12	1108755	18-5717	18-5838	1971-78	12	ALL	18-5717	18-5838
1977-82	12	1108756	18-5717	—	1969-78	12	MEO-7003	—	18-5840
1977-82	12	1109484,5,6	18-5717	18-5838					



① **18-5801D** Display Package

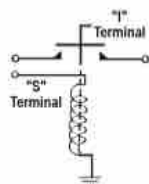

**18-5801
SOLENOID**
Replaces: 89-76416A1



① **18-5802D** Display Package

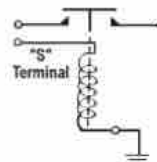

**18-5802
SOLENOID**
Grounded base
Replaces: 65057A1, 65057T1, 65057, 54981

① Items ending in "D" are Display Packaged - Regular number is Non-Display
APPLICATION BEGINS ON PAGE 722

<p>① 18-5810D </p>  <p>18-5810 SOLENOID</p>	 <p>18-5811 STARTER SOLENOID Replaces: 809463A1, 8094631, 809463, 8094621, 809462 For: PG 280 Series Starters, GM V6 & V8 (1983-Up)</p>	<p>① 18-5815D </p>  <p>18-5815 SOLENOID Replaces: 89-68258A4, 89-853654A1, 89-76545, 89-76545T, 89-65258, 89-61053, 89-15857</p>	
<p>① 18-5816D </p>  <p>18-5816 SOLENOID Replaces: 89-96054, T, 89-91975 (Flat Bracket)</p>	<p>① 18-5817D </p>  <p>18-5817 SOLENOID Replaces: 89-96158, 89-96158T, 94318, 846070 (Curved Bracket)</p>	 <p>18-5820 SOLENOID Replaces: 89-818999A2, 89-825842A1, 89-850188T1</p>	
<p>① 18-5836D </p>  <p>18-5836 SOLENOID Replaces: 25661, 256611, 25661T1</p>	 <p>18-9802 TIMING LIGHT Self-powered accurate up to 10,000 RPM's</p>	 <p>18-6749 TRIM BRACKET Metal Bracket Replaces: 862548A1, 42419A1, 88893A4, 88553A1, 862548A1, 58397A3, 58397A2, 42419A1 For: MerCruiser Floor Mount Bracket</p>	 <p>18-6750 TRIM BRACKET Stainless Steel Replaces: 862548A1, 42419A1 For: MerCruiser Floor Mount Bracket</p>
 <p>18-6747 TILT/TRIM ASSEMBLY Replaces: 865380A25, 865380A15, 865380A05, 865380A02, 14336A28, 14336A22, 14336A17, 14336A15, 14336A9, 14336A6, 88183A12, 88183A3 For late model sterndrive applications</p>	 <p>18-6752 HYDRAULIC TRIM PUMP ASSEMBLY Low Pressure - High Flow Metal Bracket Replaces: 14336A9, 88183A12, 96477A3, 88183A11, 88183A6, 14336A28, 14336A22, 14336A17, 14336A15, 14336A6 Fits: 1983 and Later without "quick connect" Replacement Motor: 18-6772 20 amp fuse</p>	 <p>18-6753 HYDRAULIC TRIM PUMP ASSEMBLY Low Pressure - High Flow Stainless Steel Bracket Replaces: 14336A9, 88183A12 Fits: 1983 and Later without "quick connect" Replacement Motor: 18-6772 20 amp fuse</p>	
<p>① Items ending in "D" are Display Packaged - Regular number is Non-Display APPLICATION BEGINS ON PAGE 722</p>			



18-6768
COMPLETE POWER TRIM PUMP ASSEMBLY
 Steel Bracket
 Replaces: 93247A7, 93247A4, 392-8261A1, 392-8263, 88475A4, 79271A4, 74436A9
 Replacement pump for Prestolite high pressure/low flow system. Primarily used 1982 and earlier. 20 amp fuse.



18-6799
COMPLETE POWER TRIM PUMP ASSEMBLY
 Stainless Steel Bracket
 Replaces: 93247A7, 93247A4, 392-8261A1, 392-8263, 88475A4, 79271A4, 74436A9
 Replacement pump for Prestolite high pressure/low flow system. Salt water series. Stainless steel bracket. Primarily used 1982 and earlier. 20 amp fuse.



18-6763
TILT/TRIM MOTOR
 Replaces: 92975A6, 79271A4, 67914A2, 92975A32, 93247A7
 To 1984. Fits most Mercuriser Stemdrives (Motor and Reservoir Only)
 For Repair Kit use: **18-6253**



18-6769-1
TILT/TRIM PUMP
 Low Pressure - High Flow
 Replaces: 14336A8, 88183A5 From 1984
 Fits: Most Mercuriser Stemdrives



18-6772
TILT PUMP MOTOR
 Replaces: 17649, 17649T, 891736T
 For late style Alpha I, Generation II, and Bravo drives; early style square motors.
 Mercuriser Stemdrive replacement for Oildyne units.



18-6813
TRIM MOTOR
 Low pressure/high flow
 Replaces: 14336A6, A8, A9, A15, A20, 88183A5, A8, A12, 865380A13
 Same as 18-6769-1, plus wiring
 Replacement Solenoid: **18-5817**



18-6746
TILT/TRIM ASSEMBLY
 Replaces: 14336A20, 14336A25, 14336A31, 14336A8, 865380A03, 865380A13, 88183A5



18-6771
TILT/TRIM RESERVOIR
 Replaces: 18525, 18525A1, 17646



18-6778
TILT/TRIM RESERVOIR
 Replaces: 883166A1, 883166A2
 For: Tilt Motors with 4 Screw Attachments



18-6823
WIRING HARNESS
 Replaces: Universal
 Converts 3-wire Tilt and Trim motors to 2-Wire design



18-6253
COMMUTATOR END PLATE
 For: Use with 18-6763



18-15501
CIRCUIT BREAKER
 Replaces: 88-93582
 60 AMP



18-6255
POWER TRIM BRUSH
 Replaces: 392-8989
 For: Use with Prestolite Pumps (Mercury #'s 93247A4)



18-5945
ALTERNATOR
 (3-Wire) (No Core) (68 AMP) · SAE J1171
 Replaces Mando, Motorola and original equipment Deico. Uses same electrical connections and mounting method. Equipped with fan and serpentine drive pulley.



18-5946
ALTERNATOR
 (1-Wire) (No Core) (68 AMP)
 Single wire connection fits Mercuriser and many other applications. Equipped with fan and serpentine drive pulley.
 SAE J1171



**18-5956
ALTERNATOR**
(1-Wire) (No Core) (68 AMP)
Single wire connection fits Mercruiser and many other applications. Equipped with fan and drive pulley.
Replaces: 69729, 90794, 78403A2, 78403A1, 78477, 59755, 56045
SAE J1171



**18-5957
ALTERNATOR**
(3-Wire) (68 AMP)
Replaces Mando, Motorola and original equipment Delco. Uses same electrical connections and mounting method. Equipped with fan and drive pulley.
Replaces: 78477, 78403A2, 92497A3, 78403A1, 90794, 69729, 59755, 56045, 817119A4, 817119A1, 98555A1, 92497, 12449A1, 12449
SAE J1171



**18-5960
ALTERNATOR**
Serpentine Pulley • 65 Amp
Replaces: 807653T • SAE J1171



**18-5965
ALTERNATOR**
65 Amp
Replaces: 817119A1, 817119A4, 805884T, 98555A1, 92497A3, 92497, 12449A1, 12449
SAE J1171



**18-5967
ALTERNATOR**
Serpentine Pulley • 55 Amp
Replaces: 807652T
SAE J1171



**18-5966
ALTERNATOR**
Single Groove Pulley • 55 Amp
Replaces: 817119A4, 12449A1, 98555A1, 92497, 817119A1, 12449A1, 12449
SAE J1171



**18-5983
ALTERNATOR**
Replaces: 862030T • SAE J1171
75i/70 amp, Hinge Mount, Single Groove Pulley



**18-6293
ALTERNATOR**
Replaces: 862031T, 862031T1 • SAE J1171
75i/70 amp, Hinge Mount,
Serpentine Pulley 2.44" Diameter



**18-6298
ALTERNATOR**
Replaces: 863077T • SAE J1171
75i/70 amp, Hinge Mount,
Serpentine Pulley 1.97" Diameter



**18-6841
ALTERNATOR**
Replaces: 56045, 59755, 69729, 78403A2, 78403A1, 78477, 90794
For: 37-63A Marine Applications



**18-6842
ALTERNATOR**
Replaces: 56045, 59755, 69729, 78403A2, 78403A1, 78477, 90794
For: 37-63A Marine Applications



**18-6844
ALTERNATOR**
Replaces: Mercruiser 834832, T2, 857006A3, Denso 101211-3460



**18-6948
ALTERNATOR**
Replaces: 882571, 8M0084523
Fits: CMD 1.7 Mi 120 i/L4, CMD 1.7 MS 120 i/L4, D1.7L DTI



**18-6960
ALTERNATOR**
Replaces: Mercruiser 821663, 8216631, 821663A1
Denso 101211-3020, 3021



**18-6975
ALTERNATOR (Universal)**
Fits: High amp 160A alternator, universal mounting pattern based on Delco CS1300 design, v-belt and 6 groove serpentine pulley included



18-5953-1

ALTERNATOR CONVERSION KIT

Includes new 18-5956 68 AMP alternator, mounting brackets 18-5968, pulley (8.0" O.D. x 2.75" H), wiring, hardware and instructions. Converts model 470 aluminum block Mercuriuser engines serial number 4625580 & up with stator charging system and water cooled voltage regulator to alternator system. **NOTE: Fuse kit 18-8220 (sold separately) is required on engines with a Delco starter (round solenoid mounted to starter); Prestolite starters with remote solenoid DO NOT require fuse kit. Visually inspect starter prior to ordering conversion kit.**
For: Mercuriuser 224 / 3.7L



18-5968

ALTERNATOR BRACKET

Replacement bracket for alternator conversion kit used on 470 Series Mercuriuser included in 18-5953-1 kit.



18-5724

VOLTAGE REGULATOR

Replaces: 78385



18-5740

VOLTAGE REGULATOR

Replaces: 42785



18-8220

FUSE KIT

Replaces: 88-79023A91
For use with 18-5953-1 alternator conversion kits installed on Mercuriuser (Model 470) 3.7 liter aluminum block engines serial number 6902288 & Up. 90 AMP

Model	Cyl.	Years	Eng Serial #	End Serial #	Slave Solenoid	Reman Starter	New Starter	Reman Alternator	New Alternator
110	GM 4	1963-1966	1538370	2044033	18-5836	18-5911	18-5911	—	—
120	GM 4	1964-1975	1666601	4469865	18-5836	18-5911	18-5911	18-5957	18-5957
120	GM 4	1976-1982	4469866	6229717	18-5815	18-5911	18-5911	18-5957	18-5957
120 / 2.5L	GM 4	1983-1989	6229718	C853255	18-5817	18-5911	18-5911	—	18-5966 ④
140	GM 4	1968-1975	2508261	4460664	18-5836	18-5911	18-5911	18-5957	18-5957
140	GM 4	1976-1981	4460665	6229717	18-5815	18-5911	18-5911	18-5957	18-5957
140/3.0L	GM 4	1982-1989	6229718	C856558	18-5817	18-5911	18-5911	18-5957	18-5957
140/3.0L	GM 4	1999-2001	0L382122	0M326292	18-5817	—	18-6275-1	—	18-5963 **
140/3.0L/3.0LX	GM 4	1990-92	C856559	D831100	18-5817	18-5911	18-5911	18-5957	18-5957
140/3.0LX	GM 4	1992-97	D831101	0K999999	18-5817	N/A	18-6275-1	—	18-5966 ④
165/3.7L	Merc 4	1987-1989	B434941	C762299	18-5802	18-5907	18-5907	N/A	N/A
170	Merc 4	1985-1986	6916779	B434940	18-5802	18-5907	18-5907	N/A	N/A
180/3.7LX	Merc 4	1987-1989	B436391	C762299	18-5802	18-5907	18-5907	N/A	N/A
190	Merc 4	1985-1986	6916779	B436390	18-5802	18-5907	18-5907	N/A	N/A
470	Merc 4	1976-1984	4208730	6916778	18-5802	18-5907	18-5907	N/A	N/A
470MIE	Merc 4	1980-1981	5520115	6218036	18-5802	18-5907	18-5907	N/A	N/A
485	Merc 4	1980-1984	5685394	6916778	18-5802	18-5907	18-5907	N/A	N/A
140	GM 6	1963	1538930	1725960	18-5836	18-5911	18-5911	—	—
150	GM 6	1964-66	1666495	2048046	18-5836	18-5911	18-5911	—	—
160	GM 6	1967-69	2048022	2768031	18-5836	18-5911	18-5911	—	—
160	GM 6	1969	2768032	2770031	18-5836	18-5911	18-5911	18-5957	18-5957
165	GM 6	1970-1975	2770032	4471565	18-5836	18-5911	18-5911	18-5957	18-5957
165	GM 6	1976-1981	4471566	5813433	18-5815	18-5911	18-5911	18-5957	18-5957
200	GM 6	1969	2453769	2712072	18-5836	18-5911	18-5911	—	—
175/4.3L	GM V-6	1987-1992	B527955	D714108	18-5816	—	18-5913-1	—	18-5966 ④
185	GM V-6	1983-1984	6330183	6919655	18-5816	18-5911	18-5911	—	18-5966 ④

① For 12 3/4" Dia. Flywheel
 ② For 14" Dia. Flywheel
 ③ For permanent magnet models use 18-5919-1
 ④ 55 AMP up grade to 65 AMP use 18-5965
 ⑤ Black
 ⑥ For permanent magnet models use 18-5913-1
 ⑦ Bravo drive

⑧ Firepower ignition
 ⑨ Ignition module mounted on distributor
 ⑩ Ignition module mounted on elbow
 ⑪ LH rotation
 ⑫ N/A for models prior to S/N 4167000
 ⑬ PG 260 (9-1/4" long)
 ⑭ PG260F1 (8-1/2" long)

⑮ RH Rotation
 ⑯ Standard Ignition
 ⑰ Thunderbolt Ignition
 ⑱ Thunderbolt IV
 ⑲ Thunderbolt V
 ⑳ Transmission models
 ** Delco Style

Model	Cyl.	Years	Eng Serial #	End Serial #	Slave Solenoid	Reman Starter	New Starter	Reman Alternator	New Alternator
185	GM V-6	1985-1987	A331455	B527954	18-5816	N/A	18-5913-1	—	18-5966 ④
205	GM V-6	1985-1991	A331455	D714369	18-5816	N/A	18-5913-1	—	18-5966 ④
262 Mag. EFI	GM V-6	1996-1997	F803800	K999999	18-5817	N/A	18-5913-1	—	18-5960
262 Mag. EFI	GM V-6	1996-1997	F803800	K999999	18-5817	N/A	18-5913-1	—	18-5960
4.3L/LX/LXH	GM V-6	1992-1997	D714107	K999999	18-5817	—	18-5913-1	—	18-5967
4.3L/LX/LXH	GM V-6	1996-1997	F803000	K999999	18-5817	—	18-5913-1	—	18-5967
4.3L/LH	GM V-6	1998-99	L010044	OL618999	18-5817	—	18-5913-1	—	18-5967
4.3L/LH(Gen +)	GM V-6	2000-02	OL619000	OM320024	18-5817	—	18-5913-1	—	18-6293 **
4.3EFI	GM V-6	1998-99	L012009	OL618999	18-5817	—	18-5913-1	—	18-5960
4.3L EFI	GM V-6	2000-01	OL619000	OM299999	18-5817	—	18-5913-1	—	18-6293 **
4.3L MPI	GM V-6	2002	OM300000	OM320024	18-5817	—	18-5913-1	—	18-6293 **
190	GM V-8	1963-1964	1564539	1730903	18-5836	18-5911	18-5911	—	—
200	GM V-8	1985-1986	6218462	B525981	18-5816	18-5911	18-5911 ① ③	—	18-5966 ④
200	GM V-8	1985-1986	6218462	B525981	18-5816	18-5910	18-5910 ② ⑤	—	18-5966 ④
200/5.0L	GM V-8	1987-1995	B525982	F600999	18-5816	18-5910	18-5910	—	18-5966 ④
200/5.0L	GM V-8	1987-1995	B525982	F600999	18-5817	18-5910	18-5910	—	18-5966 ④
215 MCM & MIE	Ford V-8	1970-1972	2781153	3563181	18-5836	18-5908	18-5908 ⑥	18-5957	18-5957
215 MCM & MIE	Ford V-8	1970-1972	2781153	3563181	18-5836	18-5907	18-5907 ⑥	18-5957	18-5957
225	Ford V-8	1973-1974	3385721	4166999	18-5802	18-5903	—	18-5957	18-5957
225 MIE	Ford V-8	1973-1974	3385721	4176999	18-5836	18-5908	18-5908 ⑥	18-5957	18-5957
225 MIE	Ford V-8	1973-1974	3385721	4176999	18-5836	18-5907	18-5907 ⑥	18-5957	18-5957
888	Ford V-8	1971-1977	3108723	4612109	18-5802	18-5903	— ⑥	18-5957	18-5957
888	Ford V-8	1971-1977	4612110	& Up	18-5801	18-5903	—	18-5957	18-5957
225	GM V-8	1963-1966	1539620	2278646	18-5836	18-5911	18-5911	—	—
225 MIE	GM V-8	1968	2278647	2694014	18-5836	18-5908	18-5908 ⑥	—	—
225 MIE	GM V-8	1968	2278647	2694014	18-5836	18-5907	18-5907 ⑥	—	—
225	GM V-8	1967-1969	2278647	2694014	18-5836	—	—	—	—
228/230	GM V-8	1977-1986	4765100	B525981	18-5816	18-5911	18-5911 ① ③	—	18-5966 ④
228/230	GM V-8	1977-1986	4765100	B525981	18-5816	18-5910	18-5910 ② ⑤	—	18-5966 ④
228 MIE	GM V-8	1977-1980	4765100	5907057	18-5815	18-5908	18-5908 ⑥	18-5957	18-5957
228 MIE	GM V-8	1977-1980	4765100	5907057	18-5815	18-5907	18-5907 ⑥	18-5957	18-5957
230/5.0LX	GM V-8	1987-1995	B525982	F600999	18-5816 ⑦	18-5910	18-5910 ③	—	18-5966 ④
230/5.0LX	GM V-8	1987-1995	B525982	F600999	18-5817 ⑧	18-5910	18-5910 ③	—	18-5966 ④
230/5.0L MIE	GM V-8	1987-1988	5907058	B788151	18-5816	18-5908	18-5908 ⑥	—	18-5966 ④
230/5.0L MIE	GM V-8	1987-1988	5907058	B788151	18-5816	18-5907	18-5907 ⑥	—	18-5966 ④
5.0L(Gen +)	GM V-8	1998-99	L015751	L618999	18-5817	—	18-5913-1	—	18-5967
5.0L(Gen +)	GM V-8	2000-2002	L619000	M320024	18-5817	—	18-5913-1	—	18-6293 **
5.0L EFI	GM V-8	1998-99	L012052	L618999	18-5817	—	18-5913-1	—	18-5960
5.0L EFI	GM V-8	2000-01	L619000	M299999	18-5817	—	18-5913-1	—	18-6293 **
5.0L MPI	GM V-8	2002	M300000	M320024	18-5817	—	18-5913-1	—	18-6293 **
198 MIE	GM V-8	1977	4762210	6218461	18-5815	18-5908	18-5908 ⑥	18-5957	18-5957
198 MIE	GM V-8	1977	4762210	6218461	18-5815	18-5907	18-5907 ⑥	18-5957	18-5957
896	GM V-8	1977-1982	4762210	6218461	18-5801	18-5911	18-5911	18-5957	18-5957

① For 12 3/4" Dia. Flywheel
 ② For 14" Dia. Flywheel
 ③ For permanent magnet models use 18-5919-1
 ④ 55 AMP up grade to 65 AMP use 18-5965.
 ⑤ Black
 ⑥ For permanent magnet models use 18-5913-1
 ⑦ Bravo drive
 ⑧ Firepower Ignition
 Ignition module mounted on distributor
 Ignition module mounted on elbow
 ⑨ LH rotation
 ⑩ NLA for models prior to S/N 4167000
 ⑪ PG 260 (9-1/4" long)
 ⑫ PG260F1 (8-1/2" long)
 ⑬ RH Rotation
 Standard Ignition
 ⑭ Thunderbolt Ignition
 ⑮ Thunderbolt IV
 ⑯ Thunderbolt V
 ⑰ Transmission models
 ⑱ Delco Style

Model	Cyl.	Years	Eng Serial #	End Serial #	Slave Solenoid	Reman Starter	New Starter	Reman Alternator	New Alternator
898	GM V-8	1983-1984	621462	8525981	18-5816	18-5911	18-5911 ① ②	—	18-5966 ④
898	GM V-8	1983-1984	621462	8525981	18-5816	18-5910	18-5910 ② ③	—	18-5966 ④
233	Ford V-8	1975-1977	4173000	4902304	18-5801	18-5903	—	18-5957	18-5957
233 MIE	Ford V-8	1975-1976	4173000	4775784	18-5836	18-5908	18-5908 ①	18-5957	18-5957
233 MIE	Ford V-8	1975-1976	4173000	4775784	18-5836	18-5907	18-5907 ②	18-5957	18-5957
250 MCM & MIE	GM V-8	1968-1969	2314301	2639854	18-5836	18-5908	18-5908 ①	—	—
250 MCM & MIE	GM V-8	1968-1969	2314301	2639854	18-5836	18-5907	18-5907 ②	—	—
250	GM V-8	1977	4768000	4908849	18-5801	18-5911	18-5911	18-5957	18-5957
255	Ford V-8	1973-1974	3258728	4175499	18-5802	18-5903	—	18-5957	18-5957
255 MIE	Ford V-8	1973-1974	3258728	4178299	18-5836	18-5908	18-5908 ①	18-5957	18-5957
255 MIE	Ford V-8	1973-1974	3258728	4178299	18-5836	18-5907	18-5907 ②	18-5957	18-5957
255	GM V-8	1975-1976	4175500	4767999	18-5815	18-5911	18-5911	18-5957	18-5957
255 MIE	GM V-8	1975-1980	4175500	5907057	18-5815	18-5908	18-5908 ①	18-5957	18-5957
255 MIE	GM V-8	1975-1980	4175500	5907057	18-5815	18-5907	18-5907 ②	18-5957	18-5957
260	GM V-8	1978-1982	4908850	6218461	18-5801	18-5911	18-5911	18-5957	18-5957
260	GM V-8	1982-1986	6218462	8525981	18-5816	18-5911	18-5911 ① ②	—	18-5966 ④
260	GM V-8	1982-1986	6218462	8525981	18-5816	18-5910	18-5910 ② ③	—	18-5966 ④
260/5.7L	GM V-8	1987-1995	8525982	F600999	18-5816 ③	18-5910	18-5910 ④	—	18-5966 ④
260/5.7L	GM V-8	1987-1995	8525982	F600999	18-5817 ④	18-5910	18-5910 ④	—	18-5966 ④
260/5.7L MIE	GM V-8	1987-1995	5907058	F746099	18-5816	18-5908	18-5908 ①	—	18-5966 ④
260/5.7L MIE	GM V-8	1987-1995	5907058	F746099	18-5816	18-5907	18-5907 ②	—	18-5966 ④
5.7L/LX	GM V-8	1996	F601000	K001526	18-5817	—	18-5913-1	—	18-5966 ④
5.7L/LX	GM V-8	1997 & Up	K001527	& Up	18-5817	—	18-5913-1	—	18-5967
5.7L	GM V-8	2000-02	L619000	M320024	18-5817	—	18-5913-1	—	18-6293 **
5.7L/LX EFI	GM V-8	1995-1996	F225560	K001505	18-5816	—	18-5913-1	—	18-5965
5.7L/LX EFI	GM V-8	1997	K001506	K999999	18-5816	—	18-5913-1	—	18-5966
5.7L EFI	GM V-8	1998 & Up	L010035	& Up	18-5816	—	18-5913-1	—	18-5966
5.7L EFI	GM V-8	2000-01	L619000	M299999	18-5816	—	18-5913-1	—	18-6293 **
5.7L MIE	GM V-8	1994-1996	F622151	K040306	18-5816	18-5908	18-5908 ①	—	18-5966 ④
5.7L MIE	GM V-8	1994-1996	F622151	K040306	18-5816	18-5907	18-5907 ②	—	18-5966 ④
5.7L MIE	GM V-8	1997 & Up	K040307	& Up	18-5817	18-5908	18-5908	—	18-5967
5.7L MIE	GM V-8	1998-01	L002003	L677226	18-5817	18-5908	18-5908	—	18-6293 **
5.7L EFI MIE	GM V-8	1997	K040300	K999999	18-5816	18-5908	18-5908	—	18-5966
5.7L Ski	GM V-8	1985-1995	A338533	F775199	18-5816	—	18-5913-1 ⑤	—	18-5966 ④
5.7L Ski	GM V-8	1985-1995	A338533	F775199	18-5816	18-5907	18-5907 ②	—	18-5966 ④
5.7L Ski	GM V-8	1996	F775200	K040003	18-5817	—	18-5913-1	—	18-5966 ④
5.7L Ski	GM V-8	1997	K040004	K999999	18-5817	—	18-5913-1	—	18-5967
5.7L Ski	GM V-8	1998 & Up	L002005	& Up	18-5817	—	18-5913-1	—	18-5967
5.7L Ski	GM V-8	2000-01	L619000	L678784	18-5817	—	18-5913-1	—	18-6293 **
350 Mag. Alpha	GM V-8	1986-1995	A635178	F600999	18-5816 ③	18-5910	18-5910 ④	—	18-5966 ④
350 Mag. Alpha	GM V-8	1987-1996	8525982	K001526	18-5817 ④	18-5910	18-5910 ④	—	18-5966 ④
350 Mag. Alpha	GM V-8	1997	K001527	K999999	18-5817	—	18-5913-1	—	18-5967
350 Mag. EFI & MPI	GM V-8	1995-1996	F415189	K001500	18-5816	—	18-5913-1	—	18-5965
350 Mag. EFI & MPI	GM V-8	1997 & Up	K001501	& Up	18-5816	—	18-5913-1	—	18-5966
350 Mag MPI	GM V-8	2000-01	L619000	M299999	18-5816	—	18-5913-1	—	18-6293 **

① For 12 3/4" Dia. Flywheel
 ② For 14" Dia. Flywheel
 ③ For permanent magnet models use 18-5919-1
 ④ 55 AMP up grade to 65 AMP use 18-5965
 ⑤ Black
 ⑥ For permanent magnet models use 18-5913-1
 ⑦ Bravo drive

⑧ Firepower ignition
 ⑨ Ignition module mounted on distributor
 ⑩ Ignition module mounted on elbow
 ⑪ LH rotation
 ⑫ NLA for models prior to S/N 4167000
 ⑬ PG 260 (9-1/4" long)
 ⑭ PG260F1 (8-1/2" long)

⑮ RH Rotation
 ⑯ Standard ignition
 ⑰ Thunderbolt ignition
 ⑱ Thunderbolt IV
 ⑲ Thunderbolt V
 ⑳ Transmission models
 ㉑ Delco Style

Model	Cyl.	Years	Reg Serial #	End Serial #	Slave Solenoid	Reman Starter	New Starter	Reman Alternator	New Alternator
350 Mag MPI / Horizon	GM V-8	2002	M300000	M320024	18-5817		18-5913-1		18-6293 **
350 Mag MPI MIE	GM V-8	1998 & Up	L002008	& Up	18-5816	18-5908	18-5908	—	18-5960
350 Mag MPI MIE / Horizon	GM V-8	1999-01	L304700	L678398	18-5816	18-5908	18-5908		18-6293 **
350 Mag Ski	GM V-8	1991-1996	D505450	K040399	18-5816 ④	—	18-5913-1	—	18-5966 ④
350 Mag Ski	GM V-8	1991-1996	D505450	K040399	18-5817 ④	—	18-5913-1	—	18-5966 ④
350 Mag Ski	GM V-8	1997	K040400	K999999	18-5817	—	18-5913-1	—	18-5967
350 Mag EFI Ski	GM V-8	1994-1997	F215561	K999999	18-5816	—	18-5913-1	—	18-5965
350 Mag MPI Ski	GM V-8	1995-1996	F350583	F799999	18-5816	—	18-5913-1	—	18-5965
350 Mag MPI Ski	GM V-8	1998 & Up	L002600	& Up	18-5817	—	18-5913-1	—	18-5960
350 Mag MPI Ski	GM V-8	1998-02	L002600	M310021	18-5817	—	18-5913-1	—	18-6293 **
Black Scorpion	GM V-8	1996	F800000	K040000	18-5816	—	18-5913-1	—	18-5965
Black Scorpion	GM V-8	1997 & Up	K040001	& Up	18-5816	—	18-5913-1 ④	—	18-5960
Black Scorpion	GM V-8	1997 & Up	K040001	& Up	18-5816	—	18-5913-1 ④	—	18-5960
Black Scorpion	GM V-8	1997-01	K040001	L678036	18-5816	—	18-5913-1	—	18-6293 **
270 MCM & MIE	GM V-8	1969-1972	2851074	3385720	18-5836	18-5908	18-5908 ④	18-5957	18-5957
270 MCM & MIE	GM V-8	1969-1972	2851074	3385720	18-5836	18-5907	18-5907 ④	18-5957	18-5957
280 TRS	GM V-8	1975-1976	4176250	4770199	18-5815	18-5911	18-5911	18-5957	18-5957
300 TR TEMPEST	GM V-8	1985-1986	6668677	B430367	18-5816	18-5908	18-5908	—	18-5966 ④
300 MR TEMPEST	GM V-8	1985-1986	6668677	B430367	18-5816	—	18-5919-1 ①	—	18-5966 ④
300 MR TEMPEST	GM V-8	1985-1986	6668677	B430367	18-5816	—	18-5913-1 ②	—	18-5966 ④
320 EFI	GM V-8	1987-1989	A543604	C622418	18-5816	—	18-5913-1	—	18-5966 ④
MX 6.2L MPI	GM V-8	2000-2002	L680003	M320024	18-5817	—	18-5913-1	—	18-6293
MX 6.2L MPI Horizon	GM V-8	2002	M300000	M320024	18-5817	—	18-5913-1	—	18-6293
MX 6.2L MPI Horizon MIE	GM V-8	2002	M300000	M310099	18-5817	—	18-5603	—	18-6293
MX 6.2L MPI MIE	GM V-8	2002	M300000	M310099	18-5817	—	18-5603	—	18-6293
MX 6.2L Black Scorpion Ski	GM V-8	2001	L670015	L678036	18-5816	—	18-5913-1	—	18-6293
325 MCM & MIE	GM V-8	1968-1970	2278747	2761141	18-5836	18-5908	18-5908 ④	—	—
325 MCM & MIE	GM V-8	1968-1970	2278747	2761141	18-5836	18-5907	18-5907 ④	—	—
325 MCM & MIE	GM V-8	1970-1974	2761142	3780449	18-5836	18-5908	18-5908 ④	18-5957	18-5957
325 MCM & MIE	GM V-8	1970-1974	2761142	3780449	18-5836	18-5907	18-5907 ④	18-5957	18-5957
330	GM V-8	1977-1981	4623115	6083144	18-5836 ④	—	18-5913-1	18-5957	18-5957
330	GM V-8	1977-1981	4623115	6083144	18-5815 ④	—	18-5913-1	18-5957	18-5957
330	GM V-8	1982-1987	6083145	B816540	18-5816	18-5908	18-5908	—	18-5966 ④
330 MIE	GM V-8	1977-1980	4623115	5889913	18-5836 ④	18-5908	18-5908 ④	18-5957	18-5957
330 MIE	GM V-8	1977-1980	4623115	5889913	18-5815 ④	18-5907	18-5907 ④	18-5957	18-5957
340/7.4L MIE w/BW	GM V-8	1981-1992	5889914	D715493	18-5816	18-5908	18-5908 ④	—	18-5966 ④
340/7.4L MIE w/BW	GM V-8	1981-1992	5889914	D715493	18-5816	18-5907	18-5907 ④	—	18-5966 ④
7.4L	GM V-8	1988-1991	B771113	D603117	18-5816	18-5910	18-5910 ④	—	18-5966 ④
7.4L	GM V-8	1988-1996	B771113	F800699	18-5816 ④	18-5910	18-5910 ④	—	18-5966 ④
7.4L	GM V-8	1992-1997	D603118	K999999	18-5817 ③	—	18-5913-1	—	18-5966 ④
7.4LX EFI & MPI	GM V-8	1996-1997	F602010	K999999	18-5816	—	18-5913-1	—	18-5965
7.4L MPI	GM V-8	1998 & Up	L010003	& Up	18-5817	—	18-5913-1	—	18-6293
7.4L MIE	GM V-8	1989-1996	C391564	F820141	18-5816 ④	18-5908	18-5908	—	18-5966 ④
7.4L MIE	GM V-8	1992-1997	D715494	K999999	18-5817 ④	18-5908	18-5908	—	18-5966 ④
7.4L EFI & MPI MIE	GM V-8	1995-1997	F563052	K999999	18-5816	18-5908	18-5908	—	18-5965
7.4L MPI MIE	GM V-8	1998 & Up	L002006	& Up	18-5817	18-5908	18-5908	—	18-6293
350 MIE	GM V-8	1974-1976	3780450	4623109	18-5836	18-5908	18-5908 ④	18-5957	18-5957
350 MIE	GM V-8	1974-1976	3780450	4623109	18-5836	18-5907	18-5907 ④	18-5957	18-5957
370 TRS	GM V-8	1978-1985	4179554	6721527	18-5815	18-5908	18-5908	18-5957	18-5957

① For 12 3/4" Dia. Flywheel
 ② For 14" Dia. Flywheel
 ③ For permanent magnet models use 18-5919-1
 55 AMP up grade to 65 AMP use 18-5965
 ④ Black
 ⑤ For permanent magnet models use 18-5913-1
 Bravo drive

⑥ Firepower ignition
 ⑦ Ignition module mounted on distributor
 ⑧ Ignition module mounted on elbow
 ⑨ LH rotation
 ⑩ NLA for models prior to S/N 4167000
 PG 260 (8-1/4" long)
 PG260F1 (8-1/2" long)













⑪ RH Rotation
 ⑫ Standard Ignition
 ⑬ Thunderbolt Ignition
 ⑭ Thunderbolt IV
 ⑮ Thunderbolt V
 ⑯ Transmission models
 Delco Style

Model	Cyl.	Years	Eng Serial #	End Serial #	Slave Solenoid	Reman Starter	New Starter	Reman Alternator	New Alternator
370 TRS	GM V-8	1978-1985	4179554	6721527	18-5815	18-5908	18-5908	—	18-5966 ④
370 TRS	GM V-8	1985-1987	6721526	8714586	18-5816	18-5908	18-5908	—	18-5966 ④
390 MCM & MIE	GM V-8	1969-1970	2781129	3042731	18-5836	18-5908	18-5908 ①	18-5957	18-5957
390 MCM & MIE	GM V-8	1969-1970	2781129	3042731	18-5836	18-5907	18-5907 ②	18-5957	18-5957
400 TRS	GM V-8	1980-1986	4179554	8457644	18-5815	18-5908	18-5908	18-5957	18-5957
400 TRS	GM V-8	1980-1986	4179554	8457644	18-5815	18-5908	18-5908	—	18-5966 ④
420	GM V-8	1987-1989	A398941	B622418	18-5816	18-5908	18-5908	—	18-5966 ④
425	GM V-8	1990-1992	A398941	D937011	18-5816	18-5908	18-5908	—	18-5966 ④
440 TRS	GM V-8	1983-1986	4179554	8485220	18-5815	18-5908	18-5908	18-5957	18-5957
440 TRS	GM V-8	1983-1986	4179554	8485220	18-5815	18-5908	18-5908	—	18-5966 ④
450	GM V-8	1995-1996	F347100	F347277	18-5820	—	18-5913-1	—	—
454 Mag.	GM V-8	1986-1994	A631894	F304999	18-5816	—	18-5913-1	—	18-5966 ④
454 Mag.	GM V-8	1995-1997	F305000	K999999	18-5817	—	18-5913-1	—	18-5966 ④
454 Mag. MPI	GM V-8	1994-1997	F115700	K999999	18-5816	—	18-5913-1	—	18-5965
454 Mag. MPI	GM V-8	1998 & Up	L010029	& Up	18-5816	—	18-5913-1	—	18-6293
454 Mag. MPI MIE	GM V-8	1996-1997	F820100	K999999	18-5816	—	18-5913-1	—	18-5965
454 Mag. MPI MIE	GM V-8	1998 & Up	L002200	& Up	18-5816	18-5908	18-5908	—	18-6293
454 EFI Ski	GM V-8	1995-1996	F215800	F820099	18-5816	—	18-5913-1	—	18-5965
460 TRS	GM V-8	1983-1986	4179554	6181046	18-5815	18-5908	18-5908	18-5957	18-5957
460 TRS	GM V-8	1983-1986	4179554	6181046	18-5815	18-5908	18-5908	—	18-5966 ④
465	GM V-8	1990-1994	C849992	F213244	18-5816 ③	—	18-5913-1 ⑦	—	18-5966 ④ ⑧
465	GM V-8	1990-1994	C849992	F213244	—	18-5908 ③	—	—	—
500	GM V-8	1994-1997	F213293	& Up	18-5820	—	18-5913-1 ⑦	—	—
500	GM V-8	1994-1995	F213293	& Up	18-5820	18-5908	18-5908 ③	—	—
500 Bulldog	GM V-8	1990-1996	C577254	& Up	18-5820 ③	—	18-5913-1 ⑦	—	—
500 Bulldog	GM V-8	1990-1996	C577254	& Up	18-5816 ⑩	18-5908	18-5908 ③	—	18-5966 ④ ⑧
502 Mag. Bravo	GM V-8	1990-1993	C878221	F114528	18-5816	—	18-5913-1	—	18-5966 ④
502 Mag. MPI	GM V-8	1993-1997	D840650	K999999	18-5816	—	18-5913-1	—	18-5965
502 Mag. MPI	GM V-8	1998 & Up	L017000	& Up	18-5816	—	18-5913-1	—	18-6293
525 SC	GM V-8	1991-1993	D456000	D763831	18-5816	—	18-5913-1 ⑦	—	18-5966 ④ ⑧
525 SC	GM V-8	1991-1993	D456000	D763831	18-5816	18-5908	18-5908 ③	—	—
525 SC	GM V-8	1993-1997	D763871	& Up	18-5820	—	18-5913-1 ⑦	—	18-5966 ④ ⑧
525 SC	GM V-8	1993-1997	D763871	& Up	18-5820	18-5908	18-5908 ③	—	—
525 EFI	GM V-8	2003-2010	M900146	& Up	—	—	—	—	18-6298
575	GM V-8	1986-1992	A677429	D763716	18-5816	18-5908	18-5908	—	18-5966 ④
600 SC	GM V-8	1991-1996	D456489	F877642	18-5816 ⑩	18-5908	18-5908	—	18-5966 ④ ⑧
600 SC	GM V-8	1991-1996	D456489	F877642	18-5820 ⑩	18-5908	18-5908	—	—
600 SC	GM V-8	1997	K000227	& Up	18-5820	—	18-5913-1 ⑩	—	—
600 Sci	GM V-8	2005-2010	M952908	& Up	—	—	—	—	18-6298
800 SC	GM V-8	1993-1996	D763836	& Up	18-5820	18-5908	18-5908 ③	—	—
8.2L MIE	GM V-8	1990-1996	C878221	F819619	18-5816 ③	18-5908	18-5908	—	18-5966 ④
8.2L MIE	GM V-8	1993-1996	D857200	F819619	18-5817	18-5908	18-5908	—	18-5966 ④
8.2L MPI MIE	GM V-8	1996-1997	F819620	K999999	18-5816	18-5908	18-5908	—	18-5965
8.2L MPI MIE	GM V-8	1998 & Up	L002450	& Up	18-5816	18-5908	18-5908	—	18-6293

- ① For 12 3/4" Dia. Flywheel
 ② For 14" Dia. Flywheel
 ③ For permanent magnet models use 18-5919-1
 ④ 55 AMP up grade to 65 AMP use 18-5965
 ⑤ Black
 ⑥ For permanent magnet models use 18-5913-1
 ⑦ Bravo drive

- ⑧ Firepower ignition
 ⑨ Ignition module mounted on distributor
 ⑩ Ignition module mounted on elbow
 ⑪ LH rotation
 ⑫ NLA for models prior to S/N 4167000
 ⑬ PG 260 (9-1/4" long)
 ⑭ PG260F1 (8-1/2" long)

- ⑮ RH Rotation
 ⑯ Standard Ignition
 ⑰ Thunderbolt Ignition
 ⑱ Thunderbolt IV
 ⑲ Thunderbolt V
 ⑳ Transmission models
 ** Delco Style

 <p>18-7683 FUEL PRESSURE REGULATOR Replaces: 849899 Fits: MCM 500 EFI</p>	 <p>18-7663 FUEL PRESSURE REGULATOR Replaces: 802630T01, 802630001, 802630T, 802630, 8M0069803 7.4L MPI (L29)</p>	 <p>18-33207 FUEL PRESSURE REGULATOR Replaces: 860349A1 Fits: MCM/MIE 7.4LX MPI, 4545 Mag MPI, 502 Mag MPI, MIE 8.2L MPI, Mounts on Fuel Cooler.</p>
 <p>18-33211 FUEL PRESSURE REGULATOR Replaces: 892681 Fits: Mercruiser 8.1L, 496 Mag HO, 502 Mag MPI 375-400 HP.</p>	 <p>18-7600 TEMPERATURE SENSOR Replaces: 805218T</p>	 <p>18-7700 THROTTLE POSITION SENSOR Replaces: 853678T Fits: MCM/MIE 4.3L MPI, 5.0L MPI, MX6.2L MPI w/ECM 555 and 350 Mag MPI, Black Scorpion Tow Sports, 377 Scorpion Tow Sports, 7.4L MPI(L29) & MCM 496 Mag & HO and MIE 8.1S & HO</p>
 <p>18-7630 THROTTLE POSITION SENSOR Replaces: 805226A1</p>	 <p>18-7701 IDLE SPEED CONTROL MOTOR Replaces: 862998 Fits: MCM 3.0L MPI, V6 & V8(305, 350 & 496 cid)MPI engines w/ECM555, (Includes gasket)</p>	 <p>18-7697 IAC MOTOR Replaces: 803149 Fits: MCM/MIE 350 Mag MPI, Black Scorpion Tow Sports, 377 Scorpion MCM & Tow Sports, MX6.2L MPI, 7.4L MPI(L29) & 575 Sci</p>
 <p>18-7632-1 IDLE AIR CONTROL MOTOR Replaces: 805224A1</p>	 <p>18-33800 PCV VALVE Replaces: 21-806118 Fits: MCM 282 Mag EFI, 4.3L EFI</p>	 <p>18-7682 MAP SENSOR Replaces: 849934, 879150150 Fits: MCM 576 Sai</p>
 <p>18-7684 MAP SENSOR Replaces: 864856A1, 805217A1 Fits: MCM/MIE GM V6 & V8 (350, 377, 454 & 502cid)EFI Engines</p>	 <p>18-7660 MAP SENSOR Replaces: 881731, 8M0054726 V-6 & V-8 MPI engines with 555 ECM</p>	 <p>18-7550 MAP SENSOR Replaces: 861249, 861249A1 Fits: Mercury 5.7L, 7.4L 1998-2001</p>



18-7551
MAP SENSOR
Replaces: 861425
Fits: Mercury Scorpion,
Black Scorpion 1998-2010



18-7668
MAP SENSOR
Replaces: 854445
525 EFI



18-7553
KNOCK SENSOR
Replaces: 808015T
Fits: Mercury 5.7L MAG 1998-2010



18-7554
KNOCK SENSOR
Replaces: 878187
Fits: Mercury 5.7L MAG 1994-2010



18-7677
KNOCK SENSOR
Replaces: 806612T
Fits: GM V8(305, 350 & 377 cid) engines



18-7703
KNOCK SENSOR
Replaces: 805544T



18-7646
CAMSHAFT SENSOR
Replaces: 892615002, 892615001, 892615



18-7685
TBI INJECTOR
Replaces: 852956A1
Fits: MCM GM V6 & V8 (305 & 350 cid) TBI engines



18-7757
THROTTLE POSITION SENSOR
Replaces: 803148
For: 350 Mag OL005900 & Up.



18-33104
FUEL INJECTOR
Replaces: 802632T, 802632
Fits: MCM/MIE 7.4L MPI L29



18-7688
FUEL INJECTOR
Replaces: 885176
Fits: MCM 4.3L MPI engines (s/n OM300000-1A063239)
& 5.0L, 5.7L & 6.2L MPI engines w/ ECM 555
(s/n OM300000-1A064824)



**18-7690
INJECTOR SEAL KIT**
Replaces: 27-852957
Use with Mercury Injector # 852956A1, 853998A1, 853998T, 853998
Fits: 262 Mag EFI (1996-97), 4.3L EFI (1998-01), 5.0L EFI (1998-01), 350 Mag Alpha EFI (Gen+) (1996-97), 350 Mag EFI SKI (1994-97), 5.7L EFI (1995-01), 5.7L EFI MIE (Gen+) (1997), 5.7L LX Bravo EFI (Gen+) (1996-97), 5.7 LX EFI (1995-97), 7.4L LX TBI (1996-97), 575 Sci (2000-05)



**18-7692
INJECTOR SEAL KIT**
Use with Mercury Injector # 861260T, 861260
Fits: 350 Mag MPI(98-01), 350 Mag MPI Horizon MIE(99-01), 350 Mag MPI MIE(98-01), 350 Mag MPI SKI(98-01), MX 6.2L MPI(00-01), 454 Mag MPI(99-01), 454 Mag MPI Horizon MIE(99-01), 502 Mag MPI(99-01), 8.2L MPI(99-01)



**18-7693
INJECTOR SEAL KIT**
Use with Mercury Injector # 802632T, 849896
Fits: 7.4L MPI(L29)(98-01), 7.4L MPI MIE(L29)(98-01), 500 EFI(99-05)



**18-7694
INJECTOR SEAL KIT**
Use with Mercury Injector # 881693002
Fits: 496 Mag (2001-08), 496 Mag DTS (2001-08), 496 Mag HO (2001-08), 496 Mag HO DTS (2001-08), 8.1L MIE (2001-08), 496 Mag DTS (2001-08), 8.1L HO MIE (2001-08), 496 Mag HO DTS (2001-08)



**18-7695
INJECTOR SEAL KIT**
Use with Mercury Injector # 885176
Fits: 4.3L MPI(02-08), 5.0L MPI(02-08), 5.0L MPI DTS(05-08), 350 Mag MPI(02-08), 350 Mag MPI DTS(05-08), 350 Mag MPI Horizon(02-07), 350 Mag MPI Horizon DTS(05-07), 350 Mag MPI Horizon MIE(02-07), 350 Mag MPI Horizon MIE DTS(05-07), 350 Mag MPI SKI(02-07), 5.7L Horizon MIE(08), 5.7L MIE(08), 5.7L DTS MIE(08), 5.7L MPI SKI(08), MX6.2L MPI(02-07), MX6.2L MPI DTS(05-07), MX6.2L MPI Horizon(04-07), MX6.2L MPI Horizon DTS(05-07), MX6.2L MPI Horizon MIE(02-08), MX6.2L MPI Horizon MIE DTS(05-08), MX 6.2L MPI MIE(02-07), MX6.2L MPI MIE DTS(05-07), MX6.2L MPI SKI(02-07)



**18-7696
INJECTOR SEAL KIT**
Use with Mercury Injector # 805225A1
Fits: 320 EFI(87-89), 350 Mag Bravo MPI(Gen+)(97), Black Scorpion Ski(97-98), 377 Scorpion MCM(99-05), 377 Scorpion Ski(97-98), MX6.2L Black Scorpion Ski (01-07), 454 Mag EFI SKI(94-97), 454 Mag MPI(96-98), 454 Mag MPI Horizon MIE(98), 7.4L MPI MIE (95-97), 7.4LX MPI(96-97), 502 Mag MPI(93-98), 525 EFI(03-08), 8.2L MPI MIE(96-98)

FUEL INJECTION SYSTEM APPLICATION

Model	L/In	CID	# CYL	Year Range	Serial # Range	Injector	IAC Valve	TPS	F/P Regulator Rail-Mounted	F/P Regulator Cooler Mounted	MAP Sensor
3.0L MPI	3.0L	181	L4	2008-2010	A072812 & UP	N/A	18-7701	N/A	N/A	N/A	N/A
262 MAG EFI	4.3L	262	V-6	1996-1997	F803800 - K999999	18-7685	18-7632-1	18-7630	N/A	N/A	18-7684
4.3L EFI	4.3L	262	V-6	1988-2001	L012009 - M299999	18-7685	18-7632-1	18-7630	N/A	N/A	N/A
4.3L MPI	4.3L	262	V-6	2002-2007	M300000 - A063239	18-7688	18-7701	18-7700	N/A	N/A	N/A ⊕
4.3L MPI	4.3L	262	V-6	2007-2010	A063240 & UP	N/A	18-7701	18-7700	N/A	N/A	N/A ⊕
5.0L EFI	5.0L	305	V-8	1998-2001	L012052 - M299999	18-7685	18-7632-1	18-7630	N/A	N/A	N/A
5.0L MPI	5.0L	305	V-6	2002-2007	M300000 - A064824	18-7688	18-7701	18-7700	N/A	N/A ⊕	N/A ⊕
5.0L MPI	5.0L	305	V-6	2007-2010	A064825 & UP	N/A	18-7701	18-7700	N/A	N/A ⊕	N/A ⊕
5.0L MPI DTS	5.0L	305	V-8	2005-2007	W310000 - A064824	18-7685	N/A	N/A	N/A	N/A	N/A
5.0L MPI DTS	5.0L	305	V-8	2010	A064825 & UP	N/A	N/A	N/A	N/A	N/A	N/A
350 MAG ALPHA EFI (GEN +)	5.7L	350	V-8	1996-1997	F800300 - K999999	18-7685	18-7632-1	18-7630	N/A	N/A	18-7684
350 MAG BRAVO MPI	5.7L	350	V-8	1995-1996	F415189 - K001500	N/A	18-7632-1	18-7630	N.L.A.	N/A	18-7684 ⊕
350 MAG BRAVO MPI (GEN +)	5.7L	350	V-8	1997	K001501 - K999999	N/A	18-7632-1	18-7630	N/A	N/A	18-7684 ⊕
350 MAG EFI SKI	5.7L	350	V-8	1994-1996	F215561 - F820706	18-7685	18-7632-1	18-7630	N/A	N/A	18-7684
350 MAG EFI SKI	5.7L	350	V-8	1996	F820707 - K040005	18-7685	18-7632-1	18-7630	N/A	N/A	18-7684
350 MAG MPI	5.7L	350	V-8	1998	L010019 - L331588	N/A	18-7697	18-7700	N/A	N/A	N/A
350 MAG MPI	5.7L	350	V-8	1998	L336000 - L346999	N/A	18-7697	18-7700	N/A	N/A	N/A
350 MAG MPI	5.7L	350	V-8	1999	L331599 - L335999	N/A	18-7697	18-7757	N/A	N/A	N/A
350 MAG MPI	5.7L	350	V-8	1999-2001	L340000 - M299999	N/A	18-7697	18-7757	N/A	N/A	N/A
350 MAG MPI	5.7L	350	V-6	2002-2007	M300000 - A064824	18-7688	18-7701	18-7700	N/A	N/A ⊕	N/A ⊕
350 MAG MPI DTS	5.7L	350	V-8	2005-2007	W310000 - A064824	18-7688	N/A	N/A	N/A	N/A	N/A ⊕
350 MAG MPI DTS	5.7L	350	V-8	2007-2010	A064825 & UP	N/A	N/A	N/A	N/A	N/A	N/A ⊕
350 MAG MPI HORIZON	5.7L	350	V-8	2002-2007	M300000 - A064824	18-7688	18-7701	18-7700	N/A	N/A ⊕	N/A ⊕
350 MAG MPI HORIZON	5.7L	350	V-8	2007	A064825 - A299999	N/A	18-7701	18-7700	N/A	N/A ⊕	N/A ⊕
350 MAG MPI HORIZON DTS	5.7L	350	V-8	2005-2007	W310000 - A064824	18-7688	N/A	N/A	N/A	N/A	N/A ⊕
350 MAG MPI HORIZON DTS	5.7L	350	V-8	2007	A064825 - A299999	N/A	N/A	N/A	N/A	N/A	N/A ⊕
350 MAG MPI HORIZON MIE	5.7L	350	V-8	1999-2001	L364700 - M299999	N/A	18-7697	18-7757	N/A	N/A	N/A
350 MAG MPI HORIZON MIE	5.7L	350	V-8	2002-2004	M300000 - M398371	18-7688	18-7701	18-7700	N/A	N/A	N/A ⊕

⊕ BRAVO APPS W/SN W060000, ORDER REGULATOR # 892681

⊕ MAPT SENSOR (TEMP & PRESSURE)

FUEL INJECTION SYSTEM APPLICATION (CONT.)

Model	Liter	CID	# CYL	Year Range	Serial # Range	Injector	IAC Valve	TPS	F/P Regulator Rail-Mounted	F/P Regulator Cooler Mounted	MAP Sensor
350 MAG MPI HORIZON MIE	5.7L	350	V-8	2004-2007	M398372 - A064824	18-7688	18-7701	18-7700	N/A	N/A	N/A ⊕
350 MAG MPI HORIZON MIE	5.7L	350	V-8	2007	A064825 - A089999	N/A	18-7701	18-7700	N/A	N/A	N/A ⊕
350 MAG MPI HORIZON MIE DTS	5.7L	350	V-8	2005-2007	W390000 - A064824	18-7688	N/A	N/A	N/A	N/A	N/A ⊕
350 MAG MPI HORIZON MIE DTS	5.7L	350	V-8	2007	A064825 - A089999	N/A	N/A	N/A	N/A	N/A	N/A ⊕
350 MAG MPI MIE	5.7L	350	V-8	1998	L002008 - L302199	N/A	18-7697	18-7700	N/A	N/A	N/A ⊕
350 MAG MPI MIE	5.7L	350	V-8	1999-2001	L302200 - M299999	N/A	18-7697	18-7757	N/A	N/A	N/A
350 MAG MPI MIE	5.7L	350	V-8	2002-2004	M300000 - M308371	18-7688	18-7701	18-7700	N/A	N/A	N/A ⊕
350 MAG MPI MIE	5.7L	350	V-8	2004-2007	M398372 - A064824	18-7688	18-7701	18-7700	N/A	N/A	N/A ⊕
350 MAG MPI MIE	5.7L	350	V-8	2007	A064825 - A089999	N/A	18-7701	18-7700	N/A	N/A	N/A ⊕
350 MAG MPI MIE DTS	5.7L	350	V-8	2005-2007	W390000 - A064824	18-7688	N/A	N/A	N/A	N/A	N/A ⊕
350 MAG MPI MIE DTS	5.7L	350	V-8	2007	A064825 - A089999	N/A	N/A	N/A	N/A	N/A	N/A ⊕
350 MAG EFI SKI	5.7L	350	V-8	1994-1996	F215561 - F820706	18-7685	18-7632-1	18-7630	N/A	N/A	18-7684
350 MAG MPI SKI	5.7L	350	V-8	1998	L002600 - L304599	N/A	18-7697	18-7700	N/A	N/A	N/A
350 MAG MPI SKI	5.7L	350	V-8	1999-2001	L304600 - M299999	N/A	18-7697	18-7757	N/A	N/A	N/A
350 MAG MPI SKI	5.7L	350	V-8	2002-2007	M300000 - A064824	N/A	18-7701	18-7700	N/A	N/A	N/A ⊕
350 MAG MPI SKI	5.7L	350	V-8	2007	A064825 - A089999	N/A	18-7701	18-7700	N/A	N/A	N/A ⊕
5.7L EFI	5.7L	350	V-8	1995-1997	F225560 - K999999	18-7685	18-7632-1	18-7630	N/A	N/A	18-7684
5.7L EFI (GEN +)	5.7L	350	V-8	1998-2001	L010035 - M299999	18-7685	18-7632-1	18-7630	N/A	N/A	N/A
5.7L EFI MIE (GEN +)	5.7L	350	V-8	1997	X040300 - K999999	18-7685	18-7632-1	18-7630	N/A	N/A	18-7684
5.7L MPI HORIZON MIE	5.7L	350	V-8	2006-2010	A090000 - & UP	N/A	18-7701	18-7700	N/A	N/A	N/A ⊕
5.7L MPI HORIZON DTS MIE	5.7L	350	V-8	2008-2010	A090000 - & UP	N/A	N/A	N/A	N/A	N/A	N/A ⊕
5.7L MPI MIE	5.7L	350	V-8	2006-2010	A090000 - & UP	N/A	18-7701	18-7700	N/A	N/A	N/A ⊕
5.7L MPI DTS MIE	5.7L	350	V-8	2008-2010	A090000 - & UP	N/A	N/A	N/A	N/A	N/A	N/A ⊕
5.7L MPI SKI	5.7L	350	V-8	2006-2010	A090000 - & UP	N/A	N/A	18-7700	N/A	N/A	N/A ⊕
5.7LX BRAVO EFI (GEN +)	5.7L	350	V-8	1996-1997	F800300 - K999999	18-7685	18-7632-1	18-7630	N/A	N/A	18-7684
5.7LX EFI	5.7L	350	V-8	1995-1997	F225560 - K999999	18-7685	18-7632-1	18-7630	N/A	N/A	18-7684
BLACK SCORPION SKI	350	V-8	1996	F350583 - K040000	N/A	18-7697	18-7700	N.L.A.	N.L.A.	18-7684	
BLACK SCORPION SKI	350	V-8	1997	K040001 - L002699	N/A	18-7697	18-7700	N/A	N/A	18-7684	
BLACK SCORPION SKI	350	V-8	1998	L002700 - L005600	N/A	18-7697	18-7700	N/A	N/A	N/A	
BLACK SCORPION SKI	350	V-8	1998-2002	L005601 - M391599	N/A	18-7697	18-7757	N/A	N/A	N/A	
BLACK SCORPION SKI	350	V-8	2003-2010	M391600 - W698432	N/A	18-7701	18-7757	N/A	N/A	N/A	
SCORPION 350	5.0L	350	V-8	2008-2010	W698433 & UP	N/A	18-7701	18-7757	N/A	N/A	N/A
377 MAG	377	V-8	2008-2010	A300000 & UP	N/A	N/A	N/A	N/A	N/A	N/A	N/A ⊕
377 MAG DTS	377	V-8	2008-2010	A300000 & UP	N/A	N/A	N/A	N/A	N/A	N/A	N/A ⊕
377 SCORPION MCM	377	V-8	1999-2005	L416146 - M807201	N/A	18-7697	18-7757	N/A	N/A	N/A	18-7684
377 SCORPION SKI	377	V-8	1997-1998	K000656 - L600314	N/A	18-7697	18-7700	N/A	N/A	N/A	18-7684
MX 6.2L MPI	6.2L	377	V-8	2000-2001	L880003 - M299999	N/A	18-7697	18-7757	N/A	N/A	N/A
MX 6.2L MPI	6.2L	377	V-8	2002-2004	M300000 - W059999	18-7688	18-7701	18-7700	N/A	N/A	N/A ⊕
MX 6.2L MPI	6.2L	377	V-8	2004-2007	W060000 - A064824	18-7688	18-7701	18-7700	N/A	N/A	N/A ⊕
MX 6.2L MPI	6.2L	377	V-8	2007	A064825 - A299999	N/A	18-7701	18-7700	N/A	N/A	N/A ⊕
MX 6.2L MPI DTS	6.2L	377	V-8	2005-2007	W310000 - A064824	18-7688	N/A	N/A	N/A	N/A	N/A ⊕
MX 6.2L MPI DTS	6.2L	377	V-8	2007	A064825 - A299999	N/A	N/A	N/A	N/A	N/A	N/A ⊕
MX 6.2L MPI HORIZON	6.2L	377	V-8	2002-2004	M300000 - W059999	18-7688	18-7701	18-7700	N/A	N/A	N/A ⊕
MX 6.2L MPI HORIZON	6.2L	377	V-8	2004-2007	W060000 - A064824	18-7688	18-7701	18-7700	N/A	N/A	N/A ⊕
MX 6.2L MPI HORIZON	6.2L	377	V-8	2007	A064825 - A299999	N/A	18-7701	18-7700	N/A	N/A	N/A ⊕
MX 6.2L MPI HORIZON DTS	6.2L	377	V-8	2005-2007	W310000 - A064824	18-7688	N/A	N/A	N/A	N/A	N/A ⊕
MX 6.2L MPI HORIZON DTS	6.2L	377	V-8	2007	A064825 - A299999	N/A	N/A	N/A	N/A	N/A	N/A ⊕
MX 6.2L MPI HORIZON MIE	6.2L	377	V-8	2002-2004	M300000 - M398394	18-7688	18-7701	18-7700	N/A	N/A	N/A ⊕
MX 6.2L MPI HORIZON MIE	6.2L	377	V-8	2004-2007	M398395 - A064825	18-7688	18-7701	18-7700	N/A	N/A	N/A ⊕
MX 6.2L MPI HORIZON MIE	6.2L	377	V-8	2007-2010	A064825 & UP	N/A	18-7701	18-7700	N/A	N/A	N/A ⊕
MX 6.2L MPI HORIZON MIE DTS	6.2L	377	V-8	2005-2007	W390000 - A064824	18-7688	N/A	N/A	N/A	N/A	N/A ⊕
MX 6.2L MPI HORIZON MIE DTS	6.2L	377	V-8	2007-2010	A064825 & UP	N/A	N/A	N/A	N/A	N/A	N/A ⊕
MX 6.2L MPI MIE	6.2L	377	V-8	2002-2004	M300000 - M398394	18-7688	18-7701	18-7700	N/A	N/A	N/A ⊕
MX 6.2L MPI MIE	6.2L	377	V-8	2004-2007	M398395 - A064825	18-7688	18-7701	18-7700	N/A	N/A	N/A ⊕
MX 6.2L MPI MIE	6.2L	377	V-8	2007-2010	A064825 & UP	N/A	18-7701	18-7700	N/A	N/A	N/A ⊕
MX 6.2L MPI MIE DTS	6.2L	377	V-8	2005-2007	W390000 - A064824	18-7688	N/A	N/A	N/A	N/A	N/A ⊕
MX 6.2L MPI MIE DTS	6.2L	377	V-8	2007-2010	A064825 & UP	N/A	N/A	N/A	N/A	N/A	N/A ⊕

FUEL INJECTION SYSTEM APPLICATION (CONT.)

Model	Liter	CID	# CYL	Year Range	Serial # Range	Injector	IAC Valve	TPS	FIP Regulator Rail-Mounted	FIP Regulator Cooler Mounted	MAP Sensor
MX 6.2L MPI SKI	6.2L	377	V-8	2002-2007	M317000 - W689999	18-7688	18-7701	18-7700	N/A	N/A	N/A ♦
MX 6.2L BLACK SCORPION SKI	6.2L	377	V-8	2001-2003	L005601 - M391999	N/A	18-7687	18-7757	N/A	N/A	N/A
MX 6.2L BLACK SCORPION SKI	6.2L	377	V-8	2003-2007	M391750 - W688432	N/A	18-7701	18-7757	N/A	N/A	N/A
454 MAG EFI	7.4L	454	V-8	1994-1996	F115700 - F802340	N/A	18-7632-1	18-7630	N/A	N/A	18-7684
454 MAG EFI SKI	7.4L	454	V-8	1995-1996	F215800 - F820099	N/A	18-7632-1	18-7630	N/A	N/A	18-7684
454 MAG EFI SKI	7.4L	454	V-8	1996-1997	F820099 - K999999	N/A	18-7632-1	18-7630	N/A	N/A	18-7684
454 MAG MPI	7.4L	454	V-8	1996-1997	F802350 - K147348	N/A	18-7632-1	18-7630	N/A	N/A	18-7684
454 MAG MPI	7.4L	454	V-8	1997-1998	K147350 - L085399	N/A	18-7632-1	18-7630	N/A	N/A	18-7684
454 MAG MPI	7.4L	454	V-8	1999-2001	L085400 - M024999	N/A	18-7632-1	18-7630	N/A	N/A	18-7684
454 MAG MPI HORIZON MIE	7.4L	454	V-8	1996	L002200 - L086049	N/A	18-7632-1	18-7630	N/A	N/A	18-7684
454 MAG MPI HORIZON MIE	7.4L	454	V-8	1998-2001	L086050 - L674000	N/A	18-7632-1	18-7630	N/A	N/A	18-7684
7.4L MPI (L29)	7.4L	454	V-8	1998-2001	L010003 - M024330	N/A	18-7697	18-7700	18-7663	N/A	N/A
7.4L MPI MIE	7.4L	454	V-8	1995-1996	F563052 - K147349	N/A	18-7632-1	18-7630	N/A	N/A	18-7684
7.4L MPI MIE	7.4L	454	V-8	1997	K147350 - K999999	N/A	N/A	18-7630	N/A	N/A	18-7684
7.4L MPI MIE (L29)	7.4L	454	V-8	1998-2001	L010003 - L674613	N/A	N/A	18-7700	18-7663	N/A	N/A
7.4LX TH	7.4L	454	V-8	1996-1997	F820000 - K999999	N.L.A.	18-7632-1	18-7630	N/A	N/A	18-7684
7.4LX MPI	7.4L	454	V-8	1996	F602010 - K147349	N/A	18-7632-1	18-7630	N/A	N/A	18-7684
7.4LX MPI	7.4L	454	V-8	1997	K147350 - K999999	N/A	18-7632-1	18-7630	N/A	N/A	18-7684
496 MAG		496	V-8	2001-2004	M025000 - W059999	N/A	N/A	18-7700	18-7663	N/A	N/A
496 MAG		496	V-8	2004	W060000 - W060573	N/A	N/A	18-7700	18-7663	N/A	N/A
496 MAG		496	V-8	2004-2010	W060574 - & UP	N/A	N/A	18-7700	N/A	N/A	N/A
496 MAG DTS		496	V-8	2001-2004	M025000 - W059999	N/A	N/A	N/A	18-7663	N/A	N/A
496 MAG DTS		496	V-8	2004	W060000 - W060573	N/A	N/A	N/A	18-7663	N/A	N/A
496 MAG HO		496	V-8	2001-2004	M025000 - W059999	N/A	N/A	18-7700	18-7663	N/A	N/A
496 MAG HO		496	V-8	2004	W060000 - W060461	N/A	N/A	18-7700	18-7663	N/A	N/A
496 MAG HO		496	V-8	2004-2010	W060462 - & UP	N/A	N/A	18-7700	N/A	N/A	N/A
496 MAG HO DTS		496	V-8	2001-2004	M025000 - W059999	N/A	N/A	N/A	18-7663	N/A	N/A
496 MAG HO DTS		496	V-8	2004	W060000 - W060461	N/A	N/A	N/A	18-7663	N/A	N/A
496 MAG HO DTS		496	V-8	2004-2010	W060462 - & UP	N/A	N/A	N/A	N/A	N/A	N/A
496 MAG & HO EC		496	V-8	2007-2010	A068168 & UP	N/A	N/A	18-7700	N/A	N/A	N/A
496 MAG & HO DTS EC		496	V-8	2010		N/A	N/A	N/A	N/A	N/A	N/A
8.1L & HO MIE		496	V-8	2001-2004	M026000 - W089999	N/A	N/A	18-7700	18-7663	N/A	N/A
8.1L & HO MIE		496	V-8	2004	W090000 - W389999	N/A	N/A	18-7700	18-7663	N/A	N/A
8.1L & HO MIE		496	V-8	2004-2010	W390000 - & UP	N/A	N/A	18-7700	N/A	N/A	N/A
8.1L & HO MIE DTS		496	V-8	2001-2004	M026000 - W089999	N/A	N/A	N/A	18-7663	N/A	N/A
8.1L & HO MIE DTS		496	V-8	2004	W090000 - W389999	N/A	N/A	N/A	18-7663	N/A	N/A
8.1L & HO MIE EC		496	V-8	2007-2010	W697154 - & UP	N/A	N/A	18-7700	N/A	N/A	N/A
500 EFI	8.2L	502	V-8	1999-2005	L001477 - M907127	N/A	18-7632-1	N/A	N/A	N/A	18-7684
502 MAG MPI	8.2L	502	V-8	1993-1996	D840650 - K147349	N/A	18-7632-1	18-7630	N/A	N/A	18-7684
502 MAG MPI	8.2L	502	V-8	1997-1998	K147350 - L085432	N/A	18-7632-1	18-7630	N/A	N/A	18-7684
502 MAG MPI	8.2L	502	V-8	1999-2001	L085432 - M024999	N/A	18-7632-1	18-7630	N/A	N/A	18-7684
575 Sci	8.2L	502	V-8	2000-2005	L306696 - M950525	N.L.A.	18-7632-1	18-7630	N/A	N/A	N/A
575 Sci	8.2L	502	V-8	2000-2005	L306696 - M950526	N.L.A.	18-7632-1	18-7630	N/A	N/A	N/A
8.2L MAG	8.2L	502	V-8	2010	A350340 & UP	N/A	N/A	18-7700	N/A	N/A	N/A
8.2L MIE	8.2L	502	V-8	2010	A350340 & UP	N/A	N/A	18-7700	N/A	N/A	N/A
8.2L MPI MIE	8.2L	502	V-8	1996	F819620 - K147349	N/A	18-7632-1	18-7630	N/A	N/A	18-7684
8.2L MPI MIE	8.2L	502	V-8	1997-1998	K127350 - L086012	N/A	18-7632-1	18-7630	N/A	N/A	18-7684
8.2L MPI MIE	8.2L	502	V-8	1999-2001	L086013 - L674200	N/A	18-7632-1	18-7630	N/A	N/A	18-7684

① BRAVO APPS W/SH W060000, ORDER REGULATOR # 892681 ♦ MAPT SENSOR (TEMP & PRESSURE)



ALL SIERRA CARBURETORS INCLUDE BASE GASKET

- Precision remanufactured to meet or exceed OEM specifications
- Re-calibrated and re-engineered to maximize fuel efficiency and performance
- All carburetors are flow tested throughout the entire throttle range
- Fuel mixture and idle settings are pre-set to ensure that only minor idle and choke adjustments are necessary during installation
- All bases are resurfaced and throttle shaft bushings replaced



**18-7370N
CARBURETOR**
Replaces: 3310-860070A2,
3310-806077A2, 3310-806078A2,
1389-9562A1, 1389-9350A2,
1389-8490A2, 1389-815396A2
For: MCM 120/2.5L & 140/3.0L



**18-7373N
MERCARB 2V CARBURETOR**
Replaces: 3310-864941A01
2002-2004 4.3L engines
(s/n OM615000-OW300012
Uses Carb Kit **18-7098-1**



**18-7375N
CARBURETOR**
Replaces: 3310-864942A01,
3310-861448A1
For: 1998-2004 MCM 5.0L



**18-7376N
CARBURETOR**
Replaces: 3310-864943A01,
3310-861245A1
For: 1998 and newer 5.7L applications



**18-7615N
Q-JET CARBURETOR**
Replaces: 1347-816373A4,
1347-804624R1,
1347-804624R02
Uses Carb Kit **18-7095**



**18-7639
CARBURETOR**
Replaces: 3310-864943A01,
861245A1
Mercarb-5.7L 2V 1998 and newer 5.7L
(OLD10337-OW300754) & 5.7L MIE
(OLD002003-OW090899)
(Remanufactured)
Uses Carb Kit **18-7098-1** & Gasket **18-0994**



**18-7640
CARBURETOR**
Universal Q-jet with electric choke
(Remanufactured)
Uses Carb Kit **18-7095** & Gasket **18-0994**



**18-7603-1
CARBURETOR**
2 Barrel - Rochester
Replaces: 1347-818622,
1376-5659A1, 1347-818622 1,
1347-818622R02
(Remanufactured)
Uses Carb Kit **18-7075** & Gaskets **18-0994**
(left) & **18-0434** (right)



**18-7604-1
CARBURETOR**
4 Barrel - Rochester
Replaces: 3304-9354A2,
1347-804623R02, 1347-804623R1
(Remanufactured)
Uses Carb Kit **18-7095** & Gasket **18-2648**



**18-7605-1
CARBURETOR**
4 Barrel - Rochester
Replaces: 1347-9661A3,
1347-804623A1, 1347-804623R02
(Remanufactured)
Uses Carb Kit **18-7095** & Gasket **18-2648**



**18-7608-1
CARBURETOR**
2 Barrel - Rochester
Replaces: 1347-818620,
1347-818620 1, 1347-818620R02
(Remanufactured)
Uses Carb Kit **18-7070** & Gasket **18-0356**



**18-7609-1
CARBURETOR**
2 Barrel - Rochester
Replaces: 1347-818619,
1347-818619 1, 1347-818619 1R
(Remanufactured)
Uses Carb Kit **18-7070** & Gasket **18-0356**



**18-7610-1
CARBURETOR**
2 Barrel - Rochester
Replaces: 1347-818621,
1347-818621 1, 1347-818621 1R02
(Remanufactured)
Uses Carb Kit **18-7070** & Gasket **18-0396**



**18-7611-2
CARBURETOR**
2 Barrel - Rochester
Replaces: 3310-807312A1, 3310-807312R02
(Remanufactured)
Uses Carb Kit **18-7097** & Gasket **18-0994**



**18-7613-1
CARBURETOR**
4 Barrel - Carter (Weber)
Replaces: 3310-806969A1, 3310-806969R01
(Remanufactured)
Uses Gasket **18-0467**



**18-7615-1
CARBURETOR**
4 Barrel - Rochester
Replaces: 1347-816373A4,
1347-804624R1, 1347-804624R02
(Remanufactured)
Uses Carb Kit **18-7095** & Gasket **18-2548**

ALL SIERRA CARBURETORS INCLUDE BASE GASKET



**18-7616-1
CARBURETOR**
4 Barrel - Rochester
Replaces: 1347-8288A1,
1347-804626R02
(Remanufactured)
Uses Carb Kit 18-7072 & Gasket 18-2848



**18-7617-1
CARBURETOR**
4 Barrel - Rochester
Replaces: 1347-9863A3,
1347-804624R1, 1347-804625R02
(Remanufactured)
Uses Carb Kit 18-7095 & Gasket 18-2848



**18-7618-1
CARBURETOR**
4 Barrel - Rochester
Replaces: 1347-8289A1,
1347-804624R1, 1347-804624R02
(Remanufactured)
Uses Carb Kit 18-7095 & Gasket 18-2848



**18-7619-1
CARBURETOR**
4 Barrel - Rochester
Replaces: 1347-9142A2, 1347-8460A3
(Remanufactured)
Uses Carb Kit 18-7095 & Gasket 18-0462



**18-79994N
CARBURETOR**
Replaces: 3310-866142A04,
3310-866142A03
Fits: TKS-5.0L

CARBURETOR APPLICATION

Model	Ci/D/Cyl	Year Range	Beginning Serial #	Ending Serial #	Original Carb Part Number	Carb Code/Model	Carb Repair Kit	Replacement O.E. Carb No.	Float	Sierra Carb #
90	96/L4	1970-1971	2851424	3225967	1351-4263A 1	7040082 R2/2GC	18-7746	1347-818619R02	18-7200	18-7609-1
90	96/L4	1972	3225868	3226957	1351-4263A 1	7036543 R2/2GC	18-7746	1347-818619R02	18-7200	18-7609-1
110	153/L4	1963-1966	1357370	2044033	1336-2076	R2/2GC	—	—	—	18-7609-1
120	153/L4	1972-1973	3377341	3770649	1351-4263A3	7043182 R2/2GC	18-7746	1347-818619R02	18-7200	18-7609-1
120	153/L4	1974-1975	3776650	4469665	1351-5202A1	7044182 R2/2GC	18-7746	1347-818619R02	18-7200	18-7609-1
120	153/L4	1976-1978	4469666	5192048	1351-6065A2	7044182 R2/2GC	18-7746	1347-818619R02	18-7200	18-7609-1
120	153/L4	1979-1982	5192049	6229717	1351-7354A1	17059054 R2/2GC	18-7746	1347-818619R02	18-7200	18-7609-1
120	153/L4	1983	6229718	6663797	1351-8480A 2	17081060 R2/2GC	18-7746	1347-818621R02	18-7200	18-7610-1
120	153/L4	1984	6663798	6953913	1389-8490A 2	M2/MERCarb	18-7097	3310-860070A 2	18-7202	—
120	153/L4	1985	6863914	A482055	1389-9350A 2	M2/MERCarb	18-7097	3310-860070A 2	18-7202	—
120	153/L4	1986	A492056	B531853	1389-9562A 1	M2/MERCarb	18-7098-1	3310-860070A 2	18-7202	—
2.5L	153/L4	1983-1989	B531854	C853255	3310-806077A 2	M2/MERCarb	18-7098-1	3310-860070A 2	18-7202	—
140	181/L4	1968-1969	2508261	2816416	1351-3635A 1	7036646 R2/2GC	18-7746	—	18-7200	—
140	181/L4	1970	2816417	2911439	1351-4032A 1	7040080 R/2GC	18-7746	1347-818620R02	18-7200	18-7608-1
140	181/L4	1970-1973	2911440	3771644	1351-4293A1	7040084 R/2GC	18-7746	1347-818620R02	18-7200	18-7608-1
140	181/L4	1974-1978	3771645	5157668	1351-5203A1	7043184 R/2GC	18-7746	1347-818620R02	18-7200	18-7608-1
140	181/L4	1979-1982	5157669	6229717	1351-7355A1	17059062 R/2GC	18-7746	1347-818620R02	18-7200	18-7608-1
140	181/L4	1983	6229718	6671328	1351-8480A 2	17081060 R/2GC	18-7746	1347-818621R02	18-7200	—
140	181/L4	1984	6671329	6852269	1389-8490A 2	M2/MERCarb	18-7097	3310-860070A 2	18-7202	—
140	181/L4	1985	6852270	A484072	1389-9350A 2	M2/MERCarb	18-7097	3310-860070A 2	18-7202	—
140	181/L4	1986	A484073	B450800	1389-9562A 1	M2/MERCarb	18-7098-1	3310-860070A 2	18-7202	—
140/3.0L	181/L4	1983-1989	6229718	C856556	1351-8480A2	R2/2GC	—	1348-818621 1	—	18-7610-1
3.0L	181/L4	1987-1989	8450901	C856556	3310-806077A 2	M2/MERCarb	18-7098-1	3310-860070A 2	18-7202	—
3.0L	181/L4	1990	C856559	D447414	1389-815396A 2	M2/MERCarb	18-7098-1	3310-860070A 2	18-7202	—
3.0L	181/L4	1991-1993	D447415	D838075	1389-806077A 2	M2/MERCarb	18-7098-1	3310-860070A 2	18-7202	—
3.0L	181/L4	1993-1994	D838076	F603999	1389-806078A 1	M2/MERCarb	18-7098-1	3310-860070A 2	18-7202	—
3.0L	181/L4	1998-2002	L010042	M065672	3310-807504A 1	M2/MERCarb	18-7098-1	3310-860045397	18-7202	—
3.0L	181/L4	2003-2004	M355673	W301999	3310-864940A01	M2/MERCarb	18-7098-1	3310-860045397	18-7202	—
3.0L	181/L4	1999-2004	L382122	W301999	3310-864940A01	M2/MERCarb	18-7098-1	865959A01	18-7202	—

- Automatic Choke
- On-Line
- Ⓞ Use with in-line transmission
- Black
- Rear (Blue)
- Ⓞ Use with V-drive transmission
- Blue
- Spacer Mounted
- Ⓞ V-drive
- Electric Choke
- Use if original carb is MERCarb
- Ⓞ Wedge mounted
- Front (Blue)
- Use if original carb is Rochester
- Ⓞ TKS Retrofit Kit

CARBURETOR APPLICATION

Model	CID/Cyl	Year Range	Beginning Serial #	Ending Serial #	Original Carb Part Number	Carb Code/Model	Carb Repair Kit	Replacement O.E. Carb No.	Floet	Sierra Carb #
3.0L	181/L4	2004-2010	W302000	& UP	3310-866140A02	M2/MERCARB	18-7098-1	3310-866140A02	18-7202	—
3.0LX	181/L4	1990-1997	C856559	K999999	1388-815387A 2	M2/MERCARB	18-7098-1	3310-8M0045387	18-7202	—
3.0LX	181/L4	1990-1997	C856559	K999999	3310-805924A 2	M2/MERCARB	18-7098-1	3310-8M0045387	18-7202	—
165 (4 CYL)	224/L4	1987	B434841	B774251	1388-9564A 1	M2/MERCARB	18-7098-1	3310-860071A 2	18-7202	—
170	224/L4	1985-1989	6916779	B434940	1388-9564A 1	M2/MERCARB	18-7098-1	3310-860071A 2	18-7202	—
180	224/L4	1987	B436391	B775248	1347-9142A 2	17083522 R4/4ME	18-7077	—	18-7201	—
190 (4 CYL)	224/L4	1985-1986	6916779	B436390	1347-9142A 2	17083522 R4/4ME	18-7077	—	18-7201	—
3.7L	224/L4	1988-1989	B774252	& UP	1388-9564A 1	M2/MERCARB	18-7098-1	3310-860071A 2	18-7202	—
3.7LX	224/L4	1988-1989	B775249	& UP	1347-9142A 2	17083522 R4/4ME	18-7077	—	18-7201	—
470	224/L4	1976-1984	4208730	6916778	1375-5990A 1	17057132 R2/2GC	18-7075	3310-860071A 4	18-7202	—
470	224/L4	1983-1984	6218037	6916778	1388-8489A 5	M2/MERCARB	18-7097	3310-860071A 2	18-7202	—
485	224/L4	1980-1982	5665394	6218036	1375-5990A 1	17057132 R2/2GC	18-7075	3310-880071A 4	18-7202	—
488	224/L4	1983-1984	6170297	6916778	1347-8460A 3	17081299 R4/4ME	18-7077	—	18-7201	18-7619-1
150	230/L6	1964-1966	1830152	2046046	1338-2633	8025188 R2/2GC	18-7746	—	18-7200	—
160	250/L6	1967-1968	2048022	2492038	1338-2991	7026086 R2/2GC	18-7746	—	18-7200	—
160	250/L6	1969	2492036	277031	1351-3635A 1	7038646 R2/2GC	18-7746	—	18-7200	—
165 (6 CYL)	250/L6	1970-1972	3774865	3354791	1351-4282A 1	7043183 R2/2GC	18-7746	1347-618620R02	18-7200	18-7608-1
165 (6 Cyl)	250/L6	1979-1981	5178959	5813433	1351-7356A 1	17059050 R2/2GC	18-7746	1347-618620R02	18-7200	18-7608-1
165 (6 Cyl)	L6	1972-1973	3354702	3774864	1351-4871A 1	R2/2GC	—	1347-618620 1	—	18-7608-1
180/190 3.7L	—	—	—	—	—	R4/4ME	—	1347-8460	—	18-7619-1
L4 Engine	—	1985-1989	6916779	Later	1347-9142A 2	R4/4ME	—	—	—	18-7619-1
200 (6 CYL)	292/L6	1969	2453769	2484935	1347-3237A 4	7037082 R4/4MV	18-7077	—	18-7201	—
185 (4bb)	229/V-6	1993-1994	6330183	6919655	3300-8886A 2	17083515 R4/4ME	18-7077	—	18-7201	—
175	262/V-6	1987	B627965	B773242	3304-9685A 1	M2/MERCARB	18-7098-1	3310-807764A 1	18-7202	—
185	262/V-6	1985-1986	A331455	B527954	3304-9353A 2	M2/MERCARB	18-7097	3310-807764A 1	18-7202	—
205	262/V-6	1985-1987	A331455	B775129	3304-9354A 2	17084516 R4/4MV	18-7077	—	18-7201	18-7605-1
4.3L	262/V-6	1988-1992	B773243	D714106	3304-9685A 1	M2/MERCARB	18-7098-1	3310-807764A 1	18-7202	—
4.3L	262/V-6	1992-1993	D714107	F000877	3304-9685A 1	M2/MERCARB	18-7098-1	3310-807764A 1	18-7202	—
4.3L	262/V-6	1993-1995	F000878	F601126	3310-806672A 1	M2/MERCARB	18-7098-1	3310-807764A 1	18-7202	—
4.3L	262/V-6	1996-2002	F601127	M614999	3310-957784A 1	M2/MERCARB	18-7098-1	3310-807764A 1	18-7202	—
4.3L	262/V-6	2002-2004	M615000	W300012	3310-864941A01	M2/MERCARB	18-7098-1	3310-864941A01	18-7202	—
4.3L	262/V-6	2000-2004	L619000	W300012	3310-864941A01	M2/MERCARB	18-7098-1	865960A02	18-7202	—
4.3L	262/V-6	2004-2010	W300013	& UP	3310-866141A02	M2/MERCARB	18-7098-1	3310-866141A02	18-7202	—
4.3LH	262/V-6	1998-2002	L010044	ME1A999	3310-807826A 1	9666 WEBER	18-7749	—	—	—
4.3LX	262/V-6	1988-1991	B775130	D714369	3304-9354A 2	17084516 R4/4MV	18-7077	1347-804623R02	18-7201	18-7605-1
4.3LX	262/V-6	1992-1996	D714370	F802999	3310-818660A 1	9660 WEBER	18-7749	—	—	—
4.3XH	262/V-6	1996-1997	F803114	K999999	3310-807826A 1	9666 WEBER	18-7749	—	—	—
215 MCM/MIE (FORD)	302/V-8	1979-1972	2781153	3385720	1356-4066	C9FFB9510E HA/4160	18-7096	1356-804628R02	18-7206	—
225 MCM/MIE (FORD)	302/V-8	1973-1974	3385721	4166899	1356-5155	D2JL9510C HA/4160	18-7096	1356-804628R02	18-7206	—
888	302/V-8	1971-1977	3108723	4887829	1376-6658A 1	7044185 R2/2GC	18-7075	1376-818622R02	18-7202	18-7603-1
888	302/V-8	1971-1977	3108723	4887829	1356-4642	D1JJ95108 H2/2300	18-7081	—	—	—
198 MIE	305/V-8	1977	4776402	4931099	1376-6491A 1	17057139 R2/2GC	18-7075	3310-861080A 1	18-7202	—
200	305/V-8	1985-1986	6899058	A482026	1388-8489A 2	M2/MERCARB	18-7097	3310-861080A 1	18-7202	—
200	305/V-8	1985-1987	A482027	B525961	1388-9583A 1	M2/MERCARB	18-7098-1	3310-861080A 1	18-7202	—
200	305/V-8	1987	B525982	B774444	1388-9670A 2	M2/MERCARB	18-7098-1	3310-807312A 1	18-7202	—
228	305/V-8	1977-1978	4765100	5069430	1347-6427A 1	17057282 R4/4MV	18-7077	9661A 3	18-7201	18-7605-1
228	305/V-8	1978-1981	5069431	6021783	1347-7361A 1	17059292 R4/4MV	18-7077	9661A 3	18-7201	18-7605-1
228	305/V-8	1982	6021784	6218461	1347-6296A 4	17080565 R4/4MV	18-7077	9661A 3	18-7201	18-7605-1
228	305/V-8	1982-1994	6218462	6899288	1347-9661A 3	17080565 R4/4MV	18-7077	9661A 3	18-7201	18-7605-1
228 MIE	305/V-8	1977-1978	4765100	5069430	1347-6438A 1	17057283 R4/4MV	18-7077	9661A 3	18-7201	18-7605-1
228 MIE	305/V-8	1978-1982	5069431	6040745	1347-7364A 1	17059281 R4/4MV	18-7077	9661A 3	18-7201	18-7605-1
228 TR	305/V-8	1977-1978	4765100	5069430	1347-6438A 1	17057283 R4/4MV	18-7077	9661A 3	18-7201	18-7605-1

- Automatic Choke
- Black
- Blue
- Electric Choke
- Front (Blue)

- On-Line
- Rear (Blue)
- Spacer Mounted
- Use if original carb is MERCARB
- Use if original carb is Rochester

- Ⓜ Use with in-line transmission
- Ⓜ Use with V-drive transmission
- Ⓜ V-drive
- Ⓜ Wedge mounted
- Ⓜ TKS Retrofit Kit

CARBURETOR APPLICATION

Model	CID/Cyl	Year Range	Beginning Serial #	Ending Serial #	Original Carb Part Number	Carb Code/Model	Carb Repair Kit	Replacement O.E. Carb No.	Float	Stem Carb #
230	305V-8	1985-1987	6892269	B773739	1347-9661A 3	17080565 R4/4MV	18-7077	9661A 3	18-7201	18-7605-1
230 MIE	305V-8	1982-1987	6040746	B788151	1347-8290A1	17080564 R4/4MV	18-7077	9661A 3	18-7201	18-7605-1
223/230/5.0LX	V-8	1983-1995	6218462	F600989	1347-9661A3	R4/4MV	—	1347-9661A3	—	18-7605-1
5.0L	305V-8	1988-1995	B774445	F600989	1389-9670A 2	M2/MERCARB	18-7098-1	3310-867312A1	18-7202	—
5.0L (GEN +)	305V-8	1998-2002	L015751	M599999	3310-861448A 1	M2/MERCARB	18-7098-1	3310-864942A01	18-7202	—
5.0L (GEN +)	305V-8	2002-2004	M600000	W300069	3310-864942A01	M2/MERCARB	18-7098-1	3310-864942A01	18-7202	—
5.0L (GEN +)	305V-8	2000-2004	L619000	W300009	3310-864942A01	M2/MERCARB	18-7098-1	865961A02	18-7202	—
5.0L (GEN +)	305V-8	2004-2010	W300010	& UP	3310-866142A03	M2/MERCARB	18-7098-1	3310-866142A04	18-7202	—
5.0LX	305V-8	1988-1995	B773740	F600999	1347-9661A 3	17080565 R4/4MV	18-7077	9661A 3	18-7201	18-7605-1
898/200/5.0L	V-8	1987-95	B525962	F600989	1389-9670A2	M2/MERCARB	—	3310-807312A1	—	18-7611-1
898	305V-8	1977	4762210	6021383	1378-6491A 1	17057139 R2/2GC	18-7075	3310-861060A 1	18-7202	—
898	305V-8	1982	6021384	6219461	1378-8285A 3	17080350 R2/2GC	18-7075	3310-861060A 1	18-7202	—
898	305V-8	1983-1984	6218462	6899057	1389-8488A 2	M2/MERCARB	18-7097	3310-861060A 1	18-7202	—
225 MCM/MIE (GM)	327V-8	1993-1999	1539620	2694014	1347-3237A 3	7037082 R4/4MV	—	1347-804624R02	—	18-7615N
250	350V-8	1977	4768000	4908849	1347-3353	7037082 R4/4MV	—	1347-804624R02	—	18-7615N
250	350V-8	1977	4768000	4908849	1347-3237A 3	7037082 R4/4MV	—	1347-804624R02	—	18-7615N
255	350V-8	1975-1976	4175550	4767999	1347-5732A 1	7044291 R4/4MV	18-7077	1347-804624R02	18-7201	18-7615N
255 MIE (GM)	350V-8	1975-1976	4175550	4924984	1347-5732A 1	7044291 R4/4MV	18-7077	1347-804624R02	18-7201	18-7615N
255 MIE (GM)	350V-8	1978	4924565	5195908	1347-7062A1	17057292 R4/4MV	18-7077	1347-804624R02	18-7201	18-7615N
255 MIE (GM)	350V-8	1979-1980	5195909	5907057	1347-7365A1	17059289 R4/4MV	18-7077	1347-804624R02	18-7201	18-7615N
260 MIE	V-8	1980-1986	5907058	B522505	1347-8289A1	R4/4MV	—	1347-8289A1	—	18-7618-1
260	350V-8	1978	4908850	5060805	1347-6482A 1	17057298 R4/4MV	18-7077	1347-804624R02	18-7201	18-7615N
260	350V-8	1976-1982	5060808	6024393	1347-7362A 1	17059288 R4/4MV	18-7077	1347-804624R02	18-7201	18-7615N
260	350V-8	1982-1987	6024393	B525861	1347-8292A 4	17080561 R4/4MV	18-7077	1347-804624R02	18-7201	18-7615N
260	350V-8	1987	B525982	B773304	1347-9662A 1	17080561 R4/4MV	18-7077	1347-804624R02	18-7201	18-7615N
260 MIE	350V-8	1981-1987	5907058	B522505	1347-8289A 1	17080562 R4/4MV	18-7077	1347-804624R02	18-7201	18-7615N
260 MIE	350V-8	1987	B522506	B789151	1347-9662A 1	17080561 R4/4MV	18-7077	1347-804624R02	18-7201	18-7615N
260/5.7MIE	V-8	1987-1993	B522506	F024999	1347-9664A	R4/4MV	—	1347-816373A4	—	18-7615N
260/5.7L ALPHA	V-8	1987-1993	B525982	F000454	1347-9662A4	R4/4MV	—	1347-816373A4	—	18-7615N
270 MCM/MIE	350V-8	1989-1972	2851074	3385720	1347-4186A 1	7023285 R4/4MV	18-7077	—	18-7201	—
280 TRS	350V-8	1975	4176250	4176468	1347-4179A 2	7040283 R4/4MV	18-7077	—	18-7201	—
280 TRS	350V-8	1975-1976	4176468	4770199	1347-5981A 1	7044290 R4/4MV	18-7077	—	18-7201	—
300 MR/TRS	350V-8	1985-1986	6668677	B430367	1347-7488A 7	17059280 R4/4MV	18-7077	—	18-7201	18-7615N
350 MAG ALPHA	350V-8	1986-1991	A635178	D617327	1347-9662A 1	17080562 R4/4MV	18-7077	1347-804624R02	18-7201	18-7615N
350 MAG ALPHA	350V-8	1992-1995	D617329	F600999	3310-806970A 1	9770SA WEBER	18-7749	3310-807262A 1	—	—
350 MAG ALPHA	350V-8	1996-1997	F601000	K999999	3310-807262A 2	9781 WEBER	18-7748	—	—	—
350 MAG SKI	350V-8	1991-1996	D505450	K040399	3310-806970A 1	9770SA WEBER	18-7749	—	—	—
350 MAG SKI	350V-8	1991-1997	D505450	K999999	3310-807262A 2	9781 WEBER	18-7748	—	—	—
350 MAG SKI	350V-8	1997	K040400	K999999	3310-800371A 1	9781SB WEBER	18-7746	—	—	—
5.7L (2BBL)	350V-8	1996-1997	F601000	K999999	3310-807312A1	M2/MERCARB	18-7098-1	3310-807312A1	18-7202	18-7611-2
5.7L (GEN +) (2bb)	350V-8	1998-2002	L010037	M599999	3310-861245A 1	M2/MERCARB	18-7098-1	3310-864943A01	18-7202	18-7639
5.7L (GEN +) (2bb)	350V-8	2002-2004	M600000	W300754	3310-864943A01	M2/MERCARB	18-7098-1	3310-864943A01	18-7202	18-7639
5.7L (GEN +) (2bb)	350V-8	2000-2004	L015751	W300754	3310-864943A01	M2/MERCARB	18-7098-1	865982A02	18-7202	—
5.7L (Gen II)	V-8	1998-2004	L010037	W300754	3310-864943101	M2/MERCARB	—	3310-864943101	—	18-7639
5.7L (GEN +) (2bb)	350V-8	2004-2010	W300755	& UP	3310-866143A03	M2/MERCARB	18-7098-1	3310-866143A03	18-7202	—
5.7L ALPHA	350V-8	1988-1993	B773305	F000454	1347-9662A 4	17080561 R4/4MV	18-7077	1347-804624R02	18-7201	18-7615N
5.7L ALPHA	350V-8	1993-1994	F000455	F273497	3310-805484A 1	9661 WEBER	18-7746	—	—	—
5.7L ALPHA	350V-8	1993-1994	F000455	F273497	3310-806761A 1	9665S WEBER	18-7748	—	—	—
5.7L ALPHA	350V-8	1994-1995	F273498	F600999	3310-806761A 3	9665S WEBER	18-7748	3310-806761A 3	—	—
5.7L BRAVO	350V-8	1988-1991	B773305	D617327	1347-9662A 4	17080561 R4/4MV	18-7077	1347-804624R02	18-7201	18-7615N
(W/O HIGH RISE INTAKE)										
5.7L BRAVO	350V-8	1988-1991	B773305	D617327	1347-8289A 1	17080562 R4/4MV	18-7077	1347-804624R02	18-7201	18-7615N
(W/HIGH RISE INTAKE)										

- Ⓐ Automatic Choke
- Ⓑ Black
- Ⓒ Blue
- Ⓓ Electric Choke
- Ⓔ Front (Blue)

- Ⓘ On-Line
- Ⓚ Rear (Blue)
- Ⓛ Spacer Mounted
- Ⓜ Use if original carb is MERCARB
- Ⓝ Use if original carb is Rochester

- Ⓟ Use with in-line transmission
- Ⓠ Use with V-drive transmission
- Ⓡ V-drive
- Ⓢ Wedge mounted
- Ⓣ TKS Retrofit Kit

CARBURETOR APPLICATION

Model	CID/Cyl	Year Range	Beginning Serial #	Ending Serial #	Original Carb Part Number	Carb Code/Model	Carb Repair Kit	Replacement O.E. Carb No.	Float	Stigma Carb #
5.7L BRAVO	V-8	1987-1991	0B525982	0D617327	1347-962A4	R4/4MV	—	1347-816373A4	—	18-7615N
W/O HIGH RISE INTAKE										
5.7L BRAVO	V-8	1987-1991	0B525982	0D617327	1347-8289A1	R4/4MV	—	1347-8289A1	—	18-7615-1
W/HIGH RISE INTAKE										
5.7L BRAVO	350V-8	1992-1995	D617328	F800999	3310-806970A 1	9770SA WEBER	18-7749	3310-807262A 1	—	—
5.7L MIE	350V-8	1988-1992	B768152	D715493	1347-962A 4	17080561 R4/4MV	18-7077	1347-804624R02	18-7201	18-7615N
5.7L MIE	350V-8	1992-1994	D715494	F349999	3310-806761A 2 ①	9665S WEBER	18-7748	3310-806761A 2	—	—
5.7L MIE	350V-8	1995	F349300	F820099	3310-806761A 3	9665S WEBER	18-7748	3310-806761A 3	—	—
5.7L MIE (2bb)	350V-8	1998-2002	L002003	M316999	3310-861245A 1	M2/MERCcarb	18-7098-1	3310-864943A01	18-7202	18-7639
5.7L MIE (2bb)	350V-8	2002-2004	M317000	W090899	3310-864943A01	M2/MERCcarb	18-7098-1	3310-864943A01	18-7202	18-7639
5.7L MIE (2bb)	350V-8	2000-2004	L390600	W090899	3310-864943A01	M2/MERCcarb	18-7098-1	865962A02	18-7202	—
5.7L MIE (2bb)	350V-8	2004-2010	W090900	& UP	3310-866143A03	M2/MERCcarb	18-7098-1	3310-866143A03	18-7202	—
5.7L SKI	350V-8	1985-1987	A338553	B514626	1347-9415T	17080213 R4/4MV	18-7077	9415T	18-7201	—
5.7L SKI	V-8	1985-1993	A338533	F025099	1347-9415T	R4/4MV	—	1347-9415T	—	18-7615N
5.7L SKI	350V-8	1987-1995	F450000	F775199	3310-805498A 1	9661 WEBER	18-7749	3310-806761A 3	—	—
5.7L SKI (2bb)	350V-8	1996-1997	F775200	K999999	3310-807312A1	M2/MERCcarb	18-7098-1	3310-807312A1	18-7202	18-7611-2
5.7L SKI (GEN+) (2bb)	350V-8	1998-2002	L002005	M316999	3310-861245A 1	M2/MERCcarb	18-7098-1	3310-864943A01	—	18-7639
5.7L SKI (GEN+) (2bb)	350V-8	2002-2004	M317000	W090899	3310-864943A01	M2/MERCcarb	18-7098-1	3310-864943A01	—	18-7639
5.7L SKI (GEN+) (2bb)	350V-8	2000-2004	L390600	W090899	3310-864943A01	M2/MERCcarb	18-7098-1	865962A02	18-7202	18-7615-1
5.7L SKI (GEN+) (2bb)	350V-8	2004-2010	W090900	& UP	3310-866143A03	M2/MERCcarb	18-7098-1	3310-866143A03	18-7202	—
5.7LX (4bb)	350V-8	1996-1997	F601000	K999999	3310-807262A 2	9761 WEBER	18-7748	—	—	—
233 MCM & MCI (FORD)	351V-8	1975-1977	4173000	4465029	1378-5744 1	7044187 R2/2GC	18-7075	1347-818622R02	—	18-7603-1
233 MCM & MCI (FORD)	351V-8	1975-1977	4465030	4902304	1378-6152A 1	17056197 R2/2GC	18-7075	1347-818622R02	—	18-7603-1
325 MCM/MIE	427V-8	1969-1970	2278747	2042730	1347-3342 ②	7027080 R4/4MV	18-7077	—	18-7201	—
325 MCM/MIE	427V-8	1971-1972	3042731	3780448	1347-4533A 1 ②	7041831 R4/4MV	18-7077	—	18-7201	—
325 MCM/MIE	427V-8	1969-1972	2278747	3780449	1347-3889A 1 ②	7029280 R4/4MV	18-7077	—	18-7201	—
330 MCM	427V-8	1977-1978	4623115	5027230	1347-6493A1	17057287 R4/4MV	18-7077	1347-804625R02	18-7201	18-7615-1
330 MCM	427V-8	1977-1981	5027231	6083144	1347-7363A1	17059290 R4/4MV	18-7077	1347-804626R02	18-7201	18-7616-1
330 MCM	427V-8	1982-1987	6083145	B816540	1347-8291A3	17080563 R4/4MV	18-7077	1347-804626R02	18-7201	18-7615-1
330 MIE	427V-8	1977-1978	4623115	5226384	1347-6493A1	17057287 R4/4MV	18-7077	1347-804626R02	18-7201	18-7615-1
330 MIE	427V-8	1979-1980	5226385	5889913	1347-7366A1	17059287 R4/4MV	18-7077	1347-804626R02	18-7201	18-7615-1
340 MIE	454V-8	1981-1987	5889914	D788365	1347-8288A1	17080560 R4/4MV	18-7077	1347-804626R02	18-7201	18-7616-1
370	454V-8	1978-1987	4179554	B714585	1347-7498A 2	17059280 R4/4MV	18-7077	1347-804625R02	18-7201	—
400	454V-8	1980-1986	4179554	B457644	1347-7498A 2	17059280 R4/4MV	18-7077	1347-804625R02	18-7201	—
420	454V-8	1987-1989	A390941	B622418	13549A 4	H4	18-7751	—	—	—
425	454V-8	1980-1993	B622419	D937011	13549A 4	H4	18-7751	—	—	—
440	454V-8	1983-1986	4179554	B485220	1393-8862A 1	H4	18-7751	—	—	—
450	454V-8	1995-1996	F347100	F347277	13549A14	H4	18-7751	—	—	—
454 MAG ALPHA	454V-8	1986-1988	A631894	B785148	1347-8291A3	17080563 R4/4MV	18-7077	1347-804626R02	18-7201	18-7615-1
454 MAG BRAVO	454V-8	1988-1992	B721206	D805068	1347-7498A2	17059280 R4/4MV	18-7077	1347-804625R02	18-7201	18-7617-1
454 MAG BRAVO	454V-8	1992-1994	D805069	F304999	3310-806755A 1	9779 WEBER	18-7748	—	—	—
454 MAG BRAVO	454V-8	1995-1997	F305000	K999999	3310-806755A 2	9779 WEBER	18-7748	—	—	—
7.4L BRAVO I/II	454V-8	1988-1991	B711113	D603117	1347-8291A3	17080563 R4/4MV	18-7077	1347-804626R02	18-7201	18-7615-1
7.4L BRAVO III	454V-8	1992-1994	D603116	F351999	3310-806959A 2	9780 WEBER	18-7748	—	—	—
7.4L BRAVO III	454V-8	1995-1997	F352000	K999999	3310-806960A1	9780 WEBER	18-7748	3310-806960A 1	—	18-7613-1
7.4L BRAVO III	454V-8	1993-1996	D638819	F800699	3310-806755A 2	9779 WEBER	18-7748	—	—	—
7.4L BRAVO III	454V-8	1996-1997	F800700	K999999	3310-806960A1	9780 WEBER	18-7748	3310-806960A 1	—	18-7613-1
7.4L MIE	454V-8	1988-1992	5889914	D715493	1347-8268A 1	17080560 R4/4MV	18-7077	1347-804626R02	18-7201	18-7615-1
460	462V-8	1983-1986	4179554	B485220	1393-8862A 1	H4	18-7751	—	—	—
465	502V-8	1990-1992	C849992	F213244	—	H4	18-7751	—	—	—
465	502V-8	1990-1992	C849992	F213244	—	H4	18-7751	—	—	—
500	502V-8	1994-1995	F213293	F815766	13549A12	H4	18-7751	—	—	—

- ① Automatic Choke
- ② Black
- ③ Blue
- ④ Electric Choke
- ⑤ Front (Blue)

- ① On-Line
- ② Rear (Blue)
- ③ Spacer Mounted
- ④ Use if original carb is MERCarb
- ⑤ Use if original carb is Rochester

- ① Use with in-line transmission
- ② Use with V-drive transmission
- ③ V-drive
- ④ Wedge mounted
- ⑤ TKS Retrofit Kit

CARBURETOR APPLICATION

Model	CID/Cyl	Year Range	Beginning Serial #	Ending Serial #	Original Carb Part Number	Carb Code/Model	Carb Repair Kit	Replacement O.E. Carb No.	Float	Stems Carb #
500	502/V-6	1996-1996	F615767	L001772	13549A15	H4	18-7751	—	—	—
500 (GEN +)	502/V-8	1999	L414639	L601036	13549T21	H4	18-7751	—	—	—
502 MAG	502/V-8	1990-1992	C878221	D824588	1347-514625A 2	17089112 R4/4MV	18-7077	—	18-7291	—
502 MAG	502/V-8	1992-1993	D824589	F114528	3310-806971A 1	9782 WEBER	18-7748	—	—	—
8.2L MIE	502/V-8	1990-1992	C878221	D857199	1347-514625A 2	17089113 R4/4MV	18-7077	—	—	—
8.2L MIE	502/V-8	1990-1992	C878221	D857199	3310-817693A 1	9774 WEBER	18-7748	—	—	—
8.2L MIE	502/V-6	1993-1996	D857200	F819619	3310-806971A.1	9782 WEBER	18-7748	—	—	—
500 BULLDOG	540/V-8	1990-1995	C677254	F348987	13549A10	H4	18-7751	—	—	—
500 BULLDOG	540/V-6	1995-2001	F615762	M050281	13549A23	H4	18-7751	—	—	—

- ① Automatic Choke
- ② Black
- ③ Blue
- ④ Electric Choke
- ⑤ Front (Blue)

- ⑥ On-Line
- ⑦ Rear (Blue)
- ⑧ Spacer Mounted
- ⑨ Use if original carb is MERCarb
- ⑩ Use if original carb is Rochester

- ⑪ Use with in-line transmission
- ⑫ Use with V-drive transmission
- ⑬ V-drive
- ⑭ Wedge mounted
- ⑮ TKS Retrofit Kit



**18-8114
FUEL LINE HOSE**

For fuel pump to carburetor connection. Replaces copper or steel tubing 3/8" X 31" PTFE composite hose with 5/8"-18 male inverted flare straight one end, 5/8"-18 90° one end. SAE J1527 type A1



**18-8115
FUEL LINE HOSE**

For fuel pump to carburetor connection. Replaces copper or steel tubing 3/8" X 25" PTFE composite hose with 5/8"-18 male inverted flare straight one end, 5/8"-18 90° one end. SAE J1527 type A1

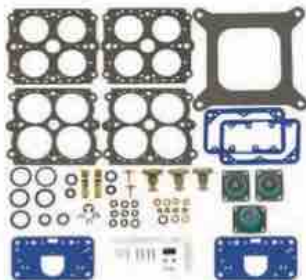

**18-7751
CARB KIT**

Replaces: 13220

Fits: GM 420 V8 454 (1987-89), GM 425 V8 454 (1990-93), GM 425 (Gen V) V8 454 (1992-93), 440 TRS GM 454 (1983-86), GM 450 V8 454 (1995-96), 460 TRS V8 482 (1983-86), GM 465 V8 502 (1990-92), GM 465 (Gen V) V8 502 (1992-94), 500 (Gen+) GM 502 V8 (1999), 500 (Gen V) 502 V8 (1994-98), 500 Bulldog 540 V8 (1990-01)



**18-7071
CARB KIT**

Replaces: 1397-3458



**18-7075
CARB KIT**

Replaces: 1397-5830, 1397-7099, 1397-8760, 1397-5831



**18-7070
CARB KIT**

Replaces: 1397-2072, 1397-7542, 1397-2637, 1397-7543, 1397-8872, 1397-3464



18-7072
CARB KIT
Replaces: 1397-3306, 1397-4329,
1397-5635, 1397-6638, 823426A1



18-7076
CARB KIT
Replaces: 1397-6367, A1



18-7077
CARB KIT
Replaces: 1397-8952, 823426A1



18-7078
CARB KIT
Replaces: 1397-2605, 1397-3462, 1397-2133
Fits: 1337-2604, 1337-2103



18-7080
CARB KIT
Replaces: 1398-3089
Fits: 1346-2770



18-7081
CARB KIT
Replaces: 1396-4656
Contains adjustable needles and seats

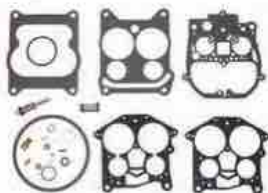

18-7095
CARB KIT
Replaces: 1397-7539, 1397-7540, 1397-7544,
1397-8535, 1397-9723



18-7096
CARB KIT
Replaces: 1396-5238, 1396-5222, 1356-4092
Fits: 1356-5169, 1356-5155, 1356-4066
Contains adjustable needles and seats



18-7097
CARB KIT
Replaces: 3302-9437, 3302-804845
MerCarb 2 bbl. bottom fill accelerator pump 1983-1986
MCM 120, 140, 470, 185, 200, 898



18-7098-1
CARB KIT
Replaces: 3302-804844002,
3302-804844001, 3302-804844
MerCarb 2 bbl. side fill accelerator pump
1986 and UP MCM 4-cyl., V6 & V8



18-7728
CARB KIT



18-7749
CARB KIT
Replaces: 809065, 835076, 823728



18-7748
CARB KIT
Replaces: 809064



18-7746
CARB KIT
Replaces: 823427A1, 1397-8873, 1397-8872,
1397-7547, 1397-7543, 1397-7542, 1397-3464,
1397-3459, 1397-2637, 1397-2634, 1397-2631,
1397-2067
Repair Kit for 2 BBL Rochester



CARBURETOR KIT/FLOAT APPLICATION

Model & Serial #	Mercruiser Carb #	Mfg. Carb #	Carb. Code & Model	Carb Kit ①	Float
MCM 80 ALL	1346-2770	RBS-4394S	C1/RBS	18-7090	—
MCM 90					
3225967 & BELOW	1351-4263A1	7040082	R2/2GC	18-7746	18-7200
3225968 & ABOVE	1351-4263A2	7041369	R2/2GC	18-7746	18-7200
MCM110 ALL	1336-2076	7038543	R2/2GC	18-7070	18-7200
MCM 120/2.3L					
2520424 & BELOW	1336-2076	7038543	R2/2GC	18-7746	18-7200
2520425-3377340	1336-3594A1	7036543	R2/2GC	18-7746	18-7200
3377341-3770649	1351-4263A3	7041369	R2/2GC	18-7746	18-7200
3770650-4469865	1351-5202A1	7043182	R2/2GC	18-7746	18-7200
4469866-5192047	1351-6065A2	7044182	R2/2GC	18-7746	18-7200
5192048-6229717	1351-7354A1	17059054	R2/2GC	18-7746	18-7200
6229718 & ABOVE	1351-8480A2	17081060	R2/2GC	18-7746	18-7200
6229718 & ABOVE	1389-8490A2	N/A	M2/Mercarb	18-7097	18-7202
6229718 & ABOVE	1389-8360A2	N/A	M2/Mercarb	18-7097	18-7202
6229718 & ABOVE	1389-9562A1	N/A	M2/Mercarb	18-7098-1	18-7202
MCM 140 (3.0L/3.0LX)(4 cyl.)					
2816416 & BELOW	1351-3635A1	7038646	R2/2GC	18-7746	18-7200
2816417-3332137	1351-4032A1	7040080	R2/2GC	18-7746	18-7200
3332138-3771644	1351-4293A1	7040084	R2/2GC	18-7746	18-7200
3771645-5157668	1351-5203A1	7043184	R2/2GC	18-7746	18-7200
5157669-6229717	1351-7355A1	17059052	R2/2GC	18-7746	18-7200
6229718-C856558	1351-8480A2	17081060	R2/2GC	18-7746	18-7200
6229718-C856558	1389-8480A2	N/A	M2/Mercarb	18-7097	18-7202
6229718-C856558	1389-9350A2	N/A	M2/Mercarb	18-7097	18-7202
6229718-C856558	1389-9562A1	N/A	M2/Mercarb	18-7098-1	18-7202
C856559 & ABOVE	1389-815396A2	N/A	M2/Mercarb	18-7098-1	18-7202
C856559 & ABOVE	1389-815097A2	N/A	M2/Mercarb	18-7098-1	18-7202
MCM 140 (5 cyl.)					
ALL (BC)	1338-2161	7025638	R1/BC	18-7071	—

① Does not include metering rods

CARBURETOR KIT/FLOAT APPLICATION (Cont.)

Model & Serial #	Mercuriuar Carb #	Mfg. Carb #	Carb. Code & Model	Carb Kit ①	Float
ALL (B)	1338-2166	7025662	R1/B	18-7071	—
MCM 150					
1823489 & BELOW	1338-2428	7024180	R1/BC	18-7071	—
1823489 & BELOW	1338-2431	7024181	R1/B	18-7071	—
1823490-1830151	1338-2808	7025183	R1/BC	18-7071	—
1823490-1830151	1338-2809	7025184	R1/B	18-7071	—
1830152 & ABOVE	1338-2833	7025188	R2/2GC	18-7070	18-7200
MCM 180					
2492035 & BELOW	1338-2991	7026088	R2/2GC	18-7748	18-7200
2492036 & ABOVE	1351-3835A1	7036646	R2/2GC	18-7748	18-7200
MCM 185 (8 cyl)					
3354701 & BELOW	1351-4282A1	7040083	R2/2GC	18-7746	18-7200
3354702-3774884	1351-4871A1	7042183	R2/2GC	18-7746	18-7200
3774885-5178958	1351-5204A1	7043183	R2/2GC	18-7746	18-7200
5178959 & ABOVE	1351-7356A1	17059050	R2/2GC	18-7746	18-7200
MCM 185/170/3.7L (4 cyl)					
6218037-6918778	1388-8488A5	N/A	M2/Mercarb	18-7097	18-7202
6918779 & ABOVE	1388-9564A1	N/A	M2/Mercarb	18-7098-1	18-7202
MCM 175/4.3L/185 (V-6)					
	3304-8565A1	N/A	M2/Mercarb	18-7098-1	18-7202
(229 CID) ALL					
A321455-D714106	3300-8886A2	17083515	RA/4MV	18-7095	18-7201
185 (262 CID)					
A321455-B527954	3304-8953A2	N/A	M2/Mercarb	18-7097	18-7202
MCM 205 (262 CID)					
	3304-9354A2	—	RA/4MV	18-7095	18-7201
A331455-D714369	3304-8565A1	N/A	M2/Mercarb	18-7098-1	18-7202
MCM/MIE 470 ALL					
	1376-5980A1	17057132	R2/2GC	18-7076	18-7202
MCM 485 ALL					
	1376-5980A1	17057132	R2/2GC	18-7076	18-7202
MCM 488 ALL					
	1347-8460A3	17081299	RA/4ME	18-7077	18-7201
MCM 888					
ALL HOLLEY	1356-4642	D1JJ-9510-8	H2/2300	18-7081	18-7206
ALL ROCHESTER	1376-5659A1	7044185	R2/2GC	18-7075	18-7202
MCM 180/190/3.7LX					
(4 cyl)	1347-9142A2	17083522	RA/4MV	18-7095	18-7201
MIE 198/200/5.0L					
6021383 & BELOW	1376-6491A1	17057139	R2/2GV	18-7075	18-7202
6021384 & ABOVE	1376-8295A3	17080350	R2/2GV	18-7075	18-7202
MCM 200 (8 cyl)					
2494935 & BELOW	1347-3237A2	7037082	RA/4MV	18-7072	18-7201
2494936 & ABOVE	1347-3237A4	7037082	RA/4MV	18-7072	18-7201
MCM 198/200/5.0L					
6218482 & ABOVE	1388-8488A2	N/A	M2/Mercarb	18-7097	18-7202
6218482 & ABOVE	1388-9563A1	N/A	M2/Mercarb	18-7098-1	18-7202
6218482 & ABOVE	1388-9670A2	N/A	M2/Mercarb	18-7098-1	18-7202
MCM 205/4.3LX (V-6 262 CID)					
A331455-D714369	3304-9354A2	17084518	RA/4MV	18-7095	18-7201
MCM/MIE 215 ALL					
	1356-4066	C9FF-9510-E	HA/4160	18-7096	18-7206
MCM/MIE 225 (FORD)					
ALL	1356-5155	D2JL-9510-G	HA/4160	18-7096	18-7206
MCM/MIE 225 (GM)					
	1337-2103	7025584	RA/4GC	18-7078	—
1536920-2694014	1337-2604	7025756	RA/4GC	18-7078	—
	1347-3353	7037082	RA/4MV	18-7072	18-7201
	1347-3237A3	7037082	RA/4MV	18-7072	18-7201
MCM 228					
5068430 & BELOW	1347-6427A1	17057282	RA/4MV	18-7072	18-7201
MCM 228TR/ MIE 228					
5068430 & BELOW	1347-6438A1	17057283	RA/4MV	18-7072	18-7201
MCM 228/230/5.0L					
5068431-6021783	1347-7361A1	17059292	RA/4MV	18-7095	

① Does not include metering rods

CARBURETOR KIT/FLOAT APPLICATION (Cont.)

Model & Serial #	Mercurian Carb #	Mfg. Carb #	Carb. Code & Model	Carb Kit ①	Float
6021784-6218461	1347-8296A4	17080565	R4/4MV	18-7095	18-7201
6218462 & ABOVE	1347-8661A3	—	R4/4MV	18-7095	18-7201
MIE 228					
5067431-6040745	1347-7364A1	17059291	R4/4MV	18-7095	18-7201
6040746 & ABOVE	1347-8290A1	17080564	R4/4MV	18-7095	18-7201
MIE 230/5, DL ALL	1347-8290A1	17080564	R4/4MV	18-7095	18-7201
230/5, OLX	1347-8661A3	—	R4/4MV	18-7095	18-7201
MCM/MIE 233					
4465029 & BELOW	1376-5744A1	7044187	R2/2GC	18-7075	18-7202
4465030 & ABOVE	1376-6152A1	17056197	R2/2GC	18-7075	18-7202
MCM/MIE 250 AUTO, CHOKE					
4767999 & BELOW	1347-3353	7037082	R4/4MV	18-7072	18-7201
MCM/MIE 250 (EL. CHOKE)					
4767999 & BELOW	1347-3237A3	7037082	R4/4MV	18-7072	18-7201
MCM 250					
4769000 & ABOVE	1347-6492A1	17057298	R4/4MV	18-7072	18-7201
MCM/MIE 255 (GM)					
4924564 & BELOW	1347-5732A1	7044291	R4/4MV	18-7072	18-7201
4924565-5195908	1347-7062A1	17057295	R4/4MV	18-7072	18-7201
5195909-5907067	1347-7365A1	17058289	R4/4MV	18-7095	18-7201
5907068 & ABOVE	1347-8289A1	17080562	R4/4MV	18-7095	18-7201
MCM/MIE 255 (FORD)					
ALL	1366-5169	D2JL-9510E	H4/4180	18-7096	18-7206
MCM 260/5.7L BRAVO					
5060805 & BELOW	1347-6492A1	17057298	R4/4MV	18-7072	18-7201
5060806-6024393	1347-7362A1	17058288	R4/4MV	18-7095	18-7201
6024394-B525981	1347-8292A4	17080561	R4/4MV	18-7095	18-7201
B525982 & ABOVE	1347-8662A4	—	R4/4MV	18-7095	18-7201
MIE 260/5.7L 350 MAG					
A635178-D617327	1347-8289A1	17080562	R4/4MV	18-7095	18-7201
MIE 5.7 SKI					
A339533-F205099	1347-9415T	17085013	R4/4MV	18-7095	18-7201
MCM/MIE 270 ALL	1347-4180A1	7029285	R4/4MV	18-7072	18-7201
MCM 280					
4178488 & BELOW	1347-4179A2	7040283	R4/4MV	18-7072	18-7201
4178489 & ABOVE	1347-5981A1	7044290	R4/4MV	18-7072	18-7201
MCM 300 MR/TRS (GM)					
6668677 & ABOVE	1347-7496A7	—	R4/4MV	18-7095	18-7201
MCM/MIE 325 AUTO, CHOKE					
3042730 & BELOW	1347-3342	7027080	R4/4MV	18-7072	18-7201
3042731 & ABOVE	1347-4533A1	7041831	R4/4MV	18-7072	18-7201
MCM/MIE 325 EL. CHOKE					
2278747-378009	1347-3689A1	7029280	R4/4MV	18-7072	18-7201
MCM 330/454 MAGNUM (ALPHA ONE)					
5027230 & BELOW	1347-6493A1	17057287	R4/4MV	18-7072	18-7201
5027231-6083144	1347-7363A1	17058280	R4/4MV	18-7095	18-7201
6083145 & ABOVE	1347-8291A3	17080563	R4/4MV	18-7095	18-7201
MIE 330					
5226384 & BELOW	1347-6493A1	17057287	R4/4MV	18-7072	18-7201
5226385 & ABOVE	1347-7366A1	17058287	R4/4MV	18-7095	18-7201
MIE 340/7.4L					
ALL	1347-8288A1	17080560	R4/4MV	18-7095	18-7201
MCM 350 MAGNUM/5.7L BRAVO					
B525992-317327	1347-8289A1	—	R4/4MV	18-7095	18-7201
MIE 350 ALL	1347-5326A2	17066977	R4/4MV	18-7072	18-7201
MCM 370/400 ALL	1347-7496A2	17058280	R4/4MV	18-7095	18-7201
MCM 7.4L (BRAVO ONE)	1347-8291A3	17080563	R4/4MV	18-7095	18-7201
MCM 454 7.4L					

① Does not include metering rods

CARBURETOR KIT/FLOAT APPLICATION (Cont.)

Model & Serial #	Mercury/Sea Carb #	Mfg. Carb #	Carb. Code & Model	Carb Kit ①	Float
0063145-8816540	—	—	HA/4150, R6647A	18-7228	—
MCM 454 MAGNUM					
(BRAVO ONE)	1347-7498A2	17059280	RA/4MV	18-7095	18-7201
ALL	1347-9863A3	—	RA/4MV	18-7095	18-7201
MCM 592 MAGNUM (BRAVO ONE)					
C678221-0857199	1347-814623A2	—	RA/4MV	18-7095	18-7201
MCM 8.2L	1347-814623A2	—	RA/4MV	18-7095	18-7201

① Does not include metering rods



**18-7228
FLAME ARRESTOR**
Replaces: 85784A1



**18-7229
FLAME ARRESTOR**
Replaces: 85785T, 85785-2



**18-7230
FLAME ARRESTOR**
Replaces: 41639A1, 41639



**18-7231
FLAME ARRESTOR**
Replaces: 85785A2



**18-7232
FLAME ARRESTOR**
Replaces: 57882, 57882T



**18-7234
FLAME ARRESTOR**
Replaces: 805016A1

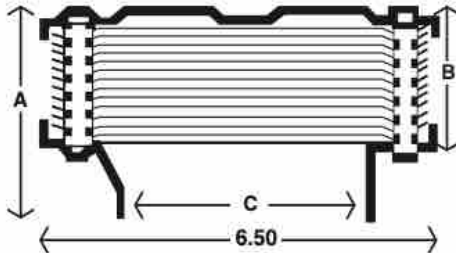

Engine	Part No.	Height A	Element B	Throat C	Vent Tubes ¹
4 & 6 cyl.	18-7228	2.156	1.088	3.12	1
4 & 6 cyl. ①	18-7234	2.28	1.55	3.1	0
V-8	18-7229	2.25	1.47	5.05	0
V-8	18-7230	2.25	1.47	5.05	1
V-8	18-7231	2.25	1.47	5.05	2
Hi-Performance	18-7232	2.969	2.19	5.05	2

① 3" Outside diameter ¹ Vent tubes accept 1/8 inch ID hose

**ANODIZED ALUMINUM
FLAME ARRESTOR SPECIFICATIONS**



**18-8864
FUEL PUMP W/ REGULATOR**
Replaces: 866169T01, 866169A01
For: Gm V-8 with Gen III Cool Fuel Module-high pressure



**18-8865
FUEL PUMP**
Replaces: 866170A01
For: Gm V-8 with Gen III Cool Fuel Module-low pressure



18-7326
ELECTRIC FUEL PUMP
Replaces: 805656A2, 805656A6, 805656A5, 805025A2, 861155A6, 861155A5
For: 1992-93, 1996 F.I. & Carbureted 4.3L with inline electric pump



18-35433
ELECTRIC FUEL PUMP
 One end threaded, One end snap fitting
Replaces: 861156A1
Fits: Mercuriser V8 & V8 305/350/377/454/502 EFI (Non-Threaded)(Replaces Cool Fuel Pump)



18-7266
FUEL PUMP
Flange I.D. # 41413, M6696
For: Ford (V-8) 302, 351



18-7267
FUEL PUMP
Flange I.D. # 41414
Replaces: 62092T, 62092, 54552
For: Ford (V-8) 302 (Includes gasket)



18-7274
FUEL PUMP
Flange I.D. # 41421, M73021
Replaces: 86246, 86246A1, 78485, 71646
For: GM (V-8) 305, 350, 400, 228 / 250 / 255 / 260 / 280



18-7275
FUEL PUMP
Flange I.D. # 41422
Replaces: 86247, 86247T, 86247A2, 78820, 63196, 46860
For: GM (V-8) 454, 330 / 325 / 350 / 390 (Includes gasket)



18-7278
FUEL PUMP
Flange I.D. # M60032
Replaces: 86234A4, 86234A05, 86234A3, 86234, 77594, 71327, 47585
For: GM (4 & 6 Cyl.) 153, 181, 225, 250, 120 / 140 / 160 / 165 / 470 / 485 / 488
 Uses filter **18-7860** & gasket **18-0869**



18-7282
FUEL PUMP
Flange I.D. # M60337
Replaces: 8M0073435, 861676T09
For: GM 4 cyl. (2.5/3.0L) & Mercuriser 3.7L
 Uses filter **18-7784** & gasket **18-0869**



18-7283
FUEL PUMP
Flange I.D. # M60600
Replaces: 97401A2, 97401A8, 861678A1, 8M0058164, 97401
For: GM (V-8) 305, 350, 228 / 230 / 260 / 898
 Uses gasket **18-0889**



18-7284
FUEL PUMP
Flange I.D. # M60315
Replaces: 41141A2, 862077A1
For: GM (V-6) 231, 262, 229
 Uses filter **18-7784** & gasket **18-0889**



18-7288-1
FUEL PUMP
Flange I.D. # 60601
Replaces: 812454A1, 862048A1, 812454A3, 97399A2, 97399
For: Inline (4 cyl) 120, 140, 3.0L and 224 CID
 7.4L / 454 / 420 / 330



18-35437
FUEL PUMP
Replaces: 42725A3, 861676A1, 861676T09, 8M0073435
Fits: Mercuriser 3.0L (SN L097000 & Up)
 (Includes gasket)



18-8860
FUEL PUMP
Replaces: 861677T
For: GM V-8 (454 & 502) applications
 (Includes gasket)



18-7256
FUEL PUMP
Flange I.D. # 6790, M3530
Replaces: 32722
For: GM (4 & 6 Cyl.) 153, 230, 250, 292

FUEL PUMP APPLICATION

Model	CID/#CYL	Year Range	Beginning Serial #	Ending Serial #	Fuel Pump #1	Fuel Pump #2	Pump Filter
120	153/L4	1964-1972	1666601	3377340	18-7278 ①	—	18-7863
120	153/L4	1964-1972	1666601	3377340	18-7256 ②	—	—
120	153/L4	1972-1982	3377341	6229717	18-7278	—	18-7860
120	153/L4	1983-1986	6229718	B531853	18-7278 ③	—	18-7860
120			4469866	& Below	18-7278	—	—
120			4469866	4952700	18-7278	—	—
120			4952701	& Up	18-7278	—	—
120			5192049	6229717	18-7278	—	—
120/2.5L			6229718	& Up	18-7278	—	—
120/2.5L			6229718	& Up	18-7282	—	—
2.5L	153/L4	1987-1989	B531854	BC853255	18-7278 ④	—	18-7860
140 (4 CYL)	181/L4	1968-1982	2508261	6229717	18-7278	—	18-7860
140 (4 CYL)	181/L4	1983-1986	6229718	B450800	18-7278 ⑤	—	18-7860
3.0L	181/L4	1987-1989	B450801	C856558	18-7278 ⑥	—	18-7860
140			4460664 & Below	& Below	18-7278	—	—
140			4460665	4918569	18-7278	—	—
140			4918570	& Up	18-7278	—	—
140 (4 Cyl.)			5157689	6229717	18-7278	—	—
140/3.0L			6229717 & Below	& Below	18-7278	—	—
140/3.0L			6229718 & Up	& Up	18-7282	—	—
3.0L/3.0LX			C856559 & Up	& Up	18-7282	—	—
140 (6 Cyl.)			1538930	1725960	18-7256	—	—
150			1666495	2048046	18-7256	—	—
160			2046022	2770031	18-7278	—	—
165			4471566	4884834	18-7278	—	—
165			5178959 & Up	& Up	18-7278	—	—
165/3.7L (4 Cyl.)			6916779 & Up	& Up	18-7282	—	—
180/3.7-LX (4 Cyl.)			6916779 & Up	& Up	18-7282	—	—
175/4.3L (262 CID)			B527955 & Up	& Up	18-7284	—	—
185 (229 CID)			6330183 & Up	& Up	18-7284	—	—
185 (262 CID)			A331455 & Up	& Up	18-7284	—	—
470	224/L4	1976-1984	4208730	6916778	18-7278	—	18-7860
485	224/L4	1980-1982	5685394	6218036	18-7278	—	18-7860
488	224/L4	1983-1984	6170297	6916778	18-7278 ⑦	—	18-7860
140 (6 CYL)	194/L6	1963	1538930	1725960	18-7256	—	—
150	230/L6	1964-1966	1666495	2048046	18-7256	—	—
160	250/L6	1967-1969	2048022	2770031	18-7278 ⑧	—	18-7860
160	250/L6	1967-1969	2048022	2770031	18-7256 ⑨	—	—
165 (6 CYL)	250/L6	1979-1981	2770032	5813433	18-7278	—	18-7860
200 (6 CYL)	250/L6	1969	2453769	2712072	18-7278	—	18-7860
200 GM			6218462	& Up	18-7283	—	—
200/5.0L GM			B525982	& Up	18-7283	—	—
185 (4bbl)	229/V-6	1983-1984	6330183	6919855	18-7284	—	—
175	262/V-6	1967	B527955	B773242	18-7284	—	—
185 (2bbl)	262/V-6	1985-1986	A331455	B527954	18-7284	—	—
205	262/V-6	1985-1987	A331455	B775129	18-7284	—	—
205/4.3L-LX (262 CID)			B527955	& Up	18-7284	—	—
4.3L	262/V-6	1988-1992	B773243	D714106	18-7284	—	—
4.3LX	262/V-6	1988-1992	B775130	D714369	18-7284	—	—
215 (FORD)	302/V-8	1970-1972	2781153	3563181	18-7267	—	—
215 Ford			3085036	& Below	18-7267	—	—

- ① low pressure lift pump
- ② high pressure fuel cool pump
- ③ fuel pump mounted with filter bowl facing up
- ④ fuel pump mounted with filter bowl facing down
- ⑤ AC fuel pump

- ⑥ Carter fuel pump
- ⑦ mechanical fuel pump
- ⑧ use if fuel pump has sight glass
- ⑨ use if fuel pump has sight tube
- ⑩ fuel pump/cooler kit

FUEL PUMP APPLICATION

Model	CID/CYL	Year Range	Beginning Serial #	Ending Serial #	Fuel Pump #1	Fuel Pump #2	Pump Filter
215 Ford			3258182	& Up	18-7267	—	—
225 Ford	302/V-8	1973-1974	3385721	4166999	18-7267	—	—
228 MCM & MIE	305/V-8	1977-1978	4765100	5170008	18-7274	—	—
228 MCM & MIE	305/V-8	1979-1982	5170009	6218461	18-7274	—	—
228 MCM & MIE	305/V-8	1979-1982	5170009	6218461	18-7283 ①	—	—
888 (FORD)	302/V-8	1971-1977	3108723	4887829	18-7267	—	—
228	305/V-8	1982-1984	6218462	6899268	18-7283	—	—
230 MIE	305/V-8	1981-1987	5907058	B788151	18-7283	—	—
230/5.0L-GM (IB)			B522506	& Up	18-7283	—	—
230 GM			6218462	& Up	18-7283	—	—
230/5.0L-LX GM			B525982	& Up	18-7283	—	—
230	305/V-8	1985-1987	6899269	B773739	18-7283	—	—
5.0L	305/V-8	1986-1995	B774445	F600999	18-7283	—	—
5.0L MIE	305/V-8	1988	B788152	C396832	18-7283	—	—
5.0L MPI BRAVO	305/V-8	2004-2010	W060000	& Up	18-8864 ②	18-8865 ③	—
5.0LX	305/V-8	1988-1995	B773740	F600999	18-7283	—	—
898	305/V-8	1977-1982	4762210	6218461	18-7274 ④	—	—
898	305/V-8	1977-1982	4762210	6218461	18-7283 ④	—	—
898	305/V-8	1983-1984	6218462	6899057	18-7283	—	—
233 FORD			4500880	& Up	18-7267	—	—
250	350/V-8	1977	4768000	4908849	18-7274	—	—
255	350/V-8	1975-1976	4175500	4767999	18-7274	—	—
255 MIE (GM)	350/V-8	1975-1980	4175500	5907057	18-7274	—	—
255 FORD			3258728	& Up	18-7267	—	—
255 GM			5195909	& Up	18-7274	—	—
260	350/V-8	1978-1982	4908850	6218461	18-7274 ⑤	—	—
260	350/V-8	1978-1982	4908850	6218461	18-7283 ⑤	—	—
260	350/V-8	1983-1987	6218461	& Up	18-7283	—	—
260 MIE	350/V-8	1981-1987	5907058	B788151	18-7283	—	—
280/5.7 GM			B525982	& Up	18-7283	—	—
260 GM Inboard			5907058	& Up	18-7283	—	—
260/5.7L GM (IB)			5907058	& Up	18-7283	—	—
5.7L-GM			F025000	& Up	18-7283	—	—
280	350/V-8	1975-1976	4176250	4770199	18-7274	—	—
300MR/TRS GM	350/V-8	1985-1986	6668677	B430367	18-7283	—	—
320 EFI	350/V-8	1987-1989	A543604	C622418	N.L.A.	—	—
325-GM			2278747	3640670	18-7275	—	—
330 GM			4623115	& Up	18-7275	—	—
330 GM/W.B.W.			6083145	& Up	18-7288-1	—	—
340/7.4L-GM (IB)			5889914	& Up	18-7288-1	—	—
350 MAG ALPHA	350/V-8	1986-1997	A635178	K999999	18-7283	—	—
350 MAG ALPHA EFI (GEN +)	350/V-8	1996	F800300	K001508	18-7283	—	—
350 MAG ALPHA EFI (GEN +)	350/V-8	1997	K001509	K999999	—	—	—
350 MAG BRAVO MPI	350/V-8	1995-1996	F415189	K001500	18-7283	—	—
350 MAG BRAVO MPI	350/V-8	1997	K001501	K999999	—	—	—
350 MAG EFI SKI	350/V-8	1994-1997	F215561	K999999	—	—	—
350 MAG MPI BRAVO	350/V-8	2004-2010	W060000	& Up	18-8864 ②	18-8865 ③	—
350 MAG MPI HORIZON	350/V-8	2004-2007	W060000	A299999	18-8864 ②	18-8865 ③	—
350 MAG MPI HORIZON MIE	350/V-8	2004-2007	M398372	A089999	18-8864 ②	18-8865 ③	—
350 MAG MPI MIE	350/V-8	2004-2007	M398372	A089999	18-8864 ②	18-8865 ③	—
350 MAG MPI MIE	350/V-8	2004-2007	M398372	A089999	18-8864 ②	18-8865 ③	—
350 MAG MPI SKI	350/V-8	1995-1996	F350583	F799999	18-7283	—	—
350 MAG SKI	350/V-8	1991-1997	D505450	K999999	18-7283	—	—

- ① low pressure lift pump
- ② high pressure fuel cool pump
- ③ fuel pump mounted with filter bowl facing up
- ④ fuel pump mounted with filter bowl facing down
- ⑤ AC fuel pump

- ⑥ Carter fuel pump
- ⑦ mechanical fuel pump
- ⑧ use if fuel pump has sight glass
- ⑨ use if fuel pump has sight tube
- ⑩ fuel pump/cooler kit

FUEL PUMP APPLICATION

Model	CID/#CYL	Year Range	Beginning Serial #	Ending Serial #	Fuel Pump #1	Fuel Pump #2	Pump Filter
350 GM			3780450	& Up	18-7275	—	—
(MAG-TOURNEY SKI)			D505450	& Up	18-7283	—	—
370 TRS-GM			6721528	& Up	18-7288-1	—	—
390-GM			2781129 - 2825059	2825059	18-7275	—	—
5.7L	350/V-8	1988-1997	B773305	K999999	18-7283	—	—
5.7L EFI	350/V-8	1995-1996	F225560	K001505	18-7283	—	—
5.7L MIE	350/V-8	1988-1997	B788152	K999999	18-7283	—	—
5.7L MPI HORIZON MIE	350/V-8	2008-2010	A090000	& Up	18-8864 ①	18-8865 ①	—
5.7L MPI MIE	350/V-8	2008-2010	A090000	& Up	18-8864 ①	18-8865 ①	—
5.7L SKI	350/V-8	1985-1997	A338553	K999999	18-7283	—	—
5.7LX	350/V-8	1986-1997	F601000	K999999	18-7283	—	—
5.7LX BRAVO EFI (GEN +)	350/V-8	1996	F800300	K001506	18-7283	—	—
5.7LX BRAVO EFI (GEN +)	350/V-8	1997	K001509	K999999	—	—	—
5.7LX EFI	350/V-8	1996	F752400	K001505	18-7283	—	—
5.7LX EFI	350/V-8	1997	K001506	K999999	—	—	—
5.7 GM (SKI)			B514627	& Up	18-7283	—	—
5.7L BRAVO (GM)350			B525982	& Up	18-7283	—	—
BLACK SCORPION SKI	350/V-8	1997	K040001	K999999	—	—	—
SCORPION 350 EC	350/V-8	2009-2010	W098433	& Up	18-8864 ①	18-8864 ①	—
233 (FORD)	351/V-8	1975-1977	4173000	4902304	18-7267	—	—
255 (FORD)	351/V-8	1973-1974	3256728	4175499	18-7267	—	—
377 MAG	377/V-8	2008-2010	A300000	& Up	18-8864 ①	18-8865 ①	—
MX 6.2L MPI	377/V-8	2004-2007	W060000	A299999	18-8864 ①	18-8865 ①	—
MX 6.2L MPI HORIZON	377/V-8	2004-2007	W060000	A299999	18-8864 ①	18-8865 ①	—
MX 6.2L MPI HORIZON MIE	377/V-8	2004-2010	M398395	& Up	18-8864 ①	18-8865 ①	—
MX 6.2L MPI MIE	377/V-8	2004-2010	M398395	& Up	18-8864 ①	18-8865 ①	—
SCORPION 377 HO EC	377/V-8	2009-2010	A091488	A092170	18-8864 ①	18-8865 ①	—
325	427/V-8	1969-1972	2278747	3780449	18-7275	—	—
330	454/V-8	1977-1981	4623115	6083144	18-7275	—	—
330 WITH B/W	454/V-8	1982-1987	6083145	B816540	18-7288-1	—	—
340 MIE	454/V-8	1981-1987	5889914	B788365	18-7288-1	—	—
350 MIE	454/V-8	1974-1976	3780450	4623109	18-7275	—	—
370 TRS	454/V-8	1978-1987	4179554	B714586	18-7288-1	—	—
400 TRS	454/V-8	1980-1986	4179554	B457644	18-7288-1	—	—
420	454/V-8	1987-1989	A398341	B622418	18-7288-1	—	—
425-GM			A398941	& Up	18-7288-1	—	—
425	454/V-8	1990-1992	B622419	D725499	18-7288-1	—	—
425 (GEN V)	454/V-8	1992-1993	D763855	D937011	18-8860	—	—
440 TRS	454/V-8	1983-1986	4179554	B485220	18-7288-1	—	—
450	454/V-8	1995-1996	F347100	F347277	18-8860	—	—
454 MAG ALPHA	454/V-8	1988-1988	A631894	B785148	18-7288-1	—	—
454 MAG BRAVO GM			B840126	& Up	18-7288-1	—	—
454 MAG BRAVO	454/V-8	1988-1992	A631894	B785148	18-7288-1	—	—
454 MAG BRAVO	454/V-8	1982-1997	D805069	K999999	18-8860	—	—
454 MAG EFI	454/V-8	1994-1996	F115700	F802349	18-8860	—	—
454 MAG EFI SKI	454/V-8	1995-1996	F215800	F820099	18-8860	—	—
454 MAG MPI	454/V-8	1996	F802350	K147349	18-8860	—	—
454 MAG MPI	454/V-8	1997	K147350	K999999	—	—	—
454 MAG MPI	454/V-8	1998-2001	L010029	M024899	—	—	—
454 MAG MPI HORIZON MIE	454/V-8	1998-2001	L002200	L674000	—	—	—
454 MAG MPI SKI	454/V-8	1996-1997	F820100	K999999	18-8860	—	—
470			5097479	& Below	18-7278	—	—

- ① low pressure lift pump
- ② high pressure fuel cool pump
- ③ fuel pump mounted with filter bowl facing up
- ④ fuel pump mounted with filter bowl facing down
- ⑤ AC fuel pump

- ⑥ Carter fuel pump
- ⑦ mechanical fuel pump
- ⑧ use if fuel pump has sight glass
- ⑨ use if fuel pump has sight tube
- ⑩ fuel pump/cooler kit

FUEL PUMP APPLICATION

Model	CID/CYL	Year Range	Beginning Serial #	Ending Serial #	Fuel Pump #1	Fuel Pump #2	Pump Filter
470			5097480	& Up	18-7278	—	—
470			5520115	6218036	18-7278	—	—
470			6218037	& Up	18-7278	—	—
485			5685394	& Up	18-7278	—	—
488			6170297	& Up	18-7278	—	—
525SC	454/V-8	1992-1999	D725809	L415623	18-8860	—	—
7.4L BRAVO	454/V-8	1988-1991	B771113	D603117	18-7288-1	—	—
7.4L BRAVO	454/V-8	1992-1997	D603118	K999999	18-8860	—	—
7.4L EFI MIE	454/V-8	1996-1997	F874815	K999999	—	—	—
7.4L MIE	454/V-8	1988-1992	B788366	D715493	18-7288-1	—	—
7.4L MIE	454/V-8	1992-1997	D715494	K999999	18-8860	—	—
7.4L MPI	454/V-8	1998-2001	L010003	M024330	—	—	—
7.4L MPI MIE	454/V-8	1995-1997	F563052	K147349	18-8860	—	—
7.4L MPI MIE	454/V-8	1997	K147350	K999999	—	—	—
7.4L MPI MIE	454/V-8	1997-2001	L002006	L674813	—	—	—
7.4LX BRAVO EFI	454/V-8	1996-1997	F820000	K999999	—	—	—
7.4LX BRAVO MPI	454/V-8	1996-1997	F602010	K999999	18-8860	—	—
7.4L WHURTH (IB)			C391564	& Up	18-7288-1	—	—
390	482/V-8	1969-1970	2781129	2825059	18-7275	—	—
496 MAG & HQ	496/V-8	2004-2010	W060000	& Up	18-8864 ②	18-8865 ①	—
8.1S MPI MIE & HQ	496/V-8	2004-2010	W090000	& Up	18-8864 ②	18-8865 ①	—
465	502/V-8	1992-1994	D456155	F213244	18-7275	—	—
500	502/V-8	1994-1998	F213293	L001772	18-7275	—	—
502 MAG BRAVO	502/V-8	1992-1993	D824589	F114528	18-8860	—	—
502 MAG EFI	502/V-8	1993-1995	D840650	F902599	18-8860	—	—
502 MAG MPI	502/V-8	1996	F802500	K147349	18-8860	—	—
502 MAG MPI	502/V-8	1997	K147350	K999999	—	—	—
502 MAG MPI	502/V-8	1998-2001	L017000	M024999	—	—	—
600SC	502/V-8	1992-2000	D725676	L601186	18-8860	—	—
8.2L MAG & HQ	502/V-8	2010	A340340	& Up	18-8864 ②	18-8865 ①	—
8.2L MAG & HQ MIE	502/V-8	2010	A350802	& Up	18-8864 ②	18-8865 ①	—
8.2L MIE	502/V-8	1993-1996	D857200	F819619	18-8860	—	—
8.2L MPI MIE	502/V-8	1996-1997	F819620	K147349	18-8860	—	—
8.2L MPI MIE	502/V-8	1997	K147350	K999999	—	—	—
8.2L MPI MIE	502/V-8	1998-2001	L002450	L674200	—	—	—

- ① low pressure lift pump
- ② high pressure fuel cool pump
- ③ fuel pump mounted with filter bowl facing up
- ④ fuel pump mounted with filter bowl facing down
- ⑤ AC fuel pump

- ⑥ Carter fuel pump
- ⑦ mechanical fuel pump
- ⑧ use if fuel pump has sight glass
- ⑨ use if fuel pump has sight tube
- ⑩ fuel pump/cooler kit

FUEL WATER SEPARATORS

Sierra fuel water separators remove over 99.8% of emulsified water from your gasoline. Sierra's 10 micron filters are over 90% efficient at removing particles as small as 10 micron. All filters flow @ 90 GPH to feed even the hungriest motor. Sierra 10 micron filters are recommended to prevent damage to sensitive inboard and outboard fuel injection systems.

- UNIVERSAL DESIGN -

DIRECT REPLACEMENT FOR MERCURY AND YAMAHA

FUEL WATER SEPARATOR BRACKETS



Bracket Type	Part No.	Replaces
1/4" Stainless Steel	18-8777	—
3/8" Stainless Steel	18-7776	—
1/4" Aluminum	18-7853-1	Mercury 89876A3, 55481, 89876
3/8" Aluminum	18-7775	—

FUEL WATER SEPARATOR KITS



**21 MICRON
FILTER KITS
FOR CARBURETED
ENGINES**

Kit Type	Part No.	Micron Rating	Contents	Replaces
1/4" Aluminum (Short Filter)	18-7848-1	21	1 - 18-7844 filter & 1 18-7853-1 bracket 2 - 18-4256 1/4" pipe plugs	Mercury - 35-807172A4, Q4, 35-60494A4, 35-805369A4, 35-57250A1, 35-55501A1, 35-52456A1, 35-60494A1, 52444
1/4" Aluminum Bonus Pack (Contains spare filter)	18-7848-2	21	2 - 18-7844 filter & 1 18-7853-1 bracket 2 - 18-4256 1/4" pipe plugs	—
1/4" Aluminum (Tall Filter)	18-7852-1	21	1 - 18-7845 filter & 1 18-7853-1 bracket 2 - 18-4256 1/4" pipe plugs	—
1/4" Aluminum Bonus Pack (Contains spare filter)	18-7852-2	21	2 - 18-7845 filter & 1 18-7853-1 bracket 2 - 18-4256 1/4" pipe plugs	—
3/8" Aluminum (Tall Filter)	18-7775-1	21	1 - 18-7845 filter & 1 18-7775 bracket 2 - 18-4264 3/8" pipe plugs	—
1/4" Stainless Steel (Tall Filter)	18-7777-1	21	1 - 18-7845 filter & 1 18-7777 bracket 2 - 18-4256 1/4" pipe plugs	—
3/8" Stainless Steel (Tall Filter)	18-7776-1	21	1 - 18-7845 filter & 1 18-7776 bracket 2 - 18-4264 3/8" pipe plugs	—

10 MICRON FILTER KITS FOR FUEL INJECTED ENGINES



Kit Type	Part #	Micron Rating	Contents
1/4" Aluminum (Short Filter)	18-7983-1	10	1 - 18-7944 filter & 1 18-7853-1 bracket • 2 - 18-4256 1/4" pipe plugs
1/4" Aluminum Bonus Pack (Contains spare filter)	18-7983-2	10	2 - 18-7944 filter & 1 18-7853-1 bracket • 2 - 18-4256 1/4" pipe plugs
1/2" Aluminum (Tall Filter)	18-7982-1	10	1 - 18-7945 filter & 1 18-7853-1 bracket • 2 - 18-4256 1/4" pipe plugs
1/2" Aluminum Bonus Pack (Contains spare filter)	18-7982-2	10	2 - 18-7945 filter & 1 18-7853-1 bracket • 2 - 18-4256 1/4" pipe plugs
1/2" Aluminum (High Capacity Filter)	18-7966-1	10	1 - 18-7866 filter & 1 18-7853-1 bracket • 2 - 18-4256 1/4" pipe plugs
3/8" Aluminum (Tall Filter)	18-7986-1	10	1 - 18-7945 filter & 1 18-7775 bracket • 2 - 18-4264 3/8" pipe plugs
1/4" Stainless Steel (Tall Filter)	18-7984-1	10	1 - 18-7945 filter & 1 18-7777 bracket
3/8" Stainless Steel (Tall Filter)	18-7985-1	10	1 - 18-7945 filter & 1 18-7776 bracket • 2 - 18-4264 3/8" pipe plugs
1/4" Aluminum (Tall Filter)	18-79912	10	1 - 18-79911 & 1 - 18-7853-1

* Display Packaged

10 MICRON FILTER KITS WITH DRAIN BOWLS

Sierra AquaVue™ and metal bowl separator filters allow water to be drained from the filter to extend service life. Use the AquaVue™ bowl for outboard, above deck installations. USCG regulations require the use of the flame resistant metal bowl below deck.

- Display Packaged



Kit Type	Part #	Micron Rating	Contents
1/2" Aluminum w/ metal drain bowl	18-7951	10	1 - 18-7919 filter & 1 18-7853-1 bracket 1 - 18-7924 metal bowl 2 - 18-4256 1/4" pipe plugs
1/2" Stainless Steel w/ metal drain bowl	18-7938	10	1 - 18-7919 filter & 1 18-7777 bracket 1 - 18-7924 metal bowl 2 - 18-4256 1/4" pipe plugs

COMPACT BRACKET AND SEPARATOR KIT - FOR SMALL OUTBOARDS AND FRESH WATER APPLICATIONS

 <p>18-7774 COMPACT ALUMINUM BRACKET</p>	 <p>18-6999 UNIVERSAL FUEL WATER SEPARATOR KIT MOUNTING BRACKET Fits: All 305 and 350 Mercuriser engines with Center Riser manifolds</p>	 <p>18-7965-1 10 MICRON COMPACT SEPARATOR KIT Contains: 1 - 18-7774 bracket 1 - 18-7865 filter</p>
--	--	--

REPLACEMENT FILTERS

	<p>UNIVERSAL DESIGN - DIRECT REPLACEMENT FOR MERCURY</p>
--	---

10 MICRON REPLACEMENT FILTERS			10 MICRON REPLACEMENT FILTERS		
Part No.	Description	Replaces	Part No.	Description	Replaces
18-7944	Short - 3.875"	35-807172, 35-802893Q, 35-806771, 35-8053691, 35-805369, 35-604941, 35-60494, 35-57250, 35-55501, 35-52456	18-7865	Compact 10 Micron	—
18-7945	Long - 8.5"	35-802893Q, 35-806771, 35-8053691, 35-805369, 35-604941, 35-60494, 35-57250, 35-55501, 35-52456	18-79911	Long - 8.5"	35-8M0079962
18-7866	High Capacity - 6"	—	21 MICRON REPLACEMENT FILTERS		
			18-7844	Short - 3.875"	35-807172, 35-802893Q
			18-7845	Long - 4.35"	35-807172, 35-806771, 35-8053691, 35-60494A4, 35-604941, 35-57250, 35-55501

<p>10 MICRON REPLACEMENT FILTERS AND KITS WITH DRAIN BOWLS</p>	
---	--

REPLACEMENT FILTERS			REPLACEMENT BOWLS		
Part No.	Description	Replaces	Part No.	Description	
18-7919	Spin-on replacement	35-809097, 35-8M0103095 Racor S3213	18-7924	Metal Collection Bowl	
18-7920	Spin-on replacement	Mercury 35-809099 Racor S3214	FILTER & BOWL KITS		
18-7947	Spin-on replacement	Racor S3240	Part No.	Description	
18-7948	Spin-on replacement Fits: 320RRAC01	35-896638 Racor S3227	18-7929	Filter & Metal Bowl, Mercury Style Contains: 18-7919 filter & 18-7924 bowl	
18-7949	Spin-on replacement Fits: 660RRAC02	Racor S3232	18-7943	Filter & Metal Bowl, Contains: 18-7920 filter & 18-7924 bowl	
			18-7969	Filter & Metal Bowl, Contains: 18-7948 filter & 18-7924 bowl	

- Display Packaged



**18-7919
FUEL/WATER
SEPARATING FILTER**
Replaces: Mercuriser 35-809097,
35-8M0103095 and Racor™ S3213
For styles with spin on drain bowls



**18-8955
FUEL WATER
SEPARATOR COVER**
Fits: 18-7944 & 18-7945 sized filter



**18-7784
FUEL FILTER**
Replaces: Mercuriser 35-11004A1, 35-803897Q1
For: 2.5L/3.0L(6229718 & later), All MC224 CID
(8218037 & later), All GM 262 CID (A331455 & later)
with Carter Fuel Pumps



**18-7977
"GEN III COOL FUEL
SYSTEM" FUEL FILTER**
Replaces: 35-866171A01
For: 350 Mag MPI Alpha/Bravo, 350 Mag MPI Horizon Alpha/
Bravo, 350 Mag MPI Horizon MIE, 350 Mag MPI MIE, 496 MAG,
496 MAG H.O., 5.0 MPI Alpha/Bravo, 8.1L Inboard, 8.1L Inboard
H.O., MX 6.2L MPI Alpha/Bravo, MX 6.2L MPI Horizon Alpha/
Bravo, MX 6.2L MPI Horizon MIE, MX 6.2L MPI MIE



**18-7964-1
TRANSMISSION FILTER KIT**
Replaces: 35-815419, 8791014241, 879194241,
35-813405A1, 35-813405, F19608751, FFF001138
For: Mercuriser V-8 Inboard with Hurth Transmission



**18-7855
FUEL FILTER**
Replaces: 1397-2150
Rochester Carb Inlet



**18-7717
FILTER ELEMENT**
Replaces: 35-93568
For: Rochester 2 bbl & 4 bbl Carburetors



**18-7859
FUEL FILTER**
Replaces: 35-53336, 3302-9033, 35-53336Q
For: Most GM Inline 4 & 6 cycle, Ford & Gm V-8's up to
400 HP and all Mercuriser 224 CID



**18-7721
FUEL FILTER**
Replaces: 35-864572
All MPI & EFI engines with boost pump, 8.1L & 496cid,
for 3/8" ID fuel lines



**18-7860
FUEL FILTER**
Replaces: 35-49088A2,
35-49088Q2, 35-49088, F18390006
(Used in 18-7278 Fuel Pump)
For: Inline 4 & 6 cycle engines



**18-7869
FUEL FILTER ASSEMBLY**
Uses filter 18-7859
Replaces: 1397-8767, 1397-8545
For:

Model/HP	Serial #
GM 2.5L/3.0L	6229718 & later
GM 5.0L/5.7L	6218462 & later
All 205	A331455 & later
228 HP	6021784 & later
330 HP	6083145 & later
GM 255	590768 & later
5.7L SKI 340,230 & 260 Inboards	ALL



**18-7873
FUEL FILTER**
Replaces: 35-808275
For: Models D7.3/270 Bravo & MIE Diesel Engines 1994-96



**18-7715
FUEL FILTER**
Replaces: 35-892665
Fits: Mercuriser V-8 using Gen III Cool Fuel Systems



**18-79901
VST FILTER**
Replaces: 65L-13915-00-00
Fits: 454 EFI(GenV) GM 1994-96, 454 EFI (SKI)(Gen V)
GM 1995, 454 Mag Bravo MPI (Gen VI) GM 1996-97, 454
Mag MPI (SKI)(Gen VI) GM 1996-97, 502 EFI (Gen V) GM
1993-95, 502 Mag MPI (Gen VI) GM 1996, 7.4L MIE MPI
(LH) Gen V GM 1995-96, 7.4L MIE MPI (LH) Gen VI GM
1996-97, 7.4LX Bravo MPI (Gen V) GM 1996, 7.4LX Bravo
MPI (Gen VI) GM 1996-97, 8.2L MIE MPI (LH) Gen VI GM
1996-97



18-6457
COMPOSITE PULLEY
 Replaces: 807757T
 3" OD Serpentine for 13/16" width belt
 For: Late model GM V6 & V8 engines



18-3506
CIRCULATING PUMP
 Replaces: 46-879194401
 For: V6 MCM SN: 1A063240 (2007), Newer 4.3L w/o
 water bypass hole
 - CURRENT



18-3577-2
CIRCULATING WATER PUMP
(Bi-Directional)
 Replaces: 67859, 17670, 811573, 850454,
 8504541, 878342, 850454002, 59972, 54534,
 49139, F6269358, F11100997, F11101053
 For: Big block GM engines



18-3573
CIRCULATING WATER PUMP
 All 8.1L big-block GM engines
 Replaces: 883514, 883925
 For: Engines with composite timing cover



18-3593
WATER PUMP
 Replaces: 33957, 37369, 52353, 65142,
 65142A1, 814755, 880817, 884727, F2774666,
 F11100785, F11101079
 Late Model 4 cyl GM engines requiring hose fitting, GM
 inline (4 & 6 Cyl.)



18-3599-2
CIRCULATING WATER PUMP
 Replaces: 60658, 811841,
 850399, 8503991, 17437, 878341, 850399002,
 54793, 52226, 37951, 35341, F11101292,
 F11101208, F11100742
 For: GM V-6 & small block V-8 engines



18-3007
18-3007-10Ⓜ
IMPELLER
 Replaces: 47-89983, 4789983T
 For 60 HP



18-3016-1
IMPELLER KIT
 with gasket
 Replaces: 47-862232A2, 8M0104229
 For: Late-model Bravo & High Performance. Includes
 350 Mag., 4.3L., 496 Mag., 5.0L., 8.1S and MX 5.2L



18-3017
18-3017-10Ⓜ
IMPELLER
 Replaces: 47-89984, 47-899842, 47-89984T3,
 47-89984T4, 47-899844, 47-30221, 47-65960,
 47-85460
 For all #1, R, MR, Alpha Units thru S/N D494568.
 Also for raw water pump on: 190 IB S/N 1564539-1720903 225
 IB S/N 1539620-2278546



18-3056
18-3056-10Ⓜ
IMPELLER
 Replaces: 47-43026-2
 For: Alpha I-Generation 2
 S/N D494569 & Above
 Mercuriuser Vazer



18-3087
IMPELLER
 Replaces: 47-59362, 47-59362T



18-3109
WATER TUBE GUIDE
 Replaces: 23-29804, 23-29804T, 23-52928
 (used with 18-3116 Housing)



18-3110
WATER PUMP
HOUSING BUSHING
 Replaces: 26-38970, 26-36557A1, 26-29677
 (Part of 18-3116 Housing)



18-3114
INSERT CUP
 Replaces: 48752, 48752T
 (Part of 18-3116 Housing)

Ⓜ Discount shop pack of 10 - Priced per package

 <p>18-3117 IMPELLER PLATE Replaces: 32435, 324351, 30605 For: #1 Units thru S/N D494568</p>	 <p>18-3122 IMPELLER PLATE Replaces: 817276, 8172761, 8172763 For: Alpha I - Generation 2 S/N D494569 & Above</p>	 <p>18-3350 WEAR PLATE Replaces: 72778, 94576</p>		
 <p>18-3351 WEAR PLATE Replaces: 72777, 94916</p>	 <p>18-3293 IMPELLER KEY Replaces: 28-43037</p>	 <p>18-3151 COUPLING Replaces: 816597</p>		
 <p>18-3417 WATER PUMP BASE Replaces: 46-57234A1</p>	 <p>18-3420 WATER PUMP BASE Replaces: 46-44292A3, 46-44292Q03, 46-44292T1</p>	 <p>18-3421 WATER PUMP BASE Replaces: 46-48748A1</p>		
 <p>18-3116 WATER PUMP HOUSING Replaces: 46-96148, 46-96148A1, 46-96148T1, 46-64141A1, 46-48743A1</p>	<p>PKG. OF 2</p>  <p>6.125" 2.360"</p> <p>18-2732 18-2732-9① WATER SHUTTER Replaces: 807166A3</p>	 <p>3.175" 2.5"</p> <p>18-2733 WATER SHUTTER Replaces: 92802, 99370A2</p>		
 <p>3.780" 3"</p> <p>18-2727 EXHAUST WATER SHUTTER Replaces: 60930</p>	 <p>18-3220 WATER TUBE Replaces: 32-54236 For: #1 -R/MR/Alpha</p>	 <p>18-3221 WATER TUBE Replaces: 32-814384, 32-860220 For: Gen II</p>		
 <p>18-3222 WATER TUBE GUIDE Replaces: 23-816583 For: Gen II</p>	<p>PKG. OF 5</p>  <p>18-3226 18-3226-9③ IMPELLER PUMP SCREW Replaces: 10-30720 For: R units</p>	<p>PKG. OF 5</p>  <p>18-3227-9① WATER PUMP DOWEL PIN Replaces: 17-35973 For: R/MR, Alpha I</p>	<p>PKG. OF 5</p>  <p>18-3229 18-3229-9① WATER POCKET SCREW Replaces: 10-28668 For: MR/Alpha</p>	 <p>18-3197 SCREW Replaces: 10-76156, 10-67373</p>

① Priced per Package



18-3160-1
SEA WATER PUMP, BRASS
Replaces: 46-862914A13
Uses impeller 18-3016-1



18-3600
SEA WATER PUMP
Replaces: 46-72774A32, 46-72774A11, 46-73823A7, 46-63450A2, 46-59112A2
Fits: V8 Engines with V-Belt and 2 piece pump. Use repair kit 18-3155



18-36001
SEA WATER PUMP
Replaces: 46-807151A12
Fits: V6 & V8 engines with v-belt and 1 piece pump. Use repair kit 18-3237



18-3155
WATER PUMP REPAIR KIT
Replaces: 47-72774A89
Fits: Bravo Seawater Pump with 2 piece housing



18-3160
WATER PUMP REPAIR KIT
Replaces: 350 MAG MPI, 377 MAG MPI, 4.3L MPI, 496 MAG, 5.0L MPI, 5.7L MPI, 6.2L MPI, 8.1L MAG using brass seawater pump 46-862914A13 (18-3160)
Includes: Impeller, O-ring, Base Gasket, and Stainless Steel Wear Plate



18-3216
IMPELLER KIT
Replaces: 47-59362A4
Fits: 1996-97 7.4L MIE MPI(LH) Gen VI GM 454 V8, 1996-97, 7.4L TBI MIE(LH) Gen VI GM 454 V8, 1996-97 8.2L MIE MPI(LH) Gen VI GM 502 V8



18-3318
WATER PUMP KIT
Replaces: 47-59362Q08
Fits: Plastic 1 and 2 piece sea water pump body



18-3237
IMPELLER REPAIR KIT
For: Bravo I, II, III (1988 & up) B864190 & up
Fits Bravo drives with 1 piece housing

-CONTAINS-			
Part #	Desc.	O.E. #	Qty.
18-3087	Impeller	47-59362	1
18-3350	Wear Plate	94576	1
18-7163	O-Ring	25-33465	1

18-3214
IMPELLER REPAIR KIT
Replaces: 47-43026T6, T8, T11
For: Alpha I - Generation II S/N D494569 & Above
Mercuriser Vazer
For same kit with upper housing, order 18-3147



18-3214D

-CONTAINS-

Part #	Desc.	O.E. #	Qty.
18-2564-1	Impeller Gasket	22-43033-1, 27-43033-1	1
18-2565	Impeller Gasket	27-43047-1	1
18-2566	Impeller Gasket	27-817277	1
18-2944	Seal Ring	26-45577, 26-455771, 26-45577B, 26-45577B1	1
18-3058	Impeller	47-43026-1, 47-43026-2	1
18-3122	Impeller Plate	817276	1
18-7420	O-Ring	25-21836	2

18-3217
IMPELLER KIT
For: #1 Units thru S/N D494568
(Similar to #46-96148A5 without base or housing)



18-3217D

-CONTAINS-

Part #	Desc.	O.E. #	Qty.
18-3109	Water Tube	23-29804	1
18-3017	Impeller	47-89984	1
18-2919	Water Pump Base to Gear Housing Gasket	27-42631-1	1
18-3110	Gcommat	26-38970	1
18-2945	Drain Screw Gasket	12-19183	2
18-2826	Water Pump Base to Gear Housing Gasket	27-85610-1	1
18-2914	Lower Water Pump to Wear Plate Gasket	27-85608-1	1
18-2915	Upper Water Pump to Wear Plate Gasket	27-85609-1	1
18-2944	Seal Ring	26-45577	1
18-3117	Plate	32435	1
18-7158	O-Ring	25-30613	1
18-7162	O-Ring	25-33145	1
18-7173	O-Ring	26-30224	1
18-7176	O-Ring	25-80011	1
18-2801	Water Pump Gasket	27-32438	1
18-7196	O-Ring	25-38099	1
18-7426	O-Ring	35-30271	1

18-3150
WATER PUMP KIT
Replaces: 46-807151A14, 46-807151A7
For: Bravo



18-3309
WATER PUMP KIT
For: Bravo

-CONTAINS-

Part #	Desc.	O.E. #	Qty.
18-3350	Wear Plate	94576	1
18-3351	Wear Plate	94916	1
18-3087	Impeller	47-59362	1
18-0366	Body Gasket	27-94914	2
18-0916	Water Pump Gasket	27-805215-1	1



18-3147
WATER PUMP KIT
Replaces: 817275T4, 817275K05
For: Gen II-Lower s/n D469859 and Up
For same kit without upper housing, order 18-3214



① Items ending in "D" are Display Packaged - Regular number is Non-Display

— CONTAINS —

Part #	Desc.	O.E. #	Qty.
18-3109	Water Tube	23-29804	1
18-3017	Impeller	47-89984	1
18-3116	Housing	46-96148A1	1
18-2919	Water Pump Base to Gear Housing Gasket	27-42631-1	1
18-3110	Grommet	26-38970	1
18-2945	Drain Screw Gasket	26-20260, 12-19183	2
18-2826	Water Pump Base to Gear Housing Gasket	27-85610-1	1
18-2914	Lower Water Pump to Wear Plate Gasket	27-85608-1	1
18-2915	Upper Water Pump to Wear Plate Gasket	27-85609-1	1
18-2944	Seal Ring	26-45577	1
18-3117	Plate	32435	1
18-7158	O-Ring	25-30613	1
18-7162	O-Ring	25-33145	1
18-7173	O-Ring	25-30224	1
18-7176	O-Ring	25-90011	1
18-2801	Water Pump Gasket	27-32438	1
18-7196	O-Ring	25-38099	1
18-7426	O-Ring	35-30271	1



**18-3517
WATER PUMP KIT
Without Base**
Replaces: 46-96148A5, 46-60367A1, 46-96148A8

— CONTAINS —

Part #	Desc.	O.E. #	Qty.
18-3109	Water Tube	23-29804	1
18-3017	Impeller	47-89984	1
18-3116	Housing	46-96148A1	1
18-3420	Water Pump Base	46-44292A3	1
18-2919	Water Pump Base to Gear Housing Gasket	27-42631-1	1
18-3110	Grommet	26-38970	1
18-2945	Drain Screw Gasket	12-19183	2
18-2826	Water Pump Base to Gear Housing Gasket	27-85610-1	1
18-2914	Lower Water Pump to Wear Plate Gasket	27-85608-1	1
18-2915	Upper Water Pump to Wear Plate Gasket	27-85609-1	1
18-2944	Seal Ring	26-45577	1
18-3117	Plate	32435	1
18-7158	O-Ring	25-30613	1
18-7162	O-Ring	25-33145	1
18-7173	O-Ring	25-30224	1
18-7176	O-Ring	25-90011	1
18-2801	Water Pump Gasket	27-32438	1
18-7196	O-Ring	25-38099	1
18-7426	O-Ring	35-30271	1



**18-3320
WATER PUMP KIT**
For: MR/Alpha I Units
S/N 6854393-OD469658

— CONTAINS —

Part #	Desc.	O.E. #	Qty.
18-3109	Water Tube	23-29804	1
18-3017	Impeller	47-89984	1
18-3116	Housing	46-96148A1	1
18-3421	Water Pump Base	46-46748A1	1
18-2919	Water Pump Base to Gear Housing Gasket	27-42631-1	1
18-3110	Grommet	26-38970	1
18-2945	Drain Screw Gasket	12-19183	2
18-2826	Water Pump Base to Gear Housing Gasket	27-85610-1	1
18-2914	Lower Water Pump to Wear Plate Gasket	27-85608-1	1
18-2915	Upper Water Pump to Wear Plate Gasket	27-85609-1	1
18-2944	Seal Ring	26-45577	1
18-3117	Plate	32435	1
18-7158	O-Ring	25-30613	1
18-7162	O-Ring	25-33145	1
18-7173	O-Ring	25-30224	1
18-7176	O-Ring	25-90011	1
18-2801	Water Pump Gasket	27-32438	1
18-7196	O-Ring	25-38099	1
18-7426	O-Ring	35-30271	1



**18-3321
WATER PUMP KIT**
For: #1 Units with flush
S/N 2495186-2783441

— CONTAINS —

Part #	Desc.	O.E. #	Qty.
18-3109	Water Tube	23-29804	1
18-3017	Impeller	47-89984	1
18-3116	Housing	46-96148A1	1
18-2919	Water Pump Base to Gear Housing Gasket	27-42631-1	1
18-3417	Water Pump Base	46-57234A1	1
18-3110	Grommet	26-38970	1
18-2945	Drain Screw Gasket	12-19183	2
18-2826	Water Pump Base to Gear Housing Gasket	27-85610-1	1
18-2914	Lower Water Pump to Wear Plate Gasket	27-85608-1	1
18-2915	Upper Water Pump to Wear Plate Gasket	27-85609-1	1
18-2944	Seal Ring	26-45577	1
18-3117	Plate	32435	1
18-7158	O-Ring	25-30613	1
18-7162	O-Ring	25-33145	1
18-7173	O-Ring	25-30224	1
18-7176	O-Ring	25-90011	1
18-2801	Water Pump Gasket	27-32438	1
18-7196	O-Ring	25-38099	1
18-7426	O-Ring	35-30271	1
18-2919	Water Pump Gasket	27-46231-1	1



**18-3317
WATER PUMP KIT**
For: #1/R Units without flush
S/N 2763442-6854392

COMPLETE WATER PUMP KIT, IMPELLER REPAIR KIT, IMPELLER APPLICATION

Model	Serial No.	Complete Water Pump Kit	Upper Pump Housing	Upper Pump Kit	Water Pump Base	Impeller Repair Kit (no housing)	Impeller
#1 Units with plastic flush screw in gear housing	2495186 - 2783441	18-3321	18-3116	18-3517	18-3421	18-3217	18-3017
1 Units w/o flush screw in gear housing	2763442 - 6854392	18-3317 (1)	18-3116	18-3517	18-3417 (1)	18-3217	18-3017
MR/ALPHA I	6854393 - OD534568	18-3320	18-3116	18-3517	18-3420	18-3217	18-3017
ALPHA I - Generation II & Vazer	0D494569 & ABOVE	18-3147	—	18-3570	—	18-3214	18-3066
BRAVO/Inboards w/ Plastic pump body	3040411 & ABOVE	—	—	18-3150	—	18-3318	18-3087
BRAVO/Inboards w/ Brass pump body	6M100001 & ABOVE	—	—	18-3160-1	—	18-3016-1	—

(1) Models which have been retro-fitted with an Alpha style lower unit (no pre-load pin in top of drivehaft) must use Alpha style parts (18-3320 and 18-3420)

GENERATION II WATER PUMP ASSEMBLY

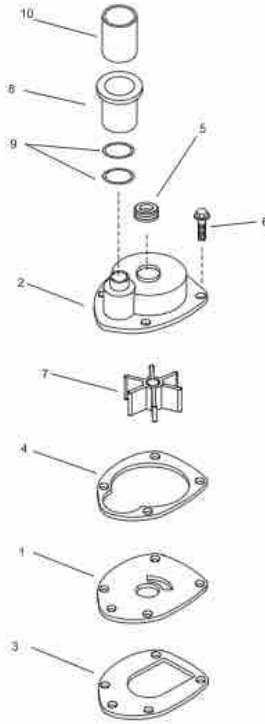

Sequence	Description	Part No.	O.E. #	Qty.
1	Face Plate	18-3122	817276	1
2	Housing Assembly	N.S.S.	817275A1	1
3	Gasket, Base	18-2564-1	27-43033-1	1
4	Gasket, Housing	18-2566	27-817277	1
5	Seal, Face	18-2598	26-816575A2	1
6	Screw, Housing	N/A	10-816926	4
7	Impeller	18-3056	47-43026-2	1
8	Coupling Assembly	18-3151	47-43026T11	1
9	O-Ring	18-7420	25-21836	2
10	Sleeve	18-3222	23-816583	1

MR ALPHA WATER PUMP ASSEMBLY

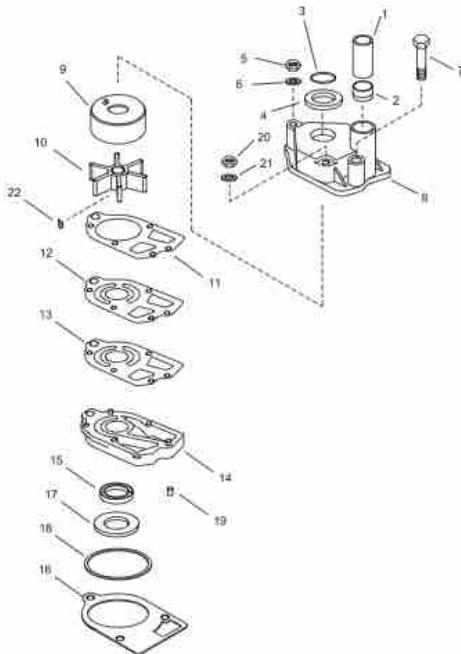

Sequence	Description	Part No.	O.E. #	Qty.
1	Guide Sleeve	18-3109	23-29804	1
2	Seal, Sleeve Guide	18-3110	26-38970	1
3	Ring, Upper	18-7158	25-30613	1
4	Ring, Dust	18-7426	25-30271	1
5	Nut, Housing	N/A	11-13436	1
6	Washer, Housing	18-4270	12-36001	3
7	Screw, Housing	N/A	10-96411	1
8	Housing, Water Pump	18-3116	46-96148A1	1
9	Cup, Impeller	18-3114	48752T	1
10	Impeller	18-3017	48752	1
11	Gasket, Impeller	18-2915	47-69964	1
12	Plate, Impeller	18-3117	27-85609-1	1
13	Gasket, Stainless Steel Plate	18-2914	27-85608-1	1
14	Water Pump Base Assembly	18-3420	46-44292A3	1
15	Oil Seal, Water Pump Base	18-2013	26-16977	1
16	Gasket, Water Pump Base	18-2919	27-42631-1	1
17	Oil Seal, Water Pump Base	18-2014	26-69238	1
18	O-Ring, Water Pump Base	18-7176	25-90011	1
19	Pin, Alignment	N/A	17-42636	1
20	Nut, Housing	N/A	11-13438	1
21	Washer, Housing	18-4275	12-29245	2
22	Key, Impeller	N/A	28-56654	1

R WATER PUMP ASSEMBLY

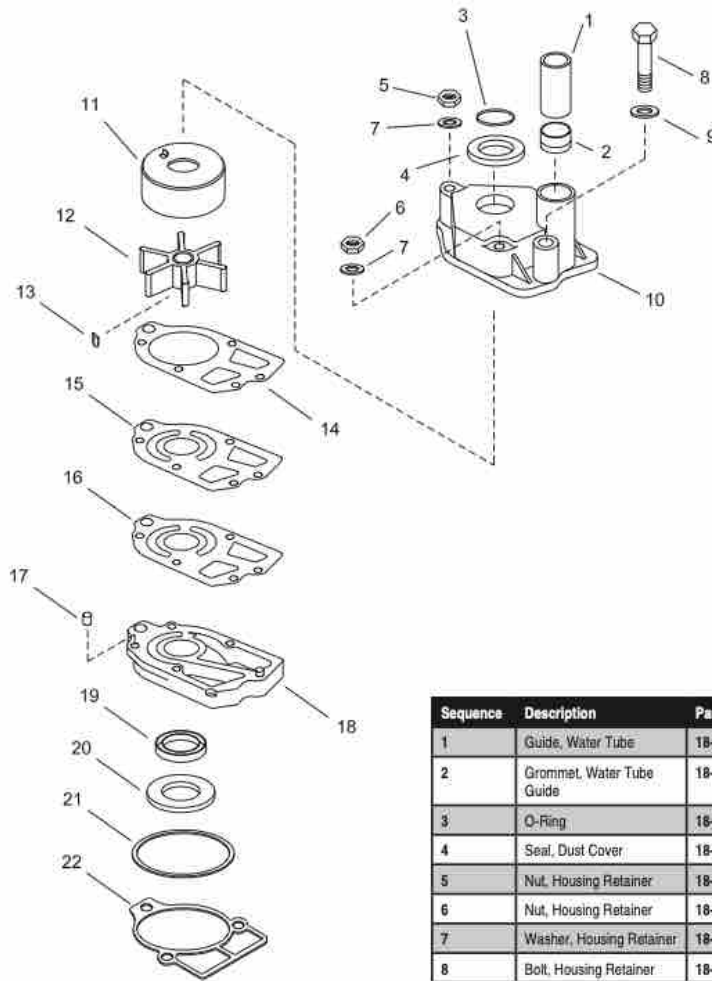

Sequence	Description	Part No.	O.E. #	Qty.
1	Guide, Water Tube	18-3109	23-29804	1
2	Grommet, Water Tube Guide	18-3110	26-38970	1
3	O-Ring	18-7158	25-30613	1
4	Seal, Dust Cover	18-7426	25-30271	1
5	Nut, Housing Retainer	18-3723	11-45592	1
6	Nut, Housing Retainer	18-3722	11-20361, 11-35888	2
7	Washer, Housing Retainer	18-4275	12-29245	3
8	Bolt, Housing Retainer	18-3226	10-30720	1
9	Washer, Housing Retainer	18-4270	12-36001	1
10	Housing, Impeller	18-3116	46-96148A1	1
11	Cup, Impeller	18-3114	48752	1
12	Impeller	18-3017	47-89984	1
13	Key, Impeller	N/A	28-58654	1
14	Gasket, Impeller	18-2915	27-85609-1	1
15	Wear Plate, Impeller	18-3117	32435	1
16	Gasket Wear Plate	18-2914	27-85608-1	1
17	Pin, Alignment	18-3227-9	17-35973	1
18	Base Assembly	18-3417	46-57234A1	1
19	Oil Seal, Base Assembly	18-2013	26-16877	1
20	Oil Seal, Base Assembly	18-2014	26-89238	1
21	O-Ring, Base Assembly	18-7162	25-33145	1
22	Gasket, Base Assembly	18-2826	27-85610-1	1



**18-3549
THERMOSTAT**
Replaces: 14586
120°



**18-3550
THERMOSTAT**
Replaces: 59078, 59078A1
140°



**18-3551
THERMOSTAT**
Replaces: 32728, 35884, 59137,
59137A1, 8072521, 8072531,
807252T1, 8M0089715
142°



**18-3552
THERMOSTAT**
Replaces: 76270, 76270T
160°



**18-3555
THERMOSTAT**
Replaces: 99155A1,
99155T2
160°



**18-3557
THERMOSTAT**
Replaces: 47594
143°



**18-3649
THERMOSTAT**
Replaces: 8072522, 807252T2,
8052732, 8M0091470
160°



**18-43015
THERMOSTAT**
Replaces: Mercury 864493
Fits: Mercruiser MCM 4.3L MPI, 5.0L
MPI and MX6.2L w/dry joint exhaust
and closed cooling



**18-43017
THERMOSTAT**
Replaces:
Mercury 863358T, 8M0074922, 8M0076464
Fits: Mercruiser 496 Mag & HO,
8.1L MIE & HO



**18-3568
THERMOSTAT KIT**
Replaces: 99155T1

Model	Year	Serial #
5.7MIE	1998-2001	OL002003 & Up
MX6.2L MPI	2000-2001	OL886003 & Up
454 Horizon MIE	1998-2001	OL002200 & Up
502 Mag MPI	1998-2001	OL17000 & Up



**18-3644
THERMOSTAT KIT**
—CONTAINS—

Part #	Description	O.E.#
18-3649	Thermostat 150°	807252T2
18-2553	Thermostat Cover Gasket	27-47510
18-2917	Thermostat Cover Gasket	27-53045-1



**18-3646
THERMOSTAT KIT**
Replaces: 807252Q3, 807252T6
—CONTAINS—

Part #	Description	O.E.#
18-3551	Thermostat	59137
18-2917	Thermostat Housing Gasket	27-53045-1, 27-33918
18-2844	Thermostat Cover Gasket	27-48818-1
18-2553	Thermostat Cover Gasket	27-47510
18-2834	Thermostat Cover Gasket	27-60208



**18-3647
THERMOSTAT KIT**
Replaces: 807252Q5, 807252T8
—CONTAINS—

Part #	Description	O.E.#
18-3649	Thermostat	807252-2
18-2844	Thermostat Cover Gasket	27-48818-1
18-2552	Thermostat Cover Gasket	27-33179-2
18-2553	Thermostat Cover Gasket	27-47510
18-7173	O-Ring	25-30224
18-2917	Thermostat Housing Gasket	27-53045-1, 27-33918



**18-3648
THERMOSTAT KIT**
160°



**18-3650
THERMOSTAT KIT**
Replaces: 59078T3
—CONTAINS—

Part #	Description	O.E.#
18-2831	Thermostat Gasket	27-47590-1
18-3550	Thermostat	59078



**18-3651
THERMOSTAT KIT**
—CONTAINS—

Part #	Description	O.E.#
18-2554	Thermostat Cover Gasket	27-90556
18-2553	Thermostat Cover Gasket	27-47510
18-2834	Thermostat Cover Gasket	27-60208
18-2844	Thermostat Cover Gasket	27-48818-1
18-3551	Thermostat	59137



**18-3652
THERMOSTAT KIT**
—CONTAINS—

Part #	Description	O.E.#
18-2555	Thermostat Cover Gasket	27-89658-1
18-2843	Thermostat Cover Gasket	27-74830
18-3552	Thermostat	76270

THERMOSTAT APPLICATION BEGINS ON NEXT PAGE

① Items ending in "D" are Display Packaged - Regular number is Non-Display



**18-3667
THERMOSTAT KIT**
—CONTAINS—

Part #	Description	O.E.#
18-2555	Thermostat Cover Gasket	27-89656-1
18-3555	Thermostat	99155A1



18-3668
THERMOSTAT KIT
Replaces: 807252T4, 807252Q4
—CONTAINS—

Part #	Description	O.E.#
18-2552	Thermostat Cover Gasket	27-33179-2
18-2553	Thermostat Cover Gasket	27-47510
18-2554	Thermostat Cover Gasket	27-41812
18-3551	Thermostat	59137
18-7173	O-Ring	25-30224
18-2917	Thermostat Housing Gasket	27-53045-1, 27-33918



**18-1977-1
THERMOSTAT HOUSING**
Replaces: 47441, 47441A1
Fits: 225, GM 260, 228, 898/198,
185R, 898R, 228R, 2GR



**18-1989
THERMOSTAT HOUSING**
Replaces: 8M0061381, 861006A1
Stainless Steel
Use 18-1989K Thermostat Service Kit
for replacement parts



**18-1994
THERMOSTAT HOUSING**
Replaces: 87290A4
For: Stainless Steel Version use 18-1989



**18-3531
THERMOSTAT HOUSING**
Replaces: 807074A1, 808064A1,
861188A1
Fits: MCM/MIE GM V-6 & V-8 (305, 350, 454
& 502 cid) engines w/closed cooling systems



**18-1910
THERMOSTAT HOUSING KIT**
Replaces: 47587, 47587A2, 47588,
60372A1, 60372A2, 63908A2,
861493A07, 861493A3
Fits: 3.0L GM 1999-Up, S/N
0L340999-Lower



**18-1989K
THERMOSTAT SERVICE KIT**
Service Kit for 18-1989 Thermostat Housing



**18-1508
THERMOSTAT SEAL**
Replaces: 25-8071341
Fits: Vazer (2007 & UP), GM V6 & V8
with closed cooling systems (1996 & UP)

THERMOSTAT APPLICATION

Engine/Model	CID/CYL	Year Range	Beginning Serial #	Ending Serial #	Housing	Thermostat Cover	Thermostat & Gasket Kit	Thermostat	Gaskets Req.	Gaskets Req. - Design II	Gaskets Req. - Design III
ROVER			3140000	UP				18-3551			
60	66L4	1965-1968	1887079	2049044				18-3551			
80	80L4	1966-1969	2049045	2851423				18-3551			
90	96L4	1970-1972	2851424	3226957				18-3557	18-2831		
100 VASER	99L4	2007-2010	w995000	& UP					18-1508		
110	153L4	1963-1966	1537370	2044033	ⓐ			18-3551			
110	153L4	1963-1966	1821720	2044033	ⓑ			18-3551			
120	153L4	1964-1972	1666601	3377340	ⓐ			18-3551			
120	153L4	1964-1966	1725593	2046624	ⓑ			18-3551			
120	153L4	1967	2046625	2324346	ⓐ			18-3551			
120	153L4	1968-1972	2324347	3377340	18-3650 ⓐ, ⓑ		18-3650	18-3550	18-2831		
120	153L4	1972-1986	3377341	8531853	18-3650 ⓑ		18-3650	18-3550	18-2831		
2.5L	153L4	1967-1989	8531854	C853255	18-3650 ⓑ		18-3650	18-3550	18-2831		
140	181L4	1968-1986	2508261	B450800	18-3650 ⓑ		18-3650	18-3550	18-2831		
140 (6 CYL)			1538830	1725960	—			18-3551	—		

- ⓐ Design I
- ⓑ Design II
- ⓒ Design III
- ⓓ Aluminum Exhaust Manifold
- ⓔ Cast Iron Exhaust Manifold
- ⓕ Closed Cooling
- ⓖ Standard Cooling
- ⓗ With check ball
- ⓓ Without check ball
- ⓔ SN 4167000 & Up
- ⓕ Original thermostat housing listed as NLA. Order update kit 87290A23
- ⓖ Original thermostat housing listed as NLA. Order update kit 90736A24
- ⓗ Complete thermostat housing kit kit
- ⓓ Single and 3-point drain system
- ⓔ 7-point drain system
- ⓕ Mechanical Throttle Body
- ⓖ Digital Throttle Body
- ⓗ Emission Control Engine
- ⓓ Manual drain system
- ⓔ Air Actuated drain system
- ⓕ Old Design
- ⓖ New Design
- ⓗ 160 degree
- ⓓ For Stainless Steel version use 18-1989

THERMOSTAT APPLICATION (Cont.)

Engine/Model	CID/CYL	Year Range	Beginning Serial #	Ending Serial #	Housing	Thermostat Cover	Thermostat & Gasket Kit	Thermostat	Gaskets Req.	Gaskets Req. - Design I	Gaskets Req. - Design II
3.0L	181L4	1987-1989	B450801	C856558	18-3650 ①		18-3650	18-3550	18-2831		
3.0L FWC	181L4	1990-2010	C856559	UP	②		18-3647	18-3649			
3.0L	181L4	1990-1994	C856559	F603999	18-3650 ②, ③		18-3650	18-3550	18-2831		
3.0L	181L4	2000-2010	L341000	& UP	④		18-3647	18-3649	18-2552		
3.0L	181L4	1998-2000	L010042	L340999	18-3650 ②, ③		18-3650	18-3550	18-2831		
3.0L MPI	181L4	2008-2010	A072812	& UP			18-3647	18-3649	18-2552		
3.0L MPI FWC	181L4	2008-2010	A072812	& UP	⑤		18-3647	18-3649			
3.0LX FWC	181L4	1990-1997	C856559	K999999	⑥		18-3647	18-3649			
3.0LX	181L4	1990-1997	C856559	K999999	18-1910 ②, ③		18-3650	18-3550	18-2831		
150			1666495	2048046	—			18-3551	—		
160	⑦		2048022	2770031	—			18-3551	—		
160	⑧		2048022	2233574	—			18-3557	—		
160	⑨		2326069	2770031	—			18-3557	18-2831		
165			2770032	5813433	—		18-3650	18-3550	18-2831		
165	224L4	1987	B434941	B774251			18-3667	18-3555	18-2555		
165			6916779	UP	—		18-3667	18-3555	18-2555		
170	224L4	1985-1986	6916779	B434940	18-3667		18-3667	18-3555	18-2555		
175/4.3L 4.3LX (262 CID)	⑩		B527955	UP	—		18-3668	18-3551	18-2553	18-2554	
175/4.3L 4.3LX (262 CID)	⑪		B527955	UP	—		18-3668	18-3551	18-2552	18-7173	
175/4.3L 4.3LX (262 CID)	⑫		F001220	UP	—		18-3648	18-3649 ⑬	18-2552	18-7173	
180/3.7L LX (4 CYL)			6916779	UP	—		18-3667	18-3555	18-2555		
180	224L4	1987	B436391	B775248			18-3667	18-3555	18-2555		
185 (229 CID)			6330183	6919655	18-1994 ▼		18-3668	18-3551	18-2553	18-2554	
185 (262 CID)			A331455	B527954	18-1994 ▼		18-3668	18-3551	18-2553	18-2554	
190			1564539	1730903	—			18-3551	—	—	
190	224L4	1985-1986	6916779	B436390			18-3667	18-3555	18-2555		
3.7L	224L4	1988-1989	B774562	& UP			18-3667	18-3555	18-2555		
3.7LX	224L4	1988-1989	B775249	& UP			18-3667	18-3555	18-2555		
470 MCMME	224L4	1976-1982	4206730	6218036				18-3552	18-2843		
470	224L4	1983-1984	6218037	6916778			18-3667	18-3555	18-2555		
485	224L4	1980-1982	5685394	6218036				18-3552	18-2555		
488	224L4	1983-1984	6170297	6916778			18-3667	18-3555	18-2555		
140 (6 CYL)	194L6	1963	1538930	1725960				18-3551			
150	200L6	1964-1966	1666495	2048046	⑭			18-3551			
150	200L6	1964-1966	1727965	2048046	⑮			18-3551			
160	250L6	1967-1969	2048022	2770031	⑯			18-3551			
160	250L6	1967	2048022	2233574	⑰			18-3551			
160	250L6	1968-1969	2326069	2770031	18-1910 ⑱, ⑲			18-3557	18-2831		
165 (6 CYL)	250L6	1970-1981	2770032	5813433	18-1910 ⑲		18-3650	18-3550	18-2831		
200 (6 CYL)	282L6	1969	2453769	2712072	18-1910 ⑲			18-3557	18-2831		
185 (4bb)	229-V-6	1983-1984	6330183	6919655	18-3678		18-3668	18-3551	18-2554	18-2553	18-2917
175	262V-6	1987	B527955	B773242	18-1994 ⑳	18-1977-1	18-3668	18-3551	18-2554	18-2553	18-2917
175	262V-6	1987	B527955	B773242	㉑, ㉒		18-3668	18-3551	18-7173		18-2917
185 (2bb)	262V-6	1985-1986	A331455	B527954	18-1994	18-1977-1	18-3668	18-3551	18-2554	18-2553	18-2917
205	262V-6	1985-1986	A331455	B527954	18-3668	18-1977-1	18-3668	18-3551	18-2554	18-2553	18-2917
205	262V-6	1987	B527955	B775129	18-3668 ㉓	18-1977-1	18-3668	18-3551	18-2554		18-2917
205	262V-6	1967	B527955	B775129	㉔, ㉕		18-3668	18-3551	18-7173	18-2552	18-2917
205/4.3L 4.3LX (262 CID)	⑳		B527955	D714369	— ㉖		18-3668	18-3551	18-2552	18-7173	
205/4.3L 4.3LX (262 CID)	㉗		F001220	UP	—		18-3648	18-3649 ㉘	18-2552	18-7173	

- ① Design I
- ② Design II
- ③ Design III
- ④ Aluminum Exhaust Manifold
- ⑤ Cast Iron Exhaust Manifold
- ⑥ Closed Cooling
- ⑦ Standard Cooling
- ⑧ With check ball

- ⑨ Without check ball
- ⑩ SN 4167000 & Up
- ⑪ Original thermostat housing listed as NLA. Order update kit 87290A23
- ⑫ Original thermostat housing listed as NLA. Order update kit 90736A24
- ⑬ Complete thermostat housing kit
- ⑭ Single and 3-point drain system
- ⑮ 7-point drain system
- ⑯ Mechanical Throttle Body

- ⑰ Digital Throttle Body
- ⑱ Emission Control Engine
- ⑲ Manual drain system
- ㉑ Air Actuated drain system
- ㉒ Old Design
- ㉓ New Design
- ㉔ 160 degree
- ㉕ For Stainless Steel version use 18-1989

THERMOSTAT APPLICATION (Cont.)

Engine/Model	CID/CYL	Year Range	Beginning Serial #	Ending Serial #	Housing	Thermostat Cover	Thermostat & Gasket Kit	Thermostat	Gaskets Req.	Gaskets Req. - Design II	Gaskets Req. - Design III
215 FORD			2781153	3040410	—			18-3551	—	—	
215 FORD			3040411	UP	—		18-3651	18-3551	18-2834	—	
215 FORD MCMMIE			3040411	3385720	—		18-3646	18-3649	18-2834	—	
225 FORD MCMMIE			3385721	4176999	—		18-3646	18-3649	18-2834	—	
262 MAG EFI ALPHA	262V-6	1996-1997	0F803800	0K999999	18-3647		18-3647	18-3649	18-2917		
262 MAG EFI BRAVO	262V-6	1996-1997	0F803800	0K999999	18-3647		18-3647	18-3649	18-2917		
4.3L	262V-6	1988-1993	E773243	F000877	18-1994 ①	18-1977-1	18-3668	18-3551	18-2554	18-2553	18-2917
4.3L	262V-6	1987-1993	E773243	F000877	② ③		18-3668	18-3551	18-7173	18-2552	18-2917
4.3L	262V-6	1993-1995	F000878	F601126	18-3647 ④ ⑤		18-3668	18-3649	18-2917	18-2552	18-2917
4.3L	262V-6	1993-1995	F000878	F601126	⑥		18-3668	18-3551	18-0398		
4.3L FWC	262V-6	1993-2002	F000878	M614999	18-3531 ⑦		18-3588	18-3555	18-0398		
4.3L ALPHA	262V-6	1996-2002	0F601127	M614999	18-3647 ⑧		18-3647	18-3649	18-2917		
4.3L BRAVO	262V-6	1996-2002	0F601127	M614999	18-3647 ⑨		18-3647	18-3649	18-2917		
4.3L FWC	262V-6	2002-2010	M615000	& UP	⑩				18-0398		
4.3L	262V-6	2002-2010	M615000	& UP	⑪		18-3647	18-3649	18-0398		
4.3L EFI FWC	262V-6	1998-2001	L012009	M239999	18-3531 ⑫		18-3588	18-3555	18-0398		
4.3L EFI ALPHA	262V-6	1998-2001	L012009	M239999	⑬		18-3647	18-3649	18-0398		
4.3L EFI BRAVO	262V-6	1998-2001	L012009	M239999	⑭		18-3647	18-3649	18-0398		
4.3L MPI	262V-6	2002-2010	M300000	& UP	⑮, ⑯		18-3647	18-3649	18-0398		
4.3L MPI	262V-6	2002-2010	M300000	& UP	⑰, ⑱		18-3647	18-3649	18-0398		
4.3L MPI EC	262V-6	2010-2011	A637496	& UP	⑲, ⑳		18-3647	18-3649	18-0398		
4.3L MPI FWC	262V-6	2002	M300000	M614999	㉑		18-3588	18-3555	18-0398		
4.3L MPI FWC	262V-6	2002-2010	M615000	& UP	㉒				18-0398		
4.3LH FWC	262V-6	1998-2002	L010044	M614999	18-3531 ㉓		18-3588	18-3555	18-0398		
4.3LH ALPHA	262V-6	1998-2002	L010044	M614999	㉔		18-3647	18-3649	18-0398		
4.3LH BRAVO	262V-6	1998-2002	L010044	M614999	㉕		18-3647	18-3649	18-0398		
4.3LX	262V-6	1988-1993	E775130	F001219	18-1994 ㉖	18-1977-1	18-3668	18-3551	18-2554	18-2553	18-2917
4.3LX	262V-6	1988-1993	E775130	F001219	㉗, ㉘		18-3668	18-3551	18-7173	18-2552	18-2917
4.3LX	262V-6	1993-1995	F001220	F601126	㉙, ㉚		18-3668	18-3551	18-7173	18-2552	18-2917
4.3LX	262V-6	1993-1995	F001220	F601126	㉛		18-3668	18-3551	18-0398		
4.3LX FWC	262V-6	1993-1997	F001220	K999999	㉜		18-3567	18-3555	18-0398		
4.3LX ALPHA	262V-6	1996-1997	F601127	K999999	㉝		18-3647	18-3649	18-0398		
4.3LX BRAVO	262V-6	1996-1997	F601127	K999999	㉞		18-3647	18-3649	18-0398		
4.3LXH FWC	262V-6	1996-1997	F803114	K999999	18-3531 ㉟		18-3588	18-3555	18-0398		
4.3LXH ALPHA	262V-6	1996-1997	F803114	K999999	㊱		18-3647	18-3649	18-0398		
4.3LXH BRAVO	262V-6	1996-1997	F803114	K999999	㊲		18-3647	18-3649	18-0398		
215 MCMMIE (FORD)	302V-8	1970	2781153	3040410				18-3649			
215 MCMMIE (FORD)	302V-8	1971-1972	3040411	3385720			18-3646	18-3551	18-2834		
225 MCMMIE (FORD)	302V-8	1973-1974	3385721	4176999			18-3646	18-3551	18-2834		
88B (FORD)	302V-8	1971-1977	3108723	4887829	㊳		18-3646	18-3551	18-2834		
190	283V-8	1963-1964	1564539	1730903				18-3551			
198 ME	305V-8	1977	4762210	6218461							
198 ME	305V-8	1977	4776402	4931099		18-1977-1	18-3646	18-3551	18-2844	18-0398	
200	305V-8	1965-1987	6899058	E774444	18-1994	18-1977-1	18-3668	18-3551	18-2554	18-2553	18-2917
200 GM			6218462	B525981	18-1994 ㊴		18-3668	18-3551	18-2553	18-2554	
2005.0L			0B525982	0F600999			18-3647	18-3649	—		
2005.0L GM	㊵		B525982	UP	18-1994 ㊵		18-3668	18-3551	18-2553	18-2554	
2005.0L GM	㊶		B525982	UP	18-1994 ㊶		18-3648	18-3649 ㊷	18-2552	18-7173	
228	305V-8	1977-1982	4765100	6218461		18-1977-1	18-3646	18-3551	18-2844	18-0398	

- ① Design I
- ② Design II
- ③ Design III
- ④ Aluminum Exhaust Manifold
- ⑤ Cast Iron Exhaust Manifold
- ⑥ Closed Cooling
- ⑦ Standard Cooling
- ⑧ With check ball

- ⑨ Without check ball
- ⑩ SN 4167000 & Up
- ⑪ Original thermostat housing listed as NLA. Order update kit 87290A23
- ⑫ Original thermostat housing listed as NLA. Order update kit 90736A24
- ⑬ Complete thermostat housing kit
- ⑭ Single and 3-point drain system
- ⑮ 7-point drain system
- ⑯ Mechanical Throttle Body

- ㊰ Digital Throttle Body
- ㊱ Emission Control Engine
- ㊲ Manual drain system
- ㊳ Air Actuated drain system
- ㊴ Old Design
- ㊵ New Design
- ㊶ 160 degree
- ㊷ For Stainless Steel version use 18-1989

THERMOSTAT APPLICATION (Cont.)

Engine/Model	CID#CYL	Year Range	Beginning Serial #	Ending Serial #	Housing	Thermostat Cover	Thermostat & Gasket Kit	Thermostat	Gaskets Req.	Gaskets Req. - Design #	Gaskets Req. - Design #
228	305V-8	1982-1984	6218462	6899268	18-1994	18-1977-1	18-3668	18-3551	18-2554	18-2553	18-2917
228 ME	305V-8	1977-1980	4785100	5907057	18-3651	18-1977-1	18-3646	18-3551	18-2944		
230	305V-8	1985-1987	6899269	8773739	18-1994	18-1977-1	18-3668	18-3551	18-2554	18-2553	18-2917
230 ME	305V-8	1981-1987	5807058	8788151	18-1994	18-1977-1	18-3668	18-3551	18-2554	18-2553	18-2917
230 ME FWC	305V-8	1981-1987	5907058	8788151	ⓐ	18-1977-1	18-3646	18-3551	18-2553	18-2844	18-2917
230 GM			6218462	8525981	18-1994	♥		18-3668	18-3551	18-2553	18-2554
230 ME			5907058	085225505			18-3646	18-3649	18-2553	18-2844	18-2917
230 GM IB	ⓐ		5907058	8522505	ⓐ		18-3668	18-3551	18-2553	18-2554	
230 GM IB	ⓐ		5907058	8522505	ⓐ		18-3651	18-3551	18-2553	18-2844	
2305.0L GM IB	ⓐ, ⓑ		8522506	8525981	ⓐ, ⓑ		18-3668	18-3551	18-2553	18-2554	18-2917
2305.0L GM IB	ⓐ, ⓑ		8522506	8525981	ⓐ, ⓑ		18-3648	18-3649	18-2552	18-7173	18-2917
2305.0L GM IB	ⓐ		8522506	8525981			18-3651	18-3551	18-2553	18-2844	18-2917
2305.0L-LX GM	ⓐ		8525982	F600999	18-1994	♥		18-3668	18-3551	18-2553	18-2554
2305.0L-LX GM	ⓐ		8525982	UP			18-3668	18-3551	18-2552	18-7173	
2305.0L GM IB	ⓐ		8522506	8525981			18-3648	18-3649	18-2552	18-7173	
2305.0L-LX GM			8525982	F600999	18-1994	♥		18-3648	18-3649	18-2552	18-7173
2305.0L ME			08522506	08788151			18-3646	18-3649	18-2553	18-2944	18-2917
2305.0LX GM			08525982	0F600999			18-3647	18-3649	18-2917	—	
5.0L	305V-8	1988-1995	8774445	F600999	18-1994	ⓐ	18-1977-1	18-3668	18-3551	18-2554	18-2553
5.0L	305V-8	1988-1995	8774445	F600999	ⓐ, ⓑ			18-3668	18-3551	18-7173	18-2552
5.0L	305V-8	1988-1995	8774445	F600999	ⓐ, ⓑ			18-3668	18-3551	18-7173	18-2552
5.0L	305V-8	1988-1995	8774445	F600999	ⓐ			18-3647	18-3649	18-0398	18-2917
5.0L (GEN+) FWC	305V-8	1998-2002	L015751	M599999	18-3531	ⓐ		18-3568	18-3555	18-1508	18-2917
5.0L (GEN+) FWC	305V-8	2002-2010	M600000	& UP	ⓐ				18-0398		18-2917
5.0L (GEN+) ALPHA	305V-8	1998-2002	L015751	M599999	ⓐ			18-3647	18-3649	18-0398	
5.0L (GEN+) BRAVO	305V-8	1998-2002	L015751	M599999	ⓐ			18-3647	18-3649	18-0398	
5.0L (GEN+)	305V-8	2002-2010	M600000	& UP	ⓐ			18-3647	18-3649	18-0398	
5.0L EFI FWC	305V-8	1998-2001	L012052	M299999	18-3531	ⓐ		18-3668	18-3555	18-1508	
5.0L EFI ALPHA	305V-8	1998-2001	L012052	M299999	ⓐ			18-3647	18-3649	18-0398	
5.0L EFI BRAVO	305V-8	1998-2001	L012052	M299999	ⓐ			18-3647	18-3649	18-0398	
5.0L MIE FWC	305V-8	1988	8788152	C396832	ⓐ	18-1977-1	18-3646	18-3551	18-2553	18-2844	
5.0L MIE	305V-8	1988	8788152	C396832	ⓐ, ⓑ, ⓐ			18-3668	18-3551	18-7173	
5.0L MIE	305V-8	1988	8788152	C396832	18-1994	ⓐ, ⓑ	18-1977-1	18-3668	18-3551	18-2554	18-2553
5.0L MPI FWC	305V-8	2002	M300000	M599999	ⓐ			18-3568	18-3555	18-0398	
5.0L MPI FWC	305V-8	2002-2010	M600000	& UP	ⓐ				18-0398		18-2917
5.0L MPI FWC DTS	305V-8	2005-2010	W310000	& UP	ⓐ, ⓐ				18-0398		18-2917
5.0L MPI FWC EC	305V-8	2008-2010	A300000	& UP	ⓐ, ⓑ, ⓐ				18-0398		
5.0L MPI FWC EC DTS	305V-8	2008-2010	A300000	& UP	ⓐ, ⓐ, ⓐ				18-0398		
5.0L MPI	305V-8	2002-2010	M300000	& UP	ⓐ, ⓐ		18-3647	18-3649	18-0398		18-2917
5.0L MPI ALPHA	305V-8	2002	M300000	M599999	ⓐ, ⓐ		18-3647	18-3649	18-0398		
5.0L MPI BRAVO	305V-8	2002	M300000	M599999	ⓐ, ⓐ		18-3647	18-3649	18-0398		
5.0L MPI	305V-8	2002-2010	M600000	& UP	ⓐ, ⓐ		18-3647	18-3649	18-0398		
5.0L MPI EC	305V-8	2008-2010	A300000	& UP	ⓐ, ⓐ		18-3647	18-3649	18-0398		
5.0L LX	305V-8	1988-1995	8773740	F600999	18-1994	ⓐ	18-1977-1	18-3668	18-3551	18-2554	18-2553
5.0LX	305V-8	1988-1995	8773740	F600999	ⓐ, ⓐ			18-3668	18-3551	18-7173	18-2552
5.0LX	305V-8	1988-1995	8773740	F600999	ⓐ			18-3647	18-3649	18-0398	
898	305V-8	1977-1982	4782210	6218461			18-1977-1	18-3646	18-3551	18-2944	18-0398
898	305V-8	1983-1984	6218462	6899057	18-1994		18-1977-1	18-3668	18-3551	18-2554	18-2553
225 (GM)	327V-8	1967-1969	2389198	2694014			18-1977-1	18-3651	18-3551	18-2553	18-2844

- ⓐ Design I
- ⓑ Design II
- ⓒ Design III
- ⓓ Aluminum Exhaust Manifold
- ⓔ Cast Iron Exhaust Manifold
- ⓕ Closed Cooling
- ⓖ Standard Cooling
- ⓗ With check ball

- ⓓ Without check ball
- ⓔ SN 4167000 & Up
- ⓕ Original thermostat housing listed as NLA. Order update kit 87290A23
- ⓖ Original thermostat housing listed as NLA. Order update kit 90736A24
- ⓗ Complete thermostat housing kit kit
- ⓓ Single and 3-point drain system
- ⓔ 7-point drain system
- ⓕ Mechanical Throttle Body

- ⓖ Digital Throttle Body
- ⓗ Emission Control Engine
- ⓓ Manual drain system
- ⓔ Air Actuated drain system
- ⓕ Old Design
- ⓖ New Design
- ⓗ 160 degree
- ⓔ For Stainless Steel version use 18-1989

THERMOSTAT APPLICATION (Cont.)

Engine/Model	CID/CYL	Year Range	Beginning Serial #	Ending Serial #	Housing	Thermostat Cover	Thermostat & Gasket Kit	Thermostat	Gaskets Req.	Gaskets Req. - Design #	Gaskets Req. - Design #
225 (GM)	327V-8	1963-1967	1539620	2399197	N.L.A.			18-3551			
225 (GM)			2278647	2399197			18-3668	18-3551	18-2552	18-7173	
225/225S FORD			3385721	UP			18-3651	18-3551	18-2834		
250 MCM/ME	327V-6	1968-1969	2314301	2639854		18-1977-1	18-3651	18-3551	18-2553	18-2844	
250	350V-6	1977	4768000	4908849		18-1977-1	18-3651	18-3551	18-2844		
250 (GM)			4768000	4908849			18-3646	18-3551	18-2844		
250 (GM)			4175500	5907057			18-3651	18-3649	18-2844	18-2917	
255 (GM)	350V-6	1975-1976	4175500	4767999		18-1977-1	18-3646	18-3551	18-2844	18-0398	
255 (GM) MIE	350V-6	1975-1980	4175500	5907057		18-1977-1	18-3646	18-3551	18-2844	18-0398	
255 (GM) MIE	350V-6	1979-1980	5195909	5907057							
255 FORD			3258728	UP			18-3651	18-3551	18-2834	—	
255 FORD MCM/ME			3258728	4178299			18-3646	18-3649	18-2834	—	
260	350V-6	1978-1982	4908850	6218461		18-1977-1	18-3651	18-3551	18-2844	18-0398	
260	350V-6	1982-1987	6218462	8773304	18-1994	18-1977-1	18-3668	18-3551	18-2554	18-2553	18-2917
260 MIE FWC	350V-6	1981-1987	5907058	8788151	ⓐ	18-1977-1	18-3646	18-3551	18-2553	18-2844	18-2917
260 MIE	350V-6	1981-1987	5907058	8788151	18-1994 ⓐ	18-1977-1	18-3668	18-3551	18-2554	18-2553	18-2917
260 GM			6218462	8625981	18-1994 ♠		18-3668	18-3551	18-2553	18-2554	
260 GM			4908850	6218461			18-3646	18-3649	18-2844	18-2917	
260 GM IB	ⓐ		5907058	8622505	ⓐ		18-3668	18-3551	18-2553	18-2554	
260 GM IB	ⓐ		5907058	8622505	ⓐ		18-3651	18-3551	18-2553	18-2844	
260 MIE			5907058	8622505			18-3646	18-3649	18-2553	18-2844	18-2917
260.5.7L GM IB	ⓐ ⓑ		8622506	8625981	ⓐ ⓑ		18-3668	18-3551	18-2553	18-2554	
260.5.7L GM IB	ⓐ ⓑ		8622506	8625981	ⓐ ⓑ		18-3668	18-3551	18-2552	18-7173	
260.5.7L GM IB	ⓐ ⓑ		8622506	8625981	ⓐ ⓑ		18-3648	18-3649 ⓐ	18-2552	18-7173	
260.5.7L GM IB	ⓐ		8622506	8625981	ⓐ		18-3651	18-3551	18-2553	18-2844	
260.5.7L GM	ⓐ		8625982	F600999	18-1994 ♠		18-3668	18-3551 ⓐ	18-2553	18-2554	
260.5.7L GM	ⓐ		8625982	F600999			18-3668	18-3551 ⓐ	18-2552	18-7173	
260.5.7L GM	ⓐ		8625982	F600999			18-3648	18-3649 ⓐ	18-2552	18-7173	
260.5.7L GM			08625982	0F600999			18-3647	18-3649	18-2917	—	
260.5.7L MIE			08622506	0F024999			18-3646	18-3649	18-2553	18-2844	18-2917
270 MCM/ME	350V-6	1969-1972	2851074	3385720		18-1977-1	18-3646	18-3551	18-2553	18-2844	18-2917
270 GM			2851074	3077735			18-3651	18-3551	18-2553	18-2844	
280 GM	350V-6	1975-1976	4176250	4770199		18-1977-1	18-3646	18-3649	18-2844	18-0398	
280 GM TRS			4176250	4770199			18-3651	18-3551	18-2844		
300	350V-6	1985-1986	6686677	B430367		18-1977-1	18-3668	18-3551	18-2554	18-2553	18-2917
320 EFI	350V-6	1987-1989	A543604	C622418		18-1977-1	18-3646	18-3551	18-2553	18-2844	18-2917
325 GM MCM/ME			2278747	3780449			18-3646	18-3649	18-2553	18-2844	18-2917
325 GM			2278747	2313964			18-3668	18-3551	18-2553	—	
325 GM			2313965	3042730			18-3651	18-3551	18-2553	18-2844	
325 GM			3042731	UP			18-3651	18-3551	18-2844	—	
330 GM			4623115	UP			18-3651	18-3551	18-2844	—	
330 GM MCM/ME			4623115	08816540			18-3646	18-3649	18-2553	18-2844	18-2917
330 GM W/BW	ⓐ		6063145	UP	ⓐ		18-3668	18-3551	18-2553	18-2554	
330 GM W/BW	ⓐ		6063145	UP	ⓐ		18-3651	18-3551	18-2553	18-2844	
360 MAG ALPHA	350V-6	1987-1995	8625982	F600999	ⓐ ⓑ		18-3668	18-3551	18-7173		18-2917
360 MAG ALPHA	350V-6	1986-1995	A635178	8625981	ⓐ	18-1977-1	18-3668	18-3551	18-2554	18-2553	18-2917
360 MAG ALPHA	350V-6	1987-1995	8625982	F600999	ⓐ ⓑ		18-3668	18-3551	18-7173	18-2552	18-2917
360 MAG ALPHA	350V-6	1987-1997	8625982	K999999	ⓐ		18-3647	18-3649	18-0398		
360 MAG ALPHA EFI (GEN +)	350V-6	1996-1997	F600300	K999999			18-3647	18-3649	18-0398		

- ⓐ Design I
- ⓑ Design II
- ⓒ Design III
- ⓓ Aluminum Exhaust Manifold
- ⓔ Cast Iron Exhaust Manifold
- ⓕ Closed Cooling
- ⓖ Standard Cooling
- ⓗ With check ball

- ⓐ Without check ball
- ⓑ SN 4167000 & Up
- ⓒ Original thermostat housing listed as N.L.A. Order update kit 87290A23
- ⓓ Original thermostat housing listed as N.L.A. Order update kit 90736A24
- ⓔ Complete thermostat housing kit
- ⓕ Single and 3-point drain system
- ⓖ 7-point drain system
- ⓗ Mechanical Throttle Body

- ⓐ Digital Throttle Body
- ⓑ Emission Control Engine
- ⓒ Manual drain system
- ⓓ Air Actuated drain system
- ⓔ Old Design
- ⓕ New Design
- ⓖ 160 degree
- ⓗ For Stainless Steel version use 18-1989

THERMOSTAT APPLICATION (Cont.)

Engine/Model	CID/CYL	Year Range	Beginning Serial #	Ending Serial #	Housing	Thermostat Cover	Thermostat & Gasket Kit	Thermostat	Gaskets Req.	Gaskets Req. - Design II	Gaskets Req. - Design III
350 MAG BRAVO MPI	350V-8	1995-1997	F415189	K999999			18-3647	18-3649	18-0398		
350 MAG EFI SKI	350V-8	1994-1997	F215561	K999999			18-3647	18-3649	18-0398		
350 MAG MPI FWC	350V-8	1998-2001	L010019	M299999	18-3531 ①		18-3568	18-3555	18-1508		
350 MAG MPI	350V-8	1998-2001	L010019	M299999	①		18-3647	18-3649	18-0398		
350 MAG MPI FWC	350V-8	2002	M300000	M599999	②		18-3568	18-3555	18-0398		
350 MAG MPI FWC	350V-8	2002-2010	M600000	& UP	③				18-0398		
350 MAG MPI FWC DTS	350V-8	2005-2010	W310000	& UP	④, ⑦				18-0398		
350 MAG MPI FWC EC	350V-8	2008-2010	A300000	& UP	⑤, ⑥, ⑧				18-0398		
350 MAG MPI FWC EC DTS	350V-8	2008-2010	A300000	& UP	⑤, ⑦, ⑧		NA		18-0398		
350 MAG MPI	350V-8	2002	M300000	M599999	⑨, ④		18-3647	18-3649	18-0398		
350 MAG MPI ALPHA	350V-8	2002	M300000	M599999	⑨, ⑤		18-3647	18-3649	18-0398		
350 MAG MPI BRAVO	350V-8	2002	M300000	M599999	⑨, ⑤		18-3647	18-3649	18-0398		
350 MAG MPI	350V-8	2002-2010	M600000	& UP	⑨, ⑤		18-3647	18-3649	18-0398		
350 MAG MPI	350V-8	2002-2010	M600000	& UP	⑨, ④		18-3647	18-3649	18-0398		
350 MAG MPI EC	350V-8	2008-2010	A300000	& UP	⑨, ⑥		18-3647	18-3649	18-0398		
350 MAG MPI HORIZON	350V-8	2002	M300000	M599999	⑩		18-3568	18-3555	18-0398		
350 MAG MPI HORIZON	350V-8	2002-2007	M600000	A299999	⑪				18-0398		
350 MAG MPI HORIZON MIE	350V-8	1999-2001	L304700	M299999	18-3531 ⑫		18-3568	18-3555	18-1508		
350 MAG MPI HORIZON MIE	350V-8	2002	M300000	M316999	⑬		18-3568	18-3555	18-1508		
350 MAG MPI HORIZON MIE	350V-8	2002-2007	M317000	A069999	⑭				18-0398		
350 MAG MPI MIE FWC	350V-8	1998-2001	L002008	M299999	18-3531 ⑮		18-3568	18-3555	18-1508		
350 MPI MIE	350V-8	1998-2001	L002008	M299999	⑯		18-3647	18-3649	18-0398		
350 MAG MPI MIE FWC	350V-8	2002	M300000	M316999	⑰		18-3568	18-3555	18-1508		
350 MAG MPI MIE FWC	350V-8	2002-2007	M317000	A069999	⑱				18-0398		
350 MAG MPI MIE	350V-8	2002-2007	M300000	A069999	⑲		18-3647	18-3649	18-0398		
350 MAG MPI SKI	350V-8	1995-2001	F350583	M299999			18-3647	18-3649	18-0398		
350 MAG MPI SKI	350V-8	2002-2007	M300000	A069999			18-3647	18-3649	18-0398		
350 MAG SKI	350V-8	1991-1996	D505450	K040389	⑲, ⑳		18-3668	18-3551	18-7173	18-2532	18-2917
350 MAG SKI	350V-8	1991-1997	D505450	K999999	㉑		18-3647	18-3649	18-0398		
5.7L	350V-8	1988-1995	B773305	F600999	18-1994 ㉒	18-1977-1	18-3668	18-3551	18-2554	18-2553	18-2917
5.7L	350V-8	1988-1995	B773305	F600999	㉓, ㉔		18-3668	18-3551	18-7173	18-2552	18-2917
5.7L	350V-8	1988-1995	B773305	F600999	㉓, ㉔		18-3668	18-3551	18-7173	18-2552	18-2917
5.7L	350V-8	1988-1996	B773305	K001526	㉕		18-3647	18-3649	18-2944	18-0398	
5.7L FWC	350V-8	1987	K001527	K999999	18-3531 ㉖		18-3568	18-3555	18-1508		
5.7L ALPHA	350V-8	1988-1997	B773305	F600999	㉗		18-3647	18-3649	18-0398		
5.7L BRAVO	350V-8	1995-1997	F601000	K999999	㉘		18-3647	18-3649	18-0398		
5.7L (GEN+) FWC	350V-8	1998-2002	L010037	M599999	18-3531 ㉙		18-3568	18-3555	18-1508		
5.7L (GEN+) ALPHA	350V-8	1998-2002	L010037	M599999	㉚		18-3647	18-3649	18-0398		
5.7L (GEN+) BRAVO	350V-8	1998-2002	L010037	M599999	㉛		18-3647	18-3649	18-0398		
5.7L (GEN+) FWC	350V-8	2002-2010	M600000	& UP	㉜				18-0398		
5.7L (GEN+)	350V-8	2002-2010	M600000	& UP	㉝		18-3647	18-3649	18-0398		
5.7L EFI FWC	350V-8	1995-1996	F225260	K001505	㉞		18-3647	18-3649	18-2944	18-0398	
5.7L EFI FWC	350V-8	1997-2001	K001506	M299999	18-3531 ㉟		18-3568	18-3555	18-1508		
5.7L EFI ALPHA	350V-8	1995-2001	F355305	M299999	㊱		18-3647	18-3649	18-0398		

- ① Design I
- ② Design II
- ③ Design III
- ④ Aluminum Exhaust Manifold
- ⑤ Cast Iron Exhaust Manifold
- ⑥ Closed Cooling
- ⑦ Standard Cooling
- ⑧ With check ball

- ⑨ Without check ball
- ⑩ SN 4167000 & Up
- ⑪ Original thermostat housing listed as NLA. Order update kit 87290A23
- ⑫ Original thermostat housing listed as NLA. Order update kit 90736A24
- ⑬ Complete thermostat housing kit
- ⑭ Single and 3-point drain system
- ⑮ 7-point drain system
- ⑯ Mechanical Throttle Body

- ⑰ Digital Throttle Body
- ⑱ Emission Control Engine
- ⑲ Manual drain system
- ㉑ Air Actuated drain system
- ㉒ Old Design
- ㉓ New Design
- ㉔ 160 degree
- ㉕ For Stainless Steel version use 18-1989

THERMOSTAT APPLICATION (Cont.)

EngnModel	CID/CYL	Year Range	Beginning Serial #	Ending Serial #	Housing	Thermostat Cover	Thermostat & Gasket Kit	Thermostat	Gaskets Req.	Gaskets Req. - Design II	Gaskets Req. - Design III
5.7L EFI BRAVO	350V-8	1995-2001	F225560	M299999	ⓐ		18-3647	18-3649	18-0398		
5.7L EFI MIE (GEN +) FWC	350V-8	1997	K040300	K999999	18-3531 ⓐ		18-3568	18-3555	18-1508		
5.7L EFI MIE (GEN +)	350V-8	1997	K040300	K999999	ⓐ		18-3647	18-3649	18-0398		
5.7L MIE	350V-8	1988-1995	B788152	F800399	18-1994 ⓐ	18-1977-1	18-3668	18-3551	18-2554	18-2553	18-2917
5.7L MIE	350V-8	1988-1995	B788152	F622099	ⓐ, ⓑ		18-3668	18-3551	18-7173		18-2917
5.7L MIE	350V-8	1988-1995	B788152	F622099	ⓐ, ⓑ		18-3668	18-3555	18-7173		18-2917
5.7L MIE FWC	350V-8	1988-1996	B788152	K04306	ⓐ		18-3647	18-3649	18-2844		
5.7L MIE FWC	350V-8	1997-2002	K040307	M316999	18-3531 ⓐ		18-3568	18-3555	18-1508		
5.7L MIE	350V-8	1996-2002	F622100	M316999	ⓐ		18-3647	18-3649	18-0398		
5.7L MIE FWC	350V-8	2002-2010	M317000	& UP	ⓐ				18-0398		
5.7L MIE	350V-8	2002-2010	M317000	& UP	ⓐ		18-3647	18-3649	18-0398		
5.7L MPI HORIZON MIE	350V-8	2008-2010	A0900000	& UP	ⓐ				18-0398		
5.7L MPI MIE FWC	350V-8	2008-2010	A0900000	& UP	ⓐ				18-0398		
5.7L MPI MIE FWC DTS	350V-8	2008-2010	A0900000	& UP	ⓐ, ⓑ				18-0398		
5.7L MPI MIE FWC EC	350V-8	2008-2010	A0900000	& UP	ⓐ, ⓑ, ⓓ				18-0398		
5.7L MPI MIE FWC EC DTS	350V-8	2008-2010	A0900000	& UP	ⓐ, ⓑ, ⓓ				18-0398		
5.7L MPI MIE	350V-8	2008-2010	A0900000	& UP	ⓐ		18-3647	18-3649	18-0398		
5.7L MPI MIE EC	350V-8	2008-2010	A0900000	& UP	ⓐ, ⓑ		18-3647	18-3649	18-0398		
5.7L MPI SKI	350V-8	2008-2010	A0900000	& UP	ⓐ		18-3647	18-3649	18-0398		
5.7L MPI SKI EC	350V-8	2008-2010	A0900000	& UP	ⓐ		18-3647	18-3649	18-0398		
5.7L SKI	350V-8	1985-1986	A338553	F775199	18-1994 ⓐ	18-1977-1	18-3668	18-3551	18-2554	18-2553	18-0398
5.7L SKI	350V-8	1987-1995	B514627	F775199	ⓐ, ⓑ		18-3668	18-3551	18-7173		18-0398
5.7L SKI	350V-8	1987-1995	B514627	F775199	ⓐ, ⓑ		18-3668	18-3551	18-7173		18-0398
5.7L SKI	350V-8	1996-2002	F775200	M316999	ⓐ		18-3647	18-3649	18-0398		
5.7L SKI	350V-8	2002-2010	M317000	& UP	ⓐ		18-3647	18-3649	18-0398		
5.7LX ALPHA	350V-8	1995-1997	F601000	K999999	ⓐ		18-3647	18-3649	18-0398		
5.7LX BRAVO	350V-8	1995-1997	F601000	K999999	ⓐ		18-3647	18-3649	18-0398		
5.7LX RWC	350V-8	1996	F601000	K001526	ⓐ		18-3647	18-3649	18-2844	18-0398	
5.7LX RWC	350V-8	1997	K001527	K999999	18-3531 ⓐ		18-3568	18-3555	18-1508		
5.7LX BRAVO EFI (GEN +) FWC	350V-8	1996	F800300	K001508	ⓐ		18-3647	18-3649	18-2844	18-0398	
5.7LX BRAVO EFI (GEN +) FWC	350V-8	1997	K001509	K999999	ⓐ		18-3568	18-3555	18-0398		
5.7LX BRAVO EFI (GEN +)	350V-8	1996-1997	F800300	K999999	ⓐ		18-3647	18-3649	18-0398		
5.7LX EFI FWC	350V-8	1996	F752400	K001505	ⓐ		18-3647	18-3649	18-2844	18-0398	
5.7LX EFI FWC	350V-8	1997	K001506	K999999	18-3531 ⓐ		18-3568	18-3555	18-0398		
5.7LX EFI ALPHA	350V-8	1996-1997	F752400	K999999	ⓐ		18-3647	18-3649	18-0398		
5.7LX EFI BRAVO	350V-8	1996-1997	F752400	K999999	ⓐ		18-3647	18-3649	18-0398		
5.7 GM ALPHA			F225560	0K999999			18-3647	18-3649	18-2917	—	
5.7 GM BRAVO			F225560	0K999999			18-3647	18-3649	18-2917	—	
5.7L/EFI GM ALPHA			L010037	UP			18-3647	18-3649	18-2917	—	
5.7L/EFI GM BRAVO			L010037	UP			18-3647	18-3649	18-2917	—	
5.7L MIE			F025000	0F622099			18-3647	18-3649	18-2844	—	
5.7L MIE			F622100	0K999999			18-3647	18-3649	18-2917	—	
5.7L MIE			F622100	0K999999			18-3647	18-3649	18-2844	—	
5.7L MIE			L002003	UP			18-3647	18-3649	18-2917	—	
BLACK SCORPION SKI	350V-8	1996-2001	0F800000	M391599			18-3647	18-3649	18-0398		
BLACK SCORPION SKI	350V-8	2003-2006	M391600	V690192	ⓐ		18-3647	18-3649	18-0398		

- ⓐ Design I
- ⓑ Design II
- ⓓ Design III
- ⓔ Aluminum Exhaust Manifold
- ⓕ Cast Iron Exhaust Manifold
- ⓖ Closed Cooling
- ⓗ Standard Cooling
- ⓙ With check ball

- ⓑ Without check ball
- ⓓ SN 4167000 & Up
- ⓔ Original thermostat housing listed as NLA. Order update kit 87290A23
- ⓕ Original thermostat housing listed as NLA. Order update kit 90736A24
- ⓖ Complete thermostat housing kit
- ⓗ Single and 3-point drain system
- ⓙ 7-point drain system
- ⓚ Mechanical Throttle Body

- ⓓ Digital Throttle Body
- ⓕ Emission Control Engine
- ⓖ Manual drain system
- ⓗ Air Actuated drain system
- ⓙ Old Design
- ⓚ New Design
- ⓔ 160 degree
- ⓕ For Stainless Steel version use 18-1989

THERMOSTAT APPLICATION (Cont.)

Engine/Model	CID/CYL	Year Range	Beginning Serial #	Ending Serial #	Housing	Thermostat Cover	Thermostat & Gasket Kit	Thermostat	Gaskets Req.	Gaskets Req. - Design I	Gaskets Req. - Design II
BLACK SCORPION SKI	350V-8	2006-2007	W690193	W698432	⑨		18-3647	18-3649	18-0398		
BLACK SCORPION SKI	350V-8	2003-2007	M391600	W698433	⑩		18-3647	18-3649	18-0398		
SCORPION 350	350V-8	2008-2010	W698433	& UP	⑩		18-3647	18-3649	18-0398		
SCORPION 350	350V-8	2008-2010	W698433	& UP	⑩		18-3647	18-3649	18-0398		
SCORPION 350 EC	350V-8	2008-2010	W698433	& UP	⑩		18-3647	18-3649	18-0398		
233 MCM (FORD)	351V-8	1975-1977	4173000	4902304			18-3646	18-3551	18-2834		
233 MIE (FORD)	351V-8	1975-1977	4173000	4902304			18-3646	18-3551	18-2834		
255 MCM (FORD)	351V-8	1973-1974	3258728	4178299			18-3646	18-3551	18-2834		
377 MAG FWC	377V-8	2008-2010	A300000	& UP	⑥, ⑧				18-0398		
377 MAG FWC DTS	377V-8	2008-2010	A300000	& UP	⑥, ⑦				18-0398		
377 MAG FWC EC	377V-8	2008-2010	A300000	& UP	⑥, ⑧				18-0398		
377 MAG FWC EC DTS	377V-8	2008-2010	A300000	& UP	⑥, ⑦, ⑧				18-0398		
377 MAG	377V-8	2008-2010	A300000	& UP	⑥, ⑤		18-3647	18-3649	18-0398		
377 MAG	377V-8	2008-2010	A300000	& UP	⑥, ⑤		18-3647	18-3649	18-0398		
377 MAG EC	377V-8	2008-2010	A300000	& UP	⑥, ⑧		18-3647	18-3649	18-0398		
377 SCORPION MCM	377V-8	1999-2005	L416146	M907201		18-1977-1		18-3551	18-0398		18-2553
377 SCORPION SKI	377V-8	1997-1998	K000656	L600314			18-3647	18-3649	18-0398		
MX 6.2L MPI FWC	377V-8	2000-2001	L680003	M299999	18-3531 ④		18-3568	18-3555	18-0398		
MX 6.2L MPI	377V-8	2000-2001	L680003	M299999	④		18-3647	18-3649	18-0398		
MX 6.2L MPI FWC	377V-8	2002	M300000	M599999	④		18-3568	18-3555	18-0398		
MX 6.2L MPI FWC	377V-8	2002-2007	M600000	A299999	④				18-0398		
MX 6.2L MPI	377V-8	2002-2007	M300000	A299999	④, ⑤		18-3647	18-3649	18-0398		
MX 6.2L MPI	377V-8	2002-2007	M300000	A299999	④, ⑤		18-3647	18-3649	18-0398		
MX 6.2L MPI HORIZON	377V-8	2002	M300000	M599999	④		18-3568	18-3555	18-0398		
MX 6.2L MPI HORIZON	377V-8	2002-2007	M600000	A299999	④				18-0398		
MX 6.2L MPI HORIZON MIE	377V-8	2002	M300000	M316999	④		18-3568	18-3555	18-0398		
MX 6.2L MPI HORIZON MIE	377V-8	2002-2010	M317000	& UP	④				18-0398		
MX 6.2L MPI MIE FWC	377V-8	1999-2002	L670000	M316999	④		18-3568	18-3555	18-0398		
MX 6.2L MPI MIE FWC	377V-8	2002-2010	M317000	& UP	④, ⑤				18-0398		
MX 6.2L MPI MIE FWC DTS	377V-8	2008-2010	A0900000	& UP	④, ⑦				18-0398		
MX 6.2L MPI MIE FWC EC	377V-8	2008-2010	A0900000	& UP	④, ⑤, ⑧				18-0398		
MX 6.2L MPI MIE FWC EC DTS	377V-8	2008-2010	A0900000	& UP	④, ⑦, ⑧				18-0398		
MX 6.2L MPI MIE	377V-8	2002-2010	M300000	& UP	④		18-3647	18-3649	18-0398		
MX 6.2L MPI MIE	377V-8	2008-2010	A0900000	& UP	④		18-3647	18-3649	18-0398		
MX 6.2L BLACK SCORPION	377V-8	2001-2002	L005601	M391599			18-3647	18-3649	18-0398		
MX 6.2L BLACK SCORPION	377V-8	2003-2006	M391600	W690192	⑩		18-3647	18-3649	18-0398		
MX 6.2L BLACK SCORPION	377V-8	2006-2007	W690192	W698432	⑨		18-3647	18-3649	18-0398		
SCORPION 377	377V-8	2008-2010	W698433	& UP	⑩		18-3647	18-3649	18-0398		
SCORPION 377	377V-8	2008-2010	W698433	& UP	⑩		18-3647	18-3649	18-0398		
SCORPION 377 HD EC	377V-8	2008-2010	A091488	A0G2170	⑩		18-3647	18-3649	18-0398		
325 MCM (FORD)	427V-8	1969-1972	2278747	3780449			18-3646	18-3551	18-2553		18-0398
330 (WITH MERC TRANS)	454V-8	1977-1981	4623115	6083144			18-3646	18-3551	18-2844	18-0398	
330 (WITH BW) FWC	454V-8	1982-1987	6083145	B816540	④		18-3646	18-3551	18-2553		18-0398

- ④ Design I
- ⑤ Design II
- ⑥ Design III
- ⑦ Aluminum Exhaust Manifold
- ⑧ Cast Iron Exhaust Manifold
- ⑨ Closed Cooling
- ⑩ Standard Cooling
- ⑪ With check ball

- ⑫ Without check ball
- ⑬ SN 4167000 & Up
- ⑭ Original thermostat housing listed as NLA. Order update kit 87290A23
- ⑮ Original thermostat housing listed as NLA. Order update kit 90736A24
- ⑯ Complete thermostat housing kit
- ⑰ Single and 3-point drain system
- ⑱ 7-point drain system
- ⑲ Mechanical Throttle Body

- Ⓣ Digital Throttle Body
- Ⓤ Emission Control Engine
- ⓖ Manual drain system
- ⓗ Air Actuated drain system
- ⓓ Old Design
- ♣ New Design
- ♠ 160 degree
- ♣ For Stainless Steel version use 18-1989

THERMOSTAT APPLICATION (Cont.)

Engine/Model	CID/CYL	Year Range	Beginning Serial #	Ending Serial #	Housing	Thermostat Cover	Thermostat & Gasket Kit	Thermostat	Gaskets Req.	Gaskets Req. - Design II	Gaskets Req. - Design III
330 (WITH B/W)	454V-8	1982-1987	6063145	B816540	18-3678 Ⓢ		18-3668	18-3551	18-2554	18-2553	18-0398
330 ME (WITH MERC TRANS)	454V-8	1977-1980	4623115	5889913			18-3646	18-3551	18-2844	18-0398	
340 ME FWC	454V-8	1981-1987	5889914	B788365	Ⓢ		18-3646	18-3551	18-2553	18-2844	18-0398
340 ME	454V-8	1981-1987	5889914	B788365	18-3678 Ⓢ		18-3668	18-3551	18-2554	18-2844	18-0398
340 ME	454V-8	1981-1987	5889914	B788365	Ⓢ, Ⓢ		18-3668	18-3551	18-2554	18-2553	18-0398
3407 AL ME			5889914	00715493			18-3646	18-3649	18-2553	18-2844	18-2917
360 ME	454V-8	1974-1976	3780450	4623109			18-3646	18-3551	18-2844	18-0398	
360 GM (MAGNUM)			A635178	B625981			18-3668	18-3551	18-2553	18-2554	
360 GM (MAGNUM)	II		B625982	UP	Ⓢ		18-3668	18-3551	18-2553	18-2554	
350 GM (MAGNUM)	II		B625982	UP	Ⓢ		18-3668	18-3551	18-2552	18-7173	
350 GM (MAGNUM)	II		B625982	UP	18-3648 Ⓢ		18-3648	18-3649	18-2552	18-7173	
370	454V-8	1978-1985	4179554	6721527		18-1977-1	18-3646	18-3551	18-2553	18-2844	18-0398
370	454V-8	1985-1987	6721528	B714586			18-3668	18-3551	18-2554	18-2553	18-0398
370 TRS GM			4179554	6721527			18-3651	18-3551	18-2553	18-2844	
370 TRS GM			6721528	UP			18-3668	18-3551	18-2553	18-2554	
390 GM			2781129	2825059			18-3651	18-3551	18-2553	18-2844	
390 GM MCOMMIE			2781129	3042731			18-3646	18-3649	18-2553	18-2844	18-2917
400	454V-8	1980-1986	4179554	08457644			18-3646	18-3551	18-2553	18-2554	18-0398
400 TRS GM			4179554	UP			18-3651	18-3551	18-2553	18-2844	
420 GM			A398941	UP	18-3651		18-3651	18-3551	18-2553	18-2844	
420	454V-8	1987-1989	A398941	B622418	18-1994	18-1977-1	18-3646	18-3551	18-2553	18-2844	18-0398
425	454V-8	1990-1993	A398941	D837011	18-3678			18-3551		18-2553	18-0398
440	454V-8	1983-1986	4179554	B485220			18-3646	18-3551	18-2553	18-2844	18-0398
450	454V-8	1995-1996	F347100	F347277	18-1994	18-1977-1		18-3551		18-2553	18-0398
525 SC	454V-8	1991-1999	D456000	L415623		18-1977-1		18-3551		18-2553	18-0398
454 MAG ALPHA	454V-8	1986-1988	A631894	B785148	18-3678 Ⓢ		18-3668	18-3551	18-2554	18-2553	18-0398
454 MAG ALPHA	454V-8	1986-1988	A631894	B785148	Ⓢ, Ⓢ		18-3668	18-3551	18-7173	18-2552	18-3098
454 MAG BRAVO	454V-8	1988-1992	B721206	D805068	18-3678 Ⓢ		18-3668	18-3551	18-2554	18-2553	18-0398
454 MAG BRAVO	454V-8	1995-1997	F305000	K999999	Ⓢ, Ⓢ		18-3647	18-3649	18-0398		
454 MAG BRAVO	454V-8	1988-1992	B721206	D805068	Ⓢ, Ⓢ		18-3668	18-3551	18-7173		18-0398
454 MAG BRAVO	454V-8	1992-1994	D805069	F304999	Ⓢ, Ⓢ		18-3668	18-3551	18-7173		18-0398
454 MAG EFI	454V-8	1995-1997	F115700	F802349	Ⓢ		18-3647	18-3649	18-0398		
454 MAG EFI SKI	454V-8	1995-1997	F215800	K999999	Ⓢ		18-3647	18-3649	18-0398		
454 MAG MPI	454V-8	1996-2001	F802350	M024999	Ⓢ		18-3647	18-3649	18-0398		
454 MAG MPI FWC	454V-8	1998-2001	L010029	M024999	18-3531 Ⓢ		18-3568	18-3555	18-0398		
454 MAG MPI HOPI-ZION ME	454V-8	1998-2001	L002200	L674000	18-3531 Ⓢ		18-3568	18-3555	18-0398		
454 MAG MPI SKI	454V-8	1996-1997	F820100	K999999	Ⓢ		18-3647	18-3649	18-0398		
525 SC	454V-8	1991-1999	D456000	L415623		18-1977-1		18-3551		18-2553	18-0398
7.4L BRAVO	454V-8	1995-1997	0F352000	0K999999	Ⓢ		18-3647	18-3649	18-0398		
7.4L BRAVO	454V-8	1988-1991	B771113	D603117	18-3678 Ⓢ		18-3668	18-3551	18-2554	18-2553	18-0398
7.4L BRAVO	454V-8	1988-1991	B771113	D603117	Ⓢ, Ⓢ		18-3668	18-3551	18-7173	18-2552	18-0398
7.4L BRAVO	454V-8	1992-1994	D603118	F351999	Ⓢ, Ⓢ		18-3668	18-3551	18-7173	18-2552	18-0398
7.4L EFI MIE	454V-8	1995-1997	F874815	K999999	Ⓢ		18-3647	18-3649	18-0398		
7.4L EFI MIE FWC	454V-8	1996-1997	F874815	K999999	18-3531 Ⓢ		18-3568	18-3555	18-0398		
7.4L MIE FWC	454V-8	1988-1992	B788366	D715493	Ⓢ		18-3646	18-3551	18-2553	18-2844	18-0398
7.4L MIE	454V-8	1988-1992	B788366	D715493	Ⓢ, Ⓢ		18-3668	18-3551	18-2554	18-2553	18-0398
7.4L MIE	454V-8	1989-1994	C391564	D715493	Ⓢ		18-3668	18-3551	18-7173	18-2552	18-0398
7.4L MIE FWC	454V-8	1989-1994	C391564	D715493	Ⓢ		18-3646	18-3551	18-2553	18-2844	18-0398

- Design I
- Design II
- Design III
- Aluminum Exhaust Manifold
- Cast Iron Exhaust Manifold
- Closed Cooling
- Standard Cooling
- With check ball

- Ⓢ Without check ball
- Ⓢ SN 4167000 & Up
- Ⓢ Original thermostat housing listed as NLA. Order update kit 87290A23
- Ⓢ Original thermostat housing listed as NLA. Order update kit 90736A24
- Ⓢ Complete thermostat housing kit kit
- Ⓢ Single and 3-point drain system
- Ⓢ 7-point drain system
- Ⓢ Mechanical Throttle Body

- Ⓢ Digital Throttle Body
- Ⓢ Emission Control Engine
- Ⓢ Manual drain system
- Ⓢ Air Actuated drain system
- Ⓢ Old Design
- Ⓢ New Design
- Ⓢ 160 degree
- Ⓢ For Stainless Steel version use 18-1989

THERMOSTAT APPLICATION (Cont.)

Engine/Model	CID/CYL	Year Range	Beginning Serial #	Ending Serial #	Housing	Thermostat Cover	Thermostat & Gasket Kit	Thermostat	Gaskets Req.	Gaskets Req. - Design I	Gaskets Req. - Design II
7.4L ME	454V-8	1989-1994	D715494	F349999	①		18-3668	18-3651	18-7173	18-2552	18-0398
7.4L ME FWC	454V-8	1989-1994	D715494	F820141	②		18-3646	18-3649	18-2553	18-2844	18-0398
7.4L ME	454V-8	1995-1996	F350000	F820141	③		18-3647	18-3649	18-0398		
7.4L ME	454V-8	1996-1997	F820142	K999999	④		18-3647	18-3649	18-0398		
7.4L ME	454V-8	1996-1997	F820142	K999999	⑤		18-3647	18-3649	18-2844	18-0398	
7.4L MPI	454V-8	1998-2001	L010003	M024330	⑥		18-3647	18-3649	18-0398		
7.4L MPI ME	454V-8	1995-2001	F563062	M025999	⑦		18-3647	18-3649	18-0398		
7.4L MPI ME FWC	454V-8	1995-2001	F563062	M025999	⑧		18-3668	18-3655	18-0398		
7.4LX BRAVO EFI	454V-8	1996-1997	F620000	K999999	⑨		18-3647	18-3649	18-0398		
7.4L BRAVO MPI	454V-8	1996-1997	F602010	K999999	⑩		18-3647	18-3649	18-0398		
7.4L ME			0C391564	0D715493			18-3646	18-3649	18-2553	18-2844	18-2917
7.4L ME			0C391564	0F349999			18-3646	18-3649	18-2553	18-2844	18-2917
390 MCMME	482V-8	1969-1970	2781129	3042731			18-3646	18-3651	18-2553	18-2844	18-0398
460	482V-8	1983-1986	4179554	6181046			18-3668	18-3651	18-2554	18-2553	18-0398
465	502V-8	1980-1984	C849992	F213244	18-3678			18-3651		18-2553	18-0398
470			4208730	6218036			18-3652	18-3652	18-2843		
470			6218037	UP			18-3667	18-3655	18-2555	—	
485			5685394	UP			18-3652	18-3652	18-2555	—	
488			6170297	UP			18-3667	18-3655	18-2555	—	
500	502V-8	1994-1998	F213293	L001772	18-1994	18-1977-1		18-3651		18-2553	18-0398
500 (GEN+)	502V-8	1999	L414839	L601036	18-1994	18-1977-1		18-3651		18-2553	18-0398
500 EFI	502V-8	1999-2005	L001477	M907127		18-1977-1		18-3651		18-2553	18-0398
502 MAG	502V-8	1990-1993	C878221	F114528	⑪		18-3668	18-3651	18-7173	18-2552	18-0398
502 MAG EFI	502V-8	1993-1995	D640650	F802599	⑫		18-3647	18-3649	18-0398		
502 MAG MPI	502V-8	1996-1997	F802600	K999999	⑬		18-3647	18-3649	18-0398		
502 MAG MPI FWC	502V-8	1998-2001	L017000	M024999	18-3531 ⑭		18-3668	18-3655	18-0398		
525 EFI	502V-8	2003-2010	M900146	& UP			NA		18-1508		
575 GM			0A677429	0D763716			18-3646	18-3649	18-2553	18-2844	18-2914
575			A677429	UP			18-3651	18-3651	18-2553	18-2844	
8.2L MAG	502V-8	2010	A350340	& UP					18-1508		
8.2L ME EC	502V-8	2010	A350602	& UP					18-1508		
8.2L ME	502V-8	1990-1992	C878221	D657199	⑮		18-3668	18-3651	18-7173	18-2552	18-0398
8.2L ME FWC	502V-8	1990-1992	C878221	D657199	⑯		18-3668	18-3651	18-2553	18-2844	18-0398
8.2L ME	502V-8	1993-1996	D657200	F350274	⑰		18-3647	18-3649	18-0398		
8.2L ME	502V-8	1996	F350275	F819619	⑱		18-3647	18-3649	18-0398		
8.2L ME FWC	502V-8	1993-1996	D657200	F819619	⑲		18-3647	18-3649	18-2844	18-0398	
8.2L MPI ME	502V-8	1996-2001	F819620	L674200	⑳		18-3647	18-3649	18-0398		
8.2L MPI ME FWC	502V-8	1996-2001	F819620	L674200	18-3531 ㉑		18-3668	18-3655	18-1508		
500 BULLDOG	540V-8	1990-2001	C577254	M050281	18-1994	18-1977-1		18-3651		18-2553	18-0398
888 FORD			3108723	UP			18-3651	18-3651	18-2834		
888 FORD MCM			3108723	4887829			18-3646	18-3649	18-2834		
898/198 GM			4762210	6218461			18-3651	18-3651	18-2844		
898/198 GM MCMME			4762210	6218461			18-3646	18-3649	18-2844	18-2917	
898 GM		1977-1982	4762210	6218461							
898 GM			6218462	UP			18-3668	18-3651	18-2553	18-2554	

- ① Design I
- ② Design II
- ③ Design III
- ④ Aluminum Exhaust Manifold
- ⑤ Cast Iron Exhaust Manifold
- ⑥ Closed Cooling
- ⑦ Standard Cooling
- ⑧ With check ball

- ⑨ Without check ball
- ⑩ SN 4167000 & Up
- ⑪ Original thermostat housing listed as NLA. Order update kit 87290A23
- ⑫ Original thermostat housing listed as NLA. Order update kit 90736A24
- ⑬ Complete thermostat housing kit
- ⑭ Single and 3-point drain system
- ⑮ 7-point drain system
- ⑯ Mechanical Throttle Body

- ⑰ Digital Throttle Body
- ⑱ Emission Control Engine
- ⑲ Manual drain system
- ⑳ Air Actuated drain system
- ㉑ Old Design
- ㉒ New Design
- ㉓ 160 degree
- ㉔ For Stainless Steel version use 18-1989



18-7702
AIR CHARGE
TEMPERATURE SENDER
Replaces: 805223T
Fits: Mercruiser V6 & V8(350, 454, 496
& 502 cid)MPI engines



18-5897
SENDER
Replaces: 97257A1, 806490T,
97257, 806490, 811091, 36525
For Water Temperature
3/8" - 18 NPT



18-5898
SENDER
Replaces: 97258A1, 97258, 34625,
F16900198, F16900152
For Water Temperature
1/2" -14 NPT



18-5899
OIL PRESSURE SENDER
Replaces: 90806, 815425T, 90806A1,
815425, 34623, 8M0068784
For Oil Pressure

TEMPERATURE SENDER/OIL SENDER APPLICATION

Model	Serial No.	Oil Pressure	Water Temperature	Model	Serial No.	Oil Pressure	Water Temperature
ROVER	31400000F & UP	—	18-5897	270	2851074-3077735	18-5899	18-5897
110	1565944-1566081	18-5899	18-5898	280	4176250 & UP	18-5899	18-5898
110	1602980 & UP	18-5899	18-5898	300 MR/TRS	6668677 & UP	18-5899 ②	18-5897 ②
120	2324346 & BELOW	18-5899	18-5898	320	A543604 & UP	18-5899 ②	18-5897 ②
120	2324347 & UP	18-5899 ① ②	18-5897 ②	325	2278747 & UP	18-5899	18-5897 ③ ④
140 (4 cyl/3.0)	2508061 - 3482807	18-5899 ②	18-5897 ②	330	4623115 & UP	18-5899	18-5898
140 (4cyl/3.0)	4512156 & UP	18-5899 ②	18-5897 ②	330/W.B.W.	6083145 & UP	18-5899 ②	18-5897 ②
3.0L/3.0LX	C856559 & UP	18-5899 ②	18-5897 ②	340/7.4L	5889914 & UP	18-5899 ②	18-5897 ②
140 (6 cyl)	1566119-1725960	18-5899	18-5898	350	3780450 & UP	18-5899	18-5898
150	1666495-2048046	18-5899	18-5898	350 (Magnum)	A635178- B525981	18-5899 ②	18-5897 ②
160	2048022-2770031	18-5899	18-5897 ④ ⑤	350 (Magnum)	B525982-0505449	—	18-5897 ② ⑥ ⑦
165	2770032 & UP	18-5899	18-5897	350 (Magnum)	D505450 & UP	18-5899 ②	18-5897 ②
165/3.7L/170/180	6916779 & UP	18-5899	—	370 (TRS)	4179554 & UP	18-5899 ②	18-5897 ②
175 (262 CID)	B527955 & UP	18-5899 ②	18-5897 ② ③ ④	390	2781129-2825059	18-5899	18-5897
4.3L (Generation II)	D714107 & UP	18-5899 ②	18-5897 ②	400	4179554 & UP	18-5899	18-5897
185 (228 CID)	6330183 & UP	18-5899 ②	18-5897 ②	420/425	A398941 & UP	18-5899 ②	18-5897 ②
185 (262 CID)	A331455 & UP	18-5899 ②	18-5897 ②	440	4179554 & UP	18-5899	18-5897
190	1504311-1730903	18-5899	18-5898	454 (Magnum)	A631894 & UP	18-5899 ②	18-5897 ②
190 (4 cyl)	6916779 & UP	18-5899	—	454 (Bravo)	B721206-D805068	18-5899 ③	18-5897 ② ④ ⑦
200	2453769-271202	18-5899	18-5897	460	4179554	18-5899	18-5897
200	6218462 & UP	18-5899 ②	18-5897 ②	465	C849992 & UP	18-5899 ②	18-5897 ③
200/5.0	B525982 & UP	—	18-5897 ② ③ ④	500	C577254 & UP	18-5899 ②	18-5897 ②
205 (262 CID)	A331455 & UP	18-5899 ②	18-5897 ②	502 (Bravo)	C878221 & UP	18-5899 ②	18-5897 ②
205 (4.3L)	B527955 & UP	18-5899 ②	18-5897 ② ③ ④	502 (Bravo Gen V)	D824589 & UP	—	18-5897
4.3LX (Generation II)	D714370 & UP	18-5899 ②	18-5897 ②	525	D456000 & UP	18-5899 ③	18-5897 ②
215	2781153 & UP	18-5899	18-5897	575	A677429 & UP	18-5899 ②	18-5899 ②
225 (Ford)	3385721 & UP	18-5899	18-5897	688	3108720 & UP	18-5899	18-5897
225 (GM)	1632308-2694014	18-5899	18-5897 ③ ④ ⑤	898	4762210-6218461	18-5899	18-5898
228	4765100-6218461	18-5899	18-5898	898	6218462 & UP	18-5899 ②	18-5897 ②
228 & 230	6218462 & UP	18-5899 ②	18-5897 ②	5.7	A338553-B514626	18-5899 ②	18-5897 ②
230 (I.B.)	5907058 & UP	18-5899 ②	18-5897 ②	5.7	B514627-B525981	18-5899 ②	18-5897 ② ③ ④
230 (5.0)	B522506 & UP	18-5899 ④	18-5897 ③ ④	5.7 (Bravo)	B525982 & UP	—	18-5897 ④ ⑦
233 Ford	4173000 & UP	18-5899	18-5898	7.4 (Bravo)	B771113-D803117	18-5899 ②	18-5897 ② ③ ④
250	9314301-4908849	18-5899	18-5897 ③ ④	7.4 (Bravo Gen V)	D803118 & UP	—	18-5897 ②
255	3258728 & UP	18-5899	18-5898	7.4L (Hurth)	ALL	18-5899 ③	18-5897 ②
260	4908850-6218461	18-5899	18-5898	454	D805069 & UP	—	18-5897 ②
260	6218462 & UP	18-5899 ②	18-5897 ②	8.2	C878221-D857199	18-5899 ③	18-5897 ②
260/5.7	B522506 & UP	18-5899 ④	18-5897 ③ ④	8.2	D857200 & UP	—	18-5897 ②
260	5907058 & UP	18-5899 ②	18-5897 ②				

① S/N - 3377341-3461707 & 5192049 & UP
② Does not include Dual application
③ 2326096 & UP

④ 2233574 & Below use 18-5898
⑤ (3/8 - 18)
⑥ (1/2 -14) Use 18-5898

⑦ Electric Choke
⑧ Auto Choke
⑨ Thru S/N B525981 only



18-70948
MOLDED HOSE
Replaces: 32-808033

Fits: 262 Mag EFI Bravo w/Fuel Cool System (1996-97), 4.3L EFI (TBI) (1998-01), 5.0L (Gen+) Bravo (1998-07), 5.0L EFI (Gen+) (1998-01), 350 Mag Alpha (Gen+) (1997), 350 Mag Alpha EFI (Gen+) (1997), 350 Mag Bravo MPI (Gen+) (1997), 350 Mag MPI (Gen+) (1998-01), 5.7L (1997), 5.7L (Gen+) (1998-07), 5.7L EFI (1997), 5.7L EFI (Gen+) 1998-2001, 5.7LX (1997), 5.7LX Bravo EFI (Gen+) (1997), 5.7LX EFI (1997).
For: Cooler to thermostal housing



18-70949
MOLDED HOSE
Replaces: 32-807407

Fits: 454 Mag MPI (Gen VI) (1996-01), 7.4LX MPI Bravo (Gen VI) (1996-97), 502 Mag MPI (Gen VI) (1996-01) **For:** Cooler to thermostal housing



18-70954
MOLDED HOSE

Replaces: 32-8600891, 32-860089
Fits: 5.0L (Gen+) Bravo (1998-07), 5.0L EFI (Gen+) Alpha & Bravo (1998-01), 350 Mag Alpha (1997), 350 Mag EFI (Gen+) Alpha (1997), 350 Mag EFI (Gen+) Alpha (1997), 350 Mag MPI (Gen+) Bravo (1997-01), 350 Mag MPI (Gen+) Alpha (1998-01), 5.7L Alpha & Bravo (1997), 5.7L (Gen+) Alpha & Bravo (1998-07), 5.7L EFI Bravo (1997-01), 5.7LX Alpha & Bravo (1997), 5.7LX EFI (Gen+) Alpha & Bravo (1997), 6.2L MPI (2000-01) **For:** oil cooler to oil cooler



18-70956
MOLDED HOSE
Replaces: 32-16012

Fits: MC175/205 (1987), 4.3L (1988-92), 4.3L (Gen II) (1992-95), 4.3LX (Gen II) (1992-95) **For:** Oil cooler to thermostal housing with all four hose connectors cast into the thermostal housing (No "T" connector) Two hoses to manifold and two hoses to elbow



18-70955
MOLDED HOSE

Replaces: 32-16011
Fits: MC200/230 (1987), 5.0L Alpha (1988-95), 5.0LX Alpha (1988-95), MC260 (1987), 350 Mag Alpha (1987-95), 5.7L Alpha & Bravo (1988-95), 454 Mag Bravo (1988-92), 7.4L (GenV) Bravo (1992-96)
For: Oil cooler to thermostal housing with all four hose connectors cast into the thermostal housing (No "T" connector) Two hoses to manifold and two hoses to elbow



18-70952
MOLDED HOSE
Replaces: 32-887952

Fits: 5.0 L Bravo (1988-95), 5.0LX Bravo (1988-95), 350 Mag MPI Bravo (1995), 350 Mag MPI (Gen+) Bravo (1996), 5.7L Bravo (1988-96), 5.7L EFI 1995, 5.7L EFI Bravo (1996), 5.7LX EFI (Gen+) Bravo (1996) **For:** Seawater pump to oil cooler



18-70953
MOLDED HOSE

Replaces: 32-8080441
Fits: 5.0L EFI (Gen+) Bravo (1998-01), 350 Mag MPI (Gen+) (1998-01), 5.7L Bravo (1997), 5.7L (Gen+) Bravo (1998-07), 5.7L EFI Bravo 1997, 5.7L EFI (Gen+) Bravo (1998-01), 5.7LX Bravo (1997), 5.7LX EFI (Gen+) Bravo (1997), 6.2L MPI (2000-01)
For: Seawater pump to oil cooler



18-70951
MOLDED HOSE
Replaces: 32-860205, 32-8078962, 32-8078961

Fits: 262 Mag, EFI Bravo (1996-97), 4.3L (Gen+) Bravo (1998-07), 4.3L TBI (Gen+) Bravo (1998-01), 4.3LH (Gen+) Bravo (1998-02), 4.3LX(H) (Gen+) Bravo (1996-97)
For: Seawater pump to oil cooler



18-70945
MOLDED HOSE
Replaces: 32-862139

Fits: 4.3L (Gen+) (1998-07), 4.3L EFI (Gen+) (1998-01), 4.3LH (Gen+) (1998-02)
For: Thermostat housing to port manifold with 2 piece exhaust manifold



18-70947
MOLDED HOSE
Replaces: 32-862124

Fits: 4.3L (Gen+) (1998-07) (S/N 0L619000 & UP), 4.3L EFI (Gen+) (2000-01), 4.3LH (Gen+) (2000-02)
For: Thermostat housing to starboard manifold with 2 piece exhaust manifold



**18-70940
MOLDED HOSE**
Replaces: 32-860144
Fits: 262 Mag with Fuel Cool, 4.3L-LX (1996 & Up) with 1 pc. manifold, 5.0L-EFI (1998 & Up), 350 Mag-MPI 97-01, 5.7L-EFI (1996-97), 6.2L MPI(20 01 & Up).
For: Thermostat housing to port exhaust manifold



**18-70946
MOLDED HOSE**
Replaces: 32-8066362
Fits: 262 Mag EFI (Gen+) (1998-97), 4.3L (Gen+) (1998-07) (S/N 0L01004-0L618999), 4.3L EFI (Gen+) (1998-00), 4.3LH (Gen+) 1998-00, 4.3LX (Gen+) (1996-97), 4.3LXH (Gen+) (1996-97)
For: Thermostat housing to starboard manifold with 2 piece exhaust manifold



**18-44092
MOLDED HOSE
TRANSOM TO T-STAT HSG**
Replaces: 32-861635
For: Mercruiser 3.0L



**18-70958
MOLDED HOSE**
Replaces: 32-96246A4, 32-96246A1, 32-96246
Fits: MC898 (1983-84), MC200 (1985-87), MC228 (1982-84), MC230 (1985-87), 5.0L & 5.0LX Alpha (1988-95), MC250 (1983-87), 300 Tempest MR (1985-86), MC320 EFI (1987-89), 350 MAG Alpha (1986-96), 5.7L Alpha (1988-95), 5.7LX & 5.7LX EFI Alpha (1996), 454 MAG Alpha (1986-88)
For: Transom to oil cooler



**18-70934
MOLDED HOSE**
Replaces: 32-897181
Fits: 330 (1977-87), 330 MIE (1977-80), 340 MIE W/ BW (1981-87), 370 TRS (1978-87), 400 TRS (1980-86), 420 (1987-89), 425 (1990-92), 425 (Gen V) (1992-93), 440 TRS (1983-86), 450 (Gen V) (1995-96), 454 EFI (Gen V) (1994-96), 454 Mag Alpha (1986-88), 454 Mag Bravo (1988-92), 454 Mag Bravo(Gen V) (1992-97), 454 Mag MPI Bravo(Gen V) (1996-98), 454 Mag MPI SKI (Gen V)(1996-97), 460 TRS (1983-86), 465 (1990-92), 465 (Gen V) (1992-94), 500 Gen + (1999), 500 (Gen V) (1994-96), 500 (Gen V)(1997-98), 502 EFI (Gen V)(1993-95), 502 Mag Bravo (1990-92), 502 Mag MPI Bravo (Gen V), 502 Mag Bravo(Gen V)(1992-93), 502 Mag MPI(Gen V)(1996), 7.4L MIE W/BW (1988-92), 7.4L Bravo (1988-91), 7.4L Bravo(Gen V)(1992-96), 7.4L Bravo (Gen V)(1996-97), 7.4L MIE (LH)(Gen V)(1992-96), 7.4L MIE (LH)(Gen V)(1996-97), 7.4L MIE W/Hurth (1989-92), 7.4L MIE MPI (LH)(Gen V)(1996-97), 7.4L TBI MIE (LH)(Gen V)(1996-97), 7.4LX Bravo MPI(Gen V)(1996-97), 7.4LX Bravo TBI(Gen V)(1996-97), 8.2L MIE (Gen V)(1993-96), 8.2L MIE MPI (Gen V), 8.2



**18-70935
MOLDED HOSE**
Replaces: 32-806856
Fits: 200 2bbl (1987), 230 4bbl (1987), 260 (1987), 350 Mag SKI (1991-96), 350 Mag Alpha (1987-95), 350 Mag Alpha 4bbl (1996), 350 Mag Alpha EFI (Gen+)(1996), 350 Mag Bravo MPI (1995), 350 Mag Bravo MPI (Gen+)(1996), 350 Mag EFI SKI TBI (1994-96), 350 Mag MPI SKI (1995-96), 4.3L (Gen II)(2bbl)(1993-96), 4.3LX (Gen II)(4bbl)(1993-96), 5.0L 2bbl (1988-95), 5.0LX 4bbl (1988-95), 5.7L (1988-95), 5.7L 2bbl (1996), 5.7L Alpha EFI TBI (1995), 5.7L Bravo EFI TBI(1995), 5.7L Competition SKI (1996), 5.7L EFI (2bbl TBI)(1996), 5.7L MIE (1996), 5.7LX 4bbl (1996), 5.7LX Bravo EFI (Gen+)(1996), 5.7LX EFI 4bbl TBI (1996), Black Scorpion(Gen+)(1996)
For: Oil cooler to thermostat housing.



**18-70938
MOLDED HOSE**
Replaces: 32-8066351
Fits: 262 Mag with VST (1996-97), 4.3L-LX (1993-96) Design III, 5.0L-LX (1988-95) Design III, 350Mag-EFI-MPI (1987-96), 5.7L-LX 88-96 Design III
For: Thermostat housing to port exhaust manifold



**18-70939
MOLDED HOSE**
Replaces: 32-8066361
Fits: 4.3L-LX (1993-96) Standard Cooling Design III, 5.0L-LX/5.7L-LX (1988-95) Standard Cooling Design III, 350 Mag (1987-95) Standard Cooling Design III
For: Thermostat housing to starboard exhaust manifold



**18-70943
MOLDED HOSE**
Replaces: 32-897491
Fits: 7.4L, 454 Mag, 502 Mag. For Thermostat housing to port exhaust manifold



**18-3601
GIMBAL HOUSING WATER FEED HOSE**
Replaces: 32-32461, 32-32461A1
Dia. 3/8"
Length 13 1/8"



18-3602
WATER INTAKE HOSE
 Replaces: 32-4172533, 32-8M0062309
 13 3/4" Length - 3/4" I.D.
 For: MR, Alpha I, Gen II



18-3603
WATER INTAKE HOSE
 Replaces: 32-43437, 32-8M0090859



18-70925
MOLDED HOSE
 Replaces: 32-160211, 32-87116, 32-16021
 For: 4.3L, 5.0L, & 5.7L
 For: Thermostat Cover to Port Manifold



18-70926
MOLDED HOSE
 Replaces: 32-73796
 For: 5.0L & 5.7L
 For: Thermostat Cover to Exhaust Elbow



18-70927
MOLDED HOSE
 Replaces: 32-73795
 For: 5.0L & 5.7L Port
 For: Thermostat Housing to Port Manifold



18-70928
MOLDED HOSE
 Replaces: 32-71613
 For: 5.0L & 5.7L
 For: Thermostat Housing to Oil Cooler



18-70929
MOLDED HOSE
 Replaces: 32-73794
 For: 5.0L & 5.7L Starboard
 For: Thermostat Housing to Starboard Manifold



18-70930
MOLDED HOSE
 Replaces: 32-52481
 For: GM Inline 4 & 6 cyl.
 For: Water Distribution Block to End Cap



18-70931
MOLDED HOSE
 Replaces: 32-96879, 32-47640, 32-8M0071007
 For: 2.5L & 3.0L
 For: Distribution Block to Water Pump



18-70932
MOLDED HOSE
 Replaces: 32-871171, 32-87117
 For: 4.3L, 5.0L, & 5.7L Starboard
 For: Thermostat Cover to Starboard Manifold

SINGLE DIAMETER HOSE



4 3/4"

18-70021
MOLDED HOSE
3/4" ID



5"

18-70704
MOLDED HOSE
Replaces: 32-89653
1 1/4" ID
For: 3.7L



5"

18-70924
MOLDED HOSE
1 1/4" ID



12 1/2"

18-71218
MOLDED HOSE
Replaces: 32-48131, 32-48132
1" ID
For: 230 & 260 MIE



12 3/4"

18-71337
MOLDED HOSE
Replaces: 32-861590A05, 32-861590A2, 32-806825
1 3/4" ID
For: 4.3L, 5.0L, 5.7L
Circulating Pump Hose

STRAIGHT HOSE



18-75100
MOLDED HOSE
Replaces: 32-8M0062614
Straight 48"
1" ID



18-75125
MOLDED HOSE
Replaces: 32-8M0062665, 32-865672070, 32-5346170
Straight 48"
1 1/4" ID

HOSE INTERCHANGE

Part No.	Mercruiser Part No.	Part No.	Mercruiser Part No.	Part No.	Mercruiser Part No.
18-70925	32-16021 1	18-70926	32-71613	18-70940	32-860144
18-3601	32-32461	18-70929	32-73794	18-71337	32-87108
18-71337	32-33189	18-70927	32-73795	18-70932	32-87117 1
18-3602	32-41725-33	18-70926	32-73796	18-70704	32-89653
18-3603	32-43437	18-70938	32-806635 1	18-70934	32-89718 1
18-71218	32-48132	18-70939	32-806636 1	18-70943	32-89749 1
18-70930	32-52481	18-70935	32-806856	18-70931	32-96879

V-BELTS



- 1 High strength synthetic cords resist shockload failure. Their low stretch properties assure uniform performance over the life of the belt.
- 2 The compression section is a special rubber compound that assures smooth and even transfer of load forces to the cords.
- 3 Cogs are molded to precise engineering tolerances to improve flexibility and maintain cord support. Cog geometry provides a large area for air circulation to keep the belt cool and prevent damaging heat build up in the cushion section.
- 4 Rubber edges maintain positive, no-slip contact with pulley grooves for reliable energy transfer.

BELT SIZE LISTING BY NUMBER

Part No.	OE #	Effective Length (in.)	Top Width (in.)	Part No.	OE #	Effective Length (in.)	Top Width (in.)
18-15290	57-13457, 57-13457T, 57-13457Q, 57-53215, 57-53215T	29	29/64	18-15435	57-64415, 57-49211	43 1/2	29/64
18-15300	57-49756	30	29/64	18-15440	57-49213A1, 57-45856	44	29/64
18-15325	57-7727AA1, 57-77274	32 1/2	29/64	18-15450	-	45	29/64
18-15345	57-74271T, 57-74271, 57-74271Q	34 1/2	29/64	18-15455	-	45 1/2	29/64
18-15370	57-65607T, 57-65607, 57-65607Q	37	29/64	18-15460	57-48120A1, 57-48120, 57-48120D1	46	29/64
18-15380	-	38	29/64	18-15470	57-78200A1, 57-78200, 57-78200D1	47	29/64
18-15390	57-52692	39	29/64	18-15480	57-48122, 57-48122Q	48	29/64
18-15400	57-32850, 57-69143T, 57-69143Q	40	29/64	18-15490	57-816295T, 57-816295Q	52 1/2	29/64
18-15405	57-76269, 57-76269Q	40 1/2	29/64	18-15495	57-91035A1, 57-91035Q1, 57-91035	49 1/2	29/64
18-15410	57-49043A1, 57-64032A1, 57-32850, 57-49043, 57-64032, 57-64032Q1, 57-81654	41	29/64	18-15500	57-96834T, 57-96834Q, 57-96834, 57-13458, 57-13458Q	50	29/64
18-15415	57-36556	41 1/2	29/64	18-15520	57-33170, 57-33170Q, 57-37619T	52	29/64
18-15430	57-49211, 57-64415	43	29/64	18-15550	57-13458T	55	29/64

V-BELT APPLICATION

HP	liter	Model	Years	CID	# Cyl	Stroke	Serial #	Belt Type	Alternator/ Water Pump	Power Steering	Sea Water Pump
110		110	1963-1966	153	4	4	1657370 - 2044033	V-BELT	18-15410	—	—
120		120	1964-1973	153	4	4	1666601 - 3773649	V-BELT	18-15410	—	—
120		120	1974-1982	153	4	4	3770650 - 8229717	V-BELT	18-15410	18-15400 (40" BELT)	—
120		120	1974-1982	153	4	4	3770650 - 8229717	V-BELT	18-15410	18-15400 (40" BELT)	—
120		120	1982-1986	153	4	4	8229716 - b531853	V-BELT	18-15410 (18)	—	—
120		120	1982-1986	153	4	4	8229716 - b531853	V-BELT	18-15400 (18)	—	—
120	2.5L	120	1982-89	153	4	4	8229718 - C853255	V-BELT	18-15410	—	—
120	2.5L	120 (18)	1982-89	153	4	4	8229716 - C853255	V-BELT	18-15400	18-15370	—
140		140	1968-73	181	4	4	2508261-3770649	V-BELT	18-15410	—	—

- (1) 1/2" wide (13mm) belt
- (2) 3/8" wide (10mm) belt
- (3) 28" wide (711mm) belt
- (4) 30" wide (762mm) belt
- (5) 37" wide (940mm) belt
- (6) 40" wide (1016mm) belt
- (7) 50" wide (1270mm) belt
- (8) 55" wide (1397mm) belt

- (9) Use with 5 1/2" (140mm) dia water pump pulley
- (10) Use with 5 7/8" (149mm) dia water pump pulley
- (11) Use with 7" (178mm) dia water pump pulley
- (12) Use with stamped steel sea water pump pulley
- (13) Use with cast aluminum sea water pump pulley
- (14) Use with plastic 4 3/4" (121mm) dia p/s pump pulley
- (15) Use with metal 5 3/4" (146mm) dia p/s pump pulley
- (16) For engine with high mounted p/s pump

- (17) For engines with low mounted p/s pump
- (18) For engine with power steering
- (19) For engines w/o power steering
- (20) For engines with closed cooling
- (21) For engines with standard cooling
- (22) Replacement kit includes 5 3/4" (146mm) pulley and longer serpentine belt
- (23) For engines with high mounted alternator

V-BELT APPLICATION

HP	Liter	Model	Years	CID	# Cyl	Stroke	Serial #	Belt Type	Alternator/ Water Pump	Power Steering	Sea Water Pump
140		140	1974-82	181	4	4	3770650-6229717	V-BELT	18-15416	18-15370 (37" BELT)	—
140		140	1974-82	181	4	4	3770650-6229717	V-BELT	18-15410	18-15400 (40" BELT)	—
140	3.0L	140 / 3.0L / 3.0LX	1982-1985	181	4	4	6229718 - B450800	V-BELT	18-15410 (19)	—	—
140	3.0L	140 / 3.0L / 3.0LX	1982-1999	181	4	4	6229718 - B450800	V-BELT	18-15400 (18)	18-15370	—
140	3.0L	3.0L	1987-1994	181	4	4	6229718 - F603999	V-BELT	18-15400 (18)	18-15370	—
140	3.0L	3.0L	1987-1994	181	4	4	6229718 - F603999	V-BELT	18-15400 (18)	18-15370	—
	3.0L	3.0L	1998-1999	181	4	4	L010042 - L382121	V-BELT	18-15400	18-15370	—
	3.0L	3.0L	1999-2010	181	4	4	L382122 & LP	V-BELT	—	18-15370	—
	3.0L	3.0LX	1990-1995	181	4	4	C856559 - F603999	V-BELT	18-15410 (19)	—	—
	3.0L	3.0LX	1990-1995	181	4	4	C856558 - F603999	V-BELT	18-15400 (18)	18-15370	—
	3.0L	3.0LX	1985-1997	181	4	4	F604000 - K999999	V-BELT	18-15400	18-15370	—
	3.0L	3.0L MPI	2008-2010	181	4	4	A072812 & LP	V-BELT	—	18-15370	—
150		150	1984-86		4	4	1856495-2048646	V-BELT	18-15410	—	—
160		160	1967-69		4	4	2048022-2770031	V-BELT	18-15410	—	—
185		185	1987	224	4	4	B434841 - B774251	V-BELT	—	18-15410	—
185		185	1970-73		4	4	2770032 - 3774864	V-BELT	18-15410	—	—
185		185	1974-81		4	4	3774865 - 5813433	V-BELT	18-15410	18-15370 (37" BELT)	—
185		185	1974-81		4	4	3774865 - 5813433	V-BELT	18-15410	18-15400 (40" BELT)	—
170	3.7L	165 / 170 / 180 / 190 / 3.7L	1985-89		4	4	6916779 - C762288	V-BELT	—	18-15410	—
170		170	1985-1998	224	4	4	6916778 - B438940	V-BELT	—	18-15410	—
170		470	1975-82		4	4	4208730 - 5218036	V-BELT	—	18-15405	—
170		470	1983-84		4	4	6218037 - 6916778	V-BELT	—	18-15410	—
		488	1983-84		4	4	6170297 - 6916778	V-BELT	—	18-15410	—
175		175	1987		4	4	C8527955-OB773242	V-BELT	—	18-15400	—
180		180	1987	224	4	4	B436391 - B775246	V-BELT	—	18-15410	—
185		185	1985-1998	224	4	4	691779 - B436390	V-BELT	—	18-15410	—
	3.7L	3.7L	1989-1989	224	4	4	B774252 - C762299	V-BELT	—	18-15410	—
	3.7L	3.7LX	1989-1998	224	4	4	B775240 - C762299	V-BELT	—	18-15410	—
		470	1983-1984	224	4	4	6218037 - 6916778	V-BELT	—	18-15410	—
		470 MIE	1983-1981	224	4	4	5520115 - 6218036	V-BELT	—	—	18-15345
		485	1980-1982	224	4	4	5885394 - 6218036	V-BELT	—	18-15410	—
		488	1983-1994	224	4	4	6170297 - 6916778	V-BELT	—	18-15410	—
		140	1963	194	6	4	1538930 - 1725980	V-BELT	18-15410	—	—
		150	1964-1996	230	6	4	1866495 - 2048046	V-BELT	18-15410	—	—
		160	1967-1969	250	6	4	2048022 - 2770031	V-BELT	18-15410	—	—
		165	1970-1973	250	6	4	2770032 - 3774864	V-BELT	18-15410	—	—
140		165	1974-1981	250	6	4	3774865 - 5813433	V-BELT	18-15410	18-15370 (37" BELT)	—
150		165	1974-1981	250	6	4	3774865 - 5813433	V-BELT	18-15410	18-15400 (40" BELT)	—
		200	1969	292	6	4	2453769 - Z712072	V-BELT	18-15410	—	—
		185 (abb)	1983-1984	229	6	4	6330183 - M6919655	V-BELT	—	18-15520	18-15345
		175	1987	262	6	4	B527955 - B773242	V-BELT	—	18-15520	18-15345
		185 (2bb)	1985-1986	262	6	4	A331455 - B527954	V-BELT	—	18-15520	18-15345
		205	1985-1987	262	6	4	A331455 - B775129	V-BELT	—	18-15520	18-15345
		205	1985-1991		6	4	A331455 - D714369	V-BELT	18-15440	18-15520	18-15345
		205	1987		6	4	B527955 - OB775129	V-BELT	—	18-15490	—
		4.3L (2bb)	1988-82	262	6	4	OB773243-OD714108	V-BELT	—	18-15490	—
		4.3L	1992-96	262	6	4	D714107 - F802999	V-BELT	18-15480	—	18-15290
		4.3L ALPHA FWC	1996-1999	262	6	4	F803000 - L618999	SERPENTINE	18-15116 (14, 21, 22)	—	—
		4.3L ALPHA FWC	1996-1999	262	6	4	F803000 - L518999	SERPENTINE	—	—	—
		4.3L	4.3L ALPHA FWC	1996-1999	262	6	F803000 - L518999	SERPENTINE	18-15116 (16, 21)	—	—
		4.3L	4.3L ALPHA FWC	1996-1999	262	6	F803000 - L518999	SERPENTINE	—	—	—
		4.3L	4.3L ALPHA FWC (19)	1996-1999	262	6	F803000 - L518999	SERPENTINE	18-15112 (19)	—	—
		4.3L	175 / 185 / 4.3L	1985-92	262	6	A331455 - D714108	V-BELT	18-15440	18-15520	18-15345
		4.3L	4.3L Gen II (2bb)	1992-96	262	6	OD714107-OF802999	V-BELT	—	18-15480	—
		4.3L	4.3LX (Hbb)	1989-92	262	6	OB775130-OD714369	V-BELT	—	18-15490	—

- (1) 1/2" wide (13mm) belt
- (2) 3/8" wide (10mm) belt
- (3) 28" wide (711mm) belt
- (4) 30" wide (762mm) belt
- (5) 37" wide (940mm) belt
- (6) 40" wide (1016mm) belt
- (7) 50" wide (1270mm) belt
- (8) 55" wide (1397mm) belt

- (9) Use with 5 1/2" (140mm) dia water pump pulley
- (10) Use with 5 7/8" (149mm) dia water pump pulley
- (11) Use with 7" (178mm) dia water pump pulley
- (12) Use with stamped steel sea water pump pulley
- (13) Use with cast aluminum sea water pump pulley
- (14) Use with plastic 4 3/4" (121mm) dia p/s pump pulley
- (15) Use with metal 5 3/4" (146mm) dia p/s pump pulley
- (16) For engine with high mounted p/s pump

- (17) For engines with low mounted p/s pump
- (18) For engine with power steering
- (19) For engines w/o power steering
- (20) For engines with cooled cooling
- (21) For engines with standard cooling
- (22) Replacement kit includes 5 3/4" (146mm) pulley and longer serpentine belt
- (23) For engines with high mounted alternator

V-BELT APPLICATION

HP	Ultr	Model	Years	CID	# Cyl	Stroke	Serial #	Belt Type	Alternator/ Water Pump	Power Steering	Sea Water Pump
	4.3L	4.3LX Gen II (Bob)	1992-99	262	6	4	0D714370-DF902999	V-BELT	—	18-15490	—
	4.3L	4.3L BRAVO RWC	1996-1999	262	6	4	F803000 - L818999	SERPENTINE	18-15115 (14, 21, 22)	—	—
	4.3L	4.3L BRAVO FWC	1996-1999	262	6	4	F803000 - L818999	SERPENTINE	18-15114 (14, 20, 22)	—	—
	4.3L	4.3L BRAVO RWC	1996-1999	262	6	4	F803000 - L818999	SERPENTINE	18-15115 (15, 21)	—	—
	4.3L	4.3L BRAVO FWC	1996-1999	262	6	4	F803000 - L818999	SERPENTINE	18-15114 (15, 20)	—	—
	4.3L	4.3L BRAVO RWC (19)	1996-1999	262	6	4	F803000 - L818999	SERPENTINE	18-15113 (19)	—	—
	5.0L	215	1970-1972	302	8	4	2781153 - 3563181	V-BELT	18-15460	—	—
	5.0L	215 MIE	1970-1972	302	8	4	2781153 - 3563181	V-BELT	18-15460	—	—
	5.0L	225 (FORD)	1973-74	302	8	4	3385721 - 4186999	V-BELT	18-15440	18-15320	18-15345
	5.0L	225 MIE (FORD)	1973-74	302	8	4	3385721 - 4166999	V-BELT	18-15440	—	—
	5.0L	888 (FORD)	1971-1977	302	8	4	3108723 - 4887829	V-BELT	18-15440 (28" BELT)	— (28" BELT)	—
	5.0L	888 (FORD)	1971-1977	302	8	4	3108723 - 4887829	V-BELT	18-15440 (30" BELT)	18-15290 (30" BELT)	18-15440
	5.0L	188 MIE	1977	305	8	4	4762210 - 6218461	V-BELT	18-15460	—	18-15345
	5.0L	200	1985-1987	305	8	4	6899058 - B774444	V-BELT	— (9)	18-15520 (9)	18-15345
	5.0L	200	1985-1987	305	8	4	6899058 - B774444	V-BELT	18-15460 (11)	18-15490 (11)	18-15345
	5.0L	200	1987		8	4	2453769 - 2712072	V-BELT	18-15410	—	—
	5.0L	200	1987		8	4	8529882-B774444	V-BELT	—	18-15490	—
		225 MCM / 225 MIE	1967-69		8	4	2278847 - 2694014	V-BELT	18-15460	—	—
	5.0L	228	1977-1982	305	8	4	4795100-8218461	V-BELT	18-15460 (17)	18-15325	18-15345
	5.0L	228	1977-1982	305	8	4	4795100-8218461	V-BELT	18-15440 (18)	18-15495	18-15345
	5.0L	228	1980-1984	305	8	4	6218462 - 6899298	V-BELT	— (9)	18-15520 (9)	18-15345
	5.0L	228	1983-1984	305	8	4	6218462 - 6899298	V-BELT	18-15460 (11)	18-15490 (11)	18-15345
	5.0L	228 MIE	1977	305	8	4	4795100 - 4929029	V-BELT	18-15460	—	18-15345
	5.0L	228 MIE	1978-1980	305	8	4	4929030 - 5907057	V-BELT	— (9)	—	18-15345 (12)
	5.0L	228 MIE	1978-1980	305	8	4	4929030 - 5907057	V-BELT	18-15460 (11)	—	18-15290 (13)
	5.0L	228 MIE	1977	305	8	4	4795100 - 4929030	V-BELT	18-15460	—	18-15325
	5.0L	228 / 230 / 5.0L	1983-95		8	4	8218462 - F600999	V-BELT	18-15440	18-15495	18-15345 (20)
	5.0L	228 / 230 / 5.0L	1983-95		8	4	8218462 - F600999	V-BELT	18-15460	18-15520	18-15290 (21)
	5.0L	228 / 230 / 5.0L MIE	1978-87		8	4	4929030 - B788151	V-BELT	18-15440	18-15495	18-15345 (12)
	5.0L	228 / 230 / 5.0L MIE	1978-87		8	4	4929030 - B788151	V-BELT	18-15460	18-15520	18-15290 (13)
	5.0L	230	1985-1987	305	8	4	6899269 - B773739	V-BELT	18-15500 (9)	18-15520 (9)	18-15345
	5.0L	230	1983-1984	305	8	4	6899269 - B773739	V-BELT	18-15460 (11)	18-15490 (11)	18-15345
	5.0L	230 MIE	1981-1987	305	8	4	5907058 - B788151	V-BELT	— (9)	—	18-15345 (12)
	5.0L	230 MIE	1981-1987	305	8	4	5907058 - B788151	V-BELT	18-15460 (11)	—	18-15290 (13)
		230	1987		8	4	8529882-B773739	V-BELT	—	18-15490	—
		233	1975-77		8	4	4173000 - 4923304	V-BELT	18-15440	—	—
		233	1975-77		8	4	4173000 - 4923304	V-BELT	18-15440	18-15290	18-15345 (12)
		233 MIE	1975-76		8	4	4173000 - 4775784	V-BELT	18-15440	—	—
	5.0L	5.0L	1988-1995	305	8	4	B774445 - F600999	V-BELT	— (9)	18-15500 (9)	18-15345 (12)
	5.0L	5.0L	1988-1995	305	8	4	B774445 - F600999	V-BELT	18-15460 (11)	18-15490 (11)	18-15290 (13)
	5.0L	5.0L ALPHA RWC	1998-1999	305	8	4	L012052 - L818999	SERPENTINE	18-15115 (1, 14, 21, 22)	—	—
	5.0L	5.0L ALPHA FWC	1998-1999	305	8	4	L012052 - L818999	SERPENTINE	18-15114 (14, 20, 22)	—	—
	5.0L	5.0L ALPHA RWC	1998-1999	305	8	4	L012052 - L818999	SERPENTINE	18-15116 (15, 21)	—	—
	5.0L	5.0L ALPHA FWC	1998-1999	305	8	4	L012052 - L818999	SERPENTINE	18-15114 (15, 20)	—	—
	5.0L	5.0L BRAVO RWC	1998-1999	305	6	4	L012052 - L818999	SERPENTINE	18-15115 (1, 14, 20, 22)	—	—
	5.0L	5.0L BRAVO FWC	1998-1999	305	6	4	L012052 - L818999	SERPENTINE	18-15114 (1, 14, 21, 22)	—	—
	5.0L	5.0L BRAVO RWC	1998-1999	305	6	4	L012052 - L818999	SERPENTINE	18-15115 (15, 21)	—	—
	5.0L	5.0L BRAVO FWC	1998-1999	305	6	4	L012052 - L818999	SERPENTINE	18-15114 (15, 20)	—	—
	5.0L	5.0L MIE	1988	305	8	4	B788152 - C396832	V-BELT	18-15460 (11)	—	57-13457Q (13)
	5.0L	5.0LX	1988	305	8	4	6218462 - F600999	V-BELT	— (8)	18-15520 (8)	57-74271Q (12)
	5.0L	5.0LX	1980-1985	305	8	4	6218462 - F600999	V-BELT	18-15460 (11)	18-15490 (11)	57-13457Q (13)
	5.0L	5.0L (2bb)	1988-95		8	4	B774445-F600999	V-BELT	—	18-15490	—
	5.0L	5.0LX (Abx)	1988-95		8	4	B773740-F600999	V-BELT	—	18-15490	—
	5.0L	898	1977-1984	305	8	4	4762210 - 6218461	V-BELT	18-15460 (17)	18-15325 (17)	18-15345
	5.0L	898	1977-1984	305	8	4	4762210 - 6218461	V-BELT	18-15460 (16)	18-15495	18-15345

- (1) 1/2" wide (13mm) belt
 (2) 3/8" wide (10mm) belt
 (3) 28" wide (711mm) belt
 (4) 30" wide (762mm) belt
 (5) 37" wide (940mm) belt
 (6) 40" wide (1016mm) belt
 (7) 50" wide (1270mm) belt
 (8) 55" wide (1397mm) belt

- (9) Use with 5 1/2" (140mm) dia water pump pulley
 (10) Use with 5 7/8" (149mm) dia water pump pulley
 (11) Use with 7" (178mm) dia water pump pulley
 (12) Use with stamped steel sea water pump pulley
 (13) Use with cast aluminum sea water pump pulley
 (14) Use with plastic 4 3/4" (121mm) dia p/s pump pulley
 (15) Use with metal 5 3/4" (146mm) dia p/s pump pulley
 (16) For engine with high mounted p/s pump

- (17) For engines with low mounted p/s pump
 (18) For engine with power steering
 (19) For engines w/o power steering
 (20) For engines with closed cooling
 (21) For engines with standard cooling
 (22) Replacement kit includes 5 3/4" (146mm) pulley and longer serpentine belt
 (23) For engines with high mounted alternator

V-BELT APPLICATION

HP	Liter	Model	Years	CID	# Cyl	Stroke	Serial #	Belt Type	Alternator/ Water Pump	Power Steering	Sea Water Pump
	5.0L	898	1983-1984	305	8	4	6218462 - 6899057	V-BELT	— (9)	18-15520 (9)	18-15345 (9)
	5.0L	898	1983-1984	305	8	4	6218462 - 6899057	V-BELT	18-15460 (11)	18-15490 (11)	18-15345
	5.0L	898 / 200 / 5.0L	1985-1995	305	8	4	6218462 - F600999	V-BELT	18-15440 (20)	18-15495	18-15345
	5.0L	898 / 200 / 5.0L	1995-1996	305	8	4	6218462 - F600999	V-BELT	18-15460 (21)	18-15520	18-15290
	5.7L	250 MCM / 250 MIE	1968-69	350	8	4	2314301 - 2639854	V-BELT	18-15460	—	—
	5.7L	250	1977	350	8	4	4768000 - 4908849	V-BELT	18-15440	18-15345	18-15345
	5.7L	255 MCM / 255 MIE	1973-74	350	8	4	3258726 - 4175499	V-BELT	18-15440	—	—
	5.7L	255 (GM)	1875-78	350	8	4	4175500 - 4498700	V-BELT	18-15460	18-15300	18-15345
	5.7L	255 (GM)	1976	350	8	4	4499701-4499050	V-BELT	18-15460	—	18-15345
	5.7L	255 (GM)	1976	350	8	4	4499061-4797989	V-BELT	18-15460	—	18-15345
	5.7L	255 MIE (GM)	1975-77	350	8	4	4175500 - 4498700	V-BELT	18-15460	—	18-15345
	5.7L	255 MIE (GM)	1977-78	350	8	4	4499701 - 4924564	V-BELT	18-15460	—	18-15345
	5.7L	255 MIE (GM)	1978-1980	350	8	4	4924565 - 5907057	V-BELT	—	—	18-15345
	5.7L	260 MIE	1978-80	350	8	4	4924565 - B822506	V-BELT	18-15440	—	18-15345
	5.7L	260 / 5.7L MIE / 5.7L Ski	1987-93	350	8	4	B822506 - F024999	V-BELT	18-15440	—	18-15345 (12)
	5.7L	260 / 5.7L MIE / 5.7L Ski	1987-93	350	8	4	B822506 - F024999	V-BELT	18-15460	—	18-15290 (13)
	5.7L	260	1978-1982	350	8	4	4908850 - 6218461	V-BELT	18-15440 (16)	18-15495 (17)	18-15345
	5.7L	260	1978-1982	350	8	4	4908850 - 6218461	V-BELT	18-15460 (17)	—	18-15345
	5.7L	260	1987	350	8	4	B825982-B773304	V-BELT	—	18-15490	—
	5.7L	260	1983-1987	350	8	4	6218462 - B7733304	V-BELT	18-15460 (11)	18-15490 (11)	18-15290 (13)
	5.7L	260 MIE	1987	350	8	4	B822506 - B769151	V-BELT	18-15460 (11)	—	18-15290 (13)
	5.7L	260 / 5.7L	1983-1995	350	8	4	6218462 - F600999	V-BELT	18-15440	18-15495	18-15345 (20)
	5.7L	280 / 5.7L	1983-1995	350	8	4	6218462 - F600999	V-BELT	18-15460	18-15520	18-15290 (21)
	5.7L	276 MCM / 276 MIE	1969-1972	350	8	4	3851074 - 3885720	V-BELT	18-15460	—	—
	5.7L	280 TRS	1975	350	8	4	4176250 - 4176468	V-BELT	18-15460	—	—
	5.7L	280 TRS	1975	350	8	4	4176250 - 4176468	V-BELT	18-15460	18-15300	—
	5.7L	280 TRS	1975-78	350	8	4	4176469 - 4496090	V-BELT	18-15460	18-15300	—
	5.7L	280 TRS	1976	350	8	4	4499391 - 4499780	V-BELT	18-15460	—	—
	5.7L	280 TRS	1976	350	8	4	4499781 - 4770199	V-BELT	18-15460	18-15325	—
		320 EFI	1987-88	350	8	4	AS43804 - CR22418	V-BELT	18-15440	18-15520	—
		330	1977-81	350	8	4	4623115-6083144	—	18-15470	—	18-15345
		330	1982-87	350	8	4	6083144 - B818540	—	18-15470	18-15500	18-15345 (12)
		330	1982-87	350	8	4	6083144 - B818540	—	18-15470	18-15550	18-15290 (13)
	5.7L	350 MAG ALPHA	1966-1995	350	8	4	A635178 - F600999	V-BELT	18-15440 (9)	18-15520 (9)	18-15345 (20)
	5.7L	350 MAG ALPHA	1966-1995	350	8	4	A635178 - F600999	V-BELT	18-15460 (11)	18-15490 (11)	18-15290 (21)
	5.7L	350 MAG ALPHA	1996	350	8	4	F801000 - K001500	V-BELT	18-15460	18-15490	18-15290
	5.7L	350 Mag Alpha	1987-1995	350	8	4	B825982 - F600999	V-BELT	—	18-15490	—
	5.7L	350 Mag Alpha (4bb)	1996	350	8	4	F801000 - K001528	V-BELT	—	18-15490	—
	5.7L	350 Mag Alpha EFI /									
		350 Mag ALPHA Gen+	1996	350	8	4	F800300 - K001508	V-BELT	—	18-15490	—
	5.7L	350 Mag Bravo MPI	1995	350	8	4	F415189 - F601999	V-BELT	—	18-15490	—
	5.7L	350 Mag Bravo MPI /									
		350 Mag Bravo MPI Gen+	1996	350	8	4	F602000 - K001500	V-BELT	—	18-15490	—
	5.7L	350 MAG Ski	1991-98	350	8	4	D805450 - K040005	V-BELT	18-15460	—	18-15290
	5.7L	350 MAG ALPHA RWC	1997-1999	350	8	4	K001501 - L619999	SERPENTINE	18-15116 (14, 21, 22)	—	—
	5.7L	350 MAG ALPHA FWC	1997-1999	350	8	4	K001501 - L619999	SERPENTINE	18-15114 (14, 20, 22)	—	—
	5.7L	350 MAG ALPHA RWC	1997-1999	350	8	4	K001501 - L619999	SERPENTINE	18-15116 (15, 20)	—	—
	5.7L	350 MAG ALPHA FWC	1997-1999	350	8	4	K001501 - L619999	SERPENTINE	18-15114 (15, 21)	—	—
	5.7L	350 MAG BRAVO RWC	1997-1999	350	8	4	K001501 - L619999	SERPENTINE	18-15115 (14, 21, 22)	—	—
	5.7L	350 MAG BRAVO FWC	1997-1999	350	8	4	K001501 - L619999	SERPENTINE	18-15114 (14, 20, 22)	—	—
	5.7L	350 MAG BRAVO RWC	1997-1999	350	8	4	K001501 - L619999	SERPENTINE	18-15115 (15, 21)	—	—
	5.7L	350 MAG BRAVO FWC	1997-1999	350	8	4	K001501 - L619999	SERPENTINE	18-15114 (15, 20)	—	—
	5.7L	350 MIE	1974-75	350	8	4	3780450-4501840	—	18-15480	—	—
	5.7L	350 MIE	1976	350	8	4	4501641 - 4623109	—	18-15480	—	18-15345
	5.7L	350 MAG MPI / 350 MAG Ski	1995-1996	350	8	4	F360583 - F799999	V-BELT	18-15460	—	18-15290

- (1) 1/2" wide (13mm) belt
- (2) 3/8" wide (10mm) belt
- (3) 28" wide (711mm) belt
- (4) 30" wide (762mm) belt
- (5) 37" wide (940mm) belt
- (6) 40" wide (1016mm) belt
- (7) 50" wide (1270mm) belt
- (8) 55" wide (1397mm) belt

- (9) Use with 5 1/2" (140mm) dia water pump pulley
- (10) Use with 5 7/8" (149mm) dia water pump pulley
- (11) Use with 7" (178mm) dia water pump pulley
- (12) Use with stamped steel sea water pump pulley
- (13) Use with cast aluminum sea water pump pulley
- (14) Use with plastic 4 3/4" (121mm) dia p/s pump pulley
- (15) Use with metal 5 3/4" (146mm) dia p/s pump pulley
- (16) For engine with high mounted p/s pump

- (17) For engines with low mounted p/s pump
- (18) For engine with power steering
- (19) For engines w/o power steering
- (20) For engines with closed cooling
- (21) For engines with standard cooling
- (22) Replacement kit includes 5 3/4" (146mm) pulley and longer serpentine belt
- (23) For engines with high mounted alternator



V-BELT APPLICATION

HP	liter	Model	Years	CID	# Cyl	Stroke	Serial #	Belt Type	Alternator/ Water Pump	Power Steering	Sea Water Pump
	5.7L	350 MAG SKI	1991-1996	350	8	4	D805450 - K040005	V-BELT	18-15460	—	18-15290 (12)
	5.7L	5.7L	1988-1995	350	8	4	B773305 - F609999	V-BELT	— (9)	18-15520 (8)	18-15345
	5.7L	5.7L	1988-1995	350	8	4	B773305 - F609999	V-BELT	18-15460 (11)	18-15490 (11)	18-15290
	5.7L	5.7L	1996	350	8	4	F601000 - K001505	V-BELT	18-15460	18-15490	18-15290
	5.7L	5.7L ALPHA FWC	1997-1999	350	8	4	K001506 - L618999	SERPENTINE	18-15116 (14, 21, 22)	—	—
	5.7L	5.7L ALPHA FWC	1997-1999	350	8	4	K001506 - L618999	SERPENTINE	18-15114 (14, 20, 22)	—	—
	5.7L	5.7L ALPHA FWC	1997-1999	350	8	4	K001506 - L618999	SERPENTINE	18-15116 (15, 21)	—	—
	5.7L	5.7L ALPHA FWC	1997-1999	350	8	4	K001506 - L618999	SERPENTINE	18-15114 (16, 20)	—	—
	5.7L	5.7L BRAVO FWC	1997-1999	350	8	4	K001506 - L618999	SERPENTINE	18-15114 (14, 20, 22)	—	—
	5.7L	5.7L BRAVO FWC	1997-1999	350	8	4	K001506 - L618999	SERPENTINE	18-15115 (15, 21)	—	—
	5.7L	5.7L BRAVO FWC	1997-1999	350	8	4	K001506 - L618999	SERPENTINE	18-15114 (16, 20)	—	—
	5.7L	5.7L MIE	1988-1993	350	8	4	B522506 - F024999	V-BELT	—	—	18-15345
	5.7L	5.7L MIE	1988-1993	350	8	4	B522506 - F024999	V-BELT	—	—	18-15290
	5.7L	5.7L MIE	1994-1996	350	8	4	F025000 - K040096	V-BELT	18-15460	—	18-15290
	5.7L	5.7L SKI	1985-1987	350	8	4	A338553 - B518626	V-BELT	—	—	18-15290 (13)
	5.7L	5.7L SKI	1987-1995	350	8	4	B514827 - F775199	V-BELT	—	—	18-15345
	5.7L	5.7L SKI	1987-1995	350	8	4	B514827 - F775199	V-BELT	—	—	18-15290
	5.7L	5.7L SKI	1996	350	8	4	F775200 - K040003	V-BELT	18-15460	—	18-15290
	5.7L	5.7LX	1996	350	8	4	F601000 - K001505	V-BELT	18-15460	18-15490	18-15290
	5.7L	5.7L BRAVO EFI	1996	350	8	4	F800300 - K001505	V-BELT	18-15460	18-15490	18-15290
	5.7L	5.7LX BRAVO	1996	350	8	4	F801000 - K001505	V-BELT	18-15460	18-15490	18-15290
	5.7L	BLACK SCORPION SKI	1996	350	8	4	F800000 - K040006	V-BELT	18-15460	—	18-15290
	5.7L	5.7L MIE / 5.7L Ski	1994-96	350	8	4	F025000 - K040305	—	18-15460	—	—
	5.7L	5.7L	1988-95	350	8	4	B525982 - F609999	—	—	18-15490	—
	5.7L	5.7L (2bbb)	1996	350	8	4	F601000 - K001526	—	—	18-15490	—
	5.7L	5.7L EFI (2bbb)	1996	350	8	4	F752400 - K001505	—	—	18-15490	—
	5.7L	5.7L Alpha EFI / 5.7L ALPHA TBI	1995	350	8	4	F255305 - F752389	—	—	18-15490	—
	5.7L	5.7L Alpha EFI / 5.7L ALPHA TBI	1995	350	8	4	F225560 - F752399	—	—	18-15490	— (13)
	5.7L	5.7LX EFI / 5.7LX TBI (4bbb)	1996	350	8	4	F752400 - K001505	—	—	18-15490	— (12)
	5.7L	233	1975-1977	351	8	4	4173000 - 4902304	V-BELT	—	18-15290 (30" BELT)	18-15345
	6.2L	377 SCORPION MCM	1990-2005	377	8	4	L418146 - M907201	SERPENTINE	18-15115	—	—
	7.4L	325 MCM / 325 MIE	1968-1974	427	8	4	2278747 - 3780449	V-BELT	18-15480	—	—
	7.4L	330	1977-1981	454	8	4	4623115 - 6083144	V-BELT	18-15470	—	18-15345
	7.4L	330	1982-1987	454	8	4	6083145 - 8818540	V-BELT	18-15470	18-15500 (50" BELT)	18-15345 (12)
	7.4L	330	1982-1987	454	8	4	6083145 - 8818540	V-BELT	18-15470	18-15500 (55" BELT)	18-15290 (13)
	7.4L	330 MIE	1977-1980	454	8	4	4623115 - 5889913	V-BELT	18-15470	—	18-15345
	7.4L	340 MIE	1981-1987	454	8	4	5889914 - 8788385	V-BELT	18-15470	—	18-15345 (12)
	7.4L	340 MIE	1981-1987	454	8	4	5889914 - 8788385	V-BELT	18-15470	—	18-15290 (13)
	7.4L	340	1981-92	454	8	4	5889914 - 0715493	V-BELT	18-15470	—	18-15345 (12)
	7.4L	340	1981-92	454	8	4	5889914 - 0715493	V-BELT	18-15470	—	18-15290 (13)
	7.4L	350 MIE	1974-1975	454	8	4	3780450 - 4501640	V-BELT	18-15480	—	—
	7.4L	350 MIE	1976	454	8	4	4501641 - 4623109	V-BELT	18-15480	—	18-15345
	7.4L	370 TRS	1978-1985	454	8	4	4179554 - 6721527	V-BELT	18-15480	—	—
	7.4L	370 TRS	1985-1987	454	8	4	6721528 - 8714586	V-BELT	18-15480	18-15500	18-15345
	7.4L	400 TRS	1986-1986	454	8	4	4179554 - 8457644	V-BELT	18-15480	—	—
	7.4L	420	1987-1988	454	8	4	A339941 - B622418	V-BELT	—	18-15500	18-15345
	7.4L	425	1990-1992	454	8	4	B622419 - 0725499	V-BELT	—	18-15500	18-15345
	7.4L	425	1992	454	8	4	D725500 - 0937011	V-BELT	—	—	18-15400
	7.4L	440 TRS	1983-1986	454	8	4	4179554 - 8485220	V-BELT	18-15480	—	—
	7.4L	450	1995-1996	454	8	4	F347100 - F347277	V-BELT	—	—	18-15400
	7.4L	454 MAG ALPHA	1989-1988	454	8	4	A631894 - 8785148	V-BELT	18-15470	18-15500 (50" BELT)	—
	7.4L	454 MAG ALPHA	1989-1988	454	8	4	A631894 - 8785148	V-BELT	18-15470	18-15500 (55" BELT)	—
	7.4L	454 MAG	1988-92	454	8	4	8721206 - 0805088	—	18-15470	18-16550	18-15290
	7.4L	454 MAG	1988-92	454	8	4	8721206 - 0805088	—	18-15480	—	18-15290
	7.4L	454 MAG	1982-97	454	8	4	D805089 - K999999	—	18-15460	—	18-15400

- (1) 1/2" wide (13mm) belt
 (2) 3/8" wide (10mm) belt
 (3) 28" wide (711mm) belt
 (4) 30" wide (762mm) belt
 (5) 37" wide (940mm) belt
 (6) 40" wide (1016mm) belt
 (7) 50" wide (1270mm) belt
 (8) 55" wide (1397mm) belt

- (9) Use with 5 1/2" (140mm) dia water pump pulley
 (10) Use with 5 7/8" (149mm) dia water pump pulley
 (11) Use with 7" (178mm) dia water pump pulley
 (12) Use with stamped steel sea water pump pulley
 (13) Use with cast aluminum sea water pump pulley
 (14) Use with plastic 4 3/4" (121mm) dia p/s pump pulley
 (15) Use with metal 5 3/4" (146mm) dia p/s pump pulley
 (16) For engine with high mounted p/s pump

- (17) For engines with low mounted p/s pump
 (18) For engine with power steering
 (19) For engines w/o power steering
 (20) For engines with closed cooling
 (21) For engines with standard cooling
 (22) Replacement kit includes 5 3/4" (146mm) pulley and longer serpentine belt
 (23) For engines with high mounted alternator

V-BELT APPLICATION

HP	Liter	Model	Years	CID	# Cyl	Stroke	Serial #	Belt Type	Alternator/ Water Pump	Power Steering	Sea Water Pump
7.4L	454	MAG MPI	1994-97	454	6	4	F115700 - K147349		18-15480	—	18-15400
7.4L	454	MAG MPI	1997	454	6	4	K147350 - K999999		18-15480	—	18-15290
7.4L	454	MAG Ski	1995-97	454	6	4	F215800 - K999999		18-15460	—	18-15400
7.4L	454	MAG BRAVO	1989-1992	454	6	4	B721206 - D805068	V-BELT	18-15470 (9)	18-15550 (9)	18-15290
7.4L	454	MAG BRAVO	1989-1992	454	6	4	B721206 - D805068	V-BELT	18-15480 (11)	— (11)	18-15290
7.4L	454	MAG BRAVO	1992-1997	454	6	4	D805069 - K999999	V-BELT	18-15480	—	18-15400
7.4L	454	MAG EFI	1994-1996	464	6	4	F115700 - F802349	V-BELT	18-15480	—	18-15400
7.4L	454	MAG EFI SKI	1995-1996	454	6	4	F215800 - F820099	V-BELT	18-15480	—	18-15400
7.4L	454	MAG MPI	1996-1997	454	6	4	F115700 - F147349	V-BELT	18-15480	—	18-15400
7.4L	454	MAG MPI	1997	454	6	4	K147350 - K999999	V-BELT	18-15480	—	18-15290
7.4L	525	SC	1991-1999	454	6	4	D456000 - L415623	V-BELT	—	18-15500	18-15400
7.4L	7.4L	BRAVO	1989-1991	454	6	4	B771119 - D603117	V-BELT	18-15470	18-15550 (8)	18-15290
7.4L	7.4L	BRAVO	1989-1991	454	6	4	B771119 - D603117	V-BELT	18-15480	— (11)	18-15290
7.4L	7.4L	BRAVO	1992-1997	454	6	4	D603119 - K999999	V-BELT	18-15480	—	18-15400
7.4L	7.4L	MIE (WITH BW)	1989-1992	454	6	4	B788366 - D715493	V-BELT	18-15470	—	18-15290
7.4L	7.4L	MIE (WITH BW)	1989-1992	454	6	4	B788366 - D715493	V-BELT	18-15470	—	18-15400
7.4L	7.4L	MIE (WITH HURTH)	1989-1992	454	6	4	C391564 - D715493	V-BELT	18-15470 (10)	—	18-15290 (12)
7.4L	7.4L	MIE (WITH HURTH)	1989-1992	454	6	4	C391564 - D715493	V-BELT	18-15480 (11)	—	18-15290 (13)
7.4L	7.4L	MIE	1992-1997	454	6	4	D715494 - K999999	V-BELT	18-15480	—	18-15400
7.4L	7.4L	MPI	1998-2001	454	6	4	L010003 - M024330	SERPENTINE	18-15114 (14, 22)	—	—
7.4L	7.4L	MPI	1999-2001	454	6	4	L010003 - M024330	SERPENTINE	18-15114 (14)	—	—
7.4L	7.4L	MPI / 7.4L MIE	1996-1998	454	6	4	F963052 - F820131	V-BELT	18-15480	—	18-15400
7.4L	7.4L	MPI / 7.4L MIE	1996-1997	454	6	4	F820132 - K999999	V-BELT	18-15480	—	18-15290
7.4L	7.4LX	BRAVO EFI	1996-1997	454	6	4	F820000 - K999999	V-BELT	18-15480	—	18-15290
7.4L	7.4LX	BRAVO MPI	1996-1997	454	6	4	F602010 - K147349	V-BELT	18-15480	—	18-15400
7.4L	7.4LX	BRAVO MPI	1997	454	6	4	K147350 - K999999	V-BELT	18-15480	—	18-13290
7.4L	7.4LX	Bravo MPI	1996-97	454	6	4	F602010 - K147349		18-15480	—	18-15400
7.4L	7.4L	MIE	1992-97	454	6	4	C391564 - K999999		18-15480	—	18-15400
7.4L	370	TRS	1978-85		6	4	4179554 - 6721527		18-15480	—	—
7.4L	370	TRS	1985-87		6	4	6721528 - 5714586		18-15480	18-15500	—
	390	MCM / 390 MIE	1969-1970	482	6	4	Z781129 - 3042731	V-BELT	18-15480	—	—
	400	TRS	1963-1966	482	6	4	4179554 - 6181046	V-BELT	18-15480	—	—
	420/425		1967-1992		6	4	A399941 - D725499		18-15480	18-15500	—
	420 / 425		1992		6	4	D725500 - D937011		18-15480	—	18-15400
	440	TRS	1963-1966		6	4	4179554 - 5485220		18-15480	—	—
	450		1965-1966		6	4	F347100 - F347227		18-15480	—	18-15400
	460	TRS	1983-1986		6	4	4179554 - 6181046		18-15480	—	—
	465		1980-1992	502	6	4	C848992 - D725646	V-BELT	—	—	18-15290
	8.2L	465	1992-1994	502	6	4	D725647 - F213244	V-BELT	—	—	18-15400
	8.2L	500	1994-1998	502	6	4	F213293 - L001732	V-BELT	—	—	18-15400
	8.2L	500 GEN +	1999	502	6	4	L414639 - L601036	V-BELT	—	—	18-15400
	8.2L	502	MAG BRAVO	1990-1997	502	6	C878221 - D824588	V-BELT	18-15480	—	18-15290
	8.2L	502	MAG BRAVO	1990-1997	502	6	C824589 - K999999	V-BELT	18-15480	—	18-15400
	8.2L	502	MAG EFI	1994-1995	502	6	D840650 - F802599	V-BELT	18-15480	—	18-15400
	8.2L	502	MAG MPI	1996-1997	502	6	F802600 - K147349	V-BELT	18-15480	—	18-15400
	8.2L	502	MAG MPI	1997	502	6	K147350 - K999999	V-BELT	18-15480	—	18-15290
	8.2L	502	MAG MPI	1999-2001	502	6	L017000 - M024999	SERPENTINE	18-15114 (14, 22)	—	—
	8.2L	502	MAG MPI	1998-2001	502	6	L017000 - M024999	SERPENTINE	18-15114 (14)	—	—
	8.2L	600	SC	1991-1992	502	6	D456489 - D456786	V-BELT	—	18-15500	18-15345
	8.2L	600	SC	1992-2000	502	6	D725878 - L901166	V-BELT	—	18-15500	18-15400
	8.2L	8.2L	MIE	1990-1993	502	6	C878221 - D857198	V-BELT	18-15480	—	18-15290
	8.2L	8.2L	MIE	1993-1997	502	6	D857200 - K999999	V-BELT	18-15480	—	18-15400
	8.2L	8.2L	MPI MIE	1996-1997	502	6	F819629 - K147349	V-BELT	18-15480	—	18-15400
	8.2L	8.2L	MPI MIE	1997	502	6	K147350 - K999999	V-BELT	18-15480	—	18-15290
	8.2L	500	BULLDOG	1990-2001	540	6	C577254 - M050281	V-BELT	— (3/8" BELT WIDTH)	—	18-15345
	8.2L	500	BULLDOG	1990-2001	540	6	C577254 - M050281	V-BELT	— (1/2" BELT WIDTH)	—	18-15345

- (1) 1/2" wide (13mm) belt
- (2) 3/8" wide (10mm) belt
- (3) 28" wide (711mm) belt
- (4) 30" wide (762mm) belt
- (5) 37" wide (940mm) belt
- (6) 40" wide (1016mm) belt

- (7) 50" wide (1270mm) belt
- (8) 55" wide (1397mm) belt
- (9) Use with 5 1/2" (140mm) dia water pump pulley
- (10) Use with 5 7/8" (149mm) dia water pump pulley
- (11) Use with 7" (178mm) dia water pump pulley
- (12) Use with stamped steel sea water pump pulley

- (13) Use with cast aluminum sea water pump pulley
- (14) Use with plastic 4 3/4" (121mm) dia p/s pump pulley
- (15) Use with metal 5 3/4" (146mm) dia p/s pump pulley
- (16) For engine with high mounted p/s pump
- (17) For engine with low mounted p/s pump
- (18) For engine with power steering

- (19) For engines w/o power steering
- (20) For engines with closed cooling
- (21) For engines with standard cooling
- (22) Replacement kit includes 5 3/4" (146mm) pulley and longer serpentine belt
- (23) For engines with high mounted alternator

SERPENTINE BELTS



BELT INTERCHANGE

Part No.	OE #	Width	Length (in.)
18-15100	57-8638763, 57-862807, 57-862087A1, 57-865615003, 57-865615Q03	13/16	106.25
18-15101	57-8638764, 57-862086, 57-862086A1, 57-865615004, 57-865615Q04	13/16	76.5
18-15102	57-8638766, 57-8610491, 57-865615006, 57-865615Q06	13/16	105
18-15103	57-8638767, 57-865615007, 57-861050, 57-865615Q07	13/16	96.75
18-15104	57-8638768, 57-862089, 57-862089A1, 57-865615008, 57-865615Q08	13/16	99.5
18-15112	57-8077554, 57-807755Q04	13/16	88
18-15113	57-8077555	13/16	75.75

Part No.	OE #	Width	Length (in.)
18-15114	57-861049, 57-861049Q	13/16	104.25
18-15115	57-861757, 57-861757Q	13/16	97.5
18-15116	57-861758, 57-861758Q	13/16	86.75
18-15119	57-8638761, 57-8623523, 57-865615001, 57-865615Q01	13/16	111.25
18-15121	57-865615005, 57-865615Q05, 57-8638765, 57-865423005	13/16	87.5
18-15123	57-864639	13/16	85

BELT APPLICATION

Engine	Years	Serial #	Part #	Mercruiser #	Foothole	Engine	Years	Serial #	Part #	Mercruiser #	Foothole
4.3L Alpha	1996-99	DF803000-OL618998	18-15116	57-861758	2, 6	5.7L Bravo	1997-99	OK001508-OL618999	18-15115	57-861757	2, 6
4.3L Alpha	2000-04	OL619000 & up	18-15101	57-863876 4	3, 6, 7	5.7L Bravo	2002-04	OM600000 & up	18-15102	57-863876 6	3, 5, 7
4.3L Alpha	2000-04	OL619000 & up	18-15104	57-863876 8	4, 5, 7	5.7L Bravo	2000-04	OL619000 & up	18-15104	57-863876 8	4, 7
4.3L Bravo	1996-99	DF803000-OL618999	18-15114	57-861049	2, 5	5.7L Ski	1997-02	OK040004-OM316999	18-15112	57-8077554	
4.3L Bravo	1996-99	DF803000-OL618998	18-15115	57-861757	2, 6	5.7L Ski	2002-05	OM317000 & up	18-15121	57-865615005	
4.3L Bravo	2000-04	OL619000 & up	18-15104	57-863876 8	4, 7	5.7L MIE	2001-05	OL677227 & up	18-15121	57-865615005	
5.0L Bravo	2002-04	OM600000 & up	18-15102	57-863876 6	3, 5, 7	377 Scorpion MCM	1999-04	OL416146 & up	18-15115	57-861757	
5.0L Alpha	1998-99	OL012052-OL618999	18-15114	57-861049	5	377 Scorpion Ski	1997-98	OK000656 & up	18-15112	57-8077554	
5.0L Alpha	1998-99	OL012052-OL618999	18-15116	57-861758	2, 6	454 Mag MPI	1998-01	OL010029-OM024999	18-15114	57-861049	1
5.0L Alpha	2000-04	OL619000 & up	18-15101	57-863876 4	3, 6, 7	454 Mag MPI	1998-01	OL010029-OM024999	18-15102	57-863876 6	2
5.0L Alpha	2002-04	OM600000 & up	18-15102	57-863876 6	3, 5, 7	454 Mag MPI	1998-01	OL010029-OM024999	18-15103	57-865615007	4
5.0L Alpha	2001-04	OL619000 & up	18-15104	57-863876 8	4, 5, 7	454 Mag MPI Horizon MIE	1998-01	OL002200-OL674000	18-15103	57-865615007	
5.0L Bravo	1998-99	OL012052-OL618999	18-15114	57-861049	2, 5	496 Mag & HO	2000-04	OM025000 & up	18-15119	57-863876 1	
5.0L Bravo	1998-99	OL012052-OL618999	18-15115	57-861757	2, 6	500 EFI	1999-04	OL001477 & up	18-15112	57-8077554	
5.0L Bravo	2000-04	OL619000 & up	18-15104	57-863876 8	4, 7	502 Mag MPI	1998-01	OL017000-OM024999	18-15114	57-861049	1
350 Mag, Alpha	1997-04	OK001501-OL618999	18-15114	57-861049	2, 5	502 Mag MPI	1998-01	OL017000-OM024999	18-15103	57-865615007	4
350 Mag, Alpha	1997-04	OK001501-OL618999	18-15116	57-861758	2, 6	502 Mag, MPI	1998-01	OL017000-OM024999	18-15102	57-863876 6	2
350 Mag, Alpha	2000-04	OL619000 & up	18-15103	57-865615007	3, 6, 7	575 Sci	2000-05	OL356696 & up	18-15112	57-8077554	9
350 Mag, Alpha	2002-04	OM600000 & up	18-15102	57-863876 6	3, 5, 7	7.4L MPI	1998-01	OL010003-OM024330	18-15114	57-861049	1
350 Mag, Alpha	2000-04	OL619000 & up	18-15104	57-863876 8	4, 5, 7	7.4L MPI	1998-01	OL010003-OM024330	18-15102	57-863876 6	2
350 Mag, Bravo	1997-04	OK001501-OL618999	18-15114	57-861049	2, 5	7.4L MPI	1998-01	OL010003-OM024330	18-15103	57-865615007	4
350 Mag, Bravo	1997-04	OK001501-OL618999	18-15115	57-861757	2, 6	7.4L MPI MIE	1998-01	OL002056-OM025999	18-15103	57-865615007	
350 Mag, Bravo	2002-04	OM600000 & up	18-15102	57-863876 6	3, 5, 7	Black Scorpion Ski	1997-01	OK040001-OM391599	18-15112	57-8077554	
350 Mag, Bravo	2000-04	OL619000 & up	18-15104	57-863876 8	4, 7	Black Scorpion Ski	2003-05	OM391600 & up	18-15121	57-865615005	
350 Mag MPI MIE	2001-05	OL673999 & up	18-15121	57-865615005	6	MX 6.2L Bk Scorpion Ski	2001	OL670015-OM391599	18-15112	57-8077554	
350 Mag MPI Ski	2001-05	OM300000 & up	18-15121	57-865615005		MX 6.2L MPI	2002-04	OM600000 & up	18-15102	57-863876 6	3, 5
350 Mag MPI Horizon MIE	2001-02	OL678399-OM316999	18-15121	57-865615005		MX 6.2L MPI	2000-04	OL680003 & up	18-15104	57-863876 8	4, 7
5.7L Alpha	1997-99	OK001501-OL618999	18-15114	57-861049	2, 5	MX 6.2L MPI Horizon	2002-04	OM600000 & up	18-15102	57-863876 6	3
5.7L Alpha	1997-99	OK001508-OL618999	18-15116	57-861758	2, 6	MX 6.2L MPI Horizon	2001-04	OM300000 & up	18-15104	57-863876 8	4
5.7L Alpha	2000-04	OL619000 & up	18-15101	57-863876 4	3, 6, 7	MX 6.2L MPI Horizon MIE	2001	OM300000-OM310099	18-15112	57-8077554	
5.7L Alpha	2002-04	OM600000 & up	18-15102	57-863876 6	3, 5, 7	MX 6.2L MPI Horizon MIE	2001-05	OM310100 & up	18-15121	57-865615005	6
5.7L Alpha	2000-04	OL619000 & up	18-15104	57-863876 8	4, 5, 7	MX 6.2L MPI MIE	1999-01	OL670000-OM310099	18-15112	57-8077554	
5.7L Bravo	1997-99	OK001508-OL618999	18-15114	57-861049	2, 5	MX 6.2L MPI MIE	2001-05	OM310100 & up	18-15121	57-865615005	6

Footnotes

- 1: Use with plastic 4-3/4" dia. p/s pump pulley
- 2: Use with metal 5-3/4" dia. p/s pump pulley
- 3: For engines with power steering

- 4: For engines without power steering
- 5: For engines with closed cooling
- 6: For engines with standard cooling

- 7: Engines with high mounted alternators
- 8: Blower
- 9: Alternator

BELT APPLICATION

Engine	Years	Serial #	Part #	Mercruiser #	Footnote
MX 6.2L MPI S/c	:2002-05	DM317000 & up	18-15121	57-865615005	
8.2L MPI ME	1998-01	DL002450-OL674200	18-15103	57-865615007	

Footnotes

- 1: Use with plastic 4-3/4" dia. p/s pump pulley
- 2: Use with metal 5-3/4" dia. p/s pump pulley
- 3: For engines with power steering
- 4: For engines without power steering

- 5: For engines with closed cooling
- 6: For engines with standard cooling
- 7: Engines with high mounted alternators
- 8: Blower
- 9: Alternator

Fits GM Big Block V8 454 cu. in. Models 330, 340 & 7.4L

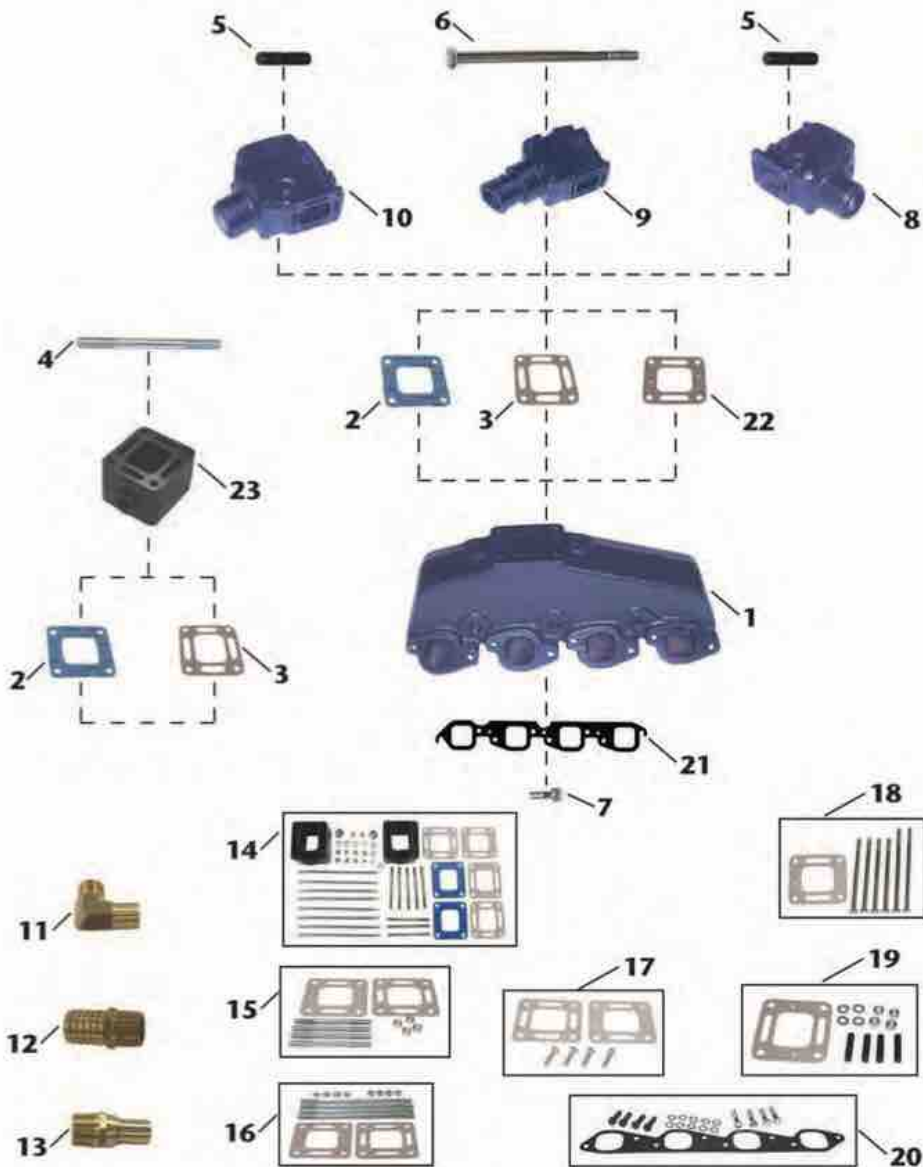

SEE NEXT PAGE FOR CHART

Item No.	Description	OE No.	Application	
1	18-1957-2	MANIFOLD	807078T08, 807078Q07	GM Big Block (VB) 454 cu.in. Models 330, 340 & 7.4L. Use with 18-0418 manifold gasket; Mounting Kit: 18-8532
2	18-0672 (blocked)	ELBOW GASKET (Blocked)	27-860231	Fits Manifold: 18-1957-2; Elbows: 18-1970-2, & 18-1976-2, 18-1974; Spacer 18-1908
3	18-2849-1	ELBOW GASKET (Open)	27-818832	Fits Manifold: 18-1957-2; Elbows: 18-1970-2, & 18-1976-2, 18-1974; Spacer 18-1908
4	NSS	MOUNTING STUD	N/A	Included in 18-8554 mounting kit
5	NSS	MOUNTING STUD	N/A	Included in 18-8529 mounting kit
6	NSS	MOUNTING BOLT	N/A	Included in 18-8505 mounting kit
7	NSS	MOUNTING BOLT	N/A	Included in 18-8532 mounting kit
8	18-1974-1	MANIFOLD ELBOW (3" hose • 15° down angle)	98502A2	Fits Manifold: 18-1957-2. Use Elbow gaskets: 18-2849-1, 18-0897, or 18-0672; Use mounting kit: 18-8529 (Do not use with spacer)
9	18-1976-2	MANIFOLD ELBOW (4" hose • 7° down angle)	44354A3	Fits Manifold: 18-1957-2. Use Elbow gaskets: 18-2849-1, 18-0897, or 18-0672; Use mounting kit: 18-8505, or if spacer is included use 18-8555
10	18-1970-2	MANIFOLD ELBOW (3" hose)	98504A3	Fits Manifold: 18-1957-2. Use Elbow gaskets: 18-2849-1, 18-0897, or 18-0672; Use mounting kit: 18-8529, or if spacer is included use 18-8554
11	18-8216	HOSE FITTING	N/A	3/4" - 14NPT X 1" Hose (Corrosion Resistant Brass Fitting)
12	18-4461	HOSE FITTING	N/A	3/4" - 14NPT X 1" Hose (Corrosion Resistant Brass Fitting)
13	18-8215	HOSE FITTING	N/A	3/4" - 14NPT X 3/4" Hose (Corrosion Resistant Brass Fitting)
14	18-1908K	MANIFOLD SPACER KIT	807476A6, 93320A5	3" Riser Kit for Manifold: 18-1957-2. Includes (2) spacers, restrictor, open, & blocked gasket. All necessary mounting hardware is also included
15	18-8554	MOUNTING KIT	N/A	Use 18-8554 Mounting Kit when 18-1908 Spacer, 18-1970-2 Elbow and 18-1974 Elbow are used together. Included in 18-1908K. Includes (1) 18-2849-1 & 18-0897 elbow gaskets
16	18-8555	MOUNTING KIT	N/A	Use with Manifold Spacer: 18-1908 with Riser 18-1976-2. Included in 18-1908K. Includes (1) 18-2849-1 & 18-0897 elbow gaskets.
17	18-8556	MOUNTING KIT	N/A	Use with Manifold Spacer: 18-1985. Includes (1) 18-2849-1 & 18-0897 elbow gaskets
18	18-8505	MOUNTING KIT	N/A	Use with Riser: 18-1976-2. Includes 18-0897 elbow gasket
19	18-8529	MOUNTING KIT	N/A	Use with Risers: 18-1970-2 & 18-1974-1. Includes 18-0897 elbow gasket
20	18-8532	MOUNTING KIT	N/A	Use with Manifold: 18-1957-2. Includes 18-0418 manifold gasket
21	18-0418	MANIFOLD GASKET	96653 / 27-41813	Use with Manifold: 18-1957-2. Included in 18-8532 mounting kit.
22	18-0897	ELBOW GASKET (Restrictor)	27-41813	Fits Manifold: 18-1957-2; Manifold Spacers: 18-1985, & 18-1908; Elbows: 18-1970-2, & 18-1976-2, 18-1974
23	18-1908	MANIFOLD SPACER	93322A12	3" Spacer for Manifold: 18-1952-1. Use with mounting kit 18-8556 (Note: To mount elbows to spacer a separate mounting kit is needed)



**Fits GM In-Line 6 Cylinder 250 & 292 cu. in.
Models 165 & 200**

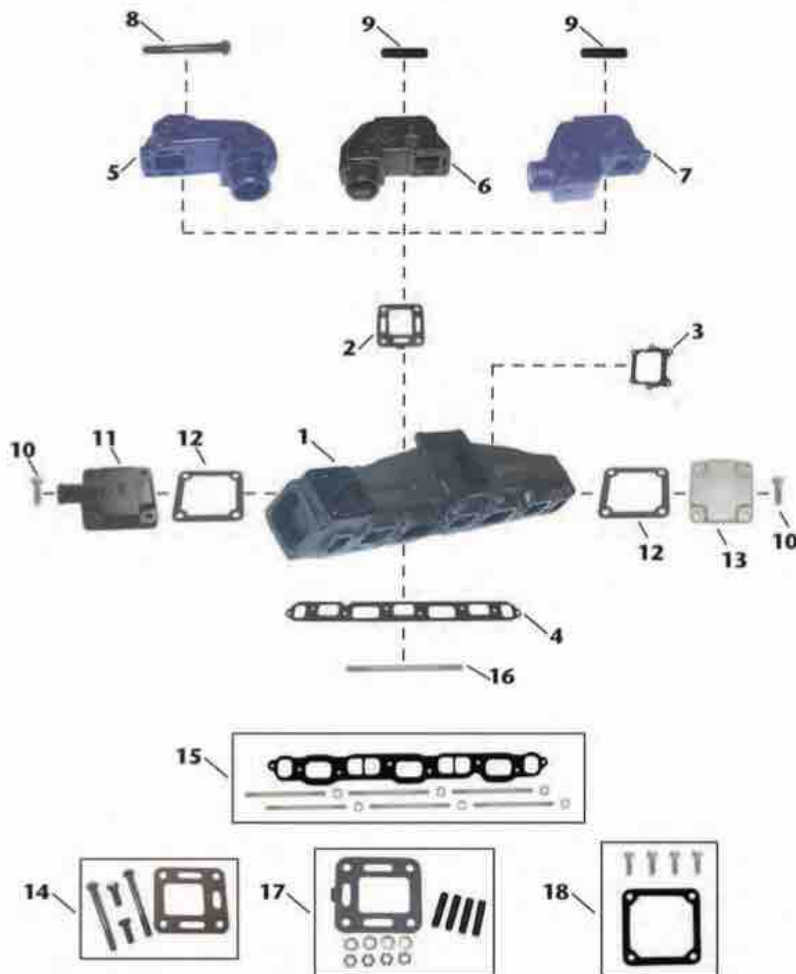

Item No.	Description	OE No.	Application	
1	18-1960-1	MANIFOLD	58759A10	GM In-Line Six Cylinder 250 & 292 cu.in. Models 165 & 200. Use with 18-2830-1 manifold gasket; 18-8531 Mounting Kit
2	18-2833	ELBOW GASKET	27-99777-2	Use with Elbows: 18-1971, 18-1978 & 18-1972. Included in 18-4362 mounting kit
3	18-0353	CARBURETOR GASKET	27-58764	Fits Manifold: 18-1960-1
4	18-2830-1	MANIFOLD GASKET	27-46401	Fits Manifold: 18-1960-1. Included in 18-8531 mounting kit.
5	18-1972	MANIFOLD ELBOW	76325A2	Use with Manifold: 18-1960-1; Elbow Gasket 18-2833
6	18-1971	MANIFOLD ELBOW	76351A2	Use with Manifold: 18-1960-1; Elbow Gasket 18-2833; Mounting Kit 18-4362
7	18-1978	MANIFOLD ELBOW	76771A3	Use with Manifold: 18-1960-1; Elbow Gasket 18-2833; Mounting Kit 18-4362
8	NSS	MOUNTING BOLT	N/A	Included in 18-8552 mounting hardware
9	18-3233	MOUNTING STUD	16-49545	3/8-24, 3/8-16 X 1 3/4. Included in 18-4362 mounting kit.
10	NSS	MOUNTING BOLT	N/A	Included in 18-8512 mounting kit.
11	18-4009	FRONT PLATE	60252A2	Fits Manifold: 18-1960-1
12	18-2832-1	FRONT/END PLATE GASKET	27-48043-1	Fits Port & Starboard Caps of Manifold: 18-1960-1. Included in 18-8512 mounting kit
13	NSS	END PLATE	N/A	Fits Manifold: 18-1960-1
14	18-8552	HARDWARE KIT	N/A	Includes only hardware for 18-1972 elbow.
15	18-8531	MOUNTING KIT	N/A	Use with Manifold: 18-1960-1. Includes 18-2830-1 manifold gasket.
16	NSS	MOUNTING STUD	N/A	Included in 18-8531 mounting kit
17	18-4362	MOUNTING KIT	N/A	Use with Elbows: 18-1971 & 18-1978. Includes 18-2833 elbow gasket
18	18-8512	MOUNTING KIT	N/A	Use with Front Plate: 18-4009. Includes 18-2832-1 gasket

Fits GM V6 229 & 262 cu. in. Models 185 & 205

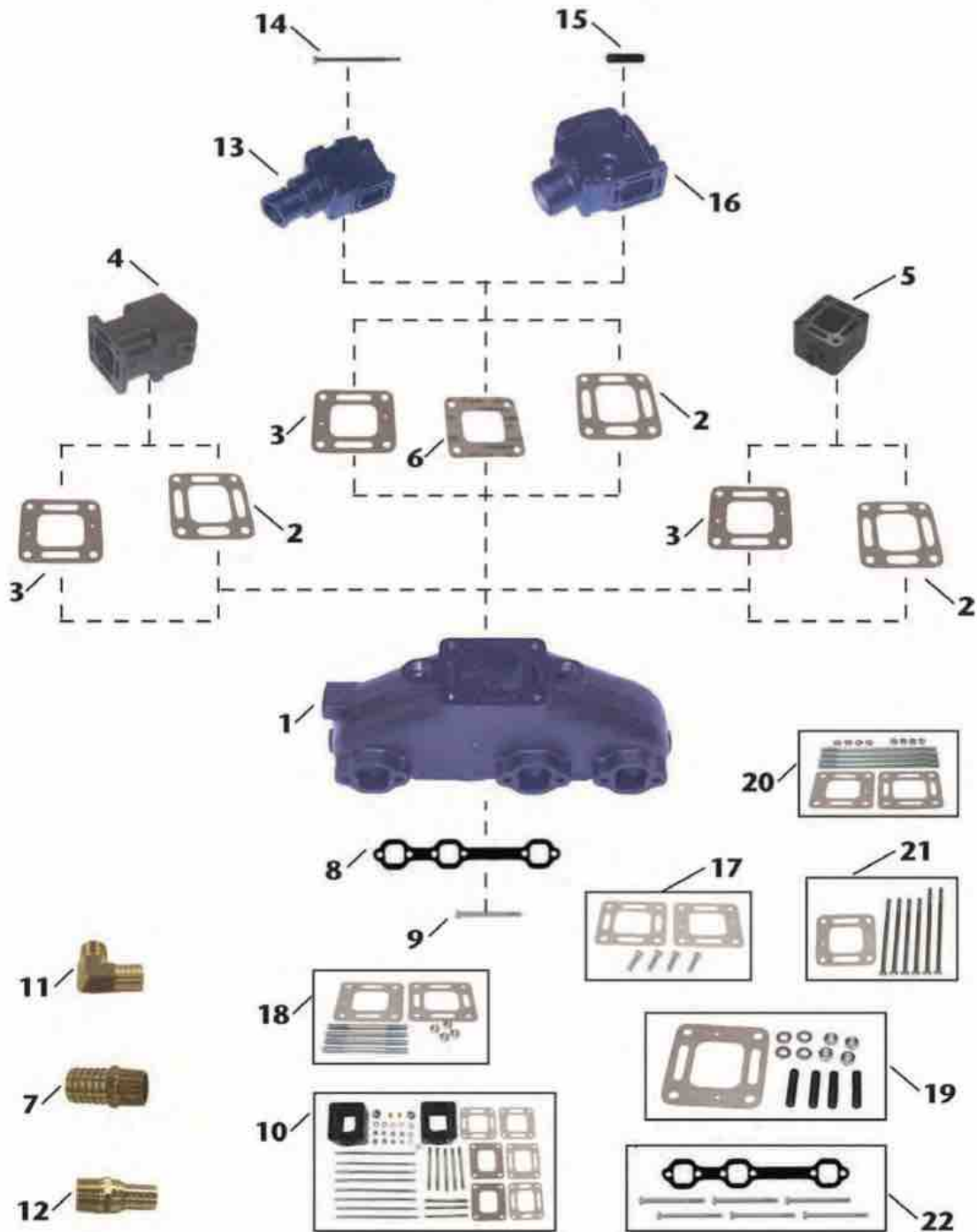

Item No.	Description	OE No.	Application	
1	18-1952-1	MANIFOLD	99746A8	GM (V6) 229 & 262 cu.in. Models 185 & 205 (Port & Starboard). Use with Manifold Gasket: 18-2909; Mounting Kit: 18-8533.
2	18-2849-1	ELBOW GASKET (OPEN)	27-818832	Fits Manifold: 18-1952-1; Manifold Spacers: 18-1985, & 18-1908; Elbows: 18-1970-2, & 18-1976-2.
3	18-0897	ELBOW GASKET (RESTRICTOR)	27-41813	Fits Manifold: 18-1952-1; Manifold Spacers: 18-1985, & 18-1908; Elbows: 18-1970-2, & 18-1976-2.
4	18-1985	MANIFOLD SPACER	93322A12	6" Spacer for Manifold: 18-1952-1. Use with mounting kit 18-8556. (Note: To mount elbows to spacer a separate mounting kit is required)
5	18-1908	MANIFOLD SPACER	933220	3" Spacer for Manifold: 18-1952-1. Use with mounting kit 18-8555 with 18-1976-2, or mounting kit 18-8554 with 18-1970-2.
6	18-0672	ELBOW GASKET (BLOCKED)	27-860231	Fits Manifold: 18-1952-1; Elbows: 18-1970-2, & 18-1976-2
7	18-4461	HOSE FITTING	N/A	3/4" - 14NPT X 1" Hose (Corrosion Resistant Brass Fitting)
8	18-2909	MANIFOLD GASKET	N/A	Gasket for Manifold: 18-1952-1. Included in 18-8533 mounting kit.
9	NSS	MOUNTING BOLT	N/A	Included in 18-8533 mounting kit.
10	18-1908K	MANIFOLD SPACER KIT	807476A6, 93320A5	3" Riser Kit for Manifold: 18-1952-1. Includes (2) spacers, restrictor, open, & blocked gasket. All necessary mounting hardware is also included.
11	18-8216	HOSE FITTING	N/A	3/4" - 14NPT X 1" Hose (Corrosion Resistant Brass Fitting)
12	18-8215	HOSE FITTING	N/A	3/4" - 14NPT X 3/4" Hose (Corrosion Resistant Brass Fitting)
13	18-1976-2	MANIFOLD ELBOW (4" hose • 7° down angle)	44354A3, 807914A1	Fits Manifold: 18-1952-1. Use Elbow gaskets: 18-2849-1, 18-0897, or 18-0672; Use mounting kit: 18-8554
14	NSS	MOUNTING BOLT	N/A	Included in 18-8505 mounting kit.
15	NSS	MOUNTING STUD	N/A	Included in 18-8529 mounting kit.
16	18-1970-2	MANIFOLD ELBOW (3" hose • 0° down angle)	98504A3	Fits Manifold: 18-1952-1. Use Elbow gaskets: 18-2849-1, 18-0897, or 18-0672; Use mounting kit: 18-8529, or if spacer is included use 18-8555
17	18-8556	MOUNTING KIT	N/A	Use with Manifold Spacer: 18-1985. Includes (1) 18-2849-1 & 18-0897
18	18-8554	MOUNTING KIT	N/A	Use with Manifold Spacer: 18-1908 with Riser 18-1970-2. Included in 18-1908K. Includes (1) 18-2849-1 & 18-0897 elbow gaskets.
19	18-8529	MOUNTING KIT	N/A	Use with Riser: 18-1970-2. Includes 18-0897 elbow gaskets.
20	18-8555	MOUNTING KIT	N/A	Use with Manifold Spacer: 18-1908 with Riser 18-1976-2. Included in 18-1908K. Includes (1) 18-2849-1 & 18-0897 elbow gasket.
21	18-8505	MOUNTING KIT	N/A	Use with Riser: 18-1976-2. Includes 18-0897 elbow gasket.
22	18-8533	MOUNTING KIT	N/A	Use with Manifold: 18-1952-1. Includes 18-2909 manifold gasket.



Fits GM Small Block V8 305-350 cu. in. Models 198, 228 & 898

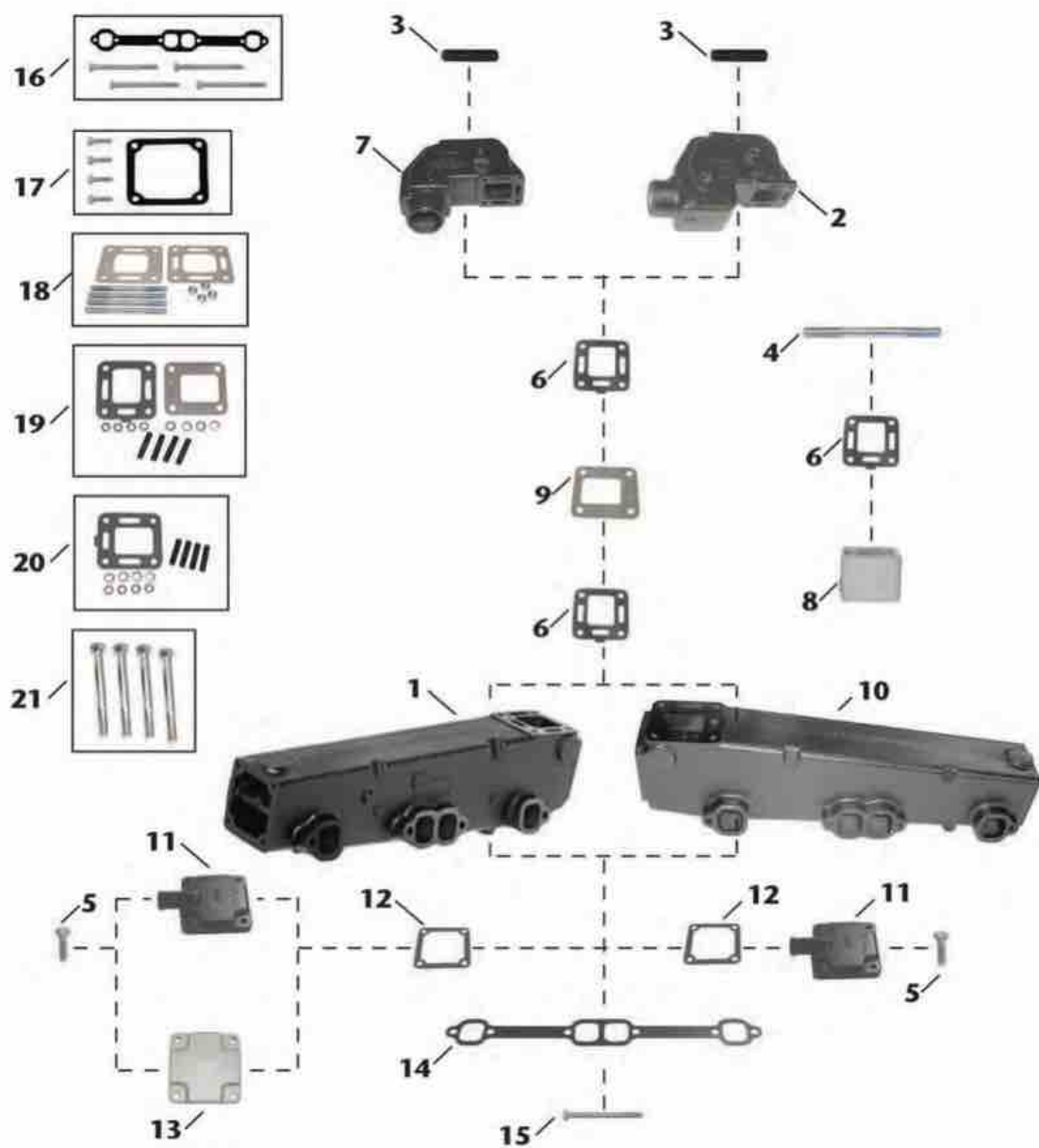

Item No.	Description	OE No.	Application	
1	18-1951-1	MANIFOLD (STARBOARD)	774235A2	GM Small Block (V8) 305-350 cu.in. Models 198, 228, & 898. (Starboard)
2	18-1978	MANIFOLD ELBOW	76771A3	Use with Manifolds: 18-1950-1, 18-1951-1; Elbow Gasket 18-2833; Mounting Kit 18-4362.
3	18-3233	MOUNTING STUD	18-49545	3/8-24, 3/8-16 X 1 3/4. Included in 18-4362 mounting kit.
4	NSS	MOUNTING STUD	N/A	Included in 18-8554 mounting kit.
5	NSS	MOUNTING BOLT	N/A	Included in 18-8512 mounting kit.
6	18-2833	ELBOW GASKET	27-99777-2	Use with Elbows: 18-1971 & 18-1978. Included in 18-4362 mounting kit.
7	18-1971	MANIFOLD ELBOW	76351A2	Use with Manifolds: 18-1950-1, 18-1951-1; Elbow Gasket 18-2833; Mounting Kit 18-4362.
8	18-1906	MANIFOLD SPACER	61851	3" Spacer for Manifold: 18-1950-1, 18-1951-1. Use with mounting kit 18-8554 with 18-1971 or 18-1978 Elbows.
9	18-4008	BLOCK OFF PLATE	60207	Use with Manifolds 18-1950-1, 18-1951-1. Requires (2) 18-2833 elbow gaskets.
10	18-1950-1	MANIFOLD (PORT)	77234A2	GM Small Block (V8) 305-350 cu.in. Models 198, 228, & 898. (Port)
11	18-4009	END PLATE	60252A2	Use with (Port & Starboard) Manifolds: 18-1950-1 & 18-1951-1; Mounting Kit: 18-8512
12	18-2832-1	FRONT/END PLATE GASKET	27-48043-1	Fits Port & Starboard Caps of Manifolds: 18-1950-1, 18-1951-1. Use with Front Plate: 18-4009. Included in 18-8512 mounting kit.
13	NSS	END PLATE	54870	Fits Manifold: 18-1950-1, 18-1951-1; Mounting Kit: 18-8512.
14	18-2949	MANIFOLD GASKET	96306	Use with Manifold: 18-1951-1
15	NSS	MOUNTING BOLT	N/A	Included in 18-8520 mounting kit.
16	18-8520	MOUNTING KIT	N/A	Use with Manifolds: 18-1950-1, 18-1951-1. Includes 18-2949 manifold gasket.
17	18-8512	MOUNTING KIT	N/A	Use with Front/End Plates: 18-4009. Includes 18-2832-1 front end plate gasket.
18	18-8554	MOUNTING KIT	N/A	Use with Manifold Spacer: 18-1908 with Riser 18-1971 or 18-1978 Elbows. Included in 18-1908K. Includes (1) 18-2849-1 & 18-0897 elbow gaskets.
19	18-8514	MOUNTING KIT	N/A	Use with Elbows: 18-1971 & 18-1978. Includes 18-2833 gasket & 18-4008 block off plate.
20	18-4362	MOUNTING KIT	N/A	Use with Elbows: 18-1971 & 18-1978. Includes 18-2833 elbow gasket.
21	18-8548	HARDWARE KIT	N/A	Includes only hardware for 18-1950-1 & 18-1951-1 manifolds. Included in 18-8520 mounting kit.



Fits Ford Small Block V8 302-351 cu. in. Models 215, 225, 233, 255 & 888

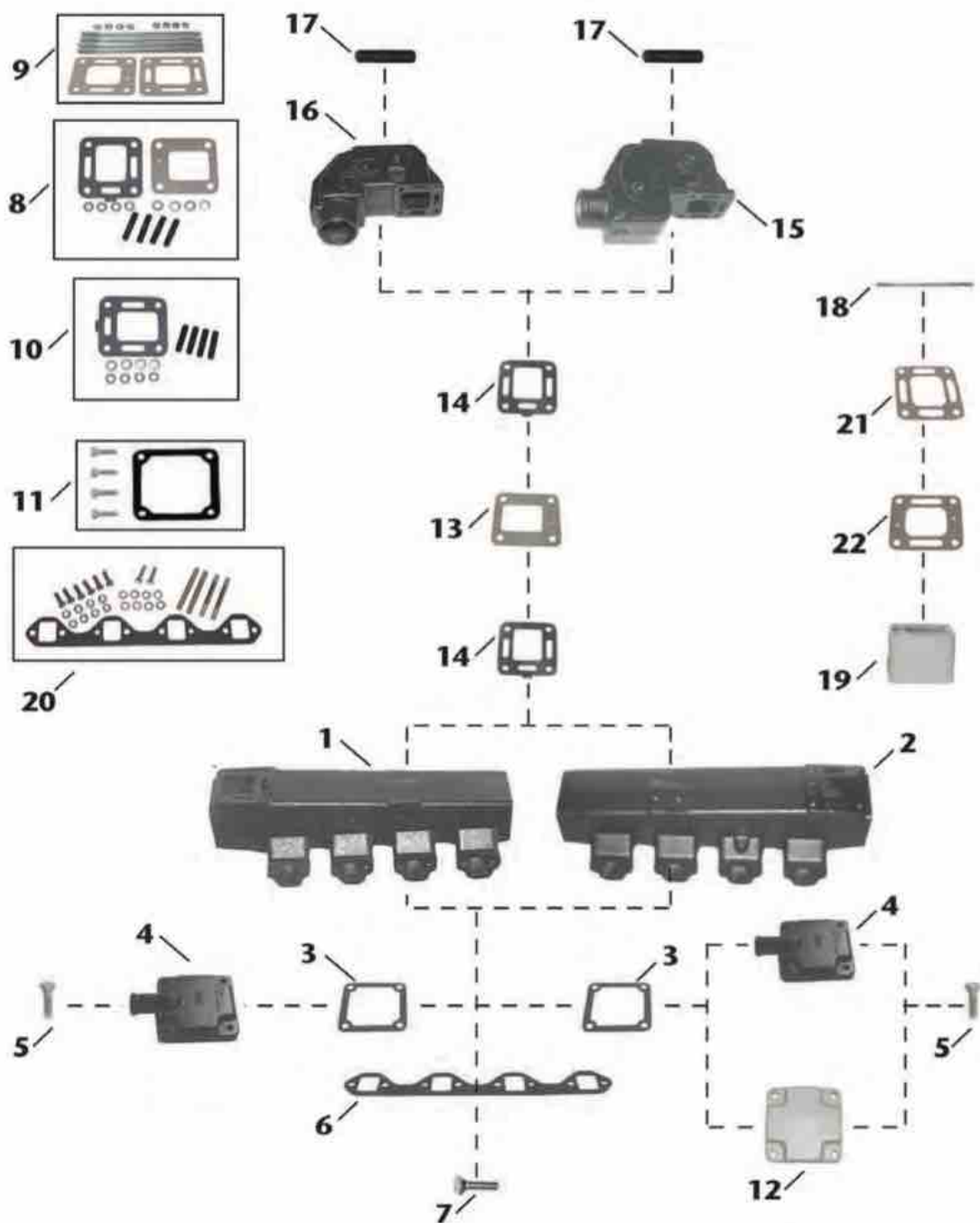

Item No.	Description	OE No.	Application	
1	18-1958-1	MANIFOLD (PORT)	65604A4	Ford Small Block (V8) 302-351 cu.in. Models 215, 225, 233, 255, & 888 (Port). Use with Manifold Gasket: 18-0183-1; Mounting Kit: 18-8509
2	18-1962-1	MANIFOLD (STARBOARD)	65603A4	Ford Small Block (V8) 302-351 cu.in. Models 215, 225, 233, 255, & 888 (Port). & 888 (Starboard). Use with Manifold Gasket: 18-0183-1; Mounting Kit: 18-8509.
3	18-2832-1	FRONT/END PLATE GASKET	27-48043-1	Fits Port & Starboard Caps of Manifolds: 18-1958-1, 18-1962-1. Use with Front Plate: 18-4009. Included in 18-8512 mounting kit.
4	18-4009	FRONT PLATE	60252A2	Use with (Port & Starboard) Manifolds: 18-1958-1, 18-1962-1; Mounting Kit: 18-8512
5	NSS	MOUNTING BOLT	N/A	Included in 18-8512 mounting kit.
6	18-0183-1	MANIFOLD GASKET	27-73866	Use with Manifold: 18-1958-1, 18-1962-1. Included in 18-8509 mounting kit.
7	NSS	MOUNTING BOLT	N/A	Included in 18-8509 mounting kit.
8	18-8514	MOUNTING KIT	N/A	Use with Elbows: 18-1971 & 18-1978. Includes 18-2833 gasket & 18-4008 block off plate.
9	18-8554	MOUNTING KIT	N/A	Use with Manifold Spacer: 18-1906 with Riser 18-1971 or 18-1978. Includes (1) 18-2849-1 & 18-0897 elbow gaskets.
10	18-4362	MOUNTING KIT	N/A	Use with Elbows: 18-1971 & 18-1978. Includes 18-2833 elbow gasket.
11	18-8512	MOUNTING KIT	N/A	Use with Front/End Plates: 18-4009. Includes 18-2832-1 gasket.
12	NSS	END PLATE	54870	Fits Manifolds: 18-1958-1, 18-1962-1; Mounting Kit: 18-8512.
13	18-4008	BLOCK OFF PLATE	60207	Use with Manifolds 18-1958-1, 18-1962-1. Requires (2) 18-2833 elbow gaskets.
14	18-2833	ELBOW GASKET	27-99777-2	Use with Elbows: 18-1971 & 18-1978. Included in 18-4362 mounting kit.
15	18-1978	MANIFOLD ELBOW	76771A3	Use with Manifolds: 18-1958-1, 18-1962-1; Elbow Gasket 18-2833; Mounting Kit 18-4362.
16	18-1971	MANIFOLD ELBOW	76351A2	Use with Manifolds: 18-1958-1, 18-1962-1; Elbow Gasket 18-2833; Mounting Kit 18-4362.
17	18-3233	MOUNTING STUD	16-49545	3/8-24, 3/8-16 X 1 3/4. Included in 18-4362 mounting kit.
18	NSS	MOUNTING STUD	N/A	Included in 18-8554 mounting kit.
19	18-1906	MANIFOLD SPACER	61851	3" Spacer for Manifolds: 18-1950-1, 18-1951-1. Use with mounting kit 18-8554 with 18-1971 or 18-1978 Elbows.
20	18-8509	MOUNTING KIT	N/A	Use with Manifolds: 18-1958-1, 18-1962-1. Includes 18-0183-1 manifold gasket.
21	18-2849-1	ELBOW GASKET (OPEN)	27-818832	Fits Manifolds: 18-1958-1, 18-1962-1; Manifold Spacers: 18-1985. Included in 18-8554 mounting kit.
22	18-0897	ELBOW GASKET (RESTRICTOR)	27-41813	Fits Manifolds: 18-1958-1, 18-1962-1; Manifold Spacers: 18-1985. Included in 18-8554 mounting kit.



Sierra[®]
Marine Engine and Drive Parts

**Fits GM 4 Cylinder 181 cu. in.
Models 120, 140, 2.5L & 3.0L**

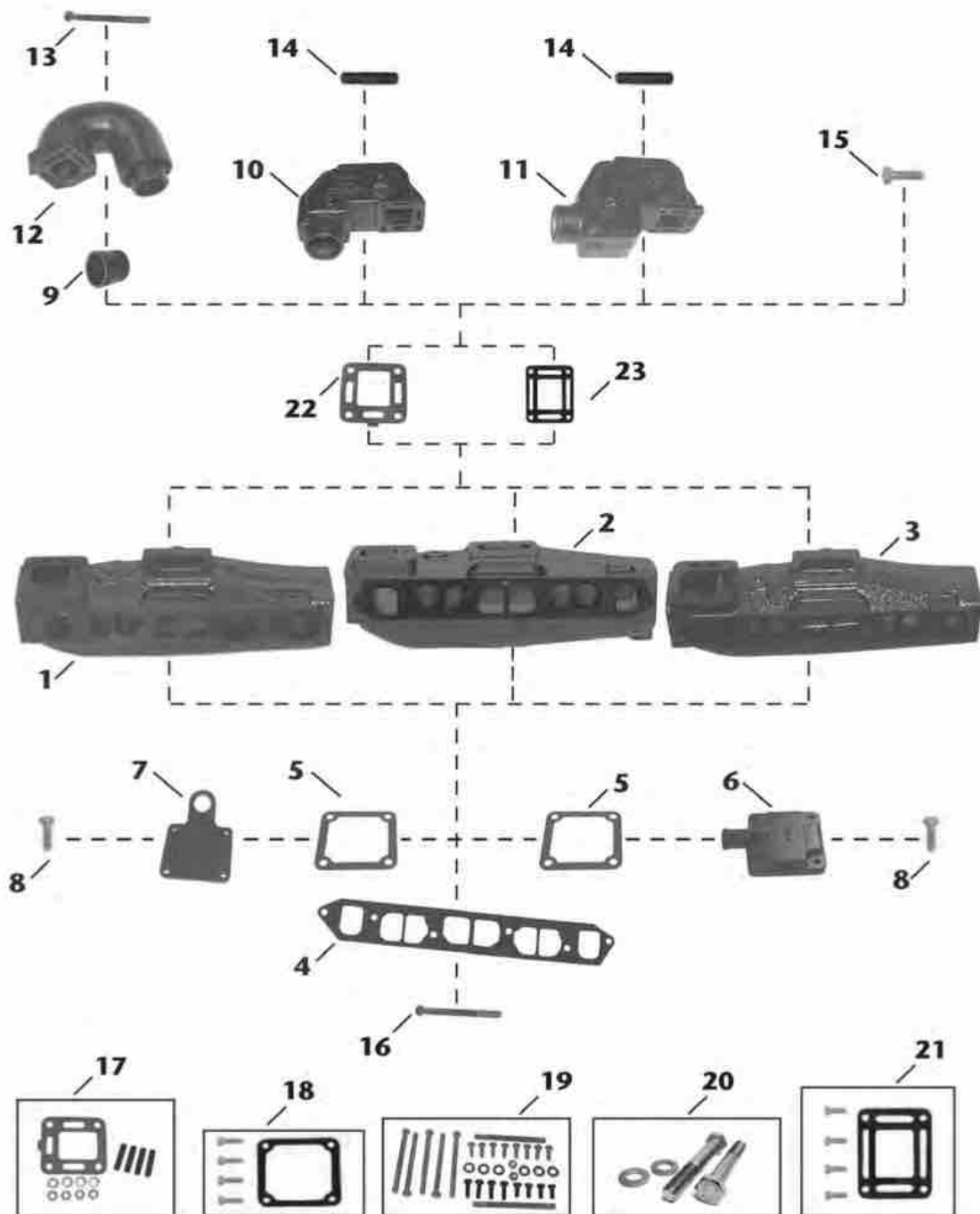

Item No.	Description	OE No.	Application	
1	18-1954-1	MANIFOLD	9582A5	Fits 2.5 & 3.0L 181 CID, Model 140 with Rochester carburetor w/ electrical choke (1983-89). Use with Manifold Gasket: 18-1204-1.
2	18-1955-1	MANIFOLD	96705A1	Fits 3.0L 181 CID, Model 140 with Rochester carburetor w/ mechanical choke (1968-82). Use with Manifold Gasket: 18-1204-1. Mounting Hardware: 18-8549.
3	18-1956-3	MANIFOLD	99798A18	Fits 3.0L 181 CID, Model 140 & 3.0 with Mercarb carburetor w/ electrical choke (1983-95). Use with Manifold Gasket: 18-1204-1.
4	18-1204-1	MANIFOLD GASKET	27-96429	Fits Manifolds: 18-1954-1, 18-1955-1, 18-1956-3
5	18-2832-1	FRONT/ END CAP GASKET	27-48043-1	Fits Port & Starboard Caps of Manifolds: 18-1954-1, 18-1955-1, 18-1956-3.
6	18-4009	FRONT PLATE	60252A2	Fits Manifolds: 18-1954-1, 18-1955-1, 18-1956-3
7	18-5021	END PLATE	805629	Fits Manifolds: 18-1954-1, 18-1955-1, 18-1956-3
8	NSS	MOUNTING BOLT	N/A	Included in 18-8512 mounting kit.
9	18-2748	EXHAUST BOOT	32-44348T	4" Inside Diameter. Use with 18-1975-1 elbow.
10	18-1971	MANIFOLD ELBOW	76351A2	Use with Manifolds: 18-1954-1, 18-1955-1, 18-1956-3; Elbow Gasket 18-2833; Mounting Kit 18-4362
11	18-1978	MANIFOLD ELBOW	76771A3	Use with Manifolds: 18-1954-1, 18-1955-1, 18-1956-3; Elbow Gasket 18-2833; Mounting Kit 18-4362
12	18-1975-1	MANIFOLD RISER	12076A2	Use with Manifolds: 18-1954-1, 18-1955-1, 18-1956-3; Elbow Gasket 18-2819-1; Mounting Hardware 18-8551; Exhaust Boot 18-2748.
13	NSS	MOUNTING BOLT	N/A	Included in 18-8551 mounting hardware.
14	18-3233	MOUNTING STUD	N/A	3/8-24, 3/8-16 X 1 3/4. Included in 18-4362 mounting kit.
15	NSS	MOUNTING BOLT	N/A	Included in 18-8549 mounting kit.
16	18-4362	MOUNTING KIT	N/A	Use with Elbows: 18-1971 & 18-1978. Includes 18-2833 elbow gasket
17	18-8512	MOUNTING KIT	N/A	Use with Front Plate: 18-4009 & End Plate (NSS). Includes 18-2832-1 front/end cap gasket.
18	18-8549	HARDWARE KIT	N/A	Includes only hardware for 18-1955-1 manifold.
19	18-8551	HARDWARE KIT	N/A	Includes only hardware for 18-1975-1 elbow.
20	18-2833	ELBOW GASKET	27-99777-2	Use with Elbows: 18-1971 & 18-1978. Included in 18-4362 mounting kit
21	18-2819-1	ELBOW GASKET	27-39915	Use with Elbow: 18-1973.



Sierra[®]
Marine Engine and Drive Parts

Fits GM Small Block V8 305 & 350 cu. in. Models 200, 228, 230, 260 & 898

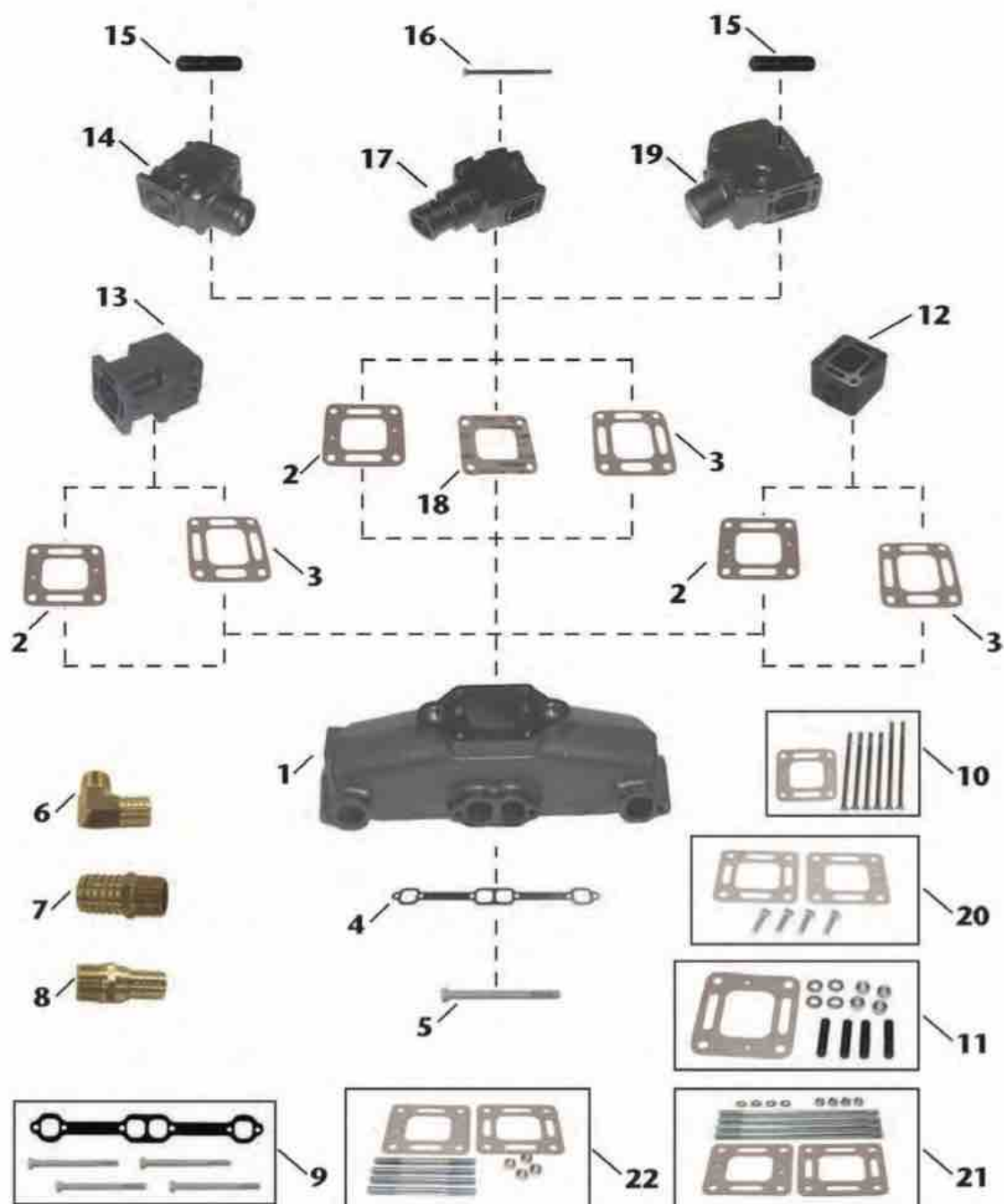

Item No.	Description	OE No.	Application	
1	18-1953-2	MANIFOLD	87114A19	GM Small Block (V8) 305-350 cu.in. Models 200, 228, 230, 260, & 898
2	18-0897	ELBOW GASKET (RESTRICTOR)	27-41813	Fits Manifold: 18-1953-2; Manifold Spacers: 18-1985, & 18-1908; Elbows: 18-1970-2, 18-1976-2, 18-1974-1
3	18-2849-1	ELBOW GASKET (OPEN)	27-818832	Fits Manifold: 18-1953-2; Manifold Spacers: 18-1985, & 18-1908; Elbows: 18-1970-2, 18-1976-2, 18-1974-1
4	18-2949	MANIFOLD GASKET	96306	Use with Manifold: 18-1953-2. Included in 18-8520 mounting kit.
5	NSS	MOUNTING BOLT	N/A	Included in 18-8520 mounting kit.
6	18-8216	HOSE FITTING	22-36305	3/4" - 14NPT X 1" Hose (Corrosion Resistant Brass Fitting)
7	18-4461	HOSE FITTING	N/A	3/4" - 14NPT X 1" Hose (Corrosion Resistant Brass Fitting)
8	18-8215	HOSE FITTING	N/A	3/4" - 14NPT X 3/4" Hose (Corrosion Resistant Brass Fitting)
9	18-8520	MOUNTING KIT	N/A	Use with Manifold: 18-1953-2. Includes 18-2949 manifold gasket.
10	18-8505	MOUNTING KIT	N/A	Use with Riser: 18-1976-2. Includes 18-0897 elbow gasket.
11	18-8529	MOUNTING KIT	N/A	Use with Risers: 18-1970-2, 18-1974-1. Includes 18-0897 elbow gaskets
12	18-1908	MANIFOLD SPACER	933220A12	3" Spacer for Manifold: 18-1953-2. Use with mounting kit 18-8554 with 18-1970-2, or mounting kit 18-8555 with 18-1976-2.
13	18-1985	MANIFOLD SPACER	93322	8" Spacer for Manifold: 18-1953-2. Use with mounting kit 18-8556. (Note to mount elbows to spacer a separate mounting kit is required)
14	18-1974-1	MANIFOLD ELBOW (3" hose • 0° down angle)	98502A2	Fits Manifold: 18-1953-2. Use Elbow gasket: 18-2849-1, 18-0897, or 18-0672; Use mounting kit: 18-8529. (Do not use with spacer)
15	NSS	MOUNTING STUD	N/A	Included in 18-8529 mounting kit.
16	NSS	MOUNTING BOLT	N/A	Included in 18-8505 mounting kit.
17	18-1976-2	MANIFOLD ELBOW (4" hose • 7° down angle)	44354A3, 807914A1	Fits Manifold: 18-1953-2. Use Elbow gasket: 18-2849-1, 18-0897, or 18-0672; Use mounting kit: 18-8505, or if spacer is included use 18-8555.
18	18-0672	ELBOW GASKET (CLOSED)	27-860231	Fits Manifold: 18-1953-2; Manifold Spacers: 18-1985, & 18-1908; Elbows: 18-1970-2, 18-1976-2, 18-1974-1
19	18-1970-2	MANIFOLD ELBOW (3" hose • 15° down angle)	98504A3	Fits Manifold: 18-1953-2. Use Elbow gasket: 18-2849-1, 18-0897, or 18-0672; Use mounting kit: 18-8529, or if spacer is included use 18-8554.
20	18-8556	MOUNTING KIT	N/A	Use with Manifold Spacer: 18-1985, Includes 18-0897 & 18-2849-1. (Note: To mount elbows to spacer a separate mounting kit is required)
21	18-8555	MOUNTING KIT	N/A	Use with Riser Kit 18-1908K; Spacer 18-1908; Riser 18-1976-2; Manifold: 18-1953-1
22	18-8554	MOUNTING KIT	N/A	Use with Riser Kit 18-1908K; Spacer 18-1908; Riser 18-1970-2; Manifold: 18-1952-1



SIERRA MANIFOLDS ARE PAINTED, PACKAGED & LEAK TESTED



18-1998-1 MANIFOLD

Port & Starboard

Replaces: Barr FM-1-83
Universal Center Riser Manifold

Fits: Ford 302 and 351 CID engines

Comes with 18-4363 Mounting Package

Use with: Exhaust Manifold Gasket Set: 18-0603

*For Exploded View - See Pages 640-641



18-1997-1 MANIFOLD

Port & Starboard

Replaces: Barr CHV-1-83 Universal Center Riser Manifold

Fits: GM 283, 305, 307 and 350 CID engines

Use with: Exhaust Manifold Gasket Set: 18-0604

*For Exploded View - See Pages 638-639



18-1898 MANIFOLD

Port & Starboard

Replaces: Barr CHVA-1-84, Marine Power 0991-110

Fits: 454 cu. in. GM big block V8 engines

Use with:

Exhaust Manifold Gasket: 18-0418

Riser: 18-1939, 18-1999

*For Exploded View - See Pages 636-637



18-1951-1* MANIFOLD

Supplied with Mounting Package

Replaces: 77235A2, 77235A8

Barr MC-1-77235

STARBOARD SIDE

Fits: Most Mercruiser (GM) small blocks with end riser

Use with:

Exhaust Manifold Gasket: 18-2949

Mounting Kit: 18-8548



18-1950-1* MANIFOLD

Supplied with Mounting Package

Replaces: 77234A2, 77234A7

Barr MC-1-77234

PORT SIDE

Fits: Most Mercruiser (GM) small blocks with end riser

Use with:

Exhaust Manifold Gasket: 18-2949

Mounting Kit: 18-8548



18-1952-1* MANIFOLD

Port & Starboard

Replaces: Mercruiser 99746A8, A17

Marine Power 611447, Barr MC-1-99746

Fits: Most 4.3L (262 CID) V-6 application

Supplied with Mounting Package

Use with:

Mounting Kit: 18-8533



18-1953-2 MANIFOLD

Port & Starboard

Supplied with Mounting Package

Replaces: Mercruiser 860246Q11

Will fit either side - Fits most Mercruiser (GM) small blocks with center riser.

Supplied with gaskets

Use with:

Mounting Kit: 18-8520



18-1954-1* MANIFOLD

Supplied with Mounting Package

Replaces: Mercruiser 95862A5

Marine Power 0993-000, Barr MC 1 95862

Fits: Most late Model 2.5L 153 CID & 3.0L 181 CID with Rochester Carb

5 BOLT PATTERN (1983-89)

Use with:

Exhaust Manifold Gasket: 18-1204-1

End Plate: 18-4009

* SEE APPLICATION CHART ON PAGES 801-802 FOR SPECIFIC MODELS



**18-1958-1*
MANIFOLD**

Replaces: 65604A4, A12, 54100A1, 54100A5
Barr MC-1-65604 PORT SIDE ONLY
Fits: Most Mercruiser (Ford) V-8 small blocks
Supplied with Mounting Package
Use with:
 Mounting Kit: 18-8509



**18-1955-1*
MANIFOLD
New Style**

Supplied with Mounting Package
Replaces: 96705A1, 52390A1
Barr MC 1 96705
Fits: Most early Model 3.0L 181 CiD with Rochester
 Carb. 5 bolt pattern and 2.5L, 153CID (1968-82)
Use with:
 Exhaust Manifold Gasket: 18-1203
 End Plate: 18-4009



**18-1956-3
MANIFOLD**

Supplied with Mounting Package
Replaces: Mercruiser 860235AD4, 99798A3, 99798A9, 99798A16, 99798A18,
 806867A8
Marine Power 600333
Barr MC 1 99798
Fits: 2.5 & 3.0L (1983-89)



**18-1957-2*
MANIFOLD**

Port & Starboard
Replaces: Mercruiser 807078T08,
 807078Q07
WILL FIT EITHER SIDE
Fits: Most Mercruiser (GM) V-8 big blocks with center
 riser
Use with:
 Exhaust Manifold Gasket: 18-0418
 Mounting Kit: 18-8532



**18-1960-1*
MANIFOLD**

Replaces: 58759A10, A14, 58759A13, 58759A1, 52969A1, 52073A1
Barr MC 1 58759
Fits: Most Mercruiser (GM) Inline 6 Cyl. Engines
Supplied with Mounting Package
Use with:
 Mounting Kit: 18-8531



**18-1962-1*
MANIFOLD
Starboard**

Replaces: 65603A4, 65603A12, 54099A5, 54099A1
Barr MC-1-65603
Fits: Most Mercruiser Engines (Ford) V-8 Small blocks
Supplied with Mounting Package
Use with:
 Mounting Kit: 18-8509

Sierra
 Marine Engine and Drive Parts



**18-1966-1
MANIFOLD**

Replaces: 806867A2, 806867A3, 806867A8, 806867A9, 806867A12, 816329A3, 860235A03, 99798A18
Fits: 3.0L/LX (1990 & Newer); Marine Power Engine Model E181S



**18-1843
EXHAUST MANIFOLD (DRY JOINT)**

Replaces: 865735A02, 865049T01, 864308T01
Fits: 305, 350, 377, 5.0L, 5.7L, 6.2L(2002 and Newer)
Use with:
Manifold Gasket: 18-2949
Elbow Gaskets: 18-0720, 18-0721 or 18-0722
Elbow: 18-1845



**18-1842
V6 DRY JOINT EXHAUST MANIFOLD**

Replaces: 864612T01
Fits: 4.3L Alpha/Bravo (2002 and Newer without Engine Catalyst)
Use with:
Dry Joint Elbow Gaskets: 18-0720, 18-0721 or 18-0722



**18-1999
ELBOW**

Replaces: Barr 20-0082
Fits: 3" I.D. exhaust hose.
Comes with 18-4364 open Mounting Package
Use with:
Manifold: 18-1997-1 or 18-1998-1 or 18-1898
Riser Gasket: 18-2854-1 open or 18-0476-1 blocked
Mounting Kit: 18-4364 open or 18-8535 blocked



**18-1970-2*
ELBOW**

Replaces: Mercruiser 98504A3, 98503A2, 95755A2
Marine Power 0992-115, Barr MC-20-98504
Fits: V-6 & V-8 applications, 15" (3" O.D. Riser) Comes with 18-0897 & brass plugs
Use with:
Manifold: 18-1952-1, 18-1953-2, 18-1957-2
Elbow Gasket: 18-0897 restrictor, 18-2849-1 open, 18-0672 blocked.
Mounting Kit: 18-8529



**18-1971*
ELBOW**

Replaces: Mercruiser 76351A2, 76351A1, 76351A04, 60426A1, 49964A1, 49964A2
Marine Power 0993-001
Fits: Most early model Mercruiser 140 HP (4 cyl) applications
Replaces: Barr MC20-60426P
Use with:
Manifold: 18-1960-1, 18-1958-1, 18-1950-1
Elbow Gasket: 18-2833
Mounting Kit: 18-4362



**18-1992-1
EXHAUST ADAPTER**

Replaces: Barr 200087P
For: 3" I.D. Exhaust Hose
(As used in 18-1987 Exhaust Manifold Conversion Kit) 80°



**18-1972*
ELBOW**

Replaces: 76325A2, 12076A2
Barr MC-20-76325
Fits: Most late Model 120, 140 HP Mercruiser applications
Use with:
Manifold: 18-1955-1, 18-1954-1, 18-1956-3, 18-1901
Elbow Gasket: 18-2833
Mounting Kit: 18-8552



**18-1973*
ELBOW**

Replaces: 39920, 39920A1, 55538A2
Barr MC-20-55538
Fits: Most early Model 120 HP Mercruiser applications



**18-1991
ELBOW ADAPTER**

Replaces: Barr 200089P
For: Use with 3" I.D. Exhaust Hose
Use with:
Manifold Riser: 18-1999
30°



**18-1978
ELBOW**

Replaces: 76771A3, A2, 60427A2, 53779A2, 53779A1
Barr MC-20-76771
V-8 Inboard Applications Only
Use with:
Manifold: 18-1950-1, 18-1951-1, 18-1958-1, 18-1962-1
Elbow Gasket: 18-2833
Mounting Kit: 18-4362



**18-1905
ELBOW**

Replaces: 90880
 Mercuriser 4 Cylinder 224cu. in. 3.7L
 (Models: 165, 170, 180, 190).
 Use with:
 Manifold: Mercuriser 99908
 Exhaust Elbow Mounting Gasket: 18-0113-1
 Mounting Kit: 18-8500



**18-1937
ELBOW**

Replaces: 98562A6
 Mercuriser 4 Cylinder 224cu. in. 3.7L (Models: 165, 170, 180, 190).
 Use with:
 Exhaust Elbow Mounting Gasket: 18-0881-1
 Mounting Kit: 18-8530



**18-1974-1*
ELBOW**

Replaces: 98502A2, Barr MC-20-98502
 Fits: V-6 & V-8 applications 0" (3" O.D. Riser)
 Comes with 18-0897 gasket & brass plugs



**18-1976-2*
ELBOW**

Replaces: Mercuriser 44354A3, 44354A9, 44354A10, 44354A13, 807914A1, 807988A2, 807988A03
 Marine Power 0992-400, Barr MC-20-44354
Fits: Most Mercuriser V-6 & V-8 applications 7" (4" O.D. Riser) Comes with 18-0897, 18-4263 & 18-4258
 Use with:
 Manifold: 18-1952-1, 18-1953-2, 18-1957-2
 Riser Gasket: 18-0897 restrictor, 18-2849-1 open, 18-0672 blocked
 Mounting Kit: 18-8505



**18-1845
EXHAUST ELBOW
(DRY JOINT)**

Replaces: 864591T02
Fits: 2004 & Up V6 & V8(305, 350, 377) SN 0W310000 & Up, 2002 & Up V8(350 & 377) SN 0M317000 & Up
 Use with:
 Manifolds: 18-1843, 18-1842
 Dry Joint Elbow Gaskets: 18-0720, 18-0721 or 18-0722



**18-1907
RISER**

Replaces: Barr 20-0102, Indmar 53-2009 and 53-2018
 Barr, Indmar Ford Small Block V8 302-351cu. in • Use with 3" hose.
 Use with:
 Manifold: 18-1997-1, 18-1998-1
 Riser Gasket: 18-2854-1 open or 18-0476-1 blocked
 Mounting Kit: 18-4364 open or 18-8535 blocked



**18-1939
RISER**

Replaces: Barr 20-0100, Marine Power 0992-593
 Barr, Indmar and Marine Power Ford Small Block V8 302-351cu. in, GM Small Block V8 305-350cu. in., GM Big Block V8 454cu. in. • Use with 4" hose.
 Use with:
 Manifold: 18-1997-1, 18-1998-1, 18-1898
 Riser Gasket: 18-2854-1 open or 18-0476-1 blocked
 Mounting Kit: 18-4364 open or 18-8535 blocked



**18-1975-1*
RISER**

Replaces: Mercuriser 12076A1, 12076A2, 95864A2
 Marine Power 6000-33A
Fits: late Model Mercuriser 4 cyl. Engines
 Use with:
 Manifold: 18-1955-1, 18-1954-1, 18-1956-3, 18-1901
 Riser Gasket: 18-2833
 Mounting Kit: 18-8551
 Bellow: 18-2748



**18-1908K
MANIFOLD RISER SPACER KIT**

Replaces: 807476A6, 93320A2, 93320A3, 93320A5, 93320A6, 93320A13
 Alpha/Bravo/Gen+/Gen/V GM Small Block V-8 305, 350, 4.3L, 454, 5.0, 5.7L, 502, 7.4L, 8.2L (3" Riser Kit)
 Complete with Mounting Hardware, Center Rise 3" PACKAGED AS SET
 Use with:
 Manifold: 18-1952-1, 18-1953-2, 18-1957-2 3"



**18-1906
MANIFOLD SPACER**

Replaces: 61851A1
 3" Spacer for 18-1950, 18-1951, 18-1958-1 & 18-1962-1 manifolds



**18-1908
MANIFOLD RISER SPACER - 3"**

Replaces: 93320
 Mercuriser GM V6 229 and 262cu.in. (Models: 185 and 205), GM Small Block V8 305-350cu.in. (Models: 200, 228, 230, 260 and 898), GM Big Block V8 454cu.in. (Models: 330, 340 and 7.4L)
 Used with:
 Manifolds: 18-1952-1, 18-1953-2, 18-1957-2



**18-1985
MANIFOLD SPACER - 6"**

Replaces: Mercuriser 93322
 Marine Power 612011
 Barr MC-20-93322A3
For: 229 and 262 V6, 305-350 Small Block V8, 454 Big Block V8
 Used with:
 Manifold: 18-1952-1, 18-1957-2, 18-1953-2

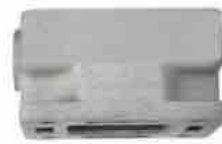

**18-1949
MANIFOLD SPACER**

Barr CM 20-0097
 3" Spacer for Barr, Indmar and Marine Power Ford Small Block V8 302-351cu.in., GM Small Block V8 305-350cu.in., GM Big Block V8 454cu.in.
 Used with:
 Manifold: 18-1998-1, 18-1997-1 and 18-1898



**18-1990
MANIFOLD BLOCK OFF PLATE**

Replaces: 48045, 54870, 73813,
73813A1, 73813F1
Barr 1-73813



**18-5021
END PLATE**

Replaces: 805629
Use with:
Manifold: 18-1954-1,
18-1955-1, 18-1956-3



**18-4008
BLOCK-OFF PLATE**

Replaces: 60207
Barr MC-20-60207
Use with:
Riser: 18-1971, 18-1978



**18-1995
MANIFOLD END PLATE**

Replaces: 47638, 47638A1
GM 4 cyl. 153 cu. in.
For: Model 110/120 where carb. linkage
mounts to the rear of the engine

PIPE PLUGS



Part #	Replaces	Thread Size	Description
18-4257	—	1/4"	Blacksteel Plug
18-4263	22-32802, 22-328022, 22-328021, 22-841908, 22-30139, F700633, F15810151.	1/8" - 27 NPT	Pipe Plug
18-4264	22-32803, 22-87543, F15880010	3/8" - 18 NPT	Pipe Plug
18-4265	22-428611, 22-42861, 22-861187	3/4" - 14 NPT	Pipe Plug (Brass hexdrive)
18-8111 (D)	22-36392	1/4" - 18 NPT	Pipe Plug
18-4258	22-33198A1, 22-41622	3/4" - 14 NPT	Pipe Plug (Stainless steel w/ square drive)

**18-4009
MANIFOLD END PLATE**

Replaces: 52999, 60252, 60252A2
Barr 160252
Use with:
Manifold: 18-1960-1, 18-1958-1,
18-1950-1, 18-1951-1
End Plate Gasket: 18-2832-1
Mounting Kit: 18-8512



RISER BOLTS

Part #	Replaces	Thread Size	Description
18-8410	10-43749	3/8"-16 x 5 1/4"	Use w/o remote oil filter
18-8411	10-44387	1/8" - 16 x 6 1/4"	Use with remote oil filter



**18-4363
EXHAUST ELBOW MOUNTING KIT**

Replaces: Barr FM-1-83-P
Use with:
Manifold: 18-1998-1



**18-4362
EXHAUST ELBOW MOUNTING KIT**

Replaces: Barr MC20-60426P
Use with:
Elbow: 18-1971



**18-8500
EXHAUST ELBOW MOUNTING KIT**

Mercuriser 4 Cylinder 224cu.in. 3.7L
(Models: 165, 170, 180, 190)
Used with:
Elbow/Reservoir: 18-1905

**18-8505
EXHAUST ELBOW MOUNTING KIT**

Mercuriser GM V6 229 and 262cu.in. (Models
185 and 205). GM Small Block V8 305-350cu.
in. (Models: 200, 228, 230, 260, 898), GM Big
Block V8 454cu.in. (Models: 330, 340 and 7.4L)
Used with:
Riser: 18-1976-2

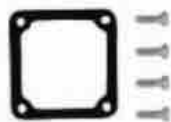

**18-8512
EXHAUST ELBOW
MOUNTING KIT**

Mercuriser GM 4 Cylinder 181cu.in. (Models:
120,140, 2.5L,3.0L), GM Inline 6 Cylinder 250-
292cu.in. (Models: 165 and 200), Ford Small Block
V8 302-351cu.in. (Models: 215,225,233, 255,888),
GM Small Block V8 305, 350cu.in.(Models:
198,228,898)
Used with:
Front Plate: 18-4009



**18-8514
EXHAUST ELBOW
MOUNTING KIT**

Mercuriser Ford Small Block V8 302-351cu.in.
(Models: 215, 225, 233, 255, 888), GM Small
Block V8 305-351cu.in. (Models: 198,228,898)
Used with:
Riser: 18-1971 & 18-1978
(Not for Fresh Water/Closed Cooling Systems)



**18-8520
EXHAUST MANIFOLD MOUNTING KIT**

Mercuriser GM Small Block V8 305-350cu.in.
(Models: 198, 200, 228, 230, 260, 898)
Used with:
Manifold: 18-1950-1, 18-1951-1, 18-1953-2

(D) This product is priced per piece. To order priced per package, please add -9 to the part number



**18-4364 (Open)
EXHAUST ELBOW MOUNTING KIT**
Replaces: Barr 20-0082-P.
Use with:
Riser: 18-1999, 18-1907, 18-1939



**18-8529
EXHAUST ELBOW
MOUNTING KIT**
MerCruiser GM V6 229 and 262cu.in.
(Models 185 and 205), GM Small Block V8
305-350cu.in. (Models: 200, 228, 230, 260,
898), GM Big Block V8 454cu.in. (Models: 330,
340 and 7.4L)
Used with:
Riser: 18-1970-2



**18-8530
EXHAUST ELBOW MOUNTING KIT**
MerCruiser 4 Cylinder 224cu.in. 3.7L
(Models: 165, 170, 180, 190)
Used with:
Elbow/Reservoir: 18-1937



**18-8531
EXHAUST MANIFOLD MOUNTING KIT**
MerCruiser GM Inline 6 Cylinder 250cu.in.
(Models: 165 and 200)
Used with:
Manifold: 18-1960-1



**18-8532
EXHAUST MANIFOLD MOUNTING KIT**
MerCruiser GM Big Block V8 454cu.in. (Models:
330, 340 and 7.4L)
Used with:
Manifold: 18-1957-2



**18-8533
EXHAUST MANIFOLD MOUNTING KIT**
MerCruiser GM V6 229 and 262cu.in. (Models
185 and 205)
Used with:
Manifold: 18-1952-1



**18-8535 (Blocked)
EXHAUST ELBOW
MOUNTING KIT**
Barr, Indmar and Marine Power
Ford Small Block V8 302-351cu.in., GM Small
Block V8 305-350cu.in., GM Big Block V8 454cu.
in.
Used with:
Risers: 18-1939, 18-1999, and 18-1907



**18-8536
EXHAUST ELBOW MOUNTING KIT**
Barr, Indmar and Marine Power GM Small Block
V8 305-350cu.in.
Used with:
Manifold: 18-1997-1



**18-8538
EXHAUST MANIFOLD MOUNTING KIT**
Barr and Indmar Ford Small Block V8
302-351cu.in.
Used with:
Manifold: 18-1998-1



**18-8554
EXHAUST ELBOW MOUNTING KIT**
For: 229 and 262 ci V6, 305 and 350
SB V8, 454 Big Block V8.
Used with:
Riser Kit: 18-1908K and 18-1908 Spacer
Riser: 18-1970-2
Manifold: 18-1952-1, 18-1953-2 & 18-1957-2



**18-8555
EXHAUST ELBOW MOUNTING KIT**
For: 229 and 262 ci V6, 305 and
350 SB V8, 454 Big Block V8.
Used with:
Riser Kit: 18-1908K and 18-1908 Spacer
Riser: 18-1976-2
Manifolds: 18-1952-1, 18-1953-2 & 18-1957-2



**18-8556
EXHAUST ELBOW MOUNTING KIT**
For: 229 and 262 ci V6, 305 and 350 SB V8, 454
Big Block V8. Used to mount Spacer 18-1985 to
18-1953-2, 18-1957-2 and 18-1952-1 Manifolds

HARDWARE KITS

















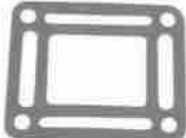

Part No.	Fits
18-8548	18-1950-1 & 18-1951-1 Manifold
18-8549	18-1950-1 Manifold
18-8551	18-1975-1 Exhaust Elbow



**18-0183-1
EXHAUST MANIFOLD GASKET**
Replaces: MerCruiser 27-73866, 27-54566
Volvo 3853742, 3852455, OMC 908717
Used with:
Manifold: 18-1962-1, 18-1938, 18-1998-1,
18-1996, 18-1979

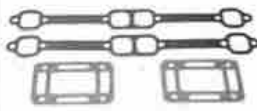

**18-0353
CARB MOUNTING GASKET**
Replaces: 27-58764
Used with:
Manifold: 18-1960-1

 <p>18-0418 EXHAUST MANIFOLD GASKET Replaces: 27-46820 Use with: Manifolds: 18-1957-2, 18-1982, 18-1929, 18-1933, 18-1898</p>	 <p>18-0476-1 RISER BLOCK OFF GASKET Barr, Indmar & Marine Power Ford Small Block V6 302-351cu.in. Used with: Risers: 18-1939, 18-1999, 18-1907</p>	<p>PKG. OF 2</p>  <p>18-0672 18-0672-9Ⓢ EXHAUST ELBOW GASKET Replaces: 27-860231, 8637251, 27-41811, 27-863725 Used with: Riser: 18-1970-2, 18-1976-2</p>	 <p>18-0881-1 EXHAUST ELBOW GASKET Replaces: 27-18272, 27-97863 Included in 18-8530 mounting kit Used with: Elbow: 18-1937</p>
 <p>18-0885-1 18-0885-9Ⓢ EXHAUST ELBOW GASKET Replaces: 27-48042</p>	 <p>18-0897 (Restrictor) EXHAUST ELBOW GASKET Replaces: 27-41813, 27-860233, 27-863724 Used with: Riser: 18-1976-2, 18-1970-2</p>	 <p>18-1204-1 18-1204-1-9Ⓢ EXHAUST MANIFOLD GASKET Replaces: 27-96429</p>	<p>PKG. OF 2</p>  <p>18-2819-1 18-2819-9Ⓢ EXHAUST ELBOW GASKET Replaces: 27-39915</p>
 <p>18-2830-1 EXHAUST MANIFOLD GASKET 6 cyl. Replaces: 27-46401</p>	<p>PKG. OF 2</p>  <p>18-1210-1 END CAP GASKET Replaces: 27-39923</p>	<p>PKG. OF 2</p>  <p>18-2832-1 18-2832-1-9Ⓢ MANIFOLD END CAP GASKET Replaces: 27-480431 Use with: Manifolds: 18-1951-1, 18-1950-1, 18-1954-1, 18-1958-1, 18-1955-1, 18-1956-3, 18-1960-1, 18-1962-1 End Plate: 18-4009</p>	 <p>18-2833 18-2833-9Ⓢ EXHAUST ELBOW GASKET Replaces: 27-99772</p>
<p>PKG. OF 2</p>  <p>18-2849-1 (Open) 18-2849-9-1Ⓢ EXHAUST ELBOW GASKET Replaces: 27-87105-1, 27-818832, 27-863726 Use with: Elbow: 18-1976-2, 18-1970-2</p>	 <p>18-2854-1 (Open) 18-2854-9Ⓢ EXHAUST ELBOW GASKET Replaces: Barr 01-0107 Use with: Riser: 18-1999, 18-1939, 18-1907</p>	 <p>18-2896-1 EXHAUST MANIFOLD GASKET Replaces: 27-52546, 27-32816 GM 4 cyl. 153 cu. in. For model 110/120 where carb. linkage mounts to the rear of the engine</p>	 <p>18-2909 18-2909-9Ⓢ EXHAUST MANIFOLD GASKET For: GM V-6 Used with: Manifold: 18-1952-1</p>
 <p>18-2912-1 EXHAUST MANIFOLD GASKET Replaces: 27-53354</p>	 <p>18-2949 18-2949-9Ⓢ EXHAUST MANIFOLD GASKET Replaces: Mercruiser 27-33395 Barr CHV-47-000 GM 5.0L & 5.7L Use with: Manifold: 18-1997-1, 18-1950-1, 18-1951-1</p>	 <p>18-0603 EXHAUST MANIFOLD GASKET SET For: Ford 302/351 CID Engines For use with 18-1998-1</p>	 <p>18-0604 EXHAUST MANIFOLD GASKET SET For: GM 305/350 CID Engines For use with 18-1997-1</p>

Ⓢ Priced per Package

 <p>18-0720 DRY JOINT GASKET (CLOSED) Replaces: 27-864549A02, 27-864549A1 Fits: 4.3L, 5.0L, 5.7L, 6.2L utilizing the Dry Joint Manifold and Riser Used with: 18-1843, 18-1842 Manifolds & 18-1845 Riser</p>	 <p>18-0721 DRY JOINT GASKET (OPEN) Replaces: 27-864547A02, 27-864547A1 Fits: 4.3L, 5.0L, 5.7L, 6.2L utilizing the Dry Joint Manifold and Riser Used with: 18-1843, 18-1842 Manifolds & 18-1845 Riser</p>	 <p>18-0722 DRY JOINT GASKET (RESTRICTED) Replaces: 27-864850A02, 27-864547A1 Fits: 4.3L, 5.0L, 5.7L, 6.2L utilizing the Dry Joint Manifold and Riser Used with: 18-1843, 18-1842 Manifolds & 18-1845 Riser</p>
 <p>18-4218 DRAIN TAP Replaces: 22-87238, 22-16951A1, 22-64426, 22-16951Q1 1/4" NPT 18-3223-9 Bulk pack of 12</p>	 <p>18-4224 DRAIN ELBOW ASSEMBLY Replaces: 22-806926A1, 22-862210A01 3/4" NPT</p>	 <p>18-4226 DRAIN PLUG Replaces: 22-806608A1, 22-806608A02</p>
 <p>18-4227 DRAIN ELBOW Replaces: 22-806926, 22-862210</p>	 <p>18-4461 HOSE BARB Replaces: 22-807155 3/4" - 14 NPT x 1" Hose Corrosion-Resistant Brass Fitting</p>	 <p>18-8216 HOSE BARB Replaces: 22-36305, 22-36305T 3/4" - 14 NPT x 1" hose barb Fits: Mercruiser- V6 (229 and 262ci), Small Block V8 (305-350ci), Big Block V8 (454ci)</p>

① Items ending in "D" are Display Packaged - Regular number is Non-Display
② Priced per Package

MANIFOLD/MANIFOLD GASKET APPLICATION

Liter	Model	Note	CID	# Cyl.	Stroke	Year Range	Serial # Range	Exh. Manifold Port	Exh. Manifold Starboard	Exh. Elbow	End Cap Front	End Cap Rear	Manifold Gasket	Exh. Elbow Gasket
2.5L	120		153	4	4	1966-1982	2045625 - 6229717						27-52546	18-2819-1
2.5L	120		153	4	4		2324347 - 3377340					18-1995	18-2896-1	18-2819-1
2.5L	120		153	4	4		3377341 - 5192408					18-1995	18-2896-1	18-2819-1
2.5L	120		153	4	4		5192049 - 6229717					18-1995	18-2896-1	18-2819-1
2.5L	120		153	4	4	1983-1986	6229718 - B5311853			16-4009			16-1204-1	18-2833
2.5L	2.5L		153	4	4	1987-1989	B531854 - C853255	18-1956-3		18-4009	18-4009	18-1204-1	18-2833	
3.0L	140		181	4	4	1968-1982	2508091 - 6229717	18-1955-1		16-1971	18-4000	18-1890	18-2812-1	18-2833
3.0L	140		181	4	4		3332128 - 5157608	18-1955-1				18-4009	18-1203	18-2833
3.0L	140		181	4	4		5157609 - 6229717	18-1955-1				18-4009	18-1203	18-2833
3.0L	140		181	4	4	1983-1986	6229718 - B450900			16-1975-1	18-4009		18-1204-1	18-2833
3.0L	3.0L		181	4	4	1990-1994	C856509 & UP	18-1956-3		16-1975-1	18-4000		18-1204-1	18-2833
3.0L	3.0L		181	4	4	1987-1989	B450801 - C856508			16-1975-1	18-4009		18-1204-1	18-2833
3.0L	3.0L		181	4	4	1998-2003	L010042 - M879999	18-1956-3		18-1975-1	18-1990		18-1204-1	18-2833
3.0L	3.0L		181	4	4	2003-2010	M880000 & UP	18-1956-3		18-1975-1			18-0680	18-2833
3.0L	3.0LX		181	4	4	1990-1987	C850509 - K999999	18-1956-3		18-1975-1	18-1990		18-0680	18-2833
3.0L	3.0L MPI / 3.0L EC		181	4	4	2008-2010	A072812 & UP						18-0680	
	150			4	4		1686496 - 2048046						18-2830-1	
	160			4	4		2048022 - 2770031						18-2830-1	
3.7L	165		224	4	4	1987	B434941 - B774251	ⓐ		18-1937			18-0956-1	18-0881-1
3.7L	165		224	4	4	1987	B434941 - B774251	ⓑ					18-0956-1	
3.7L	165		224	4	4		2770032 & up	18-1960-1			18-4009		18-2830-1	18-2833
3.7L	170		224	4	4	1985-1986	6916779 - B434940	ⓐ		18-1937			18-0956-1	18-0881-1
3.7L	170		224	4	4	1985-1986	6916779 - B434940	ⓑ					18-0956-1	18-0113-1
3.7L	180		224	4	4	1987	B436391 - B775248	ⓐ		16-1937			18-0956-1	18-0881-1

- ⓐ For engines with aluminum exhaust manifolds
- ⓑ For engines with cast iron exhaust manifolds
- ⓐ 3" (76mm) O.D. & 0 degree down angle
- ⓑ 3" (76mm) O.D. & 15 degree down angle
- ⓐ 4" (102mm) O.D.
- ⓐ 2 piece exhaust manifold
- ⓑ 1 piece exhaust manifold
- ⓐ Has a rectangular elbow mounting bolt pattern
- ⓑ Has a square elbow mounting bolt pattern
- ⓐ In-line applications
- ⓑ V-drive applications
- ⓐ Standard rise
- ⓑ 2" (51mm) rise
- ⓐ 3" (76mm) rise
- ⓑ 4" (152mm) rise
- ⓐ Port
- ⓑ Starboard
- ⓐ Engines with risers or closed cooling may require a different gasket than listed
- ⓐ Exhaust manifold with external water rail
- ⓑ Exhaust manifold w/o external water rail
- ⓐ 1 piece exhaust manifold is n/a. Engine must be converted to the 2 piece exhaust system
- ⓑ Engines with easy drain system
- ⓐ Engines with multi-point drain system
- ⓑ Intermediate collector housing

MANIFOLD/MANIFOLD GASKET APPLICATION (Cont.)

Liter	Model	Note	CID	# Cyl.	Stroke	Year Range	Serial # Range	Exh. Manifold Port	Exh. Manifold Starboard	Exh. Elbow	End Cap Front	End Cap Rear	Manifold Gasket	Exh. Elbow Gasket
3.7L	180		224	4	4	1987	8436391 - 8775248	⊖					18-0956-1	18-0113-1
3.7L	190		224	4	4	1985-1986	6916779 - 8436390	⊖		18-1937			18-0956-1	18-0881-1
3.7L	190		224	4	4	1985-1986	6916779 - 8436390	⊖					18-0956-1	18-0113-1
3.7L	3.7L		224	4	4	1988-1989	8774252 & UP	⊖		18-1937			18-0956-1	18-0881-1
3.7L	3.7L		224	4	4	1988-1989	8774252 & UP	⊖					18-0956-1	
3.7L	3.7LX		224	4	4	1988-1989	8775249 & UP	⊖		18-1937			18-0956-1	18-0881-1
3.7L	3.7LX		224	4	4	1988-1989	8775249 & UP	⊖					18-0956-1	18-0113-1
470			224	4	4	1976-1977	4206730 - 4625573						18-0956-1	18-2833
470	470 MCM / 470 MIE		224	4	4	1977-1982	4625580 - 6218038						18-0956-1	18-2833
470			224	4	4	1983-1984	6218037 - 6916778						18-0956-1	18-0113-1
485			224	4	4	1980-1982	5885994 - 6218038						18-0956-1	
488			224	4	4	1983-1984	6170297 - 6916778						18-0956-1	18-0113-1
140			194	5	4	1963	1538930 - 1725960						18-2830-1	
150			230	5	4	1964-1966	1666495 - 2048046						18-2830-1	
160			250	5	4	1967-1969	2048022 - 2770031						18-2830-1	
165			250	5	4	1970-1981	2770032 - 5813433	18-1960-1		18-1971	18-4009	18-1990	18-2830-1	18-2833
200			292	5	4	1969	2453769 - 2712072	18-1960-1		18-1971		18-1990	18-2830-1	18-2833
185		4bb	229	6	4	1983-1984	6330183 - 6919655	18-1952-1	18-1952-1	18-1970-2			18-2909	18-0897
175			262	6	4	1987	8527955 - 8773242	18-1952-1	18-1952-1	18-1976-2			18-2909	18-0897
185		2bb	262	6	4	1985-1986	A331455 - 8527954	18-1952-1	18-1952-1	18-1970-2			18-2909	18-0897
185		2bb	262	6	4	1985-1986	A331455 - 8527954	18-1952-1	18-1952-1	18-1976-2			18-2909	18-0897
205			262	6	4	1985-1986	A331455 - 8527954	18-1952-1	18-1952-1	18-1970-2			18-2909	18-0897
205			262	6	4	1985-1986	A331455 - 8527954	18-1952-1	18-1952-1	18-1976-2			18-2909	18-0897
205			262	6	4	1987	8527955 - 8775129	18-1952-1	18-1952-1	18-1976-2			18-2909	18-0897
4.3L	262 MAG EFI GEN +		262	6	4	1996-1997	F803800 - K999999	18-1952-1	18-1952-1	18-1976-2			18-2909	18-0897
4.3L	262 MAG EFI GEN +		262	6	4	1996-1997	F803800 - K999999	⊖	⊖	⊖			18-2909	
4.3L	4.3L		262	6	4	1988-1996	8773243 - F802999	18-1952-1	18-1952-1	18-1976-2			18-2909	18-0897
4.3L	4.3L GEN +		262	6	4	1998-2002	L010044 - M614999	18-1952-1	18-1952-1	18-1976-2			18-2909	18-2849-1
4.3L	4.3L GEN +		262	6	4	1998-2002	L010044 - M614999	⊖	⊖	⊖			18-2909	
4.3L	4.3L GEN +		262	6	4	2002-2004	M615000 - W309999						18-2909	
4.3L	4.3L GEN +		262	6	4	2004-2010	W310000 & UP						18-2909	
4.3L	4.3L EFI GEN +		262	6	4	1998-2002	L012009 - M322780	18-1952-1	18-1952-1	18-1976-2			18-2909	18-2849-1
4.3L	4.3L EFI GEN +		262	6	4	1998-2002	L01009 - M322780	⊖	⊖	⊖			18-2909	
4.3L	4.3L MPI		262	6	4	2002	M300000 - M614999	18-1952-1	18-1952-1	18-1976-2			18-2909	18-0897
4.3L	4.3L MPI		262	6	4	2002	M300000 - M614999	18-1952-1	18-1952-1	18-1976-2			18-2909	18-2849-1
4.3L	4.3L MPI		262	6	4	2002-2004	M615000 - W309999						18-2909	
4.3L	4.3L MPI		262	6	4	2004-2010	W310000 & UP						18-2909	
4.3L	4.3L MPI / 4.3L EC		262	6	4	2010-2011	A637495 & UP			⊖			18-2909	
4.3L	4.3L MPI / 4.3L EC		262	6	4	2010-2011	A637495 & UP			⊖			18-2909	
4.3L	4.3LH GEN +		262	6	4	1998-2002	L010044 - M614999	18-1952-1	18-1952-1	18-1976-2			18-2909	18-2849-1
4.3L	4.3LH GEN +		262	6	4	1998-2002	L010044 - M614999	⊖	⊖	⊖			18-2909	
4.3L	4.3LH	4 bbl	262	6	4	1988-1996	8775130 - F802999	18-1952-1	18-1952-1	18-1976-2			18-2909	18-0897
4.3L	4.3LX GEN +	2bb	262	6	4	1996-1997	F803800 - K999999	18-1952-1	18-1952-1	18-1976-2			18-2909	18-0897
4.3L	4.3LX GEN +	2bb	262	6	4	1996-1997	F803800 - K999999	⊖	⊖	⊖			18-2909	
4.3L	4.3LXH GEN +		262	6	4	1996-1997	F803814 - K999999	18-1952-1	18-1952-1	18-1976-2			18-2909	18-0897
4.3L	4.3LXH GEN +		262	6	4	1996-1997	F803814 - K999999	⊖	⊖	⊖			18-2909	
5.0L	215		302	6	4	1970	2781153 - 3040410	18-1958-1	18-1962-1	18-1971	18-4009	18-1990	18-0183-1	18-2833
5.0L	215		302	6	4	1971-1972	3040411 - 3385720	18-1958-1	18-1962-1	18-1971	18-4009	18-4009	18-0183-1	18-2833
5.0L	215 MIE		302	6	4	1970	2781153 - 3040410	18-1958-1	18-1962-1		18-4009	18-1990	18-0183-1	18-2833
5.0L	215 MIE		302	6	4	1971-1972	3040411 - 3563181	18-1958-1	18-1962-1		18-4009	18-4009	18-0183-1	18-2833
5.0L	225	FORD	302	6	4	1973-1974	3385721 - 4166999	18-1958-1	18-1962-1	18-1971	18-4009	18-4009	18-0183-1	18-2833
5.0L	225 MIE	FORD	302	6	4	1973-1974	3385721 - 4176999	18-1958-1	18-1962-1		18-4009	18-4009	18-0183-1	18-2833
5.0L	888		302	6	4	1971-1977	3108723 - 4867829	18-1958-1	18-1962-1	18-1971	18-4009	18-4009	18-0183-1	18-2833

- ⊖ For engines with aluminum exhaust manifolds
- ⊖ For engines with cast iron exhaust manifolds
- ⊖ 3" (76mm) O.D. & 0 degree down angle
- ⊖ 4" (102mm) O.D. & 15 degree down angle
- ⊖ 2 piece exhaust manifold
- ⊖ 1 piece exhaust manifold
- ⊖ Has a rectangular elbow mounting bolt pattern
- ⊖ Has a square elbow mounting bolt pattern

- ⊖ In-line applications
- ⊖ V-drive applications
- ⊖ Standard rise
- ⊖ 2" (51mm) rise
- ⊖ 3" (76mm) rise
- ⊖ 4" (102mm) rise
- ⊖ Port
- ⊖ Starboard
- ⊖ Engines with risers or closed cooling may require a different gasket than listed

- ⊖ Exhaust manifold with external water rail
- ⊖ Exhaust manifold w/o external water rail
- ⊖ 1 piece exhaust manifold is n/a. Engine must be converted to the 2 piece exhaust system
- ⊖ Engines with easy drain system
- ⊖ Engines with multi-point drain system
- ⊖ Intermediate collector housing

MANIFOLD/MANIFOLD GASKET APPLICATION (Cont.)

Liter	Model	Note	CID	# Cyl.	Stroke	Year Range	Serial # Range	Exh. Manifold Port	Exh. Manifold Starboard	Exh. Elbow	End Cap Front	End Cap Rear	Manifold Gasket	Exh. Elbow Gasket
	190		283	B	4	1963-1964	1564539 - 1730903						18-2949	
5.0L	198 MIE		305	B	4	1977	4776402 - 4931099	●	●	●	18-4005	18-4009	18-2949	18-0885-1
5.0L	198 MIE		305	B	4	1977	4776402 - 4931099	18-1950-1 ●	18-1951-1 ●	●	18-4005	18-4009	18-2949	18-2833
5.0L	200		305	B	4	1985-1987	6899058 - B525981	18-1953-2	18-1953-2	18-1970-2 ●			18-2949	18-0897
5.0L	200		305	B	4	1985-1987	6899058 - B525981	18-1953-2	18-1953-2	18-1976-2 ●			18-2949	18-0897
5.0L	200		305	B	4	1987	B525982 - B774444	18-1953-2	18-1953-2	18-1976-2			18-2949	18-0897
5.0L	228		305	B	4	1977	4765100 - 4888929				18-4009	18-4009	18-2949	18-0885-1
5.0L	228		305	B	4	1977-1982	4888930 - 6218461	18-1950-1	18-1951-1	18-1971	18-4009	18-4009	18-2949	18-2833
5.0L	228		305	B	4	1983-1984	6218462 - 6899058	18-1953-2	18-1953-2	18-1970-2 ●			18-2949	18-0897
5.0L	228		305	B	4	1983-1984	6218462 - 6899058	18-1953-2	18-1953-2	18-1976-2 ●			18-2949	18-0897
5.0L	228 TR		305	B	4	1977-1978	4888930 - 5170008	18-1950-1	18-1951-1	18-1971	18-4009	18-4009	18-2949	18-2833
5.0L	228 TR		305	B	4	1977-1978	4888930 - 5170008	18-1950-1	18-1951-1	18-1971	18-4009	18-4009	18-2949	18-2833
5.0L	228 MIE		305	B	4	1977	4765100 - 4888929				18-4009	18-4009	18-2949	18-0885-1
5.0L	228 MIE		305	B	4	1977-1980	4888930 - 5907057	18-1950-1	18-1951-1		18-4009	18-4009	18-2949	18-2833
5.0L	230		305	B	4	1985-1987	6899269 - B525981	18-1953-2	18-1953-2	18-1970-2 ●			18-2949	18-0897
5.0L	230		305	B	4	1985-1987	6899269 - B525981	18-1953-2	18-1953-2	18-1976-2 ●			18-2949	18-0897
5.0L	230		305	B	4	1987	B525982 - B773739	18-1953-2	18-1953-2	18-1976-2			18-2949	18-0897
5.0L	230 MIE		305	B	4	1981-1987	5907058 - B788151	18-1953-2	18-1953-2	18-1974-1 ●			18-2949	18-0897
5.0L	230 MIE		305	B	4	1981-1987	5907058 - B788151	18-1953-2	18-1953-2	18-1970-2 ●			18-2949	18-0897
5.0L	230 MIE		305	B	4	1981-1987	5907058 - B788151	18-1953-2	18-1953-2	18-1976-2 ●			18-2949	18-0897
5.0L	5.0L		305	B	4	1988-1995	B774445 - F600999	18-1953-2	18-1953-2	18-1976-2			18-2949	18-0897
5.0L	5.0L GEN +		305	B	4	1988-2002	L015751 - M599999	18-1953-2	18-1953-2	18-1976-2			18-2949	
5.0L	5.0L GEN +		305	B	4	1988-2002	M600000 - W309999						18-2949	
5.0L	5.0L GEN +		305	B	4	2004-2010	W310000 & LP						18-2949	
5.0L	5.0L EFI GEN +		305	B	4	1998-2001	L012052 - M299999	18-1953-2	18-1953-2	18-1976-2			18-2949	18-2949-1
5.0L	5.0L MIE		305	B	4	1988	B788152 - C398832	18-1953-2	18-1953-2	18-1976-2			18-2949	18-0897
5.0L	5.0L MPI		305	B	4	2002	M300000 - M599999	18-1953-2	18-1953-2	18-1976-2			18-2949	18-0897
5.0L	5.0L MPI		305	B	4	2002-2004	M600000 - W309999						18-2949	
5.0L	5.0L MPI		305	B	4	2004-2010	W310000 & LP						18-2949	
5.0L	5.0LX		305	B	4	1988-1995	B773740 - F600900	18-1953-2	18-1953-2	18-1976-2			18-2949	18-0897
5.0L	898		305	B	4	1977-1982	4762210 - 6218461	●	●	●	18-4009	18-4009	18-2949	18-0885-1
5.0L	898		305	B	4	1977-1982	4762210 - 6218461	18-1950-1 ●	18-1951-1 ●	●	18-4009	18-4009	18-2949	18-2833
5.0L	898		305	B	4	1983-1984	6218462 - 6899057	18-1953-2	18-1953-2	18-1970-2			18-2949	18-0897
5.0L	898		305	B	4	1983-1984	6218462 - 6899057	18-1953-2	18-1953-2	18-1976-2 ●			18-2949	18-0897
	225	GM	327	B	4	1963-1968	1539620 - 2399397						18-2949	
	225	GM	327	B	4	1968-1969	2399398 - 2694014				18-4009	18-1990	18-2949	18-0885-1
	225 MIE	GM	327	B	4	1968	2278647 - 2399307						18-2949	
	225 MIE	GM	327	B	4	1968-1969	2399398 - 2694014				18-4009	18-1990	18-2949	18-0885-1
	250		327	B	4	1968-1969	2314301 - 2639854				18-4009	18-1990	18-2949	18-0885-1
	250 MIE		327	B	4	1968-1969	2314301 - 2639854				18-4009	18-1990	18-2949	18-0885-1
5.7L	250		350	B	4	1977	4768000 - 4908849	●	●	●	18-4009	18-4009	18-2949	18-0885-1
5.7L	250		350	B	4	1977	4768000 - 4908849	18-1950-1 ●	18-1951-1 ●	18-1971 ●	18-4009	18-4009	18-2949	18-2833
5.7L	255	GM	350	B	4	1975-1976	4175500 - 4499050				18-4009	18-1990	18-2949	18-0885-1
5.7L	255	GM	350	B	4	1976	4499061 - 4767999	18-1950-1	18-1951-1	18-1971	18-4009	18-4009	18-2949	18-2833
5.7L	255 MIE	GM	350	B	4	1975-1976	4175500 - 4499050				18-4009	18-1990	18-2949	18-0885-1
5.7L	255 MIE	GM	350	B	4	1976-1980	4499061 - 5907057	18-1950-1	18-1951-1		18-4009	18-4009	18-2949	18-2833
5.7L	260		350	B	4	1978-1982	4908850 - 6218461	18-1950-1	18-1951-1	18-1971	18-4009	18-4009	18-2949	18-2833
5.7L	260		350	B	4	1983-1987	6218462 - B773304	18-1953-2	18-1953-2	18-1976-2 ●			18-2949	18-0897
5.7L	260		350	B	4	1983-1987	6218462 - B773304	18-1953-2	18-1953-2	18-1976-2 ●			18-2949	18-0897
5.7L	260 MIE		350	B	4	1981-1987	5907058 - B788151	18-1953-2	18-1953-2	18-1974-1 ●			18-2949	18-0897
5.7L	260 MIE		350	B	4	1981-1987	5907058 - B788151	18-1953-2	18-1953-2	18-1970-2 ●			18-2949	18-0897
5.7L	260 MIE		350	B	4	1981-1987	5907058 - B788151	18-1953-2	18-1953-2	18-1976-2 ●			18-2949	18-0897

- For engines with aluminum exhaust manifolds
- For engines with cast iron exhaust manifolds
- 3" (76mm) O.D. & 0 degree down angle
- 3" (76mm) O.D. & 15 degree down angle
- 4" (102mm) O.D.
- 2 piece exhaust manifold
- 1 piece exhaust manifold
- Has a rectangular elbow mounting bolt pattern
- Has a square elbow mounting bolt pattern

- In-line applications
- V-drive applications
- Standard rise
- 1/2" (51mm) rise
- 3/4" (76mm) rise
- 1" (152mm) rise
- Port
- Starboard
- Engines with risers or closed cooling may require a different gasket than listed

- Exhaust manifold with external water rail
- Exhaust manifold w/o external water rail
- 1 piece exhaust manifold is n/a. Engine must be converted to the 2 piece exhaust system
- Engines with easy drain system
- Engines with multi-point drain system
- Intermediate collector housing

MANIFOLD/MANIFOLD GASKET APPLICATION (Cont.)

liter	Model	Note	CID	# Cyl.	Stroke	Year Range	Serial # Range	Exh. Manifold Port	Exh. Manifold Starboard	Exh. Elbow	End Cap Front	End Cap Rear	Manifold Gasket	Exh. Elbow Gasket
5.7L	270		350	8	4	1969-1972	2851074 - 3365720				18-4009	18-1090	18-2949	18-0885-1
5.7L	270 MIE		350	8	4	1969-1972	2851074 - 3077735				18-4005	18-1990	18-2948	18-0885-1
5.7L	280 TRS		350	8	4	1975-1976	4176250 - 4770199	ⓐ	ⓐ	ⓐ	18-4009	18-1990	18-2949	18-0885-1
5.7L	280 TRS		350	8	4	1975-1976	4176250 - 4770199	18-1950-1 ⓐ	18-1951-1 ⓐ	ⓐ	18-4009	18-4009	18-2949	18-2833
5.7L	300		350	8	4	1985-1986	668677 - B4303367	18-1953-2	18-1953-2				18-2949	18-2849-1
5.7L	320 EFI		350	8	4	1987-1989	A543604 - D622418	18-1953-2	18-1953-2	18-1976-2			18-2949	18-0897
5.7L	350 MAG ALPHA		350	8	4	1986-1997	A635178 - K999999	18-1953-2	18-1953-2	18-1976-2			18-2949	18-0897
5.7L	350 MAG ALPHA /		350	8	4	1986-1997	F800300 - K999999	18-1953-2	18-1953-2	18-1976-2			18-2949	18-0897
	350 MAG EFI													
5.7L	350 MAG BRAVO /		350	8	4	1985	F415188 - F601999	18-1953-2	18-1953-2	18-1976-2			18-2949	18-0897
	350 MAG MPI													
5.7L	350 MAG BRAVO GEN + /		350	8	4	1986-1997	F602000 - K999999	18-1953-2	18-1953-2	18-1976-2			18-2949	18-0897
	350 MAG MPI GEN +													
5.7L	350 MAG EFI /		350	8	4	1994-1996	F215561 - F820706	18-1953-2	18-1953-2	18-1976-2			18-2949	18-0897
	350 MAG SKI													
5.7L	350 MAG EFI GEN + /		350	8	4	1996-1997	F820707 - K999999	18-1953-2	18-1953-2	18-1976-2			18-2949	18-0897
	350 MAG SKI GEN +													
5.7L	350 MAG MPI		350	8	4	1998-2001	L010019 - M298999	18-1953-2	18-1953-2	18-1976-2			18-2949	18-2849-1
5.7L	350 MAG MPI		350	8	4	2002	M300000 - M599999	18-1953-2	18-1953-2	18-1976-2			18-2949	18-0897
5.7L	350 MAG MPI		350	8	4	2002-2004	M600000 - W309999						18-2949	
5.7L	350 MAG MPI		350	8	4	2004-2010	W310000 & UP						18-2949	
5.7L	350 MAG MPI /		350	8	4	2002	M300000 - M599999	18-1953-2	18-1953-2	18-1976-2			18-2949	18-2849-1
	350 MAG HORIZON													
5.7L	350 MAG MPI /		350	8	4	2002-2004	M600000 - W309999						18-2949	
	350 MAG HORIZON													
5.7L	350 MAG MPI /		350	8	4	2004-2007	W310000 - A299999						18-2949	
	350 MAG HORIZON													
5.7L	350 MAG MPI /		350	8	4	1999-2001	L364700 - M299999	18-1953-2	18-1953-2	18-1976-2			18-2949	18-2849-1
	350 MAG HORIZON / 350 MAG MIE													
5.7L	350 MAG MPI /		350	8	4	2002	M300000 - M316999	18-1953-2	18-1953-2	18-1976-2			18-2949	18-2849-1
	350 MAG HORIZON / 350 MAG MIE													
5.7L	350 MAG MPI /		350	8	4	2002-2007	M317000 - A089999						18-2949	
	350 MAG HORIZON / 350 MAG MIE													
5.7L	350 MAG MPI /		350	8	4	1998-2001	L002008 - M299999	18-1953-2	18-1953-2	18-1976-2			18-2949	18-2849-1
	350 MAG MIE													
5.7L	350 MAG MPI		350	8	4	2002	M300000 - M316999	18-1953-2	18-1953-2	18-1976-2			18-2949	18-0897
	/ 350 MAG MIE													
5.7L	350 MAG MPI		350	8	4	2002-2007	M317000 - A089999						18-2949	
	/ 350 MAG MIE													
5.7L	350 MAG MPI		350	8	4	1995-1996	F305589 - F709999	18-1953-2	18-1953-2	18-1976-2			18-2949	
	/ 350 MAG SKI													
5.7L	350 MAG MPI GEN +		350	8	4	1998-2001	L002600 - M299999	18-1953-2	18-1953-2	18-1976-2			18-2949	18-2849-1
	/ 350 MAG SKI GEN +													
5.7L	350 MAG MPI GEN +		350	8	4	2002	M300000 - M316999	18-1953-2	18-1953-2	18-1976-2			18-2949	18-0897
	/ 350 MAG SKI GEN +													
5.7L	350 MAG MPI GEN +		350	8	4	2002-2007	M317000 - A089999			ⓐ			18-2949	18-0897
	/ 350 MAG SKI GEN +													
5.7L	350 MAG MPI GEN +		350	8	4	2002-2007	M317000 - A089999			ⓐ			18-2949	
	/ 350 MAG SKI GEN +													
5.7L	350 MAG SKI		350	8	4	1991-1997	D505450 - K999999	18-1953-2	18-1953-2	18-1976-2			18-2949	18-0897
5.7L	5.7L		350	8	4	1988-1997	B773305 - K999999	18-1953-2	18-1953-2	18-1976-2			18-2949	18-0897

- ⓐ For engines with aluminum exhaust manifolds
- ⓑ For engines with cast iron exhaust manifolds
- ⓐ 3" (76mm) O.D. & 0 degree down angle
- ⓑ 3" (76mm) O.D. & 15 degree down angle
- ⓐ 4" (102mm) O.D.
- ⓑ 2 piece exhaust manifold
- ⓐ 1 piece exhaust manifold
- ⓑ Has a rectangular elbow mounting bolt pattern
- ⓐ Has a square elbow mounting bolt pattern

- ⓐ In-line applications
- ⓑ V-drive applications
- ⓐ Standard rise
- ⓑ 3" (51mm) rise
- ⓐ 3" (76mm) rise
- ⓑ 4" (102mm) rise
- ⓐ Port
- ⓑ Starboard
- ⓐ Engines with risers or closed cooling may require a different gasket than listed

- ⓐ Exhaust manifold with external water rail
- ⓑ Exhaust manifold w/o external water rail
- ⓐ 1 piece exhaust manifold is n/a. Engine must be converted to the 2 piece exhaust system.
- ⓑ Engines with easy drain system
- ⓐ Engines with multi-point drain system
- ⓑ Intermediate collector housing

MANIFOLD/MANIFOLD GASKET APPLICATION (Cont.)

Liter	Model	Note	CID	# Cyl.	Stroke	Year Range	Serial # Range	Exh. Manifold Port	Exh. Manifold Starboard	Exh. Elbow	End Cap Front	End Cap Rear	Manifold Gasket	Exh. Elbow Gasket
5.7L	5.7L GEN +		350	B	4	1999-2002	L010037 - M599999	18-1953-2	18-1953-2	18-1976-2			18-2949	18-2949-1
5.7L	5.7L GEN +		350	B	4	2002-2004	M600000 - W309999						18-2949	
5.7L	5.7L GEN +		350	B	4	2004-2010	W310000 & UP						18-2949	
5.7L	5.7L EFI		350	B	4	1985-1997	F225560 - K999999	18-1953-2	18-1953-2	18-1976-2			18-2949	18-0897
5.7L	5.7L EFI GEN +		350	B	4	1998-2001	L010035 - M299999	18-1953-2	18-1953-2	18-1976-2			18-2949	18-2949-1
5.7L	5.7L EFI / 5.7L MIE		350	B	4	1997	K040300 - K999999	18-1953-2	18-1953-2	18-1976-2			18-2949	18-0897
5.7L	5.7L MIE		350	B	4	1988-1997	B788152 - K999999	18-1953-2	18-1953-2	18-1976-2			18-2949	18-0897
5.7L	5.7L MIE GEN +		350	B	4	1998-2002	L020203 - M316999	18-1953-2	18-1953-2	18-1976-2			18-2949	18-2949-1
5.7L	5.7L MIE GEN +		350	B	4	2002-2010	M317000 & UP						18-2949	
5.7L	5.7L MPI / 5.7L MIE		350	B	4	2008-2010	A090000 & UP						18-2949	
5.7L	5.7L MPI / 5.7L SKI		350	B	4	2008-2010	A090000 & UP			ⓐ			18-2949	
5.7L	5.7L MPI / 5.7L SKI		350	B	4	2008-2010	A090000 & UP			ⓐ			18-2949	
5.7L	5.7L SKI		350	B	4	1985-1995	A338553 - F775199	18-1953-2	18-1953-2	18-1976-2 ⓐ			18-2949	18-0897
5.7L	5.7L SKI		350	B	4	1985-1995	A338553 - F775199	18-1953-2	18-1953-2	18-1976-2 ⓐ			18-2949	18-0897
5.7L	5.7L SKI		350	B	4	1996-1997	F775200 - K999999	18-1953-2	18-1953-2	18-1976-2			18-2949	18-0897
5.7L	5.7L SKI		350	B	4	1998-2002	L020205 - M316999	18-1953-2	18-1953-2	18-1976-2			18-2949	18-2949-1
5.7L	5.7L SKI		350	B	4	2002-2010	M317000 & UP						18-2949	
5.7L	5.7LX		350	B	4	1996-1997	F601000 - K999999	18-1953-2	18-1953-2	18-1976-2			18-2949	18-0897
5.7L	5.7LX BRAVO EFI		350	B	4	1996-1997	F800300 - K999999	18-1953-2	18-1953-2	18-1976-2			18-2949	18-0897
5.7L	5.7LX EFI		350	B	4	1996-1997	F752400 - K999999	18-1953-2	18-1953-2	18-1976-2			18-2949	18-0897
5.7L	BLACK SCORPION SKI		350	B	4	1999-1997	F800000 - K999999	18-1953-2	18-1953-2	18-1976-2			18-2949	18-0897
5.7L	BLACK SCORPION SKI		350	B	4	2003-2007	M391600 - W698432			ⓐ			18-2949	
5.7L	BLACK SCORPION SKI		350	B	4	2003-2007	M391800 - W698432			ⓐ			18-2949	
5.7L	SCORPION 350		350	B	4	2008-2010	W698433 & UP			ⓐ			18-2949	
5.7L	SCORPION 350		350	B	4	2009-2010	W698433 & UP			ⓐ			18-2949	
6.2L	233		351	B	4	1975-1977	4173000 - 4902304	18-1958-1	18-1962-1	18-1971	18-4009	18-4009	18-0183-1	18-2833
6.2L	233 MIE		351	B	4	1975-1977	4173000 - 4902304	18-1958-1	18-1962-1	N.L.A.	18-4009	18-4009	18-0183-1	18-2833
6.2L	233 MIE		351	B	4	1975-1977	4173000 - 4902304	18-1958-1	18-1962-1	N.L.A.	18-1990 ⓐ	18-4009	18-0183-1	18-2833
6.2L	255	FORD	351	B	4	1973-1974	3258728 - 4175499	18-1958-1	18-1962-1	18-1971	18-4009	18-4009	18-0183-1	18-2833
6.2L	255 MIE	FORD	351	B	4	1973-1974	3258728 - 4175499	18-1958-1	18-1962-1	18-1971	18-4009	18-4009	18-0183-1	18-2833
6.2L	225 MIE	FORD	351	B	4	1973-1974	3258728 - 4175499	18-1958-1	18-1962-1	18-1971	18-1990 ⓐ	18-4009	18-0183-1	18-2833
6.2L	377 MAG		377	B	4	2008-2010	A300000 & UP						18-2949	
6.2L	377 SCORPION MCM		377	B	4	1999-2005	L416146 - M907201	18-1953-2	18-1953-2	18-1976-2			18-2949	18-2949-1
6.2L	377 SCORPION SKI		377	B	4	1997-1998	K000656 - L600314	18-1953-2	18-1953-2	18-1976-2			18-2949	18-0897
6.2L	MX 6.2L MPI		377	B	4	2000-2001	L680003 - M299999	18-1953-2	18-1953-2	18-1976-2			18-2949	18-2949-1
6.2L	MX 6.2L MPI		377	B	4	2002	M300000 - M599999	18-1953-2	18-1953-2	18-1976-2			18-2949	18-0897
6.2L	MX 6.2L MPI		377	B	4	2002-2004	M600000 - W309999						18-2949	
6.2L	MX 6.2L MPI		377	B	4	2004-2007	W310000 - A299999						18-2949	
6.2L	MX 6.2L MPI / MX 6.2L HORIZON		377	B	4	2002	M300000 - M599999	18-1953-2	18-1953-2	18-1976-2			18-2949	18-2949-1
6.2L	MX 6.2L MPI / MX 6.2L HORIZON		377	B	4	2002-2004	M600000 - W309999						18-2949	
6.2L	MX 6.2L MPI / MX 6.2L HORIZON		377	B	4	2004-2007	W310000 - A299999						18-2949	
6.2L	MX 6.2L MPI / MX 6.2L HORIZON / MX 6.2L MIE		377	B	4	2002	M300000 - M316999	18-1953-2	18-1953-2	18-1976-2			18-2949	18-2949-1
6.2L	MX 6.2L MPI / MX 6.2L HORIZON / MX 6.2L MIE		377	B	4	2002-2007	M317000 - A089999						18-2949	
6.2L	MX 6.2L MPI / MX 6.2L MIE		377	B	4	1999-2001	L670000 - M299999	18-1953-2	18-1953-2	18-1976-2			18-2949	18-2949-1
6.2L	MX 6.2L MPI / MX 6.2L MIE		377	B	4	2002	M300000 - M316999	18-1953-2	18-1953-2	18-1976-2			18-2949	18-0897
6.2L	MX 6.2L MPI / MX 6.2L MIE		377	B	4	2002-2010	M317000 & UP						18-2949	
6.2L	MX 6.2L MPI / MX 6.2L SKI		377	B	4	2002-2007	M317000 - A089999						18-2949	
6.2L	MX 6.2L MPI / MX 6.2L SKI		377	B	4	2002-2007	M317000 - A089999						18-2949	
6.2L	MX 6.2L BLACK SCORPION SKI		377	B	4	2001-2003	L670015 - M391599	18-1953-2	18-1953-2	18-1976-2			18-2949	18-2949-1

- ⓐ For engines with aluminum exhaust manifolds
- ⓑ For engines with cast iron exhaust manifolds
- ⓐ 3" (76mm) O.D. & 0 degree down angle
- ⓑ 3" (76mm) O.D. & 15 degree down angle
- ⓐ 4" (102mm) O.D.
- ⓑ 2 piece exhaust manifold
- ⓐ 1 piece exhaust manifold
- ⓐ Has a rectangular elbow mounting bolt pattern
- ⓑ Has a square elbow mounting bolt pattern

- ⓐ In-line applications
- ⓑ V-drive applications
- ⓐ Standard rise
- ⓑ 2" (51mm) rise
- ⓐ 3" (76mm) rise
- ⓑ 4" (102mm) rise
- ⓐ 6" (152mm) rise
- ⓐ Port
- ⓑ Starboard
- ⓐ Engines with risers or closed cooling may require a different gasket than listed

- ⓐ Exhaust manifold with external water rail
- ⓑ Exhaust manifold w/o external water rail
- ⓐ 1 piece exhaust manifold is n/a. Engine must be converted to the 2 piece exhaust system
- ⓑ Engines with easy drain system
- ⓐ Engines with multi-point drain system
- ⓑ Intermediate collector housing

MANIFOLD/MANIFOLD GASKET APPLICATION (Cont.)

Liter	Model	Note	CID	# Cyl.	Stroke	Year Range	Serial # Range	Exh. Manifold Port	Exh. Manifold Starboard	Exh. Elbow	End Cap Front	End Cap Rear	Manifold Gasket	Exh. Elbow Gasket
6.2L	MX 6.2L BLACK SCORPION SKI		377	8	4	2003-2007	M391600 - W698432						18-2949	
6.2L	MX 6.2L BLACK SCORPION SKI		377	8	4	2003-2007	M391600 - W698432						18-2949	
6.2L	SCORPION 377		377	8	4	2008-2010	W698433 & UP						18-2949	
6.2L	SCORPION 377		377	8	4	2008-2010	W698433 & UP						18-2949	
7.4L	325		427	8	4	1968	2278747 - 2313964							18-0418
7.4L	325		427	8	4	1968-1974	2313965 - 3760449				18-4009	18-1990	18-0418	18-0885-1
7.4L	325 MIE		427	8	4	1968	2278747 - 2313964							18-0418
7.4L	325 MIE		427	8	4	1968-1974	2313965 - 3760449				18-4009	18-1990	18-0418	18-0885-1
7.4L	330		454	8	4	1977-1981	4623115 - 6083144				18-4009	18-4009	18-0418	18-0885-1
7.4L	330		454	8	4	1982-1987	6083145 - 8816540	18-1957-2	18-1957-2	18-1976-2			18-0418	18-0897
7.4L	330		454	8	4	1982-1987	6083145 - 8816540	18-1957-2	18-1957-2	18-1976-2			18-0418	18-0897
7.4L	330 MIE		454	8	4	1977-1981	4623115 - 6083144				18-4009	18-4009	18-0418	18-0885-1
7.4L	340 MIE W/BW		454	8	4	1981-1987	5889914 - B788365	18-1957-2	18-1957-2	18-1974-1			18-0418	18-0897
7.4L	340 MIE W/BW		454	8	4	1981-1987	5889914 - B788365	18-1957-2	18-1957-2	18-1970-2			18-0418	18-0897
7.4L	340 MIE W/BW		454	8	4	1981-1987	5889914 - B788365	18-1957-2	18-1957-2	18-1976-2			18-0418	18-0897
7.4L	350 MIE		454	8	4	1974-1975	3780450 - 4501640				18-4009	18-1990	18-0418	18-0885-1
7.4L	350 MIE		454	8	4	1976	4501641 - 4623109				18-4009	18-4009	18-0418	18-0885-1
7.4L	370 TRS		454	8	4	1978-1985	4179554 - 8721527				18-4009	18-1990	18-0418	18-0885-1
7.4L	370 TRS		454	8	4	1985-1987	6721528 - 8714586	18-1957-2	18-1957-2	18-1976-2			18-0418	18-2849-1
7.4L	400 TRS		454	8	4	1980-1986	4179554 - B457644				18-4009	18-1990	18-0418	18-0885-1
7.4L	420		454	8	4	1987-1989	A398941 - B622418						18-0418	
7.4L	425		454	8	4	1990-1992	G398941 - D837011						18-0418	
7.4L	440 TRS		454	8	4	1983-1986	4179554 - B465220						18-0418	
7.4L	450		454	8	4	1985-1996	F347100 - F347277			ⓐ			18-0418	
7.4L	450		454	8	4	1995-1996	F347100 - F347277			ⓑ			18-0418	
7.4L	450		454	8	4	1995-1996	F347100 - F347277			ⓒ			18-0418	
7.4L	454 MAG ALPHA		454	8	4	1986-1988	A631894 - B785148	18-1957-2	18-1957-2	18-1976-2			18-0418	18-0897
7.4L	454 MAG BRAVO		454	8	4	1988-1987	B721206 - K999999	18-1957-2	18-1957-2	18-1976-2			18-0418	18-0897
7.4L	454 MAG EFI		454	8	4	1994-1996	F115700 - F802349	18-1957-2	18-1957-2	18-1976-2			18-0418	18-0897
7.4L	454 MAG EFI / 454 MAG SKI		454	8	4	1995-1996	F215800 - F820089	18-1957-2	18-1957-2	18-1976-2			18-0418	18-0897
7.4L	454 MAG MPI		454	8	4	1996-1997	F802350 - K999999	18-1957-2	18-1957-2	18-1976-2			18-0418	18-0897
7.4L	454 MAG MPI		454	8	4	1999-2001	L010029 - M0224999	18-1957-2	18-1957-2	18-1976-2			18-0418	18-2849-1
7.4L	454 MAG MPI / 454 MAG HORIZON / 454 MAG MIE		454	8	4	1999-2001	L086050 - L674000	18-1957-2	18-1957-2	18-1976-2			18-0418	18-2849-1
7.4L	454 MAG MPI / 454 MAG SKI		454	8	4	1996-1997	F820100 - K999999	18-1957-2	18-1957-2	18-1976-2			18-0418	18-0897
7.4L	525 SC W/BRAVO		454	8	4	1991-1996	D456000 - F877734			ⓓ			18-0418	
7.4L	525 SC W/BRAVO		454	8	4	1991-1996	D456000 - F877734			ⓔ			18-0418	
7.4L	525 SC W/BRAVO		454	8	4	1991-1996	D456000 - F877734			ⓕ			18-0418	
7.4L	525 SC W/SSM		454	8	4	1991-1996	D456000 - F877734			ⓖ			18-0418	
7.4L	525 SC W/SSM		454	8	4	1991-1996	D456000 - F877734			ⓗ			18-0418	
7.4L	525 SC W/SSM		454	8	4	1991-1996	D456000 - F877734			ⓓ			18-0418	
7.4L	7.4L BRAVO		454	8	4	1988-1997	B771113 - K999999	18-1957-2	18-1957-2	18-1976-2			18-0418	18-0897
7.4L	7.4L EFI / 7.4L MIE		454	8	4	1996-1997	F574615 - K999999	18-1957-2	18-1957-2	18-1976-2			18-0418	18-0897
7.4L	7.4L MIE W/BW		454	8	4	1988-1992	B788366 - D715493	18-1957-2	18-1957-2	18-1974-1	ⓓ		18-0418	18-0897
7.4L	7.4L MIE W/BW		454	8	4	1988-1992	B788366 - D715493	18-1957-2	18-1957-2	18-1970-2	ⓔ		18-0418	18-0897
7.4L	7.4L MIE W/BW		454	8	4	1988-1992	B788366 - D715493	18-1957-2	18-1957-2	18-1976-2	ⓕ		18-0418	18-0897
7.4L	7.4L MIE W/HURTH		454	8	4	1989-1992	C391564 - D715493	18-1957-2	18-1957-2	18-1976-2			18-0418	18-0897
7.4L	7.4L MIE		454	8	4	1992-1997	D715494 - K999999	18-1957-2	18-1957-2	18-1976-2			18-0418	18-0897
7.4L	7.4L MPI		454	8	4	1998-2001	L010003 - M024330	18-1957-2	18-1957-2	18-1976-2			18-0418	18-2849-1
7.4L	7.4L MPI / 7.4L MIE		454	8	4	1995-1997	F563052 - K999999	18-1957-2	18-1957-2	18-1976-2			18-0418	18-0897
7.4L	7.4L MPI / 7.4L MIE		454	8	4	1998-2001	L002006 - L574613	18-1957-2	18-1957-2	18-1976-2			18-0418	18-2849-1

- ⓐ For engines with aluminum exhaust manifolds
- ⓑ For engines with cast iron exhaust manifolds
- ⓒ 3" (76mm) O.D. & 0 degree down angle
- ⓓ 3" (76mm) O.D. & 15 degree down angle
- ⓔ 4" (102mm) O.D.
- ⓕ 2 piece exhaust manifold
- ⓖ 1 piece exhaust manifold
- ⓗ Has a rectangular elbow mounting bolt pattern
- ⓓ Has a square elbow mounting bolt pattern

- ⓐ In-line applications
- ⓑ V-drive applications
- ⓒ Standard rise
- ⓓ 2" (51mm) rise
- ⓔ 3" (76mm) rise
- ⓕ 6" (152mm) rise
- ⓖ Port
- ⓗ Starboard
- ⓓ Engines with risers or closed cooling may require a different gasket than listed

- ⓐ Exhaust manifold with external water rail
- ⓑ Exhaust manifold w/o external water rail
- ⓒ 1 piece exhaust manifold in line. Engine must be converted to the 2 piece exhaust system
- ⓓ Engines with easy drain system
- ⓔ Engines with multi-point drain system
- ⓕ Intermediate collector housing

MANIFOLD/MANIFOLD GASKET APPLICATION (Cont.)

Liter	Model	Note	CID	# Cyl.	Stroke	Year Range	Serial # Range	Exh. Manifold Port	Exh. Manifold Starboard	Exh. Elbow	End Cap Front	End Cap Rear	Manifold Gasket	Exh. Elbow Gasket
7.4L	7.4LX BRAVO EFI		454	8	4	1996-1997	F82000 - K999999	18-1957-2	18-1957-2	18-1976-2			18-0418	18-0897
7.4L	7.4LX BRAVO MPI		454	8	4	1996-1997	F602010 - K999999	18-1957-2	18-1957-2	18-1976-2			18-0418	18-0897
	390 MCM / 390 MIE		482	8	4	1969-1970	2761129 - 3042731				18-1990	18-1990	18-0418	18-0885-1
	496 MAG / 496 HO		496	8	4	2001-2003	M025000 - M687143		③	②			18-0418	
	496 MAG / 496 HO		496	8	4	2001-2010	M0225000 & UP		④	②			18-0418	
	8.1S / 8.1 HO / 8.1 MIE		496	8	4	2001-2003	M026000 - M319190		③	②			18-0418	
	8.1S / 8.1 HO / 8.1 MIE		496	8	4	2001-2010	M026000 & UP		④	②			18-0418	
8.2L	465		502	8	4	1996-1994	C849992 - F213244			②			18-0418	
8.2L	465		502	8	4	1990-1994	C849992 - F213244			③			18-0418	
8.2L	465		502	8	4	1990-1994	C849992 - F213244			⑤			18-0418	
8.2L	500 BRAVO		502	8	4	1994-1998	F213293 - L001772			②			18-0418	
8.2L	500 BRAVO		502	8	4	1994-1998	F213293 - L001772			④			18-0418	
8.2L	500 BRAVO		502	8	4	1994-1998	F213293 - L001772			⑤			18-0418	
8.2L	500 GEN +		502	8	4	1999	L414639 - L601036			②			18-0418	
8.2L	500 GEN +		502	8	4	1999	L414639 - L601036			④			18-0418	
8.2L	500 GEN +		502	8	4	1999	L414639 - L601036			⑤			18-0418	
8.2L	502 MAG BRAVO		502	8	4	1990-1993	C878221 - F114528	18-1957-2	18-1957-2	18-1976-2			18-0418	18-0897
8.2L	502 MAG EFI		502	8	4	1993-1995	D840850 - F802599	18-1957-2	18-1957-2	18-1976-2			18-0418	18-0897
8.2L	502 MAG MPI		502	8	4	1996-1997	F802600 - K999999	18-1957-2	18-1957-2	18-1976-2			18-0418	18-0897
8.2L	502 MAG MPI		502	8	4	1998-2001	L017000 - M024999	18-1957-2	18-1957-2	18-1976-2			18-0418	18-2849-1
8.2L	600 SC		502	8	4	1991-1996	D456489 - F877642						18-0418	
8.2L	600 SC		502	8	4	1991-1996	D456489 - F877642						18-0418	
8.2L	8.2L MIE		502	8	4	1990-1996	C878221 - F819619	18-1957-2	18-1957-2	18-1976-2			18-0418	18-0897
8.2L	8.2L MIE / 8.2L MPI		502	8	4	1996-1997	F819620 - K999999	18-1957-2	18-1957-2	18-1976-2			18-0418	18-0897
8.2L	8.2L MIE / 8.2L MPI		502	8	4	1998-2001	L002450 - L674200	18-1957-2	18-1957-2	18-1976-2			18-0418	18-2849-1
	500 BULLDOG W/BRAVO		540	8	4	1990-1998	C577254 - L001607			②			18-0418	
	500 BULLDOG W/BRAVO		540	8	4	1990-1998	C577254 - L001607			③			18-0418	
	500 BULLDOG W/BRAVO		540	8	4	1990-1998	C577254 - L001607			⑤			18-0418	
	500 BULLDOG W/BRAVO		540	8	4	1996-2001	L414620 - M050281			②			18-0418	
	500 BULLDOG W/BRAVO		540	8	4	1999-2001	L414620 - M050281			④			18-0418	
	500 BULLDOG W/BRAVO		540	8	4	1999-2001	L414620 - M050281			⑤			18-0418	
	500 BULLDOG W/SSM		540	8	4	1996-2001	C577254 - M050281			②			18-0418	
	500 BULLDOG W/SSM		540	8	4	1996-2001	C577254 - M050281			④			18-0418	
	500 BULLDOG W/SSM		540	8	4	1996-2001	C577254 - M050281			⑤			18-0418	

- ① For engines with aluminum exhaust manifolds
- ② For engines with cast iron exhaust manifolds
- ③ 3" (76mm) O.D. & 0 degree down angle
- ④ 3" (76mm) O.D. & 15 degree down angle
- ⑤ 4" (102mm) O.D.
- ⑥ 2 piece exhaust manifold
- ⑦ 1 piece exhaust manifold
- ⑧ Has a rectangular elbow mounting bolt pattern
- ⑨ Has a square elbow mounting bolt pattern

- ⑩ In-line applications
- ⑪ V-drive applications
- ⑫ Standard riser
- ⑬ 2" (51mm) riser
- ⑭ 3" (76mm) riser
- ⑮ 6" (152mm) riser
- ⑯ Port
- ⑰ Starboard
- ⑱ Engines with risers or closed cooling may require a different gasket than listed

- ⑲ Exhaust manifold with external water rail
- ⑳ Exhaust manifold w/o external water rail
- ㉑ 1 piece exhaust manifold in rta. Engine must be converted to the 2 piece exhaust system
- ㉒ Engines with easy drain system
- ㉓ Engines with multi-point drain system
- ㉔ Intermediate collector housing



Sierra
Marine Engine and Drive Parts

Features...

- Manufactured to meet or exceed OEM specifications.
- High Efficiency Filter
- Field-tested and approved.
- Anti-drainback valves where required.



OIL FILTERS

- Ⓢ Do not use on V-6 engines equipped with remote oil filter kit
- * Display Packaged

SEE PAGES 200-202 & 1165-1190 FOR ADDITIONAL INFORMATION

Part #	O.E. #	Application
18-7824-2*	54111, 14957, 32716, 35-802885Q, 35-866340K01, 35-866340Q03, 35-866340Q02, 35-866340K01, 35-866340Q, 52731A1, 52731, 52022, 32717, 14957	GM Engines Ⓢ (Short Filter)
18-7871	35-805809, 35-805809T	D7.3L Diesel
18-7875*	80565, 35-802886Q	Ford Engines. (Long Filter)
18-7876-1*	52731, 35-16595T, 35-866340Q03, 35-866340Q02, 32-802885Q, 14957, 54111, 52731A1, 52022, 32717, 14957	GM Engines (Long Filter)
18-7878-1*	803470, 803470Q, 45692, 38463	80 & 80 HP Engines (Renault) (Short Filter)
18-7879-1*	41815, 35-802884Q, 35-883702Q, K	GM V-6 Engines

OIL PANS AND GASKET



Part No.	OE	OE No.	Application
18-0612	Mercuriser	809910, 14259	1 piece rear main seal; GM Small Block V8 (Right Handed Dipstick)
18-0613	Mercuriser	93476	2 piece rear main seal; GM Small Block V8 (Right Handed Dipstick)
18-0614	Mercuriser	845668T, 850458, 811549	1 piece rear main seal; GM Big Block V8 (Right Handed Dipstick)
18-0615	Mercuriser	93477T, 93477, 14760, 75639	2 piece rear main seal; GM Big Block V8 (Right Handed Dipstick)
18-0616	Mercuriser	14244T, 14244	1 piece rear main seal; GM V6 (Right Handed Dipstick)

Drain Plug: M12 - 1.75

CYLINDER HEAD ASSEMBLIES

All cylinder heads are new castings and complete assemblies with new- stainless steel valves, hardened steel exhaust seats, valve springs, valve locks, and retainers.
 All GM cylinder heads utilize high performance screw-in rocker arm studs in place of factory press in rocker arm studs.



**18-4486HP
CYLINDER HEAD ASSEMBLY**

Fits: Vortec GM small block 5.7L high performance
 Completely assembled with revised runner and combustion chambers.
 Add 30hp to stock motor with no additional modifications.



**18-4501HP
CYLINDER HEAD**

Fits: Vortec GM small block 5.0L
 Completely assembled with revised runner and combustion chambers.
 Add 30hp to stock motor with no additional modifications.



**18-4492
ROCKER ARM ASSEMBLY**
Replaces: 35329, F3746241, F11100014, F11100495
Fits: MCM/MIE Gm V6 & V8(283, 305 & 350 cid) engines



**18-7508
POWER STEERING PUMP**
Replaces: 16792A39, 16792A33



**18-8227
POWER STEERING PUMP PULLEY**
Replaces: 73873A1, 73873
For: Sterndrives with v-belt



**18-8297
POWER STEERING PUMP PULLEY**
Replaces: 861578
For: Sterndrives with serpentine belt



**18-1400
HYDRAULIC LIFTER**
Replaces: 17340, 17340T
GM 4.3L/V-6 Late/5.0L/5.7L



**18-1401
HYDRAULIC LIFTER**
Replaces: 56153, F724102
Ford 302/351
Ford 5.0L & 5.8L



**18-1402
HYDRAULIC LIFTER**
Replaces: 72638, 34282, 35583, 46472, 46744, 49117, F2769931, F5232670, F11100349, F11100399, F11100862, F11100954, F11101222
GM 2.5L/120
For: Mercuriser 140 (S/N 2508261-6229717), 140/3.0L (S/N 6229718-up), 3.0L/3.0LX (S/N C856559-up)

PISTONS



All pistons are supplied complete with piston rings and wrist pin.

RINGS	
STD	REPLACES
18-3928	39-74381A1, 39-75422
18-3937	39-17464, 39-65153, 39-67123, 39-34988, F328506, F3892364, F11100386, F11100692, F11101321
18-3942	39-67132, 39-67119, 39-58096, 39-34479
18-3944	39-75609, F11101057
.020	
18-3939	39-66217, 39-97125, 39-48344, F11100387, F11100780, F11101134
.030	
18-3938	39-17465, 39-67126, 39-48345, F11100694, F11101322, F328516

PISTONS	
STD	REPLACES
18-4180	736-2343, 733-66217, 733-2278
18-4161	733-3819, 733-803850T, 733-4028, 24-38191, F11100779, F11100780
18-4109	778-9441A3, 759-80661A7, 759-80661A3, 759-8312A2, 759-831210, 759-661010, 759-592010, 778-9015A2
18-4173	735-6370, 735-9686, 735-808674, 735-850097, 735-808674A1, 735-808661, 735-9703, 735-6370, F11101184, F11101318, F11101334, 833232E
.020	
18-4160	733-3818, 733-38181, F11100781
18-4189	737-6523, 737-6523, 737-879194035, F11101101
.030	
18-4134	778-9441A5, 759-80661A8, 759-806661A5, 759-9015A4, 759-8312A6, 759-831212, 759-661012, 759-592012
18-4164	735-6371, 735-9687, 735-850098, 735-9431, 735-9704, F11101185, F11101320, F11101336
18-4178	735-9715, 735-97151, 735-9715T1, F11101317
18-4191	733-3819, 733-38191, 733-803850T, 733-4028, F11100779, F11100780

PISTON/RING APPLICATION

Liter	Model	Note	CID	# Cyl	Stroke	Year	Serial #	Pistons Std.	0.02	0.03	Rings Std.	0.02	0.03	Qty. Eng.
1.6L	100 VASER		98	4	4	2007-2010	W995000 & UP	-	-	-	-	-	-	
2.5L	120		153	4	4	1964-1966	1666001 - B531853	18-4180	-	-	-	-	-	
2.5L	2.5L		153	4	4	1987-1989	B531854 - C853256	18-4190	-	-	-	-	-	
3.0L	140		181	4	4	1966-1966	2508261 - B450800	18-4161	18-4160	18-4191	18-3937	18-3939	18-3938	4
3.0L	140			4			3332138 - 5157668	18-4161	18-4160	18-4191	18-3937	18-3939	18-3938	4
3.0L	140			4			5157669 - 6229717	18-4161	18-4160	18-4191	18-3937	18-3939	18-3938	4
3.0L	140 / 3.0L			4			6229718 - C856558	18-4161	18-4160	18-4191	18-3937	18-3939	18-3938	4
3.0L	3.0L		181	4	4	1987-1989	B450801 - C856558	18-4161	18-4160	-	-	-	-	
3.0L	3.0L		181	4	4	1990-1994	C856559 - F903999	-	-	-	18-3937	18-3939	18-3938	6
3.0L	3.0L		181	4	4	1996-2010	L010042 & UP	-	-	-	-	-	-	
3.0L	3.0L MPI		181	4	4	2008-2010	A072912 & UP	-	-	-	-	-	-	
3.0L	3.0LX		181	4	4	1990-1997	C856559 - K999999	-	-	-	-	-	-	
3.7L	185 / 3.7L		224	4	4	1987-1989	B434041 - C762299	-	- (11)	18-4134	-	-	-	
3.7L	170		224	4	4	1985-1986	6916779 - B434940	18-4109	18-4118	18-4134	18-3928	18-3929	-	4
3.7L	180 / 3.7LX		224	4	4	1987-1989	B436391 - C762299	18-4109	- (11)	18-4134	-	-	-	
3.7L	190 / 3.7L		224	4	4	1985-1986	6916779 - B436390	18-4109	- (11)	18-4134	-	-	-	
3.7L	470		224	4	4	1976-1984	4208730 - 8916779	18-4109	18-4118	18-4134	18-3928	18-3929	-	4
3.7L	485		224	4	4	1980-1982	5685394 - 6218036	18-4109	- (11)	18-4134	-	-	-	
3.7L	488		224	4	4	1983-1984	6170297 - 8916778	18-4109	- (11)	18-4134	-	-	-	
	150			4			1666495 - 2048046	18-4180	18-4183	-	18-3942	-	-	6
4.1L	160		250	6	4	1987-1989	2048022 - 2770031	-	-	-	18-3942	-	-	
4.1L	165		250	6	4	1970-1981	2770032 - 5813433	-	-	-	18-3942	-	-	
4.3L	175 / 4.3L			4			B527955 - & Up	18-4173	18-4188	18-4164	18-3937	18-3939	18-3938	6
4.3L	185	Zbbf		4		1983-1984	6330183 - 6919655	-	-	-	18-3944	-	-	
4.3L	175 / 4.3L		262	6	4	1987-1992	B527955 - D714106	-	-	-	-	-	-	
4.3L	185	Zbbf	262	6	4	1985-1986	A331455 - B527954	-	-	18-4164	18-3937	18-3939	-	
4.3L	205 / 4.3LX		262	6	4	1985-1986	A331455 - B527954	-	-	18-4164	18-3937	18-3939	18-3938	
4.3L	262 MAG EFI GEN +		262	6	4	1987-1991	B527955 - D714369	18-4173	-	-	-	-	-	
4.3L	262 MAG EFI GEN +		262	6	4	1996-1997	F803800 - K999999	-	-	-	-	-	-	
4.3L	4.3L GEN II		262	6	4	1992-1996	D714107 - F802999	18-4173	18-4188	-	-	-	18-3938	6
4.3L	4.3L GEN +		262	6	4	1998-2010	L010044 & UP	-	-	-	-	-	-	
4.3L	4.3L EFI GEN +		262	6	4	1998-2001	L012009 - M299999	-	-	-	-	-	-	
4.3L	4.3L MPI		262	6	4	2002-2010	M502781 & UP	-	-	-	-	-	-	
4.3L	4.3LH GEN +		262	6	4	1998-2002	L010044 - M614289	-	-	-	-	-	-	
4.3L	4.3LX GEN II		262	6	4	1992-1996	D7141370 - F802999	-	-	18-4164	18-3937	18-3939	18-3938	6
4.3L	4.3LX GEN +		262	6	4	1996-1997	F803000 - K999999	-	-	-	-	-	-	
4.3L	4.3LXH GEN +		262	6	4	1996-1997	F803114 - K999999	-	-	-	-	-	-	
4.9L	215	FORD	302	8	4	1970-1972	2781153 - 3385720	-	-	-	18-3937	18-3939	18-3938	8
4.9L	215	FORD		4		1973-1974	3385721 - 4186999	-	-	-	18-3937	18-3939	18-3938	8
	225	GM		4			1538920 - & Up	-	-	-	18-3937	18-3939	18-3938	8
4.9L	190	GM	283	8	4	1953-1964	1564539 - 1750903	18-4180	18-4183	-	18-3942	-	-	6
5.0L	198 MIE		305	8	4	1977	4776402 - 4931099	-	-	-	-	-	-	
5.0L	200		305	8	4	1985-1987	6899056 - B525981	-	-	-	-	-	-	
5.0L	200 / 5.0L	GM	305	8	4	1987	B525982 - B774444	-	-	18-4178	18-3944	-	-	8
	200	GM		4			6218462 - & Up	-	-	-	18-3944	-	-	8
5.0L	228	GM	305	8	4	1977-1984	4765100 - 6899288	-	-	-	18-3944	-	-	8
5.0L	228 MIE		305	8	4	1977-1980	5170009 - 5907057	-	-	-	-	-	-	
5.0L	230		305	8	4	1985-1987	6899289 - B525981	-	-	-	-	-	-	
5.0L	230		305	8	4	1987-1995	B525982 - 5773739	-	-	18-4178	18-3944	-	-	8
5.0L	230 MIE	GM	305	8	4	1981-1987	5907058 - B522505	-	-	-	18-3944	-	-	8
5.0L	230 MIE		305	8	4	1987	B522506 - B788151	-	-	18-4178	18-3944	-	-	8
5.0L	230 GM			8	4		6218462 - & Up	-	-	-	18-3944	-	-	8
5.0L	5.0L		305	8	4	1988-1995	B774445 - F000999	-	-	-	-	-	-	
5.0L	5.0L GEN +		305	8	4	1998-2010	L015751 & UP	-	-	-	-	-	-	
5.0L	5.0L EFI GEN +		305	8	4	1998-2001	L012052 - M299999	-	-	-	-	-	-	

(1) Cast Aluminum (Use with GM Engine Code 1XW)

(2) Cast aluminum (Use with GM Engine Code 4XW)

(3) Forged Aluminum (Use with GM Engine Code 3UB)

(4) Cast Aluminum (Use with GM Engine Code 4XX)

(5) Cast Aluminum (Use with GM Engine Code 2XY)

(6) Cast Aluminum (Use with GM Engine Code 4XY)

(7) Flat Head

(8) Forged Aluminum, Recessed Head

(9) Starboard

(10) Port

(11) .010 (25mm) Oversize

N.L.A. No longer available from O.E. source

PISTON/RING APPLICATION

Liter	Model	Nota	CID	# Cyl	Stroke	Year	Serial #	Pistons Std.	0.02	0.03	Rings Std.	0.02	0.03	Qty. Eng.
5.0L	5.0L MIE		305	6	4	1988	B788152 - C396832	-	-	-	-	-	-	
5.0L	5.0L MPI		305	6	4	2002-2010	M300000 & LP	-	-	-	-	-	-	
5.0L	5.0LX		305	6	4	1988-1995	B773740 - F600999	-	-	-	-	-	-	
5.0L	898 / 198	GM	305	6	4	1977-1984	4762210 - 6899257	-	-	-	18-3944	-	-	8
5.4L	225 MCM / 225 MIE	GM	327	6	4	1963-1969	1539820 - 2694014	-	-	-	-	-	-	
5.4L	250 MCM - 250 MIE	GM	327	6	4	1968-1969	2314301 - 2639854	-	-	-	18-3937	18-3939	18-3938	8
5.7L	250	GM	350	6	4	1977	4768000 - 4908848	18-4173	18-4188	18-4164	18-3937	18-3939	18-3938	8
5.7L	255	GM	350	6	4	1975-1976	4175500 - 4767999	18-4173	18-4188	18-4164	18-3937	18-3939	18-3938	8
5.7L	255 MIE	GM	350	6	4	1975-1980	4175500 - 5907057	18-4173	-	-	-	-	-	8
5.7L	260	GM	350	6	4	1978-1987	4908850 - B773304	18-4173	18-4188	18-4164	18-3937	18-3939	18-3938	8
5.7L	260 MIE	GM	350	6	4	1981-1987	5907058 - B788151	18-4173	18-4188	18-4164	18-3937	18-3939	18-3938	8
5.7L	260 / 5.7L	GM	350	6	4		B523982 - & Lp	18-4173	18-4188	18-4164	18-3937	18-3939	18-3938	8
5.7L	270 MCM / 270 MIE		350	6	4	1969-1972	2861074 - 3077735	-	-	-	18-3937	18-3939	18-3938	8
5.7L	280		350	6	4	1975-1976	4176250 - 4770199	-	-	-	-	-	-	8
5.7L	300		350	6	4	1985-1988	6668677 - B430367	-	-	-	18-3937	18-3939	18-3938	8
5.7L	320 EFI		350	6	4	1987-1988	A543604 - C622418	-	-	-	18-3937	18-3939	18-3938	8
5.7L	320 GM EFI BRAVO			6	4		B157603 - & Lp	-	-	-	18-3937	18-3939	18-3938	8
	325	GM		6	4		2278747 - & Lp	-	-	-	-	-	-	8
	330	GM		6	4		4623115 - & Lp	-	18-4189	-	-	-	-	8
	330 W/B.W.	GM		6	4		6083145 - & Lp	-	18-4189	-	-	-	-	8
5.7L	350 MAG ALPHA		350	6	4	1986-1997	A635178 - K399999	18-4173	18-4188	18-4164	18-3937	18-3939	18-3938	8
5.7L	350 MAG ALPHA EFI GEN +		350	6	4	1996-1997	F803300 - K999999	-	-	-	-	-	-	8
5.7L	350 MAG BRAVO MPI		350	6	4	1995	F415189 - F601999	18-4173	-	18-4164	-	-	-	8
5.7L	350 MAG BRAVO MPI GEN +		350	6	4	1996-1997	F802000 - K999999	-	-	-	-	-	-	8
5.7L	350 MAG SKI		350	6	4	1994-1996	F215561 - F820706	18-4173	-	18-4164	-	-	-	8
5.7L	350 MAG EFI SKI GEN +		350	6	4	1996-1997	F820707 - K999999	-	-	-	-	-	-	8
5.7L	350 MAG MPI GEN +		350	6	4	1996-2010	L010019 & UP	-	-	-	-	-	-	8
5.7L	350 MAG MPI / 350 MAG HORIZON		350	6	4	2002-2007	M300000 - A299999	-	-	-	-	-	-	8
5.7L	350 MAG MPI / 350 MAG HORIZON / 350 MAG MIE		350	6	4	1998-2007	L304700 - A899999	-	-	-	-	-	-	8
5.7L	350 MAG / 350 MAG MIE / 350 MAG MPI GEN +		350	6	4	1998-2007	L002008 - A089999	-	-	-	-	-	-	8
5.7L	350 MAG MPI SKI		350	6	4	1995-1996	F350583 - F799999	18-4173	-	18-4164	-	-	-	8
5.7L	350 MAG MPI SKI GEN +		350	6	4	1998-2007	L002600 - A089999	-	-	-	-	-	-	8
5.7L	350 MAG SKI		350	6	4	1991-1997	D505450 - K999999	18-4173	18-4188	18-4164	18-3937	18-3939	18-3938	8
5.7L	350	GM	350	6	4		3780450 - & Lp	-	-	-	-	-	-	8
5.7L	350 MAG	GM	350	6	4		B523982 - & Lp	18-4173	18-4188	18-4164	18-3937	18-3939	18-3938	8
5.7L	5.7L		350	6	4	1988-1995	B773305 - F600999	18-4173	-	18-4164	-	-	-	8
5.7L	5.7L	2bbl	350	6	4	1996-1997	F601000 - K999999	18-4173	-	18-4164	-	-	-	8
5.7L	5.7L GEN +		350	6	4	1988-2010	L010037 & UP	-	-	-	-	-	-	8
5.7L	5.7L EFI		350	6	4	1995-1997	F225560 - K999999	18-4173	-	18-4164	-	-	-	8
5.7L	5.7L EFI GEN +		350	6	4	1998-2001	L010035 - M299999	-	-	-	-	-	-	8
5.7L	5.7L EFI MIE GEN +		350	6	4	1997	K040300 - K999999	-	-	-	-	-	-	8
5.7L	5.7L MIE		350	6	4	1988-1997	B788152 - K999999	18-4173	-	18-4164	-	-	-	8
5.7L	5.7L MIE GEN +		350	6	4	1998-2010	L002003 & UP	-	-	-	-	-	-	8
5.7L	5.7L MPI / 5.7L HORIZON / 5.7L MIE		350	6	4	2008-2010	A090000 & UP	-	-	-	-	-	-	8
5.7L	5.7L MPI / 5.7L MIE		350	6	4	2008-2010	A090000 & UP	-	-	-	-	-	-	8
5.7L	5.7L MPI / 5.7L SKI		350	6	4	2008-2010	A090000 & UP	-	-	-	-	-	-	8
5.7L	5.7L SKI		350	6	4	1985-1997	A338553 - K999999	18-4173	-	18-4164	-	-	-	8
5.7L	5.7L SKI GEN +		350	6	4	1998-2010	L002005 & UP	-	-	-	-	-	-	8
5.7L	5.7LX		350	6	4	1996-1997	F601000 - K999999	18-4173	-	18-4164	-	-	-	8
5.7L	5.7LX BRAVO EFI GEN +		350	6	4	1996-1997	F803300 - K999999	-	-	-	-	-	-	8
5.7L	5.7LX EFI		350	6	4	1996-1997	F752400 - K999999	18-4173	-	18-4164	-	-	-	8
5.7L	BLACK SCORPION SKI GEN +		350	6	4	1998-2007	F802000 - W6988432	-	-	-	-	-	-	8
5.7L	SCORPION 350		350	6	4	2008-2010	W698432 & UP	-	-	-	-	-	-	8
5.8L	233	FORD	361	6	4	1975-1977	4173000 - 4922304	-	-	-	-	-	-	8

- | | | |
|---|---|---|
| (1) Cast Aluminum (Use with GM Engine Code 1XW) | (5) Cast Aluminum (Use with GM Engine Code 2XY) | (9) Starboard |
| (2) Cast aluminum (Use with GM Engine Code 4XW) | (6) Cast Aluminum (Use with GM Engine Code 4XY) | (10) Port |
| (3) Forged Aluminum (Use with GM Engine Code 3UB) | (7) Flat Head | (11) .010 (25mm) Oversize |
| (4) Cast Aluminum (Use with GM Engine Code 4XX) | (8) Forged Aluminum, Recessed Head | N.L.A. No longer available from O.E. source |

PISTON/RING APPLICATION

Liter	Model	Note	CID	# Cyl	Stroke	Year	Serial #	Pistons Std.	0.02	0.03	Rings Std.	0.02	0.03	Qty. Eng.
5.8L	255	FORD	351	8	4	1973-1974	3258726 - 4175499	-	-	-	-	-	-	8
6.2L	377 MAG		377	8	4	2008-2009	A600000 - A345479	-	-	-	-	-	-	8
6.2L	377 MAG		377	8	4	2009	A345480 - A345492	-	-	-	-	-	-	8
6.2L	377 MAG		377	8	4	2009	A345493 - A345755	-	-	-	-	-	-	8
6.2L	377 MAG		377	8	4	2009	A345756 - A345757	-	-	-	-	-	-	8
6.2L	377 MAG		377	8	4	2009	A345758 - A346788	-	-	-	-	-	-	8
6.2L	377 MAG		377	8	4	2009-2010	A346790 & UP	-	-	-	-	-	-	8
6.2L	377 SCORPION STEERDRIVE		377	8	4	2000-2010	L416146 & UP	-	-	-	-	-	-	8
6.2L	377 SCORPION SKI		377	8	4	1997-1998	R000556 - L600314	-	-	-	-	-	-	8
6.2L	MX 6.2L MPI		377	8	4	2000-2007	L880003 - A299999	-	-	-	-	-	-	8
6.2L	MX 6.2L MPI / MX 6.2L MIE		377	8	4	2002-2009	M300000 - A091825	-	-	-	-	-	-	8
6.2L	MX 6.2L MPI / MX 6.2L MIE		377	8	4	2009-2010	A091826 & UP	-	-	-	-	-	-	8
6.2L	MX 6.2L MPI / MX 6.2L SKI		377	8	4	2002-2007	M517000 - W689999	-	-	-	-	-	-	8
6.2L	MX 6.2L BLACK SCORPION SKI		377	8	4	2001-2007	L570015 - W689432	-	-	-	-	-	-	8
6.2L	SCORPION 377		377	8	4	2008-2009	W689826 & UP	-	-	-	-	-	-	8
6.2L	SCORPION 377 HO / SCORPION 377 EC		377	8	4	2009-2010	A091488 - A082170	-	-	-	-	-	-	8
7.4L	325 MCM / 325 MIE		454	8	4	1969-1972	2279747 - 3780449	-	-	-	-	-	-	8
7.4L	330		454	8	4	1977-1987	4623115 - B816540	-	-	-	-	-	-	8
7.4L	330 MIE		454	8	4	1977-1980	4623115 - 5779913	-	-	-	-	-	-	8
7.4L	340 MIE		454	8	4	1991-1987	5889914 - B788365	-	18-4189	-	-	-	-	8
7.4L	350 MIE		454	8	4	1974-1976	3780450 - 4623109	-	-	-	-	-	-	8
7.4L	370 TRS		454	8	4	1978-1987	4179554 - B714586	-	-	-	-	-	-	8
7.4L	390	GM	454	8	4		2781129 - 2825059	-	-	-	-	-	-	8
7.4L	400 TRS		454	8	4	1990-1986	4179554 - B457644	-	-	-	-	-	-	8
7.4L	420		454	8	4	1987-1989	A398941 - B6222418	-	-	-	-	-	-	8
7.4L	425		454	8	4	1990-1992	B622419 - D725496	-	-	-	-	-	-	8
7.4L	425 GEN V		454	8	4	1992-1993	D725500 - D937011	-	-	-	-	-	-	8
7.4L	440 TRS		454	8	4	1983-1986	4179554 - B485220	-	-	-	-	-	-	8
7.4L	450 GEN V		454	8	4	1995-1996	F347100 - F347277	-	-	-	-	-	-	8
7.4L	454 MAG ALPHA		454	8	4	1986-1988	A631894 - B785148	-	18-4189	-	-	-	-	8
7.4L	454 MAG BRAVO		454	8	4	1988-1992	D721206 - D805066	-	-	-	-	-	-	8
7.4L	454 MAG BRAVO GEN V		454	8	4	1992-1996	D805069 - F801699	-	-	-	-	-	-	8
7.4L	454 MAG BRAVO GEN VI		454	8	4	1996-1997	F801700 - K999999	-	-	-	-	-	-	8
7.4L	454 MAG EFI GEN V		454	8	4	1994-1996	F115700 - F802349	-	-	-	-	-	-	8
7.4L	454 MAG EFI SKI GEN V		454	8	4	1995-1996	F215800 - F820099	-	-	-	-	-	-	8
7.4L	454 MAG MPI GEN VI		454	8	4	1996-2001	F802350 - M0224999	-	-	-	-	-	-	8
7.4L	454 MAG MPI / 454 MAG HORIZON / 454 MAG MIE		454	8	4	1996-2001	L002200 - L674000	-	-	-	-	-	-	8
7.4L	454 MAG MPI SKI GEN VI		454	8	4	1996-1997	F820100 - K999999	-	-	-	-	-	-	8
7.4L	454 MAG BRAVO		454	8	4		B840126 - & Up	-	-	-	-	-	-	8
7.4L	470		454	8	4		4206730 - & Up	18-4109	18-4118	18-4134	18-3928	18-3929	-	4
7.4L	485		454	8	4		5685394 - & Up	18-4109	18-4118	18-4134	18-3928	18-3929	-	4
7.4L	488		454	8	4		6170297 - & Up	18-4109	18-4118	18-4134	18-3928	18-3929	-	4
7.4L	525 SC		454	8	4	1991-1992	D456000 - D725808	-	-	-	-	-	-	8
7.4L	525 SC GEN V		454	8	4	1992-1996	D783748 - F348863	-	-	-	-	-	-	8
7.4L	525 SC GEN V		454	8	4	1996-1999	F615614 - L415623	-	-	-	-	-	-	8
7.4L	7.4L BRAVO		454	8	4	1988-1991	B771113 - D603117	-	-	-	-	-	-	8
7.4L	7.4L BRAVO I GEN V / 7.4L BRAVO II GEN V		454	8	4	1992-1995	D603118 - F900699	-(1)	-	-	-	-	-	8
7.4L	7.4L BRAVO I GEN V / 7.4L BRAVO II GEN V		454	8	4	1992-1996	D603118 - F900999	-(2)	-	-	-	-	-	8
7.4L	7.4L BRAVO III GEN V		454	8	4	1992-1995	D603118 - F900699	-(3)	-	-	-	-	-	8
7.4L	7.4L BRAVO III GEN V		454	8	4	1992-1996	D603118 - F900999	-(4)	-	-	-	-	-	8
7.4L	7.4L BRAVO GEN VI		454	8	4	1996-1997	F800700 - K999999	-	-	-	-	-	-	8
7.4L	7.4L EFI GEN VI / 7.4L MIE GEN VI / 7.4L GEN VI MIE		454	8	4	1996-1997	F874815 - K999999	-	-	-	-	-	-	8
7.4L	7.4L MIE W/HURTH		454	8	4	1988-1992	B788366 - D715493	-	-	-	-	-	-	8
7.4L	7.4L W/HURTH		454	8	4		C91584 - & Up	-	18-4189	-	-	-	-	8

(1) Cast Aluminum (Use with GM Engine Code 1XW)

(2) Cast aluminum (Use with GM Engine Code 4XW)

(3) Forged Aluminum (Use with GM Engine Code 3UB)

(4) Cast Aluminum (Use with GM Engine Code 4XX)

(5) Cast Aluminum (Use with GM Engine Code 2XY)

(6) Cast Aluminum (Use with GM Engine Code 4XY)

(7) Flat Head

(8) Forged Aluminum, Recessed Head

(9) Starboard

(10) Port

(11) .010 (25mm) Oversize

N.L.A. No longer available from O.E. source

PISTON/RING APPLICATION

Literal	Model	Nota	CID	# Cyl	Stroke	Year	Serial #	Pistons Std.	0.02	0.03	Rings Std.	0.02	0.03	Qty. Eng.
7.4L	7.4L MIE GEN V		454	8	4	1992-1995	D715494 - F820141	(5)	-	-	-	-	-	8
7.4L	7.4L MIE GEN V		454	8	4	1982-1996	D715494 - F820141	(5)	-	-	-	-	-	8
7.4L	7.4L MIE GEN VI		454	8	4	1996-1997	F820142 - K999999	-	-	-	-	-	-	8
7.4L	7.4L MPI GEN VI		454	8	4	1998-2001	L010903 - M029330	-	-	-	-	-	-	8
7.4L	7.4L MPI GEN V / 7.4L MIE GEN V		454	8	4	1995-1996	F563052 - F820103	-	-	-	-	-	-	8
7.4L	7.4L MPI GEN VI / 7.4L MIE GEN VI / 7.4LH GEN VI		454	8	4	1996-1997	F820104 - K999999	-	-	-	-	-	-	8
7.4L	7.4L MPI L-29 GEN VI / 7.4L MIE L-29 GEN VI		454	8	4	1998-2001	L002006 - M025999	-	-	-	-	-	-	8
7.4L	7.4LX BRAVO GEN VI / 7.4L BRAVO EFI		454	8	4	1996-1997	F802000 - K999999	-	-	-	-	-	-	8
7.4L	7.4LX BRAVO GEN V / 7.4L MPI GEN V		454	8	4	1996	F802010 - F801999	-	-	-	-	-	-	8
7.4L	7.4LX BRAVO GEN VI / 7.4L MPI GEN VI		454	8	4	1996-1997	F802000 - K999999	-	-	-	-	-	-	8
7.9L	390		482	6	4	1969-1970	2781129 - 2825059	-	-	-	-	-	-	8
7.9L	460 TRS		482	6	4	1983-1986	4179554 - E181046	-	-	-	-	-	-	8
8.1L	496		482	6	4	2001-2010	M025000 & LJP	(9)	-	-	-	-	-	8
8.1L	496		496	8	4	2001-2010	M025000 & LJP	(10)	-	-	-	-	-	8
8.2L	465		502	8	4	1990-1992	C849992 - D725646	-	-	-	-	-	-	8
8.2L	465 GEN V		502	8	4	1992-1994	D725647 - F213244	-	-	-	-	-	-	8
8.2L	500 GEN V		502	8	4	1994-1996	F213293 - F745159	-	-	-	-	-	-	8
8.2L	500 GEN VI		502	8	4	1997-1999	K745196 - L601036	-	-	-	-	-	-	8
8.2L	500 EFI		502	8	4	1999-2005	L001477 - M907127	-	-	-	-	-	-	8
8.2L	502 MAG BRAVO		502	8	4	1990-1992	C878221 - D824588	-	-	-	-	-	-	8
8.2L	502 MAG BRAVO GEN V		502	8	4	1992-1993	D824589 - F114528	-	-	-	-	-	-	8
8.2L	502 MAG EFI		502	8	4	1993-1996	D649650 - F802599	-	-	-	-	-	-	8
8.2L	502 MAG MPI GEN VI		502	8	4	1996-2001	F802600 - M024999	-	-	-	-	-	-	8
8.2L	525 EFI		502	8	4	2003-2010	M900148 & LJP	-	-	-	-	-	-	8
8.2L	575 Sci		502	8	4	2001-2005	L366896 - M950526	-	-	-	-	-	-	8
8.2L	600 SC		502	8	4	1991-1992	D456489 - D486768	-	-	-	-	-	-	8
8.2L	600 SC GEN V		502	8	4	1992-1996	D725676 - F877642	-	-	-	-	-	-	8
8.2L	600 SC GEN VI		502	8	4	1997-2000	K000227 - L601186	-	-	-	-	-	-	8
8.2L	8.2L MAG EC		502	8	4	2010	A350340 & LJP	-	-	-	-	-	-	8
8.2L	8.2L MIE / 8.2L EC		502	8	4	2010	A350802 & LJP	-	-	-	-	-	-	8
8.2L	8.2L MIE WILURTH		502	8	4	1990-1992	C878221 - D857199	-	-	-	-	-	-	8
8.2L	8.2L MIE GEN V		502	8	4	1993-1995	D857200 - F819619	-	-	-	-	-	-	8
8.2L	8.2L MPI GEN VI / 8.2L MIE GEN VI / 8.2LH GEN VI		502	8	4	1996-2001	F819620 - L574200	-	-	-	-	-	-	8
8.9L	920 BULLDOG		540	8	4	1990-2001	D577254 - M050281	-	-	-	-	-	-	8
8.9L	575		540	8	4	1986-1992	A677429 - D763716	(7)	-	-	18-3937	18-3939	18-3938	8

- (1) Cast Aluminum (Use with GM Engine Code 1XW)
- (2) Cast aluminum (Use with GM Engine Code 4XW)
- (3) Forged Aluminum (Use with GM Engine Code 3UB)
- (4) Cast Aluminum (Use with GM Engine Code 4XX)
- (5) Cast Aluminum (Use with GM Engine Code 2XY)
- (6) Cast Aluminum (Use with GM Engine Code 4XY)
- (7) Flat Head
- (8) Forged Aluminum, Recessed Head
- (9) Starboard
- (10) Port
- (11) .010 (25mm) Oversize
N.L.A. No longer available from O.E. source



ROD BEARINGS
(Sold individually, 1 per rod)

Part No.	Size	Replaces:
18-1148	Std.	168704A1, 23-853853, 23-853853A1, 23-853853002
18-1308	Std.	23-85701, 23-15961, 23-52221, 23-52270, F3910555, F3916351, F1100305, F1100570
18-1309	0.01	23-85704, 23-52224, 23-52273, 23-1596110, F1100381, F1100573
18-1327	Std.	23-11992, 23-11992001
18-1329	Std.	23-85677, 23-52242, 23-48351
18-1333	0.01	23-85691, 23-69887, 23-49171
18-1334	Std.	23-85726, 23-85726001, 23-49168, 23-69884, F1100980
18-1337	0.01	23-811858, 23-811858001
18-1341	0.02	23-85705, 23-1596120, 23-52225, 23-52274, F1100382

MAIN BEARINGS

Part No.	Per Eng.	Size	Replaces:
18-1131	4	0.010	74313A4
18-1137	1	0.020	15103-A3
18-1311	1	Std.	23-801793
18-1317	1	Std.	23-818469, 23-818469001, 23-34464, 23-85669, 23-85715, 23-52261,
18-1320	1	0.010	23-801803

CAM BEARINGS



Part No.	Per Eng.	Replaces:
18-1305	1	23-85684
18-1340	5	23-67484

Ⓢ Complete engine set
Ⓣ Priced per piece. Add -9 to order priced per package.

BEARING APPLICATION

HP	Liter	Model	Note	CID	# Cyl	Stroke	Year	Serial #	Rod Bearing			Main Bearing			
									Std.	0.01	0.02	Std.	0.01	0.02	Cam Bearing
100		100 VASER		98	4	4	2007-2010	W995000 & UP	-	-	-	-	-	-	-
120		120		153	4	4	1964-1986	1666001 - B531853	18-1329	-	-	-	-	-	-
126	2.5L	1200.5L		153	4	4	1967-1989	B531854 - C853255	18-1329	18-1330	-	18-1317	-	-	-
140		140		181	4	4	1968-1986	2508261 - B450800	18-1308	18-1309	18-1341	18-1317	-	-	18-1331
140		140		181	4	4		3462908 - B157668	18-1308	18-1309	18-1341	18-1317	-	-	-
140		140		181	4	4		5157669 - 6229717	18-1308	18-1309	18-1341	18-1317	-	-	-
140	3.0L	140 / 3.0L		181	4	4		6229718 & Up	18-1308	18-1309	18-1341	18-1317	-	-	-
	3.0L	3.0L		161	4	4	1987-1989	B450801 - C856556	18-1308	-	-	-	-	-	-
	3.0L	3.0L		181	4	4	1990-1994	C856559 - F803999	18-1308	18-1309	18-1341	18-1317	-	-	-
	3.0L	3.0L		181	4	4	1996-1999	L010042 - L605541	18-1308	-	-	-	-	-	-
	3.0L	3.0L		181	4	4	2000-2010	L605542 & UP	-	-	-	-	-	-	-
	3.0L	3.0L MPI		181	4	4	2008-2010	A67282 & UP	-	-	-	-	-	-	-
	3.0L	3.0LX		181	4	4	1990-1997	C856558 - K999999	18-1308	-	18-1341	-	-	-	-
		165		224	4	4	1987	B434941 - B774251	-	-	-	-	-	-	-
		170		224	4	4	1985-1986	B916779 - B434940	-	-	-	-	-	-	-
		180		224	4	4	1987	B436391 - B775248	-	-	-	-	-	-	-
		190		224	4	4	1985-1986	B916778 - B436390	-	-	-	-	-	-	-
	3.7L	3.7L		224	4	4	1986-1989	B774252 - C762299	-	-	-	-	-	-	-
	3.7L	3.7LX		224	4	4	1988-1989	B775249 - C762299	-	-	-	-	-	-	-
		470		224	4	4	1976-1984	4206730 - 6916778	-	-	-	-	-	-	-
		485		224	4	4	1980-1982	5685394 - 8218030	-	-	-	-	-	-	-
		488		224	4	4	1983-1984	6170297 - 6916778	-	-	-	-	-	-	-
		140		6	4			1536930 - 1725980	18-1329	18-1330	-	-	-	-	-
		150			4			1666495 - 2048046	18-1329	18-1330	-	-	-	-	-
		160		250	6	4	1967-1969	2048022 - Z770031	18-1329	18-1330	-	-	18-1320	-	-
		165		250	6	4	1970-1981	Z770032 - 5813433	18-1329	18-1330	-	-	18-1320	-	-
4.3L		175 / 4.3L		262	6	4		B527955 & Up	18-1327	18-1337	18-1338	18-1311	-	-	-
		185	4bbl	229	6	4	1983-1984	6330183 - 6819655	-	-	-	-	-	-	-
		175		262	6	4	1987	B527955 - B773242	-	-	-	-	-	-	-
		185	2bbl	262	6	4	1985-1986	A331455 - B527954	-	-	-	-	-	-	-
		205		262	6	4	1985-1986	A331455 - B527954	-	-	-	-	-	-	-
4.3L		262 MAG / 262 EFI / 262 GEN +		262	6	4	1996-1997	F803800 - K999999	-	-	-	-	-	-	-
4.3L		4.3L GEN II		262	6	4	1992-1996	D714107 - F802999	18-1327	18-1337	18-1338	18-1311	-	-	-
4.3L		4.3L GEN +		262	6	4	1998-2010	L010044 & UP	-	-	-	-	-	-	-
4.3L		4.3L EFI / 4.3L GEN +		262	6	4	1998-2001	L012009 - M298099	-	-	-	-	-	-	-
4.3L		4.3L MPI		262	6	4	2002-2010	M300000 & UP	-	-	-	-	-	-	-
4.3L		4.3LH GEN +		262	6	4	1996-2002	L010044 - M614999	-	-	-	-	-	-	-
4.3L		4.3LX		262	6	4	1988-1991	B775130 - D714369	-	-	-	-	-	-	-
4.3L		4.3LX GEN II		262	6	4	1992-1996	D714370 - F802999	-	-	-	-	-	-	-
4.3L		4.3LX GEN +		262	6	4	1996-1997	F803000 - K999999	-	-	-	-	-	-	-
4.3L		4.3LXH GEN +		262	6	4	1996-1997	F803114 - K999999	-	-	-	-	-	-	-
		185		262	6	4		A331455 & Up	18-1327	18-1337	18-1338	18-1311	-	-	-
		205		262	6	4		A331455 & Up	18-1327	18-1337	18-1338	18-1311	-	-	-
4.3L		209 / 4.3L / 4.3LX LX		262	6	4		B527955 & Up	18-1327	18-1337	18-1338	18-1311	-	-	-
		4.3LX GEN II		262	6	4		D714370 & Up	18-1327	18-1337	18-1338	18-1311	-	-	-
		190	GM	283	6	4	1963-1964	1564539 - 1730603	18-1329	18-1330	-	-	-	-	-
		200						2463769 - 2712072	18-1308	18-1309	18-1341	18-1317	-	-	-
		200	GM					6216462 & Up	18-1308	18-1309	18-1341	-	-	-	-
	5.0L	500			6	4		B525962 & Up	18-1308	18-1309	18-1341	-	-	-	-
5.0L		215	FORD	302	6	4		2781153 - 3395720	18-1336	-	-	-	-	-	-
5.0L		225	FORD	302	6	4	1973-1974	3385721 - 4166899	18-1329	18-1330	-	-	-	-	-
5.0L		225 S	FORD	302	6	4	1973-1974	3385721 - 4166899	-	-	-	-	-	-	-
5.0L		225	GM		6	4		1536920 - 2278646	18-1329	18-1330	-	-	-	-	-
5.0L		225	GM		6	4		2278647 - 2399397	18-1329	18-1330	-	18-1317	-	-	-
5.0L		225	GM		6	4		2399398 & Up	18-1308	18-1309	18-1341	-	-	-	-
5.0L		225	GM		6	4		4765100 & Up	18-1308	18-1309	18-1341	-	-	-	-

CHART CONTINUED ON NEXT PAGE

BEARING APPLICATION

HP	Liter	Model	Note	CID	# Cyl	Stroke	Year	Serial #	Rod Bearing			Main Bearing			
									Std.	0.01	0.02	Std.	0.01	0.02	Cam Bearing
	5.0L	888		302	4	4	1971-1977	3108723 - 4887829	-	-	-	-	-	-	-
		190		283	4	4	1963-1964	1564539 - 1730903	18-1329	-	-	-	-	-	-
	5.0L	198 MIE		305	4	4	1977	4775402 - 4931099	18-1308	-	-	-	-	-	-
	5.0L	200		305	4	4	1985-1987	6899058 - B774444	18-1308	-	-	-	-	-	-
	5.0L	228		305	4	4	1977-1984	4785100 - 6899268	18-1308	-	-	-	-	-	-
	5.0L	228 MIE		305	4	4	1977-1980	4785100 - 5907057	18-1308	-	-	-	-	-	-
	5.0L	230		305	4	4	1985-1987	6899269 - B773739	18-1308	-	-	-	-	-	-
	5.0L	230	GM	305	4	4	1981-1987	5907058 - B788151	18-1308	18-1309	18-1341	-	-	-	-
	5.0L	5.0L		305	4	4	1988-1995	B774445 - F800999	18-1308	-	-	-	-	-	-
	5.0L	5.0L GEN +		305	4	4	1988-2010	L015751 & UP	18-1308	-	-	-	-	-	-
	5.0L	5.0L EFI GEN +		305	4	4	1998-2001	L012052 - M299999	18-1308	-	-	-	-	-	-
	5.0L	5.0L MIE		305	4	4	1988	B788152 - C396882	18-1308	-	-	-	-	-	-
	5.0L	5.0L MPI		305	4	4	2002-2010	M3000000 & UP	18-1308	-	-	-	-	-	-
	5.0L	5.0LX		305	4	4	1988-1995	B773740 - F600999	18-1308	-	-	-	-	-	-
	5.0L	230 / 5.0L	GM	305	4	4		B52506 & Up	18-1308	18-1309	18-1341	-	-	-	-
		230	GM		4	4		6218462 & Up	18-1308	18-1309	18-1341	-	-	-	-
	5.0L	230 / 5.0L / 5.0LX	GM	305	4	4		B525982 & Up	18-1308	18-1309	18-1341	-	-	-	-
	5.0L	898		305	4	4	1977-1984	4762210 - 6899057	18-1308	-	-	-	-	-	-
		225	GM	327	4	4	1963-1967	1530620 - 2389397	18-1329	-	-	-	-	-	-
		225	GM	327	4	4	1968-1969	2399398 - 2594014	18-1308	-	-	-	-	-	-
		250		327	4	4	1968-1969	2314301 - 2639854	18-1308	18-1309	18-1341	-	-	-	-
	5.7L	250		350	4	4	1977	4768000 - 4908648	18-1308	18-1309	18-1341	-	-	-	-
	5.7L	255	GM	350	4	4	1875-1976	4175500 - 4767999	18-1308	18-1309	18-1341	-	-	-	-
	5.7L	255 MIE		350	4	4	1975-1980	4175500 - 5907057	18-1308	-	-	-	-	-	-
	5.7L	260	GM	350	4	4	1878-1987	4908850 - B773304	18-1308	18-1309	18-1341	-	-	-	-
	5.7L	260 MIE		350	4	4	1981-1987	5907058 - B788151	18-1308	18-1309	18-1341	-	-	-	-
	5.7L	260 / 5.7L	GM	350	4	4		B525982 & Up	18-1308	18-1309	18-1341	-	-	-	-
	5.7L	260 / 5.7L	GM	350	4	4		B525206 & Up	18-1308	18-1309	18-1341	-	-	-	-
	5.7L	270	GM	350	4	4	1968-1972	2851074 - 3077736	18-1308	18-1309	18-1341	-	-	-	-
	5.7L	280	GM	350	4	4	1975-1976	4176250 - 4770196	18-1308	18-1309	18-1341	-	-	-	-
	5.7L	300	GM	350	4	4	1985-1986	6668677 - E430367	18-1308	18-1309	18-1341	-	-	-	-
	5.7L	320 EFI	GM	350	4	4	1987-1989	A543604 - C622418	18-1308	18-1309	18-1341	-	-	-	-
	5.7L	320 EFI BRAVO	GM	350	4	4		B157603 & Up	18-1308	18-1309	18-1341	-	-	-	-
		325 GM			4	4		2278747 & Up	18-1334	18-1333	18-1332	-	-	-	-
		330 GM			4	4		4623115 & Up	18-1334	18-1333	18-1332	-	-	-	-
		330 W.B.W	GM		4	4		6083045 & Up	18-1334	18-1333	18-1332	-	-	-	-
	7.4L	340 / 7.4L	GM		4	4		5889914 & Up	18-1334	18-1333	18-1332	-	-	-	-
	5.7L	350 MAG ALPHA		350	4	4	1986-1997	A635178 - K999999	18-1308	18-1309	18-1341	-	-	-	-
	5.7L	350	GM	350	4	4		3780450 & Up	18-1334	18-1333	18-1332	-	-	-	-
	5.7L	350 MAG / 350 ALPHA / 350 EFI / 350 GEN +		350	4	4	1996-1997	F800300 - K999999	18-1308	-	-	-	-	-	-
	5.7L	350 MAG / 350 BRAVO / 350 MPI		350	4	4	1995	F415188 - F501099	18-1308	-	-	-	-	-	-
	5.7L	350 MAG / 350 BRAVO / 350 MPI / 350 GEN +		350	4	4	1996-1997	F602000 - K999999	18-1308	-	-	-	-	-	-
	5.7L	350 MAG SKI		350	4	4	1994-1996	F215561 - F820708	18-1308	-	-	-	-	-	-
	5.7L	350 MAG EFI SKI GEN +		350	4	4	1996-1997	F820707 - K999999	18-1308	-	-	-	-	-	-
	5.7L	350 MAG MPI GEN +		350	4	4	1988-2010	L010019 & UP	18-1308	-	-	-	-	-	-
	5.7L	350 MAG MPI / 350 MAG MIE GEN +		350	4	4	1988-2007	L002008 - A089999	18-1308	-	-	-	-	-	-
	5.7L	350MG / 350 MPI / 350 SKI		350	4	4	1995-1996	F352583 - F799999	18-1308	-	-	-	-	-	-
	5.7L	350 MAG / 350 MPI / 350 SKI / 350 GEN +		350	4	4	1998-2007	L002600 - A089999	18-1308	-	-	-	-	-	-
	5.7L	350 MAG SKI		350	4	4	1991-1997	D505450 - K999999	18-1308	-	-	-	-	-	-
	5.7L	5.7L		350	4	4	1988-1997	4908850 - F600999	18-1308	-	-	-	-	-	-
	5.7L	5.7L GEN +		350	4	4	1998-2010	L010037 & UP	18-1308	-	-	-	-	-	-
	5.7L	5.7L EFI		350	4	4	1995-1997	F225560 - K999999	18-1308	-	-	-	-	-	-
	5.7L	5.7L EFI GEN +		350	4	4	1998-2001	L010035 - M299999	18-1308	-	-	-	-	-	-

CHART CONTINUED ON NEXT PAGE

BEARING APPLICATION

HP	Liter	Model	Note	CID	# Cyl	Stroke	Year	Serial #	Rod Bearing			Main Bearing						
									Std.	0.01	0.02	Std.	0.01	0.02	Cam Bearing			
5.7L	5.7L	EFI MIE GEN +		350	8	8	1987	K040300 - K999999	18-1308	-	-	-	-	-	-	-		
5.7L	5.7L	MIE		350	8	4	1988-1987	B788152 - K999999	18-1308	-	-	-	-	-	-	-		
5.7L	5.7L	MIE GEN +		350	8	4	1988-2010	L002003 & UP	18-1308	-	-	-	-	-	-	-		
5.7L	5.7L	MPI / 5.7L MIE		350	8	4	2008-2010	A090000 & UP	18-1308	-	-	-	-	-	-	-		
5.7L	5.7L	MPI SKI		350	8	4	2008-2010	A090000 & UP	18-1308	-	-	-	-	-	-	-		
5.7L	5.7L	SKI		350	8	4	1985-1987	A336553 - K999999	18-1308	-	-	-	-	-	-	-		
5.7L	5.7L	SKI GEN +		350	8	4	1988-2010	L002005 & UP	18-1308	-	-	-	-	-	-	-		
5.7L	5.7L	X		350	8	4	1996-1997	F601000 - F600999	18-1308	-	-	-	-	-	-	-		
5.7L	5.7LX / 5.7LX BRAVO / 5.7LX EFI / 5.7LX GEN +			350	8	4	1996-1997	F800300 - K999999	18-1308	-	-	-	-	-	-	-		
5.7L	5.7L	EFI		350	8	4	1996-1997	F752400 - K999999	18-1308	-	-	-	-	-	-	-		
5.7L	BLACK SCORPION	SKI GEN +		350	8	4	1996-2006	F800000 - W689999	18-1308	-	-	-	-	-	-	-		
5.7L	BLACK SCORPION	SKI GEN +		350	8	4	2003-2007	W690000 - W698432	●	●	-	-	-	-	-	-		
5.7L	SCORPION 350			350	8	4	2008-2010	W698433 & UP	●	●	-	-	-	-	-	-		
	233			351	8	4	1975-1977	4173000 - 4902304	-	-	-	-	-	-	-	-		
	255	FORD		351	8	4	1973-1974	3258728 - 4175499	-	-	-	-	-	-	-	-		
	TOURNEY	SKI			8	4		D505450 & Up	18-1308	18-1309	18-1341	-	-	-	-	-		
	370	TRS	GM		8	4		6721528 & Up	18-1334	18-1333	18-1332	-	-	-	-	-		
	377	MAG		377	8	4	2008-2010	A3000000 & UP	●	●	-	-	-	-	-	-		
	377	SCORPION	MCM		377	8	4	1999-2005	L416145 - M907201	●	●	-	-	-	-	-		
	377	SCORPION	SKI GEN +		377	8	4	1987-1988	K000856 - L600314	●	●	-	-	-	-	-		
6.2L	MX 6.2L	MPI		377	8	4	2000-2007	L680003 - A299999	●	●	-	-	-	-	-	-		
6.2L	MX 6.2L	MPI / MX 6.2L HORIZON		377	8	4	2002-2007	M3000000 - A299999	●	●	-	-	-	-	-	-		
6.2L	MX 6.2L	MPI / MX 6.2L HORIZON / MX 6.2L MIE		377	8	4	2002-2010	M3000000 & UP	●	●	-	-	-	-	-	-		
6.2L	MX 6.2L	MPI / MX 6.2L MIE		377	8	4	2002-2010	M3000000 & UP	●	●	-	-	-	-	-	-		
6.2L	MX 6.2L	BLACK SCORPION	SKI		377	8	4	2002-2007	M3000000 - W698432	●	●	-	-	-	-	-		
6.2L	SCORPION	377		377	8	4	2008-2010	W698433 & UP	●	●	-	-	-	-	-	-		
7.4L	325			454	8	4	1969-1972	2275747 - 3780449	-	-	-	-	-	-	-	-		
7.4L	330			454	8	4	1977-1987	4623115 - B816540	-	-	-	-	-	-	-	-		
7.4L	330	MIE		454	8	4	1977-1980	4623115 - 5889913	-	-	-	-	-	-	-	-		
7.4L	340	MIE	WB-W		454	8	8	1981-1987	5889914 - B788365	-	-	-	-	-	-	-		
7.4L	350	MIE		454	8	4	1974-1976	3780450 - 4623109	-	-	-	-	-	-	-	-		
7.4L	370	TRS		454	8	4	1978-1987	4179554 - B714586	-	-	-	-	-	-	-	-		
	390	GM			8	4		2781129 - 2825059	18-1334	18-1333	18-1332	-	-	-	-	-		
7.4L	400	TRS		454	8	4	1980-1986	4179554 - B457844	-	-	-	-	-	-	-	-		
7.4L	420	GM		454	8	4	1987-1989	A398941 - B622418	18-1334	18-1333	18-1332	-	-	-	-	-		
7.4L	425	GM		454	8	4	1990-1992	B622419 - D725499	-	-	-	-	-	-	-	-		
7.4L	425	GEN V		454	8	4	1992-1993	D725500 - D937011	-	-	-	-	-	-	-	-		
7.4L	440	TRS		454	8	4	1983-1986	4179554 - B485220	-	-	-	-	-	-	-	-		
7.4L	450	GEN V		454	8	4	1995-1996	F347100 - F347277	-	-	-	-	-	-	-	-		
7.4L	454	MAG	ALPHA	GM		4	1996-1988	A631864 - B785148	18-1334	18-1333	18-1332	-	-	-	-	-		
7.4L	454	MAG	BRAVO		454	8	4	1988-1992	B721206 - D805068	-	-	-	-	-	-	-		
7.4L	454	MAG	BRAVO	GM		4		B840126 & UP	18-1334	18-1333	18-1332	-	-	-	-	-		
7.4L	454	MAG	BRAVO	GEN V		454	8	4	1992-1996	D805069 - M801699	18-1334	18-1333	18-1332	-	-	-	-	
7.4L	454	MAG	BRAVO	GEN VI		454	8	4	1996-1997	F801700 - K999999	-	-	-	-	-	-	-	
7.4L	454	MAG	EFI	GEN V		454	8	4	1994-1996	F115700 - F802349	-	-	-	-	-	-	-	
7.4L	454	MAG	EFI	SKI	GEN V		454	8	4	1996-1996	F215800 - F820099	-	-	-	-	-	-	-
7.4L	454	MAG	MPI	GEN VI		454	8	4	1996-2001	F802350 - M024999	-	-	-	-	-	-	-	
7.4L	454	MAG	MPI / 454 MAG HORIZON / 454 MAG MIE		454	8	4	1996-2001	L002200 - L674000	-	-	-	-	-	-	-	-	
7.4L	454	MAG	MPI / 454 MAG	SKI	GEN VI		454	8	4	1996-1997	F820100 - K999999	-	-	-	-	-	-	-
7.4L	454	EFI		454	8	4		F115700 & UP	18-1334	18-1333	18-1332	-	-	-	-	-		
	502	MAG	GM		8	4		C878221 & Up	18-1334	18-1333	18-1332	-	-	-	-	-		
	502	MAG	BRAVO	GEN V		8	4		D824589 & Up	18-1334	18-1333	18-1332	-	-	-	-	-	
	502	MAG	BRAVO	GEN V		8	4		D840650 & Up	18-1334	18-1333	18-1332	-	-	-	-	-	
	502	EFI		8	4			3108723 & Up	18-1336	-	-	-	-	-	-	-		







BEARING APPLICATION

HP	Liter	Model	Note	CID	# Cyl	Stroke	Year	Serial #	Rod Bearing			Main Bearing			
									Std.	0.01	0.02	Std.	0.01	0.02	Cam Bearing
		525 SC		454	8	4	1991-1992	D456000 - D725808	-	-	-	-	-	-	-
		525 SC GEN V		454	8	4	1992-1996	D763746 - F745215	-	-	-	-	-	-	-
		525 SC GEN V		454	8	4	1996-1999	F745260 - L415823	-	-	-	-	-	-	-
7.4L		7.4L BRAVO		454	8	4	1988-1991	B771113 - D603117	-	-	-	-	-	-	-
7.4L		7.4L BRAVO GEN V		454	8	4	1992-1996	D603116 - F800699	-	-	-	-	-	-	-
7.4L		7.4L BRAVO GEN VI		454	8	4	1996-1997	F800700 - K299999	-	-	-	-	-	-	-
7.4L		7.4L EFI / 7.4L MIE GEN VI		454	8	4	1996-1997	F674815 - K999999	-	-	-	-	-	-	-
7.4L		7.4L MIE		454	8	4	1988-1992	B786386 - D715483	-	-	-	-	-	-	-
7.4L		7.4L MIE GEN V		454	8	4	1992-1996	D715494 - F820141	-	-	-	-	-	-	-
7.4L		7.4L LH / 7.4L MIE GEN VI		454	8	4	1996-1997	F820142 - K999999	-	-	-	-	-	-	-
7.4L		7.4L MPI GEN V		454	8	4	1998-2001	L010003 - M024330	-	-	-	-	-	-	-
7.4L		7.4L MPI GEN V / 7.4L MIE GEN V		454	8	4	1995-1996	F563052 - F820103	-	-	-	-	-	-	-
7.4L		7.4L MPI GEN VI / 7.4L MIE GEN VI		454	8	4	1996-1997	F820104 - K999999	-	-	-	-	-	-	-
7.4L		7.4L MPI GEN VI L29 / 7.4L MIE GEN VI L29		454	8	4	1998-2001	L002906 - M025999	-	-	-	-	-	-	-
7.4L		7.4LX BRAVO TBI GEN VI		454	8	4	1988-2001	F802000 - K999999	-	-	-	-	-	-	-
7.4L		7.4LX BRAVO MPI GEN V		454	8	4	1996	F602010 - F801999	-	-	-	-	-	-	-
7.4L		7.4LX BRAVO MPI GEN VI		454	8	4	1996-1997	F802000 - K999999	-	-	-	-	-	-	-
7.4L		7.4L BRAVO	GM					D603118 & Up	18-1334	18-1333	18-1332	-	-	-	-
7.4L		7.4L BRAVO GEN V						C391564 & Up	18-1334	18-1333	18-1332	-	-	-	-
7.4L		7.4L WHURTH						D715494 & Up	18-1334	18-1333	18-1332	-	-	-	-
7.4L		7.4LHR GEN V						C878221 & Up	18-1334	18-1333	18-1332	-	-	-	-
		390		482	8	4	1969-1970	E781129 - 2825056	-	-	-	-	-	-	-
		460 TRS		482	8	4	1983-1986	4179554 - 6181046	●	●	-	-	-	-	-
		496 MAG / 496 HD		496	8	4	2001-2010	M025000 & UP	-	-	-	-	-	-	-
		8.15 MPI / 8.15 MIE / 8.15 HO		496	8	4	2001-2010	M025000 & UP	-	-	-	-	-	-	-
8.2L		465		502	8	4	1990-1992	C849992 - D725646	-	-	-	-	-	-	-
8.2L		465 GEN V		502	8	4	1992-1994	D725647 - F213244	-	-	-	-	-	-	-
8.2L		500 GEN V		502	8	4	1994-1996	F213293 - F745159	-	-	-	-	-	-	-
8.2L		500 GEN VI		502	8	4	1997-1999	K745195 - L801036	-	-	-	-	-	-	-
8.2L		500 EFI		502	8	4	1999-2000	L001477 - L306496	-	-	-	-	-	-	-
8.2L		500 EFI		502	8	4	2000-2005	L306500 - M907127	-	-	-	-	-	-	-
8.2L		502 MAG BRAVO		502	8	4	1990-1992	C876221 - D804588	-	-	-	-	-	-	-
8.2L		502 MAG BRAVO GEN V		502	8	4	1992-1993	D824589 - F114528	-	-	-	-	-	-	-
8.2L		502 MAG EFI		502	8	4	1993-1996	D840650 - F802599	-	-	-	-	-	-	-
8.2L		502 MAG MPI GEN VI		502	8	4	1996-2001	F802600 - M024999	-	-	-	-	-	-	-
8.2L		525 EFI		502	8	4	2003-2007	M920146 - M958499	-	-	-	-	-	-	-
8.2L		525 EFI		502	8	4	2007-2010	M958500 & UP	-	-	-	-	-	-	-
8.2L		575SCI		502	8	4	2000-2005	LN06696 - M95052E	-	-	-	-	-	-	-
8.2L		600 SC		502	8	4	1991-1992	D456489 - D456768	-	-	-	-	-	-	-
8.2L		600SC GEN V		502	8	4	1992-1996	D725676 - F877642	-	-	-	-	-	-	-
8.2L		600 SC GEN VI		502	8	4	1997-2000	K000227 - L801186	-	-	-	-	-	-	-
8.2L		8.2L MAG		502	8	4	2010	A350340 & UP	-	-	-	-	-	-	-
8.2L		8.2L MIE		502	8	4	2010	A350802 & UP	-	-	-	-	-	-	-
8.2L		8.2L MIE WHURTH		502	8	4	1990-1992	C878221 - D857199	-	-	-	-	-	-	-
8.2L		8.2L WHURTH (IB)		502	8	4		D857200 & Up	18-1334	18-1333	18-1332	-	-	-	-
8.2L		8.2L MIE GEN V		502	8	4		D857200 - F819619	-	-	-	-	-	-	-
8.2L		8.2L MPI GEN VI / 8.2L MIE GEN VI / 8.2LH GEN VI		502	8	4	1996-2001	F819620 - L674200	-	-	-	-	-	-	-
		500 BULLDOG		540	8	4	1990-1996	C577254 - F745405	●	●	-	-	-	-	-
		500 BULLDOG		540	8	4	1997-2001	K000248 - M050291	●	●	-	-	-	-	-
		575		540	8	4	1986-1992	A677429 - D763716	●	●	-	-	-	-	-
		800 SC GEN V		540	8	4	1993-1998	D783836 & UP	●	-	-	-	-	-	-
		888	FORD					4752210 & Up	18-1308	18-1309	18-1341	-	-	-	-
		898 / 198	GM					A338553 & Up	18-1308	18-1309	18-1341	-	-	-	-

● 8 Pair Bearing Set

MERCURUISER 3.7L BEARING APPLICATION

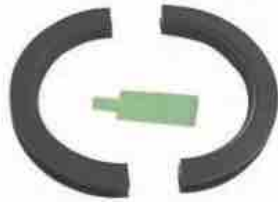
Model	Serial #	Rod Bearings			Main Bearings			Main (Thrust Bearings)		
		Std.	.010	.020	Std.	.010	.020	Std.	.010	.020
169/3.7 (4cyl)	6916779 & Up	18-1148	-	-	-	-	-	18-1149	-	-
170 (4cyl)	6916779 & Up	18-1148	-	-	-	-	18-1149	-	-	
180/3.7L (4cyl)	6916779 & Up	18-1148	-	-	-	-	18-1149	-	-	
190 (4cyl)	6916779 & Up	18-1148	-	-	-	-	18-1149	-	-	
470	4208730 & Up	18-1148	-	-	-	-	18-1149	-	-	
485	5685394 & Up	18-1148	-	-	-	-	18-1149	-	-	
488	6170297 & Up	18-1148	-	-	-	-	18-1149	-	-	

 <p>18-0518 VALVE STEM SEAL Replaces: 26-34217, 26-72564, 26-58094, 26-75413, 26-75624</p>	 <p>18-4023 VALVE STEM SEAL Replaces: 26-75413, 26-75624, 26-72564, 26-58094 For: 165, 170, 180, 190 4 cyl. (224 CID) SN 6916779 & later</p>	 <p>18-4022 VALVE STEM SEAL Replaces: 26-75988, 26-75982, 26-67863, 26-49131, F3866612, F1100968, F11101117 For: 330 (SN 4623115 & later), 340 (IB) (SN 5889914 & later), 454 Mag (SN A631894 & later)</p>	 <p>18-4024 18-4024-9[Ⓢ] VALVE STEM SEAL Replaces: 26-97664, 26-976641, 26-8M0050563, F11101200</p>
 <p>ONE PIECE REAR MAIN SEALS 18-1234 Replaces: 24-811554, 24-17057A1, 24-801879, 24-801879T For: 7.4L, GL, GI, GSI: 8.2L, GL 18-0519 Replaces: 26-14240, F11101300, 4.3L/3.0L/5.0L 5.7L 18-0864 Replaces: 26-90925, 27-67389</p>	 <p>TWO PIECE REAR MAIN SEALS 18-0528 Replaces: 26-56868 18-1211 Replaces: 26-58203, 26-49947, 26-814622, F1110026, F1110027, F1110041</p>	 <p>TIMING COVER SEALS 18-1213 Replaces: 26-97335, 26-11973, 26-42750, 26-54799 18-1230 Replaces: 26-56866 18-1233 Replaces: 26-8219471, 26-821947, 26-49154, F11100986 18-0578 Replaces: 26-67388</p>	

MERCURUISER SEAL APPLICATION

Model	Serial No.	Rear Main Crankshaft Seal	Timing Cover Seal
120/2.5L	1666601 & UP	—	18-1213
120/2.5L	2786857 & UP	18-1211	18-1213
140/3.0L & LX	2508261 & UP	—	18-1213
140/3.0L & LX	8229716 & UP	18-1211	18-1213
150/160/165/200 (I/L-6)	1666495 & UP	—	18-1213
150/160/165/200 (I/L-6)	2770032 & UP	18-1211	18-1213
175/185/205/262/4.3L (V-6)	6330183 & UP	18-1211	18-1213
200/228/225/230/250/255/260/270/280/300/320/5.0L/5.7L/8.98 (V-8)	2453769 & UP	18-1211 [Ⓢ]	18-1213
215	2761153 & UP	18-0528	—
224/L4	ALL	18-0864	18-0578
225 FORD	3865721 & UP	18-0528	—
5.0L/5.7L, 4.3L, 3.0L Std. Rotation	*All one piece seal	18-0519	18-1213
340 (7.4L)	4623115 & UP	—	18-1233
370 TRS	5889914 & UP	—	18-1233
400 TRS	4179554 & UP	—	18-1233
420	A398941 & UP	—	18-1233
440 TRS	4179554 & UP	—	18-1233
454 MAGNUM	A631894 & UP	—	18-1233
460 TRS	4179554 & UP	—	18-1233
7.4L/8.2L/454/502 Std. Rotation	*All one piece seal	18-1234	18-1233
7.4 BRAVO	B771113 & UP	—	18-1233
888 (188)	3108723 & UP	18-0528	—

Ⓢ Lrg. Journal Crankshaft GM Engines Ⓢ Priced per Package

ALWAYS GET A PERFECT FIT



ALL SIERRA MANIFOLDS:

- Manufactured as a direct OE replacement and are fully interchangeable with the OEM products they are designed to replace.
- Includes all the necessary gaskets and hardware for easy, out-of-the-box installation.
- Revised gasket material for more compressibility and better sealing properties.
- All manifolds are primed and painted for added durability, protection. Components are ready to install out-of-the box.
- Packaged for maximum protection during shipping and handling.
- Backed by Sierra's Comprehensive Warranty.

The Very Best Parts of Boating

Sierra
Marine Engine and Drive Parts

MANIFOLD & EXHAUST MANIFOLD GASKET SETS



18-0403

INTAKE GASKET KIT

Replaces: 27-805722A1, 27-812712, 27-61782, 27-52571
For: MCM 370, 400, 325, 454, 502 Mag, 7.4L Bravo II & MIE 8.2L 1976-1997



18-0404

INTAKE GASKET KIT

Replaces: 27-805403A1
For: MCM/MIE 454 Mag MPI, 7.4L/LX MPI & 8.2L MPI 1993-UP



18-0603

EXHAUST MANIFOLD GASKET SET

For: Ford 302/351 CID Engines
For use with 18-1998-1



18-0604

EXHAUST MANIFOLD GASKET SET

For: GM 305/350 CID Engines
For use with 18-1997-1



18-4347-1

EXHAUST MANIFOLD GASKET SET

For: GM 175, 185, 205 (229 & 262 CID)

— CONTAINS —			
Part #	Description	O.E. #	Qty.
18-0897	Exhaust Elbow Mounting Gasket	27-41813-1	2
18-2909	Exhaust Manifold to Cyl. Head Gasket	27-99757	2



18-4348

EXHAUST MANIFOLD GASKET SET

For: GM 454, 525 (7.4L & 8.2L)

— CONTAINS —			
Part #	Description	O.E. #	Qty.
18-0415	Manifold to Cylinder Head Gasket	27-46820	2
18-0897	Exhaust Elbow Mounting Gasket	27-41813-1	2



18-4408

INTAKE MANIFOLD GASKET SET

Replaces: 27-11977, 27-11987
For: GM 262 CID Engines 175, 185 and 205 HP



18-4349

EXHAUST MANIFOLD GASKET SET

For: GM 200, 228, 230, 260, 898 (5.0 & 5.7L)

— CONTAINS —			
Part #	Description	O.E. #	Qty.
18-2949	Exhaust Manifold Gasket	27-33395	2
18-0897	Exhaust Elbow Mounting Gasket	27-41813-1	2



18-4367

EXHAUST MANIFOLD GASKET SET

Replaces: 27-99777A1
For: GM 153 & 181 (2.5 & 3.0L) CID Eng's; 120 & 140 HP
 S/N 6229718 & UP.
 (With Siamese Port Cylinder Heads)

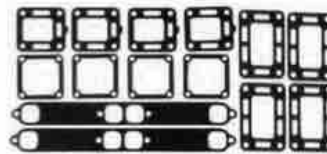

18-4394

EXHAUST MANIFOLD GASKET SET

Replaces: 27-33395A2, 27-33395A1
For: GM 350 (5.7L) CID Eng; 250 HP S/N 4768000-4908849 255 HP S/N 5195909 & UP

— CONTAINS —			
Part #	Description	O.E. #	Qty.
18-2832-1	Manifold End Cap Gasket	27-48043	4
18-2833	Exhaust Elbow Gasket	27-99777-2	4
18-2949	Exhaust Manifold Gasket	27-33395	2
18-0885-1	Exhaust Elbow Gasket	27-48042	4

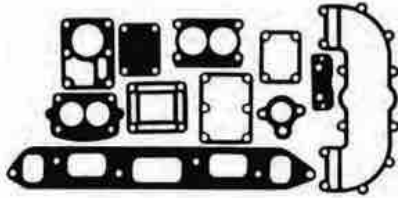

18-4395
EXHAUST MANIFOLD GASKET SET
 Replaces: 27-35898A4, 27-35898A3, 27-35898A2
 For: GM 153 (2.5L) CID Eng.
 120 HP S/N 2046625-6229717

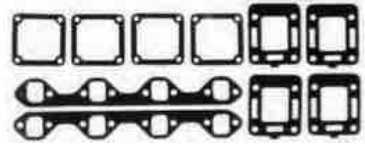

18-4399
EXHAUST MANIFOLD GASKET SET
 Replaces: 27-54566A1
 For: Ford 302/351 (5.0L & 5.8L) CID Eng. All 888 (188 HP)
 & 233 HP, 255 HP • S/N 3258728-4175498

— CONTAINS —			
Part #	Description	O.E. #	Qty.
18-0183-1	Exhaust Mounting Gasket	27-46820	2
18-2832-1	Manifold End Cap Gasket	27-48043-1	4
18-2833	Exhaust Elbow to Gasket	27-99777-2	4

18-4396
EXHAUST MANIFOLD GASKET SET
 Replaces: 27-46401A1
 For: 250 (4.1L) CID Eng; 165 HP S/N 2770032 & UP



— CONTAINS —			
Part #	Description	O.E. #	Qty.
18-2830-1	Intake Exhaust Gasket	27-46401	1
18-2831	Thermostat Gasket	27-47590-1	1
18-2832-1	Manifold End Cap Gasket	27-48083-1	2
18-2833	Exhaust Elbow Gasket	27-99777-2	1
18-0353	Carb. Mounting Gasket	27-58764	1
18-0358	Carb. Mounting Gasket	27-64692	1
18-0928-1	Exhaust End Cap Gasket	27-73814	1

18-4398
EXHAUST MANIFOLD GASKET SET
 Replaces: 27-53354A1
 For: GM 181 (3.0L) CID Eng; 140 HP S/N 3332137-6229717
 (Without Siamese Port Cylinder)

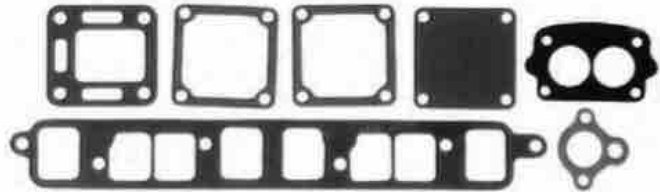

CYLINDER HEAD AND INTAKE MANIFOLD GASKET SETS



18-4383
 For: GM 153 (2.5L) CID Eng.
 S/N 2324347 & UP Includes 18-3880 Head Gasket



18-4384
 For: GM 181 (3.0L) CID Eng.
 S/N 2508261-6229717 (Except 3.0LX)

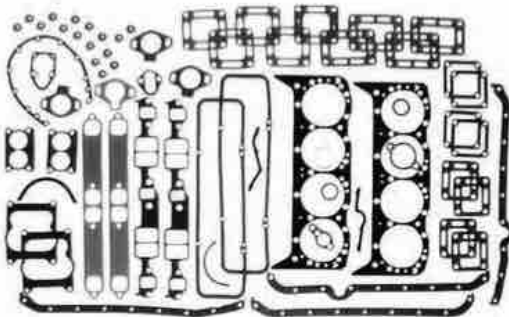

18-4386
 For: GM 305 & 350 (5.0L & 5.7L) CID Eng. With Heads (1987 & Earlier)

— CONTAINS —			
Part #	Description	O.E. #	Qty.
18-0975	Timing Chain Cover Gasket	27-14250	1
18-0868	Intake Manifold Gasket	27-17145	1
18-2949	Exhaust Manifold Gasket	27-33395	2
18-0897	Exhaust Elbow Mounting Gasket	27-41813	2
18-0895-1	Exhaust Elbow Mounting Gasket	27-48042	4
18-2917	Lower Thermostat Housing Gasket	27-53045-1	1
18-0153	Port Dip Gasket	27-95817A1	1
18-2848	Quadrajet Base Gasket	27-58457-2	2
18-2849-1	Exhaust Elbow To Manifold Gasket	27-87105-1, 27-818632	4
18-3876	Head Gasket	27-75611	2
18-2554	Thermostat Gasket	27-41812	1
18-2832-1	Manifold End Cap Gasket	27-48043-1	4
18-2553	Thermostat Gasket	27-47510	1
18-2833	Exhaust Elbow To Manifold Gasket	27-99777-2	4
18-2844	Thermostat Cover Gasket	27-48818-1	1
18-0869	Fuel Pump Housing Gasket	27-34213	1
18-0991	Water Pump Mounting Gasket	27-34897	1
18-0905	Oil Pan Drain Plug Gasket	27-49855	1
18-0876	Water Pump Mounting Gasket	27-34899	1
18-0894	Carb. Mounting Gasket	27-70143-1	2
18-0518	Seal	26-34217	18
18-2845	Valve Cover Gasket	121-122	2

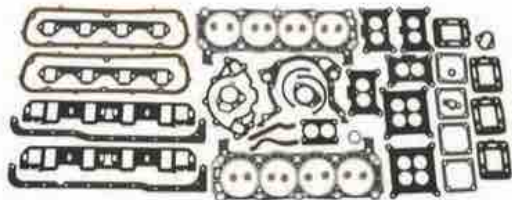

18-4385

For: Ford 302 (5.0L) CID Eng; 215, 225 & 888 (188 HP)
Includes 18-3883 Head Gasket

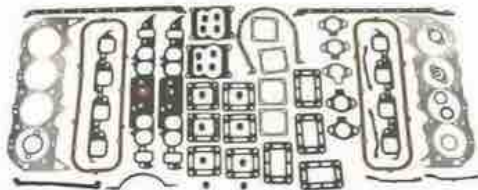

18-4387

Replaces: 27-801853
For: GM 454 (7.4L) CID Eng; Production Models
Oval Port
Includes 18-3877 Head Gasket



18-0465

INTAKE MANIFOLD GASKET SET

Replaces: 27-65184, 27-8M0050224
For: GM 454 CID Engines, 325, 330, 340, 350 HP
and 454 Magnums, 7.4L

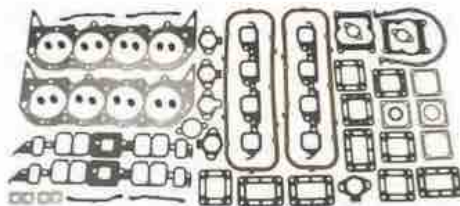

18-4365

INTAKE MANIFOLD GASKET SET

Replaces: 27-801855
For: GM 454 (7.4L) CID Eng; Production Models
Rectangular Port
Includes 18-3877 Head Gasket



18-4388

INTAKE MANIFOLD GASKET SET

Replaces: 27-11977A88, A92
For: GM 262 CID Eng; 175, 185 & 205 HP, 4.3L
Includes 18-3879 Head Gasket

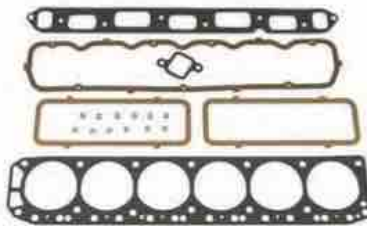

18-4389

INTAKE MANIFOLD GASKET SET

Replaces: 27-47453A1
For: All GM 165 HP (S/N 270032 & UP) & Inline 6 cyl.
250 CID

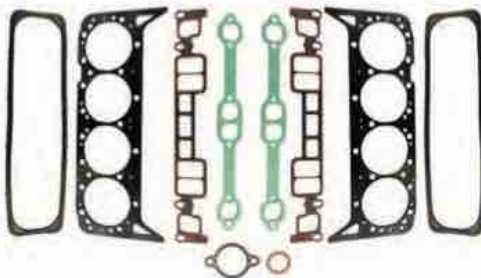

18-1254

**VORTEC
HEAD GASKET SET**

Replaces: 27-75611A03
For: Small Block GM V8 engines with Vortec heads

18-4392

INTAKE MANIFOLD GASKET SET

Replaces: 27-75611A2, 27-75611A1
For: GM 905 & 350 CID Eng. 898 (198 HP) 200, 228,
230/260 (inboard) 230, 250, 255, 260, 280 & 5.7L Ski

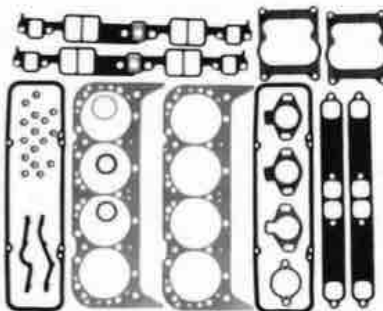

— CONTAINS —

Part #	Description	O.E. #	Qty.
18-0868	Intake Manifold Gasket	27-17145	1
18-2949	Exhaust Manifold Gasket	27-33395	2
18-2848	Quadrajet Base Gasket	27-52457-2	2
18-3876	Head Gasket	27-75611	2
18-2553	Thermostat Gasket	27-47510	1
18-2844	Thermostat Cover Gasket	27-48818-1	1
18-2554	Thermostat Gasket	27-41812	2
18-2917	Lower Thermostat Housing Gasket	27-53045-1	1
18-2845	Valve Cover Gasket	27-11999	2
18-0518	Seal	26-34217	16

OVERHAUL GASKET SETS
(Sets do not include Front and Rear Crankshaft Seals)



18-4381

Replaces: 27-43186A1, 27-89656A1, 27-41636A1
For: 224 (3.7L) CID Eng, 165, 170, 180, 190 HP
S/N 6916779 & UP

— CONTAINS —

Part #	Description	O.E. #	Qty.
NSS	O-Ring	25-28543	4
18-0860	O-Ring	25-62700	1
18-0864	Seal	26-90925	1
18-0881-1	Exhaust Elbow Mounting Gasket	27-18272	1
18-0992	Exhaust Manifold Mounting Gasket	27-68715	1
18-0994	Carburetor Mounting Gasket	27-70143-1	1
18-0158	Intake Manifold Gasket	27-70905	1
18-0111	Exhaust Elbow Mounting Gasket	27-89657	2
18-0160	Lower Exhaust to Intake Manifold Gasket	27-94136	1
18-0113-1	Exhaust Elbow Mounting Gasket	27-97542	1
18-2843	Thermostat Cover Gasket	27-74830	1
18-2848	QuadraJet Base Gasket	27-52457-2	1
18-3878	Head Gasket	27-13709T	1
18-7121	O-Ring	25-35027	1
18-0874	Distributor Gasket	27-34486	1
18-0165	Seal	27-91892	1
18-2555	Thermostat Gasket	27-89656-1	1
18-0889	Fuel Pump Mounting Gasket	27-34213	1
18-4366	Oil Pan Gasket Set	27-72479A5	1
18-0387	Flywheel Cover Gasket	27-94976	1
18-0172	Oil Seal	26-97530	2

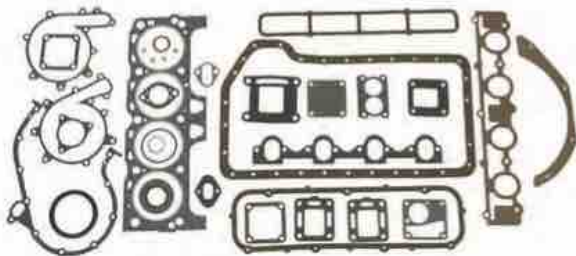

18-4382

Replaces: 27-74830A3, 27-74830A1, 27-74264A1
For: 224 (3.7L) CID Eng, 470 S/N 4208730 & UP

— CONTAINS —

Part #	Description	O.E. #	Qty.
18-0864	Seal	26-90925	1
18-0956-1	Exhaust Manifold Mounting Gasket	27-68715	1
18-0158	Intake Manifold Gasket	27-70905	1
18-0950	Impeller Cover Gasket	27-88048	1
18-0954	Exhaust Mounting Gasket	27-92720	1
18-0113-1	Exhaust Elbow Mounting Gasket	27-97542	1
18-2832-1	Manifold End Cap Gasket	27-48043-1	2
18-2833	Exhaust Elbow To Manifold Gasket	27-99777-2	2
18-2843	Thermostat Cover Gasket	27-74830	1
18-3878	Head Gasket	27-13709T	1
NSS	O-Ring	25-28543	4
18-0889	Fuel Pump Mounting Gasket	27-34213	1
18-7121	O-Ring	25-35029	1
18-0874	Distributor Gasket	27-34486-3	1
18-0928-1	Manifold End Cap Gasket	27-73814	1
18-0994	Carb. Mounting Gasket	27-70143-1	1
18-2555	Thermostat Cover Gasket	27-89656-1	1
18-4366	Oil Pan Gasket Set	27-72479A5	1
18-0387	Flywheel Cover Gasket	27-94976	1

MISCELLANEOUS GASKET SETS



18-0153

OIL PAN GASKET SET

Replaces: 27-85817A1, F15110037, F15110032,
27-72627

For: Mercruiser GM 350 CID (5.7L)



18-1239

OIL PAN GASKET

Replaces: 27-810846T, 27-810846

For: Mercruiser 3.0L GM 181



18-0348

OIL PAN GASKET SET

Replaces: 27-52550, 27-49107, F1100229,
F15000229, F15000245

For: Mercruiser GM 454/502 CID Eng;
(7.4L and 8.2L)



18-1237

OIL PAN GASKET

Replaces: 27-138651, 27-13865, F1101281

For: Mercruiser GM 5.7L



18-0466

OIL PAN GASKET SET

Replaces: 27-14901A1, 27-14901, 27-52144

For: Mercruiser GM 153/181 (2.5L & 3.0L)



18-1232

OIL PAN GASKET

Replaces: 27-811566, 27-845628

For: GM Big Block



18-1231

INTAKE GASKET

Replaces: 27-8181881, 27-818188

For: Rectangular port high performance big block Chevy



18-0405

OIL PAN GASKET

Replaces: 27-883964, 27-14247, 27-883964T

For: Mercruiser GM 262 CID Eng. (4.3L)

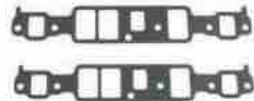

18-1238

INTAKE GASKET SET

Replaces: 27-824326

For: Mercruiser 4.3L/LX models,
pre SN F802999



18-0407
OIL PAN GASKET SET
 Replaces: 27-64798, 27-56870A1
 For: Mercruiser: 215, 225, 898



18-0410
INTAKE MANIFOLD GASKET SET
 Replaces: 27-75648
 For: Ford 5.0L/302, 5.8L/351 CID Engine, (233HP) S/N 3108723 & UP



18-0411
OIL PAN GASKET SET
 Replaces: 27-90458A1, 27-90458, FI5000178, FI5000183
 For: Mercruiser GM 350 CID (5.7L) Starboard Dipstick



18-0611
OIL PAN GASKET SET
 Replaces: 27-75483
 For: Mercruiser Ford 351 CID Eng.



18-0868
INTAKE MANIFOLD GASKET SET
 Replaces: 27-17145, 27-72637, FI5000263, FI5000232, FI1101296
 For: Mercruiser 305, 350

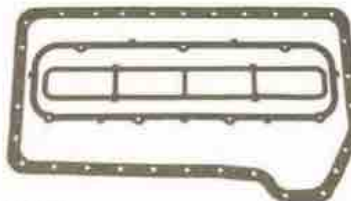

18-4366
OIL PAN GASKET SET
 Replaces: 27-72479A5, 27-72479T, 27-72479
 For: Mercruiser 224 CID (3.7L)



18-4375
TIMING CHAIN GASKET SET
 Replaces: 27-34213A2, 27-34213A1
 For: Mercruiser GM 153 & 181 CID Eng's; 110, 120, 130, 140, 150, 160 & 165 HP; 2.5L & 3.0L

— CONTAINS —

Part #	Description	O.E. #	Qty.
18-0888	Fuel Pump Mounting Gasket	27-34213	1
18-0887	Timing Cover Gasket	27-49953	1
18-0948	Distributor Gasket	27-87707	1
18-0327	Water Pump Gasket	27-33956	1

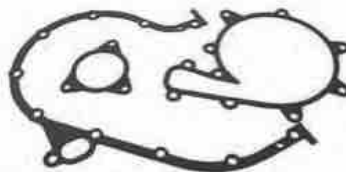



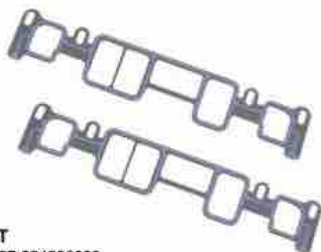













18-4380
TIMING CHAIN GASKET SET
 Replaces: 27-68714A6, 27-68714A7, 27-68714, 27-72098
 For: Mercruiser 224 CID Eng. 165, 170, 180, 190, 470, 485 & 488 HP



18-0487
INTAKE GASKET SET
 Replaces: 27-8243261, 27-824326002
 Fits: MCM 262 Mag & 4.3L/LXLH/LXH Gen II (1996-up)



18-0488
INTAKE GASKET SET
 Replaces: 27-807473A1
 Fits: MCM 350 Mag, 5.0L & 5.7L/LX Gen II (1996-up)

 <p>18-2946 HEAD GASKET Replaces: 27-52364, 27-81084, FI5000204 For: GM 181 (3.0L) CID Eng.</p>	 <p>18-3874 HEAD GASKET Replaces: 27-811546, 27-879150139 For: (8.2L) 502 CID</p>	 <p>18-3876 HEAD GASKET Replaces: 27-75611, 27-75611001, 27-48330, 27-34278 For: GM 305 (5.0L)/350 (5.7L) CID Eng.</p>	
 <p>18-3877 HEAD GASKET Replaces: 27-13218, 27-13687, 27-19315, 27-49104, 27-61224, 27-97529, 27-8M0049045 For: GM 454 (7.4L) CID Eng., Mark IV (pre-1992)</p>	 <p>18-3878 HEAD GASKET Replaces: 27-13709, 27-13709T, 27-74264, 27-79986, 27-92166, 27-921661 For: Mercruiser 224 (3.7L) CID Eng. Model 470</p>	 <p>18-3879 HEAD GASKET Replaces: 27-11986, 27-816460, 27-879150140, 27-42744 For: GM 262 (4.3L) CID Eng.</p>	
 <p>18-3880 HEAD GASKET Replaces: 27-34273, 27-342731 For: GM 153 (2.5L)</p>	 <p>18-3881 HEAD GASKET Replaces: 27-47453, 27-72622, 27-39164, 27-34274 For: GM 250 (4.1L) CID (6 cyl) Eng.</p>	 <p>18-3883 HEAD GASKET Replaces: 27-75647, 27-75646, 27-64763, 27-56110 For: Ford 302 (5.0L) 351 (5.8L) CID Eng.</p>	
 <p>18-3887 HEAD GASKET Replaces: 27-850470, 27-879150141, 27-811547 For: (7.4L) 454 CID GEN V and VI (1992-up)</p>	 <p>18-0353 CARB MOUNTING GASKET Replaces: 27-58764</p>	 <p>18-0354 CARB MOUNTING GASKET Replaces: 27-60715</p>	 <p>18-0685 VALVE COVER GASKET Replaces: 27-73666 224 CID (3.7L)</p>
 <p>18-0356 CARB MOUNTING GASKET (For Rochester) Replaces: 27-64692, 27-32910</p>	 <p>18-0357 CARB MOUNTING GASKET Replaces: 27-65577, 27-56884</p>	<p>PKG. OF 2</p>  <p>18-0876 18-0876-9Ⓢ FUEL PUMP GASKET For GM 4.3L, 5.0L & 5.7L Replaces: 27-34898, FI5005756</p>	<p>PKG. OF 2</p>  <p>18-0889 18-0889-9Ⓢ FUEL PUMP GASKET For GM 4.3L, 5.0L & 5.7L Replaces: 27-34213, 27-56883, FI5000074</p>

SEE PAGE 219 FOR OUR COMPLETE LINE OF GASKET SEALANTS

Ⓢ Priced per Package



18-0360
CARB MOUNTING GASKET
Replaces: 27-70142



18-0462
CARB MOUNTING GASKET
Replaces: 27-48399

Model	Year	S/N
250	1968-69	2314301-2629854
270	1968-72	2851074-3385720
325	1969-70	2278747-3042730
380	1969-70	2781129-3042731



18-0463
CARB MOUNTING GASKET
(For Weber)
Replaces: 27-814210



18-0467
CARB MOUNTING GASKET
(For Weber)
Replaces: 27-41610, 27-49814

PKG. OF 2



18-0994
18-0994-9Ⓢ
CARB MOUNTING GASKET
Replaces: 27-701431, 27-8079821, 27-807982, 27-70143, 27-807982B, 27-70143B1

PKG. OF 2



18-2848
18-2848-9Ⓢ
CARB BASE GASKET
Replaces: 27-524572, 18-524577, 18-524571

PKG. OF 2



18-0874
18-0874-9Ⓢ
DISTRIBUTOR GASKET
For GM V6 & V8
Replaces: 27-344863, 27-344861, 27-34486, 27-52184, 27-34891, FI5000162, F3932344
For: 2.6L (1989), 3.5L (1989), 4.3L (1987-93), 5.0L (1987-88), 5.7L (1987-92), 7.4L (1989-93), 8.2L (1992-93)

PKG. OF 2



18-0948
18-0948-9Ⓢ
DISTRIBUTOR GASKET
Replaces: 27-87707
4 Cyl.

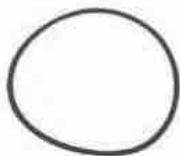

18-0422
DISTRIBUTOR CAP GASKET
Replaces: 391-5076
V8



18-0740-1
THROTTLE BODY GASKET
Replaces: 27-805396

PKG. OF 2



18-2552
18-2552-9Ⓢ
THERMOSTAT GASKET
Replaces: 27-331792, 27-331791

PKG. OF 2



18-0667
18-0667-9Ⓢ
CONNECTOR COVER GASKET
Replaces: 27-995061, 27-99506

PKG. OF 2



18-2553
18-2553-9Ⓢ
THERMOSTAT GASKET
Replaces: 27-47510, 27-47510Q
GM V-6, V-8

PKG. OF 2



18-2554
18-2554-9Ⓢ
THERMOSTAT GASKET
Replaces: 27-41812, 27-90556, 27-41812Q
V-6 & V-8

PKG. OF 2



18-2555
18-2555-9Ⓢ
THERMOSTAT GASKET
Replaces: 27-896561, 27-89656
4 Cyl.

PKG. OF 2



18-2831
18-2831-9Ⓢ
THERMOSTAT GASKET
Replaces: 27-475901, 27-47590
4 & 6 Cyl.

PKG. OF 2



18-2834
18-2834-9Ⓢ
THERMOSTAT GASKET
Replaces: 27-60208
Ford V-8

PKG. OF 2



18-2843
18-2843-9Ⓢ
THERMOSTAT GASKET
Replaces: 27-74830
470

PKG. OF 2



18-2844
18-2844-9Ⓢ
THERMOSTAT GASKET
Replaces: 27-48818, 27-488181, 27-4881801
V-8

















PKG. OF 2



18-2917
18-2917-9Ⓢ
THERMOSTAT GASKET
Replaces: 27-53045, 27-530451, 27-33179, F10077105, F11101276, F11101291, FI5000096

SEE PAGE 219 FOR OUR COMPLETE LINE OF GASKET SEALANTS

Ⓢ Priced per Package





<p>PKG. OF 2</p>  <p>18-0398 18-0398-9① THERMOSTAT GASKET Replaces: 27-8M2021920, 27-33918</p>	 <p>18-0111 EXHAUST ELBOW GASKET Replaces: 27-89657</p>	 <p>18-0113-1 EXHAUST ELBOW GASKET Replaces: 27-97542, 27-856705</p>	<p>PKG. OF 2</p>  <p>18-0672 18-0672-9① EXHAUST ELBOW GASKET Replaces: 27-860231, 27-8637251</p>
 <p>18-0365 HEAT EXCHANGER END GASKET 2 3/4" dia. Replaces: 27-75450 224 CID</p>	 <p>18-0389 HEAT EXCHANGER END GASKET 3 15/16" dia. Replaces: 27-99960</p>	 <p>18-0881-1 EXHAUST ELBOW GASKET Replaces: 27-18272</p>	<p>PKG. OF 2</p>  <p>18-0885-1 18-0885-9① EXHAUST ELBOW GASKET Replaces: 27-48042</p>
 <p>18-0897 EXHAUST ELBOW GASKET Replaces: 27-41813</p>	<p>PKG. OF 2</p>  <p>18-0928-1 18-0928-9① MANIFOLD END CAP GASKET Replaces: 27-73814, 27-738141, 27-807218</p>	 <p>18-0954 EXHAUST ELBOW GASKET Replaces: 27-92720</p>	<p>PKG. OF 2</p>  <p>18-2819-1 18-2819-9① EXHAUST ELBOW GASKET Replaces: 27-39915</p>
<p>PKG. OF 2</p>  <p>18-2832-1 18-2832-1-9① MANIFOLD END CAP GASKET Replaces: 27-480431, 27-48043</p>	<p>PKG. OF 2</p>  <p>18-2833 18-2833-9① EXHAUST ELBOW GASKET Replaces: 27-997772, 27-997771, 27-99777, 27-52076</p>	<p>PKG. OF 2</p>  <p>18-2849-1 18-2849-9-1① EXHAUST ELBOW GASKET Replaces: 27-87105, 27-871051, 27-860232, 27-818832, 27-863726</p>	<p>PKG. OF 2</p>  <p>18-1210-1 END CAP GASKET Replaces: 27-39923</p>
 <p>18-0158 INTAKE MANIFOLD GASKET Replaces: 27-70905 For: 3.7L</p>	 <p>18-0183-1 EXHAUST MANIFOLD GASKET Replaces: 27-73866, 27-54566</p>	 <p>18-0418 EXHAUST MANIFOLD GASKET Replaces: 27-46820</p>	 <p>18-2830-1 EXHAUST MANIFOLD GASKET Inline 6 cyl. Replaces: 879036, 27-46401, 27-52584, 27-33121</p>



SEE PAGE 219 FOR OUR COMPLETE LINE OF GASKET SEALANTS





© Priced per Package

 <p>18-0680 EXHAUST MANIFOLD GASKET Replaces: 27-815528</p>	 <p>18-2896-1 EXHAUST MANIFOLD GASKET Replaces: 27-52546, 27-32816</p>	<p>PKG. OF 2</p>  <p>18-2909 18-2909-9① EXHAUST MANIFOLD GASKET Replaces: 27-99757</p>	 <p>18-2949 EXHAUST MANIFOLD GASKET Replaces: 27-33395 GM 5.0L & 5.7L</p>	 <p>18-2912-1 EXHAUST MANIFOLD GASKET Replaces: 27-53354</p>
---	--	---	--	---

 <p>18-0956-1 EXHAUST MANIFOLD GASKET Replaces: 27-68715</p>	<p>PKG. OF 2</p>  <p>18-1204-1 18-1204-1-9① EXHAUST MANIFOLD GASKET Replaces: 27-96429</p>	 <p>18-0664 VALVE COVER GASKET Replaces: 27-17467, F11101287 For: GM 305/350, 5.0 & 5.7L</p>	 <p>18-2845 VALVE COVER GASKET Replaces: 27-11999, 27-34043, 27-52202, F11101236, F15000161 V-8 GM 305/350 CID, 5.0 & 5.7L</p>
--	--	--	--

















 <p>18-25001 VALVE COVER GASKET Replaces: 27-14765, F3860315, F11110294, F11110958 Fits: GM 454, 7.4L</p>	 <p>18-25002 VALVE COVER GASKET Replaces: 27-811588 Fits: GM 454, 502, (1992-UP) Recessed Grooved Valve Cover</p>	 <p>18-0311 VALVE COVER GASKET Replaces: 27-11988 For: 4.3 Litre 262 CID</p>	 <p>18-0346 VALVE COVER GASKET Replaces: 27-49936, 27-34042 For: GM 250 CID (4,1L), 160/165/200 (6 cyl.)</p>
---	---	--	---

 <p>18-0347 VALVE COVER GASKET Replaces: 27-52145, 27-806452, 27-34041 For: GM 153 & 181 CID (2.5L & 3.0L)</p>	<p>PKG. OF 2</p>  <p>18-0464 18-0464-9① VALVE COVER GASKET Replaces: 27-49121, 27-91831 For: GM 454/502 CID (7.4L & 8.2L)</p> <table border="1"> <thead> <tr> <th>Model</th> <th>Year</th> <th>S/N</th> </tr> </thead> <tbody> <tr> <td>330</td> <td>1977-81</td> <td>4623115-6083144</td> </tr> <tr> <td>7.4 Bravo</td> <td>1988-91</td> <td>B771113-D603117</td> </tr> <tr> <td>454 Mag</td> <td>1986-92</td> <td>A631894-D805068</td> </tr> <tr> <td>370 TRS</td> <td>1978-87</td> <td>4179554-B714588</td> </tr> <tr> <td>400 TRS</td> <td>1980-86</td> <td>4179554-B457644</td> </tr> <tr> <td>400 TRS</td> <td>1983-86</td> <td>4179554-B485220</td> </tr> <tr> <td>460 TRS</td> <td>1983-86</td> <td>4179554-6181046</td> </tr> <tr> <td>502 Mag Bravo</td> <td>1990-92</td> <td>C878221-D824588</td> </tr> </tbody> </table>	Model	Year	S/N	330	1977-81	4623115-6083144	7.4 Bravo	1988-91	B771113-D603117	454 Mag	1986-92	A631894-D805068	370 TRS	1978-87	4179554-B714588	400 TRS	1980-86	4179554-B457644	400 TRS	1983-86	4179554-B485220	460 TRS	1983-86	4179554-6181046	502 Mag Bravo	1990-92	C878221-D824588	 <p>18-0352 VALVE COVER GASKET Replaces: 27-56173 For: Ford 302/351 CID (5.0L & 5.8L)</p>
Model	Year	S/N																											
330	1977-81	4623115-6083144																											
7.4 Bravo	1988-91	B771113-D603117																											
454 Mag	1986-92	A631894-D805068																											
370 TRS	1978-87	4179554-B714588																											
400 TRS	1980-86	4179554-B457644																											
400 TRS	1983-86	4179554-B485220																											
460 TRS	1983-86	4179554-6181046																											
502 Mag Bravo	1990-92	C878221-D824588																											

 <p>18-0468 TIMING COVER GASKET Replaces: 27-811572 GM 4.3L, 5.0L & 5.7L</p>	<p>PKG. OF 2</p>  <p>18-0887 18-0887-9① TIMING COVER GASKET Replaces: 27-49953, 27-34216, F15000201 4 & 6 Cyl.</p>	<p>PKG. OF 2</p>  <p>18-0976 18-0976-9① TIMING CHAIN COVER GASKET Replaces: 27-14250, 27-34895, F11101297</p>	 <p>18-0980 TIMING COVER GASKET Replaces: 27-54529, 27-49109, 110990, 1100990 GM 7.4L</p>
--	--	---	---

SEE PAGE 219 FOR OUR COMPLETE LINE OF GASKET SEALANTS

① Priced per Package

<p>PKG. OF 2</p>  <p>18-0328 18-0328-9① PUSH ROD/LIFTER COVER GASKET Replaces: 27-34208 153 & 181 CID, 120/140 (4 Cyl.)</p>	 <p>18-0329 PUSH ROD/LIFTER COVER GASKET Replaces: 27-34209 For: 140/150/160/165 (6 cyl.)</p>	 <p>18-2815 PUSH ROD COVER GASKET Replaces: 27-814703, FI5000119, FI5000199 For: 3.0L</p>	<p>PKG. OF 2</p>  <p>18-0185 18-0185-9① REMOTE OIL SEAL Replaces: 27-91892</p>
 <p>18-1240 OUTDRIVE SEAL For Bravo Replaces: 12708</p>	<p>PKG. OF 5</p>  <p>18-2516 18-2516-9① BRAVO OUTDRIVE SEAL Replaces: 16755, 16755A1, 16755Q1</p>	<p>PKG. OF 2</p>  <p>18-2556 18-2556-9① DRIVE SHAFT HOUSING TO BELL HOUSING GASKET Replaces: 27-35996, A1</p>	 <p>18-2743 OUTDRIVE HOUSING GASKET Replaces: 27-94996, 27-949962, 27-94996A1, 27-94996A2, 27-94996Q2, 27-94996A3, 27-94996A20, 27-64818A2</p>
<p>PKG. OF 5</p>  <p>18-2820 18-2820-9① OUTDRIVE GASKET Replaces: 27-64818, Q4, 27-64818A20, 27-64818A4, 27-64818A1, 27-45821</p>	<p>PKG. OF 5</p>  <p>18-2840 18-2840-9① BELL HOUSING GASKET Replaces: 27-35982</p>	<p>PKG. OF 2</p>  <p>18-2847 18-2847-9① OUTDRIVE GASKET Replaces: 27-54014, 27-54014A1, 27-54014Q1, 27-54014T1 For: E, H, TR, TRS</p>	 <p>18-0386 WATER PUMP BODY GASKET Replaces: 27-94914, 27-72780</p>
<p>PKG. OF 2</p>  <p>18-0894 18-0894-9① WATER POCKET COVER GASKET Replaces: 27-55810, 27-55810-1</p>	 <p>18-0916 WATER PUMP GASKET Replaces: 27-8052151, 27-805215, 27-94915, 27-72779</p>	<p>PKG. OF 2</p>  <p>18-0903 18-0903-9① WATER PUMP GASKET Replaces: 27-49110, FI1101000 454 CID</p>	 <p>18-0147 WATER PUMP GASKET For Ford V-8 Replaces: 27-56880</p>
 <p>18-0327 WATER PUMP GASKET Replaces: 27-33956, FI5000200, FI5000219 4 & 6 Cyl.</p>	<p>PKG. OF 2</p>  <p>18-0891 18-0891-9① WATER PUMP MOUNTING GASKET Replaces: 27-34897, 27-34896, FI5000077, FI5000078 For: GM 4.3L, 5.0L & 5.8L</p>	<p>PKG. OF 2</p>  <p>18-0893 18-0893-9① WATER PUMP BACK-IN PLATE GASKET Replaces: 27-35380 GM 4.3L, 5.0L & 5.7L</p>	<p>PKG. OF 2</p>  <p>18-2564-1 IMPELLER GASKET Alpha I - Generation 2 Replaces: 27-430331</p>

SEE PAGE 219 FOR OUR COMPLETE LINE OF GASKET SEALANTS

① Priced per Package

 <p>18-0950 IMPELLER HOUSING GASKET Replaces: 27-88046 224 CID</p>	<p>PKG. OF 2</p>  <p>18-2565 18-2565-9① IMPELLER GASKET Alpha I - Generation 2 Replaces: 27-430472</p>	<p>PKG. OF 2</p>  <p>18-2566 18-2566-9① IMPELLER GASKET Alpha I - Generation 2 Replaces: 27-817277</p>	<p>PKG. OF 2</p>  <p>18-2823 18-2823-9① LOWER WATER PUMP GASKET Replaces: 27-32769, 27-19553</p>
<p>PKG. OF 2</p>  <p>18-2824 18-2824-9① UPPER WATER PUMP GASKET Replaces: 27-32770, 27-19551</p>	<p>PKG. OF 2</p>  <p>18-2825 18-2825-9① WATER PUMP BASE GASKET Replaces: 27-32771</p>	<p>PKG. OF 2</p>  <p>18-2826 18-2826-9① WATER PUMP BASE GASKET Replaces: 27-856101, 27-856704, 27-85610</p>	<p>PKG. OF 2</p>  <p>18-2914 18-2914-9① WATER PUMP GASKET Replaces: 27-856081, 27-85608, 27-32433, 27-30603, 27-8M0090319</p>
<p>PKG. OF 2</p>  <p>18-2915 18-2915-9① WATER PUMP GASKET Replaces: 27-856091, 27-858524, 27-85609, 27-32434, 27-30604</p>	<p>PKG. OF 2</p>  <p>18-2919 18-2919-9① WATER PUMP GASKET Replaces: 27-426311, 27-42631</p>	 <p>18-0342 POWER TRIM HOSE CONNECTOR PLATE GASKET Replaces: 27-476441, 27-47644</p>	 <p>18-0388 POWER TRIM HOSE CONNECTOR GASKET Replaces: 27-988231, 27-98823</p>
<p>PKG. OF 2</p>  <p>18-0322 18-0322-9① REAR SEAL GASKET Replaces: 27-14241, 27-881715, F11101656 GM 5.0L & 5.7L</p>	 <p>18-0898 OIL PUMP MOUNTING GASKET Replaces: 27-56859 For: Ford Engines</p>	 <p>18-3289 DOUBLE LIP SEAL Replaces: 26-864319 For: Gen II Upper Housing</p>	 <p>18-2094 OIL SEAL Replaces: 26-36143, 26-88416 Fits: 120/140(1978-82), 165 (1978-81), 260 (1978-82), 470 (1978-82), 485 (1980-82), 898/228 (1978-82), Alpha I/Gen II (1991 & Up), Blackhawk (1994-95), Bravo I/II/III (1988-98), R/M/R/Alpha One Standby and Transom (1983-90)</p>
<p>PKG. OF 2</p>  <p>18-2944 18-2944-9① SEAL RING GASKET (Quad Ring) Replaces: 26-45577, 26-455771</p>	<p>PKG. OF 2</p>  <p>18-2945 18-2945-9① 18-29451-9① (PKG. OF 50) DRAIN SCREW GASKET Replaces: 12-20260, 12-19183, 12-191832, 12-191833, F50556, F8077, F8186 Used in most lower units and sea water pumps</p>	<p>PKG. OF 5</p>  <p>18-2948 18-2948-9① RUBBER WASHER Replaces: 12-492211, 12-49221, 12-23245</p>	 <p>18-2349 SHIFT SHAFT SLEEVE Replaces: 23-67370 For: Ratios 1.47, 1.62, 1.81 & 1.94. For: Gen II (1998 & up), (DL100040 & up) 1/4" Thick</p>

SEE PAGE 219 FOR OUR COMPLETE LINE OF GASKET SEALANTS

① Priced per Package

<p>PKG. OF 2</p>  <p>18-0905 18-0905-9Ⓜ OIL PAN DRAIN PLUG GASKET Replaces: 27-49955, 27-34502, 27-60721, 27-8M0077608</p>	<p>PKG. OF 2</p>  <p>18-4267 18-4267-9Ⓜ SHIFT SHAFT WASHER Replaces: 12-29395, 12-8M0042641</p>	<p>PKG. OF 3</p>  <p>18-0681 18-0681-9Ⓜ WASHER Replaces: 12-32834, 12-8M2001219, 12-93416, 12-934161</p>	<p>PKG. OF 5</p>  <p>18-0203 18-0203-9Ⓜ BELL HOUSING WASHER Replaces: 12-35935 All Mercuriser Stern drives 1963-1998</p>																		
<p>PKG. OF 5</p>  <p>18-2316 18-2316-9Ⓜ SHIFT SHAFT WASHER Replaces: 12-77674, 12-25410 Used over 18-2349 sleeve For: Ratios 1.47, 1.62, 1.81 & 1.94 For: Gen II (1998 & up), (0L100040 & up) 1/8" Thick</p>	 <p>18-0318 WASHER Replaces: 12-815472</p>	<p>PKG. OF 2</p>  <p>18-4270 18-4270-9Ⓜ WASHER Replaces: 12-36001</p>	<p>PKG. OF 5</p>  <p>18-2340 18-2340-9Ⓜ SHIFT SHAFT WASHER Replaces: 12-31266 For: #1R/MR (1/16" Thick)</p>																		
<p>PKG. OF 2</p>  <p>18-2343 18-2343-9Ⓜ PINION NUT WASHER Replaces: 12-92721 For: MR/Alpha/Gen II</p>	<p style="text-align: center;">SCREWS</p> <table border="1"> <thead> <tr> <th>Part No.</th> <th>Description</th> <th>O.E. #</th> </tr> </thead> <tbody> <tr> <td>18-2361</td> <td>(PKG. OF 2)</td> <td>10-805783, 10-853163</td> </tr> <tr> <td>18-2361-9Ⓜ</td> <td>Lower Unit Mounting Screw</td> <td>10-30206</td> </tr> <tr> <td>18-3197</td> <td>Water Pick-Up Insert Screw</td> <td>10-76156, 10-67373</td> </tr> <tr> <td>18-3230</td> <td>Gear Housing to Drive Shaft Housing Screw</td> <td>10-816601</td> </tr> <tr> <td>18-3231</td> <td>Upper Drive Shaft Top Cover Screw</td> <td>10-98704</td> </tr> </tbody> </table>		Part No.	Description	O.E. #	18-2361	(PKG. OF 2)	10-805783, 10-853163	18-2361-9Ⓜ	Lower Unit Mounting Screw	10-30206	18-3197	Water Pick-Up Insert Screw	10-76156, 10-67373	18-3230	Gear Housing to Drive Shaft Housing Screw	10-816601	18-3231	Upper Drive Shaft Top Cover Screw	10-98704	 <p>18-3721 18-3721-9Ⓜ NUT Replaces: 11-13439-1, 11-859116 For: MR/Alpha</p>
Part No.	Description	O.E. #																			
18-2361	(PKG. OF 2)	10-805783, 10-853163																			
18-2361-9Ⓜ	Lower Unit Mounting Screw	10-30206																			
18-3197	Water Pick-Up Insert Screw	10-76156, 10-67373																			
18-3230	Gear Housing to Drive Shaft Housing Screw	10-816601																			
18-3231	Upper Drive Shaft Top Cover Screw	10-98704																			
 <p>18-3236 HOUSING ALIGNMENT BUSHING Replaces: 23-32632 For: #1R/MR/Alpha</p>	 <p>18-4272 WELCH PLUG O.D. 0.870" Replaces: 19-32652</p>	 <p>18-4273 WELCH PLUG O.D. 1.250" Replaces: 19-42682</p>	 <p>18-2140 ENGINE MOUNT BOLT KIT For: Mercuriser I</p>																		
 <p>18-2141 ENGINE MOUNT BOLT KIT Replaces: 10-97934A1 For: R/MR/Alpha I/ Gen II/Bravo</p>	 <p>18-3728 LOCK NUT Replaces: 11-99298, 11-863332</p>	 <p>18-3729 MOTOR MOUNT BOLT 1/2" - 20 x 5 3/8" Replaces: 10-97934, 10-36289</p>	 <p>18-2193 REAR ENGINE MOUNT Replaces: 33149, 99297A1, 99297A2 For: 120/140 HP S/N 6229717 & UP; All 224 CID Blocks; All 898, 200, 226, 230, 260, 300 & 320 HP; All 350-454 Magnums</p>																		

Ⓜ Priced per Package



18-2614
OUTDRIVE GASKET SET
 1967-1982
Replaces: 27-64818A1, 27-64818T4,
 27-64818Q4, 27-64818A20, 27-64818A4, 27-
 64818, 27-45821

Display Package

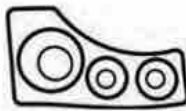

18-2615
OUTDRIVE GASKET SET
 (Bravo Unit)
Replaces: 16755, 16755A1, 16755Q1, 16755T1
 For: All Bravo

Display Package



18-2617
OUTDRIVE GASKET SET
 Old Style
Replaces: 27-35996, 27-35996A1
 For: IA/IB/IC and EZ Shift (1964-1966)

Display Package

---CONTAINS---

Part #	Description	O.E. #	Qty.
18-2820	Drive Shaft Housing to Bell Housing Gasket	27-64818	1
18-2840	Bell Housing Gasket	27-35982	1
18-7153	O-Ring	25-25439	2
18-7170	O-Ring	25-33504	1

---CONTAINS---

Part #	Description	O.E. #	Qty.
18-2516	Seal	16755	1
18-7198	O-Ring	25-45710	1
18-7153	O-Ring	25-25439	2
18-7188	O-Ring	25-48171	2
18-7109	O-Ring	25-62705	1
18-7117	O-Ring	25-35027	1

---CONTAINS---

Part #	Description	O.E. #
18-2566	Drive Shaft Housing to Bell Housing Gasket	27-35996
18-2840	Bell Housing Gasket	27-35982
18-7153	O-Ring	25-25439
18-7170	O-Ring	25-33504



18-2619-1
OUTDRIVE GASKET SET
Replaces: 27-64818A3, 27-94996Q2, 27-94996T2, 27-94996,
 27-94996A1, 27-94996A2, 27-94996A20, 27-64818A2, 27-64818A3
 For: R, MR, Alpha I, Alpha Gen II (1983-Newar)

Display Package

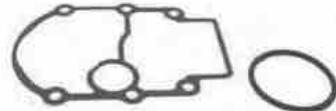

18-2620
OUTDRIVE GASKET SET
Replaces: 27-54014A1, 27-54014Q1, 27-54014T1, 27-54014
 For: E, H, TR, TRS

Display Package

---CONTAINS---

Part #	Description	O.E. #
18-2743	Drive Shaft Housing to Bell Housing Gasket	27-94996-2
18-2840	Bell Housing Gasket	27-35982
18-7153	O-Ring	25-25439
18-7170	O-Ring	25-33504
18-7117	O-Ring	25-35027

---CONTAINS---

Part #	Description	O.E. No.
18-7175	O-Ring	25-62517
18-2847	Drive Shaft Housing to Bell Housing Gasket	27-54014

Ⓛ Items ending in 'D' are Display Packaged - Regular number is Non-Display

Stam Drive Model	Beginning Serial #	Ending Serial #	Bell Housing Gasket	Bell Housing O-Ring	Bell Housing Rubber Gasket	U-Joint O-Ring (2 Required)	Gasket Set
I	1534570	1684187	—	18-7170	—	18-7153	—
IA	1684188	2062140	18-2556	18-7170	18-2840	18-7153	18-2617
IB	1684633	2062140	18-2556	18-7170	18-2840	18-7153	18-2617
IC	1685240	2065189	18-2556	18-7170	18-2840	18-7153	18-2617
II TR	3377316	4794899	18-2847	18-7175	—	—	18-2620
120	2062141	6225576	18-2820	18-7170	18-2840	18-7153	18-2614
120	6225577	UP	18-2743	18-7170	18-2840	18-7153	18-2619-1
120	6225577	UP	18-2743 Ⓛ	18-7170	18-2840	18-7153	18-2619-1
140	2062141	6225576	18-2820	18-7170	18-2840	18-7153	18-2614
140	6225577	UP	18-2743	18-7170	18-2840	18-7153	18-2619-1
140	6225577	UP	18-2743 Ⓛ	18-7170	18-2840	18-7153	18-2619-1
160	2065190	2763441	18-2820	18-7170	18-2840	18-7153	18-2614
165	2763442	UP	18-2820	18-7170	18-2840	18-7153	18-2614
170	6225577	UP	18-2743	18-7170	18-2840	18-7153	18-2619-1
170	6225577	UP	18-2743 Ⓛ	18-7170	18-2840	18-7153	18-2619-1
185	6225577	UP	18-2743	18-7170	18-2840	18-7153	18-2619-1
185	6225577	UP	18-2743 Ⓛ	18-7170	18-2840	18-7153	18-2619-1
190	6225577	UP	18-2743	18-7170	18-2840	18-7153	18-2619-1
190	6225577	UP	18-2743 Ⓛ	18-7170	18-2840	18-7153	18-2619-1
200	6225577	UP	18-2743	18-7170	18-2840	18-7153	18-2619-1
200	6225577	UP	18-2743 Ⓛ	18-7170	18-2840	18-7153	18-2619-1
215 E/H	2782203	2915034	18-2847	18-7175	—	18-7153 Ⓛ	18-2620
225	3856268	4200499	18-2820	18-7170	18-2840	18-7153	18-2614
228	4782330	6225576	18-2820	18-7170	18-2840	18-7153	18-2614
228	6225577	UP	18-2743	18-7170	18-2840	18-7153	18-2619-1
228	6225577	UP	18-2743 Ⓛ	18-7170	18-2840	18-7153	18-2619-1
230	6225577	UP	18-2743	18-7170	18-2840	18-7153	18-2619-1
230	6225577	UP	18-2743 Ⓛ	18-7170	18-2840	18-7153	18-2619-1
233	4200500	UP	18-2820	18-7170	18-2840	18-7153	18-2614
250	4791300	4898729	18-2820	18-7170	18-2840	18-7153	18-2614

Ⓛ Hydraulic Shift Only Ⓜ Borg Warner Transmission Only Ⓨ For housing with oil reservoir check valve

CHART CONTINUED ON NEXT PAGE

Stem Drive Model	Beginning Serial #	Ending Serial #	Bell Housing Gasket	Bell Housing O-Ring	Bell Housing Rubber Gasket	U-Joint O-Ring (2 Required)	Gasket Set
255 TRS	3377316	4203749	18-2847	18-7175	—	—	18-2620
260	4898730	6225576	18-2820	18-7170	18-2840	18-7153	18-2614
260	6225577	UP	18-2743	18-7170	18-2840	18-7153	18-2619-1
260	6225577	UP	18-2743 ③	18-7170	18-2840	18-7153	18-2619-1
280 TRS	4203750	4895399	18-2847	18-7175	—	—	18-2620
470	4208730	6225576	18-2820	18-7170	18-2840	18-7153	18-2614
470	6225577	UP	18-2743	18-7170	18-2840	18-7153	18-2619-1
470	6225577	UP	18-2743 ③	18-7170	18-2840	18-7153	18-2619-1
485	4893835	UP	18-2820	18-7170	18-2840	18-7153	18-2614
488	6225577	UP	18-2743	18-7170	18-2840	18-7153	18-2619-1
488	6225577	UP	18-2743 ③	18-7170	18-2840	18-7153	18-2619-1
888	3106717	UP	18-2820	18-7170	18-2840	18-7153	18-2614
898	4782330	6225576	18-2820	18-7170	18-2840	18-7153	18-2614
898	6225577	UP	18-2743	18-7170	18-2840	18-7153	18-2619-1
898	6225577	UP	18-2743 ③	18-7170	18-2840	18-7153	18-2619-1
R/MR/Alpha One	6225577	UP	18-2743	18-7170	18-2840	18-7153	18-2619-1
R/MR/Alpha One	6225577	up	18-2743 ③	18-7170	18-2840	18-7153	18-2619-1
Bravo (I/II)	B664190	UP	18-2516	—	—	18-7153	18-2615
TR-TRS	4794900	UP	18-2847	18-7175	18-2847	18-7153 ②	18-2620

① Hydraulic Shift Only ② Borg Warner Transmission Only ③ For housing with oil reservoir check valve

**All Sierra products
meet or exceed the
original equipment part
it replaces.**



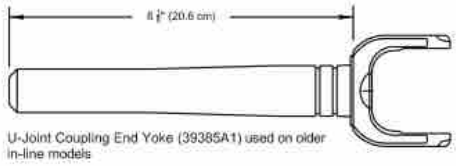
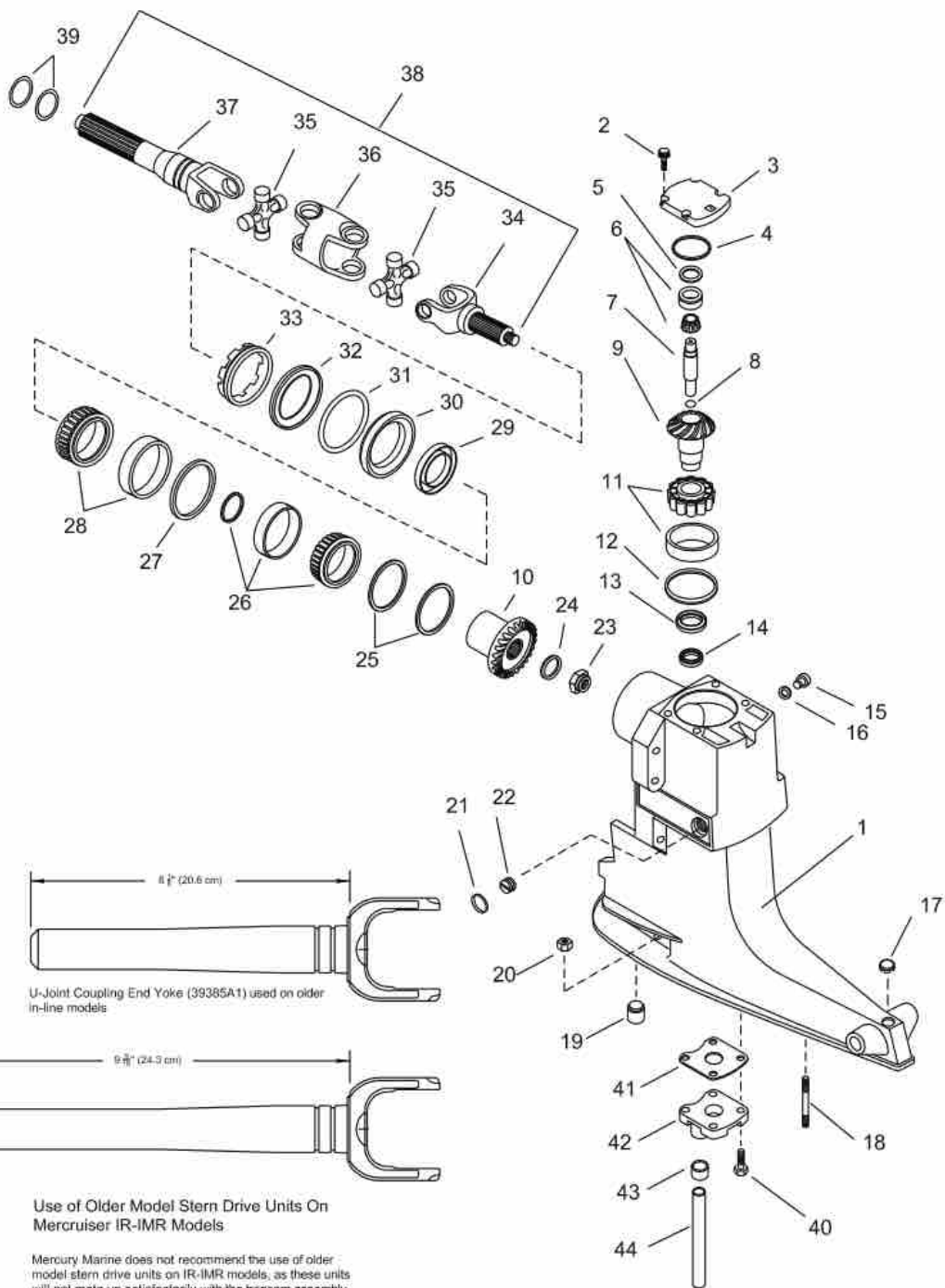

U-Joint Coupling End Yoke (39385A1) used on older in-line models

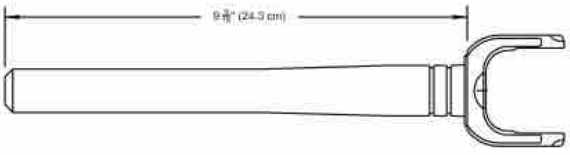

Use of Older Model Stern Drive Units On Mercruiser IR-IMR Models

Mercury Marine does not recommend the use of older model stern drive units on IR-IMR models, as these units will not mate up satisfactorily with the transom assembly. In addition, the older model in-line stern drive units are equipped with U-Joint coupling end yoke (39385A1). This yoke is shorter than yoke (59830A1) used on the IR-IMR stern drive units, and therefore, will not fully engage the engine coupler splines. **Use of an older In-Line model stern drive unit on a IR-IMR model will result in a spline failure to coupling and/or yoke.**

Figure #	Description	Part #	OEM #	Qty.
1	Upper Gear Housing	N/A	1547-9412A18	1
2	Screw, Top Cover	18-3231	10-98794	4
3	Top Cover	18-2381	94998A2	1
4	O-Ring, Top Cover	18-7161	25-32546	1
5	Shim, Bearing Cup to Top Cover	18-2283	15-45691A1	1
6	Tapered Roller Bearing	18-1165	31-61100A1	1
7	Upper Drive Shaft	N/A		1
8	O-Ring, Upper Drive Shaft	N/A	25-55801	1
9/10.	Upper Unit Gear Set	N/A		
	1.5:1	18-2201	43-18410A2, 46-18411A2	1
	Rebuild Kit	18-2256	43-803116T1	1
	1.65:1	18-2203	43-45814A5	1
	Rebuild Kit	18-2257	43-803112T1	1
	1.84:1	18-2204	43-75325A3	1
	Rebuild Kit	18-2258	43-803114T1	1
	1.98:1	18-2205	43-55778A3	1
	Rebuild Kit	18-2259	43-803101T1	1
11	Tapered Roller Bearing	18-1161	31-35990A1	1
12	Shim Kit, Bearing Cup to Drive Shaft Housing	18-2293	15-36178A1	1
13	Oil Seal, Upper Drive Shaft Housing	18-2049	26-32511	1
14	Oil Seal, Lower Drive Shaft Housing	18-2056	26-96503	1
15	Drain Screw	18-2244	10-79953A2	1
16	Drain Screw Gasket	18-2945	12-19183, 12-20260	1
17	Plug, Trim Tab Hole	18-3232	19-47579	1
18	Stud, Drive Shaft Housing	N/A	18-56295	2
19	Bushing, Drive Shaft Housing	18-3236	23-32632	1
20	Nut, Gear Housing Stud	18-2362	11-13439-1	3
21	Welch Plug, Drive Shaft Housing	N/A		
	(7/8" OD)	18-4272	19-32652	1
	(1 1/4" OD)	18-4273	19-42682	1
22	Pipe Plug, Water Pocket	18-4265	22-428611	1
23	Nut, Drive Gear to U-Joint	18-3713	11-22339	1
24	Washer, Drive Gear to U-Joint Nut	18-3712	12-45810	1
25	Shim Kit Drive Gear	18-2292	15-35980A1	1
26	Bearing Kit	18-1160	31-35988A2, A12	1
27	Spacer (comes with kit)	18-1160	31-35988A2, A13	1
28	Roller Bearing (comes with kit)	18-1160	31-35988A2, A13	1
29	Oil Seal	18-2003	26-64893	1
30	Carrier Assembly Oil Seal	18-0577	66081A2	1
31	O-Ring	18-7169	25-70937	1
32	Ring, Roller Bearing Retainer	18-4296	35983	1
33	Retaining Nut Drive Shaft Housing	18-3752	816811-1	1
34	Yoke Assembly	18-2125	46020T	1
35	Heavy Duty U-Joint	18-2104	75832A2	1
36	Center Socket	18-2128	39383T	1
37	U-Joint Shaft Coupler	18-2146	59830A1	1
38	Drive Shaft	18-9218	59830A5	1
39	O-Ring	18-7153	25-25439	2
40	Screw, Water Pocket Cover to Drive Shaft Housing	18-3229	10-28668	4
41	Gasket, Water Pocket Cover	18-0894	27-55810	1
42	Water Pocket Cover (Sold as Assembly includes 40-44)	18-3219	42724A3	1
43	Bushing, Water Pump Housing	18-3110	26-38970	1
44	Water Tube	18-3220	32-54238	1

AR As required

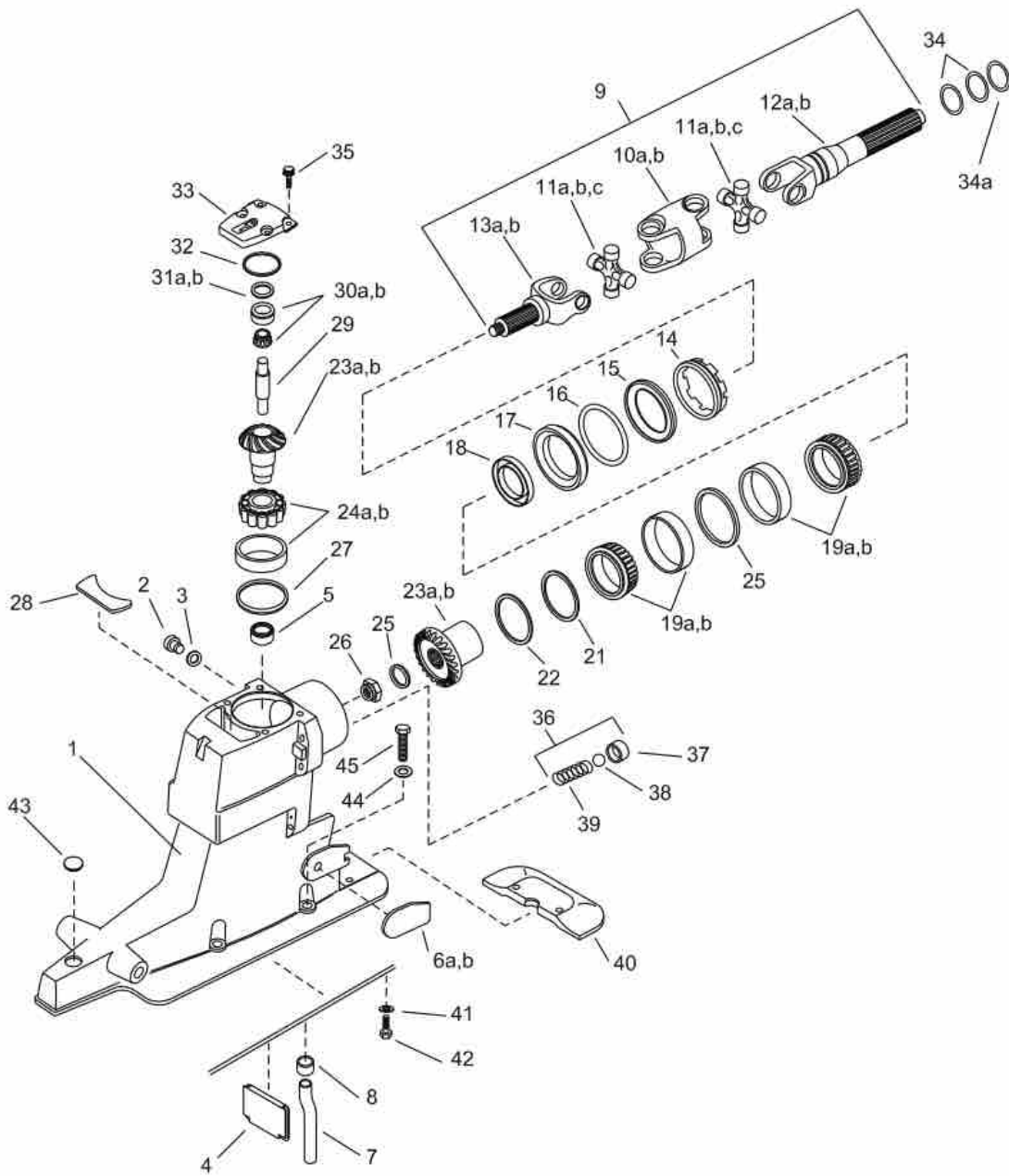

SEE PAGES 863-864 FOR COMPLETE REPLACEMENT HOUSINGS

Figure #	Description	Part #	OEM #	Qty.	Figure #	Description	Part #	OEM #	Qty.
1	Drive Shaft Housing (OL100009 & UP)	18-2411	1547-861063A 4	1		1.84:1/ 1.81:1 Gear Set (tooth count... 17/19)	18-2204	43-75325A3	1
2	Drain Screw	18-2244	10-79953A2	1		Std. Rebuild Kit	18-2258	43-803114T 1	1
3	Drain Screw Gasket	18-2945	12-19183, 12-20260	1		Complete Service Kit	18-2365	43-803120 T 1	1
4	Filler Wall	N/A	815932	1		1.98:1/ 1.94:1 Gear Set (tooth count... 20/24)	18-2205	43-55778A3	1
5	Oil Seal	18-2056	26-66302	AR		Std. Rebuild Kit	18-2259	43-803101T 1	1
6a	Wear Pad (Port)	NSS	814386	1		Complete Service Kit	18-2363	43-803118T 1	1
6b	Wear Pad (Std)	NSS	814387	1	23a	Upper Unit Gear Set (OL100009 & UP)			
7	Water Tube	18-3221	32-860220	1		1.47:1 Gear Set (tooth count... 20/22)	18-6351	43-853641A2	1
8	Seal	NSS	26-88397	1		Complete Service Kit	18-6351K	43-803103T 1	1
9	Yoke Assembly (OK999999 & Below)	18-9218	814819A2	1		1.81:1 Gear Set (tooth count... 17/19)	18-6353	43-853643A2	1
	Yoke Assembly (OL100009 & UP)	NSS	864281A2	1		Complete Service Kit	18-6353K	43-803105T 1	1
10a	Socket, Center (old design)	18-2128	343831, 39383T	1		1.94 & 2.4:1 Gear Set (tooth count... 20/24)	18-6352	43-853642A2	1
10b	Socket, Center GKN Series	NSS	865503T	1		Complete Service Kit	18-6352K	43-803106T 1	1
11	Cross and Bearing				24	Roller Bearing (All but 1.47:1 ratio)	18-1161	43-803106T 1	1
11a	D469859 - F679999 (old design)	18-2174	75832A2	2	24a	Roller Bearing (1.47:1 Ratio only)	18-1142	31-32573A 1	1
11b	F680000 - OK999999 (old design- permalube)	18-2097	8055361, 805536A1, 805536A2	2	25	Washer	18-3712	12-45810	1
11c	OL100009 & UP (GKN Series)	18-6406	865493A01	2	26	Nut	18-3713	11-22339	1
12a	Yoke, Coupling End (OK999999 & Below)	18-2146	59830A1	1	27	Shim Kit	18-2293	15-36178A1	1
12b	Yoke, Coupling End (OL100009 & UP)	NSS	865491A01	1	28	Plug	NSS	861738	1
13a	Yoke, Gear End (OK999999 & Below)	18-2125	46020T	1	29	Drive Shaft, Upper (F680000 & Up)	18-2324	45-55796-1	1
13b	Yoke, Gear End (OL100009 & UP)	NSS	865492T	1	30	Bearing Assembly			
14	Retaining Nut	18-3752	816811-1	1	30a	F680000 & UP (small bearing)	18-1179	31-32575A1	1
15	Ring	18-4296	35983	1	30b	D494569 - F679999 (large bearing)	18-1165	31-61100A1	1
16	O-Ring	18-7169	25-70937	1	31	Shim Kit			
17	Carrier Assembly (Set)	18-0577	66081A2	1	31a	D494569 - F679999	18-2283	15-45691A1	1
18	Oil Seal	18-2003	26-68493	1	31b	F680000 & UP	18-2282	15-32563A1	1
19	Roller Bearing Kit (D469859 - K999999)	18-1160	31-35988A2, A12	1	32	O-Ring	18-7161	25-32546	1
19a	Roller Bearing Kit (OL100009 & UP)	18-1182	31-30894A 15	1	33	Cover Assembly, Top (F680000 & Up)	18-2382	828692A1	1
20	Cup Spacer (Included with 18-1160)	18-1160	31-35988A2, A12	AR	34	O-Ring	18-7153	25-25439	2
20a	Cup Spacer (Included with 18-1182)	NSS	23-853649A 1	AR	34a	O-Ring	18-7117	25-35027	1
21	Shim Kit	18-2292	15-35980A1	1	35	Screw	18-3231	10-98794	4
22	Shim Spacer	18-2296	15-71013	1	36	Check Valve Kit, Oil Passage	18-2715 KIT	24-17997A1	1
23	Upper Unit Gear Set (0D469859-OK999999)				37	Oil Seal (Included in Kit)	NSS	—	1
	1.5:1/ 1.47:1 Gear Set (tooth count... 20/22)	18-2201	43-18410A2, 43-18411A2	1	38	Ball (Included in Kit)	NSS	—	1
	Std. Rebuild Kit	18-2258	43-803116T 1	1	39	Spring	NSS	—	1
	Complete Service Kit	18-2358	43-803102T 1	1	40	Anode Plate	18-6080	821629A1	1
	1.65:1/ 1.62:1 Gear Set (tooth count... 24/24)	18-2203	43-45814A5	1	41	Lockwasher	N/A	13-78968	2
	Std. Rebuild Kit	18-2257	43-803112T 1	1	42	Screw	18-3229	10-28668	2
	Complete Service Kit	18-2364	43-803119T 1	1	43	Plug	N/A	19-824928	1
					44	Washer	18-4858-9	12-45176	4
					45	Bolt	18-3230	10-816601	4

AR As Required

NSS Not Sold Separate

N/A Not Available

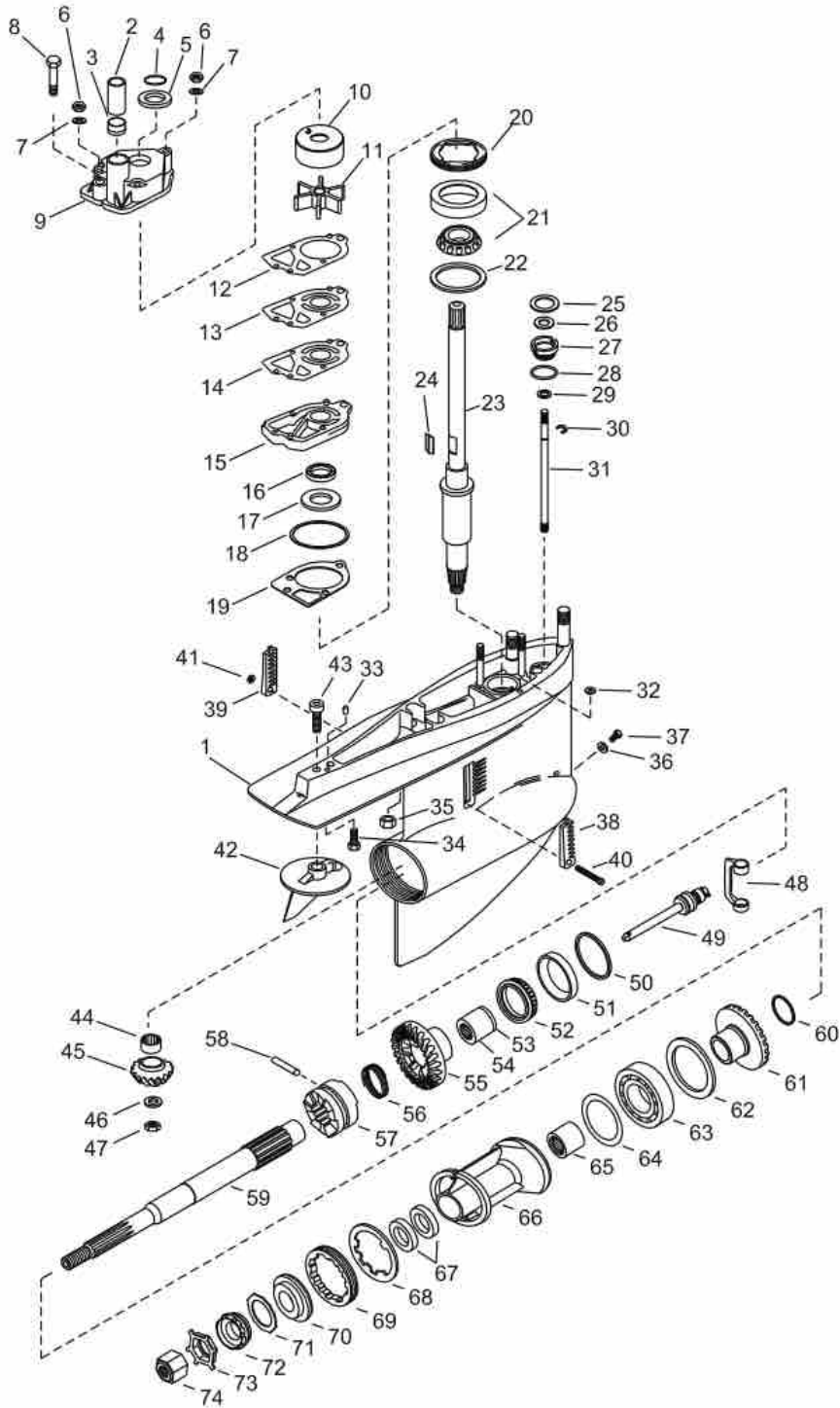

SEE PAGES 844-845 FOR COMPLETE REPLACEMENT HOUSINGS

Figure #	Description	Part #	OEM #	Qty.	Figure #	Description	Part #	OEM #	Qty.
1	Gear Housing	18-2401	1623-8951A37	1	36	Drain Screw Gasket	18-2945	12-19183, 12-20260	1
2	Water Tube Guide	18-3109	23-29804	1	37	Drain Screw	18-2244	10-79953A2	1
3	Bushing/Water Pump Housing	18-3110	26-38970	1	38	Insert, Water Pick (Std)	18-3199	93423-1	1
4	O-Ring, Upper Drive Shaft	18-7158	25-30613	1	39	Insert, Water Pick (Port)	118-3198	93424-1	1
5	Slinger	18-7426	25-30271	1	40	Screw, Insert to Gear Housing	18-3197	10-76156	1
6	Stainless Steel Locknuts (5/16-24)	N/A	11-13436	1	41	Nut, Insert Screw	18-2344	11-45812	1
	Stainless Steel Locknuts (1/4-28)	N/A	11-13438	2	42	Trim Tab	18-6011	31640A1	1
7	Washer	18-4270	12-36001	3	43	Screw, Trim Tab Gear Housing	18-6245	10-32470	1
8	Screw, Water Pump Body to Water Pump Base	N/A	10-96411	1	44	Pinion Bearing	18-1117	31-42647A1	1
9	Upper Pump Housing	18-3116	46-96148A1	1	45	Lower Alpha Gear Set (pinion gear)	18-2206	43-17064A2, 43-17064A3, 43-42934	1
10	Insert Cup	18-3114	48752	1	46	Anti-Galling Washer Pinion Gear	18-2343	22-92721	1
11	Impeller	18-3017	47-89984	1	47	Pinion Nut	18-3719	11-35921	1
12	Gasket, Upper Water Pump to Wear Plate	18-2915	27-85608-1	1	48	Shift Crank	18-2130	76865	1
13	Impeller Plate	18-3117	32435	1	49	Shift Spool Assembly	18-2286	818349A1	1
14	Gasket, Wear Plate to Water Pump Base	18-2914	27-85608-1	1	50	Shim Kit, Forward Gear	18-2286	15-47397A1	1
15	Water Pump Base	18-3420	46-44292A3	1	51	Tapered Roller Bearing Set	18-1159	31-35928A1	1
16	Oil Seal (upper)	18-2013	26-16977	1	52	Inner Bearing, Forward Gear	18-1157	31-30895	1
17	Oil Seal (lower)	18-2014	26-89238	1	53	Retaining Clip, Inner Bearing	N/A	—	1
18	O-Ring, Water Pump	18-7176	25-90011	1	54	Retaining Clip, Inner Bearing	18-1157	31-30895	1
19	Gasket, Water Pump Base to Gear Housing	18-2919	27-42631-1	1	55	Lower Alpha Gear Set (Forward Gear/Pinion)	18-2206	43-17064A2, 43-17064A3, 43-42934	1
20	Retainer, Drive Shaft Bearing	18-2346	824518	1	56	Spring, Retainer - Cross Pin	18-2348	24-30893	1
21	Tapered Roller Bearing Drive Shaft	18-1143	31-36387A1	1	57	Sliding Clutch	18-2202	52-66063	1
22	Shim Kit, Lower Drive Shaft Bearing	18-2294	15-42637A1	1	58	Cross Pin, Clutch to Actuating Shaft	18-2357	24-30893	1
23	Drive Shaft	18-2180	45-42634	1	59	Propeller Shaft	18-2166	44-66060, 44-6606-3	1
24	Drive Key Water Pump Impeller	N/A	28-56654	1	60	Spacer, Reverse Gear	N/A	23-824108	1
25	Shift Shaft Washer	18-4267	12-29395	1	61	Lower Alpha Gear Set (Reverse Gear-NSS)	18-2206	43-17064A2, 43-17064A3, 43-42934	1
26	Washer Rubber Shift Shaft Bushing	18-2340	12-31266	1	62	Thrust Ring, Bearing Carrier	18-2342	68100-1	1
27	Shift Bushing	18-2154	23-30617A2	1	63	Ball Bearing	18-1155	30-88957A1	1
28	O-Ring, Shift Shaft Bushing	18-7153	25-25439	1	64	O-Ring, Bearing Carrier	18-7158	25-31534	1
29	Washer, Lower Shift Shaft	NSS	12-27880	1	65	Needle Roller Bearing	18-1158	31-30956	1
30	Retaining Clip, Shift Shaft	NSS	53-29641	1	66	Bearing Carrier	18-2191	73020A-14	1
31	Stainless Steel Shift Shaft	18-2150	77481-1	1	67	Oil Seals, Bearing Carrier	18-2002	26-76668	2
32	Oil Passage Seal	18-2944	26-45577	1	68	Tab Washer	18-2298	14-18323	1
33	Dowel Pin, Gear Housing to Drive Shaft Housing	18-3226	10-30720	2	69	Spanner Nut	18-3751	79448	1
34	Screw, Gear Housing to Drive Shaft Housing	18-2361	10-30206	1	70	Thrust Washer	18-4220	13171, 77987	1
35	Nut, Gear Housing to Drive Shaft Housing	18-2362	11-13439-1	2	71	Continuity Washer	N/A	13-423511	1
					72	Brass Castle Washer	18-3714	12-31211A2	1
					73	Tab Washer	18-3200	14-31210, 14-816629	1
					74	Prop Nut	18-3700	11-52707	1

N/A Not Available

NSS Not Sold Separate



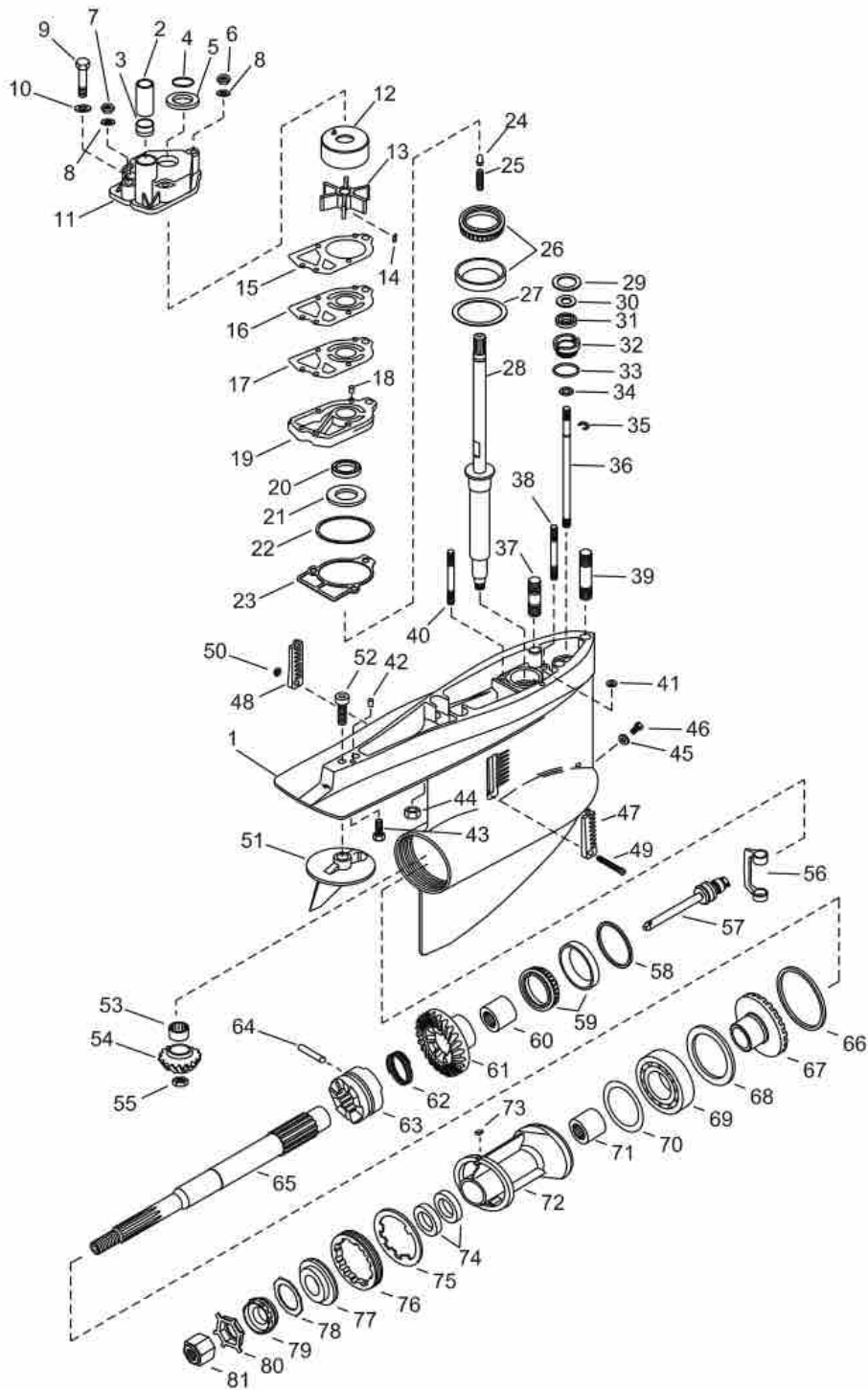
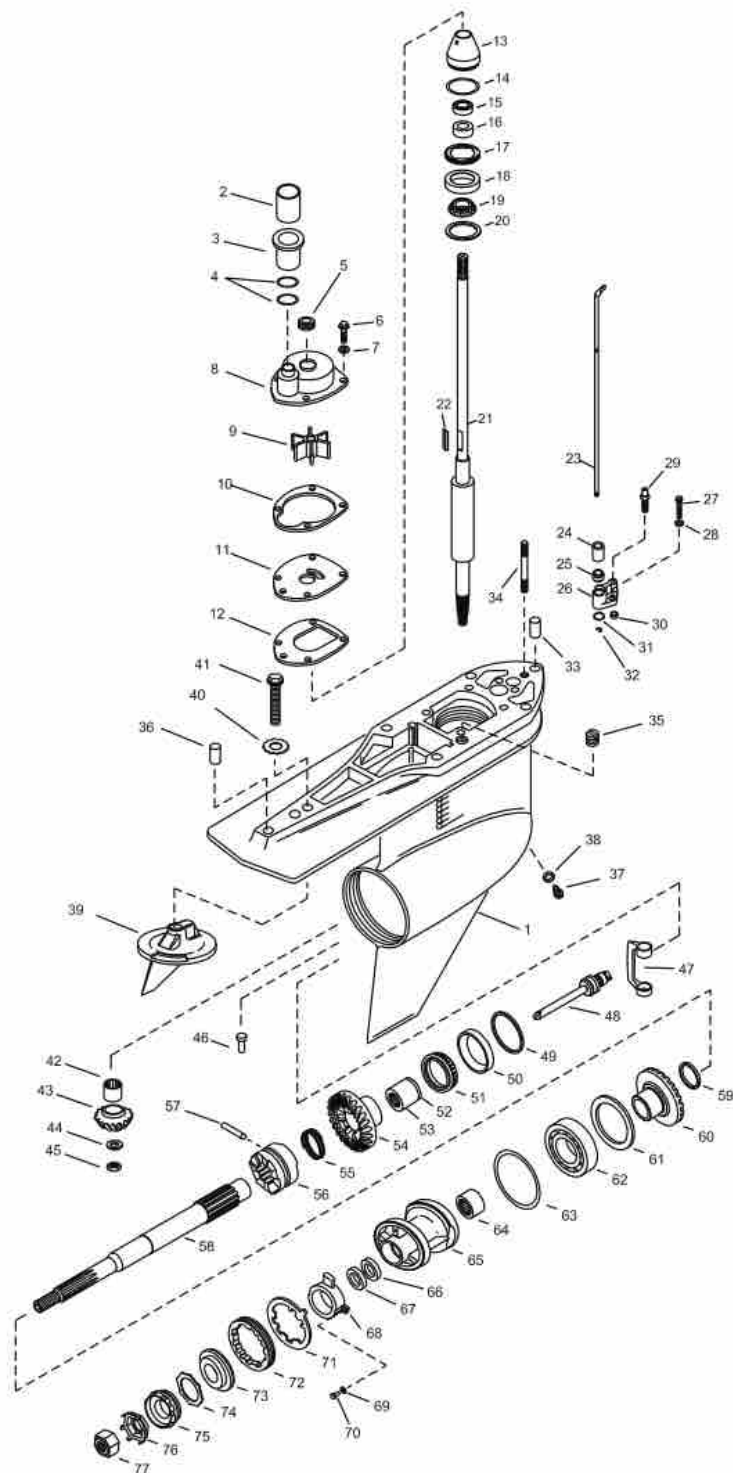

Figure #	Description	Part #	OEM #	Qty.	Figure #	Description	Part #	OEM #	Qty.
1	Lower Gear Housing	N/A	1623-5356A4	1	41	Oil Passage Seal	18-2944	26-45577	1
2	Water Tube Guide	18-3109	23-29804	1	42	Dowel Pin, Gear Housing to Drive Shaft Housing	N/A	17-35973	2
3	Bush Water Pump Housing	18-3110	26-38970	1	43	Screw, Gear Housing to Drive Shaft Housing	18-2361	10-30206	1
4	O-Ring, Upper Drive Shaft	18-7158	25-30613	1	44	Nut Gear Housing to Drive Shaft Housing	N/A	11-82671015	2
5	Slinger	18-7426	25-30271	1	45	Drain Screw Gasket	18-2945	12-19183, 12-20260	1
6	Stainless Steel Locknuts (5/16-24)	18-3723	11-45592	1	46	Drain Screw	18-2244	10-79953A2	1
7	Stainless Steel Locknuts (1/4-28)	18-3722	11-20361, 11-35886	2	47	Insert, Water Pick (Sbd)	N/A	66885	1
8	Washer	18-4275	12-29245	3	48	Insert, Water Pick (Port)	N/A	66884	1
9	Screw	18-3226	10-30720	1	49	Screw Insert to Gear Housing	18-3197	10-76156	1
10	Washer, Water Pump Body	18-4270	12-36001	1	50	Nut, Insert Screw	18-2344	11-45812	1
11	Upper Pump Housing	18-3116	46-96148A1	1	51	Trim Tab	18-6011	31640A1	1
12	Insert Cup	18-3114	48752	1	52	Screw, Trim Tab to Gear Housing	18-6245	10-32470	1
13	Impeller	18-3017	47-89984	1	53	Needle Roller Bearing	N/A	31-92366A1	1
14	Drive Key	N/A	28-56654	1	54	Lower Unit Gear Set (pinion gear)	18-2200	23-96084A4	1
15	Gasket, Upper Water Pump to Wear Plate (upper)	18-2915	27-85609-1	1	55	Pinion Nut	18-3719	11-35921	1
16	Impeller Plate	18-3117	32435	1	56	Shift Crank	18-2130	76865	1
17	Gasket, Upper Water Pump to Wear Plate (lower)	18-2914	27-85608-1	1	57	Shift Spool Assembly	19755A2	15-2285	1
18	Dowel Pin	18-3227-9	17-35973	2	58	Shim Kit, Forward Gear Bearing	18-2285	15-47397A1	1
19	Water Pump Base	18-3417	46-57234A1	1	59	Tapered Roller Bearing	18-1159	31-35926A1	1
20	Oil Seal (upper)	18-2026	26-16977	1	60	Needle Roller Bearing	18-1157	31-30895	1
21	Oil Seal (lower)	18-2014	26-89238	1	61	Lower Unit Gear Set (Forward)	18-2200	23-96084A4	1
22	O-Ring (2.175 ID) & (2.1091 ID)	18-7176, 18-7196	25-90011	1	62	Spring, Retainer, Cross Pin	18-2348	24-30893	1
23	Gasket, Water Pump Base to Gear Housing	18-2826	27-85610-1	1	63	Sliding Clutch	15-2202	52-66063	1
24	Pin, Driveshaft	N/A	17-30545	1	64	Cross Pin, Clutch to Clutch Actuating Shaft	18-2348	17-30632	1
25	Spring	N/A	24-34576	1	65	Propeller Shaft	15-2166	44-66060, 44-66060-3	1
26	Tapered Roller Bearing	N/A	31-53079A1	1	66	Lower Unit Gear Set (reverse)	18-2200	43-96084A4	1
27	Shim Kit, Drive Shaft Bearing	18-2295	15-57007A	1	67	Thrust Ring, Bearing Carrier	18-3759	35915	1
28	Drive Shaft	N/A	45-41939A1	1	68	Ball Bearing	18-1155	30-88957A1	1
29	Shift Shaft Washer	18-4267	12-29395	1	69	O-Ring	18-7159	25-31534	1
30	Washer, Rubber Shift Shaft Bushing	18-2340	12-31266	1	70	Needle Roller Bearing	18-1158	31-30956	1
31	Oil Seal	26-89236	18-2009	1	71	Bearing Carrier Assembly	15-2191	73020A14	1
32	Shift Bushing	18-2154	23-30617A2	1	72	Key, Locating - Bearing Carrier	N/A	28-30281	1
33	O-Ring	18-7153	25-25439	1	73	Oil Seals	18-2002	26-76868	2
34	Washer, Lower Shift Shaft Bushing	N/A	12-27880	1	74	Tab Washer	18-2299	14-79447	1
35	Retaining Clip, Shift Shaft	18-4295	63-29641	1	75	Spanner Nut	18-3751	79448	1
36	Stainless Steel Shift Shaft	18-2150	77481-1	1	76	Thrust Washer	18-4220	13171, 77987	1
37	Stud, Gear Housing to Drive Shaft Housing (1-31/32")	N/A	16-56298	2	77	Continuity Washer	NSS	13-423511	1
38	Stud, Water Pump to Gear Housing (3 - 3/8")	N/A	16-56292	1	78	Brass Castle Washer	18-3714	12-31211A2	1
39	Stud, Gear Housing to Drive Shaft Housing (3 - 3/16")	N/A	16-46911	1	79	Tab Washer	18-3200	14-31210, 14-816629	1
40	Stud, Water Pump to Gear Housing (3 - 1/4")	N/A	16-69501	2	80	Prop Nut	18-3700	11-52707	1

AR As required NSS Not Sold Separate





SEE PAGES 844-845 FOR COMPLETE REPLACEMENT HOUSINGS

Figure #	Description	Part #	OEM #	Qty.	Figure #	Description	Part #	OEM #	Qty.
1	Gear Housing	18-2415	1623-815822A36	1	39	Trim Tab	18-6016	76214A5	1
2	Sleeve	—	23-816573	1	40	Washer, Anode Mounting	—	13-806210	1
3	Coupling	18-3151	816597A1	1	41	Bolt, Anode Mounting	—	10-806327	1
4	O-Rings	18-7420	25-21836	2	42	Pinion Bearing	18-1117	31-42647A1	1
5	Face Seal	18-2599	26-816575A2	1	43	Pinion Gear	18-2206	43-828072A2	1
6	Screw, 10-32 X 5/8	NSS	10-816928	4	44	Washer	18-2943	12-92721	1
7	Star Washer	NSS	13-69432	4	45	Nut	18-3719	11-35921	1
8	Water Pump Body	18-3147	817275A1	1	46	Pin	—	17-37972-1	1
9	Impeller	18-3056	47-43026-2	1	47	Shift Crank	18-2130	78865	1
10	Gasket	18-2563	27-817277	1	48	Shift Spool Assembly	18-2286	818349A1	1
11	Face Plate	18-3122	817276	1	49	Shim Kit	18-2285	15-47397A1	1
12	Gasket	18-2564-1	27-43033-1	1	50 & 51	Forward Gear, Outer Bearing	18-1159	31-35926A1	1
13	Seal Carrier	18-2354	821759A2	1	52	Retaining Clip, Inner Bearing	NSS	—	1
14	O-Ring	18-7176	25-90011	1	53	Forward Gear, Inner Bearing	18-1157	31-30895	1
15	Seal	18-2013	26-16977	1	54	Forward Gear	18-2206	43-828072A2	1
16	Seal	18-2014	26-89238	1	55	Cross Pin Spring	18-2348	24-30893	1
17	Cover Nut	18-2346	824519	1	56	Sliding Clutch	18-2202	52-824112	1
18 & 19	Bearing, Upper Driveshaft (1.50-1.65 Ratio)	18-1143	31-36387A1	1	57	Cross Pin	18-2357	17-30632	1
20	Shim Kit	18-2294	15-42637A1	1	58	Propeller Shaft	18-2166	44-824110	1
21	Drive Shaft (1:47 & 1:62)	18-2331	45-853648	1	59	Spacer	—	23-824108	1
	Drive Shaft (1:50 & 1:65)	18-2261	45-816919	1	60	Reverse Gear	18-2206	43-828072A2	1
	Drive Shaft (1:84 & 1:98) (Early Style use with 18-1143)	—	45-816472	1	61	Thrust Ring	18-2342	681001	1
22	Impeller Drive Key	18-3293	28-43037	1	62	Ball Bearing	18-1155	30-88957A1	1
23	Shift Shaft	18-2320	815919A1	1	63	O-Ring	18-7159	25-31534	1
24	Sleeve	18-2349	23-67370	1	64	Roller Bearing	18-1158	31-30956	1
25	Seal	18-2009	26-89236	1	65	Bearing Carrier	18-2376	818763A10	1
26	Shift Rod Bushing Assembly	18-2353	23-815921A21	1	66	Seal	18-2002	26-14077	1
27	Screw, 10-32 X 5/8	NSS	10-806290	2	67	Seal	18-2076	26-12224	1
28	Star Washer	NSS	13-69432	2	68	Carrier Anode	18-8093	806105A1	1
29	Speedometer Pickup Fitting	—	NSS	1	69	Lockwasher, Anode Mounting	—	13-69432	2
30	O-Ring	18-7440-1	25-36318	1	70	Bolt, Anode Mounting	—	10-806290	2
31	O-Ring	18-7440-1	25-36318	1	71	Tab Washer	18-2298	14-18323	1
32	Retaining Ring	18-4295	53-29641	1	72	Cover Nut	18-3751	79448	1
33	Dowel Pin	—	17-43044	1	73	Thrust Hub	18-4220	13171	1
34	Stud, Mounting	—	16-57984	1	74	Continuity Washer	NSS	13-42351-1	1
35	Seal	18-2944	26-45577	1	75	Splined Washer	18-3714	12-31211A2	1
36	Dowel Pin	—	17-43044	1	76	Tab Washer	18-3200	14-31210	1
37	Plug	18-2375	22-67892A1	1	77	Propeller Nut	18-3700	11-52707	1
38	Drain Screw Gasket	18-2945	12-19163	1		Seal Kit (Not Pictured)	18-2646-1	26-816575A3	1

NSS Not Sold Separate





18-2292 SHIM KIT

Drive Gear
Replaces: 15-35980A1
 Contains (1) each
 .002, .003, .005, .006, .010, .025
For: Mercuriser Vazer



18-2293 SHIM KIT

Upper Bearing
Replaces: 15-36178A1, 15-36178A02,
 15-39899A1, 15-23097A1
 Contains (1) each .002, .003, .015
 (2) each .010
For: Mercuriser Vazer

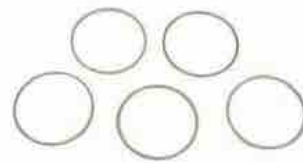

18-2294 SHIM KIT

Lower Drive Shaft Bearing
Replaces: 15-8M0063267, 15-42637A1
 Contains (1) each
 .002, .003, .005, .010, .020
For: Mercuriser Vazer



18-2295 SHIM KIT

Lower Drive Shaft Bearing
Replaces: 15-57007A1, 15-33143A1
 Contains (1) each
 .002, .003, .005, .010, .020
For: Mercuriser Vazer

SHIMS

Part No.	Size	O.E. #
18-0208	.208	23-1761515 Ⓢ
18-0210	.210	23-1761516 Ⓢ
18-0212	.212	23-1761517 Ⓢ
18-0214	.214	23-1761518 Ⓢ
18-0216	.216	23-1761519 Ⓢ
18-0218	.218	23-1761520 Ⓢ
18-0230	.230	23-1761526 Ⓢ
18-0222	.222	23-1761522 Ⓢ
18-0224	.224	23-1761523 Ⓢ
18-0226	.226	23-1761524 Ⓢ

Part No.	Size	O.E. #
*18-2282	Kit	15-32563A1 + For: Mercuriser Vazer
*18-2283	Kit	15-45691A1
*18-2285	Kit	15-35931A1, 15-47397A1
*18-2296	.055	15-71013, 15-45811

- * 18-2282 (1) each .002, .003, .005, .010, .025
- * 18-2283 (1) each .002, .003, .005, .010
- * 18-2285 (1) each .002, .003, .005, .010, .020

SHIM KIT APPLICATION

HP	Serial No.	Bearing to Top Cover Kit	Bearing Cup to Drive Shaft Housing	Drive Gear	Drive Gear Spacer	Drive Shaft Bearing to Gear Housing	Reverse Gear	Forward Gear Kit
120/140	2062141 thru 2791956	18-2282 Ⓢ	18-2293	18-2292	18-2296	18-2295	—	18-2285
120/140	2791957 thru 4893634	18-2283 Ⓢ	18-2293	18-2292	18-2296	18-2295	—	18-2285
120/140	4893635 thru 6225576	18-2283	18-2293	18-2292	18-2296	18-2295	—	18-2285
160	2065190 thru 2763441	18-2282 Ⓢ	18-2293	18-2292	18-2296	18-2295	—	18-2285
165	2763442 thru 4890459	18-2283 Ⓢ	18-2293	18-2292	18-2296	18-2295	—	18-2285
165	4890460 & UP	18-2283	18-2293	18-2292	18-2296	18-2295	—	18-2285
888	3106717 & UP	18-2283 Ⓢ	18-2293	18-2292	18-2296	18-2295	—	18-2285
898/228	4782330 thru 4898729	18-2283	18-2293	18-2292	18-2296	18-2295	—	18-2285
898/228	4898730 thru 6225576	18-2283	18-2293	18-2292	18-2296	18-2295	—	18-2285
225-S	3856268 thru 4200499	18-2283	18-2293	18-2292	18-2296	18-2295	—	18-2285
233	4200500 & UP	18-2283	18-2293	18-2292	18-2296	18-2295	—	18-2285
250	4791300 thru 4898729	18-2283	18-2293	18-2292	18-2296	18-2295	—	18-2285
260	4898730 thru 6225576	18-2283	18-2293	18-2292	18-2296	18-2295	—	18-2285
470	4208730 thru 4893934	18-2283	18-2293	18-2292	18-2296	18-2295	—	18-2285
470	4893935 thru 6225576	18-2283	18-2293	18-2292	18-2296	18-2295	—	18-2285
485	4893935 & UP	18-2283	18-2293	18-2292	18-2296	18-2295	—	18-2285
RMR/Alpha One	6225577 & UP (R)	18-2283	18-2293	18-2292	18-2296	18-2295	—	18-2285
RMR/Alpha One	6225577 & UP (MR)	18-2283	18-2293	18-2292	18-2296	18-2294	—	18-2285
Alpha Gen II	D494589 thru F679999	18-2283	18-2293	18-2292	18-2296	18-2294	—	18-2285
Alpha Gen II	F680000 & UP	18-2282		18-2293	18-2292	18-2296	18-2294 Ⓢ	—

Ⓢ S/N #2187468 & Below use 18-2293 Ⓢ S/N #4433200 & UP Only Ⓢ S/N #4530702 & UP Only Ⓢ Kit Ⓢ For Counter Rotation Only

18-2400 COMPLETE LOWER GEAR CASE

Replaces: 1623-815822A53,
 1623-815822A5,
 1623-815822A32,
 1623-815822A43
For: Ratios 1.47, 1.62, 1.81 & 1.94
Fits: Gen II (1998 & up) 0L100040 & up



18-2411 DRIVE SHAFT HOUSING ASSEMBLY

Replaces: 1547-861063A4
For: Gen II Upper (1998-up), 0L100040-up, 1.47:1 Ratio/Gen II Upper (1998-up) 0L100040-up, 1.62/2.00:1 Ratio's/Gen II Upper (1998-up), 0L100040-up, 1.81:1 Ratio/Gen II Upper (1998-up), 0L100040-up, 1.94/2.40:1 Ratios
Used with: 18-2416, 18-2419 Complete Upper Gear Cases





**18-2415
GEAR HOUSING ASSEMBLY**

Replaces: 1623-815822A36
For: Ratios 1.47, 1.62
 Gen II (1998 & up), (OL100040 & up)
Used with: 18-2400 Complete Lower Gear Case



**18-2416
COMPLETE UPPER GEAR CASE**

Replaces: 1547-815930A16, 1547-815930A6, 1547-861063A12
For: Alpha Gen II (1991 & UP) for gear ratios 1.47:1, 1.50:1
Used with: 18-2411 Drive Shaft Housing Assembly



**18-2419
COMPLETE UPPER GEAR CASE**

Replaces: 1547-815930A13, 1547-815930A3, 1547-861063A6
For: Alpha Gen II (1991 & UP) for gear ratios 1.98:1, 2.40:1
Used with: 18-2411 Drive Shaft Housing Assembly



**18-2450
COMPLETE UPPER GEAR CASE**

Replaces: 1547-9412A20, 1547-3917A13, 1547-3917A21, 1547-3917A32, 1547-3917A37, 1547-5523A2, 1547-5523A9, 1547-5523A12, 1547-5523A68, 1547-8265A15, 1547-9412A30, 1547-9412A35
For: Alpha I
 1.5:1/1.47:1



**18-2451
COMPLETE
UPPER GEAR CASE**

Replaces: 1547-9412A21, 1547-3917A4, 1547-3917A8, 1547-3917A16, 1547-3917A30, 1547-3917A38, 1547-5523A8, 1547-5523A11, 1547-8265A16
For: Alpha I
 1.65:1/1.62:1



**18-2452
COMPLETE
UPPER GEAR CASE**

Replaces: 1547-9412A22, 1547-5523A67, 1547-8265A17, 1547-9412A36
For: Alpha I
 1.84:1/1.81:1



**18-2453
COMPLETE
UPPER GEAR CASE**

Replaces: 1547-9412A23, 1547-5523A49, 1547-5523A67, 1547-8265A17
For: Alpha I
 1.98:1/1.94:1



**18-2443
COMPLETE
LOWER GEAR CASE**

Replaces: 1623-8951A43, 1623-4110A4, 1623-4110A6, 1623-4110A13, 1623-5356A3, 1623-5356A16, 1623-5356A19, 1623-5356A20, 1623-8951A2, 1623-8951A14, 1623-8951A19, 1623-8951A23
For: R/MR/ALPHA I



**18-2401
LOWER GEAR HOUSING**

Replaces: 1623-8951A27, 1623-8951A37, 1623-8951A5, 1623-8951A15
For: MR/ALPHA Style
 Bore size 3.2635-3.2650. Includes tapered roller bearing for non-tractor 14/28 or 17/28 gears. When installing new gears use 18-2206-1 gear kit which includes tapered roller bearing 18-1156 for tractor 13/21 gears.



**18-2402
LOWER GEAR HOUSING**

Replaces: 1623-5356A4
For: R Style



18-2368
LOWER GEARCASE KIT
 Replaces: 43-803069T1
 ALPHA/Gen II 1991-95



18-2369
LOWER GEARCASE KIT
 Replaces: 43-803069T1
 ALPHA/Gen II 1991-95



18-2358
UPPER UNIT
GEAR REPAIR KIT
 Replaces: 43-803102T1
 For: 20-22 Teeth: 1.50:1 (1.47:1)
 Gen II applications serial number range up to OK999999 only



18-2363
UPPER UNIT
GEAR REPAIR KIT
 Replaces: 43-803118T1
 For: 20-24 Teeth: 1.98:1 (1.94/2.40:1)
 Gen II applications serial number range up to OK999999 only



18-2364
UPPER UNIT
GEAR REPAIR KIT
 Replaces: 43-803119T1
 For: 24-24 Teeth: 1.85:1 (1.82:1)
 Gen II applications serial number range up to OK999999 only



18-2365
UPPER UNIT
GEAR REPAIR KIT
 Replaces: 43-803120T1
 For: 17-19 Teeth: 1.84:1 (1.81:1)
 Gen II applications serial number range up to OK999999 only



18-6351K
UPPER UNIT
GEAR REPAIR KIT
 Replaces: 43-803103T1
 For: Gen II (1998 & Up)(S/N OL100040 & Up)
 1.47:1 Ratio



18-6352K
UPPER UNIT
GEAR REPAIR KIT
 Replaces: 43-803106T1
 For: Gen II (1998 & Up)(S/N OL100040 & Up)
 1.94:1 and 2.40:1 Ratio



18-6353K
UPPER UNIT
GEAR REPAIR KIT
 Replaces: 43-803105T1
 For: Gen II (1998 & Up)(S/N OL100040 & Up)
 1.81:1 Ratio



18-2204
UPPER UNIT GEAR SET
Replaces: 43-75325A3, 43-75325A2
(1.84:1 Ratio)
(Drive Gear = 17 teeth Driven Gear = 19 teeth)
For: V-6 and 470/485 (4 Cyl. etc.) and Gen II
(S/N K999999 & BELOW)



18-2205
UPPER UNIT GEAR SET
Replaces: 43-55778A3, 43-55766A2, 43-55766A3
(1.98:1 Ratio)
(Drive Gear = 20 teeth Driven Gear = 24 teeth)
For: 120/140 (S/N 2791957 & UP) and Gen II
(S/N K999999 & BELOW)

18-2201
UPPER UNIT GEAR SET
Replaces: 43-18410A2, 43-18411A2, 43-59832A2, A4
Includes: (1) 18-1142
MerCruiser #31-32573A1
(1.5:1 Ratio)
(Drive Gear = 22 teeth Driven Gear = 20 teeth)
For most V-8 Drives and Gen II (S/N K999999 & BELOW)

Stern Drive Model	Beg. S/N	End. S/N
225	3856268	4200499
260	4898730	6225576
898/228	4782330	6225576
Stern Drive Model	Beg. S/N	End. S/N
888	3106717	& UP
V8R/MR/AlphaOne	6225577	& UP



18-2203
UPPER UNIT GEAR SET
Replaces: 43-45814A5, 43-55765A2, 43-55765A3
(1.65:1 Ratio) (Drive Gear = 24 teeth
Driven Gear = 24 teeth)
For: 6 Cyl. Inline S/N K999999 & BELOW



18-6351
UPPER UNIT GEAR SET
Replaces: 43-853641A2
For: Alpha I (Gen II) (1998-up), 0L100040-up,
1.47:1 Ratio (20-22 Teeth)
Used with: 18-2416 Complete Upper Gear Case



18-6352
UPPER UNIT GEAR SET
Replaces: 43-853642A2
For: Alpha I (Gen II) (1998-up), 0L100040-up,
1.94:1, 2.40:1 Ratios (20-24 Teeth)
For: MerCruiser Vazer
Used with: 18-2411 Drive Shaft Housing Assembly,
18-2419 Complete Upper Gear Case



18-6353
UPPER GEAR KIT
Replaces: 43-853643A2
1.81 Ratio Upper Gear Set, 17-19 Teeth
For: Alpha I Gen II 1998-up/0L00040-up
For: MerCruiser Vazer



FIG. #1

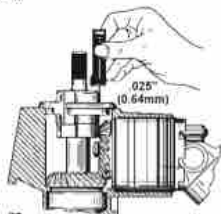

FIG. #2

FIGURES #1 - #2
 Provides two separate views of the upper gear housing driven gear being properly shimmed using the Sierra installation tools.

FIGURES #3 - #4
 Provides the same views of the drive gear being shimmed in the same application.

NOTE:
 This installation **cannot** be performed correctly without the Sierra 18-9856 shim tool. Improper installation **will** result in gear failure. The .025 referenced in **FIG #2** & **FIG #4** is achieved when .025 will not fit the clearance but .025 will.

A service manual should always be consulted for step-by-step instructions.

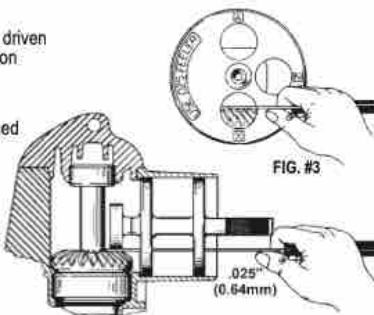

FIG. #4



18-2256
UPPER GEAR KIT
Replaces: 43-803116T1
Most V-8 Drives (1.5:1 Ratio)

— CONTAINS —

Part #	Description	O.E. #	Qty.
18-2201	Upper Unit Gear Set	43-18410A2	1
18-2648	Seal Kit	26-32511A2	1
18-2619-1	Outdrive Gasket Set	27-94996A1	1
18-2820	Drive Shaft Housing to Ball Housing Gasket	27-64818	1
18-2743	Drive Shaft Housing to Ball Housing Gasket	27-94996-2	1
18-1160	Bearing	31-35988A2	1
18-1165	Bearing	31-61100A1	1
18-1142	Bearing	31-35990A1	1

— CONTAINS —

Part #	Description	O.E. #	Qty.
18-2203	Gear Set	43-45814A5	1
18-2648	Seal Kit	26-32511A2	1
18-2619-1	Outdrive Gasket Set	27-94996A1	1
18-2820	Drive Shaft Housing to Bell Housing Gasket	27-64818	1
18-1150	Bearing	31-35988A2	1
18-1161	Bearing	31-35990A1	1
18-1165	Bearing	31-61100A1	1
18-2743	Drive Shaft Housing to Bell Housing Gasket	27-94996-2	1

**18-2257
UPPER GEAR KIT**
Replaces: 43-803112T1
6 Cyl. Inline (1.65:1 Ratio)



— CONTAINS —

Part #	Description	O.E. #	Qty.
18-2204	Gear Set	43-75325A3	1
18-2648	Seal Kit	26-32511A2	1
18-2619-1	Outdrive Gasket Set	27-94996A1	1
18-2820	Drive Shaft Housing to Bell Housing Gasket	27-64818	1
18-1150	Bearing	31-35988A2	1
18-1161	Bearing	31-35990A1	1
18-2743	Drive Shaft Housing to Bell Housing Gasket	27-94996-2	1
18-1165	Bearing	31-61100A1	1

**18-2258
UPPER GEAR KIT**
Replaces: 43-803114T1
V-6 (470/485) (1.84:1 Ratio)



— CONTAINS —

Part #	Description	O.E. #	Qty.
18-2205	Gear Set	43-55778A3	1
18-2648	Seal Kit	26-32511A2	1
18-2619-1	Outdrive Gasket Set	27-94996A1	1
18-2820	Drive Shaft Housing to Bell Housing Gasket	27-64818	1
18-1150	Bearing	31-35988A2	1
18-1161	Bearing	31-35990A1	1
18-1165	Bearing	31-61100A1	1
18-2743	Drive Shaft Housing to Bell Housing Gasket	27-94996-2	1

**18-2259
UPPER GEAR KIT**
Replaces: 43-803101T1
120/140 (1.98:1 Ratio)



**18-2125
YOKE**

Replaces: 39384, 46020, 460201, 46020T,
4602002, 46020002
Fits all #1/ALPHA Units (S/N 1684188 - OK999999)



**18-2146
YOKE**

Replaces: 20175, 59830A1, 59830A7
Fits all #1, R, MR, Alpha I, Alpha I Gen II, Bravo & Blackhawk



**18-6400
YOKE**

Replaces: 12784, 12784T
For: Bravo (OM111207 & below) and Blackhawk



**18-6401
YOKE ASSEMBLY**

Replaces: 12784A10, 12784A4
For: Bravo I, II, III (OB664190 - up)
(1998-05)



**18-9218
YOKE ASSEMBLY**

Replaces: 814819A2, 59830A5, 59829A1
For all #1, R/MR/ALPHA Gen II
OK999999 & Below (1971-97)



**18-2128
CENTER SOCKET**

Replaces: 39383, 39383T, 393831
(Rockwell)
Fits I/AB/IC & EZ, MC-I, R, MR, Alpha One, Gen II
(OL949778 & below), Bravo (OM111207 & below),
MC II & TS



**18-6404
CENTER SOCKET**

Replaces: 865503T
Fits: Alpha I Gen II OL949779 & UP, (GKN style)



**18-1711
U-JOINT**

Replaces: 862132, 862132T
For: Bravo One, Two, & Three (All Ratios), Bravo One X/
Two X, Three X (All Ratios), Bravo One XR/XZ (All Ratios),
Bravo One XR Sportmaster (All Ratios) & Integrated Transom



**18-2097
U-JOINT**

Permalube
Replaces: 8055361, 805536A1, 805536A2
For: Generation II F680000 & UP

 <p>18-2104 U-JOINT Heavy Duty Replaces: 75832, 75832A2, 75832T, 75832I, 75832T1, 75832A1, 75832A3, 58749, 41431, 36312 Includes both straight and 90° grease fitting. Fits all #1 and ALPHA I Units S/N 1684188-B418818. Also TRVTRS and II SSM.</p>	 <p>18-2174 U-JOINT Heavy Duty Replaces: 36312, 41431, 58749, 75832, 75832T, 75832A1, 75832A2, 75832A3, 75832I, 75832T1 Includes both straight and 90° grease fitting. Fits ALPHA I Units S/N B418819 & above. Also fits ALPHA I SS & BRAVO</p>	 <p>18-6405 U-JOINT ASSEMBLY Replaces: 865496A01, 865493A01, 865510T, 865496A01, 865511T GKN new style with external clips. Fits: Alpha I Gen II 0L949779 & UP, Bravo 0M111208 & UP For: Mercuriuser / Vazer</p>	 <p>18-8311 GIMBAL HOUSING REBUILD KIT Fits: Alpha One</p>
 <p>18-8312 GIMBAL HOUSING REBUILD KIT Fits: Gen II</p>	 <p>18-8313 GIMBAL HOUSING REBUILD KIT Fits: Bravo</p>	 <p>18-21001 GIMBAL BEARING Replaces: 30-60794A2, 30-60794A4, 30-879194A02 Non Greasable Fits: MC-1, R, MR and Alpha(1974-97), Gen II(1991-97), Bravo I/II/III (1988-95)</p>	 <p>18-21006 GIMBAL BEARING Non Greasable Replaces: 30-862540T1, 30-862540A3, 30-862540A04, 30-879194A01 Fits: Gen II (1998-10), Bravo I/II/III & X/XP/XZ (1996-10)</p>
 <p>18-21005 GIMBAL BEARING Replaces: 30-862540A3, 30-862540T1, 30-862540A04, 30-879194A01 Greasable Fits: All Bravos, Alpha One Gen II (1998-up)</p>	 <p>18-21005K SEAL & GIMBAL BEARING KIT Replaces: 30-862540A3, 30-862540T1, 30-862540A04, 30-879194A01 Greasable Contains (1) each of 18-2094 & 18-21005 Fits: Gen II (1998-Up) and all Bravo</p>	 <p>18-2101 GIMBAL BEARING Replaces: 30-36418, 30-36056, 36147 Greasable (Link-Belt)</p>	 <p>18-2100 HEAVY DUTY GIMBAL BEARING Replaces: 30-60794A4, 30-60794A2, 30-879194A02 Greasable (Link Belt) Fits: Mercuriuser- 120HP / 140HP (2791957-6225576) (With Gimbal Trim Sender), 165HP (2763442 & Up), 225S (3856268-4200499), 228HP (4782330 & Up), 233HP (4200500 & Up), 250HP (4791300 & Up)</p>
 <p>18-2100K SEAL & GIMBAL BEARING KIT Replaces: 30-60794A2, 30-60794A4, 30-879194A02 Greasable Contains (1) each of 18-2094 & 18-2100 Fits: 1, R, MR and Alpha (1974-97)</p>	 <p>18-7313 SWIVEL GIMBAL RING SHAFT Replaces: 98230A1 Fits: Mercuriuser Alpha/Gen II/Bravo I/II/III & Vazer</p>	 <p>18-1705 HINGE PIN Replaces: 77123, 77123A1, 65547 (with grease port)For gimbal housing Fits: Alpha, Alpha Gen II S/N 0M815638 & Lower</p>	 <p>18-1706 HINGE PIN Replaces: 10-86801 For gimbal housing Fits: Alpha Gen II S/N 0M85639 & UP Bravo All Models with trim sender</p>

GIMBAL BEARING APPLICATION

Model	Year Range	Serial No. Range	Gimbal Bearing	Model	Year Range	Serial No. Range	Gimbal Bearing
I	1963	1534570-1684187	30-32537T	250 / 260	1977-1982	1791300-6225576	18-21001
IA	1964	1684186-1777798	18-2101	R / MR / ALPHA I	1963-1990	6225577 & UP	18-21001
IB	1964	1684188-1777798	18-2101	ALPHA I / SS	1986-1989	A545004 & UP	18-21001
IC	1964	1684188-1777798	18-2101	ALPHA I GEN II	1991-1997	D469859-K399999	18-21001
EZ-SHIFT	1964	1684188-1777798	18-2101	ALPHA I GEN II	1998-2010	L100040 & UP	18-21001
120 / 140	1967-1973	2062141-3780849	18-2101	BRAVO I	1988-1995	B664190-F729999	18-21001
120 / 140	1974-1982	3780850-6225576	18-21001	BRAVO II	1988-1985	B664190-F729999	18-21001
470 / 485	1976-1982	4208730-6225575	18-21001	BRAVO III	1988-1995	B664190-F729999	18-21001
160 / 165	1967-1973	2065195-3780849	18-2101	BRAVO I	1996-2010	F730000 & UP	18-21006
165	1974-1981	3780850 & UP	18-21001	BRAVO II	1996-2010	F730000 & UP	18-21006
888	1971-1973	3106717-3784374	18-2101	BRAVO III	1996-2010	F730000 & UP	18-21006
888	1974-1977	3784375 & UP	18-21001	X / XR / XZ	1996-2010	F730000 & UP	18-21006
225 / 233	1974	3856268 & UP	18-21001	BLACKHAWK	1994-1995	F186717 & UP	18-21001
898 / 226	1977-1982	4782330-6225576	18-21001	II	1984-1969	1602186-2671321	18-2101



**18-2381
UPPER DRIVE UNIT CAP**
Replaces: 94998A1, 94998A2,
94998A3, 94998A4
S/N 6225577 & Later Alpha I, except Gen II



**18-2382
UPPER DRIVE UNIT CAP**
Replaces: 828692A1, 18312A3
For: Gen II S/N F880000 & UP



**18-3752
RETAINING NUT**
Replaces: 8168111, 8168112,
66071, 35992



**18-4296
SPACER RING**
Replaces: 35983
(Upper Housing)



**18-0577
CARRIER OIL
SEAL ASSEMBLY**
Replaces: 66081A2, 35993A1,
66081A1, 66081A4



**18-3219
WATER TUBE &
COVER ASSEMBLY**
Replaces: 32489, 32489A2, 42724A3
For: Merc I and Alpha I drives
Models: I, 1A, 1B, 1C, 1CEZ, 120, 140, 160,
165, 886, 896, 226, 225-S, 233, 250, 260,
470, 485, R, MR, Alpha
18-3229 Bolt Replaces: 10-28668



**18-2322
SHIFT SHAFT**
Replaces: 62104, 621041
For: I and Alpha I



**18-2169
SHIFT ARM**
Replaces: 45589A1, 45589A3



**18-3749
UPPER SHIFT SHAFT**
Replaces: 816685
For: Alpha Gen II (1991-98)



**18-2599
FACE SEAL & TOOL**
Replaces: 26-816575A2
For: ALPHA I GENERATION II



**18-2622
BELL HOUSING BUSHING KIT**
Replaces: 23-79373A1,
23-805041A2, 27-45588, 27-79373



**18-3760
BELL HOUSING BUSHING KIT**
Replaces: 23-806036A1
For: GEN II Serial # F880000 & UP



**18-2324
DRIVE SHAFT**
Replaces: 45-557961
For: Gen II (S/N F880000 & UP),
Mercuriser Vazer



**18-3713
LOCK NUT**
Replaces: 11-22339, 11-97522,
11-36084, F1348, F1881
5/8" - 18



**18-3712
CARRIER NUT WASHER**
Replaces: 12-45810



**18-2161
SHIFT ARM**
Replaces: 45518A1, 45518A2,
45518A3



**18-2170
SHIFT ARM SCREW**
Replaces: 10-45590,
10-8M0084649



**18-2162
SHIFT CABLE SLIDE
& SCREW**
Replaces: 33981, 33981T,
33981T1, 8507521, 8507522

PKG. OF 5



18-2163
18-2163-9Ⓢ
SHIFT SLIDE SCREW
 Replaces: Mercuriser 10-31700
 GLM: 21090
 Mallory: 9-72152

PKG. OF 5



18-2163E-9Ⓢ
SHIFT SLIDE SCREW
 For: Extreme Cables Only



18-2715
CHECK VALVE KIT
 Replaces: 24-17997A1
 For: Alpha I Generation II and Bravo I, II, and III Drives



18-2724
TRANSOM SEAL
 Replaces: 3713
 For: Alpha Gen II, All Bravo

— CONTAINS —

Part #	Description	O.E. #	Qty.
18-2619-1	Outdrive Gasket Set	27-84818A3 27-94996A1_Q2	1
18-2100	Gimbal Bearing	30-60794A2, 30-60794A4	1
18-2161	Shift Arm	45518A2	1
18-2751	U-Joint Bellows	60932A4	1
18-2750	Exhaust Bellows	32734A3, 18654A1	1
18-2753-1	Shift Cable Bellows	74639	1
18-3601	Water Intake Hose	32-32461	1
18-3602	Water Intake Hose	32-41725-33	1
18-710-16-2	Hose Clamp	—	2
18-7314	Stainless Steel Hose Clamp	—	1
18-710-64-2	Stainless Steel Hose Clamp	—	1



18-2601-1
TRANSOM SEAL KIT
 Replaces: 30-803097T1
 R, MR, ALPHA 1 (1983-90) S/N 6225577 & UP
 ALPHA 1 SS (1986-89) S/N OA 545004 & UP
 *Greasable Gimbal Bearing

— CONTAINS —

Part #	Description	O.E. #	Qty.
18-2100	Gimbal Bearing	30-60794A4, 30-60794A2	1
18-2751	U-Joint Bellows	60932A4	1
18-2760	Exhaust Tube	78458A1	1
18-3601	Water Intake Hose	32-32461	1
18-3602	Water Intake Hose	32-41725-33	1
18-2743	Drive Shaft Housing to Bell Housing Gasket	27-94996-2	1
18-2840	Bell Housing Gasket	27-35982	1
18-7153	O-Ring	25-25439	1
18-7117	O-Ring	25-35027	1
18-710-16-2	Hose Clamp	—	2
18-7170	O-Ring	25-33504	1
18-710-24-2	Hose Clamp	—	1
18-2753-1	Shift Cable Bellows	74639	1
18-7321	Bellows Clamp	54-38863	1



18-8205
TRANSOM SEAL KIT
 Replaces: 30-803098T1
 For: 1, R, MR, Alpha-1 with exhaust tube
 *Greasable Gimbal Bearing

— CONTAINS —

Part #	Description	O.E. #	Qty.
18-3602	Water Intake Hose	32-41725-33	1
18-710-16-2	Hose Clamp	—	2
18-710-24-2	Hose Clamp	—	1
18-2753-1	Shift Cable Bellows	74639	1
18-7321	Bellows Clamp	54-38863	1
18-2100	Gimbal Bearing	30-60794A4, 30-60794A2	1
18-2743	Drive Shaft Housing to Bell Housing Gasket	27-94996-2	1
18-2840	Bell Housing Gasket	27-35982	1
18-7153	O-Ring	25-25439	1
18-7170	O-Ring	25-33504	1
18-7117	O-Ring	25-35027	1
18-2750	Exhaust Bellows	18654A1, 32734A3	1
18-2747	Drive Bellows	816431A1	1



18-8206-1
TRANSOM SEAL KIT
 Replaces: 30-803099T1
 For: Alpha 1 Gen II
 *Greasable Gimbal Bearing

— CONTAINS —

Part #	Description	O.E. #	Qty.
18-2753-1	Shift Cable Bellow	74639	1
18-2100	Gimbal Bearing	30-862540A3	1
18-2756	U-Joint Bellows	86840A3	1
18-2750	Exhaust Bellows	32734A3	1
18-2760	Exhaust Tube	78458A1	1
18-3603	Water Hose	32-43437	1
18-2615	Outdrive Mounting Kit	16755A1	1



18-8212-1
TRANSOM SEAL KIT
 Replaces: 30-803100T1, 8M0095485
 For: All Bravos 1982 & up
 *Greasable Gimbal Bearing



**18-8213
TRANSOM SEAL KIT**
Replaces: 30-803097T1
For: R, MR, Alpha 1 (1983-90) S/N 6225577-0D469858; Alpha 1 SS (1986-89) S/N 0A545004 & Up
*Sealed Gimbal Bearing 18-21001



**18-8217
TRANSOM SEAL KIT**
Replaces: 30-803098T1
For: R, MR, Alpha 1 (1983-90) w/exhaust tube S/N 6225577-0D469858; Alpha 1 SS (1986-89) w/exhaust tube S/N 0A545004 & Up
*Sealed Gimbal Bearing 18-21001



**18-8218
TRANSOM SEAL KIT**
Replaces: 30-803099T1
For: Alpha 1 Gen II (1991 & Up) S/N 0D469859 & Up
*Sealed Gimbal Bearing 18-21006



**18-8219
TRANSOM SEAL KIT**
Replaces: 30-803100T1
For: Bravo I/II/III (1988 & Up) S/N 0B864190 & Up; Blackhawk (1994-95) S/N 0F186717 & Up
*Sealed Gimbal Bearing 18-21006



**18-2747
U-JOINT BELLOWS**
Alpha 1, Gen II
Replaces: 816431A1



**18-2750
EXHAUST BELLOWS**
All #1 Units, Gen II, TRS, & Bravo I, II, III
Replaces: 32734, 32734A3, 18654A1
(Includes 18-710-48-2 Clamp)



**18-2751
U-JOINT BELLOWS**
All #1 units with ridge
(S/N 3469428 & UP)
Replaces: 60932A1, 60932A4
(Includes 18-710-72-2 Clamp)



**18-2752
U-JOINT BELLOWS**
All #1 units without ridge
(S/N 3443920 & BELOW)
Replaces: 36223, 36223A1, 36223A2
(Includes 18-710-72-2 Clamp)



**18-2753-2
SHIFT CABLE BELLOWS**
All #1, #2 units, Alpha, Bravo I, II, III
Replaces: 31659, 74639, 74639A2
(Includes 18-7321 Clamp)



**18-2756
U-JOINT BELLOWS**
Replaces: 86840A3, 86840A05, 8M0062406
Fits: All Bravo and Blackhawk models



**18-1710
BELLOW FLANGE RING**
Replaces: 862209, 86814
Fits: All Bravo



**18-1728
BELLOW FLANGE RING**
Replaces: 816607
Fits: Alpha One (GenII) (1991 and Up)



**18-2746
EXHAUST BOOT**
Replaces: 32-14358, 32-14358T, 31-14358001
(4" Lower Tube)



**18-2748
EXHAUST BOOT**
Replaces: 32-44348, 32-44348T, 31-44348001
(4" Upper Tube)



**18-2759
EXHAUST TUBE**
Replaces: 53114, 53114A1



**18-2760
EXHAUST TUBE**
Replaces: 78458, 78458A1
(Includes 18-7314 Clamp)
For: #1, Bravo I, II, III



**18-2761
EXHAUST TUBE**
3" I.D.
Replaces: 32-90949, 32-90949T

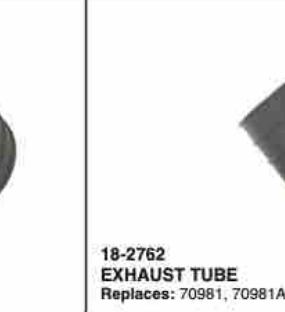

**18-2762
EXHAUST TUBE**
Replaces: 70981, 70981A3



**18-2770
EXHAUST TUBE**
Replaces: 32-807458T

Ⓜ Items ending in "D" are Display Packaged - Regular number is Non-Display

BELLOWS APPLICATION

Model	Years	Serial #	Exhaust Bellows	Shift Cable Bellows	U-Joint
V/A/1B/1C & EZ	1963-1966	1534570-2065186	18-2750	18-2753-2	18-2752
120/140/160/165	1967-1972	2062141-3443920	18-2750	18-2753-2	18-2752
120/140/160/165	1972-1982	3469428-6225576	18-2750	18-2753-2	18-2751
888	1971-1972	3106717-3472477	18-2750	18-2753-2	18-2752
888	1973-1977	3472478 & Up	18-2750	18-2753-2	18-2751
225/233	1974-1977	3856268 & Up	18-2750	18-2753-2	18-2751
898/228/250/260	1977-1982	4782330-6225576	18-2750	18-2753-2	18-2751
R/MR/Alpha One	1983-1990	6225577 & Up	18-2750	18-2753-2	18-2751
R/MR/Alpha One	1983-1990	6225577 & Up	18-2760 ②	18-2753-2	18-2751
Alpha One Gen II	1991 & Newer	0D469859 & Up	18-2750	18-2753-2	18-2747
Bravo I/II/III	1988 & Newer	0B664190 & Up	18-2750	18-2753-2	18-2756
Bravo I/II/III	1988 & Newer	0B664190 & Up	18-2760 ②	18-2753-2	18-2756
Blackhawk	1994-1995	0F18677 & Up	18-2750	18-2753-2	18-2756
Blackhawk	1994-1995	0F18677 & Up	18-2760 ②	18-2753-2	18-2756
II	1962-1969	1474909-2671321	—	18-2753-2	—
215H	1970	2782203-2909034	—	—	18-2752
215E	1970-1972	2909035-2915034	—	18-2753-2	18-2752
TR/TRS	1973-1993	3377316 & Up	—	—	18-2751

② Tube

PKG. OF 5



18-7321
18-7321-9 ②
BELLOWS CLAMP

Replaces: 54-38863, 54-866507, 54-8M0090424

INNER SHIFT CABLE

18-2159

Replaces: 19543A2, 19543A4, 19543A8, 19543A10, 41951A1, 66065A1, 66069A2, 73679A2, 865436A02
Use in 18-2157, 18-2158 and their Mercruiser equivalent as replacement wire and tube
Stranded Core 73"



18-2189

Replaces: 32992A1, 34086A1, 37611A1, 38399A2
Use with 18-2248
Inner Core Wire 59"

18-2160
SHIFT CABLE
SUPPORT TUBE

Replaces: 32-38377
Replaces tube on 18-2157, 18-2158 & 18-2159



18-2248
SHIFT CABLE
ASSEMBLY

Replaces: 73723A1, 73723A01, 49518A1, 35187A1, 35187A2, 35187A4
Mercruiser #1 Drives S/N 1562900-6225576 for forward installation into bell housing.
Has new style armored strand construction. (No support tube) 54" conduit with hardware package.



18-2157

Replaces: 19543A2, 41951A1, 19543A8, 19543A10, 19543A4, 66065A1, 66069A2, 73679A2, 865436A02
Mercruiser 1 drives S/N 6225577 & UP For AFT installation into bell housing. Has old style stranded core wire with soldered tip. (Uses Support Tube).



18-2158

Mercruiser #1 Drives S/N 1562900-6225576 for forward installation into bell housing. Has old style stranded core wire with soldered tip. (Uses support tube **18-2160**) 63" conduit

SHIFT CABLE ASSEMBLY

18-2190
SHIFT CABLE

Replaces: 19543A2, 19543A4, 19543A8, 19543A10, 41951A1, 66065A1, 66069A2, 73679A2, 865436A02
Mercruiser 1 drives S/N 6225577 & UP
For AFT installation into bell housing. For use in applications using core wire with armored strand construction (No Support Tube). 63" Conduit with hardware package.



18-2190E
SHIFT CABLE

Replaces: 19543A4, 19543A10, 19543A8, 19543A2, 41951A1, 66065A1, 66069A2, 73679A2, 865436A02
S/N 6225577 & UP. For AFT installation into bell housing. For use in applications using core wire with armored strand construction (No Support Tube). 63" Conduit with hardware package. Lower Shift Cable- Alpha One (Gen II) (1991-97)
Requires **18-9806E** (Xtreme Shift Cable Tool) to complete installation



18-2145
SHIFT CABLE

Replaces: 815471A3, 815471A6, 85147A5, 865437A02, 43432A2, 19297A3

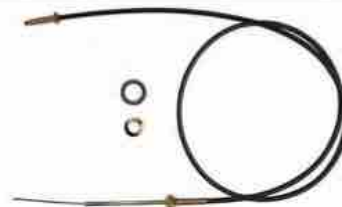



**18-2145E
SHIFT CABLE**

Replaces: 815471, A3, A6
Bravo One, Two, & Three (All Ratios), Bravo One X/Two X, Three X (All Ratios), Bravo One XR/XZ(All Ratios), Bravo One XR Sportmaster (All Ratios) & Integrated Transom



**18-9806E
SHIFT CABLE TOOL**

Installs and removes shift cables on MC-I, R-MR, Alpha I, Alpha I Gen II drive units. Use with 18-2190 and 18-2190E cables.

**18-2149
SHIFT CABLE GUIDE**

Replaces: 22879, 29880, 43433
For: Alpha & Bravo cables



PKG OF 25

**18-2303
18-2303-9①
ANCHOR SCREW SET**

Replaces: 10-20518
For: #1R, MR, Alpha, Alpha I, Gen II & Bravo



**18-3754
CABLE ANCHOR**

Replaces: 43436
For: #1R, MR, Alpha, Alpha I, Gen II & Bravo

**18-2600
LOWER SHIFT CABLE KIT**

— CONTAINS —

Part #	Description	O.E. #	Qty.
18-2753-2	Shift Cable Bellows	74639	1
18-2248	Shift Cable Assembly	73723A1	1
18-2162	Shift Slide & Screw	33981T	1
18-2149	Shift Cable End Kit	43433	1
18-2163	Shift Slide Screw	10-31700	1
18-2743	Drive Shaft Housing to Bell Housing Gasket	27-94996-2	1
18-2820	Drive Shaft Housing to Bell Housing Gasket	27-64818	1
18-2840	Bell Housing Gasket	27-35982	1
18-7117	O-Ring	25-35027	1
18-7153	O-Ring	25-25439	2
18-7170	O-Ring	25-30504	1

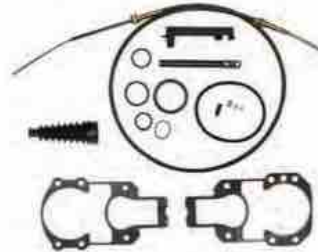

**18-2603
LOWER SHIFT
CABLE KIT**

Replaces: 19543T1, 19543T2, 865436A03
ALPHA I GENERATION II

— CONTAINS —

Part #	Description	O.E. #	Qty.
18-2619-1	Outdrive Gasket Set	27-94996A1	1
18-2753-2	Shift Cable Bellows	74639	1
18-2190	Shift Cable Assembly	19543A4	1
18-2743	Drive Shaft Housing to Bell Housing Gasket	27-94996-2	1



**18-2603E
LOWER SHIFT
CABLE KIT (XTREME)**

Replaces: 19543T1, 19543T2, 865436A03
For: Alpha I Gen II
Uses 18-2190E shift cable.
Requires 18-9806E (Xtreme Shift Cable Tool) to complete installation

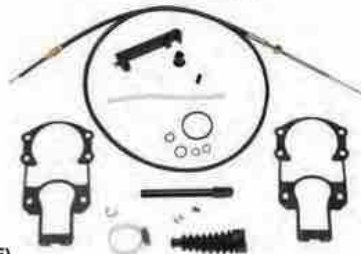

**18-2604
LOWER SHIFT CABLE KIT**

Replaces: 815471T1
BRAVO

— CONTAINS —

Part #	Description	O.E. #	Qty.
18-2145	Bravo Shift Cable	815471A3	1
18-2149	Shift Cable End Kit	43433	1
18-2753-1	Shift Cable Bellows	74639	1
18-2815	Outdrive Gasket Set	—	1



**18-2604E
LOWER SHIFT CABLE KIT
(XTREME)**

Replaces: 815471T1
Uses 18-2145E shift cable.
For: Bravo

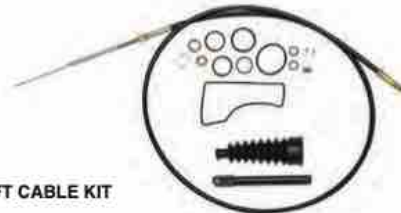

**GRADE 316
STAINLESS STEEL WORM GEAR
HOSE CLAMPS**



All components are manufactured from Marine Grade 316 stainless steel. These clamps are designed to fit many applications from 1/2" to 7" diameter hoses.

STAINLESS STEEL CLAMPS

Part #	O.E. #	Diameter Size	Std. #	Part #	O.E. #	Diameter Size	Std. #
18-710-06-2	-	7/16" to 3/4"	006	18-710-32-2	-	1 9/16" to 2 1/2"	032
18-710-10-2	-	9/16" to 1 1/16"	010	18-710-48-2 ①②	54-815504348	2 9/16" to 3 1/2"	048
18-710-12-2	-	9/16" to 1 1/4"	012	18-710-64-2 ③	-	2 1/2" to 4 1/2"	064
18-710-16-2	-	1 1/16" to 1 1/2"	016	18-710-72-2 ③③	-	3" to 5"	072
18-710-20-2	-	3/4" to 1 3/4"	020	18-710-104-2	-	5" to 7"	104
18-710-24-2	-	1 1/16" to 2"	024				

① For use with 3" Bellows ② O.E. #54-32533 ③ O.E. #s 54-31765, 54-815504372

**18-2175
ENGINE
COUPLER**

Replaces: 12632A4

Uses 18-2146 Yoke Shaft

Flex plate style for late model, small crankshaft bolt pattern, style engines



**18-2195
ENGINE COUPLER**

Replaces: 12632A3, 12632A7

Uses 18-2146 Yoke Shaft

Flex plate style for GM 4 Cyl engines with late style, small crankshaft bolt pattern



**18-2323
ENGINE COUPLER**

Replaces: 18643A5

(Same as 18-2175 without yoke)



**18-2321
ENGINE COUPLER**

Replaces: 12632A6

(Same as 18-2195 without yoke)

For: Late model GM 4 cylinder



**18-2412-1
ENGINE
COUPLER**

Replaces: 18309A2, 18311A2, 18311A17,
812964A2, 861523A9, 8M0098795
For: Bravo



**18-2413
ENGINE
COUPLER**

Replaces: 69354A1, 69354A2
For: 470, 485 (224 cu. in.)
S/N 4208730-6218036 (1976-1982)



**18-2414
ENGINE
COUPLER**

Replaces: 97432A2

For: 165, 170, 470: 3.7L S/N 6170297 & UP (1983-1989)
180, 190, 488, 3.7LX S/N 6170297 & UP (1983-1989)



**18-2171
ENGINE
COUPLER**

Replaces: 32492A2, 32492A3, 32492A5,
38965A1, 38965A2, 76850A2
For: All GM engines except MR/ALPHA/BRAVO
with "Triangular", 3-Bolt coupler



**18-2172
ENGINE COUPLER**

Replaces: 14505A2

Used when replacing V8 or V8 2 piece rear main seal
with 3-1/2" crankshaft bolt pattern to a newer 1 piece
rear main seal engine with 3" bolt pattern



**18-2173
ENGINE
COUPLER**

Replaces: 59826A1, 59826A3
For: Ford engines



① Priced per Package

ENGINE COUPLER APPLICATION

HP	Liter	Model	CID	# Cyl	Stroke	Years	Serial #	Part #
110		110	153	4		1963-1966	1537370 - 2044033	18-2171
120		120	153	4		1964-1982	1537370 - 6229717	18-2171
120		120	153	4	4	1964-1982	1666601 - 6229717	18-2171
120		120	153	4	4	1983-1986	6229718 - B531853	18-2171 ●
120		120	153	4	4	1983-1986	6229718 - B531853	18-2195 ●
	2.5L	2.5L	153	4	4	1987-1989	B531854 - C853255	18-2171 ●
	2.5L	2.5L	153	4	4	1987-1989	B531854 - C853256	18-2195 ●
140		140	181	4	4	1968-1982	2508261 - 6229717	18-2171
140		140	181	4	4	1983-1986	6229718 - B450800	18-2171 ●
140		140	181	4	4	1983-1986	6229718 - B450800	18-2195 ●
140		140 INLINE 6		6	4	1963	1538830 - 1725960	18-2171
	3.0L	3.0L	181	4	4	1987-1989	B450801 - C856558	18-2171 ●
	3.0L	3.0L	181	4	4	1987-1989	B450801 - C856558	18-2195 ●
	3.0L	3.0L	181	4	4	1990-1994	C856559 - F603999	18-2195
	3.0L	3.0L	181	4	4	1998-2010	L067000 & UP	18-2323
	3.0L	3.0L MPI	181	4	4	2008-2010	A072812 & UP	18-2323
	3.0L	3.0LX	181	4	4	1990-1993	C856559 - F000000	18-2195
	3.0L	3.0LX	181	4	4	1994-1998	F000001 - L066999	18-2321
150		150			4	1964-1966	1666495 - 2048046	18-2171
160		160			4	1967-1969	2048022 - 2770031	18-2171
165		165	224	4	4	1987	B434941 - B774251	18-2414
165		165 INLINE 6		6	4	1970-1981	2770032 - 5813433	18-2171
170		170	224	4	4	1985-1986	6916779 - B434940	18-2414
180		180	224	4	4	1987	B436391 - B775248	18-2414
180		180	224	4	4	1985-1987	6916779 - B775248	18-2414
	3.7L	3.7L	224	4	4	1988-1989	B774252 & UP	18-2414
	3.7L	3.7LX	224	4	4	1983-1989	B775249 & UP	18-2414
		470	224	4	4	1976-1982	4208730 - 6218036	18-2413
		470	224	4	4	1983-1984	6218037 - 6916779	18-2414
		485	224	4	4	1980-1982	5685394 - 6218036	18-2413
		488	224	4	4	1983-1984	6170297 - 6916779	18-2414
		140	194	6	4	1963	1538930 - 1664117	18-2171
		150	230	6	4	1964-1966	1664118 - 2048046	18-2171
		160	250	6	4	1967-1969	2048022 - 2770031	18-2171
		165	250	6	4	1970-1981	2770032 - 5813433	18-2171
175		175			4	1987	B527955 - B773242	18-2175
185		185 (4bb)	229	6	4	1983-1984	6330183 - 6919655	18-2171
175		175	262	V-6	4	1987	B527955 - B773242	18-2175
185		185 (2bb)	262	6	4	1985-1986	A331455 - B827954	18-2171 ●
185		185 (2bb)	262	6	4	1985-1986	A331455 - B527954	18-2175 ●
205		205	262	6	4	1985-1986	A331455 - B527954	21-2171 ●
205		205	262	6	4	1985-1986	A331455 - B527954	18-2175 ●
205		205	262	6	4	1987	B527955 - B775129	18-2175
		262 MAG EFI GEN+	262	V-6	4	1996-1997	F803800 - K999999	18-2323
	4.3L	4.3L	262	V-6	4	1988-1993	B527955 - F000677	18-2175
	4.3L	4.3L	262	V-6	4	1993-2010	F000678 & UP	18-2323
	4.3L	4.3L EFI GEN +	262	V-6	4	1996-2001	L012009 - M299999	18-2323
	4.3L	4.3L MPI	262	V-6	4	2002-2010	M300000 & UP	18-2323
	4.3L	4.3LH GEN +	262	V-6	4	1996-2002	L010044 - M614999	18-2323
	4.3L	4.3LX	262	V-6	4	1988-1993	B775130 - F001219	18-2175
	4.3L	4.3LX (4bb)	262	V-6	4	1993-1995	F001220 - F802999	18-2323
	4.3L	4.3LX GEN + (2bb)	262	V-6	4	1996-1997	F803000 - K999999	18-2323
	4.3L	4.3LXH GEN +	262	V-6	4	1996-1997	F803000 - K999999	18-2323
5.0L		225 (FORD)	302	V-8	4	1973-1974	3385721 - 4166999	18-2173 ●
5.0L		388	302	V-8	4	1971-1977	3106723 - 4887829	18-2173

- Use with Borg Warner transmission
- Low speed / work application
- Coupler mounts to flywheel
- Use with Hurth transmission

- Hydraulic shift only
- I drive only
- Round shape coupler
- Standard Bravo applications

- Coupler mounts to crankshaft
- Triangular shape coupler
- ◆ Use with Borg Warner 71/72 series in-line transmission
- ◆ Use with Borg Warner 5000 or Hurth 630 transmission

ENGINE COUPLER APPLICATION

HP	Liter	Model	CID	# Cyl	Stroke	Years	Serial #	Part #
		190	283	V-8	4	1963-1964	1564539 - 1730903	18-2171
	5.0L	200	305	V-8	4	1985-1988	6899058 - B525981	18-2171 Ⓢ
	5.0L	200	305	V-8	4	1985-1986	6899058 - B525981	18-2175 Ⓢ
	5.0L	200	305	V-8	4	1985-1987	6899058 - B774444	18-2175
	5.0L	228	305	V-8	4	1977-1982	4765100 - 6218461	18-2171
	5.0L	228	305	V-8	4	1977-1984	6218462 - 6899268	18-2171
	5.0L	230	305	V-8	4	1985-1987	6899269 - B773739	18-2171 Ⓢ
	5.0L	230	305	V-8	4	1985-1987	6899269 - B773739	18-2175 Ⓢ
	5.0L	5.0L ALPHA	305	V-8	4	1988-1993	B774445 - F000000	18-2175
	5.0L	5.0L ALPHA	305	V-8	4	1994-1995	F000001 - F600999	18-2323
	5.0L	5.0L GEN+ ALPHA	305	V-8	4	1998-2010	L015751 & UP	18-2323
	5.0L	5.0L GEN+ BRAVO	305	V-8	4	1998-2010	L015751 & UP	18-2412-1 Ⓢ
	5.0L	5.0L EFI ALPHA	305	V-8	4	1998-2001	L012052 - M299999	18-2323
	5.0L	5.0L EFI BRAVO	305	V-8	4	1998-2001	L015751 - M299999	18-2412-1 Ⓢ
	5.0L	5.0LX ALPHA	305	V-8	4	1988-1993	B773740-F000000	18-2175
	5.0L	5.0LX ALPHA	305	V-8	4	1994-2007	F000001 & UP	18-2323
	5.0L	5.0L MPI BRAVO	305	V-8	4	1998-2007	L015751 & UP	18-2412-1
	5.0L	5.0L MPI ALPHA	305	V-8	4	2002-2010	M300000 & UP	18-2323
	5.0L	5.0L MPI BRAVO	305	V-8	4	2002-2010	M300000 & UP	18-2412-1 Ⓢ
	5.0L	5.0LX ALPHA	305	V-8	4	1988-1993	B773740 - F000000	18-2175
	5.0L	5.0LX ALPHA	305	V-8	4	1994-1995	F000001 - F600999	18-2323
	5.0L	Ⓢ98	305	V-8	4	1977-1985	4762210 - 6899057	18-2171
		225 (GM)	327	V-8	4	1963-1969	1539620 - 2694014	18-2171
		290	327	V-8	4	1977	4768000 - 4908849	18-2171
	5.7L	260	350	V-8	4	1978-1982	4908850 - 6218461	18-2171
	5.7L	260	350	V-8	4	1982-1985	6218462 - B525981	18-2171 Ⓢ
	5.7L	260	350	V-8	4	1982-1987	6218462 - B773304	18-2175 Ⓢ
	5.7L	260	350	V-8	4	1987	B525982 - B773304	18-2175
	5.7L	300 TEMPEST ALPHA	350	V-8	4	1985-1986	6668677 - B430367	18-2171 Ⓢ
	5.7L	300 TEMPEST ALPHA	350	V-8	4	1986	A434310 - B430367	18-2175 Ⓢ
	5.7L	320 EFI	350	V-8	4	1987-1989	A543624 - C622418	18-2175
	5.7L	350 MAG ALPHA	350	V-8	4	1986-1993	A835178 - F000000	18-2175
	5.7L	350 MAG ALPHA	350	V-8	4	1993-1997	F000001 - K999999	18-2323
	5.7L	350 MAG ALPHA EFI GEN +	350	V-8	4	1996-1997	F800300 - K999999	18-2323
	5.7L	350 Mag MPI ALPHA	350	V-8	4	1998-2010	L010019 & UP	18-2323
	5.7L	350 MAG MPI BRAVO	350	V-8	4	1998-2010	L010019 & UP	18-2412-1 Ⓢ
	5.7L	350 MAG MPI HORIZON ALPHA	350	V-8	4	2002-2007	M300000 - A299999	18-2323
	5.7L	350 MAG MPI HORIZON BRAVO	350	V-8	4	2002-2007	M300000 - A299999	18-2412-1 Ⓢ
	5.7L	350 MAG MPI HORIZON ALPHA	350	V-8	4	1993-2007	F000001 & UP	18-2323
	5.7L	HORIZON BRAVO	350	V-8	4	1999-2007	M300000 & UP	18-2412-1
	5.7L	5.7L ALPHA	350	V-8	4	1988-1993	B773305-F000000	18-2175
	5.7L	5.7L ALPHA	350	V-8	4	1993-2010	F000001 & UP	18-2323
	5.7L	5.7L BRAVO	350	V-8	4	1988-2010	B773305 & UP	18-2412-1 Ⓢ
	5.7L	5.7L EFI ALPHA	350	V-8	4	1995-2001	F225560 - M299999	18-2323
	5.7L	5.7L EFI BRAVO	350	V-8	4	1998-2001	L010035 - M299999	18-2412-1 Ⓢ
	5.7L	5.7LX EFI ALPHA	350	V-8	4	1996-1997	F752400 - K999999	18-2323
	5.7L	5.7LX EFI ALPHA	350	V-8	4	1993-2007	F000001 & UP	18-2323
	5.7L	5.7LX EFI BRAVO	350	V-8	4	1998-2007	L010035 & UP	18-2412-1 Ⓢ
	5.7L	233	351	V-8	4	1975-1977	4173000 - 4902304	18-2173
	6.2L	377 MAG	377	V-8	4	2008-2010	A300000 & UP	18-2412-1 Ⓢ
	6.2L	MX 6.2L MPI	377	V-8	4	2000-2007	L680003 - A299999	18-2412-1 Ⓢ
	6.2L	MX 6.2L MPI	377	V-8	4	2000-2007	L680003 - A299999	N/A Ⓢ
	6.2L	MX 6.2L MPI HORIZON	377	V-8	4	2002-2007	M300000 - A299999	18-2412-1 Ⓢ
	7.4L	454 MAG ALPHA	454	V-8	4	1986-1988	A631894 - B785148	18-2175 Ⓢ

- Ⓢ Use with Borg Warner transmission
- Ⓢ Low speed / work application
- Ⓢ Coupler mounts to flywheel
- Ⓢ Use with Hurth transmission

- Ⓢ Hydraulic shift only
- Ⓢ I drive only
- Ⓢ Round shape coupler
- Ⓢ Standard Bravo applications

- Ⓢ Coupler mounts to crankshaft
- Ⓢ Triangular shape coupler
- Ⓢ Use with Borg Warner 71/72 series in-line transmission
- Ⓢ Use with Borg Warner 5000 or Hurth 630 transmission



18-4442
ENGINE ALIGNMENT TOOL
 Replaces: 91-57797A3, 91-57797A2, 91-57797A1, 91-8M0067546,
 91-48347, 91-37384
 For use with all #1 units, MR, all Alpha & Bravo units



18-9803
SPANNER NUT WRENCH
 Replaces: 91-36235, 91-17256

SIERRA HYDRO DEFENSE MARINE GREASE

18-9240-0
 (8 oz Tube)
 Replaces:
 Mercury 92-802859A1



18-9240-1
 (14oz Cartridge)
 Replaces:
 Mercury 92-802863A1

- Prohibits rust and corrosion.
- Prevents wear against the most extreme friction in marine applications.
- Will not break down in marine conditions.
- Contains PTFE for minimum wear and added friction protection.
- For use on prop shafts, trailer bearings, throttle and shift cables and linkage, swivel pins and more!



18-2200
LOWER UNIT GEAR SET
 Replaces: 43-61027, 43-96084A4
 888 S/N 3106717 & UP #1 Units S/N 3469428 & UP Except, MR/AL-
 PHA Units (which have no pre-load pin in the top of the drive shaft).



18-2410
FORWARD GEAR SET
 Replaces: 43-96084A7, 43-96084A5
 For: "R" drive



18-2360
PINION & FORWARD GEAR SET
 Replaces: 43-828072A3, 43-878087A2
 13-21 Teeth



18-2206-1
LOWER UNIT GEAR SET
 Replaces: 43-878087A2 + 43-828073A1,
 43-828072A2
 For: Alpha 1 Gen II (serial 0F680000 & Up)



18-2409
REVERSE GEAR
 Replaces: 43-92320, 43-92320T
 For: "R" drive (28 teeth)



18-2406
FORWARD GEAR SET
 Replaces: 43-878087A2, 43-878072A3
 For: MR/Alpha/Gen II lower S/N D469859 & UP



18-2408
REVERSE GEAR
 Replaces: 43-828073A1
 For: Alpha I/Gen II lower S/N D469859 & UP

18-2404
GEAR REPAIR KIT
Replaces: 43-803079T1
For: "R" drive

— CONTAINS —

Part #	Description	O.E.#	Qty.
18-2200	Lower Unit Gear Set	43-96084A4	1
18-2202	Sliding Clutch	52-66063	1
18-1157	Needle Roller Bearing	31-30895	1
18-1155	Ball Bearing	30-88957A1	1
18-1159	Tapered Roller Bearing	31-35928A1	1
18-2285	Shim	15-47397A1	1
18-3719	Pinion Nut	11-35921	1
18-2299	Tab Washer	14-79447	1



18-2405
GEAR REPAIR KIT
Replaces: 43-803091T1
For: MR/Alpha I

— CONTAINS —

Part #	Description	O.E.#	Qty.
18-2652	Lower Gear Housing Seal Kit	26-33144A2	1
18-3719	Pinion Nut	11-35921	1
18-2343	Washer	12-982721	1
18-2298	Tab Washer	14-18323	1
18-2299	Tab Washer	14-79447	1
18-2206-1	Gear Set	43-42934	1
18-2285	Shim	15-47397A1	1
18-1155	Ball Bearing	30-88957A1	1
18-1159	Needle Roller Bearing	31-30956	1
18-1117	Pinion Bearing	31-42647A1	1
18-1143	Alpha Bearing	31-36387A1	1
18-2294	Shim Kit	15-42637A-1	1
18-2202	Sliding Clutch	52-66063	1



18-2407
GEAR SET

Replaces:
 43-876087A4, 43-823072A2, 43-42933A3,
 43-42933A2, 43-17064A3

For: MR/Alpha/Gen II
 lower gear housings

— CONTAINS —

Part #	Description	O.E.#	Qty.
18-2206-1	Gear Set	43-42934	1
18-1155	Ball Bearing	30-88957A1	1
18-1117	Pinion Bearing	31-42647A1	1
18-1159	Needle Roller Bearing	31-30956	1
18-1143	Alpha Bearing	31-36387A1	1
18-2294	Shim Kit	15-42637A-1	1
18-2285	Shim	15-47397	1
18-3719	Pinion Nut	11-35921	1
18-2343	Washer	12-982721	1



18-2202
SLIDING CLUTCH

Replaces: 52-66063, 52-853594T, 52-853594,
 52-824112
 888 S/N 3784375 & UP
 #1 Units S/N 3469428 & UP



18-2357
CROSS PIN

Replaces:
 17-30632, 17-8M0020941, 17-8M0100263,
 17-8M0084681

PKG. OF 2



18-2348
18-2348-9①
**CLUTCH CROSS
 PIN SPRING**

Replaces: 24-30893
 1/MC-1/R/MR/Alpha
 MerCruiser/Gen II lower
 S/N D469859-F679999
 MerCruiser Vazer



18-2166
PROP SHAFT

Replaces: 44-66060, 44-660603, 44-824110, 44-660602, 44-55857
For: All #1 & MR/ALPHA Units S/N 2791957 & above.
 Also for 165 (6 cyl.) S/N 2763442 & above.



18-2254
PROP SHAFT

Replaces: 44-850308
For: Alpha One Gen II S/N 0L100040 & up/Vazer



18-2180
DRIVE SHAFT
 Replaces: 45-42634
 For all MR/ALPHA Units & older units which have been retro-fitted with MR/ALPHA lower units.



18-2331
DRIVE SHAFT
 Replaces: 45-853648, 45-853647
 For: Ratios 1.47, 1.62, 1.81 & 1.94
 Fits: Gen II (1998 & up), (0L100040 & up)
 For use with: 18-2400 Complete Lower Gear Case



18-2261
DRIVE SHAFT
 Replaces: 45-816919
 All Alpha I Generation II Drives (with new style 18-3056 Impeller)
 Serial #D494569 & above.



18-2346
RETAINER NUT
 Replaces: 824519, 8245191, 11-42633, F694961, F694961-1
 For: MR Alpha & Gen II



18-3719
PINION NUT
 Replaces: 11-35921, 11-47411, 11-826375, 11-F694188
 5/8" - 18 thread • 1 1/16" wrench



18-2359
DRIVE SHAFT NUT SET

— INCLUDES —

Sierra #	Description	Replaces:
18-3719	Pinion Nut	11-35921
18-2343	Pinion Nut Washer	12-92721



18-2286
 Replaces: 66067, 66067T, 19755A2, 818349A1, 818349T1



18-2196
 Replaces: 37967, 61073, 19755A4, 19755A08

SHIFT SPOOL ASSEMBLIES

SHIFT SPOOL ASSEMBLY APPLICATION

Model	Serial #	Part #
1A (EZ-Shift)	1776349 & UP	18-2196
1B (EZ-Shift)	1775193 & UP	18-2196
1C (EZ-Shift)	1777799 & UP	18-2196
120/140	2062141-3780849	18-2196
120/140	3780850 & UP	18-2286
160	2065190-2763441	18-2196
165	2763442-3780849	18-2196
165	3780850 & UP	18-2286
888	3106717-3784374	18-2196
888	3784375 & UP	18-2286
898/228	4782330 & UP	18-2286
225-S	3856268-4200499	18-2286
233	4200500 & UP	18-2286
470/485	4208730 & UP	18-2286
R/MR/Alpha One	6225377 & UP	18-2286
Alpha One (Gen II)	D494569 & UP	18-2286



18-3759
THRUST BEARING RING
 Replaces: 35915



18-2342
THRUST RING
 Replaces: 68100, 681001
 For: MR/ ALPHA



18-2191
CARRIER BEARING
 Replaces: 56211A1, 73020A1, 73020A14
 For: #1R/MR/Alpha I
 For: Housings with casting #73020C



18-2376
CARRIER BEARING
Replaces: 73020A20, 818763A4, 818763A10.
For: Alpha Gen II & MR Units
For: Housings with casting #73020C1, Mercuriser Vazer



18-2150
SHIFT SHAFT
Replaces: 37973, 65028, 66066, 77481, 774811
Stainless Steel



18-2353
SHIFT ROD BUSHING ASSEMBLY
Replaces: 23-815921A21, 23-815921A17,
 23-815921A10, 23-815921A8,
 23-815921A6, 815921A2



18-2154
SHIFT SHAFT HOUSING BUSHING
Replaces: 23-30617A1, 23-30617A2
Mercuriser & Alpha 1 (S/N 1684188 & UP)



18-3198
WATER PICK-UP
(Port)
Replaces: 93424, 934241, 934243
For: MR Alpha



18-3199
WATER PICK-UP
(Starboard)
Replaces: 93423, 934231, 934233
For: MR Alpha



18-2320
SHIFT SHAFT
Replaces: 815919A1
For: Gen II



18-2130
SHIFT CRANK
Replaces: 66062, 76865,
 8M2009865
For: All #1 Units R/MR/Alpha,
 Mercuriser Vazer

PKG. OF 2



18-4295
18-4295-9[Ⓢ]
E-CLIP
Replaces: 53-29641
For: Gen II



18-2299
TAB WASHER
Replaces: 14-79447,
 14-52833



18-2298
TAB WASHER
Replaces: 14-18323,
 14-17460



18-3751
SPANNER NUT
Replaces: 79448
For: Mercuriser Vazer



18-2354
CARRIER SEAL
Replaces: 821759A4, 821759A3,
 821759A2, 821759A1, 815922A5,
 815922A1, 807929A2, 807929A1



18-1117
PINION BEARING
Replaces: 31-42647A1



18-1120
PINION BEARING
Replaces: 31-35246
For: Lower drive shaft III, TR & Bravo I, II, III (1986-95)



18-1356
PINION BEARING
Replaces: 31-54928

Model	Year	Model	Year
215 E/M	1970-72	II, TR	1973-76
225 TRS, 280 TRS	1973-76	TR, TRS	1977-93



18-1142
UPPER PINION BEARING
Replaces: 31-32573A1

Ⓢ Priced per Package



18-1193
TAPERED
ROLLER BEARING
 Replaces: 31-33138A1
 Fits: Gen II (1998-Up), Mercuriser Vazer



18-1143
TAPERED
ROLLER BEARING
 Replaces: 31-36387A1



18-1156
FORWARD
GEAR BEARING
 Replaces: 31-30894A1
 For: Mercuriser Vazer



18-1161
TAPERED
ROLLER BEARING
 Replaces: 31-35990A1
 For: Mercuriser Vazer



18-1162
TAPERED
ROLLER BEARING
 Replaces: 31-38356A1, 31-F84901, FA84901,
 F84903



18-1165
TAPERED
ROLLER BEARING
 Replaces: 31-61100A1



18-1173
TAPERED
ROLLER BEARING
 Replaces: 31-828437A2



18-1179
TAPERED
ROLLER BEARING
 Replaces: 31-32575A1, T1
 For: Gen II F680000 & UP, Mercuriser Vazer



18-1126
TAPERED ROLLER
BEARING
 Replaces: 31-8M0103474



18-1127
TAPERED
ROLLER BEARING
 Replaces: 31-54038A1
 For: Bravo II - Lower (S/N B664190 & UP)



18-1163
TAPERED ROLLER
BEARING
 Replaces: 31-48941A1



18-1197
TAPERED FORWARD GEAR
BEARING
 Replaces: 31-828439A2
 For: Alpha One Gen II (1996-97)
 (s/n 0F680000-0K999999)



18-1182
ROLLER BEARING KIT
 Replaces: 31-30894A5
 For: Alpha I (Gen II) (1998 & up)
 (OL100040 & up), Mercuriser Vazer



18-1129
UPPER DRIVE
SHAFT BEARING
 Replaces: 31-86748A1,
 31-8M0103473, 31-F506818,
 F508814
 For: Bravo I, II, III - Lower
 (S/N B664190 & UP)



18-1180
NEEDLE BEARING
 Replaces: 31-54042T
 For: Bravo I, II, III (1988-98), TRS
 (1977-93)-carrier



18-1157
FORWARD GEAR
INNER BEARING
 Replaces: 31-30895, 31-30895T
 For: Mercuriser Vazer



**18-1158
CARRIER BEARING**
Replaces: 31-30956, 31-30956T,
31-F523058
For: Mercuriser Vazer



**18-1153
BALL BEARING**
Replaces: 30-63326, 30-63326T,
30-49313, 30-54215, 30-20464



**18-1155
BALL BEARING**
Replaces: 30-88957A1, 30-88957T,
30-35914, 30-17927, 30-88957



**18-1160
DRIVE BEARING KIT**
Replaces: 31-35988A2, 31-35988A12

MERCURISER STERNDRIVE UPPER GEAR HOUSING BEARINGS

Stern Drive Model	Drive Ratio	Years	Serial #	Drive Gear (Yoke)	Driven Gear	Upper Cap
IA, IB, IC & EZ Shift	All	1964-66	1684188 - 2065186	18-1160	18-1161	18-1179
120/140	1.98	1967	2062141 - 2187468	18-1160	18-1161	18-1161
120/140	1.98	1967-71	2187469 - 3134193	18-1160	18-1161	18-1179
120/140	1.98	1971-82	3134194 - 6225576	18-1160	18-1161	18-1165
470/485	1.84	1976-82	4208730 - 6225576	18-1160	18-1161	18-1165
160	1.68	1967	2065190 - 2182197	18-1160	18-1161	18-1161
160	1.68	1967-71	2182198 - 3134193	18-1160	18-1161	18-1179
165	1.65	1971-81	3213658 - UP	18-1160	18-1161	18-1165
888	1.5	1971-73	3106717 - 3134193	18-1160	18-1161	—
888	1.5	1973-77	3134194 - UP	18-1160	18-1161	18-1165
225-S	1.5	1974	3856268 - 4200499	18-1160	18-1161	18-1165
898/228	1.65	1977-82	4782300 - 6225576	18-1160	18-1161	18-1165
233	1.32	1975-77	4200600 - UP	—	—	18-1165
250	1.32	1977	4791300 - 4898729	—	—	18-1165
255-TRS	All	1973-74	3377316 - 4203749	18-1162 ①	18-1162	—
260	1.5	1978-82	4898730 - 6225576	18-1160	18-1161	18-1165
280-TRS	All	1975-76	4203750 - 4895399	18-1162 ②	18-1162	—
R/MR/Alpha One	1.98/1.84/1.65/1.50	1984-90	6225577 - UP	18-1160	18-1161 ③ ④	18-1165
R/MR/Alpha One	1.5	1984-90	6225577 - UP	18-1160	18-1142	18-1165
R/MR/Alpha One	1.32	1984-90	6225577 - UP	—	—	18-1165
R/MR/Alpha One	1.5 Heavy Duty	1984-90	6225577 - UP	—	18-1142	18-1165
Alpha One SS	1.32	1986-89	A545004 - UP	—	—	18-1165
Alpha One SS	1.5	1986-89	A545004 - UP	—	18-1142	18-1165
Alpha One Gen II	2.40/1.98/1.84/1.65	1991-95	D469859 - F679999	18-1160	18-1161 ③	18-1165
Alpha One Gen II	1.5	1991-95	D469859 - F679999	18-1160	18-1142	18-1165
Alpha One Gen II	2.40/1.94/1.81/1.62	1996-97	F680000 - K999999	18-1160	18-1161 ④	18-1179
Alpha One Gen II	1.47	1996-97	F680000 - K999999	18-1160	18-1142	18-1179
Alpha One Gen II	2.40/2.00/1.94/1.81/1.62	1998 & Up	L100040 - UP	—	18-1161	18-1179
Alpha One Gen II	1.47	1998 & Up	L100040 - UP	—	18-1142	18-1179
II-TR	—	1973-76	3377316 - 4794899	18-1162 ⑤	18-1162	—
SSM II	—	1982-97	ALL	18-1162 ③	18-1162	—
TR/TRS	—	1977-93	4794900 - UP	18-1162 ③	18-1162	—
Bravo I, II, III	All	—	B664190 & UP	—	—	18-1129

① Timken Cone # 89449 / Cup 89410

② Straight Shoulder Gear Only

③ Bearing for U-Joint Yoke

④ Use 18-1142 for 1.5:1 Upper Gear Ratio

MERCURISER STERNDRIVE LOWER GEAR HOUSING BEARINGS

Stern Drive Model	Years	Beg. Serial # - End Serial #	Prop Bearing Carrier	Lower Drive Shaft (Pinion)	Upper Drive Shaft	Inside Forward Gear (Needle)	Outside Forward Gear	Reverse Gear
80	1965-66	1630753 - 2063740	—	—	—	—	18-1162	—
80/90	1966-72	2063741 - 3225967	18-1158	—	—	18-1157	18-1156	—
I	1963	1534570 - 1536617	18-1158	—	18-1153	18-1157	18-1156	—

① 18-1161 Top Bearing /
18-1163 Bottom Bearing

② Torrington#B1616
③ Prop Shaft Drive Gear

④ #15520 Stamped on Cup
⑤ Use 18-1173 for 2.40:1 ratio only (new style
lower gears) our 18-2206-1

MERCURISER STERNDRIVE LOWER GEAR HOUSING BEARINGS (Cont.)

Stardrive Model	Years	Beg. Serial # - End Serial #	Prop Bearing Carrier	Lower Drive Shaft (Pinion)	Upper Drive Shaft	Inside Forward Gear (Needle)	Outside Forward Gear	Reverse Gear
I	1963	1536618 - 1684187	18-1158	—	—	18-1157	18-1156	—
IA,IB,IC & EZ Shift	1964-66	1684188 - 2065189	18-1158	—	—	18-1157	18-1159	18-1155
120/140	1967-69	2062141 - 2791956	18-1158	—	—	18-1157	18-1159	18-1155
120/140	1970-77	2791957 - 4853634	18-1158	—	—	18-1157	18-1159	18-1155
120/140	1978-82	4893635 - 8225576	18-1158	—	—	18-1157	18-1159	18-1155
470	1976-77	4206730 - 4859934	18-1158	—	—	18-1157	18-1159	18-1155
470/485	1978-82	4893635 - 8225576	18-1158	—	—	18-1157	18-1159	18-1155
160	1967-69	2065190 - 2763441	18-1158	—	—	18-1157	18-1159	18-1155
165	1970-77	2763442 - 4890459	18-1158	—	—	18-1157	18-1159	18-1155
165	1978-81	4890460 - UP	18-1158	—	—	18-1157	18-1159	18-1155
888	1971-77	3106717 - UP	18-1158	—	—	18-1157	18-1159	18-1155
225/233	1974-77	3856288 - UP	18-1158	—	—	18-1157	18-1159	18-1155
898/228	1977	4782330 - 4898729	18-1158	—	—	18-1157	18-1159	18-1155
898/228	1978-82	4898730 - 8225576	18-1158	—	—	18-1157	18-1159	18-1155
250	1977	4791300 - 4898729	18-1158	—	—	18-1157	18-1159	18-1155
255-TRS	1973-74	3377316 - 4203749	18-1158	—	—	—	18-1159	N/A
260	1978-82	4898730 - 8225576	18-1158	—	—	18-1157	18-1159	18-1155
260-TRS	1975-76	4203750 - 4895399	18-1158	—	—	—	18-1159	N/A
R	1983	6225577 - UP	18-1158	—	—	18-1157	18-1159	18-1155
MR / Alpha One	1984-90	6225577 - UP	18-1158	18-1117	18-1143	—	18-1159 ②	18-1155
MR / Alpha One	1984-90	6225577 - UP	18-1158	18-1117	18-1143	18-1157 ②	18-1159 ③	18-1155
MR / Alpha One (CR)	1984-90	6225577 - UP	18-1158	18-1117	18-1143	—	—	—
Alpha One SS	1986-89	A545004 - UP	18-1158	18-1117	18-1143	18-1157	18-1159	18-1155
Alpha One Gen II	1991-95	D489859 - F679999	18-1158	18-1117	18-1143	18-1157	18-1159 ④	18-1155
Alpha One Gen II (CR)	1991-95	D489859 - F679999	18-1158	18-1117	18-1143	—	—	—
Alpha One Gen II	1996-97	F680000 - K999999	18-1158	18-1117	18-1143	18-1157	18-1159	18-1155
Alpha One Gen II (CR)	1996-97	F680000 - K999999	18-1158	18-1117	18-1143	—	—	—
Alpha One Gen II	1998-newer	L100040 - UP	18-1158	18-1117	18-1143	18-1157	18-1159 ⑤	18-1155
Alpha One Gen II (CR)	1998-newer	L100040 - UP	18-1158	18-1117	18-1143	—	—	—
II	1962-67	1474909 - 2275488	—	—	—	N/A	18-1156 ③	N/A
II	1968-69	2398798 - 2671321	—	—	—	—	18-1162	18-1156 ③
II-TR	1973-76	3377316 - 4794899	—	—	18-1161 ①	—	—	N/A
TR	1973-93	4794900 - UP	—	—	18-1161 ①	—	—	N/A
TRS	1973-93	4794900 - UP	18-1158	—	—	—	18-1159	N/A

① 18-1161 Top Bearing /
18-1163 Bottom Bearing

② Torrington#B1616
③ Prop Shaft Drive Gear

④ #15520 Stamped on Cup
⑤ Use 18-1173 for 2.40:1 ratio only (new style lower gears) our 18-2206-1



18-2349
SHIFT SHAFT SLEEVE
Replaces: 23-67370



18-2244
18-22441-9 ①
(PKG. OF 50 WITHOUT GASKET)
DRAIN PLUG
Replaces: 10-79953A2, 10-79953,
10-79953Q04, 10-28634,
10-28634A1, 10-20259, 816610A1,
816610A2, F40109, 10-F50109
For: #1/R/MR/Alpha/Alpha I Gen II
Both Upper And Lower Units



18-2375
18-23751-9 ①
(PKG. OF 50 WITHOUT GASKET)
DRAIN PLUG MAGNET
Replaces: 10-14834, 10-14834A1,
22-67892, 22-67892A1, 22-67892A05,
22-67892A06, 22-8M0058389
(Magnet)
For: Alpha MR/Gen II lower units
Not to be used on #1/R lower units



18-2460
PLUG KIT
Replaces: 22-88847A1,
11-88462
Fits: Mercuriser Stern Drives



18-72005
NUT AND WASHER KIT
Fits: Mercuriser R/MR/Alpha/Gen II Drives



18-4220
THRUST WASHER
Replaces: 13171, 77987
V-6, Outboards &
Mercuriser Sterndrives



18-3784
THRUST WASHER
Replaces: 805100
Fits: Bravo III (Front)

 <p>18-3701D </p> <p>18-3701 PROP NUT KIT Replaces: 11-52707A1, 11-52707A2, 11-52707Q1</p> <table border="1"> <thead> <tr> <th colspan="4">CONTAINS</th> </tr> <tr> <th>Part #</th> <th>O.E.#</th> <th>Description</th> <th>Qty.</th> </tr> </thead> <tbody> <tr> <td>18-3200</td> <td>14-31210, 14-816629, 14-816629Q, 14-F697140</td> <td>Tab Washer</td> <td>2</td> </tr> <tr> <td>18-3700</td> <td>11-52707</td> <td>Prop Nut</td> <td>1</td> </tr> </tbody> </table>	CONTAINS				Part #	O.E.#	Description	Qty.	18-3200	14-31210, 14-816629, 14-816629Q, 14-F697140	Tab Washer	2	18-3700	11-52707	Prop Nut	1	 <p>18-3755 PROP NUT KIT Fits: Bravo III (Front)</p>	 <p>18-3756 PROP NUT KIT Fits: Bravo III (Rear)</p>
CONTAINS																		
Part #	O.E.#	Description	Qty.															
18-3200	14-31210, 14-816629, 14-816629Q, 14-F697140	Tab Washer	2															
18-3700	11-52707	Prop Nut	1															
<p>PKG. OF 10</p>  <p>18-3200 18-3200-9① TAB WASHER Replaces: 14-31210, 14-816629, 14-816629Q, 14-F697140</p>	 <p>18-3787 TAB WASHER Replaces: 805101T Fits: Bravo III (Rear)</p>	<p>PKG. OF 10</p>  <p>18-3788-9① TAB WASHER Replaces: 14-34817 Fits: Bravo II</p>	 <p>18-72510 STUD KIT Fits: Mercruiser Coupler to Flywheel</p>															
 <p>18-3783 PROP NUT Replaces: 11-859131, 11-805092, 11-805092T Fits: Bravo III (Front)</p>	 <p>18-3785 PROP NUT Replaces: 11-82671127, 11-54034, 11-39907, 11-39823 Fits: Bravo II</p>	 <p>18-3786 PROP NUT Replaces: 11-862907, 11-805093 Fits: Bravo III (Rear)</p>	 <p>18-3700 PROP NUT Replaces: 11-52707, 11-827614, F7040 3/4" - 20 thread • 1 1/16" wrench</p>															
 <p>18-3714 BRASS CASTLE WASHER Replaces: 12-31211A2, 12-31211, 12-31211A3, 12-31211Q03 Fits: Alpha/Bravo I (without Flo-Torq II Hub). NOTE: Fits above product with rubber hub propellers (non-Flo-Torq II)</p>	 <p>18-4444 PROP WRENCH Replaces: 91-95830A1, 91-95830, 91-38277A1</p>	 <p>18-4446 PROP WRENCH KIT --CONTAINS--</p> <table border="1"> <thead> <tr> <th>Part #</th> <th>O.E.#</th> <th>Description</th> </tr> </thead> <tbody> <tr> <td>18-3200</td> <td>14-31210, 14-816629</td> <td>Tab Washer</td> </tr> <tr> <td>18-3700</td> <td>11-52707</td> <td>Prop Nut</td> </tr> <tr> <td>18-4444</td> <td>91-95830A1</td> <td>Prop Wrench</td> </tr> </tbody> </table>	Part #	O.E.#	Description	18-3200	14-31210, 14-816629	Tab Washer	18-3700	11-52707	Prop Nut	18-4444	91-95830A1	Prop Wrench				
Part #	O.E.#	Description																
18-3200	14-31210, 14-816629	Tab Washer																
18-3700	11-52707	Prop Nut																
18-4444	91-95830A1	Prop Wrench																
 <p>18-4459 PROP WRENCH Replaces: 91-821887A1, 91-859046Q4, 91-859046T4</p>	 <p>18-2103 POWER TRIM HOSE Replaces: 32-47373, 32-66073, 32-68676, 32-73004, 32-79431, 32-86036, 32-86036A1, 32-86036Q</p> <p>1/8" 14" 1/8" </p>																	

① Priced per Package

② Items ending in "D" are Display Packaged - Regular number is Non-Display



18-2105
POWER TRIM HOSE
Replaces: 32-45973

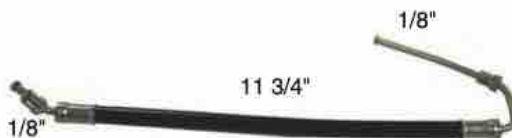

18-2106
POWER TRIM HOSE
Replaces: 32-45974



18-2107
POWER TRIM HOSE
Replaces: 32-55816



18-2108
POWER TRIM HOSE
Replaces: 32-59841, 32-59841A1, 32-73123



18-2109
POWER TRIM HOSE
Replaces: 32-59842, 32-73005



POWER TRIM HOSE

Starboard
Connector to bottom of trim cylinder MCM 120-260 & BRAVO

Part #	O.E. #	Description
18-2114	32-99902-1, 32-864960	Trim Cyl. Casting #14034-1
18-2136*	32-99902, 32-864589	Trim Cyl. Casting #98704, 98704-1

* Approximately 11 1/4" long



POWER TRIM HOSE

Port • Connector to bottom of trim cylinder MCM 120-260 & BRAVO

Part #	O.E. #	Description
18-2115	32-99903-1, 32-864959	Trim Cyl. Casting #14035-1
18-2137*	32-99903, 32-864588	Trim Cyl. Casting #98703, 98703-1

* Approximately 11 1/4" long



18-2112
POWER TRIM HOSE
Replaces: 32-87234

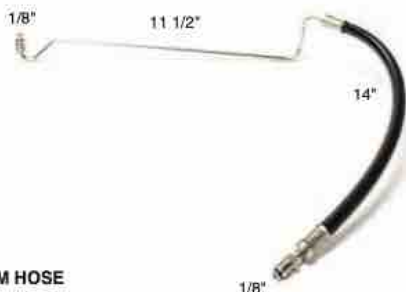

18-2113
POWER TRIM HOSE
Replaces: 32-87235



18-2435
POWER TRIM HOSE
Replaces: 32-861127, 32-95858
Fits: R/MR/Alpha/Alpha Gen II/Bravo I, II, III/Bravo X, XR, XZ
Serial number 0W099999 and below without quick connect fittings.
OEM hose color is black.



15"
1/8"

**18-2116
POWER TRIM HOSE**
Replaces: 32-99904, 32-99904Q



51"

**18-2436
POWER TRIM HOSE**
Replaces: 32-861128, 32-95859
Fits: R/MR/Alpha/Alpha Gen II/Bravo I, II, III/Bravo X, XR, XZ Serial number 0W099999 and below without quick connect fittings. OEM hose color is gray.



**18-2126
POWER TRIM HOSE**
Trim Pump to reverse lock 10 ft (3.04 m) length
Replaces: 32-52951A1, 32-48418
Fits: MC-1 Drive (w/ in-line engines) and II drives

POWER TRIM HOSE APPLICATION

Stern Drive Model	Years	Serial #	Trim Cylinder to Connector (Port Down)	Trim Cylinder to Connector (Port Up)	Trim Cylinder to Connector (Std Down)	Trim Cylinder to Connector (Std Up)	Pump to Hydraulic Connector	Pump to Hydraulic Connector	Connector to Reverse Lock Valve	Hydraulic Pump & Reverse Lock Valve
120, 140	1967-69	2052141 - 2791956	—	18-2106	—	18-2105	—	N/A	—	18-2126
120, 140	1970-73	2791957 - 3780849	18-2103	18-2103	18-2103	18-2103	18-2107	N/A	—	18-2126
120, 140	1974-82	4693635 - 6225576	18-2103	18-2103	18-2103	18-2103	18-2107	N/A	18-2109	18-2126
470/485	1976-82	4206730 - 6225576	18-2103	18-2103	18-2103	18-2103	18-2107	N/A	18-2109	18-2126
160	1967-69	2065190 - 2763441	—	18-2106	—	18-2105	—	N/A	—	18-2126
165	1970-73	2763442 - 3780849	18-2103	18-2103	18-2103	18-2103	18-2107	N/A	—	18-2126
165	1974-81	3780850 & UP	18-2103	18-2103	18-2103	18-2103	18-2107	N/A	18-2109	18-2126
888	1974 & UP	3106717 & UP	18-2103	18-2103	18-2103	18-2103	18-2105	N/A	18-2109	—
225/235	1974-77	3656268 & UP	18-2103	18-2103	18-2103	18-2103	18-2108	N/A	18-2109	—
228/898/250/260	1977-82	4782330 - 6225576	18-2103	18-2103	18-2103	18-2103	18-2105	N/A	18-2109	—
R/MR/Alpha/SS	1983-90	6225577 & UP	18-2137 ①	18-2116	18-2136 ②	18-2116	18-2436	18-2435	N/A	N/A
R/MR/Alpha/SS	1983-90	6225577 & UP	18-2115 ③	18-2116	18-2114 ④	18-2116	18-2436	18-2435	N/A	N/A
Alpha One GEN II	1991-97	D469859 & UP	18-2115	18-2116	18-2114	18-2116	18-2436	18-2435	N/A	N/A
Alpha One GEN II ⑤	1998 & UP	6L100040 & UP	18-2115	18-2116	18-2114	18-2435	18-2436	18-2435	N/A	N/A
Bravo I, II & III ⑥	1988 & UP	8684190 & UP	18-2137	18-2116	18-2136	18-2116	18-2436	18-2435	N/A	N/A
Blackhawk	1994-95	F186717 & UP	18-2137	18-2116	18-2136	18-2116	18-2436	18-2435	N/A	N/A
II (1.78)	1988-85	2396798 - 2671321	18-2103	18-2103	18-2103	18-2103	—	N/A	—	18-2126
III	1968-72	2373127 - 3002613	18-2103	18-2103	18-2103	18-2103	—	N/A	—	—
215E/H	1970-72	2909035 - 2915034	18-2103	18-2103	18-2103	18-2103	—	N/A	—	—
TR/TRS	1973-93	3377316 & Up	18-2103 ⑦	18-2103	18-2103 ⑧	18-2103	—	N/A	—	—
TR/TRS	1973-93	3377316 & Up	18-2103 ⑨	18-2103	18-2103 ⑩	18-2103	—	N/A	—	—
TR/TRS	1973-93	3377316 & Up	— ⑪	18-2103	— ⑫	18-2103	—	N/A	—	—

- ① 90° hose end
- ② External trim lines
- ③ Internal cylinder lines
- ④ Oldlyne pump
- ⑤ 18-2436 OEM hose color is gray, 18-2435 OEM hose color is black
- ⑥ Serial number 0W099999 and below without quick connect fittings.

- ★ High quality EPDM rubber cups
- ★ Metal hose connector complete with rubber washer
- ★ Use with a standard garden hose
- ★ Corrosion resistant dicromate finish
- ★ Installs in seconds
- ★ No tools required



**18-9010
MOTOR FLUSHER**
Heavy Duty

Flushes cooling system of salts and sediments and allows engine to idle for tuning and engine adjustment in your own driveway. Simply slip attachment over the engine's side water intakes. Coated spring steel arms clamp suction cup securely over the engine's side water intakes.

STAINLESS STEEL LOCKNUTS



Part #	O.E. #	Thread Size	Std. Pkg.
*18-3720 ⑬	11-34932	3/8" - 24	1
*18-3721 ⑭	11-34933, 11-95702, 11-82671015, 11-46355, 11-33962, 11-29241, 11-24648, 11-22178, 11-21298	7/16" - 20	6
*18-3722 ⑮	11-35888, 11-20361, 11-8267089	1/4" - 28	5
*18-3723 ⑯	11-45592	5/16" - 24	1

*To order locknuts in a package of 5, add -9 to end of part number



18-9099

TRAILERING CLIPS

Replaces: 817019A1, 817019Q2, 817019A2, 879078, 86459A2, 86459A1, 86459, 41155A2, 41155A1, 32657A4, 32657A3.
 LD. 3/4" x 11 1/8" length
 For all ALPHA I, ALPHA Generation II, Bravo I, II, III, and Blackhawk



18-2372
TRIM CYLINDER END CAP

Replaces: 88035
 1.850 Cap Diameter
 For: R/MR/Alpha



PKG. OF 2

18-2465-9[Ⓓ]
PIVOT PIN END CAP

Replaces: 19-14842, 19-148421
 For: R/MR/Alpha One (1983-90)
 Serial No. 6225577 and up
 V/II/III (1986-02) Serial No. 6225577

PKG. OF 2



18-2466-9[Ⓓ]
PIVOT PIN END CAP

Replaces: 19-815951
 For: Alpha One Gen II (1991-02)
 Serial No. OD469859 and up



18-2461
TRIM CYLINDER ANCHOR PIN KIT

Replaces: 17-44166T1
 For: Bravo I/II/III (1988-02)
 Serial No. 6225577 and up



18-2462
TRIM CYLINDER ANCHOR PIN KIT

Replaces: 17-14873A1, 17-85056
 For: R/MR/Alpha One (1983-90)
 Serial No. 6225577 and up (Front)



18-2463
TRIM CYLINDER ANCHOR PIN KIT

Replaces: 17-14872A1, 17-99207
 For: R/MR/Alpha One (1983-90)
 Serial No. 6225577 and up (Rear)



18-2464
FRONT AND REAR ANCHOR PIN KIT

Replaces: 17-815953T1, 56-864641A24, 56-18541A75
 For: All Alpha One Gen II



18-7633
TRIM SENDER/LIMIT KIT

Replaces: 805320A03, 805320A1, 96863A15, 88678A5, 88678A4, 63115A12, 17693A2
 Fits: MC-I, R, MR, Alpha, Alpha Gen II, Bravo drives



18-2142
POWER TRIM CYLINDER

Replaces: 45706A1, 45706A3, 45706A6, 45706A8, 45706A12, 45706A14
 Fits: All Stern Drive Models with internal lines: 120, 140, 160, 165, 888, 898, 228, 225-S, 233, 250, 260, 470 & 485



18-2148
POWER TRIM CYLINDER HOUSING

Replaces: 45523, 45706A4, 77442A1, 77443
 Fits: All Stern Drive Models: 120, 140, 160, 165, 888, 898, 228, 225-S, 233, 250, 260, 470 & 485

[Ⓓ] This product is priced per piece. To order priced per package, please add -9 to the part number.

[Ⓓ] Priced per package



18-2424
POWER TRIM CYLINDER
 Replaces: 98703A11, 98703A12,
 98703A17, 98703A26
 For: BRAVO (Port)



18-2425
POWER TRIM CYLINDER
 Replaces: 98704A11, 98704A12,
 98704A17, 98704A26, 8M0708280
 For: BRAVO (Starboard)



18-2426
POWER TRIM CYLINDER
 Replaces: 98703A3
 For: R/MR/ALPHA (Port)



18-2427
POWER TRIM CYLINDER
 Replaces: 98704A3
 For: R/MR/ALPHA (Starboard)



18-2649
POWER TRIM SEAL KIT
 Replaces: 25-87400A2

18-2291
TRIM CYLINDER REPAIR KIT
 Replaces: 25-60342A2,
 25-60342A1
 Fits: All Stern Drive Models: 120, 140,
 160, 165, 888, 898, 228, 225-S, 233, 250,
 260, 470 & 485



18-2428
TRIM CYLINDER
REPAIR KIT
 Replaces: 87399A2, 87399A1
 For: R/MR/ALPHA I, BRAVO



18-2429
TRIM CYLINDER
REPAIR KIT
 Replaces: 87399A3
 For: ALPHA I GEN II

POWER TRIM CYLINDER APPLICATION

Model	Year	Serial No.	Trim Cylinder Port	Trim Cylinder Starboard	Housing Port	Housing Starboard	Trim Cylinder Seal Kit
120 / 140 4 cyl	1967-1969	2062141-2791956	18-2142	18-2142	N/A	N/A	N/A
120 / 140	1970-1977	2791957-4893634	18-2142	18-2142	N/A	N/A	18-2291
120 / 140	1978-1982	4893635-6225576	18-2142 ⓐ	18-2142 ⓐ	N/A	N/A	18-2291
120 / 140	1978-1982	4893635-6225576	N/A ⓐ	N/A ⓐ	N.L.A	N.L.A	18-2291
160 6 cyl	1967-1969	2062141-2791956	18-2142	18-2142	N/A	N/A	N/A
160	1967-1969	2065190-2763441	18-2142	18-2142	N/A	N/A	N/A
165	1970-1977	2763442-4890459	18-2142	18-2142	N/A	N/A	18-2291
165	1978-1981	4890460-4890459	18-2142 ⓐ	18-2142 ⓐ	N/A	N/A	18-2291
225 / 233	1974-1977	3856268 & UP	18-2142	18-2142	N/A	N/A	18-2291
250	1977	4791300-4898729	18-2142	18-2142	N/A	N/A	18-2291
260	1978-1982	4898730-6225576	18-2142 ⓐ	18-2142 ⓐ	N/A	N/A	18-2291
470 / 485	1976-1977	4208730-4893934	18-2142	18-2142	N/A	N/A	18-2291
470 / 485	1978-1982	4893835-6225575	18-2142 ⓐ	18-2142 ⓐ	N/A	N/A	18-2291
898 / 228	1977	4782330-4898729	18-2142	18-2142	N/A	N/A	18-2291
898 / 228	1978-1982	4898730-6225576	18-2142 ⓐ	18-2142 ⓐ	N/A	N/A	18-2291
ALL # 1 DRIVES ⓐ	1970-1982	2791957-6225576	18-2142	18-2142	18-2148	18-2148	18-2291
R / MR / ALPHA I	1983-1990	6225577-D469858	18-2426 ⓑ	18-2427 ⓑ	N/A ⓑ	N/A ⓑ	18-2649
R / MR / ALPHA I	1983-1990	6225577-D469858	18-2426 ⓑ	18-2427 ⓑ	N/A ⓑ	N/A ⓑ	18-2649
R	1983-1990	6225577 & UP	18-2426 ⓑ	18-2427 ⓑ	N/A	N/A	18-2649
MR	1983-1990	6225577 & UP	18-2426 ⓑ	18-2427 ⓑ	N/A	N/A	18-2649
ALPHA I	1983-1990	6225577 & UP	18-2426 ⓑ	18-2427 ⓑ	N/A	N/A	18-2649
ALPHA I SS	1986-1989	A545004 & UP	18-2426 ⓑ	18-2427 ⓑ	N/A ⓑ	N/A ⓑ	18-2649
ALPHA I SS	1986-1989	A545004 & UP	N/A ⓑ	N/A ⓑ	N/A	N/A	18-2649
ALPHA I SS	1986-1989	A545004 & UP	N/A	N/A	N/A	N/A	18-2649
R	1983-1990	6225577 & UP	N/A ⓑ	N/A ⓑ	N/A	N/A	18-2649
MR	1983-1990	6225577 & UP	N/A ⓑ	N/A ⓑ	N/A	N/A	18-2649
ALPHA I	1983-1990	6225577 & UP	N/A ⓑ	N/A ⓑ	N/A	N/A	18-2649
ALPHA I GEN II	1991-2001	D469859 & UP	N/A	18-2433	N/A	N/A	18-2649
BRAVO I	1988-2010	B664190 & UP	18-2424	18-2425	N/A	N/A	18-2649
BRAVO II	1988 & UP	B664190 & UP	18-2424	18-2425	N/A	N/A	18-2649
BRAVO III	1988 & UP	B664190 & UP	18-2424	18-2425	N/A	N/A	18-2649
BRAVO SEACORE	2007-2010	W900000 & UP	N/A	N/A	N/A	N/A	18-2649
BLACKHAWK	1994-1995	F186717 & UP	18-2424	18-2425	N/A	N/A	18-2649

- ⓐ 11 3/8" LONG TUBES - INTERNAL CYLINDER LINES
- ⓑ CASTING 14035 1
- ⓒ CASTING #98704
- ⓓ INTERNAL TRIM LINES
- ⓔ TRIM CYLINDER WITH INTERNAL TRIM LINES

- ⓕ 13 3/4" LONG TUBES - INTERNAL CYLINDER LINES
- ⓖ CASTING #98703
- ⓗ CASTING #98704 1
- ⓓ USE WITH 15 9/16" LONG TRIM CYLINDER TUBE
- ⓔ TRIM CYLINDERS USING EXTERNAL TRIM LINES

- ⓓ CASTING #14034 1
- ⓕ CASTING #98703 1
- ⓖ EXTERNAL TRIM LINES
- ⓗ USE WITH 16 3/16" LONG TRIM CYLINDER TUBE
- ⓔ EXCLUDES TR, TRS, 215E, H, & EARLY II & III DRIVES

PKG. OF 5



18-4252
18-4252-9 ⓓ
CONTINUITY SPRING
Replaces: 24-46312
Grounds the trim cylinder to the pivot pin shaft.



18-2151
7 1/2" (Front)
Replaces: 17-45738

18-2152
10 1/2" (Rear)
Replaces: 17-45735

PIVOT PINS

Used on 120, 120-260, 140, 165, 225S, 233, 250, 470, 888, 898/228
Use **18-2701** Bushing



18-2393
TRIM CYLINDER PIVOT PIN

Replaces: 17-14872
For: Trim cylinder rear R/MR/Alpha
Use: 18-2702-1 Bushing



18-2394
TRIM CYLINDER PIVOT PIN

Replaces: 17-14873
3/8" - 24 thread
For: Trim cylinder front R/MR/Alpha
Use: 18-2702-1 Bushing



18-2395
TRIM CYLINDER PIVOT PIN
Replaces: 17-815953, 17-815953A1
For: Trim cylinder front & rear Gen II



18-2396
TRIM CYLINDER PIVOT PIN
9 1/4" overall length • 7 1/2" shaft length
Replaces: 17-441166
For: Rear Bravo



18-2397
TRIM CYLINDER PIVOT PIN
Replaces: 17-44167A1, 17-44167
For: Front Bravo

- ⓓ Standard package of 8 priced per piece
- ⓔ Standard package of 8 priced per package
- ⓕ Priced per Package of 4
- ⓓ Priced per Package

<p>PKG. OF 8</p>  <p>POWER TRIM BUSHING 18-2701 18-2701-04 18-2701-9 Replaces: 23-89574, 23-61290, 23-45736 Fits: 120/260 Drive Units (S/N 6225276 & Down)</p>	<p>POWER TRIM BUSHING 18-2702-1 18-2702-04 18-2702-1-9 Replaces: 23-99291, 23-99291T Fits: 120/260 Drive Units (S/N 6225277 & UP)</p>	<p>PKG. OF 8</p>  <p>18-4288 18-4288-9 POWER TRIM BUSHING Replaces: 23-807073, 23-44165 For: Bravo</p>	 <p>18-2345 18-2345-9 TRIM CYLINDER ANCHOR PIN E-RING Replaces: 53-815949 For: Gen II</p>
<p>PKG. OF 2</p>  <p>18-4289 18-4289-9 RETAINING RING Replaces: 53-805272 For: Bravo</p>	<p>PKG. OF 4</p>  <p>18-2336 18-2336-9 TRIM BUSHING Replaces: 23-47392, 23-61291, 23-90203 For: TR & TRS (1977-93), Alpha One SS (1986-1989), SSM (1982-1995)</p>	<p>PKG. OF 8</p>  <p>18-2341-1 18-2341-1-9 POWER TRIM BUSHING Replaces: 23-815950, 23-8159501, 23-815950Q01 For: Gen II</p>	<p>PKG. OF 5</p>  <p>18-3232 18-3232-9 PLUG Replaces: 19-47579, 19-475791 For: MR Alpha</p>

Zinc is for saltwater only applications.
 Magnesium is for fresh water only applications.
 Aluminum is for brackish water or salt water environments.

 <p>18-6154A 18-6154M 18-6154Z ANODE KIT Bravo III (2004 and Newer)</p>	 <p>18-6158M 18-6158Z 18-6158A ANODE KIT Replaces: 888755Q01 (18-6158M), 888756Q01 (18-6158A), 97-888756Q03 (18-6158A, M), 888756A1 (18-6158A, M) Mercuriser Alpha I Gen II (1991 & UP)</p>	 <p>18-6159A 18-6159M 18-6159Z ANODE KIT Replaces: 888758Q01 (18-6159A), 888757Q01 (18-6159M), 97-888758Q03 (18-6160A), 888758A1 (18-6160A), 97-888759Q03 (18-6160M), 888759A1 (18-6160AM) Mercuriser Bravo I - All Years</p>	 <p>18-6160A 18-6160M 18-6160Z ANODE KIT Replaces: 888761Q01 (18-6160A), 97-888761Q03 (18-6160A), 888761A1 (18-6160A), 888760Q01 (18-6160M), 97-888760Q03 (18-6160M), 888760A1 (18-6160M) Bravo II (1989 & Up), Bravo III (1989-03)</p>
 <p>① 18-6117A ② 18-6117M ③ 18-6117Z ANODE Replaces: 97-806188A1, 97-806188Q01 For: Bravo One bearing carrier</p>	 <p>② 18-6241 ③ 18-6011 ① 18-6011A ANODE Replaces: 31640, 31640A1, 97-31640Q4, 31640T6, 97-31640B4, 31640A4, 31640A2, 316404, 316403, 72436A1 For use on: R/MR/Alpha One, Sterndrive & Transom Assembly (1983-90) & prior drives, Alpha One, Gen II (1991 & up)</p>	 <p>③ 18-6012 ANODE Replaces: 34127A1, 34127T2, 34127A2, 34127T1, 34127 For use on: R/MR/Alpha One (Sterndrive & Transom Assembly 1983-90) & prior drives</p>	 <p>③ 18-6013 ANODE Replaces: 34762A1, 97-34672C, 32170, 32170A1 For use on: Alpha One SS (Sterndrive & Transom Assembly 1983-89) & prior drives</p>
 <p>③ 18-6014 ① 18-6014A ANODE Replaces: 46399A1, 822777A1, 822777Q1, 822777A4, 822777A3, 822777Z, 822777, 46399A2 For use on: Alpha One SS (1982-89)</p>	<p>PKG. OF 2</p>  <p>③④ 18-6015-9 ③⑤ 18-60151-9 ⑤① 18-6015A-9 ⑤② 18-6242-9 ANODE Replaces: 55989A3, 55989Q9, 55989T9, 55989A9, 55989A4, 55989</p>	 <p>③ 18-6016 ③④ 18-60161 ③⑤ 18-60161-9 ① 18-6016A ② 18-6244 ANODE Replaces: 76214, 76214Z, 76214A1, 76214A5, 97-76214Q5, 786214A2, 97-762145, 200, 225, 250HP, V-155-V-200, & All Bravos, Alpha One, Gen II (1991 & up) (Threaded through)</p>	 <p>③ 18-6066 ① 18-6066A ② 18-6243 ANODE Replaces: 43994A2, 821631Q1, 821631C, 821631B1, 821631A1 For use on: R/MR/Alpha One (Sterndrive & Transom Assembly 1983-90)</p>

① Aluminum ② Magnesium ③ Zinc
 ④ Standard package of 10 priced per piece ⑤ Standard package of 10 priced per package
 ⑥ Standard package of 2 priced per package

Zinc is for saltwater only applications.
 Magnesium is for fresh water only applications.
 Aluminum is for brackish water or salt water environments.



② 18-6114
 ③ 18-6067
 ① 18-6067A
ANODE

Replaces: 97-806189, 806189A1,
 97-806189Q1
 For: Alpha One, Gen II (1991 & up)



③ 18-6066
ANODE

Replaces: 826134, 826134A1,
 97-826134Q
 Alpha One (Gen II)



② 18-6099
 ③ 18-6080
 ① 18-6080A
ANODE

Replaces: 815933A1, 821629A1,
 97-821629Q1
 For: Alpha One (Gen II) (1991 & UP)



② 18-6089
 ③ 18-6092
 ① 18-6092A
ANODE

Replaces: 97-806190, 806190A1,
 97-806190Q1, 806190T1,
 97-806190B4
 All Bravos



② 18-6079
 ③ 18-6093
 ① 18-6093A
ANODE

Replaces: 806105, 806105A1, 806105Q1,
 806105T1
 For: Alpha One (Gen II) (1991 & UP)



① 18-6150A
 ② 18-6150M
 ③ 18-6150Z
ANODE KIT

Replaces: 888756Q02, 888756Q4, 888756A2
 For: MR & Alpha One Drives



② 18-6240
 ③ 18-6094
 ① 18-6094A
ANODE

Replaces: 821630C2, 821630A1, 97-821630Q1,
 817373A1
 All Bravos

— CONTAINS —

Part #	Desc.	O.E.#	Qty.
18-2589	Face Seal and Tool	26-818575A2	1
18-2584-1	Water Pump Base		
	To Face Plate Gasket	27-43033-1	1
18-2566	Face Plate to Water		
	Pump Cover Gasket	27-817277	1
18-2945	Drain Screw Gasket	12-19183	1
18-2944	Seal	26-45577	1
18-2002	Oil Seal	26-30550, 26-76868	1
18-2009	Oil Seal	26-892361	1
18-2013	Oil Seal	26-16977	1
18-2014	Oil Seal	26-89238	1
18-2054	Oil Seal	26-81846-1	1
18-2056	Oil Seal	26-965031	2
18-2076	Oil Seal	26-12224	1
18-2077	Oil Seal	26-14077	1
18-7159	O-Ring	25-31534	1
18-7168	O-Ring	25-48171	2
18-7176	O-Ring	25-90011	1
18-7420	O-Ring	25-21836	2
18-7440-1	O-Ring	25-36318	2
18-2056	Oil Seal	26-66302	2
18-7413	O-Ring	25-62702	1



**18-2646-1
 LOWER UNIT SEAL KIT**

Replaces: 26-816575A3, 26-816575A1
 For: Alpha Gen II

— CONTAINS —

Part #	Description	O.E.#	Qty.
18-2516	Bravo Outdrive Seal	18755	1
18-1240	Outdrive Seal	12708	1
18-2945	Drain Screw Gasket	12-19183	1
18-7198	O-Ring	25-45710	1
18-7102	O-Ring	25-62706	1
18-7105	O-Ring	25-62705	1
18-7449	O-Ring	25-97387	1
18-7153	O-Ring	25-25439	2
18-7167	O-Ring	25-97386	1
18-2010	NSS	26-12709	1
18-2715	Spring Kit	24-17997A1	1
18-7117	O-Ring	25-35027	1
18-7169	O-Ring	25-70937	1



**18-2643
 UPPER UNIT SEAL KIT**

Replaces: 26-16709A2,
 26-16709A1
 BRAVO - BLACKHAWK

— CONTAINS —

Part #	Desc.	O.E.#	Qty.
18-2944	Seal Gasket	26-45577	1
18-2945	Drain Screw Gasket	12-19183	3
18-7188	Drain Screw O-Ring	26-805726	1
18-7169	O-Ring	25-70937	1
18-7161	O-Ring	25-32546	1
18-7420	O-Ring	25-25439	2
18-7103	O-Ring	25-29845	2
18-7117	O-Ring	25-35027	1
18-2056	Oil Seal	26-965031	2
18-2003	Oil Seal	26-88493, 26-32080, 26-36054, 26-823894	1
	NSS	26-88397	1
18-3289	Double Lip Seal	26-864319	1
18-2715	Spring Kit	24-17997A1	1



**18-2644
 UPPER UNIT SEAL KIT**

Replaces: 26-88397A1
 ALPHA I GENERATION II

SEAL KIT APPLICATION BEGINS ON PAGE 874

① Aluminum
 ② Magnesium ③ Zinc ④ Standard package of 10 priced per piece

-- CONTAINS --

Part #	Description	O.E. #	Qty.
18-2944	Seal Gasket	26-45577	1
18-2945	Drain Screw Gasket	12-19183	1
18-7163	O-Ring	25-33465	1
18-7159	O-Ring	25-31534	1
18-2002	Oil Seal	26-70019, 26-73838	2
18-0563	Seal	26-36556	1

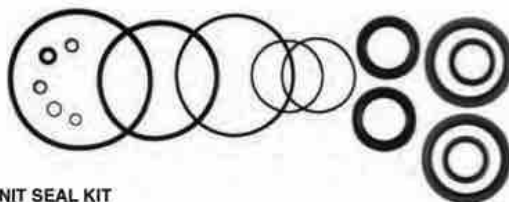

18-2645
LOWER UNIT SEAL KIT
Replaces: 26-76868A1, 26-76868A2, 26-76868A04
Bravo I, II & III MODELS

-- CONTAINS --

Part #	Description	O.E. #	Qty.
18-2945	Drain Screw Gasket	12-19183	2
18-0894	Water Pocket Cover Gasket	27-55810	1
18-2003	Oil Seal	26-823894	1
18-2049	Oil Seal	26-32511	1
18-2056	Oil Seal	26-965031	1
18-2944	Seal Ring Gasket	26-45577	1
18-3110	Bushing	26-39970	1
18-7153	O-Ring	25-25439	2
18-7181	O-Ring	25-32546	1
18-7169	O-Ring	25-70937	1
NSS	O-Ring	25-55801	1



18-2648
UPPER UNIT SEAL KIT
Replaces: 26-32511A1
S/N 1684188 & UP
For: #1 Units (Including ALPHA) (Also fits 888 Stern drive)
S/N 3106717 & UP

-- CONTAINS --

Part #	Description	O.E. #	Qty.
18-2919	Water Pump to Gear Hsg. Gasket	27-42631-1	1
18-3110	Grommet	26-38970	1
18-2002	Oil Seal	26-70019, 26-73838	1
18-2013	Oil Seal	26-16977	2
18-2014	Oil Seal	26-89238	1
18-2826	Water Pump Base to Gear Hsg. Gasket	27-85610-1	1
18-2914	Lower Water Pump to Wear Plate Gasket	27-85608-1	1
18-2915	Upper Water Pump to Wear Plate Gasket	27-85609-1	1
18-2944	Seal Ring Gasket	26-45577	1
18-2948	Gear Housing Plastic Flush Screw Gasket	12-49221-1	1
18-7158	O-Ring	25-30613	1
18-7159	O-Ring	25-31534	1
18-7162	O-Ring	25-33145	1
18-7176	O-Ring	25-90011	1
—	O-Ring	25-38099	1
18-2154	Bushing, Shift Shaft	23-30617A2	1
18-2076	Line Cutter Oil Seal	26-12224	1
18-7426	O-Ring	25-30271	1
18-2945	Drain Screw Gasket	12-20260, 12-19183	2



18-2652
LOWER UNIT SEAL KIT
Replaces: 26-33144A2, 26-33144A1, 26-89238A1
S/N 1684188 & UP
For: #1 Units (Including ALPHA)

-- CONTAINS --

Part #	Description	O.E. #	Qty.
18-2652	Lower Gear Housing Seal Kit	26-33144A2	1
18-1155	Ball Bearing	30-88957A1	1
18-1117	Pinion Bearing	31-42647A1	1
18-1143	Tapered Roller Bearing	31-36387A1	1
18-3719	Pinion Nut	11-35921	1
18-2299	Tab Washer	14-79447	1
18-2298	Tab Washer	14-18323	1
18-1158	Needle Roller Bearing	31-30956	1
18-1159	Tapered Roller Bearing	31-35928A1	1
18-2285	Shim Kit	15-47397A1	1
18-1157	Needle Roller Bearing	31-30895	1
18-2343	Washer	12-982721	1
18-2294	Shim Kit	2470	1



18-8208
SEAL & BEARING KIT
Replaces: 31-803080T1
For: MR/Alpha Drive

-- CONTAINS --

Part #	Description	O.E. #	Qty.
18-2340	Shift Shaft Rubber Washer	12-31265	1
18-2076	Oil Seal	26-12224	1
18-7159	O-Ring	25-31534	1
18-2002	Oil Seal	26-76868	1
18-3109	Water Tube	23-28804	1
18-2154	Shift Bushing	23-30617A2	1
18-3116	Housing	46-96148A1	1
18-3017	Impeller	47-89984	1
18-2914	Water Pump Gasket	27-85608-1	1
18-7158	O-Ring	25-30613	1
18-7176	O-Ring	25-90011	1
18-2944	Seal Ring Gasket	26-45577	1
18-7173	O-Ring	25-30224	1
18-2826	Water Pump Base to Gear Housing Gasket	27-85610-1	1
18-2915	Water Pump Gasket	27-85609-1	1
18-3117	Plate	32435	1
18-7162	O-Ring	25-33145	1
18-2919	Water Pump Gasket	27-42631-1	1
18-2801	Water Pump Gasket	27-32438	1
18-7426	O-Ring	25-30271	1
18-2945	Drain Screw Gasket	26-20260, 12-19183	2
18-3110	Grommet	26-38970	1
18-2013	Seal	26-16977	1
18-2014	Seal	26-89238	1



18-8370
COMPLETE LOWER GEAR CASE REBUILD KIT
Includes: Water Pump and Complete Seal Kit
For: Mercuriser R/MR/ALPHA 1

SEAL KIT APPLICATION BEGINS ON NEXT PAGE

Model	Year	Beginning Serial #	Ending Serial #	Driveshaft Hsg Seal Kit	J-Joint Seal	U-Joint Carrier Seal	Gear Hsg Seal & Brg Kit	Gear Hsg Seal Kit	Brg Carrier O-Ring	Brg Carrier Seal
60 / 80 / 90	1965-1972	1830753	3225967	N/A	N.L.A.	N/A	N/A	N/A	18-7160	18-2011
IA / IB / IC / EZ SHIFT	1964-1966	1684188	2065186	18-2648	18-2003	18-0577	N/A	18-2652	18-7159	18-2002
120 / 140	1967-1982	2082141	6225576	18-2648	18-2003	18-0577	N/A	18-2652	18-7159	18-2002
470 / 485	1976-1982	4208730	6225575	18-2648	18-2003	18-0577	N/A	18-2652	18-7159	18-2002
160 / 165	1967-1981	2065190	& UP	18-2648	18-2003	18-0577	N/A	18-2652	18-7159	18-2002
888	1971-1977	3106717	& UP	18-2648	18-2003	18-0577	N/A	18-2652	18-7159	18-2002
225 / 233	1974-1977	3856268	& UP	18-2648	18-2003	18-0577	N/A	18-2652	18-7159	18-2002
888 / 228 / 250 / 260	1977-1982	4782330	6225576	18-2648	18-2003	18-0577	N/A	18-2652	18-7159	18-2002
R	1983	6225577	& UP	18-2648	18-2003	18-0577	N/A	18-2652	18-7159	18-2002
MR ALPHA ONE	1984-1990	6225577	D469858	18-2648	18-2003	18-0577	18-8208	18-2652	18-7159	18-2002 ③
MR ALPHA ONE	1984-1990	6225577	D469858	18-2648	18-2003	18-0577	18-8208	18-2652	18-7159	18-2077 ①
MR ALPHA ONE	1984-1990	6225577	D469858	18-2648	18-2003	18-0577	18-8208	18-2652	18-7159	18-2076 ②
MR ALPHA ONE (CR)	1984-1990	6225577	D469858	18-2648	18-2003	18-0577	N.L.A.	18-2652	18-7159	18-2077 ③
MR ALPHA ONE (CR)	1984-1990	6225577	D469858	18-2648	18-2003	18-0577	N.L.A.	18-2652	18-7159	18-2076 ②
ALPHA ONE SS	1986-1989	A545004	& UP	18-2648	18-2003	18-0577	N/A	18-2652	18-7159	18-2002 ③
ALPHA ONE SS	1986-1989	A545004	& UP	18-2648	18-2003	18-0577	N/A	18-2652	18-7159	18-2077 ①
ALPHA ONE SS	1986-1989	A545004	& UP	18-2648	18-2003	18-0577	N/A	18-2652	18-7159	18-2076 ②
APLHA ONE GEN II	1991-1995	D469859	F679999	18-2644	18-2003	18-0577	N/A	18-2646-1	18-7159	18-2077 ①
APLHA ONE GEN II	1991-1995	D469859	F679999	18-2644	18-2003	18-0577	N/A	18-2646-1	18-7159	18-2076 ②
APLHA ONE GEN II (CR)	1991-1995	D469859	F679999	18-2644	18-2003	18-0577	N.L.A.	18-2646-1	18-7159	18-2077 ①
APLHA ONE GEN II (CR)	1991-1995	D469859	F679999	18-2644	18-2003	18-0577	N.L.A.	18-2646-1	18-7159	18-2076 ②
APLHA ONE GEN II	1996-1997	F680000	K999999	18-2644	18-2003	18-0577	N/A	18-2646-1	18-7159	18-2077 ③
APLHA ONE GEN II	1996-1997	F680000	K999999	18-2644	18-2003	18-0577	N/A	18-2646-1	18-7159	18-2076 ②
APLHA ONE GEN II (CR)	1996-2010	F680000	& UP	18-2644	18-2003	18-0577	N.L.A.	18-2646-1	18-7159	18-2077 ③
APLHA ONE GEN II (CR)	1996-2010	F680000	& UP	18-2644	18-2003	18-0577	N.L.A.	18-2646-1	18-7159	18-2076 ②
APLHA ONE GEN II	1996-2010	L100040	& UP	18-2644	18-2003	18-0577	N/A	18-2646-1	18-7159	18-2077 ③
APLHA ONE GEN II	1996-2010	L100040	& UP	18-2644	18-2003	18-0577	N/A	18-2646-1	18-7159	18-2076 ②
BRAVO I	1988-2010	B664190	& UP	18-2643	N/A	N/A	N/A	18-2645	18-7159	18-2002
BRAVO I X	2000-2010	M100001	& UP	18-2643	N/A	N/A	N/A	18-2645	18-7159	18-2002
BRAVO I XR/XZ	2000-2010	M100001	& UP	18-2643	N/A	N/A	N/A	N/A	18-7159	N/A
BRAVO II	1988-2010	B664190	& UP	18-2643	N/A	N/A	N/A	18-2645	N/A	N/A ①
BRAVO II	1988-2010	B664190	& UP	18-2643	N/A	N/A	N/A	18-2645	N/A	N/A ①
BRAVO II X	2000-2010	M100001	& UP	18-2643	N/A	N/A	N/A	18-2645	N/A	N/A ②
BRAVO II X	2000-2010	M100001	& UP	18-2643	N/A	N/A	N/A	18-2645	N/A	N/A ②
BRAVO III	1988-2010	B664190	& UP	18-2643	N/A	N/A	N/A	18-2645	N/A	N/A
BRAVO III X	2000-2010	M100001	& UP	18-2643	N/A	N/A	N/A	18-2645	N/A	N/A
BLACKHAWK	1994-1995	F188717	& UP	18-2643	N/A	N/A	N/A	N/A	N/A	N/A
I	1963	1534570	1684187	18-2648	N/A	18-0577	18-2652	N/A	18-7157	18-2002
II	1962-1969	1474909	2671321	N/A	N/A	N/A	N/A	N/A	18-7159	N.L.A.
III	1968-1972	2373127	3002613	N/A	N/A	N/A	N/A	N/A	N/A	N/A
215E/H	1970-1972	2909035	2915034	N/A	N/A	N/A	N/A	N/A	N/A	N/A
TR	1973-1993	3377316	& UP	N/A	N/A	N/A	N/A	N/A	N/A	N/A
TRS	1973-1983	3377316	& UP	N/A	N/A	N/A	N/A	N/A	18-7159	N/A

① Inner ② Outer ③ w/o Fishline Cutter Seal

② 18-4456D



18-4456 EXHAUST PROTECTOR VALVE
 Replaces: 34765A1, 34765A2
 INCLUDES STAINLESS STEEL CLAMP
 3"

② 18-4457D



18-4457 EXHAUST PROTECTOR VALVE
 Replaces: 12644A1, 12644Q01
 INCLUDES STAINLESS STEEL CLAMP
 4"

② 18-4458D



18-4458 EXHAUST PROTECTOR VALVE
 (Fits both 5" & 6" Exhaust)
 INCLUDES STAINLESS STEEL CLAMP

② Items ending in "D" are Display Packaged - Regular number is Non-Display

OIL SEALS

Part #	O.E. #	Shaft Size (in.)	Dimensions (in.)		
			O.D.	Width	
18-0172	26-97530	0.845	1.500	0.315	
18-0515	26-30530	0.540	1.004	0.303	
18-0516	26-30913	0.500	0.839	0.187	
18-0517	26-32911	1.100	1.280	0.127	
18-0519	26-14240	3.792	4.536	0.482	
18-0522	26-43036	1.045	1.474	0.187	
18-0523	26-43993	1.640	2.132	0.282	
18-0525	26-45587	0.390	0.626	0.124	
18-0526	26-48443	0.750	1.379	0.256	
18-0527	26-56397	0.750	1.127	0.343	
18-0529	26-62818	1.640	2.256	0.319	
18-0531	26-72785	0.790	1.880	0.248	
18-0537	26-85107	1.020	1.507	0.251	
18-0578	26-67388	1.800	3.100	0.500	
18-2002	26-76868, 26-70019	1.188	1.692	0.25	
18-2004	26-20070	0.625	1	0.25	
18-2003	26-32080, 26-68493, 26-823894	2.25	3	0.437	
18-2004	26-20070	0.625	1	0.25	
18-2006	26-897154	0.625	1.125	0.312	
18-2007	26-94039, 26-30727, 26-31489	1	1.5	0.312	
18-2008	26-56788	0.875	1.25	0.375	
18-2009	26-892361, 26-25776, 26-31249, 26-46021	0.375	0.75	0.25	
18-2010	26-897153	0.437	0.875	0.25	
18-2011	26-23300, 26-90562, 26-29595	0.75	1.25	0.312	
18-2013	802276, 26-18977, 26-20465, 26-31507, 26-79884	0.875	1.25	0.188	
18-2014	26-33144, 26-77634, 26-89238, 26-F694305	0.875	1.5	0.312	
18-2015	20250, 26-23517	0.75	1.25	0.25	
18-2016	26-20079, 26-25837, 26-29476, 26-41953	1.187	1.875	0.25	
18-2017	26-32121, 26-35025	0.75	1	0.125	
18-2019	26-27183	0.688	1.124	0.25	
18-2026 (1)	802276, 26-18977, 26-20465, 26-31507, 26-79884	0.875	1.25	0.188	
18-2048	26-24590	0.4	0.566	0.094	
18-2049	26-32511	1.25	2.005	0.388	
18-2050	26-55682	1	1.253	0.125	
18-2051	26-89188	0.875	1.253	0.278	
18-2052	26-89189	0.875	1.314	0.322	
18-2053	26-70081	1.188	1.754	0.36	
18-2054	26-76384, 26-8164641	0.375	0.75	0.243	
18-2055	26-21642, 26-26782, 26-79831	0.75	1.127	0.149	
18-2056	26-37259, 26-89237, 26-96503, 26-965031	0.875	1.375	0.250	
18-2076 (1)	26-F697118, 26-12224	1.188	1.690	0.360	
18-2077	26-F697555, 26-14077	1.188	1.689	0.247	

(1) Line Cutter Seal

DRIVESHAFT HOUSING

Stern Drive Model	Beg. S/N	End S/N	Oil Seal	Desc.	Qty.	Stern Drive Model	Beg. S/N	End S/N	Oil Seal	Desc.	Qty.
R/MR/Alpha I	6225577	UP	18-2003	BC	1	250	4791300	4898729	18-2049	GC	1
Alpha I SS		ALL	18-2003	BC	1	250	4791300	4898729	18-2003	BC	1
Alpha I SS		ALL	18-2056	LDS	1	250	4791300	4898729	18-2056	LDS	1
Alpha I SS		ALL	18-2049	GC	1	260	4898730	6225576	18-2049	GC	1
IA,IB,IC	1684188	2065189	18-2003	BC	1	260	4898730	6225576	18-2056	LDS	1
IA,IB,IC	1534570	2065189	18-2049	GC	1	260	4898730	6225576	18-2003	BC	1
IA,IB,IC	1749276	2065189	18-2056	LDS	1	470	4208730	6225576	18-2056	LDS	1
II	1474909	2671321	18-2003	BC	1	470	4208730	6225576	18-2003	BC	1
120/140	2062141	6225576	18-2003	BC	1	470	4208730	6225576	18-2049	GC	1
120/140	2062141	6225576	18-2056	LDS	1	485	4893835	UP	18-2003	BC	1
120/140	2062141	6225576	18-2049	GC	1	485	4893835	UP	18-2049	GC	1
160/165	2065190	UP	18-2003	BC	1	485	4893835	UP	18-2056	LDS	1
160/165	2065190	UP	18-2049	GC	1	888	3106717	UP	18-2055	LDS	1
160/165	2065190	UP	18-2056	LDS	1	888	3106717	UP	18-2049	GC	1
225-S	3856268	4200499	18-2056	LDS	1	888	3106717	UP	18-2003	BC	1
225-S	3856268	4200499	18-2049	GC	1	898/228	4782330	6225576	18-2049	GC	1
225-S	3856268	4200499	18-2003	BC	1	898/228	4782330	6225576	18-2003	BC	1
233	4200500	UP	18-2049	GC	1	898/228	4782330	6225576	18-2056	LDS	1
233	4200500	UP	18-2003	BC	1						
233	4200500	UP	18-2056	LDS	1						

BC Bearing Carrier Seal
GC Gear Chamber Seal
LDS Lower Driveshaft Seal

GEAR HOUSING

Stern Drive Model	Beg. S/N	End S/N	Oil Seal	Desc.	Qty.	Stern Drive Model	Beg. S/N	End S/N	Oil Seal	Desc.	Qty.
MR/Alpha I	6225577	UP	18-2002	PS	2	Alpha I SS	ALL		18-2013	WPBJU	1
R/MR/Alpha I	6225577	UP	18-2008	SSB	1	Alpha I SS	ALL		18-2002	PS	2
R/MR/Alpha I	6225577	UP	18-2014	WPBL	1	BRAVO I	8664190	UP	18-2002	PS	2
MR/Alpha I	6225577	UP	18-2013	WPBJU	1	I	1534570	1536617	18-2008	WPB	1
R	6225577	UP	18-2013	WPBJU	1	I	1534570	1684187	18-2008	SSB	1
Alpha I SS	ALL	18-2014	WPBL	1	I	1534570	1684187	18-2002	PS	2	
Alpha I SS	ALL	18-2009	SSB	1	I	1534570	1684187	18-2013	WP	1	

GEAR HOUSING (Cont.)

Stern Drive Model	Bag. S/N	End S/N	Oil Seal	Desc.	Qty.
I	1836618	1684187	18-2014	WPB	1
I	1563354	1684187	18-2013	WPB	1
IA,IB,IC	1664188	2065189	18-2014	WPB	1
IA,IB,IC	1684188	2065189	18-2002	PS	2
IA,IB,IC	1664188	2065189	18-2013	WPB	1
IA,IB,IC	1684188	2065189	18-2013	WP	1
IA,IB,IC	1664188	2065189	18-2009	SSB	1
TRS	4794900	UP	18-2002	PS	2
60	1830753	2063740	18-2009	SSB	1
60	1830753	2063740	18-2011	WPB.L	1
60	1830753	2063740	18-2055	WPB.U	1
60	1830753	2063740	18-2015	PS.O	1
60	1830753	2063740	18-2011	PS.J	1
80	2063741	2898029	18-2002	PS	2
80	2063741	2898029	18-2009	SSB	1
80	2063741	2898029	18-2055	WPB.U	1
80	2063741	2898029	18-2011	WPB.L	1
90	2898020	3225967	18-2009	SSB	1
90	2898020	3225967	18-2002	PS	2
90	2898020	3225967	18-2011	WPB.L	1
90	2898020	3225967	18-2055	WPB.U	1
120/140	2062141	6225576	18-2013	WPB.U	1
120/140	2062141	4893634	18-2013	WP	1
120/140	2062141	6225576	18-2014	WPB.L	1
120/140	2062141	6225576	18-2009	SSB	1
120/140	2062141	6225576	18-2002	PS	2
160/165	2065190	UP	18-2009	SSB	1
160/165	2065190	UP	18-2014	WPB.L	1
160/165	2065190	UP	18-2002	PS	2
160/165	2065190	4890459	18-2013	WP	1
160/165	2065190	UP	18-2013	WPB.U	1
225-S	3856268	4200499	18-2013	WPB.U	1
225-S	3856268	4200499	18-2014	WPB.L	1
225-S	3856268	4200499	18-2002	PS	2
225-S	3856268	4200499	18-2009	SSB	1

Stern Drive Model	Bag. S/N	End S/N	Oil Seal	Desc.	Qty.
233	4200500	UP	18-2009	SSB	1
233	4200500	UP	18-2013	WPB.U	1
233	4200500	UP	18-2002	PS	2
233	4200500	UP	18-2014	WPB.L	1
250	4791300	4898729	18-2013	WPB.U	1
250	4791300	4898729	18-2014	WPB.L	1
250	4791300	4898729	18-2002	PS	2
250	4791300	4898729	18-2009	SSB	1
255-TRS	3377316	4203748	18-2009	PS	2
260	4898730	6225576	18-2009	SSB	1
260	4898730	6225576	18-2002	PS	2
260	4898730	6225576	18-2013	WPB.U	1
260	4898730	6225576	18-2014	WPB.L	1
280-TRS	4203750	4895999	18-2002	PS	2
470	4208730	6225576	18-2009	SSB	1
470	4208730	6225576	18-2014	WPB.L	1
470	4208730	6225576	18-2002	PS	2
470	4208730	6225576	18-2013	WPB.U	1
485	4893835	UP	18-2002	PS	2
485	4893835	UP	18-2009	SSB	1
485	4893835	UP	18-2013	WPB.U	1
485	4893835	UP	18-2014	WPB.L	1
888	3106717	UP	18-2014	WPB.L	1
888	3106717	UP	18-2009	SSB	1
888	3106717	UP	18-2013	WP	1
888	3106717	UP	18-2013	WPB.U	1
888	3106717	UP	18-2002	PS	2
898/228	4782330	6225576	18-2014	WPB.L	1
898/228	4782330	6225576	18-2013	WPB.U	1
898/228	4782330	6225576	18-2009	SSB	1
898/228	4782330	6225576	18-2002	PS	2

PS Prop Shaft Seal WPB Water Pump Base Seal
 PS.J Prop Shaft, Inner Seal WPB.L Water Pump Base, Lower Seal
 PS.O Prop Shaft, Outer Seal WPB.U Water Pump Base, Upper Seal
 SSB Shift Shaft Bushing Seal WP Water Pump Body Seal

O-RINGS

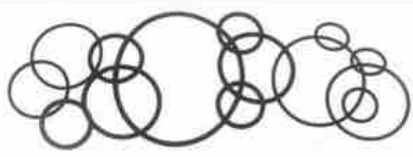

Part #	O.E. #	DIMENSIONS (in.)	
		O.D.	Width
18-0858	25-54029	2.8	0.103
18-0860	25-62700	3.237	0.103
18-7103	25-29845	0.924	0.103
18-7105	25-62705, 25-F7848342	0.75	0.065
18-7107	25-67202	4.75	0.135
18-7114	25-23145, 25-843315, 25-F702736	1	0.135
18-7115	25-28722	1.735	0.135
18-7116	25-62704, 25-85148, 25-32174, 25-20633, 802206, 25-F24342	0.36	0.1
18-7117	25-35027	1.046	0.139
18-7120	25-38933	0.215	0.065
18-7121	25-35028, 25-882613, 802231	3.1	0.135
18-7127	25-32507, F83404	3.315	0.35
18-7134	25-20195, 25-201951	0.5	0.1
18-7135	25-20365, 25-35276	0.75	0.135

Part #	O.E. #	DIMENSIONS (in.)	
		O.D.	Width
18-7143	27-58025, 25-65936, 391-5081	1.31	0.1
18-7145	25-64058	0.25	0.1
18-7146	25-47632	1.12	0.1
18-7151	25-20081, 25-39572	3	0.135
18-7152	25-20863	2.625	0.135
18-7153	25-25439, 25-20679, 25-F53795-1, F53795	0.862	0.103
18-7155	25-26855	1.52	0.135
18-7156	25-29439	1.185	0.1
18-7157	25-29976	3.5	0.21
18-7158	25-30613, 25-946357	0.74	0.1
18-7159	25-31534, 25-48431	3.855	0.21
18-7160	25-31986	2.635	0.21
18-7161	25-32546	3.25	0.07
18-7162	25-32424, 25-33145	2.025	0.135
18-7163	25-33465, 25-853220, 25-807149	2.415	0.1
18-7164	25-33466, 25-67675, 25-846356, 27-898101789	1.375	0.1
18-7165	25-32509, 25-806608, 25-F461342	0.5	0.065
18-7166	25-45254	0.615	0.065
18-7167	25-861844	3.609	0.139

CONTINUED ON NEXT PAGE

O-RINGS (CONT.)

Part #	O.E. #	DIMENSIONS (in.)		Part #	O.E. #	DIMENSIONS (in.)	
		O.D.	Width			O.D.	Width
18-7168 ② ③	25-20587, 25-21720, 25-26834, 25-48171, 25-801334436	0.37	0.065	18-7413 ② ③	22-22175, 25-62702, 25-F50342-1, F50342, F17510	0.301	0.07
18-7169 ② ③	25-35984, 25-70937	3.5	0.135	18-7414 ② ③	25-823863, 25-62384	1.999	0.07
18-7170 ② ③	25-33504	1.365	0.135	18-7415 ② ③	25-64966	3.739	0.07
18-7171 ② ③	25-30529	1.92	0.1	18-7419 ② ③	25-69222	2.675	0.103
18-7172 ② ③	25-31305	3.25	0.135	18-7420 ② ③	25-21836	0.796	0.139
18-7173 ② ③	25-27018, 25-30224Q	1.875	0.135	18-7421 ① ②	25-16524	0.15	0.065
18-7174 ② ③	25-45711, 25-F45342	0.62	0.1	18-7426 ② ③	25-30271	0.74	0.31
18-7175 ② ③	25-62817	3.75	0.27	18-7440-1 ②	25-36318	0.798	0.103
18-7176 ② ③	25-696523, 25-F74305, F74305-1, F74305, F694555	2.16	0.1	18-7449 ①	25-67387	4.487	0.103
18-7177 ② ③	25-63421, 25-59712	2.625	0.085	18-7459 ①	30311, 25-20626	2.234	0.139
18-7180 ② ③	12-31060, 25-26802, 25-8M2000926	0.445	0.09	18-7464 ①	25-39695, 25-846361	4.234	0.139
18-7188 ①	25-805728	0.381	0.0635	18-7467 ② ③	25-54030, 25-F323555, F323555	2.987	0.103
18-7195 ①	25-6M0927717	2.75	0.07	18-7474 ①	25-94288	1.239	0.07
18-7198 ② ③	25-45710	1.43	0.1	18-7491 ①	25-47254, 25-861844, 785-87386	3.85	0.135
18-7410 ② ③	25-36390	0.676	0.07				
18-7411 ② ③	25-35480, 25-47386, 25-8M2000816	1.25	0.1				

① PKG. OF 1 ② PKG. OF 5 ③ PKG. OF 2 ④ PKG. OF 3

DRIVESHAFT HOUSING

Starn Drive Model	Beg. S/N	End S/N	Oil Seal	Desc.	Qty.	Starn Drive Model	Beg. S/N	End S/N	Oil Seal	Desc.	Qty.
R/MR/Alpha I	6225577	UP	18-7153	UJ	2	215E ①	2909035	2915034	18-7174	FC	1
R/MR/Alpha I	6225577	UP	18-7169	BC	1	215E	2909035	2915034	18-7146	CC	1
R/MR/Alpha I	6225577	UP	18-7161	TC	1	225-S	3856268	4200499	18-7153	UJ	2
Alpha I SS	ALL		18-7161	TC	1	225-S	3856268	4200499	18-7169	BC	1
Alpha I SS	ALL		18-7169	BC	1	225-S	3856268	4200499	18-7161	TC	1
Alpha I SS	ALL		18-7153	UJ	2	233	4200500	UP	18-7161	TC	1
BRAVO (VII)	B664190	UP	18-7198	DSH	1	233	4200500	UP	18-7153	UJ	2
BRAVO (VII)	B664190	UP	18-7153	UJ	2	233	4200500	UP	18-7169	BC	1
I	1534570	1684187	18-7127	DG	1	250	4791300	4898729	18-7153	UJ	2
I,IA,IB,JC	1534570	1777798	18-7165	USSL	1	250	4791300	4898729	18-7169	BC	1
I,IA,IB,JC	1535212	2065189	18-7170	BH	2	250	4791300	4898729	18-7161	TC	1
IA,IB,IC	1684188	2065189	18-7153	UJ	2	255-TRS	3377316	4203749	18-7175	DSH	1
IA,IB,IC	1684188	2065189	18-7169	BC	1	260	4898730	6225576	18-7169	DG	1
II	2398796	2671321	18-7153	UJ	2	260	4898730	6225576	18-7161	TC	1
II SSM	ALL		18-7175	DSH	1	260	4898730	6225576	18-7170	BH	1
II SSM	ALL		18-7153	UJ	2	260	4898730	6225576	18-7153	UJ	2
II TR	3377316	4794899	18-7175	DSH	1	280-TRS	4203750	4895399	18-7175	DSH	1
III/III SSM	ALL		18-7115	FC	1	470	4208730	6225576	18-7169	BC	1
IV SSM ①	ALL		18-7115	FC	1	470	4208730	6225576	18-7161	TC	1
IIA/IB/IC	1534570	2065189	18-7161	TC	1	470	4208730	6225576	18-7153	UJ	2
TR/TRS ②	4794900	UP	18-7153	UJ	2	470	4893835	6225576	18-7170	BH	1
TR/TRS	4794900	UP	18-7175	DSH	1	485	4893835	UP	18-7161	TC	1
120/140	2062141	6225576	18-7161	TC	1	485	4893835	UP	18-7170	BH	1
120/140	2062141	6225576	18-7170	BH	1	485	4893835	UP	18-7153	UJ	2
120/140	2062141	6225576	18-7169	DG	1	485	4893835	UP	18-7169	DG	1
120/140	2062141	6225576	18-7153	UJ	2	888	3106717	UP	18-7161	TC	1
160/165	2065190	UP	18-7170	BH	1	888	3106717	UP	18-7169	BC	1
160/165	2065190	UP	18-7169	DG	1	888	3106717	UP	18-7153	UJ	2
160/165	2065190	UP	18-7153	UJ	2	898/228	4782330	6225576	18-7169	BC	1
160/165	2065190	UP	18-7161	TC	1	898/228	4782330	6225576	18-7161	TC	1
215H	2782203	2909034	18-7153	UJ	2	898/228	4782330	6225576	18-7153	UJ	2
215H	2782203	2909034	18-7146	PC	1	898/228	4898730	6225576	18-7170	BH	1

① 1 ST Design
 ② 5/8" ID
 ③ With Borg Warner Transmission
 BC Bearing Carrier Seal
 BH Bell Housing Seal
 CC Crankshaft Cover Seal
 DG Drive Gear Seal
 DSH Driveshaft Housing Seal
 FC Front Cover Seal
 PC Plug Cover Seal
 TC Top Cover Seal
 USSL Upper Shift Shaft Lever Seal
 UJ U-Joint Yoke Seal

GEAR HOUSING

Stern Drive Model	Beg. S/N	End S/N	Oil Seal	Desc.	Qty.
R/MR/Alpha I	6225577	UP	18-7182	WPB	1
MR/Alpha I	6225577	UP	18-7176	WPB	1 ①
R/MR/Alpha I	6225577	UP	18-7158	UDS	1
R/MR/Alpha I	6225577	UP	18-7159	PBH	1
R/MR/Alpha I	6225577	UP	18-7153	SSB	1
Alpha I SS	ALL		18-7159	PBH	1
Alpha I SS	ALL		18-7158	UDS	1
Alpha I SS	ALL		18-7153	SSB	1
Alpha I SS	ALL		18-7176	WPB	1 ①
BRAVO I	B664190	UP	18-7159	PBH	1
BRAVO VII	B664190	UP	18-7163	GH	1
I	1534570	1684187	18-7157	PBH	1
I	1534570	1536617	18-7153	WPB	1
I	1534570	1684187	18-7153	SSB	1
I,IA,IB,IC	1534570	2065189	18-7158	UDS	1
I,IA,IB,IC	1536618	2065189	18-7162	WPB	1
IA,IB,IC	1684188	2065189	18-7159	PBH	1
IA,IB,IC	1684188	1777798	18-7153	WPB	1
IA,IB,IC	1684188	2065189	18-7153	SSB	1
II	1474909	2671321	18-7159	PBH	1
III	ALL		18-7151	BRL	1
III	ALL		18-7174	BRS	1
TRS	4794900	UP	18-7159	PBH	1
60	1830753	2063740	18-7153	SSB	1
60	1830753	2063740	18-7160	PBH	1
60	1830753	2063740	18-7155	WOAL	1
60	1830753	2063740	18-7114	WOAS	1
80	2063741	2898029	18-7157	PBH	1
80	2063741	2898029	18-7155	WOAL	1
80	2063741	2898029	18-7114	WOAS	1
80	2063741	2898029	18-7153	SSB	1
90	2898020	3225967	18-7114	WOAS	1
90	2898020	3225967	18-7157	PBH	1
90	2898020	3225967	18-7153	SSB	1
90	2898020	3225967	18-7155	WOAL	1
120/140	2062141	6225576	18-7153	SSB	1
120/140	2062141	6225576	18-7158	UDS	1
120/140	2062141	6225576	18-7159	PBH	1
120/140	2062141	6225576	18-7162	WPB	1
120/140	4893835	6225576	18-7114	GH	1 ①
160/165	2065190	UP	18-7162	WPB	1
160/165	2065190	UP	18-7153	SSB	1

Stern Drive Model	Beg. S/N	End S/N	Oil Seal	Desc.	Qty.
160/165	2065190	UP	18-7158	UDS	1
160/165	2065190	UP	18-7159	PBH	1
165	4890460	UP	18-7114	GH	1 ①
225-S	3856268	4200499	18-7153	SSB	1
225-S	3856268	4200499	18-7162	WPB	1
225-S	3856268	4200499	18-7158	UDS	1
225-S	3856268	4200499	18-7159	PBH	1
233	4200500	UP	18-7162	WPB	1
233	4200500	UP	18-7158	UDS	1
233	4200500	UP	18-7159	PBH	1
233	4200500	UP	18-7153	SSB	1
250	4791300	4898729	18-7159	PBH	1
250	4791300	4898729	18-7158	UDS	1
250	4791300	4898729	18-7162	WPB	1
250	4791300	4898729	18-7153	SSB	1
255-TRS	3377316	4203749	18-7159	PBH	1
260	4898730	6225576	18-7162	WPB	1
260	4898730	6225576	18-7159	PBH	1
260	4898730	6225576	18-7153	SSB	1
260	4898730	6225576	18-7158	UDS	1
260	4898730	6225576	18-7114	GH	1 ①
280-TRS	4203750	4895399	18-7159	PBH	1
470	4208730	6225576	18-7159	PBH	1
470	4208730	6225576	18-7162	WPB	1
470	4208730	6225576	18-7158	UDS	1
470	4208730	6225576	18-7153	SSB	1
470	4208730	6225576	18-7114	GH	1 ①
485	4893835	UP	18-7158	UDS	1
485	4893835	UP	18-7162	WPB	1
485	4893835	UP	18-7153	SSB	1
485	4893835	UP	18-7114	GH	1 ①
485	4893835	UP	18-7159	PBH	1
888	3106717	UP	18-7162	WPB	1
888	3106717	UP	18-7158	UDS	1
888	3106717	UP	18-7153	SSB	1
888	3106717	UP	18-7159	PBH	1
898/228	4782330	6225576	18-7158	UDS	1
898/228	4782330	6225576	18-7153	SSB	1
898/228	4782330	6225576	18-7159	PBH	1
898/228	4782330	6225576	18-7162	WPB	1
898/228	4898730	6225576	18-7114	GH	1 ①

- ① 2.019 ID
- ② 2.17 ID
- ③ V-8 Engines Only
- BRL Bearing Retainer Large Seal
- BRS Bearing Retainer Small Seal
- GH Gear Housing Seal

- PGH Prop Bearing Housing Seal
- SSB Shift Shaft Bushing
- UDS Upper Driveshaft Seal
- WOAL Water & Oil Adapter Large Seal
- WOAS Water & Oil Adapter Small Seal
- WPB Water Pump Base Seal

GIMBAL HOUSING

Stern Drive Model	Beg. S/N	End S/N	Oil Seal	Desc.	Qty.
R/MR/Alpha I	6225577	UP	18-7170	BH	1
BRAVO (VII)	B664190	UP	18-7168	V	2 ①
I	1534570	1641940	18-7185	GHB	2
II	1474909	1475005	18-7151	SL	1

Stern Drive Model	Beg. S/N	End S/N	Oil Seal	Desc.	Qty.
II	1602196	2671321	18-7162	GHAS	1
II	1732380	2671321	18-7172	GHAL	1
III/III SSM/IV		ALL	18-7159	BH	1
60	1830753	2063740	18-7172	BH	1

- ① With Oil Reservoir
- BH Bell Housing Seal
- EE Exhaust Elbow Seal
- GH Gimbal Housing Seal
- GHAL Gimbal Housing Adapter Large Seal

- GHAS Gimbal Housing Adapter Small Seal
- GHB Gimbal Housing Bolt Seal
- SL Steering Lever Seal
- V Valve Seal

⑤ This product is priced per piece. To order priced per package, please add -9 to the part number.

GIMBAL HOUSING (CONT.)

Stern Drive Model	Beg. S/N	End S/N	Oil Seal	Desc.	Qty.
80	2063741	2898029	18-7172	BH	1
90	2898020	3225967	18-7172	BH	1
120/140	2062141	6225576	18-7152	EE	1
160/165	2065190	UP	18-7152	EE	1
225-S	3856268	4200499	18-7170	BH	1
225-S	3856268	4200499	18-7152	EE	1
225-S	3856268	4200499	18-7114	GH	1
233	4200500	UP	18-7152	EE	1
233	4200500	UP	18-7114	GH	1
233	4200500	UP	18-7170	BH	1
250	4791300	4898729	18-7152	EE	1
250	4791300	4898729	18-7114	GH	1
250	4791300	4898729	18-7170	BH	1
260	4898730	6225576	18-7152	EE	1
470	4208730	6225576	18-7152	EE	1

Stern Drive Model	Beg. S/N	End S/N	Oil Seal	Desc.	Qty.
470	4208730	4893934	18-7170	BH	1
465	4893835	UP	18-7152	EE	1
888	3106717	UP	18-7170	BH	1
888	3106717	UP	18-7114	GH	1
888	3106717	UP	18-7152	EE	1
888/228	4782330	4898729	18-7170	BH	1
888/228	4782330	4898729	18-7114	GH	1
888/228	4782330	6225576	18-7152	EE	1

- ① With Oil Reservoir
- BH Bell Housing Seal
- EE Exhaust Elbow Seal
- GH Gimbal Housing Seal
- GHAL Gimbal Housing Adapter Large Seal
- GHAS Gimbal Housing Adapter Small Seal
- GHB Gimbal Housing Bolt Seal
- SL Steering Lever Seal
- V Valve Seal

HYDRAULIC PUMP ASSY

Stern Drive Model	Beg. S/N	End S/N	Oil Seal	Desc.	Qty.
R/MR/Alpha I	6225577	UP	18-7168	CV	4
BRAVO (II)	8664190	UP	18-7134	ORC	1
BRAVO (III)	8664190	UP	18-7158	ORS	1
II	2398798	2671321	18-7168	CV	4
II TR	3377316	4794899	18-7168	CV	4
III/II SSM/IV		ALL	18-7168	CV	4
TR/TRS	4794900	UP	18-7168	CV	4
80	2898020	3225967	18-7168	CV	4
120/140	2062141	6225576	18-7168	CV	4
160/165	2065190	UP	18-7168	CV	4

Stern Drive Model	Beg. S/N	End S/N	Oil Seal	Desc.	Qty.
215HE	2782203	2915034	18-7168	CV	4
225-S	3856268	4200499	18-7168	CV	4
233	4200500	UP	18-7168	CV	4
255-TRS	3377316	4203748	18-7168	CV	4
260	4898730	6225576	18-7168	CV	4
280-TRS	4203750	4895399	18-7168	CV	4
470	4208730	6225576	18-7168	CV	4
485	4893835	UP	18-7168	CV	4
888	3106717	UP	18-7168	CV	4
888/228	4898730	6225576	18-7168	CV	4

CV - Control Valve ORC - Oil Reservoir Connector ORS - Oil Reservoir Switch

REVERSE LOCK VALVE

Stern Drive Model	Beg. S/N	End S/N	Oil Seal	Desc.	Qty.
R/MR/Alpha I	6225577	UP	18-7174	VC	1
R/MR/Alpha I	6225577	UP	18-7198	V	1
II	2398798	2671321	18-7198	V	1
II	2398798	2671321	18-7174	VC	1
120/140	2062141	6225576	18-7198	V	1
120/140	2062141	6225576	18-7174	VC	1
160/165	2065190	UP	18-7198	V	1
160/165	2065190	UP	18-7174	VC	1
250	4791300	4898729	18-7198	V	1

Stern Drive Model	Beg. S/N	End S/N	Oil Seal	Desc.	Qty.
250	4791300	4898729	18-7174	VC	1
260	4898730	6225576	18-7198	V	1
260	4898730	6225576	18-7174	VC	1
470	4208730	6225576	18-7198	V	1
470	4208730	6225576	18-7174	VC	1
485	4893835	UP	18-7174	VC	1
485	4893835	UP	18-7198	V	1
888/228	4782330	6225576	18-7174	VC	1
888/228	4782330	6225576	18-7198	V	1

V - Valve Seal VC - Valve Cover Seal



① 18-5001D



**18-5001
TUNE-UP KIT**
Replaces: 172525

—CONTAINS—

Part #	O.E. #	Description
18-5157	580290	Contact Set
18-5200	580256	Condenser



**18-5250
TUNE-UP KIT**
Replaces: 172527

—CONTAINS—

Part #	O.E. #	Description
18-5311	380538	Contact Set
18-5345	380537	Condenser
18-5418	384735	Rotor

Delco 4 & 6 cyl.



**18-5251
TUNE-UP KIT**
Replaces: 173619

—CONTAINS—

Part #	O.E. #	Description
18-5314	382135	Contact Set
18-5338	382136	Condenser
18-5404-1	982211	Rotor

18-5376 cap.



**18-5256
TUNE-UP KIT**
Replaces: 172531

—CONTAINS—

Part #	O.E. #	Description
18-5314	382135	Contact Set
18-5338	382136	Condenser
18-5411	982342	Rotor

Mallory 6 cyl. Flat Cap

① 18-5258D



**18-5258
TUNE-UP KIT**
Replaces: 173690, 987925

—CONTAINS—

Part #	O.E. #	Description
18-5303	980893	Contact Set
18-5347	980894	Condenser
18-5407	980892	Rotor

Prestolite 8 cyl.



**18-5260
TUNE-UP KIT**
Replaces: 173829, 987926

—CONTAINS—

Part #	O.E. #	Description
18-5303	980893	Contact Set
18-5347	980894	Condenser
18-5403	982880	Rotor



**18-5266
TUNE-UP KIT**

Fits: Flame Thrower Distributors 18-5481, 18-5482, 18-5483, 18-5477, 18-5478 and 18-5479.



**18-5268
TUNE-UP KIT**

—CONTAINS—

Part #	O.E. #	Description
18-5311	380538	Contact Set
18-5345	380537	Condenser
18-5418	384735	Rotor
18-5385	380541	Distributor Cap

Delco In-Line 4 - Single Point



**18-5269
TUNE-UP KIT**

—CONTAINS—

Part #	O.E. #	Description
18-5311	380538	Contact Set
18-5345	380537	Condenser
18-5418	384735	Rotor
18-5386	980152	Distributor Cap

Delco In-Line 6 - Single Point



**18-5252
TUNE-UP KIT**

—CONTAINS—

Part #	Description
18-5310	Contact Set
18-5344	Condenser
-	Rotor

Delco 8 cyl.



**18-5271
TUNE-UP KIT**

—CONTAINS—

Part #	O.E. #	Description
18-5314	382135	Contact Set
18-5338	382136	Condenser
18-5404-1	982211	Rotor
18-5376	982209	Distributor Cap

Mallory V-8 - Single Point - Top Terminal



**18-5272
TUNE-UP KIT**

—CONTAINS—

Part #	O.E. #	Description
18-5314	382135	Contact Set
18-5338	382136	Condenser
18-5411	982342	Rotor
18-5375	382133	Distributor Cap

Mallory Flat V-8 - Single Point - Side Terminal - Flat Cap



**18-5275
TUNE-UP KIT**

—CONTAINS—

Part #	O.E. #	Description
18-5303	980893, 987136,	Contact Set
	987894	
18-5347	980894, 987895	Condenser
18-5403	982880	Rotor
18-5352	984401	Distributor Cap

Prestolite V-8 - Single Point - Screw Cap

APPLICATION BEGINS ON PAGE 888

① Items ending in "D" are Display Packaged - Regular number is Non-Display

 <p>18-5276 TUNE-UP KIT —CONTAINS— Part # O.E.# Description 18-5303 980893, 987136, Contact Set 987894 18-5347 980894, 987895 Condenser 18-5403 982880 Rotor 18-5353 984398 Distributor Cap Prestolite V-6 - Single Point - Screw Cap</p>	 <p>18-5277 TUNE-UP KIT —CONTAINS— Part # O.E.# Description 18-5303 980893, 987136, 987894 Contact Set 18-5347 980894, 987895 Condenser 18-5407 980892 Rotor 18-5369 982336 Distributor Cap Prestolite V-8 - Single Point - Clip Cap</p>	 <p>18-5278 TUNE-UP KIT For: Delco EST V-6</p>	 <p>18-5279 TUNE-UP KIT For: Prestolite Electronic V-8 —CONTAINS— Part # Description O.E.# Qty. 18-5352 Distributor Cap 392-9768 1 18-5403 Rotor 392-9089 1</p>	
 <p>18-5280 TUNE-UP KIT For: Delco EST In-Line 4 —CONTAINS— Part # Description O.E.# Qty. 18-5361 Distributor Cap 986643 1 18-5406 Rotor, Delco 986651 1</p>	 <p>18-5281 TUNE-UP KIT For: Delco EST V-8</p>	 <p>18-5283 TUNE-UP KIT For: Mallory Single Point In-Line 4 —CONTAINS— Part # Description 18-5397 Distributor Cap 18-5404-1 Rotor 18-5314 Contact Set 18-5338 Condenser</p>	 <p>18-5157 CONTACT SET Replaces: 580290</p>	
 <p>18-5303 CONTACT SET Replaces: 980893, 987136, 987894</p>	 <p>18-5310 CONTACT SET Replaces: 380543</p>	 <p>18-5311 CONTACT SET Replaces: 380538</p>	 <p>18-5314 CONTACT SET Replaces: 382135</p>	 <p>18-5200 CONDENSER Replaces: 580256</p>
 <p>18-5338 CONDENSER Replaces: 382135</p>	 <p>18-5344 CONDENSER Replaces: 382125</p>	 <p>18-5345 CONDENSER Replaces: 380537</p>	 <p>18-5347 CONDENSER Replaces: 980894, 987895</p>	 <p>18-5403 ROTOR Replaces: 982880</p>
 <p>18-5404-1 ROTOR Replaces: 982211</p>	 <p>18-5405 ROTOR Replaces: 3854549 V-8 Fits new GM style "Module in Cap"</p>	 <p>18-5406 ROTOR Replaces: 986651 Use with 18-5361 Distributor Cap</p>	 <p>18-5407 ROTOR Replaces: 980892</p>	 <p>18-5408 ROTOR Replaces: 3854311 V-6 Fits new GM style "Module in Cap"</p>

APPLICATION BEGINS ON PAGE 888



**18-5411
ROTOR**
Replaces: 982342



**18-5413
ROTOR**
Replaces: 987986



**18-5418
ROTOR**
Replaces: 384735



**18-5419
ROTOR**
Replaces: 380542



**18-5301
TUNE-UP KIT**
Fits: Male cap V-8 flamethrower distributors



**18-5302
TUNE-UP KIT**
Fits: Male cap v-8 flamethrower distributors



**18-5473
DISTRIBUTOR CAP**
Black Distributor Cap with Male Terminals for Flamethrower Distributors



**18-5474
DISTRIBUTOR CAP**
Red Distributor Cap with Male Terminals for Flamethrower Distributors



**18-5248
DISTRIBUTOR CAP**
Replaces: 3854217
Fits: OMC 5.0L(1994-96), 5.8L(1994-96)



**18-5352
DISTRIBUTOR CAP**
Replaces: 984401
Prestolite



**18-5353
DISTRIBUTOR CAP**
Replaces: 984398
Prestolite



**18-5354
DISTRIBUTOR CAP**
Replaces: 3854548
V-8
Fits new GM style "module in cap"



**18-5361
DISTRIBUTOR CAP**
Replaces: 986643



**18-5362
DISTRIBUTOR CAP**
Replaces: 3854331
V-6
Fits new GM style "Module in Cap"



**18-5369
DISTRIBUTOR CAP**
Replaces: 982336
w/Gasket 18-5399



**18-5375
DISTRIBUTOR CAP**
Replaces: 382133



**18-5376
DISTRIBUTOR CAP**
Replaces: 982209
Mallory



**18-5384
DISTRIBUTOR CAP**
Replaces: 383587



**18-5385
DISTRIBUTOR CAP**
Replaces: 380541



**18-5386
DISTRIBUTOR CAP**
Replaces: 980152



**18-5397
DISTRIBUTOR CAP**
Replaces: 985218
Mallory 9-29418
Fits: Ford 2.3L w/Mallory Distributor (87-90)



**18-5107-1
IGNITION MODULE**
Replaces: 3854003
4/6/8 cyl

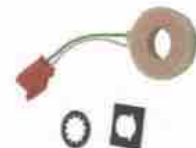

**18-5108
SENSOR
(PICK-UP COIL)**
Replaces: 3854001, 986642
4, V-6 and V-8 cyl

 <p>18-26810 GM HEI 4 TERMINAL PIGTAIL Fits: GM HEI Distributors w/4 terminals</p>	 <p>18-26811 GM HEI 2 TERMINAL PIGTAIL Fits: GM HEI Distributors w/2 terminals</p>	 <p>18-26812 HEI COIL GRAY CONNECTOR</p>	 <p>18-26813 HEI COIL BLACK CONNECTOR</p>	 <p>18-29322 CAP & ROTOR KIT Fits: Ford HEI Distributors</p>
---	--	---	---	---

FEATURES



- ★ Oil filled for better cooling and long life
- ★ Low resistance and improved turn ratios produces the higher voltage needed to run larger spark plug gaps for added power and better fuel economy
- ★ More windings maximize energy and reliability over the full RPM range
- ★ Fits existing brackets for easy installation

 <p>18-5466 HI-PERFORMANCE IGNITION COIL 1.5 ohm (oil filled), black - 8 cylinder. Flame-Thrower 40,000 volt coil. ★ Designed for use with the original Ignitor Electronic Conversion Kits ★ Can be used with other inductive ignition systems</p>	 <p>18-5469 HI-PERFORMANCE IGNITION COIL 3.0 ohm (oil filled), black - 4 & 5 cylinder. Flame-Thrower 40,000 volt coil. ★ Designed for use with the original Ignitor Electronic Conversion Kits ★ Can be used with other inductive ignition systems</p>	 <p>18-5472 HI-PERFORMANCE IGNITION COIL 0.8 ohm (oil filled), black - 4, 6, & 8 cylinder-Flame-Thrower 45,000 volt coil. ★ Super low 0.6 ohm resistance coil designed for use with the Ignitor II Hi Performance Electronic Conversion Kits ★ Compatible with capacitive discharge systems</p>
---	---	--

Part #	Description	Recommended Coil	Resistance Ohms	Part #	Description	Recommended Coil	Resistance Ohms
18-5203-1	Electronic Conversion Kit	18-5469	3.0	18-5288	Hi Performance Electronic Conversion Kit	18-5472	0.6
18-5294	Electronic Conversion Kit	18-5469	3.0	18-5289	Hi Performance Electronic Conversion Kit	18-5472	0.6
18-5295	Electronic Conversion Kit	18-5469	3.0	18-5290	Hi Performance Electronic Conversion Kit	18-5472	0.6
18-5296-2	Electronic Conversion Kit	18-5466	1.5	18-5481	Flame-Thrower Distributor	18-5472	0.6
18-5298	Electronic Conversion Kit	18-5466	1.5	18-5482	Flame-Thrower Distributor	18-5472	0.6
18-5299	Electronic Conversion Kit	18-5466	1.5	18-5483	Flame-Thrower Distributor	18-5472	0.6

 <p>18-5433 IGNITION COIL Replaces: 915735 Uses External Resistor For: 3.0L (1991 & up), 5.7 EFI (1996 & up) and 7.4L EFI (1995 & up)</p>	 <p>18-5437 IGNITION COIL Replaces: 383444, 378231 Metal Encased - 12 Volt Uses External Resistor (For All Applications) For: 1990 & prior stern drives with breaker point ignition</p>	 <p>18-5443 IGNITION COIL Replaces: 3854002 4 cyl./V-8 For: 3.0L (1991 & up), 5.7 EFI (1996 & up) & 7.4 EFI (1995 & up)</p>
---	---	---

 <p>18-5888 SHIFT ASSIST MODULE & HARNESS Replaces: 987738 For: V-8 Sterndrives Fits: 5.0, 5.7 GM (1986-90) 7.5 460 Ford (1987-91)</p>	 <p>18-5889 SHIFT ASSIST MODULE & HARNESS Replaces: 987739 For: V-8 Sterndrives Fits: 5.0, 5.8 Ford (1986-90)</p>	 <p>18-5890 SHIFT ASSIST MODULE & HARNESS Replaces: 987740, 985902 Fits: 2.3, 3.0, 4.3 (1986-90) & 2.5 (1986)</p>
--	---	---

APPLICATION BEGINS ON PAGE 888



FEATURES

- ★ Senses current levels in the coil and adjusts the dwell to maintain peak energy throughout the entire RPM range.
- ★ Develops, on average, 4 times more available energy between 3000 and 5000 RPM's and twice as much plug voltage as point-type systems.
- ★ Ignition energy is sustained and coil life is increased when peak current level is reached just prior to spark.
- ★ More stable timing.
- ★ Use with 18-5472 "Flame Thrower II" Coil for optimum performance



18-5285
HI-PERFORMANCE
ELECTRONIC CONVERSION KIT
Fits: 4 Cylinder Delco Distributors



18-5287-1
HI-PERFORMANCE
ELECTRONIC CONVERSION KIT
Fits: Fits: 6 Cylinder Prestolite Distributors



18-5288
HI-PERFORMANCE
ELECTRONIC CONVERSION KIT
Fits: Most Prestolite V-8 Distributors with snap down cap



18-5289
HI-PERFORMANCE
ELECTRONIC CONVERSION KIT
Fits: Most Prestolite V-8 Distributors with screw down cap



18-5290
HI-PERFORMANCE
ELECTRONIC CONVERSION KIT
Fits: Most Mallory YL or YD 8 cylinder Distributors with clockwise and counter clockwise rotation



FEATURES

- ★ Replaces points & condensers for true solid state ignition.
- ★ Uses standard coil, cap and rotor.
- ★ Easy to install, one-piece, 2-wire hook-up.
- ★ Accurate to within 1/4° timing accuracy 0 to 6000 RPM range.

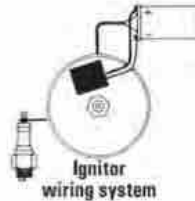

Not compatible with shift assist modules



18-5293-1
ELECTRONIC CONVERSION KIT
For: All Chevrolet V-6 Prestolite with screw down caps



18-5294
ELECTRONIC CONVERSION KIT
Fits: 5 Cyl. Delco distributors



18-5295
ELECTRONIC CONVERSION KIT
Fits: Most 4 Cyl. Prestolite distributors (except IBM 7026)
For: Onan, Universal, Waukesha, Wisconsin

Not compatible with shift assist modules

APPLICATION BEGINS ON PAGE 888

①18-5296-2D 



**18-5296-2
ELECTRONIC
CONVERSION KIT**
Fits: Most Mallory YL & YD 8 cyl.
Distributors with clockwise and counter
clockwise rotation.

①18-5297D 



**18-5297
ELECTRONIC
CONVERSION KIT**
For 4 Cyl. Delco Distributors

①18-5298D 



**18-5298
ELECTRONIC
CONVERSION KIT**
(with snap down cap)
For: Most Prestolite V-8 Distributors

①18-5299D 



**18-5299
ELECTRONIC
CONVERSION KIT**
(with screw down cap)
For: Most Prestolite V-8 Distributors
Use with 18-5403 style rotor.

Not compatible with shift assist modules



FEATURES

- ★ Distributors feature the Ignitor II Ignition module with adaptive dwell control adjusts the spark timing over the entire RPM range to maximize performance
- ★ Upper roller bearing and oil impregnated bronze sintered bottom bushing are installed and aligned bored for accuracy for maximum durability
- ★ Machined heat treated gear with tight tolerances insures durability and consistent timing to maximize horsepower and performance. Complete with high dielectric strength cap and rotor for years of performance

Standard Rotation

CCW Rotation

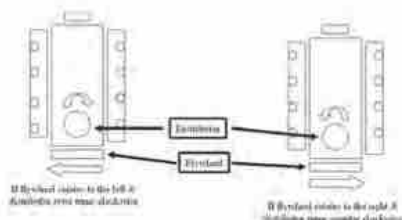

**18-5477
ELECTRONIC DISTRIBUTOR**
Fits: Ford 302 V-8 engines
Replacement Cap/Rotor Kit 18-5266



**18-5480
COMPLETE
IGNITION CONVERSION KIT**
Fits: GM SB & BB with Standard Deck Height
— CONTAINS —

Part #	Description
18-5472	Coil
18-8803-2	Wire Set
18-5483	Distributor



**18-5481
HI-PERFORMANCE
ELECTRONIC
DISTRIBUTOR**
Fits: Ford V-8 351 Windsor
Replacement cap/rotor kit: 18-5266



**18-5482
HI-PERFORMANCE
ELECTRONIC
DISTRIBUTOR**
Fits: Ford V-8 351 Cleveland, 351M, 400,
429 and 460 engines
Replacement cap/rotor kit: 18-5266



**18-5483
HI-PERFORMANCE
ELECTRONIC
DISTRIBUTOR**
Fits: Chevrolet Marine Small and Big Block
engines (Standard Deck Height)
Replacement cap/rotor kit: 18-5266

APPLICATION BEGINS ON PAGE 888

① Items ending in "D" are Display Packaged - Regular number is Non-Display



18-5478
ELECTRONIC DISTRIBUTOR
 Chrysler LA series V-8 engines
 Replacement Cap/Rotor Kit 18-5266



18-5479
ELECTRONIC DISTRIBUTOR
 GM V-8 engines—reverse rotation
 Replacement Cap/Rotor Kit 18-5266



18-5476
DISTRIBUTOR
 Fits: GM V-6 engines with Delco EST ignition HEI
 Tune-Up Kit 18-5278



18-5486-2
ELECTRONIC DISTRIBUTOR
 Replaces: Mallory YLM673AV
 Conventional Rotation
 For: Chevrolet L4, 153 & 181 CID

—CONTAINS—

Part #	Description
18-5397	Distributor Cap
18-5488	Module
18-5404-1	Rotor



18-5487-2
ELECTRONIC DISTRIBUTOR
 Replaces: 9-26309, Mallory YLM676AV
 Conventional Rotation
 For: GM L6, 194, 230, 250, 292 CID

—CONTAINS—

Part #	Description
18-5488	Module
18-5404-1	Rotor



18-5489-2
ELECTRONIC DISTRIBUTOR
 Replaces: Mallory YLM554CV
 Conventional Rotation
 For: Ford V8 951W CID

—CONTAINS—

Part #	Description
18-5376	Distributor Cap
18-5488	Module
18-5404-1	Rotor



18-5494-2
ELECTRONIC DISTRIBUTOR
 Replaces: Mallory YLM624AV
 Conventional Rotation
 For: Chevrolet all V8 includes 482, 502, 540 CID
 (Except 348, 409 & Tall Deck Big Block)

—CONTAINS—

Part #	Description
18-5376	Distributor Cap
18-5488	Module
18-5404-1	Rotor



18-5495-2
ELECTRONIC DISTRIBUTOR
 Replaces: Mallory YLM512CV
 Conventional Rotation
 For: Ford V8 302 CID

—CONTAINS—

Part #	Description
18-5376	Distributor Cap
18-5488	Module
18-5404-1	Rotor



18-5496-2
ELECTRONIC DISTRIBUTOR
 Replaces: Mallory YLM567CV
 Conventional Rotation
 For: Ford V8 351C — 460 CID

—CONTAINS—

Part #	Description
18-5376	Distributor Cap
18-5488	Module
18-5404-1	Rotor

**18-5484-1
ELECTRONIC
DISTRIBUTOR**

Replaces: 3857400, 3850399
Late HEI

Conventional Rotation
V8 262-454 & 502 except 348/409 and
tall block engines
• Designed as a plug-in replacement for
GM-style fuel injection system distributors

—CONTAINS—

Description	Part #
Distributor Cap	18-5354
Rotor	18-5405

Tune-Up Kit 18-5281



18-5498-2

ELECTRONIC DISTRIBUTOR

Replaces: 9-26307; Mallory YLM624BV
For GM V8, 482, 502, 540 CID (Except 348, 409 & Tall
Deck Big Block) (Reverse Rotation)



18-5339-1

DISTRIBUTOR

Replaces: 9-26103; Mallory YL566AV
For GM V8 327



**18-5475
DISTRIBUTOR**

Fits: 4 Cyl. GM Engines with Delco EST Ignition HEI
Tune-Up Kit 18-5280

18-5309-1

DISTRIBUTOR

Contact Controlled
Replaces: 980902; Mallory YL512CV
For most Ford 302 CID V-8 Eng.
Tune-Up Kit 18-5251



18-5316-1

DISTRIBUTOR

Replaces: Mallory YL624BV
Fits Most GM V8 (Reverse Rotation)



**18-5312-1
DISTRIBUTOR**

Contact Controlled
Replaces: 981080; Mallory YL554CV
For most Ford 351 CID V-8 Eng.
Tune-Up Kit 18-5251



**18-5313-1
DISTRIBUTOR**

Contact Controlled
Replaces: 985560; Mallory YL624MW
For most GM V-8 Engs. (small & large blocks)
Tune-Up Kit 18-5251



**18-5315-1
DISTRIBUTOR**

Contact Controlled
Replaces: Mallory YL673AV
For most GM 4 Cyl. Engines (120 & 140 HP)
Tune-Up Kit 18-5251



**18-26110-1
DISTRIBUTOR**

Replaces: 9-26110; Mallory YL579AV
For Chrysler V8, 273, 318 (1967 & Up), 340 and 360 "LA"
Engines



**18-26104-1
DISTRIBUTOR**

Replaces: 9-26104; Mallory YL567EV
For Ford V8 351C



**18-26112-1
DISTRIBUTOR**

Replaces: 9-26112; Mallory YL676AV
Fits GM L6, 194, 230, 250, 292 CID (Conventional Rotation)

OMC IGNITION APPLICATION CHART

Model	Year Start	Year Stop	Cylinder	Distributor	Contact Set	Condenser	Dist. Cap	Rotor	Tune-Up Kit w/o Cap	Tune-Up Kit w/ Cap	Plug Wire Set
2.3L	1987	1990	4	Mallory	18-5314	18-5338	18-5397	18-5404-1	-	18-5283	18-8807-1
2.3L	1990	1990	4	Prestolite	18-5303	18-5347	-	18-5403	18-5260	-	18-8807-1
2.5L	1981	1986	4	Delco	18-5311	18-5345	18-5385	18-5418	18-5250	18-5268	18-8800-1
3.0L	1982	1990	4	Delco	18-5311	18-5345	18-5385	18-5418	18-5250	18-5268	18-8800-1
3.0L	1990	1998	4	Delco EST	N/A	N/A	18-5361	18-5406	-	18-5280	18-8833-1
3.6L	1981	1985	6	Prestolite	18-5303	18-5347	18-5353	18-5403	18-5262	18-5276	18-8801-1
4.3L	1985	1990	6	Prestolite	18-5303	18-5347	18-5353	18-5403	18-5262	18-5276	18-8801-1
4.3L	1991	1993	6	Prestolite	N/A	N/A	18-5353	18-5403	-	-	18-8801-1
4.3L	1994	1998	6	Delco EST	N/A	N/A	18-53626	18-5408	-	18-5278	18-8835-1
5.0L (GM)	1979	1982	8	Prestolite	18-5303	18-5347	18-5369	18-5407	18-5258	18-5277	18-8802-1
5.0L (GM)	1981	1988	8	Mallory	18-5314	18-5338	18-5376	18-5404-1	18-5251	18-5271	18-8802-1
5.0L (GM)	1983	1988	8	Prestolite	18-5303	18-5347	18-5352	18-5403	18-5262	18-5275	18-8802-1
5.0L (Ford)	1989	1990	8	Prestolite	18-5303	18-5347	18-5352	18-5403	18-5262	18-5275	18-8806-1
5.0L (Ford)	1991	1996	8	Prestolite	N/A	N/A	18-5352	18-5403	-	18-5279	18-8806-1
5.0L (Ford)	1993	1996	8	Ford HEI	N/A	N/A	18-5248	18-5413	-	18-29322	18-8820-1
5.0L (GM)	1998	1998	8	Prestolite	N/A	N/A	18-5352	18-5403	-	18-5279	18-8801-1
5.0L (GM)	1998	1998	8	Delco EST	N/A	N/A	18-5354	18-5405	-	18-5281	18-8822-1
5.7L	1982	1990	8	Mallory	18-5314	18-5338	18-5376	18-5404-1	18-5251	18-5271	18-8802-1
5.7L	1982	1990	8	Prestolite	18-5303	18-5347	18-5352	18-5403	18-5262	18-5275	18-8802-1
5.7L	1991	1998	8	Prestolite	N/A	N/A	18-5352	18-5403	-	18-5279	18-8802-1
5.7L	1996	1998	8	Delco EST	N/A	N/A	18-5354	18-5405	-	18-5281	18-8822-1
5.8L	1989	1990	8	Prestolite	18-5303	18-5347	18-5352	18-5403	18-5262	18-5275	18-8842-1
5.8L	1991	1996	8	Prestolite	N/A	N/A	18-5352	18-5403	-	18-5279	18-8842-1
5.8L	1993	1996	8	Ford HEI	N/A	N/A	18-5248	18-5413	-	18-29322	18-8820-1
7.4L	1988	1988	8	Mallory	18-5314	18-5338	18-5376	18-5404-1	18-5251	18-5271	18-8802-1
7.4L	1988	1988	8	Prestolite	18-5303	18-5347	18-5352	18-5403	18-5262	18-5275	18-8802-1
7.4L	1990	1991	8	Distributor-less	-	-	-	-	-	-	18-8843-1
7.4L	1995	1998	8	Delco EST	N/A	N/A	18-5354	18-5405	-	18-5281	18-8832-1
7.5L	1987	1987	8	Prestolite	18-5303	18-5347	18-5369	18-5407	18-5258	18-5277	18-8803-2
7.5L	1987	1989	8	Prestolite	18-5303	18-5347	18-5352	18-5407	18-5258	18-5277	18-8803-2
8.2L	1984	1985	8	Mallory	18-5314	18-5338	18-5376	18-5404-1	18-5251	18-5271	18-8802-1
8.2L	1984	1985	8	Prestolite	18-5303	18-5347	18-5352	18-5403	18-5262	18-5275	18-8802-1
8.2L	1998	1998	8	Delco EST	N/A	N/A	18-5354	18-5405	-	18-5281	18-8832-1
80	1962	1968	4	ALL	18-5157	18-5200	-	-	18-5001	-	18-8800-1
90	1962	1968	4	ALL	18-5157	18-5200	-	-	18-5001	-	18-8800-1
100	1972	1973	4	Delco	18-5311	18-5345	18-5385	18-5418	18-5250	18-5268	18-8800-1
110	1964	1964	4	Delco	18-5311	18-5345	18-5385	18-5418	18-5250	18-5268	18-8800-1
120	1965	1981	4	Delco	18-5311	18-5345	18-5385	18-5418	18-5250	18-5268	18-8800-1
140	1973	1981	4	Delco	18-5311	18-5345	18-5385	18-5418	18-5250	18-5268	18-8800-1
150	1964	1966	6	Delco	18-5310	18-5345	-	18-5419	-	-	-
155	1967	1972	6	Delco	18-5310	18-5344	-	18-5419	-	-	-
165	1972	1976	6	Delco	18-5311	18-5345	18-5386	18-5418	18-5250	18-5269	-
170	1974	1974	8	Prestolite	18-5303	18-5347	18-5369	18-5407	18-5258	18-5277	18-8802-1
175	1975	1977	8	Prestolite	18-5303	18-5347	18-5369	18-5407	18-5258	18-5277	18-8802-1
185	1967	1968	8	Mallory	18-5314	18-5338	18-5375	18-5411	18-5256	18-5272	18-8802-1
185	1978	1980	8	Mallory	18-5314	18-5338	18-5376	18-5404-1	18-5251	18-5271	18-8802-1
185	1978	1980	8	Prestolite	18-5303	18-5347	18-5369	18-5407	18-5258	18-5277	18-8802-1
190	1974	1977	8	Prestolite	18-5303	18-5347	18-5369	18-5407	18-5258	18-5277	18-8802-1
200	1966	1966	8	Delco	18-5310	18-5345	18-5384	18-5300	-	-	-
200	1967	1968	8	Delco	18-5310	18-5344	18-5384	18-5300	18-5252	-	-
200	1979	1988	8	Mallory	18-5314	18-5338	18-5376	18-5404-1	18-5251	18-5271	18-8802-1
200	1979	1981	8	Prestolite	18-5303	18-5347	18-5369	18-5407	18-5258	18-5277	18-8802-1

① Clip down distributor cap ② Screw down distributor cap

APPLICATION CONTINUED ON NEXT PAGE

OMC IGNITION APPLICATION CHART

Model	Year Start	Year Stop	Cylinder	Distributor	Contact Set	Condenser	Dist. Cap	Rotor	Tune-Up Kit w/o Cap	Tune-Up Kit w/ Cap	Plug Wire Set
210	1968	1970	8	Mallory	18-5314	18-5338	18-5375	18-5411	18-5256	18-5272	18-8802-1
215	1971	1971	8	Mallory	18-5314	18-5338	18-5375	18-5411	18-5256	18-5272	18-8802-1
225	1972	1976	8	Mallory	18-5314	18-5338	18-5375	18-5411	18-5256	18-5272	18-8802-1
225	1978	1978	8	Mallory	18-5314	18-5338	18-5376	18-5404-1	-	18-5271	18-8802-1
230	1979	1981	8	Mallory	18-5314	18-5338	18-5376	18-5404-1	18-5251	18-5271	18-8802-1
230	1979	1981	8	Prestolite Ⓞ	18-5303	18-5347	18-5369	18-5407	18-5258	18-5277	18-8802-1
230	1975	1976	8	Mallory	18-5314	18-5338	18-5375	18-5411	18-5256	18-5272	18-8802-1
235	1971	1971	8	Mallory	18-5314	18-5338	18-5375	18-5411	18-5256	18-5272	18-8802-1
235	1975	1977	8	Prestolite Ⓞ	18-5303	18-5347	18-5369	18-5407	18-5258	18-5277	18-8802-1
240	1978	1978	8	Prestolite Ⓞ	18-5303	18-5347	18-5369	18-5407	18-5258	18-5277	18-8802-1
245	1975	1975	8	Mallory	18-5314	18-5338	18-5375	18-5411	18-5256	18-5272	18-8802-1
250	1970	1974	8	Mallory	18-5314	18-5338	18-5375	18-5411	18-5256	18-5272	18-8802-1
250	1979	1979	8	Prestolite Ⓞ	18-5303	18-5347	18-5369	18-5407	18-5258	18-5277	18-8802-1
260	1975	1976	8	Mallory	18-5314	18-5338	18-5375	18-5411	18-5256	18-5272	18-8802-1
260	1979	1981	8	Mallory	18-5314	18-5338	18-5376	18-5404-1	18-5251	18-5271	18-8802-1
260	1979	1981	8	Prestolite Ⓞ	18-5303	18-5347	18-5369	18-5407	18-5258	18-5277	18-8802-1
290 JET	1974	1975	8	Mallory	18-5314	18-5338	18-5375	18-5411	18-5256	18-5272	18-8802-1
305	1977	1979	8	Mallory	18-5314	18-5338	18-5375	18-5411	18-5256	18-5272	18-8802-1
305	1980	1981	8	Mallory	18-5314	18-5338	18-5376	18-5404-1	18-5251	18-5271	18-8802-1
305	1981	1981	8	Prestolite Ⓞ	18-5303	18-5347	18-5369	18-5407	18-5258	18-5277	18-8802-1
350	1977	1979	8	Mallory	18-5314	18-5338	18-5375	18-5411	18-5256	18-5272	18-8802-1
350	1980	1981	8	Mallory	18-5314	18-5338	18-5376	18-5404-1	18-5251	18-5271	18-8802-1
350	1981	1981	8	Prestolite Ⓞ	18-5303	18-5347	18-5369	18-5407	18-5258	18-5277	18-8802-1
454	1977	1979	8	Mallory	18-5314	18-5338	18-5375	18-5411	18-5256	18-5272	18-8803-2
454	1980	1981	8	Mallory	18-5314	18-5338	18-5376	18-5404-1	18-5251	18-5271	18-8803-2
454	1981	1981	8	Prestolite Ⓞ	18-5303	18-5347	18-5369	18-5407	18-5258	18-5277	18-8803-2

Ⓞ Clip down distributor cap Ⓢ Screw down distributor cap

 <p>MP28890 IGNITION LANAYARD Replaces: 176288 Fits: 1996 - Up</p>	 <p>MP28880 LANAYARD Replaces: 432230 Fits: 1995-Older</p>	 <p>18-5225 SPARK PLUG WIRE KIT Kit Includes 25 Ft. Roll of 7 MM Hypalon Ignition Wire With a Metallic Core and a Large Assortment of Three Different End Fittings.</p>	 <p>18-5222 IGNITION WIRE Silicone Core 100' Spool 8mm</p>
 <p>18-5226 IGNITION WIRE Metallic Core 100' Spool 7mm Hypalon</p>	<p>PKG. OF 10</p>  <p>18-5224 18-5224-9Ⓢ SPARK PLUG WIRE TERMINAL Replaces: Mercury 20121 OMC 510364</p>	<p>PKG. OF 10</p>  <p>18-5750 18-5750-9Ⓢ UNIVERSAL SPARK PLUG BOOT Supplied complete w/Terminal Connector Replaces: OMC 581027, 580339</p>	 <p>18-5752 UNIVERSAL SPARK PLUG BOOT 8mm</p>

Ⓢ Priced per Package

PREMIUM MARINE IGNITION WIRES

Sierra's MAGFORCE Ignition Wires are "Electronics Friendly" protecting all of your electronic devices and electronic engine controls from RFI and EMI while delivering the maximum amount of voltage. Exact fit design ensures easy installation and years of trouble - free service.



APPLICATION CONTINUED ON NEXT PAGE

OMC MARINE IGNITION WIRES APPLICATION

Model	Cyl.	Distributor	Year Start	Year End	Plug Wire Set
2.3L	4	Mallory	1987	1990	18-8807-1
2.3L	4	Prestolite	1990	1990	18-8807-1
2.5L	4	Delco	1981	1986	18-8800-1
3.0L	4	Delco	1982	1990	18-8800-1
3.0L	4	Delco EST	1990	1998	18-8833-1
3.8L	6	Prestolite	1981	1985	18-8801-1
4.3L	6	Prestolite	1985	1990	18-8801-1
4.3L	6	Prestolite	1991	1993	18-8801-1
4.3L	6	Delco EST	1994	1998	18-8835-1
5.0L (GM)	8	Prestolite	1979	1982	18-8802-1
5.0L (GM)	8	Mallory	1981	1988	18-8802-1
5.0L (GM)	8	Prestolite	1983	1988	18-8802-1
5.0L (Ford)	8	Prestolite	1989	1990	18-8806-1
5.0L (Ford)	8	Prestolite	1991	1996	18-8806-1
5.0L (Ford)	8	Ford HEI	1993	1996	18-8820-1
5.0L (GM)	8	Prestolite	1998	1998	18-8801-1
5.0L (GM)	8	Delco EST	1998	1998	18-8822-1
5.7L	8	Mallory	1982	1990	18-8802-1
5.7L	8	Prestolite	1982	1990	18-8802-1
5.7L	8	Prestolite	1991	1998	18-8802-1
5.7L	8	Delco EST	1996	1998	18-8822-1
5.8L	8	Prestolite	1989	1990	18-8842-1
5.8L	8	Prestolite	1991	1996	18-8842-1
5.8L	8	Ford HEI	1993	1996	18-8820-1
7.4L	8	Mallory	1988	1988	18-8802-1
7.4L	8	Prestolite	1988	1988	18-8802-1
7.4L	8	Distributorless	1990	1991	18-8843-1
7.4L	8	Delco EST	1995	1998	18-8832-1
7.5L	8	Prestolite	1987	1987	18-8803-2
7.5L	8	Prestolite	1987	1989	18-8803-2
8.2L	8	Mallory	1984	1985	18-8802-1
8.2L	8	Prestolite	1984	1985	18-8802-1
8.2L	8	Delco EST	1998	1998	18-8832-1

OMC MARINE IGNITION WIRES APPLICATION

Model	Cyl.	Distributor	Year Start	Year End	Plug Wire Set
80	4	ALL	1962	1968	18-8800-1
90	4	ALL	1962	1968	18-8800-1
100	4	Delco	1972	1973	18-8800-1
110	4	Delco	1964	1964	18-8800-1
120	4	Delco	1965	1981	18-8800-1
140	4	Delco	1973	1981	18-8800-1
170	8	Prestolite	1974	1974	18-8802-1
175	8	Prestolite	1975	1977	18-8802-1
185	8	Mallory	1967	1968	18-8802-1
185	8	Mallory	1978	1980	18-8802-1
185	8	Prestolite	1978	1980	18-8802-1
190	8	Prestolite	1974	1977	18-8802-1
200	8	Mallory	1979	1988	18-8802-1
200	8	Prestolite	1979	1981	18-8802-1
210	8	Mallory	1968	1970	18-8802-1
215	8	Mallory	1971	1971	18-8802-1
225	8	Mallory	1972	1976	18-8802-1
225	8	Mallory	1978	1978	18-8802-1
230	8	Mallory	1979	1981	18-8802-1
230	8	Prestolite	1979	1981	18-8802-1
230	8	Mallory	1975	1976	18-8802-1
235	8	Mallory	1971	1971	18-8802-1
235	8	Prestolite	1975	1977	18-8802-1
240	8	Prestolite	1978	1978	18-8802-1
245	8	Mallory	1975	1975	18-8802-1
250	8	Mallory	1970	1974	18-8802-1
250	8	Prestolite	1979	1979	18-8802-1
260	8	Mallory	1975	1976	18-8802-1
260	8	Mallory	1979	1981	18-8802-1
260	8	Prestolite	1979	1981	18-8802-1
290 JET	8	Mallory	1974	1975	18-8802-1
305	8	Mallory	1977	1979	18-8802-1

① Clip down cap ② Snap down cap

OMC MARINE IGNITION WIRES APPLICATION						OMC MARINE IGNITION WIRES APPLICATION					
Model	Cyl.	Distributor	Year Start	Year End	Plug Wire Set	Model	Cyl.	Distributor	Year Start	Year End	Plug Wire Set
305	8	Mallory	1980	1981	18-8802-1	350	8	Prestolite ⓐ	1981	1981	18-8802-1
305	8	Prestolite ⓐ	1981	1981	18-8802-1	454	8	Mallory	1977	1979	18-8803-2
350	8	Mallory	1977	1979	18-8802-1	454	8	Mallory	1980	1981	18-8803-2
350	8	Mallory	1980	1981	18-8802-1	454	8	Prestolite ⓐ	1981	1981	18-8803-2

ⓐ Clip down cap ⓑ Snap down cap



**18-5920
STARTER, PMGR, FORD**
PMGR Replacement for 18-5903; 302CID,
351CID Ford Engines
Clockwise/Standard Rotation



**18-5927
STARTER, PMGR, FORD**
PMGR Replacement for 18-5917,
2.3L Ford Starter.



**18-6270
PERMANENT MAGNET I/O STARTER**
Replaces: 988013, 984536
• Permanent Magnet
• Heavy Duty
• 12 Volt
• 2 Bolt Mount
• 1 Threaded Hole
• CW Rotation
• SAE J1171
For: 460 Ford, OMC King Cobra



**18-5919-1
STARTER**
Permanent magnet
I/O starter
For: Late model GM -
12 1/4" flywheel
Replaces: 988217
SAEJ1171
1.7 KW



**18-5920
STARTER**
Permanent Magnet
For: 5.0 & 5.8 litre Ford engines.
Clockwise/Standard Rotation
Replaces: 987811, 3854190
Replacement Solenoid: 18-6291

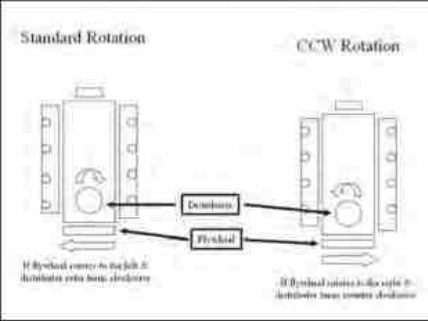

**18-6276
STARTER**
Replaces: 984536, 988013
• 12 Volt
• CW Rotation
• Threaded Top Hole in Housing
• 460 Ford, OMC King Cobra

**18-5911
STARTER**
(Heavy-Duty) (No Core)
For GM engines, bottom mount straight across bolt pattern.
Standard rotation clockwise. 100-245 HP — 1970-1978 (GM)
Replaces: 981078, 982121, 983444, 983790, 985966
Replacement Solenoid: 18-5837
SAEJ1171



**18-5907
STARTER**
(Heavy-Duty) (No Core)
Top mount front entry starter for standard rotation
GM and Ford engines.
Replaces: 981289, 982202
Replacement Solenoid: 18-5837
SAEJ1171





**18-5908
STARTER**
(Heavy-Duty) (No Core)
Top mount front entry starter for reverse rotation
GM and Ford engines. Counter-clockwise.
Replaces: 981288, 982195, 984982, 986007
Replacement Solenoid: 18-5837
SAEJ1171



**18-5910
STARTER**
(Heavy-Duty) (No Core)
Small block GM V-6 & V-8 Engine with 14 1/4" flywheel and bottom mount,
offset bolt pattern. For standard rotation engines. Clockwise. 1985-1992 - V-6,
V-8 (GM) and 1990-1993 OMC King Cobra
Replaces: 984456, 986505
Replacement Solenoid: 18-5837
SAEJ1171



**18-5917
STARTER**
Replaces: 984628
3 bolt mount - Late style 4" diameter case.
Standard rotation engines
For: Late model Ford V-8.
Replacement Solenoid: 18-5801



**18-5903
STARTER**
(No Core) (Clockwise)
Bottom mount, two bolt pattern for standard
rotation. Ford engines. Clockwise.
Non-threaded top mounting hole. For threaded
top, order 18-6276.
Replaces: 980803, 981821
Replacement Solenoid: 18-5801



**18-5913-1
STARTER**
(Clockwise)
Delco permanent magnet gear reduction 2 bolt
starter 12V - 11 Tooth - Offset bolt pattern. Fits:
Chevy Engines with 14" flywheels. 1.7 KW
Replaces: 3854751 SAEJ1171



OMC STERNDRIVE/OMC COBRA STARTERS

ENGINE	YEAR	STARTER #	ENGINE	YEAR	STARTER #	ENGINE	YEAR	STARTER #
3.0L	1982-92	18-5911	165	1972-76	18-5911	245 JET	1972-74	18-5911
5.0L	1982-86	18-5911 ①	170	1974	18-5903	250	1979	18-5903
5.0L	1986-88	18-5910 ①	175	1975-77	18-5903	260	1975-76	18-5908 ①
2.5L	1982-86	18-5911	185	1967-68, 1978-80	18-5911	260	1975-76	18-5907 ②
3.8L	1981-86	18-5911	190	1974-77	18-5903	280	1979-81	18-5911
4.3L	1985-86	18-5911	200	1966-68, 1979-81	18-5911	282 CID	1989	18-5910
4.3L	1986-92	18-5910	210	1968-72	18-5911 ①	290	1975	18-5908 ③
5.7L	1982-86	18-5911	215	1971	18-5911	305 CID	1977-80,82	18-5908 ①
5.7L	1986-92	18-5910	225	1972-76, 1978	18-5911 ①	305 CID	1977-80,82	18-5907 ②
100	1972-73	18-5911	230	1975-76	18-5908 ①	350 CID	1977-80,82	18-5908 ①
110	1964	18-5911	230	1975-76	18-5907 ②	350 CID	1977-80,82	18-5907 ②
120	1965-81	18-5911	230	1979-81	18-5911	350 CID	1988-91	18-5910
140	1973-81	18-5911	235	1971	18-5911	370 CID	1988	18-5908
140 JET	1973	18-5911	235	1975-77	18-5903	454 CID	1977-80,82	18-5908 ①
150	1964-66	18-5911	240	1978	18-5903	454 CID	1977-80,82	18-5907 ②
155	1967-72	18-5911	245	1972-75	18-5911	454 CID	1990-92	18-5910
						502 CID	1992	18-5910

① Standard rotation engines.
② Opposite (Reverse) rotation engines.

③ Engines with model number suffix "R2" or "R3"
④ '86 Model engines with model number suffix "WB"

⑤ '86 Model engines with model number suffix "XS"



**18-5717
STARTER BRUSH SET**
Replaces: Delco 1984462



**18-8412
STARTER STUD EXTENDER**
Extends the solenoid stud on PMGR starters for applications that require more accessory wire connections.
Threads: Female M8x1.25, Male 3/8"x16 UNC



**18-5811
STARTER SOLENOID**
Replaces: 3850216
For: PG 260 series starters, GM V6 & V8 (1983-Up)



**18-5801
SOLENOID**
Replaces: 985064, 586842, 586730
Grounded Base

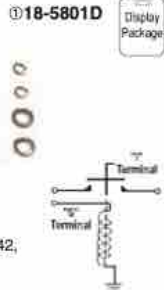

**18-5803
SOLENOID**
Replaces: 979774

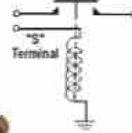

**18-5807
SOLENOID**
Replaces: 378444
Prestolite SAW4206

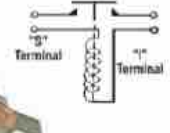

**18-6291
SOLENOID**
Replaces: 3854194 and Volvo Penta 3854194-2
Fits: Ford Gear Reduction Starters on Late Model 5.0L, 5.8L, OMC and Volvo Penta



**18-5814
SOLENOID**
Replaces: 172869, 581528
12 Volt, Isolated Base



**18-5808
SOLENOID**
Replaces: 395419, 582708

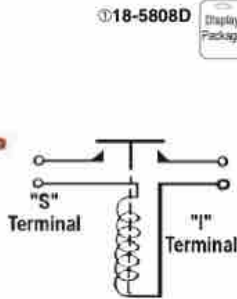

**18-5812
SOLENOID**
Replaces: 985063

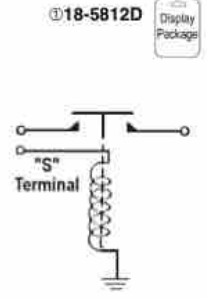

**18-5837
SOLENOID**
Replaces: 985799, 986620
Delco 1114531

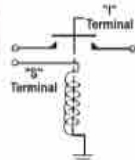

**18-5838
SOLENOID**
Replaces:
Delco 1114356, 1114458

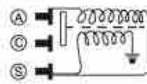

BATTERY CABLES
Gauge cable with soldered lug terminals on each end to accept a 3/8" stud

Part No.	Size	Color	Gauge	Part No.	Size	Color	Gauge
BC88523	2'	red	4	BC88563	6'	red	2
BC88533	2'	black	4	BC88573	6'	black	2
BC88543	4'	red	2	BC88583	8'	red	1
BC88553	4'	black	2	BC88593	8'	black	1

① Items ending in "D" are Display Packaged - Regular number is Non-Display

STRINGER SOLENOID APPLICATION

HP	Year	Starter Brush	Starter Mounted Solenoid	Starter Solenoid	Tilt Solenoid	Trim Solenoid
.80	1969	—	N/A	18-5806	N/A	18-5806
.88	1964	—	N/A	18-5807	N/A	18-5807
.90	1965-71	—	N/A	18-5806	N/A	18-5806
1.00	1972-73	18-5717	18-5838	18-5803	N/A	18-5803
1.10	1964	18-5717	18-5838	18-5807	N/A	18-5807
1.20	1965-71	18-5717	18-5838	18-5806	N/A	18-5806
1.20	1972-77	18-5717	18-5838	18-5803	18-5803	18-5803
1.20	1978-81	18-5717	18-5838	—	—	—
1.40	1973-77	18-5717	18-5838	18-5803	18-5803	18-5803
1.40	1978-81	18-5717	18-5838	—	—	—
1.45 ①	1973	—	18-5838	18-5803	N/A	N/A
1.50	1964	18-5717	18-5838	18-5807	N/A	18-5807
1.50	1965-86	18-5717	18-5838	18-5806	N/A	18-5806
1.55	1967-72	18-5717	18-5838	18-5806	N/A	18-5806
1.65	1972-76	18-5717	18-5838	18-5803	18-5803	18-5803
1.70	1974	—	N/A	18-5801	N/A	18-5803
1.75	1975-78	—	N/A	18-5801	N/A	18-5803
1.85	1967-68	18-5717	18-5838	18-5806	N/A	18-5806
1.85	1978-80	18-5717	18-5838	—	—	—
1.90	1974-76	—	N/A	18-5801	N/A	18-5803
2.00	1966-78	18-5717	18-5838	18-5806	N/A	18-5806
2.00	1979-81	—	18-5838	—	—	—
2.10	1968-70	18-5717	18-5838	18-5806	N/A	18-5806
2.10 ②	1970-72	18-5717	18-5838	18-5806	N/A	N/A
2.15	1971	18-5717	18-5838	18-5806	N/A	18-5806
2.25	1972	18-5717	18-5838	18-5806	N/A	18-5806
2.25	1973	18-5717	18-5838	18-5803	N/A	18-5806
2.25	1974-76	18-5717	18-5838	18-5803	N/A	18-5803
2.28	1978	18-5717	18-5838	—	—	—
2.25 ②	1973-74	18-5717	18-5838	18-5806	N/A	N/A
2.30 ①	1975-76	18-5717	18-5838	18-5803	N/A	N/A
2.30	1979-81	18-5717	18-5838	—	—	—
2.35	1971	18-5717	18-5838	18-5806	N/A	18-5806
2.35	1975-78	—	N/A	18-5801	N/A	18-5803
2.45	1972	18-5717	18-5838	18-5806	N/A	18-5806
2.45	1973	18-5717	18-5838	18-5803	N/A	18-5806
2.45	1974-75	18-5717	18-5838	18-5803	N/A	18-5803
2.45 ①	1972-75	18-5717	18-5838	18-5806	N/A	N/A
2.50 ②	1970-74	—	18-5838	18-5806	N/A	N/A
2.60 ②	1975-76	18-5717	18-5838	18-5803	N/A	N/A
2.60	1979-81	18-5717	18-5838	—	—	—
2.90 ①	1974-75	18-5717	18-5838	18-5806	N/A	N/A
3.05 ②	1977-82	18-5717	18-5838	—	N/A	N/A
3.50 ②	1977-82	18-5717	18-5838	—	N/A	N/A
4.54 ②	1977-82	18-5717	18-5838	—	N/A	N/A
2.5	1982	18-5717	18-5838	—	—	—
2.5	1983-86	18-5717	18-5837	—	—	—
3	1982	18-5717	18-5838	—	—	—
3	1983-86	18-5717	18-5837	—	—	—
3.8	1981-82	18-5717	18-5838	—	N/A	—
3.8	1983-86	18-5717	18-5837	—	N/A	—
4.3	1985-86	18-5717	18-5837	—	N/A	—
5	1982	18-5717	18-5838	—	—	—
5	1983-86	18-5717	18-5837	—	—	—
5.7	1982	18-5717	18-5838	—	—	—
5.7	1983-86	18-5717	18-5837	—	—	—

① Jet Drive

② Inboard

OMC COBRA SOLENOID APPLICATION

HP	Year	Starter Brush	Starter Mounted Solenoid	Starter Solenoid	Trim Solenoid
262	1989	N/A	18-5837	18-5812	N/A
350	1988	N/A	18-5837	18-5812	18-5812
350	1989	N/A	18-5837	18-5812	N/A
350	1990-91	N/A	18-5837	18-5801	N/A
351	1992	—	—	18-5801	N/A
370	1988	N/A	—	18-5812	18-5812
370	1989	N/A	—	18-5812	N/A
454	1990	—	—	18-5801	N/A
454	1991-92	N/A	18-5837	18-5801	N/A
460	1989-90	N/A	—	18-5801	N/A
502	1992	N/A	18-5837	18-5801	N/A
2.3	1987-88	N/A	—	18-5801	18-5812
2.3	1989-90	N/A	—	18-5801	N/A
2.5	1988	18-5717	18-5837	18-5812	18-5812
3	1988-88	18-5717	18-5837	18-5812	18-5812
3	1989-90	18-5717	18-5837	18-5812	N/A
3	1991-92	18-5717	18-5837	18-5801	N/A
4.3	1988-88	18-5717	18-5837	18-5812	18-5812
4.3 I	1989-90	18-5717	18-5837	18-5812	N/A
4.3 II	1990-92	18-5717	18-5837	18-5801	N/A
5	1988-88	18-5717	18-5837	18-5812	18-5812
5	1989-92	18-5717	—	18-5801	N/A
5.7	1988-88	18-5717	18-5837	18-5812	18-5812
5.7	1989	18-5717	18-5837	18-5812	N/A
5.7	1990-92	18-5717	18-5837	18-5801	N/A
5.8	1989-92	N/A	—	18-5801	N/A
7.5	1987	18-5717	—	18-5801	18-5812

① 1990 Models with 2 barrel carbs

② 1990 Models with 4 barrel carbs.

**18-5711
VOLTAGE REGULATOR**
Replaces: 383440
Prestolite: VSH-6201 AFY
12 Volt



Years	Model	Alternator or Generator
1964-66	110, 150 HP	ALK-6222, A, AYS
1967-81	80, 90, 120, 140, 155, 165, 175, 185, 190, 200, 210, 225, 230, 235, 250, 260 HP & 305, 350, 454 CID	ALK-6222, A, AY, Y, AYE ANK-65201S, Y ALK-6210, A

**18-6261
ALTERNATOR**
Replaces: 987774, 3857561, 3854182, 3854809, 3856600, 3860171
Fits: 3.0L, 4.3L, 5.7L, 7.4L (1995-98), 5.0L, 5.8L, 8.2L (1993-98)
For: Delco



**18-6260
ALTERNATOR**
OMC Cobra 12 Volt, 51 Amp, Internal Regulator, Negative Ground, Single Groove Pulley
For: Prestolite/Motorola



**18-6841
ALTERNATOR**
Replaces: 983424, 836, 247
For: 37-63A Marine Applications



**18-5957
ALTERNATOR**
Replaces: 982364
(3-Wire) (68 AMP)
Replaces Mando, Motorola and original equipment Delco. Uses same electrical connections and mounting method. Equipped with fan and drive pulley.
SAEJ1171





18-2192
ELECTRIC SHIFT CABLE
Replaces: 379628

ELECTRIC SHIFT CABLE APPLICATION

Year	HP
1964	110 ②, 150
1965	120 ②, 150
1966	120 ①, 150, 200
1967	120 ①, 155, 185, 200
1968	120, 155, 185, 200, 210
1969-70	120, 155, 210
1971	120, 155, 215, 235
1972-73	100, 120, 155, 165, 225, 245
1974	120, 140, 165, 170, 190, 225, 245
1975	120, 140, 165, 175, 190, 225, 235, 245
1976	120, 140, 165, 175, 190, 225, 235
1977	120, 140, 175, 190, 235

① Heavy Duty ② SU12M, SUE 12M

③ 18-5705D



18-5705
POWER TRIM/FUEL PUMP RELAY

Replaces: 582472, 584416, 586224

5 Terminal
Single Pull - Double Throw - 12 Volt
Open Contact: 40 Amps Resistive, 30 Amps Conductive
Closed Contact: 20 Amps Resistive, 15 Amps Conductive



18-6257
TILT/TRIM MOTOR
Replaces: 983195, 982957
1982-85 Models with hydraulic engine lifts for pump assembly



18-6754
TILT MOTOR
Replaces: 382138
Prestolite ETK 4102, ETK 4001, ETK 4101
(All Models 1963-77)



18-6755
TILT MOTOR
Replaces: 982706, 982058
Prestolite EVD 4001, EVD 4002
(All Models Except 2.5L, 3.0L - 1978-85)



18-6764
TILT/TRIM MOTOR
Replaces: 982073, 983318, 982069
For: OMC Stinger and Cobra
Select Trim 3-Wire Connection
1979-85 Stern Drive (2.5L & 3.0L)



18-6779
TRIM MOTOR
Replaces: 986280, 3853945
For: 1990 & 1994 King Cobra Trim System



18-6814
TRIM MOTOR
Replaces: 984356
OMC Cobra



18-6823
WIRING HARNESS
Replaces: Universal
Converts 3-wire Tilt and Trim motors to 2-Wire design



18-6950
18-6950-9 ①
POWER TILT FUSE
(50 amp)
Replaces: 982019



18-9802
TIMING LIGHT
Self-powered accurate up to 10,000 RPM's



18-7601
AIR CHARGE TEMPERATURE SENSOR
Replaces: 3854158
8 cyl
5.0L, 5.8 L, EFI (1994-96)



18-7684
MAP SENSOR
Replaces: 3850396
For: 4.3L TBI(1996-98), 5.0L TBI(1998), 5.7L TBI(1996-98), 7.4L(1995-98), 8.2L(1998)



18-7677
KNOCK SENSOR
Replaces: 3850357



18-7679
KNOCK SENSOR
Replaces: 3854905



18-7703
KNOCK SENSOR
Replaces: 3854512



18-7689
FUEL INJECTOR
Replaces: 3855182

① Items ending in "D" are Display Packaged - Regular number is Non-Display

ALL SIERRA CARBURETORS INCLUDE BASE GASKET

- Precision remanufactured to meet or exceed OEM specifications
- Re-calibrated and re-engineered to maximize fuel efficiency and performance
- All carburetors are flow tested throughout the entire throttle range
- Fuel mixture and idle settings are pre-set to ensure that only minor idle and choke adjustments are necessary during installation
- All bases are resurfaced and throttle shaft bushings replaced



**18-7635
CARBURETOR
(REMANUFACTURED)**
300 CFM Holley 2V
Use replacement gasket **18-0360**



**18-7636
CARBURETOR
(REMANUFACTURED)**
500 CFM Holley 2V
Use replacement gasket **18-0994**



**18-7637
CARBURETOR
(REMANUFACTURED)**
600 CFM Holley 4V
(Includes gasket)



**18-7638
CARBURETOR
(REMANUFACTURED)**
600 CFM Holley 4V-side inlet



**18-7640
CARBURETOR
(REMANUFACTURED)**
Universal Q-jet with electric choke
Use replacement gasket **18-0462**



**18-7605-1
CARBURETOR**
4 Barrel Rochester
Replaces: 382821, 383766, 384194
Remanufactured
Use replacement gasket **18-2948**
Use Carb Replacement Kit **18-7095**



**18-7608-1
CARBURETOR**
2 Barrel Rochester
Replaces: 381668, 980528, 982219, 982217
Remanufactured
Use replacement gasket **18-0356**
Use Carb Replacement Kit **18-7070**



**18-7609-1
CARBURETOR**
2 Barrel Rochester
Replaces: 382733, 980530, 982217, 984180, 381494, 772831
Remanufactured
Use replacement gasket **18-0356**
Use Carb Replacement Kit **18-7070**



**18-7615-1
CARBURETOR**
4 Barrel Rochester
Replaces: 981705, 982223, 983855, 981359, 981564, 985822, 981803, 981428
Remanufactured
Use replacement gasket **18-2948**
Use Carb Replacement Kit **18-7095**



**18-7615N
Q-JET CARBURETOR**
Replaces: 1347-816373A4, 1347-804624R1, 1347-804624R02
(Includes gasket)
Use Carb Replacement Kit **18-7095**



OMC STERN DRIVE CARBURETOR APPLICATION

Model	Year	OMC Carburetor #	MFG Carburetor #	Carb Code & Model	Part #
80	1968-69	382733, 772831	7028085, 17059053, 17089064, 17087311	R2, 2GC	18-7609-1
90	1970-71	382733, 772831	7028085, 17059053, 17089064, 17087311	R2, 2GC	18-7609-1
120 (400 Series)	1972-86	381668, 980528, 982210	7044186, 17059066	R2, 2GC	18-7608-1
140 (400 Series)	1973-85	979821, 980530, 982217, 984180	17086107	R2, 2GC	18-7608-1
155	1967-72	772831	7026180	R2, 2GC	18-7609-1
165	1972-76	979821, 980530	17086107	R2, 2GC	18-7609-1
185	1989	984180	17086064	R2, 2GC	18-7609-1
200	1966-68	381494	7026187	R2, 2GC	18-7609-1
210	1968-72	382921, 383766	7028282, 7028290	R4, 4MV	18-7605-1
215, 225, 230	1971-76	382821	7028280	R4, 4MV	18-7605-1
230 (800 Series)	1978-89	981705, 982223	17057290, 17059285, 17059286, 17086117	R4, 4MV	18-7615-1
245	1972-75	384194	7040284	R4, 4MV	18-7605-1
250	1970-74	384194	7040284	R4, 4MV	18-7605-1
260 (900 Series)	1975-76	384194	7040284	R4, 4MV	18-7605-1
260 (900 Series)	1978-89	982223	17057290, 17059285, 17059286, 17086117	R4, 4MV	18-7615-1
2.5L, 3.0L	1962-86	982219, 982217	17059056, 17059053	R2, 2GC	18-7608-1
3.0L	1967-90	984180	17086064	R2, 2GC	18-7608-1
3.8L (4V)	1979-85	983855	17082515, 17085010	R4, 4MV	18-7615-1
4.3L (4V)	1979-89	983855	17082515, 17085010	R4, 4MV	18-7615-1
5.0L (GM)(4V)	1979-89	982223	17057290, 17059285, 17059286, 17086117	R4, 4MV	18-7615-1
5.7L (4V)	1979-89	982223	17057290, 17059285, 17059286, 17086117	R4, 4MV	18-7615-1
305, 360 CI, I/B	1977-83	981359, 982215, 981564, 982223	17057290, 17059285, 17059286, 17086117	R4, 4MV	18-7615-1
350 (4V)	1988-89	985822	17057290, 17059285, 17059286, 17086117	R4, 4MV	18-7615-1
454 CI, I/B	1977-78	981803, 981428	17057290, 17059285, 17059286, 17086117	R4, 4MV	18-7615-1

**18-7017
CARB KIT**

Replaces: 985052

235 (5.8L Ford) 1989 7.5L/460 C.I. 1987-89
(Contains Non-adjustable needles and seats)



**18-7070
CARB KIT**

Replaces: 383615, 982384



**18-7071
CARB KIT**

Replaces: 380186



**18-7072
CARB KIT**

Replaces: 979659, 384743



**18-7080
CARB KIT**

Replaces: 979719



**18-7081
CARB KIT**

Replaces: 982537, 982538

(Contains adjustable needles and seats)



**18-7086
CARB KIT**

Replaces: 984487



**18-7095
CARB KIT**

Replaces: 983864, 383918





18-7096
CARB KIT
 Replaces: 982539, 85R-4541
 (Contains adjustable needles and seats)



18-7235
CARB KIT
 Replaces: 986783



18-7236
CARB KIT
 Replaces: 986782



18-7237
CARB KIT
 Replaces: 986784, 986799



18-7238
CARB KIT
 Replaces: 986796



18-7239
CARB KIT
 Replaces: 986800



18-7241
CARB KIT
 Replaces: 986804



18-7242
CARB KIT
 Replaces: 987313



18-7243
CARB KIT
 Replaces: 987315



18-7244
CARB KIT
 Replaces: 987317



18-7245
CARB KIT
 Replaces: 987319



18-7246
CARB KIT
 Replaces: 987438, 987440, 987485



18-7727
CARB KIT



18-7729
CARB KIT



18-7730
CARB KIT

APPLICATION BEGINS ON NEXT PAGE



**18-7200
FLOAT**
(Alcohol Resistant)
Replaces: 381369
Plastic



**18-7201
FLOAT**
(Alcohol Resistant)
Replaces: 383087, 983871
Brass



**18-7206
NITROPHYL FLOAT**
Nitrophenyl

CARBURETOR KIT/FLOAT APPLICATION

Model	Years	Mfg. Code	Carb. Model	Carb Kit	Float
80	1968-69	R2	2GC	18-7070	18-7200
90	1970-71	R2	2GC	18-7070	18-7200
100	1972-73	C1	RBS	18-7080	—
110	1964	R1	BC	18-7071	—
120	1965-71 (Dual Carb)	C1	RBS	18-7080	—
120	1972-85	R2	2GC	18-7070	18-7200
140	1973-85	R2	2GC	18-7070	18-7200
150	1964-65	R1	BC	18-7071	—
150	1965-66	C1	RBC	18-7080	—
155	1967-72	R2	2GC	18-7070	—
165	1972-76	R2	2GC	18-7070	18-7200
170	1974	H2	2300	18-7081	18-7206
175	1975-77	H2	2300	18-7081	18-7206
185	1978-81	R2	2GE	18-7086	18-7200
185	1989	H2	2300	18-7081	18-7206
190	1974-77	H2	2300	18-7081	18-7206
200	1968-68	R2	2GC,V	18-7070	—
200	1978-85	R2	2GE	18-7086	18-7200
200	1989	H2	2300	18-7081	18-7206
210	1968-72	R4	4MV	18-7072	18-7201
215	1971	R4	4MV	18-7072	18-7201
225	1972-76	R4	4MV	18-7072	18-7201
230	1975-76	R4	4MV	18-7072	18-7201
230	1978-89	R4	4MV	18-7095	18-7201
235	1975-77	H4	4160	18-7086	18-7206
235	1989	H4	4160	18-7017	—
240	1978	H4	4160	18-7017	—
245	1972-75	R4	4MV	18-7072	18-7201
250	1970-74	R4	4MV	18-7072	18-7201
250	1979	H4	4160	18-7017	—
260	1975-76	R4	4MV	18-7072	18-7201
260	1978-89	R4	4MV	18-7095	18-7201
290 JET	1974-75	R4	4MV	18-7072	18-7201
2.3L	1967-89	R2	2GE	18-7086	18-7200
2.5L	1982-85	R2	2GC	18-7070	18-7200
2.5L	1986-90	R2	2GE	18-7086	18-7200
2.5L	1986	R2	2GC	18-7070	18-7200
3.0L ②	1982-90	R2	2GC	18-7070	18-7200
3.0L/3.0L H.O.	1991-92	H-2	2300	18-7246	—
3.8L	1978-85	R2	2GE	18-7086	18-7200
4.3L	1968-89	R2	2GE	18-7086	18-7200
4.3L	1978-89	R4	4MV	18-7095	18-7201
4.3/4.3 H.O. ③	1990-92	H2	2300	18-7238	—
4.3/4.3 H.O. ③	1990-92	H4	4160	18-7237	—
4.3/262 ④	1989	R2	2GE	18-7086	18-7200
5.0L (GM)	1978-85	R2	2GE	18-7086	18-7200
5.0L (GM)	1978-89	R4	4MV	18-7095	18-7201

② For 2V Carburetors
 ③ For 4V Carburetors
 ④ For Engine Model 574APEWS

⑤ For 1990 PWC Suffix Only
 ⑥ For Engine Model 574APERGD

⑦ For Engine Model 744DPEAMH, 744DPPAMH
 ⑧ For Engine Model 744CPEAMH, 824BPEAM

CARBURETOR KIT/FLOAT APPLICATION

Model	Years	Mfg. Code	Carb. Model	Carb Kit	Float
5.0L (FORD)	1989	H2	2300	18-7081	18-7206
5.0 5.0 H.O. ②	1989-90	H4	4160	18-7237	—
5.0 5.0 H.O. ③	1989-90	H2	2300	18-7236	—
5.0 5.0 H.O. ④	1991	H4	4160	18-7245	—
5.0 5.0 H.O. ③	1991	H4	4175	18-7244	—
5.0 5.0 H.O. ②	1992	H4	4150	18-7242	—
5.7L	1979-89	R4	4MV	18-7095	18-7201
5.7	1990-92	H4	4175	18-7239	—
5.7 LE ②	1991-92	H4	4175	18-7243	—
5.7 LE ③	1990	H4	4175	18-7239	—
5.8L	1989	H4	4160	18-7017	—
7.5L	1987-88	H4	4160	18-7017	—
305 C.I./B	1977-79	R2	2GE	18-7086	18-7200
305 C.I./B	1977-78	R4	4MV	—	18-7201
305 C.I./B	1979-83	R4	4MV	18-7095	18-7201
350 C.I./B	1977-78	R4	4MV	—	18-7201
350 C.I./B	1979-83	R4	4MV	18-7095	18-7201
350 ④	1988-89	R4	4MV	18-7095	18-7201
350 ②	1988	R2	2GE	18-7086	18-7200
351 CID/5.BL H.O.	—	H4	4010, R50483A, R84046A (F1JL-9510-EA)	18-7727	—
351 CID/5.BL	—	H4	4160, R9393A, R9394A, R50399A, R50399-1A	18-7729	—
351 CID/5.BL	—	H4	4160C, R80434A	18-7730	—
454 C.I./B	1977-78	R4	4MV	18-7072	18-7201
454,454 H.O. ②	1991-92	H4	4150	18-7242	—
454,454 H.O. ③	1990-92	H4	4150	18-7241	—
460 C.I.	1987-88	H4	4160	18-7017	—
460	1989-90	H4	4160	18-7235	—

- ② For 2V Carburetors
- ③ For 4V Carburetors
- ④ For Engine Model 574APEPWS

- ② For 1990 PWC Suffix Only
- ③ For Engine Model 574APERGD

- ① For Engine Model 744DPEAMH, 744DPPAMH
- ② For Engine Model 744CPEAMH, 824BPEAM

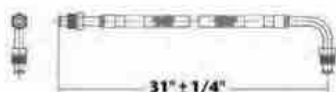

**18-8114
FUEL LINE HOSE**

For fuel pump to carburetor connection. Replaces copper or steel tubing 3/8" X 31" PTFE composite hose with 5/8"-18 male inverted flare straight one end, 5/8"-18 90° one end. SAE J1527 type A1

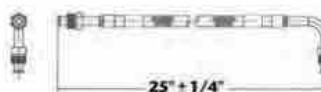

**18-8115
FUEL LINE HOSE**

For fuel pump to carburetor connection. Replaces copper or steel tubing 3/8" X 25" PTFE composite hose with 5/8"-18 male inverted flare straight one end, 5/8"-18 90° one end. SAE J1527 type A1



ALL SIERRA FUEL PUMPS INCLUDE MOUNTING GASKET



**18-7256
FUEL PUMP**

Flange I.D. # 6790
For: GM (4 & 6 cyl.) 153, 230, 250, 292



**18-7258
FUEL PUMP**

Replaces: 380986
Flange I.D. # 40001, M643
For: GM (V-6) 225, PB-V215



**18-7265
FUEL PUMP**

Flange I.D. # 41412, M73018
For: GM (V-8) 305, 350, 400



**18-7267
FUEL PUMP**

Replaces: 982063
Flange I.D. # 40778, M73016
(includes gasket)
For: Ford (V-8) 302



**18-7268
FUEL PUMP**

Replaces: 981650
Flange I.D. # 41415
For: GM (V-8) 305, 307, 350, 400
Dual diaphragm sight glass required.



**18-7278
FUEL PUMP**

Replaces: 985602, 985603, 982240
Flange I.D. # M60032
Uses filter 18-7860
For: GM (4 & 6 cyl.) 153, 181, 250, 224, 225



**18-7289
FUEL PUMP**

Replaces: 982997
Flange I.D. # 60201
(includes gasket)
For: GM (V-6) 262/4, 36

FUEL PUMP APPLICATION

Model	Years	Pump #	Model	Years	Pump #
2.5	1982-85	18-7278	185	1979-80	18-7268
5	1982-88	18-7268	190	1974-77	—
5.7	1982-92	18-7268	200	1979-81	18-7268
100	1972-73	18-7278	225	1978	18-7268
110	1964	18-7278	230	1979-81	18-7268
120	1965-80	18-7278	235	1975-77	—
140	1973-81	18-7278	240	1978	—
140 Jet Drive	1973	18-7278	245 Jet Drive	1973	18-7278
150	1964	—	250	1979	—
150 Model HU-13EM	1965	—	260	1979-81	18-7268
150 Except HU-13EM	1965	—	305 CID IB	1979-82	18-7268
165	1972-76	18-7278	350 CID IB	1979-82	18-7268
170	1974	—	350	1988-91	18-7268
175	1975-77	—			



18-7326
ELECTRIC FUEL PUMP
 Replaces: 3858261, 3857986, 3850809, 3854620



18-7330
ELECTRIC FUEL PUMP
 Replaces: 3857650, 3855958, 3854280, 987620, 988037



18-7331
ELECTRIC FUEL PUMP
 Replaces: 3850810



18-7229
FLAME ARRESTOR
 Replaces: 986865, 981566

ELECTRIC FUEL PUMP APPLICATION

Year	Engine	Application	OE #	#s Superseded from	Part #
1992-94	262/4.3L	Low Pressure	3858261	3850809, 3850810, 3857985	18-7326
1997-98	350/5.7L, 454/7.4L, & 502/8.2L	Engines w/MPI - High Pressure	3857650		18-7330
1996	454/7.4L & 502/8.2L	Engines w/MPI - High Pressure	3857650		18-7330
1993-94	4.3L thru 5.8L	Low pressure electric fuel pump	3858261	3850809	18-7326
1992-1994	454/7.4L & 502/8.2L	GM Mark V Eng. - Low Pressure	3858714	3850810, 3857985	18-7331

- UNIVERSAL DESIGN -

FUEL WATER SEPARATOR BRACKETS



Bracket Type	Part #	Bracket Type	Part #
1/4" Stainless Steel	18-7777	1/4" Aluminum	18-7853-1
3/8" Stainless Steel	18-7776	3/8" Aluminum	18-7775

FUEL WATER SEPARATOR KITS



21 MICRON FILTER KITS FOR CARBURETED ENGINES

Kit Type	Part #	Micron Rating	Contents
1/4" Aluminum (Short Filter)	18-7848-1 *	21	1 - 18-7844 filter & 1 18-7853-1 bracket, 2 - 18-4256 1/4" pipe plugs
1/4" Aluminum Bonus Pack (Contains spare filter)	18-7848-2 *	21	2 - 18-7844 filter & 1 18-7853-1 bracket, 2 - 18-4256 1/4" pipe plugs
1/4" Aluminum (Tall Filter)	18-7852-1 *	21	1 - 18-7845 filter & 1 18-7853-1 bracket, 2 - 18-4256 1/4" pipe plugs
1/4" Aluminum Bonus Pack (Contains spare filter)	18-7852-2 *	21	2 - 18-7845 filter & 1 18-7853-1 bracket, 2 - 18-4256 1/4" pipe plugs
3/8" Aluminum (Tall Filter)	18-7775-1 *	21	1 - 18-7845 filter & 1 18-7775 bracket, 2 - 18-4264 3/8" pipe plugs
1/4" Stainless Steel (Tall Filter)	18-7777-1 *	21	1 - 18-7845 filter & 1 18-7777 bracket, 2 - 18-4256 1/4" pipe plugs
3/8" Stainless Steel (Tall Filter)	18-7776-1 *	21	1 - 18-7845 filter & 1 18-7776 bracket, 2 - 18-4264 3/8" pipe plugs

10 MICRON FILTER KITS FOR FUEL INJECTED ENGINES



Kit Type	Part #	Micron Rating	Contents
1/4" Aluminum (Short Filter)	18-7983-1 *	10	1 - 18-7944 filter & 1 18-7853-1 bracket 2 - 18-4256 1/4" pipe plugs
1/4" Aluminum Bonus Pack Contains spare filter	18-7983-2 *	10	2 - 18-7944 filter & 1 18-7853-1 bracket 2 - 18-4256 1/4" pipe plugs
1/4" Aluminum (Tall Filter)	18-7982-1 *	10	1 - 18-7945 filter & 1 18-7853-1 bracket 2 - 18-4256 1/4" pipe plugs
1/4" Aluminum Bonus Pack Contains spare filter	18-7982-2 *	10	2 - 18-7945 filter & 1 18-7853-1 bracket 2 - 18-4256 1/4" pipe plugs
1/4" Aluminum (High Capacity Filter)	18-7966-1 *	10	1 - 18-7866 filter & 1 18-7853-1 bracket 2 - 18-4256 1/4" pipe plugs
3/8" Aluminum (Tall Filter)	18-7986-1 *	10	1 - 18-7945 filter & 1 18-7775 bracket 2 - 18-4264 3/8" pipe plugs
1/4" Stainless Steel (Tall Filter)	18-7984-1 *	10	1 - 18-7945 filter & 1 18-7777 bracket 2 - 18-4256 1/4" pipe plugs
3/8" Stainless Steel (Tall Filter)	18-7985-1 *	10	1 - 18-7945 filter & 1 18-7776 bracket 2 - 18-4264 3/8" pipe plugs



10 MICRON FILTER KITS WITH DRAIN BOWLS

Sierra AquaVue™ and metal bowl separator filters allow water to be drained from the filter to extend service life. Use the AquaVue™ bowl for outboard, above deck installations. USCG regulations require the use of the flame resistant metal bowl below deck.

Kit Type	Part #	Micron Rating	Contents
1/4" Aluminum w/ metal drain bowl	18-7951 *	10	1 - 18-7919 filter & 1 18-7853-1 bracket 1 - 18-7924 metal bowl 2 - 18-4256 1/4" pipe plugs
1/4" Stainless Steel w/ metal drain bowl	18-7938 *	10	1 - 18-7919 filter & 1 18-7777 bracket 1 - 18-7924 metal bowl 2 - 18-4256 1/4" pipe plugs

* Display Packaged

COMPACT BRACKET AND SEPARATOR KIT - FOR SMALL OUTBOARDS AND FRESH WATER APPLICATIONS

18-7774
COMPACT ALUMINUM BRACKET



18-7965-1
10 MICRON COMPACT
SEPARATOR KIT
Contains:
1 - 18-7774 bracket
1 - 18-7865 filter



REPLACEMENT FILTERS



UNIVERSAL DESIGN

10 MICRON REPLACEMENT FILTERS

Part #	Description
18-7944	Short - 3.875"
18-7945	Long - 4.35"
18-7866	High Capacity - 6"
18-7865	Compact 10 Micron

21 MICRON REPLACEMENT FILTERS

Part #	Description
18-7844	Short - 3.875"
18-7845	Long - 4.35"

REPLACEMENT FILTERS FOR OMC

10 MICRON REPLACEMENT FILTERS

Part #	Description	Replaces
18-7946	OMC thread	OMC 502905
18-7989	Cobra EFI	OMC 502906

21 MICRON REPLACEMENT FILTERS

Part #	Description	Replaces
18-7846	OMC thread	OMC 502905
18-7789	Cobra EFI	OMC 502906



10 MICRON REPLACEMENT FILTERS AND KITS WITH DRAIN BOWLS

REPLACEMENT FILTERS

Part #	Description	Replaces
18-7919	Spin on replacement	Racor S3213
18-7920	Spin on replacement	OMC 771839 Racor S3214
18-7947	Spin on replacement Fits - 120RRAC01	Racor S3240
18-7948	Spin on replacement Fits - 320RRAC01	Racor S3227
18-7949	Spin on replacement Fits - 660RRAC02	Racor S3232

FILTER & BOWL KITS

Part #	Description
18-7929 -	Filter & Metal Bowl Contains: 18-7919 filter, 18-7924 bowl
18-7941-1 -	Filter & AquaVue™ Bowl OMC style Contains: 18-7920 filter, 18-7922-1 bowl
18-7943 -	Filter & Metal Bowl OMC style Contains: 18-7920 filter, 18-7924 bowl

REPLACEMENT BOWLS

Part #	Description
18-7924	Metal Collection Bowl

REPLACEMENT ELEMENTS

Part #	Description	Replaces
18-7930	1977-83 Fuel system with add on filter kit	OMC 173326



18-7792
FUEL FILTER
Replaces: 910641, 3855104
Fits: OMC 3.0L (1996-98), 3.8L/170 (1981)



18-7854
FUEL FILTER
Replaces: 984491, 311684
Rochester 17078904



18-7855
FUEL FILTER
Replaces: 983870, 910139
Rochester 17068453



**18-7717
FILTER ELEMENT**
For: Rochester 2 bbl & 4 bbl Carburetors



**18-7859
FUEL FILTER**
Replaces: 908034
For: Most GM Inline 4 & 6 cycle;
Ford and GM V-8's up to 400 HP



**18-7860
FUEL FILTER**
Replaces: 381690, 312456
with AC Fuel Pumps
For: Inline 4 & 6 cycle engines



**18-7861
REPLACEMENT
CANISTER AND FILTER**
Replaces: 981911



**18-7862
FUEL FILTER ELEMENT**
For Fuel Filter
(Includes Gasket)
Replaces: 982230



**18-7964-1
TRANSMISSION FILTER KIT**



**18-8072
FUEL ELBOW**
3/8" Hose Barb with
3/8" NPT Thread
Replaces: 174177
90°



HOSE BARB
NPT Thread
18-8074 **18-8055**
3/8" with 1/4" 3/16" with 1/4"
Replaces: 173312 Replaces: 173311

PKG. OF 10

SNAPPER CLAMPS

Part No.	O.E. No.	Range	Size
18-8020 ①	322652	.538 - .608	8
18-8021 ①	911616	.597 - .665	10
18-8034 ①	329654	.670 - .780	12
18-8200 ①	322653	.360 - .406	2
18-8201 ①	124249	.410 - .468	4
18-8202 ①	322654	.475 - .536	6
18-8203 ①	329653	.760 - .875	14
18-8204 ①	324825	.875 - .975	19



**18-5894
OIL PRESSURE LIGHT SWITCH**
Replaces: 0379948

ALL SIERRA WATER PUMPS ARE BI-DIRECTIONAL



**18-3593
CIRCULATING WATER PUMP**
Replaces: 0984360, 0986779, 380640, 3854017, 3858340
Uses gasket 18-0327 (Included)
For: GM Inline (4 & 6 Cylinder)



**18-3577-2
CIRCULATING WATER PUMP**
Replaces: GM 6269358, OMC 987447,
983296, 986074, 3854118
For: GM Big Block



**18-3578
CIRCULATING WATER PUMP**
Replaces: 984876



**18-3599-2
CIRCULATING WATER PUMP**
Replaces: 382218, 980477, 985429, 3853850
For: GM V-6 & small block V-8 engines
Uses gasket 18-0981 (Included)

① This product is priced per piece. To order priced per package, please add -9 to the part number.

WATER CIRCULATING PUMP APPLICATION

Model	Year	Part #	Model	Year	Part #	Model	Year	Part #
2.3	1987-90	-	165	1972-76	18-3593	Inboard	1970-74	18-3599-2
2.5	1982-86	18-3593	185	1967-80	18-3599-2	250	1979	18-3593
3	1982-92	18-3593	200	1979-81	18-3599-2	260		
3.8	1981-86	18-3599-2	210	1968-70	18-3599-2	Inboard	1975-76	18-3599-2
4.3	1985-92	18-3599-2	210			260	1979-81	18-3599-2
5	1982-88	18-3599-2	Inboard	1970-72	18-3599-2	262	1989	18-3599-2
5	1989-92	18-3593	215	1971	18-3599-2	290		
5.7	1982-92	18-3599-2	225	1972-78	18-3599-2	Jet Drive	1974-75	18-3599-2
5.8	1989-92	18-3593	225			305 CID IB	1977-82	18-3599-2
100	1972	18-3593	Inboard	1973-74	18-3599-2	350 CID IB	1977-82	18-3599-2
100	1973	18-3599-2	230			350	1988-92	18-3599-2
120	1965-69	18-3593	Inboard	1975-76	18-3599-2	454 CID IB	1977-80	18-3577-2
120	1972	18-3593	230	1979-81	18-3599-2	454 CID IB	1982	18-3599-2
120	1973-74	18-3599-2	235	1971	18-3599-2			
120	1975-81	18-3593	245	1972-75	18-3599-2			
140			245					
Jet Drive	1973	18-3593	Jet Drive	1972-75	18-3599-2			
140	1973-81	18-3593	250					

**18-3058
IMPELLER**
Replaces: 983895



**18-3086
IMPELLER**
Replaces: 379475, 777130



**18-30585
IMPELLER**
Replaces: 3854072
Fits: King Cobra (1992-1995)



IMPELLER APPLICATION

Model	Years	Impeller	Model	Years	Impeller
2.3	1987-1990	18-3058 ①	170	1974	18-3086
2.5	1986	18-3058	175	1975-1977	18-3086
3	1986-1992	18-3058 ①	185	1967-1968	18-3086
4.3	1986-1992	18-3058	185	1978-1984	18-3086
5	1986-1992	18-3058	190	1974-1977	18-3086
5.7	1986-1992	18-3058 ②	200	1966-1968	18-3086
5.8	1989-1992	18-3058	200	1979-1984	18-3086
50FAPLJVB, 50FAPJVN	1993	18-3058	210	1968-1972	18-3086
50FAPRJVB	1993	18-3058	215	1971	18-3086
50FACPMDA, 50FACPMDM	1994	18-3060	225	1972-1976	18-3086
50FAGPMDA, 50FAGPMDM	1994	18-3060	225	1978	18-3086
50FAGPMDM	1994	18-3060	230	1975-1976	18-3086
58FACPMDA, 58FACPMDM	1994	18-3060	230	1979-1981	18-3086
58FAGPMDA, 58FAGPMDM	1994	18-3060	232AMFTC	1987	18-3086
58FAPLJVB, 58FAPLJVN	1993	18-3058	232AMRGDE, 232AMRGDP	1988	18-3058
58FAPRJVB, 58APRJVN	1993	18-3058	232APFTC	1987	18-3058
7.5	1987	18-3058	232APRGDE, 232APRGDP	1988	18-3058
80	1968-1969	—	232APSRC	1967	18-3058
88	1964	—	232BMRMED, 232BMRMEF	1989	18-3058
90	1965-1968	—	232BPRMED, 232BPRMEF	1989	18-3058
90	1970-1971	—	235	1971	18-3088
100	1972-1973	18-3086	235	1975-1977	18-3088
110	1964	— ③	240	1978	18-3088
110	1964	18-3086 ④	245	1972-1975	18-3086
120	1965-1967	— ③	250	1970-1974	18-3086
120	1965-1967	18-3086 ④	250	1979	18-3086
120	1968-1984	18-3088	252AMKWB, 252APKWB	1986	18-3058
140	1973-1984	18-3086	260	1975-1976	18-3086
150	1964-1966	18-3086	260	1979-1984	18-3086
155	1967-1972	18-3086	262	1989	18-3058
165	1972-1976	18-3086	262AMLMED, 262APRMED	1989	18-3058

① Except models originally equipped with short impeller or retrofitted with short impeller kit
 ② Except 1992 5.7LE models ③ Standard pump ④ Heavy duty pump

Model	Years	Impeller	Model	Years	Impeller
302AMARJ, 302AMARY	1987	18-3058	434AMKWB	1986	18-3058
302AMFTC	1987	18-3058	434AML PWS	1990	18-3058
302AMKWB	1986	18-3058	434AMWXS	1986	18-3058
302AMRGDP	1988	18-3058	434AML GDP	1988	18-3058
302AMRMED	1989	18-3058	434APARY, 434APFTC	1987	18-3058
302APARY, 302APFTC	1987	18-3058	434APKWB	1986	18-3058
302APKWB	1986	18-3058	434APLAMH	1992	18-3058
302APRGDP	1988	18-3058	434APL JVB, 434APL JVN	1993	18-3058
302APRMED	1989	18-3058	434APLRGD	1991	18-3058
302APSRC, 302ARSRY	1987	18-3058	434APRAMH	1992	18-3058
302BMRAMH, 302BMRAMK	1992	18-3058	434APRGDP	1988	18-3058
302BMRJVB	1993	18-3058	434APR JVB, 434APR JVN	1993	18-3058
302BMRRGD	1991	18-3058	434APRPWS	1990	18-3058
302CCPMDA, 302CGPMDA	1994	18-3060	434APRRGD	1991	18-3058
302CMHUB	1995	18-3060	434APSRC, 434APSR Y	1987	18-3058
302CMNCA, 302CMNCS	1996	18-3060	434APWXS	1986	18-3058
302CMRAMH, 302CMRRAMK	1992	18-3058	454	1977	18-3086
302CMR JVB	1993	18-3058	454	1990-1991	18-3058
302CMRRGD	1991	18-3058	460	1988-1990	18-3058
302CFHUB	1995	18-3060	460AML MED	1989	18-3058
302CFNCA "A" SUFFIX MODELS	1996	18-3060	460APRMED	1989	18-3058
302CFNCS "A" SUFFIX MODELS	1996	18-3060	502ACPMDA	1994	18-3060
302CPRAMH, 302CPRAMK	1992	18-3058	502AGPMDA	1994	18-3060
302CPR JVB	1993	18-3058	502AML GDP	1988	18-3058
302CPRRGD	1991	18-3058	502AML MED	1989	18-3058
302DCMMDA, 302DGMMDA	1994	18-3060	502AML PWS, 502ANLPWS	1990	18-3058
305	1977-1978	18-3086	502APLAMH, 502APLAMK	1992	18-3058
350	1977-1978	18-3086	502APL JVB	1993	18-3058
350	1988-1991	18-3058	502APLRGD	1991	18-3058
350AML MED, 350APRMED	1989	18-3058	502APRAMH, 502APRAMK	1992	18-3058
370	1988	18-3058	502APRGDP	1988	18-3058
432ACMMDA, 432ACPMDA	1994	18-3060	502APR JVB	1993	18-3058
432AGMMDA, 432AGPMDA	1994	18-3060	502APRMED	1989	18-3058
432AMARY, 432AMFTC	1987	18-3058	502APRPWS	1990	18-3058
432AMKWB	1986	18-3058	502APRRGD	1991	18-3058
432AML GDP	1988	18-3058	502BPRAMH, 502BPRAMK	1992	18-3058
432AML MED	1989	18-3058	502BPR JVB	1993	18-3058
432AML PWS	1990	18-3058	502BPRMED	1989	18-3058
432AMWXS	1986	18-3058	502BPRPWS	1990	18-3058
432APARY, 432APFTC	1987	18-3058	502BPRRGD	1991	18-3058
432APKWB	1986	18-3058	504AMARY, 504AMFTC	1987	18-3058
432APLAMH	1992	18-3058	504AMKWB	1986	18-3058
432APL JVB, 432APL JVN	1993	18-3058	504AML GDP	1988	18-3058
432APLRGD	1991	18-3058	504AMWXS	1986	18-3058
432APRAMH	1992	18-3058	504APARY, 504APFTC	1987	18-3058
432APRGDE, 432APRGDP	1988	18-3058	504APKWB	1986	18-3058
432APR JVB, 432APR JVN	1993	18-3058	504APRGDP	1988	18-3058
432APRMED	1989	18-3058	504APWXS	1986	18-3058
432APRPWS	1990	18-3058	572ACPMDA, 572AGPMDA	1994	18-3060
432APRRGD	1991	18-3058	574AMFTC	1987	18-3058
432APSRC, 432APSR Y	1987	18-3058	574AMKWB	1986	18-3058
432APWXS	1986	18-3058	574AML GDP	1988	18-3058
434AMARY, 434AMFTC	1987	18-3058	574AML MED	1989	18-3058

① Except models originally equipped with short impeller or retrofitted with short impeller kit

② Except 1992 5.7LE models ③ Standard pump ④ Heavy duty pump

Model	Years	Impeller	Model	Years	Impeller
574AML PWS	1990	18-3058	584AML MED	1989	18-3058
574AMWXS	1986	18-3058	584AML PWS	1990	18-3058
574APARY	1967	18-3058	584APL AMH, 584APL AMK	1992	18-3058
574APEPWS	1990	18-3058	584APL JVB	1993	18-3058
574APERGD	1991	18-3058	584APLRGD	1991	18-3058
574APFTC	1987	18-3058	584APRAMH, 584APRAMK	1992	18-3058
574APKWB	1986	18-3058	584APR JVB	1993	18-3058
574APL AMH	1992	18-3058	584APR MED	1989	18-3058
574APLRGD	1991	18-3058	584APR PWS	1990	18-3058
574APRAMH	1992	18-3058	584APR RGD	1991	18-3058
574APR GDP	1988	18-3058	744APEPWS	1990	18-3058
574APR MED	1989	18-3058	744APERGD, 744APERGF	1991	18-3058
574APR PWS	1990	18-3058	744BPERGD	1991	18-3058
574APR RGD	1991	18-3058	754APEPWS	1990	18-3058
574APSRC	1987	18-3058	754APFTC, 754APSRC	1987	18-3058
574APWXS	1986	18-3058	754BPFCT, 754BPSRC	1987	18-3058
574BML GDP	1988	18-3058			
574BPEPWS	1990	18-3058			
574BPERGD	1991	18-3058			
574BPR GDP	1988	18-3058			
584ACPMDA, 584AGPMDA	1994	18-3060			

- ① Except models originally equipped with short impeller or retrofitted with short impeller kit
- ② Except 1992 5.7LE models
- ③ Standard pump
- ④ Heavy duty pump



18-3108
IMPELLER KEY
Replaces: 308928
Fits: Stern drive models (1968-85)
For: Stringer Drive Impeller 18-3086



18-3111
WATER PUMP
SHAFT SEAL
Replaces: 907774
I/O 1972-86
EXCEPT COBRA



18-4833
WATER PASSAGE
HOUSING
(LOWER UNIT)
Replaces: 915720
Fits: OMC Cobra (1986-93) without cone clutch



18-4837
WATER PASSAGE COVER
Replaces: 911734
Fits: OMC Cobra (1986-93) without cone clutch



18-3119
WATER PUMP HOUSING
Replaces: 983298



18-3206
WATER PUMP HOUSING
Replaces: 984744
For: OMC Cobra



18-3145
PUMP LINER
Replaces: 911844



18-3121
IMPELLER PLATE
Replaces: 911703
COBRA



18-3141
IMPELLER PLATE
Replaces: 313176
110-260 HP I/O 1968-86
EXCEPT COBRA



18-3502
WATER PUMP VENT HOSE
Replaces: 912614
Fits: OMC Cobra (1986-93) without cone clutch

18-3212-1D 



**18-3212-1
IMPELLER
REPAIR KIT**
Replaces: 984461

— CONTAINS —

Part #	Description	O.E.M. #	Qty.
18-2541	O-Ring	911704	1
18-2916	Water Pump		
	Housing Gasket	911702	1
18-3058	Impeller	983895	1
18-3121	Impeller Plate	911703	1
18-3145	Pump Liner	911844	1



**18-3286
IMPELLER
REPAIR KIT**
1964-86
EXCEPT COBRA

— CONTAINS —

Part #	Description	O.E.M. #	Qty.
18-7135	O-Ring	310584	1
18-3141	Plate	313176	1
18-7129	O-Ring	314491	1
18-3111	Rubber Seal	907774	1
18-3066	Impeller	379475	1
18-7158	O-Ring	310585, 310967	1



**18-3386
WATER PUMP KIT**
Replaces: 983218
1964-86
EXCEPT COBRA

— CONTAINS —

Part #	Description	O.E.M. #	Qty.
18-7135	O-Ring	310584	1
18-3141	Plate	313176	1
18-7129	O-Ring	314491	1
18-3066	Impeller	379475	1
18-3111	Rubber Seal	907774	1
18-3119	Impeller Housing	983298	1
18-7158	O-Ring	310585, 310967	1



**18-3348
COMPLETE WATER PUMP KIT**
Replaces: 984461
For: All OMC Cobra Drives-2.3 (1987-90),
2.5 (1986), 3.0(1986-93), 4.3(1986-93), 4.6(1989),
5.0(1986-93), 5.7(1986-93),
5.8 (1989-93), 7.5(1987-89)
Uses impeller **18-3066**



**18-3469
WATER PUMP REPAIR KIT**
Replaces: 3854661
For: King Cobra Drives (1992-1995)



**18-3349
WATER PUMP HOUSING KIT**
For: All OMC Cobra Drives-2.3 (1987-90),
2.5 (1986), 3.0(1986-93), 4.3(1986-93),
4.6(1989), 5.0(1986-93), 5.7(1986-93),
5.8 (1989-93), 7.5(1987-89)



**18-5897
SENDER**
Replaces: 980613
3/8" — 18 NPT
For: Mercruiser Vazer



**18-5898
SENDER**
Replaces: 171960
1/2" — 14 NPT



**18-5899
OIL PRESSURE
SENDER**
Replaces: 982650



**18-3554
THERMOSTAT**
Replaces: 383307
160°



**18-3558
THERMOSTAT**
Replaces: 982554,
3853799
160°

18-3653D 



**18-3653
THERMOSTAT KIT**

— CONTAINS —

Part #	O.E. #	Desc.
18-3554	383307	Thermostat
18-2858	314809	Manifold Gasket
18-2917	3701777 (GM)	Thermostat Gasket
18-0398	3852111	Thermostat Gasket

APPLICATION FOR THERMOSTATS/KITS ON NEXT PAGE

① Items ending in "D" are Display Packaged - Regular number is Non-Display



18-3670
THERMOSTAT KIT

Fits: 2.5L & 3.0L (1982-88)

— CONTAINS —

Part #	O.E.#	Desc.
18-3558	982554	Thermostat
18-2858	314809	Thermostat Housing
		Cover Gasket
18-0929	313416	Thermostat Gasket



18-3676
THERMOSTAT KIT

For: 7.4L (1994-98), 8.2L (1998)

— CONTAINS —

Part #	O.E.#	Desc.
18-7170	3852071	O-Ring
18-0398	3852111	Thermostat Gasket
	3853983	Thermostat



18-3677
THERMOSTAT KIT
160°

— CONTAINS —

Part #	O.E.#	Desc.
18-7170	3852071	O-Ring
18-0398	3852111	Thermostat Gasket
	3856961	Thermostat

HP	Year	HP	Year
4.3L	1994-97	5.8L	1994-97
4.3 HO	1991-97	5.8 (EFI)	1993-97
5.0 L	1994-97		

THERMOSTAT AND THERMOSTAT KIT APPLICATION

Model	Years	Thermostat	Thermostat Kit	Model	Years	Thermostat	Thermostat Kit
90	1970	18-3554	18-3653	250	1970-73	18-3554	18-3653
100	1972-73	18-3554	18-3653	250	1979	18-3554	18-3653
120	1969-80	18-3554	18-3653 ①	260	1979-81	18-3554	18-3653
120	1980-81	18-3558	18-3670 ②	262	1989	18-3554	—
140	1973-80	18-3554	18-3653 ①	305	1977-82	18-3554	18-3653
140	1980-81	18-3558	18-3670 ②	350	1977-82	18-3554	18-3653
155	1969-72	18-3554	18-3653	350	1989	18-3554	—
165	1972-76	18-3554	18-3653	351	1992	18-3554	—
170	1974	18-3554	18-3653	454	1977-82	18-3554	18-3653
175	1975-77	18-3554	18-3653	460	1989	18-3554	—
185	1978-80	18-3554	18-3653	2.5L	1982-88	18-3558	18-3670
190	1974-77	18-3554	18-3653	3.0L	1982-88	18-3558	18-3670
200	1979-81	18-3554	18-3653	3.8L	1981-85	18-3554	18-3653
210	1969-72	18-3554	18-3653	4.3L	1985-86	18-3554	18-3653
215	1971	18-3554	18-3653	4.3L	1989-92	18-3554	—
225	1971	18-3554	18-3653	5.0L	1982-88	18-3554	18-3653
230	1979-81	18-3554	18-3653	5.0L	1989-92	18-3554	—
235	1971	18-3554	18-3653	5.7L	1982-88	18-3554	18-3653
235	1975-77	18-3554	18-3653	5.7L	1989	18-3554	—
240	1978	18-3554	18-3653	5.8L	1989-92	18-3554	—
245	1972-75	18-3554	18-3653	7.5L	1988	18-3554	18-3653

① 1980 Models with "C" suffix only

② 1980 Models with "C1" suffix only

SINGLE DIAMETER HOSE



18-70021
MOLDED HOSE
3/4" ID



18-70704
MOLDED HOSE
1 1/4" ID



18-70924
MOLDED HOSE
1 3/4" ID



18-71218
MOLDED HOSE
1" ID



18-71337
MOLDED HOSE
1 3/4" ID

STRAIGHT HOSE



18-75100
MOLDED HOSE
Straight 48"
1" ID



18-75125
MOLDED HOSE
Straight 48"
1 1/4" ID

① Items ending in "D" are Display Packaged - Regular number is Non-Display

V-BELTS

- 1 High strength synthetic cords resist shockload failure. Their low stretch properties assure uniform performance over the life of the belt.
- 2 The compression section is a special rubber compound that assures smooth and even transfer of load forces to the cords.
- 3 Cogs are molded to precise engineering tolerances to improve flexibility and maintain cord support. Cog geometry provides a large area for air circulation to keep the belt cool and prevent damaging heat build up in the cushion section.
- 4 Rubber edges maintain positive, no-slip contact with pulley grooves for reliable energy transfer.



BELT SIZE LISTING BY NUMBER

Part #	Effective Length (Inches)	Top Width (Inches)	Part #	Effective Length (Inches)	Top Width (Inches)	Part #	Effective Length (Inches)	Top Width (Inches)
18-15290	29	29/64	18-15405	40 1/2	29/64	18-15460	46	29/64
18-15300	30	29/64	18-15410	41	29/64	18-15470	47	29/64
18-15325	32 1/2	29/64	18-15415	41 1/2	29/64	18-15480	48	29/64
18-15345	34 1/2	29/64	18-15430	43	29/64	18-15495	49 1/2	29/64
18-15370	37	29/64	18-15435	43 1/2	29/64	18-15500	50	29/64
18-15380	38	29/64	18-15440	44	29/64	18-15520	52	29/64
18-15390	39	29/64	18-15450	45	29/64	18-15550	55	29/64
18-15400	40	29/64	18-15455	45 1/2	29/64			

V-BELT INTERCHANGE

OMC #	Part #	Part #	OMC #
310953	18-15460	18-15380	910414
311046	18-15440	18-15400	311606
311606	18-15400	18-15415	910343
908929	18-15455	18-15435	912509
909818	18-15500	18-15440	311046
909971	18-15460	18-15450	914787
910343	18-15415	18-15455	908929
910414	18-15380	18-15460	310953
912418	18-15500	18-15460	909971
912509	18-15435	18-15500	909818
912714	18-15520	18-15500	912418
914787	18-15450	18-15520	912714

HOSE INTERCHANGE

Sierra #	Part #	Sierra #	Part #
18-71337	312781	18-75100	913488
18-75100	910305	18-75125	912793
18-75100	912424		

V-BELT APPLICATION

Model	Year	Water Alternator	Pump	Power Steering	Model	Year	Water Alternator	Pump	Power Steering
100	1972-73	18-15400	18-15400	—	262 KING COBRA	1989	—	*18-15380	18-15455
110	ALL	18-15440	18-15440	—	305	1977-84	18-15440	18-15440/ *18-15455 or *18-15500	—
120	1965-81	18-15400	18-15400	—	350	1977-84	18-15440	18-15440/ *18-15455 or *18-15500	—
140	1982-87	18-15400	18-15400	—					
165	1972-76	18-15400	18-15400	—					
170	1974	18-15400	18-15400	—					
175	1975-77	18-15400	18-15400	—	350 KING COBRA	1988-90	18-15455	18-15455	—
185 W/O PS	1978-84	18-15440	18-15440	—	350 KING COBRA	1988-90	18-15470	*18-15380	18-15455
185 W/ PS	1978-84	18-15460	18-15460	18-15460	454	1977-82	18-15455	18-15455/ *18-15500	—
190	1974-77	18-15400	18-15400	—	454 KING COBRA	—	—	18-15470	18-15380
200 W/O PS	1979-81	18-15440	18-15440	—	460 KING COBRA	1988	18-15460	18-15460	18-15520
200 W/ PS	1979-81	18-15460	18-15460	18-15460	888	—	18-15435	18-15435	—
210	1970-71	18-15440	18-15440	—	2.3L	1987-90	18-15435	18-15435	18-15435
215	1971	18-15440	18-15440	—	2.5L W/O PS	1982-87	18-15415	18-15415	—
225	1972-84	18-15440	18-15440	—	2.5L W/ PS	1982-87	18-15400	18-15400	18-15460
230,260	1975	18-15440	18-15440/ *18-15455	—	3.8L W/O PS	1982-90	18-15400	18-15400	—
230,260	1979-81	18-15440	18-15440	—	3.8L W/ PS	1982-90	—	*18-15380	18-15455
230,260	1979-81	18-15460	18-15460	18-15460	5.0L W/O PS	1982-90	18-15455	18-15455	—
235	1971	18-15440	18-15440	—	5.0L W/ PS	1982-90	—	*18-15380	18-15455
235	1975-77	18-15400	18-15400	—	7.5L	1987	18-15460	18-15460	18-15520
240	1978-84	18-15400	18-15400	—					
250	1979	18-15400	18-15400	—					
262 KING COBRA	1989	18-15400	18-15400	—					

* W/ SEA WATER PUMP

Fits GM 181 CID 3.0L, 4 Cylinder Fits Most 141 Models

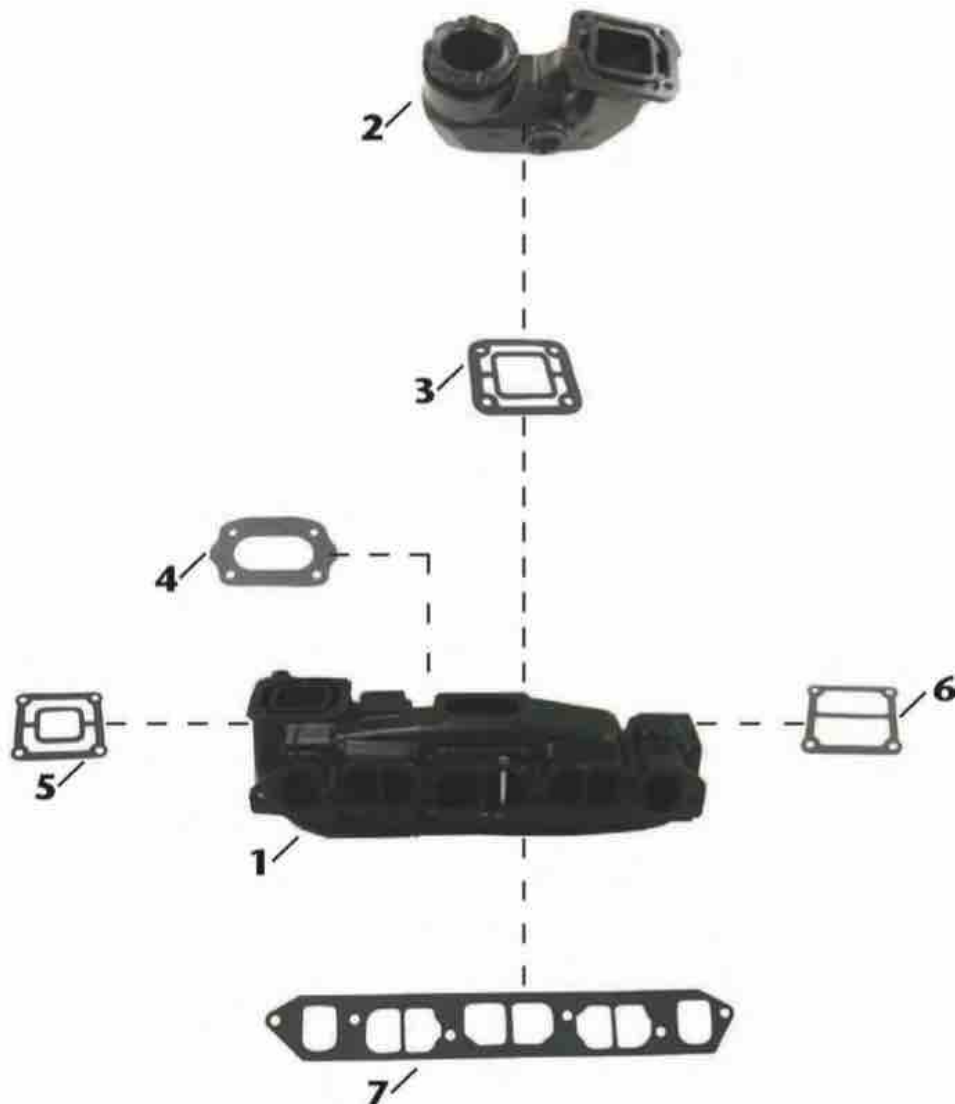

Item No	Description	OE No.	Application
1	18-1901 MANIFOLD	982490, 980083, 984054	GM 181 cu.in. 3.0L , 4 Cylinder. Fits most 140 models.
2	18-1922 MANIFOLD ELBOW	987784	Use with Manifold: 18-1901; Elbow Gasket: 18-2875-1
3	18-2875-1 ELBOW GASKET	3850495	Use with Elbow: 18-1922
4	18-0937 CARBURETOR GASKET	315055	Use with Manifold: 18-1901
5	18-2861-1 END PLATE GASKET	311121	Use with Manifold: 18-1901
6	18-0114-1 END PLATE GASKET	907761	Use with Manifold: 18-1901
7	18-1204-1 MANIFOLD GASKET	912164	Use with Manifold: 18-1901

Fits GM Small Block V8 305-350 cu. in. 1979-1989

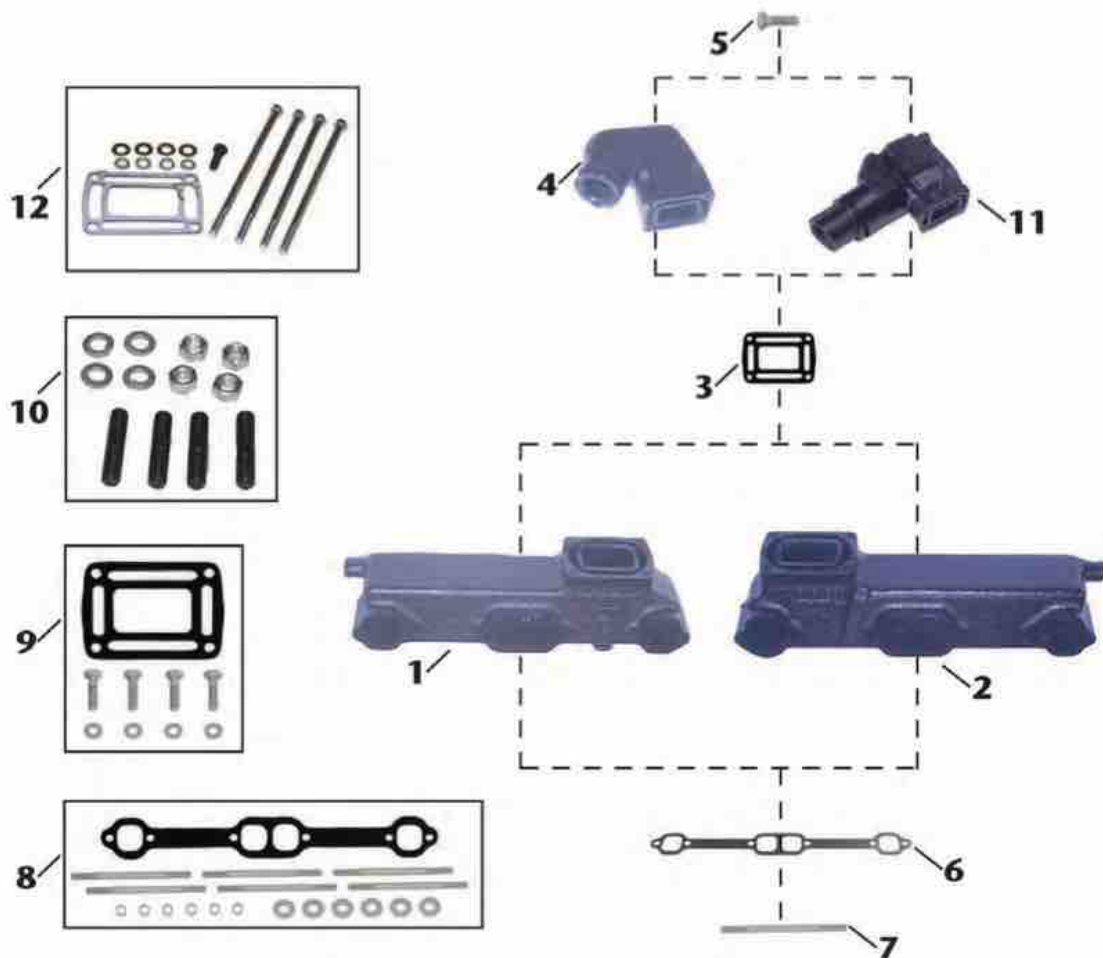

Item No	Description	OE No.	Application
1	18-1902 MANIFOLD (STARBOARD)	912441	GM Small Block (V8) 305-350 cu.in. (1979-1989)(Starboard) Use with Manifold Gasket: 18-2949. Mounting Kit: 18-8502
2	18-1903 MANIFOLD (PORT)	912442	GM Small Block (V8) 305-350 cu.in. (1979-1989)(Port). Use with Manifold Gasket: 18-2949. Mounting Kit: 18-8502
3	— ELBOW GASKET	909786	Use with Elbow: 18-1921; Mounting Kit: 18-8534.
4	18-1921 MANIFOLD ELBOW	909863	Use with Manifold: 18-1902, 18-1903. Mounting Kit: 18-8534.
5	NSS MOUNTING BOLT	N/A	Included in 18-8534 mounting kit.
6	18-2949 MANIFOLD GASKET	96306	Use with Manifold: 18-1902, 18-1903. Included in 18-8502 mounting kit.
7	NSS MOUNTING STUD	N/A	Included in 18-8502 mounting kit.
8	18-8502 MOUNTING KIT	N/A	Use with Manifold: 18-1902, 18-1903. Includes 18-2949 manifold gasket.
9	18-8534 MOUNTING KIT	N/A	Use with Elbow: 18-1921.
10	18-8553 HARDWARE KIT	N/A	Hardware only for Elbow 18-1921.
11	18-1909-1 MANIFOLD ELBOW	N/A	Use with Elbow Gasket: 18-0943-2
12	18-8507 MOUNTING KIT	N/A	Use with Manifold Elbow: 18-1909-1

Fits GM Small Block V8 305-350 cu. in.



	Item No	Description	OE No.	Application	
	1	18-1986-1	MANIFOLD	3857723	GM Small Block (V8) 305-350 cu.in. Use with Manifold Gasket: 18-2949; Mounting Kit: 18-8502.
	2	—	ELBOW GASKET	909786	Use with Elbow: 18-1909-1. Included in 18-8507 mounting kit.
	3	18-1909-1	MANIFOLD ELBOW	913784, 3855270, 3850459, 3857944	Use with Manifold: 18-1986-1; Mounting Kit: 18-8507.
	4	NSS	MOUNTING BOLT	N/A	Included in 18-8507 mounting kit.
	5	18-8216	HOSE FITTING	N/A	3/4" - 14NPT X 1" Hose (Corrosion Resistant Brass Fitting)
	6	18-4461	HOSE FITTING	N/A	3/4" - 14NPT X 1" Hose (Corrosion Resistant Brass Fitting)
	7	18-8215	HOSE FITTING	N/A	3/4" - 14NPT X 3/4" Hose (Corrosion Resistant Brass Fitting)
	8	18-2949	MANIFOLD GASKET	96306	Use with Manifold: 18-1986-1. Included in 18-8502.
	9	NSS	MOUNTING STUD	N/A	Included in 18-8502 mounting kit.
	10	18-8502	MOUNTING KIT	N/A	Use with Manifold 18-1986-1. Includes 18-2949 manifold gasket.
	11	18-8507	MOUNTING KIT	N/A	Use with Elbow: 18-1909-1. Includes 18-0943-2 elbow gasket.

SIERRA MANIFOLDS ARE PAINTED, PACKAGED AND LEAK TESTED



**18-1901
MANIFOLD**
Replaces: 984054
Fits 181 CID model 140
and 3.0L (1973 - 1989)
Use with: Exhaust Manifold Gasket **18-1204-1** &
Elbow Gasket **18-2875-1**
***For Exploded View - See PAGE 912**



**18-1898
MANIFOLD**
Port & Starboard
Replaces: Barr CHVA-1-84, Marine Power 0991-110
Fits 454 cu.in. GM big block V8 engines
Use with:
Exhaust Manifold Gasket: 18-0418
***For Exploded View - See Pages 654-655**



**18-1997-1
EXHAUST MANIFOLD**
Port & Starboard
Replaces Barr CHV-1-83 Universal Center Riser Manifold
FITS: GM 283, 305, 307 and 350 CID engines
Use with:
Exhaust Manifold Gasket Set: 18-0604
***For Exploded View - See Pages 656-657**



**18-1998-1
EXHAUST MANIFOLD**
Port & Starboard
Replaces: Barr FM-1-83
Universal Center Riser Manifold
FITS: Ford 302 and 351 CID engines
Use with:
Exhaust Manifold Gasket Set: 18-0603
***For Exploded View - See Pages 658-659**



**18-1986-1
MANIFOLD**
Port & Starboard
Replaces: 3852374, 3857723
For: GM Small Block V8 305-350 ci
Use with:
Exhaust Manifold Gasket: 18-2949
Mounting Kit: 18-8502



**18-1902
MANIFOLD**
Replaces: 912441
V-8 - STARBOARD SIDE
Fits most GM V-8 small blocks with end riser
Use with:
Mounting Kit: 18-8502



**18-1903
MANIFOLD**
Replaces: 912442 V-8 - PORT SIDE
Fits most GM V-8 small blocks with end riser
Use with:
Mounting Kit: 18-8502



**18-1904
MANIFOLD**
Port & Starboard
Replaces: 980959, 980572 V-8 - EITHER SIDE
Fits most Ford V-8 302 & 351W with end riser
Use with:
Exhaust Manifold Gasket: 18-0183-1 or 18-2896-1
(See Application Chart)



**18-1848
MANIFOLD**
Replaces: 3852338, 3857656, 914899
Fits: 4.3L V-6



**18-1991
30° EXHAUST ELBOW ADAPTER**
Replaces: Barr 200089P
For use with 3" I.D.
Exhaust Hose
Use with:
Manifold Riser: 18-1999



**18-1992-1
80° EXHAUST ELBOW**
Replaces: Barr 200087P
For 3" I.D. Exhaust Hose (As used in 18-1987
Exhaust Manifold Conversion Kit)



**18-1921
ELBOW MANIFOLD**
Replaces: 909863
V-8
Fits most GM V-8 small blocks
Use with:
Manifold: 18-1902, 18-1903
Elbow Gasket: 18-0943-2
Mounting Kit: 18-8534



**18-1922
ELBOW MANIFOLD**
Replaces: 987784, 916096, 0740120,
3850799, 910380
4 CYL.
Fits most 140 HP 3.0L (181 CID)
Use with:
Manifold: 18-1901
Elbow Gasket: 18-2875-1



**18-1909-1
RISER**
Replaces:
OMC 913784, 3855270, 3850456,
3857944
VOLVO 3855270-9, 3857944-7,
3863061, 3856444
OMC Riser, 4" outlet 7": Fits many GM
& Ford center rise manifolds.
Use with:
Manifold: 18-1986-1
Riser Gasket: 18-0943-2
Mounting Kit: 18-8507



**18-1939
RISER**
Replaces: Barr 20-0100, Marine Power 0992-593 Barr, Indmar
and Marine Power Ford Small Block V8 302-351cu.in., GM Small
Block V8 305-350cu.in., GM Big Block V8 454cu.in.
Use with:
Manifold: 18-1997-1, 18-1998-1
Riser Gasket: 18-2854-1 open or 18-0476-1 blocked
Mounting Kit: 18-4364 open or 18-8535 blocked
4" hose



**18-1907
RISER**
Replaces: Barr 20-0102, Indmar 53-2009,
53-2018, Barr and Indmar Ford Small Block
V8 302-351cu.in.
Use with:
Manifold: 18-1997-1, 18-1998-1
Riser Gasket: 18-2854-1 open or
18-0476-1 blocked
Mounting Kit: 18-4364 open or 18-8535
blocked
3" hose



**18-1999
EXHAUST
MANIFOLD
RISER**
Replaces: Barr 20-0082
Use with:
Manifold: 18-1997-1 or 18-1998-1
Riser Gasket: 18-2854-1 open
3 1/2" hose
Comes with 18-4364 open
If blocked mounting kit is required use 18-8535
Replaces: Barr 20-0082-P



**18-4009
MANIFOLD END PLATE**
Replaces: 910384



PIPE PLUGS

Part #	Thread Size
18-4256	1/4"
18-4257	1/4"
18-4258	3/4"
18-4263	1/8" - 27 NPT
18-4264	3/8" - 18 NPT



**18-4461
HOSE BARB**
3/4" - 14 NPT X 1" Hose
Corrosion Resistant Brass Fitting



**18-8216
HOSE BARB**
3/4" - 14 NPT X 1" hose barb
Fits: OMC- In-Line 6 Cylinders









18-4218D



**18-4218
BRASS DRAIN COCK**
Replaces: 379957
1/4"
18-3223-9 Bulk Pack of 12

 <p>18-4363 MOUNTING PACKAGE Replaces: Barr FM-1-83-P Use with: Manifold: 18-1998-1</p>	 <p>18-4364 (Open) MOUNTING PACKAGE Replaces: Barr 20-0082-P Use with: Riser: 18-1999, 18-1939, 18-1907</p>	 <p>18-8502 MOUNTING KIT OMC GM Small Block V8 305-350cu.in. (1979-89) OMC/Volvo GM Small Block 305-350cu.in. Used with: Manifolds: 18-1931-1,18-1902 & 18-1903</p>
 <p>18-8507 MOUNTING KIT Replaces: Barr CM-20-6674JP OMC/Volvo GM Small Block V8 305-350cu.in. Used with: Riser: 18-1909-1</p>	 <p>18-8534 MOUNTING KIT OMC GM Small Block V8 305-350cu.in. (1979-1989)and multiple application Ford and GM Risers Used with: Riser: 18-1921</p>	 <p>18-8535 (Blocked) MOUNTING KIT Barr, Indmar and Marine Power Ford Small Block V8 302-351cu.in., GM Small Block V8 305-350cu.in., GM Big Block V8 454cu.in. Used with: Risers: 18-1939, 18-1999, and 18-1907</p>
 <p>18-8536 MOUNTING KIT Barr, Indmar and Marine Power GM Small Block V8 305-350cu.in. Used with: Manifold: 18-1997-1</p>	 <p>18-8538 MOUNTING KIT Barr and Indmar Ford Small Block V8 302-351cu.in. Used with: Manifold: 18-1998-1, 18-1904</p>	 <p>18-8553 MOUNTING KIT Used with: Exhaust Elbow: 18-1921</p>
 <p>18-2779 EXHAUST HOSE Replaces: 3852696</p>	 <p>18-2781 EXHAUST HOSE Replaces: 3852742</p>	 <p>18-0114-1 MANIFOLD END GASKET Replaces: 907761</p>
 <p>18-0183-1 EXHAUST MANIFOLD GASKET Replaces: 908717, 916262, 3852455, 3853742 Use with: Manifold: 18-1958, 18-1962, 18-1904, 18-1998-1, 18-1996, 18-1979</p>	 <p>18-0476-1 (Blocked) RISER GASKET Replaces: Barr 01-0105 Indmar & Marine Power Ford Small Block V8 302-351cu.in. Used with: Risers: 18-1939, 18-1999 and 18-1907</p>	 <p>PKG. OF 2 18-0943-2 EXHAUST ELBOW GASKET Replaces: 909786, 3850496 Used with: Riser: 18-1909-1</p>

① Priced per Package

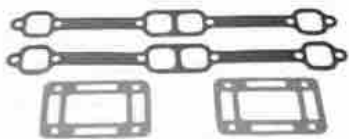
<p>PKG. OF 2</p>  <p>18-2850-1 18-2850-9Ⓜ EXHAUST ELBOW GASKET Replaces: 908935</p>	<p>PKG. OF 2</p>  <p>18-2854-1 18-2854-9Ⓜ EXHAUST RISER GASKET Replaces: Barr 01-0107 Use with: Mounting Kit: 18-8535 Risers: 18-1999, 18-1939, 18-1907</p>	<p>PKG. OF 2</p>  <p>18-2861-1 18-2861-9Ⓜ EXHAUST ELBOW GASKET Replaces: 311121</p>
<p>PKG. OF 2</p>  <p>18-2875-1 18-2875-1-9Ⓜ EXHAUST ELBOW GASKET Replaces: 3850495, 908013 Used with: Elbow: 18-1922</p>	 <p>18-2896-1 MANIFOLD GASKET Replaces: 311068 For GM 4 cyl. 153 cu.in. Early models 110/120 where the carb. linkage mounts to the rear of the engine Use with: Manifold: 18-1904</p>	
<p>PKG. OF 2</p>  <p>18-2902-1 18-2902-1-9Ⓜ MANIFOLD GASKET Replaces: 909314 Use with: Manifold: 18-1997-1, 18-1986-1, 18-1902, 18-1903</p>	<p>PKG. OF 2</p>  <p>18-2949 18-2949-9Ⓜ MANIFOLD GASKET Replaces: Barr CHV-47-000 Use with: Manifold: 18-1997-1</p>	
 <p>18-0603 EXHAUST MANIFOLD GASKET SET For: Ford 302/351 CID Eng. Use with: Manifold: 18-1998-1</p>	 <p>18-0604 EXHAUST MANIFOLD GASKET SET For: GM 305/350 CID Eng. Use with: Manifold: 18-1997-1</p>	

Ⓜ Priced per Package

MANIFOLD/MANIFOLD GASKET APPLICATION

Year	Horsepower	Exhaust Manifold	Exhaust Elbow	Manifold Mount Kit	Elbow Mount Kit	Manifold Gasket	Elbow Gasket
1997-98	5.0/5.7L	18-1986-1	18-1909-1	18-8502	18-8507	18-2902-1	18-0943-2
1994-97	5.8L (Ford)	—	—	—	—	18-0183-1	18-0943-2
1994-97	7.4L (GM)	—	—	—	—	18-0418	18-0943-2
1991-93	3.0 Liter	—	18-1922	—	—	—	18-2875-1
1992-93	4.3/4.3 HO	—	18-1909-1	—	18-8507	—	18-0943-2
1993	5.0/5.0 HO/5.8 Liter	—	18-1909-1	—	18-8507	18-0183-1	18-0943-2
1993	5.0 & 5.8 EFI	—	18-1909-1	—	18-8507	18-0183-1 ②	18-0943-2
1993	5.0 & 5.8 EFI	—	18-1909-1	—	18-8507	—	18-0943-2
1993	5.8L (Ford)	—	18-1909-1	—	18-8507	18-0183-1	18-0943-2
1993	7.4L (GM), 8.2L (GM)	—	18-1909-1	—	18-8507	18-0418	18-0943-2
1993	351 King, 454/454 HO/502	—	—	—	—	—	18-0943-2
1992	5.0/5.0 HO/5.8 Liter	—	18-1909-1	—	18-8507	18-0183-1	18-0943-2
1992	5.8L (Ford)	—	—	—	—	18-0183-1	18-0943-2
1992	7.4L (GM), 8.2L (GM)	—	—	—	—	18-0418	18-0943-2
1992	351 King Cobra	—	—	—	—	18-0183-1	18-0943-2
1992	454/454 HO/502	—	—	—	—	—	18-0943-2
1991	4.3/4.3 HO	—	—	—	—	—	18-0943-2
1991	5.8L (Ford), 5.0/5.0HO/5.8 Liter	—	18-1909-1	—	18-8507	18-0183-1	18-0943-2

② 5.0L only

APPLICATION CONTINUED ON NEXT PAGE

MANIFOLD/MANIFOLD GASKET APPLICATION

Year	Horsepower	Exhaust Manifold	Exhaust Elbow	Manifold Mount Kit	Elbow Mount Kit	Manifold Gasket	Elbow Gasket
1991	454/454 HO	—	18-1909-1	—	18-8507	—	18-0943-2
1991	7.4L (GM)	—	18-1909-1	—	18-8507	18-0418	18-0943-2
1990-91	8.2L (GM)	—	18-1909-1	—	18-8507	—	—
1982-83,1985-90	3.0 Liter	18-1901	18-1922	—	—	—	18-2875-1
1990	4.3 Liter	—	18-1909-1	—	18-8507	—	—
1990	5.0/5.0 HO/5.8 Liter	—	18-1921	—	—	18-0183-1	18-0943-2
1990	5.0/5.7L	18-1986-1	18-1909-1	18-8502	18-8507	18-2902-1	18-0943-2
1990	7.4L (GM)	—	—	—	—	18-0418	18-0943-2
1990	7.5L (Ford)	—	—	—	—	18-0992	18-0943-2
1990	454 King Cobra	—	—	—	—	—	18-0943-2
1987-90	460 King Cobra	—	—	—	—	—	18-0943-2
1989	5.0/5.0 HO/5.8 Liter	—	18-1921	—	18-8534	18-0183-1	18-0943-2
1989	5.7/350 King Cobra	—	—	—	—	18-2902-1	18-0943-2
1988	5.0/5.7/350 King Cobra	18-1902 #	18-1921	18-8502	18-8534	18-2902-1	18-0943-2
1988	5.0/5.7/350 King Cobra	18-1903 *	18-1921	18-8502	18-8534	18-2902-1	18-0943-2
1988	370 King Cobra	—	—	—	—	—	18-0943-2
1982-87	5.0/5.7 Liter	18-1902 #	18-1921 ①	18-8502	18-8534	18-2902-1	18-0943-2
1982-87	5.0/5.7 Liter	18-1903 *	18-1921	18-8502	18-8534	18-2902-1	18-0943-2
1982-86	2.5 Liter	18-1901	18-1922	—	—	18-2896-1	18-2875-1
1984	3.0 Liter	18-1901	18-1921	—	18-8534	—	18-2875-1
1978-81	400 Series, 120 HP	—	—	—	—	18-2896-1	18-2861-1
1978-81	400 Series, 140 HP	—	18-1922	—	—	—	18-2875-1
1981	800 Series, 200,230,260 HP	18-1902 #	18-1921	18-8502	18-8534	18-2902-1	18-0943-2
1981	800 Series, 200,230,260 HP	18-1903 *	18-1921	18-8502	18-8534	18-2902-1	18-0943-2
1980	800 Series, 185-260 HP	18-1902 #	18-1921	18-8502	18-8534	18-2902-1	18-0943-2
1980	800 Series, 185-260 HP	18-1903 *	18-1921	18-8502	18-8534	18-2902-1	18-0943-2
1979	800 Series,185-230 HP	18-1902 #	18-1921	18-8502	18-8534	18-2902-1	18-0943-2
1979	800 Series,185-230 HP	18-1903 *	18-1921	18-8502	18-8534	18-2902-1	18-0943-2
1979	800 Series, 260 HP	18-1902 #	18-1921	18-8502	18-8534	18-2902-1	18-0943-2
1979	800 Series, 260 HP	18-1903 *	18-1921	18-8502	18-8534	18-2902-1	18-0943-2
1978	800 Series, 185-225 HP	18-1902 #	18-1921	18-8502	18-8534	18-2902-1	18-0943-2
1978	800 Series, 185-225 HP	18-1903 *	18-1921	18-8502	18-8534	18-2902-1	18-0943-2
1978	800 Series, 240 HP	—	18-1921	—	18-8534	—	—
1977	120 HP	—	—	—	—	18-2896-1	18-0943-2
1977	140 HP	—	18-1922	—	—	—	18-2861-1
1977	175 THRU 235 HP	—	18-1921	—	18-8534	18-0183-1	18-2875-1
1976	120 HP	18-1904	—	—	—	18-0183-1	18-0943-2
1974-76	140 HP	18-1904	18-1922	—	—	—	18-2861-1
1976	165 HP	18-1904	18-1922	—	—	18-2830-1	18-2875-1
1976	175 THRU 235 HP	18-1904	—	—	—	18-0183-1	18-2875-1
1974-75	120 HP	18-1904	—	—	—	18-2896-1	18-2850-1
1974-75	165 HP	18-1904	18-1922	—	—	—	18-2875-1
1975	175 THRU 235 HP	18-1904	—	—	—	18-0183-1	18-2875-1
1974	170 & 190 HP	18-1904	—	—	—	18-0183-1	18-2875-1
1974	175 THRU 235 HP	18-1904	—	—	—	18-0183-1	18-2850-1
1973	100,120,140 HP	—	—	—	—	18-2896-1	18-2861-1
1973	165 HP	—	18-1922	—	—	18-2896-1	18-2861-1
1972-73	225 & 245 HP	—	—	—	—	—	18-2883
1972	100,120 HP	—	—	—	—	18-2896-1	18-2861-1
1972	155 HP	—	—	—	—	N/A	18-2883
1972	165 HP S MODEL, C MODEL	—	—	—	—	—	18-2875-1
1971	215 & 235 HP	—	—	—	—	—	18-2859
1965-71	120 HP	—	—	—	—	—	18-2861-1
1967-71	155 HP	—	—	—	—	N/A	18-2859
1968-70	210 HP	—	—	—	—	—	18-2859
1967-68	185 HP	—	—	—	—	—	18-2859
1966-68	200 HP	—	—	—	—	N/A	18-2859
1964-66	150 HP	—	—	—	—	N/A	18-2859
1964	110 HP	—	—	—	—	N/A	18-2859

Starboard

* Port

① High rise applications only for 1985

② 5.0L only

OIL FILTERS



Part #	Fits:	O.E.M #
18-7824-2	GM Engines (Short Filter)	173232, 502902
18-7875	Ford Engines (Long Filter)	173231, 502900
18-7876-1	GM Engines (Long Filter)	173233, 502901
18-7878-1	M-100, M200 (Short Filter)	502904
18-7879-1	GM V-6 Engines	173834, 502903

SEE PAGES 200-202 & 1165-1190 FOR ADDITIONAL INFORMATION

CYLINDER HEAD ASSEMBLIES



**18-4486HP
CYLINDER HEAD ASSEMBLY**

Fits: Vortec GM small block 5.7L high performance
Completely assembled with revised runner and combustion chambers. Add 30hp to stock motor with no additional modifications.



**18-4501HP
CYLINDER HEAD**

Fits: Vortec GM small block 5.0L
Completely assembled with revised runner and combustion chambers. Add 30hp to stock motor with no additional modifications.



18-1400
HYDRAULIC LIFTER
Replaces: 3856127
GM 4.3L/V-6 Late/5.0L/5.7L



18-1401
HYDRAULIC LIFTER
Replaces: 3853847, 985316
Ford 5.0L & 5.8L



18-1402
HYDRAULIC LIFTER
Replaces: 3854033, 502036
GM 2.5L/120
For: OMC & Volvo 3.0L/181 CID

**ALL PISTONS
ARE SUPPLIED COMPLETE WITH PISTON RINGS AND WRIST PIN.**



RINGS

Std.	REPLACES OMC/VOLVO
18-3937	*14089025
18-3937	328506
18-3937	3853960
18-3937	914555
18-3937	3853268
18-3937	985083, 986336
18-3944	370409
0.02	
18-3939	3854252
18-3939	914556
0.03	
18-3938	*14089026

RINGS (Cont.)

Std.	REPLACES OMC/VOLVO
18-3938	328516
18-3938	914557

PISTONS

18-4161	3853340, 914816
18-4173	*14077948
18-4173	3911020
0.02	
18-4160	3853477, 915236
0.03	
18-4164	*14077949, 3911023

* OMC References GM Number

PISTON / RING APPLICATION

Model	PISTONS			RINGS			Qty. per Eng.
	Std.	.020	.030	Std.	.020	.030	
OMC							
GM							
2.5L/153 CID	18-4180	18-4183	-	18-3942	-	-	4
3.0L/181 CID	18-4161	18-4160	18-4191	18-3937	18-3939	18-3938	4
I-6/250 CID	-	-	-	18-3942	-	-	6
4.3L/V-6	18-4173	18-4188	18-4164	18-3937	18-3939	18-3938	6
5.0L/305 CID	-	-	18-4178	18-3944	-	-	8
5.7L/350 CID	18-4173	18-4188	18-4164	18-3937	18-3939	18-3938	8
7.4L/454 CID	18-4171	18-4189	18-4172	-	-	-	8
FORD							
5.0L/302 CID	-	-	-	18-3937	18-3939	18-3938	8



ROD BEARINGS



MAIN BEARINGS

Part #	Size
18-1308	Std.
18-1309	.010
18-1327	Std.
18-1329	Std.
18-1333	.010
18-1334	Std.
18-1337	.010
18-1341	.020

Part #	Per Eng.	Size
18-1311	②	Std.
18-1317	②	Std.

Rod bearings sold individually, 1 per rod

BEARING APPLICATION

Model	ROD BEARING			MAIN BEARING			CAM BEARING
	Std.	.010	.020	Std.	.010	.020	
OMC							
GM							
2.5L/153 CID		18-1329	18-1330	-	18-1317	-	-
3.0L/181 CID		18-1308	18-1309	18-1341	18-1317	-	-
I-6/230 CID		18-1329	18-1330	-	-	-	-
I-6/250 CID		18-1308	18-1309	18-1341	-	-	-
4.3L/V-6		18-1327	18-1337	-	18-1311	-	-
5.0L/305 CID		18-1308	18-1309	18-1341	-	-	-
5.7L/350 CID		18-1308	18-1309	18-1341	-	-	-
7.4L/454 CID		18-1334	18-1333	18-1332	-	-	-
FORD							
5.0L/302 CID		-	-	-	-	-	-



One Piece Rear Main Seals

18-1234
Replaces:
3853528

18-0519
Replaces
3852657, 912957



Two Piece Rear Main Seals

18-0528
Replaces:
913745

18-1211
Replaces:
473424



Timing Cover Seals

18-1213
Replaces:
3853341
912989, 914817

18-1230
Replaces:
3853827, 984884

18-1233
Replaces: 3860095

OMC SEAL APPLICATION

Engine Model	2 Piece Rear Main Crankshaft Seal Conv. Rotation (LH)	Timing Cover Seal
GM		
2.5L/153 CID	18-1211 ②	18-1213
3.0L/181 CID	18-1211 ②	18-1213
I-6/230CID	18-1211 ②	18-1213
I-6/250CID	18-1211 ②	18-1213
4.3L/V-6	18-1211 ②	18-1213
5.0L/305 CID	18-1211 ①	18-1213
5.7L/350 CID	18-1211 ①	18-1213
7.4L/454 CID	③	18-1233
FORD		
5.0L/302 CID	18-0528	
5.8L/351 CID	-	18-1230

① Large Journal Crankshaft GM Engines ② For One Piece Seal (LH) Models Use 18-0519 ③ For One Piece Seal (LH) Models Use 18-1234

MISCELLANEOUS GASKETS/GASKET SETS



18-0465
INTAKE MANIFOLD GASKET SET
 Replaces: 352670
 For: GM 454 CID Engines, 325, 330, 340, 350 HP
 and 454 Magnums, 7.4L



18-0153
OIL PAN GASKET SET
 Replaces:
 393159, 458625, 357159
 For: OMC 5.7L



18-1239
OIL PAN GASKET
 Replaces: 914820
 For: OMC 3.0L



18-0348
OIL PAN GASKET SET
 Replaces: 3931593, 508871



18-1237
OIL PAN GASKET
 Replaces: 3856138
 For: GM 5.7L



18-0466
OIL PAN GASKET SET
 Replaces: 393061, 3923440, 3921473

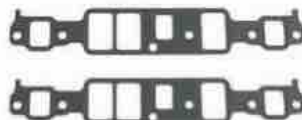

18-1238
INTAKE GASKET SET
 Replaces: 3850379, 912979
 For: OMC 4.3L 1993-98



18-1231
INTAKE GASKET
 Replaces: 3854095



18-0405
OIL PAN GASKET
 Replaces:
 3852655, 912955
 For: OMC 4.3L



18-0407
OIL PAN GASKET SET
 Replaces: 508872



18-0410
INTAKE MANIFOLD GASKET SET
 Replaces:
 988162, 3854406, 986103,
 3853912, 986104, 3853913
 For: OMC 5.0L & 5.8L (1989-96)



18-0411
OIL PAN GASKET SET
 Replaces:
 458625, 357159, 508876

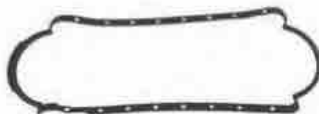

18-1232
OIL PAN GASKET
 Replaces: 3853510



18-0868
INTAKE MANIFOLD GASKET SET
 Replaces:
 985630, 3854269
 For: OMC 5.7L 1994, 1996-97

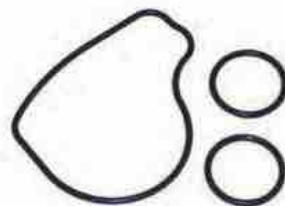
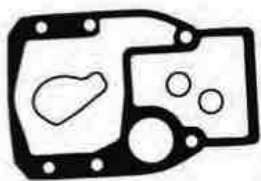

18-2613
OUTDRIVE GASKET SET
Replaces: 508105

18-2699
OUTDRIVE GASKET
For: SX Drives
Use 18-3721 Mounting Nuts

— CONTAINS —

Part #	Description	O.E. #	Qty.
18-2918	Outdrive Gasket	911836	1
18-2996	Outdrive Seal	911823	1
18-7153	O-Ring	911851	2

— CONTAINS —

Part #	Description	O.E. #	Qty.
18-7153	O-Ring	911851	2
18-2996	Outdrive Seal	911823	1

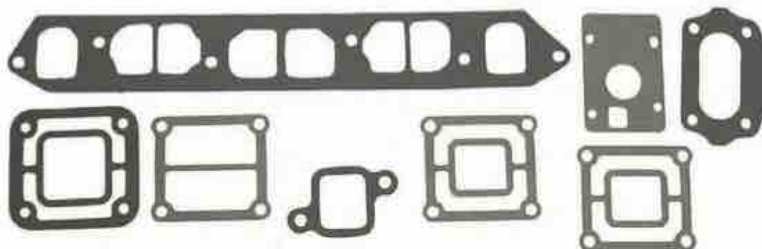

18-4369
EXHAUST MANIFOLD GASKET SET
For: 2.5L (1985-86) and 3.0L (1985-88)



18-4408
INTAKE MANIFOLD GASKET SET
Replaces: 912978
For: GM 4.3L

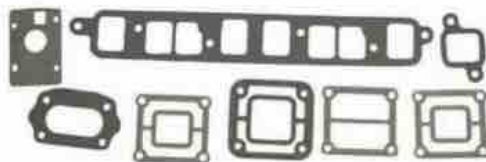

18-4371
EXHAUST MANIFOLD GASKET SET
For: 140 HP and 3.0L (1973-84)

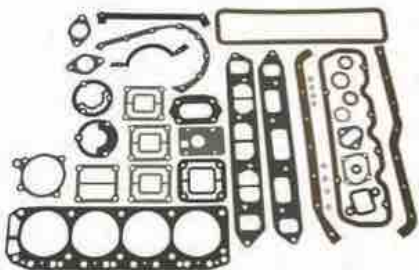

18-4373
OVERHAUL GASKET SET
For: 110, 120 HP and 2.5L (1965-86)

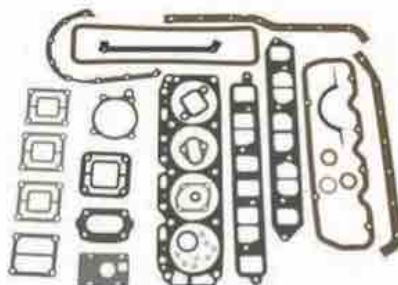





















18-4374
OVERHAUL GASKET SET
For: 140 HP and 3.0L (1973-88)







 <p>18-2946 HEAD GASKET Replaces: 3853336, 908611 For: GM 181 (3.0L) CID Eng.</p>	 <p>18-3874 HEAD GASKET Replaces: 3853511 For: (8.2L) 502 CID</p>	 <p>18-3876 HEAD GASKET Replaces: 3853380, 914971 For: GM 305 (5.0L)/350 (5.7L) CID Eng.</p>	 <p>18-3877 HEAD GASKET Replaces: 914849 For: GM 454 (7.4L) CID Eng.</p>
 <p>18-3878 HEAD GASKET Replaces: 912766 For: 460 Ford</p>	 <p>18-3879 HEAD GASKET Replaces: 3854299, 912227, 914930 For: GM 262 (4.3L) CID Eng.</p>	 <p>18-3880 HEAD GASKET Replaces: 311210 For: GM 153 (2.5L)</p>	 <p>18-3881 HEAD GASKET Replaces: 908237 For: GM 250 (4.1L) CID (6 cyl) Eng.</p>
 <p>18-3883 HEAD GASKET Replaces: 3853732 For: Ford 302 (5.0L) 351 (5.8L) CID Eng.</p>	 <p>18-3887 HEAD GASKET Replaces: 915325 For: (7.4L) 454 CID GEN V</p>	 <p>18-0434 CARB MOUNTING GASKET Replaces: 909758</p>	<p>PKG. of 2</p>  <p>18-5399 18-5399-9① DISTRIBUTOR CAP GASKET Replaces: 910169</p>
<p>PKG. OF 2</p>  <p>18-0874 18-0874-9① DISTRIBUTOR GASKET For GM V6 & V8 Replaces: 3852109, 312780 For: 2.6L (1989), 3.5L (1989), 4.3L (1987-93), 5.0L (1987-88), 5.7L (1987-82), 7.4L (1988-93), 8.2L (1992-93)</p>	<p>PKG. OF 2</p>  <p>18-0937 18-0937-9① CARB MOUNTING GASKET Replaces: 315055</p>	 <p>18-0435 CARB MOUNTING GASKET Replaces: 908765</p>	<p>PKG. OF 2</p>  <p>18-0876 18-0876-9① FUEL PUMP GASKET For GM 4.3L, 5.0L & 5.7L Replaces: 3852113, 312800</p>
<p>PKG. OF 2</p>  <p>18-0164 18-0164-9① THERMOSTAT GASKET 4 & 6 Cyl. Replaces: 311069 GM 3789161</p>	<p>PKG. OF 2</p>  <p>18-0929 18-0929-9① THERMOSTAT GASKET Replaces: 313416</p>	<p>PKG. OF 2</p>  <p>18-2858 18-2858-9① THERMOSTAT GASKET Replaces: 314809</p>	<p>PKG. OF 2</p>  <p>18-2917 18-2917-9① THERMOSTAT GASKET Replaces: 312797, 3701777 (GM)</p>

SEE PAGE 219 FOR OUR COMPLETE LINE OF GASKET SEALANTS

① Priced per Package

<p>PKG. OF 2</p>  <p>18-2947 18-2947-9^① THERMOSTAT GASKET Replaces: 310913</p>	<p>PKG. OF 2</p>  <p>18-0398 18-0398-9^① THERMOSTAT GASKET Replaces: 312797, 3852111</p>	 <p>18-0114-1 MANIFOLD END GASKET Replaces: 907761 For GM 4 Cyl.</p>	<p>PKG. OF 2</p>  <p>18-0104 18-0104-9^① EXHAUST ELBOW GASKET Replaces: 907764</p>
 <p>18-0430 EXHAUST ELBOW GASKET Replaces: 912477</p>	<p>PKG. OF 2</p>  <p>18-0673 18-0673-9^① EXHAUST ELBOW GASKET Replaces: 910113</p>	<p>PKG. OF 2</p>  <p>18-0943-2 18-0943-2-9^① EXHAUST ELBOW GASKET Replaces: 913783, 909786, 3850496</p>	<p>PKG. OF 2</p>  <p>18-2850-1 18-2850-9^① MANIFOLD END CAP GASKET Replaces: 908935</p>
<p>PKG. OF 2</p>  <p>18-2859 18-2859-9^① MANIFOLD END CAP GASKET Replaces: 311131</p>	<p>PKG. OF 2</p>  <p>18-2860 18-2860-9^① MANIFOLD END CAP GASKET Replaces: 311130</p>	<p>PKG. OF 2</p>  <p>18-2861-1 18-2861-9^① MANIFOLD END CAP GASKET Replaces: 311121</p>	<p>PKG. OF 2</p>  <p>18-2875-1 18-2875-1-9^① EXHAUST ELBOW GASKET Replaces: 908013, 3850495</p>
<p>PKG. OF 2</p>  <p>18-2883-1 18-2883-1-9^① MANIFOLD END CAP GASKET Replaces: 907775</p>	 <p>18-2541 RUBBER SEAL Replaces: 911704</p>	 <p>18-0401 EXHAUST MANIFOLD GASKET Replaces: 913393 For Ford 140 CID (2.3L)</p>	 <p>18-0431 INTAKE MANIFOLD GASKET Replaces: 912471 For Ford 140 CID (2.3L)</p>
 <p>18-0956-1 EXHAUST MANIFOLD GASKET Replaces: 912405 460 CID</p>	 <p>18-2912-1 EXHAUST MANIFOLD GASKET Replaces: 908079</p>	 <p>18-2830-1 EXHAUST MANIFOLD GASKET Inline 6 cyl. Replaces: 907932</p>	 <p>18-2896-1 EXHAUST MANIFOLD GASKET Replaces: 311068</p>

① Priced per Package

<p>PKG. OF 2</p>  <p>18-2909 18-2909-9Ⓢ EXHAUST MANIFOLD GASKET Replaces: 915025 GM V-6</p>	 <p>18-0183-1 EXHAUST MANIFOLD GASKET Replaces: 3853742, 3852455, 908717, 916262 For: OMC 5.0L & 5.8L (1993-96)</p>	 <p>18-0680 EXHAUST MANIFOLD GASKET Replaces: 3853256</p>	 <p>18-0418 EXHAUST MANIFOLD GASKET Replaces: 909613</p>
<p>PKG. OF 2</p>  <p>18-1204-1 18-1204-1-9Ⓢ EXHAUST MANIFOLD GASKET Replaces: 912164</p>	 <p>18-0892 DEFLECTOR HOSE Replaces: 322411</p>	 <p>18-0664 VALVE COVER GASKET Replaces: 913270, 3852687 For: GM 305/350, 5.0 & 5.7L</p>	 <p>18-2845 VALVE COVER GASKET Replaces: 912965 For GM 305/350 CID (5.0L and 5.7L)</p>
 <p>18-0311 VALVE COVER GASKET Replaces: 3854942 For: 4.3 Litre 262 CID</p>	 <p>18-0346 VALVE COVER GASKET Replaces: 3930912 For: GM 250 CID (4.1L), 160/165/200 (6 cyl.)</p>	 <p>18-0347 VALVE COVER GASKET Replaces: 3852693, 912981, 913277 For: GM 153 & 181 CID (2.5L & 3.0L)</p>	<p>PKG. OF 2</p>  <p>18-0464 18-0464-9Ⓢ VALVE COVER GASKET Replaces: 912768 For: GM 454/502 CID (7.4L & 8.2L)</p>
 <p>18-0352 VALVE COVER GASKET Replaces: 913758 For: Ford 302/351 CID (5.0L & 5.8L)</p>	 <p>18-0548 ADAPTER TO INTERMEDIATE HOUSING GASKET Replaces: 909515</p>	<p>PKG. OF 2</p>  <p>18-0947 18-0947-9Ⓢ PIVOT CAP COVER GASKET Replaces: 909529</p>	<p>PKG. OF 2</p>  <p>18-0440 18-0440-9Ⓢ WATER PASSAGE GASKET Replaces: 915719</p>
 <p>18-0911 WATER PUMP GASKET Replaces: 911698</p>	<p>PKG. OF 2</p>  <p>18-0903 18-0903-9Ⓢ WATER PUMP GASKET Replaces: 3853361 454 CID</p>	 <p>18-0147 WATER PUMP GASKET For Ford V-8 Replaces: 3852824</p>	 <p>18-0327 WATER PUMP GASKET Replaces: 3853342 4 & 6 Cyl.</p>

Ⓢ Priced per Package

<p>PKG. OF 2</p>  <p>18-2916 18-2916-9^① WATER PUMP HOUSING GASKET Replaces: 911702</p>	<p>18-0939 18-0939-9^① UPPER GEARCASE DIPSTICK GASKET Replaces: 315189</p> 	<p>18-0468 TIMING COVER GASKET Replaces: 3853512, 912954, 3852654, 915326 For: OMC 2.6L, 3.5L (1989), 4.3L (1987-93), 5.0L (1987-88), 5.7L (1987-92, 1994, 1996)</p> 	<p>PKG. OF 2</p>  <p>18-0891 18-0891-9^① WATER PUMP MOUNTING GASKET Replaces: 3852477, 909835 For: GM 4.3L, 5.0L & 5.8L</p>
<p>PKG. OF 2</p>  <p>18-0893 18-0893-9^① WATER PUMP BACK-IN PLATE GASKET Replaces: 3850595 GM 4.3L, 5.0L & 5.7L</p>	<p>PKG. OF 2</p>  <p>18-0322 18-0322-9^① REAR SEAL GASKET Replaces: 3852656 GM 5.0L & 5.7L</p>	<p>18-0329 PUSH ROD/LIFTER COVER GASKET</p> 	<p>PKG. OF 2</p>  <p>18-0887 18-0887-9^① TIMING COVER GASKET Replaces: 3852691, 912988, 913275 4 & 6 Cyl.</p>
<p>18-0980 TIMING COVER GASKET Replaces: 3935449 GM 7.4L</p> 	<p>PKG. OF 2</p>  <p>18-0880 18-0880-9^① SHIFT COVER GASKET Replaces: 911878</p>	<p>PKG. OF 2</p>  <p>18-0166 18-0166-9^① GROMMET Replaces: 911705</p>	<p>18-2815 PUSH ROD COVER GASKET Replaces: 3852692, 913276 For: 3.0L</p> 
<p>18-0190 WIPER GASKET Replaces: 912157</p> 	<p>PKG. OF 2</p>  <p>18-2851 18-2851-9^① SWIVEL BEARING GASKET Replaces: 313368</p>	<p>PKG. OF 2</p>  <p>18-2863 18-2863-9^① TILT CLUTCH COVER GASKET Replaces: 308799</p>	<p>PKG. OF 2</p>  <p>18-2911 18-2911-9^① SWIVEL BEARING HOUSING GASKET Replaces: 910236</p>

① Priced per Package

<p>PKG. OF 5</p>  <p>18-2918 18-2918-9① OUTDRIVE GASKET Replaces: 911836, 915840</p>	<p>PKG. OF 5</p>  <p>18-2996 18-2996-9① OUTDRIVE SEAL Replaces: 911823, 3852560</p>	<p>PKG. OF 2</p>  <p>18-0923 18-0923-9① RUBBER SEAL Replaces: 313244</p>	<p>PKG. OF 2</p>  <p>18-0188 18-0188-9① WASHER Replaces: 909748</p>
 <p>18-1704 SCREW Replaces: 331980 For: Waterpumps, power packs (1985-96)</p>	 <p>18-1236 DRAIN SCREW Replaces: 309243 For Cobra Drives & V-6 40-50HP (1989-97)</p>  <p>18-2387 18-2387-9① (PKG. OF 50) LOWER UNIT DRAIN SCREW Replaces: 307551 Fits: OMC V-6, V-4(1979 & Up), 60-75hp 3 cylinder, 20-35hp (1985-97)</p>	 <p>18-2378 18-2378-9① (PKG. OF 50 without washer) MAGNETIC DRAIN SCREW Replaces: 318544 Fits: Cobra 2.3, 3.0, 3.8 & 5.8L (1986-92), V-6, V-4(1979 & Up), 60-75hp 3 cyl, 40/50hp (1989-98)</p>	<p>PKG. OF 5</p>  <p>18-4253-9① 18-4253-9① (PKG. OF 50) DRAIN SCREW O-RING Replaces: 336982 Used w/ 18-1236 Drain Screw</p>
<p>PKG. OF 2</p>  <p>18-2945 18-2945-9① DRAIN SCREW GASKET Replaces: 307552</p>	 <p>18-8369 OIL INDICATOR WITH WASHER Replaces: 914488 Uses o-ring 18-7116 Fits: OMC Cobra (1986-93) without cone clutch</p>	<p>PKG. OF 5</p>  <p>18-4248 18-4248-9① 18-4248-9① (PKG. OF 50) DRAIN/FILL PLUG WASHER (Plastic) Replaces: 311598</p>	<p>PKG. OF 5</p>  <p>18-4250 18-4250-9① WASHER Replaces: 911820</p>
 <p>18-0549 PLUG OFF CAP Replaces: 909829 I.D. 1" For V-8 Model Stern Drives and Inboards (1977 to present)</p>	 <p>18-0550 PLUG OFF CAP Replaces: 909830 I.D. 1 1/4" For V-8 Model Stern Drives and Inboards 1977 to present</p>	 <p>18-0518 VALVE STEM SEAL Replaces: 3854956, 914323, 3853132 For: most inline 4 and 6 cyl. GM (Early) and 305-350 CID GM</p>	<p>PKG. OF 8</p>  <p>18-4024 18-4024-9① VALVE STEM SEAL Replaces: 3853226, 914445 For: Chevy 4.3L/5.0L/5.7L</p>

① Priced per Package

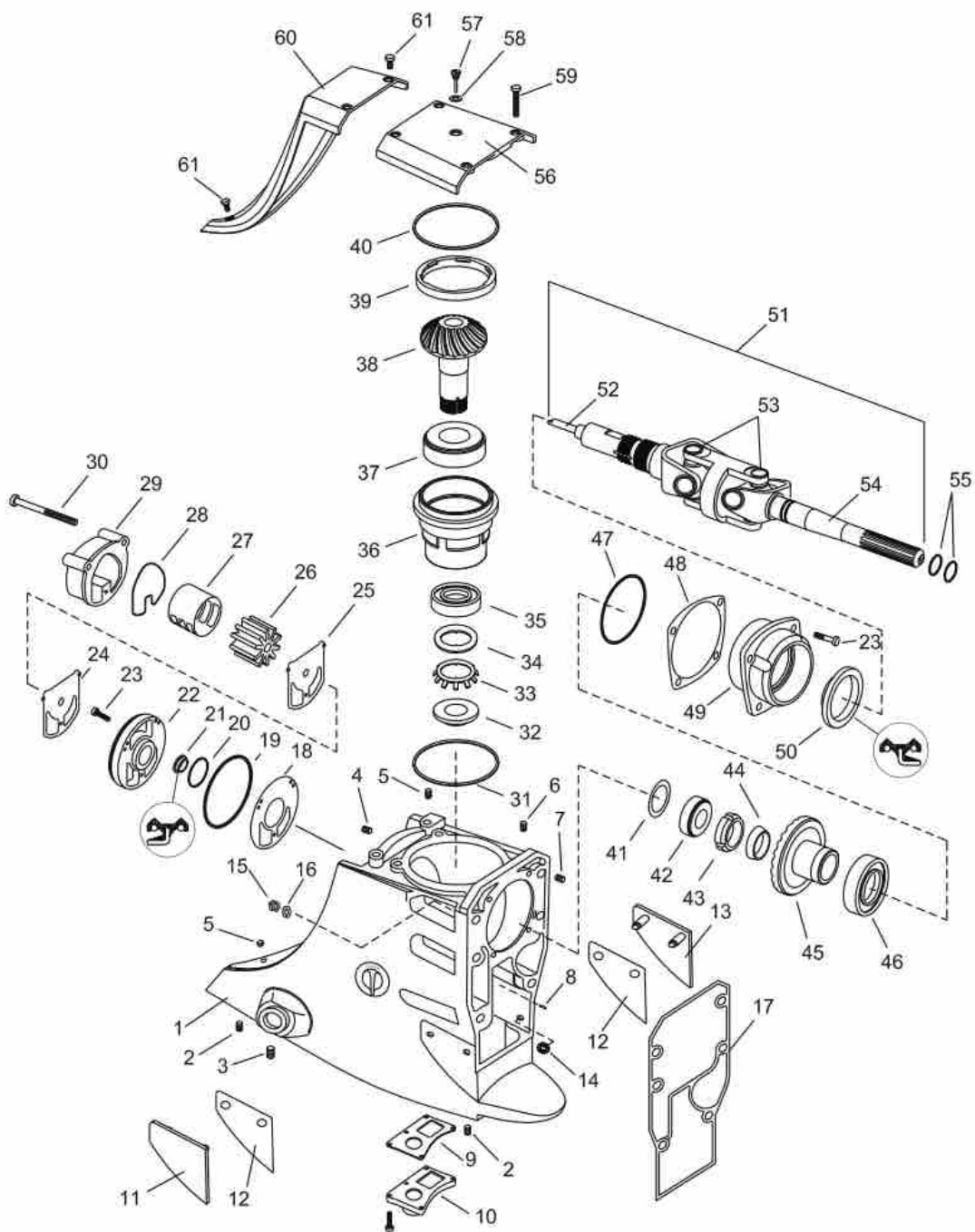

Figure #	Description	Part #	O.E.M. #	Qty.	Figure #	Description	Part #	O.E.M. #	Qty.
1	Upper Gear Housing, Basic w/ Inserts	-	984518	1	32	Pinion Nut	18-3769	911753	1
2	Gearcase Insert	NSS	910935	5	33	Nut Retainer	18-3610	911752	1
3	Gearcase Insert	NSS	911779, 3852541	5	34	Pinion Washer	NSS	911697	1
4	Gearcase Insert	NSS	910901	5	35	Pinion Bearing, Lower	18-1170	983892	1
5	Gearcase Insert	NSS	911858, 3852567	3	36	Bearing Carrier, Pinion	18-4828	911750	1
6	Gearcase Insert	NSS	910901	4	37	Pinion Bearing, Upper	18-1161	983891	1
7	Gearcase Insert	NSS	910901	4	38	Gear Set, 21:16 (includes 38 & 45)	18-1600	983825	AR
8	Shift Rod Guide	NSS	912137	1	38	Gear Set, 21:18 (includes 38 & 45)	18-1601	983826	AR
9	Gasket, Water Passage Cover	18-0894	911733	1	38	Gear Set, 21:19 (includes 38 & 45)	NSS	984012	AR
10	Water Passage Cover	18-4837	911734	1	39	Retainer Ring, Pinion Housing	18-3768	911751	1
11	Thrust Plate, Starboard	NSS	911838, 3852562	1	40	O-Ring, Gear Housing Cover	18-7107	313175	1
12	Shim, Thrust Plate, 0.015"	18-1713	911839, 3852563	AR	41	Shim, Gear Position, 0.003"	18-02062	911662	AR
13	Thrust Plate, Port	NSS	911837, 3852561	1	41	Shim, Gear Position, 0.005"	18-02063	911663	AR
14	Retainer Ring, Thrust Plate	NSS	910953	4	41	Shim, Gear Position, 0.007"	NSS	911664	AR
15	Nut	18-3730	912920, 3852648	6	41	Shim, Gear Position, 0.010"	18-02065	911665	AR
16	Washer	NSS	911833	6	41	Shim, Gear Position, 0.012"	18-02066	911666	AR
17	Gasket, Outdrive Mounting	18-2918	911836, 915840	1	41	Shim, Gear Position, 0.015"	18-02067	911667	AR
18	Gasket, Adapter to Gear Housing	18-0911	911698	1	42	Bearing, U-Joint Shaft	18-1171	983878	1
19	O-Ring, Adapter, Large	18-7407	911700	1	43	Nut, Gear to U-Joint	18-3770	911937	1
20	O-Ring, Adapter, Small	18-7403	909316	1	44	Centering Cone	18-4835	912029	1
21	Water Pump Shaft Seal	18-2068	911701, 915702, 916058, 3853655	1	45	Gear Set, 21:16 (includes 38 & 45)	18-1600	983825	AR
22	Adapter, Water Pump to Gear Housing	18-4836	911699	1	45	Gear Set, 21:18 (includes 38 & 45)	18-1601	983826	AR
23	Screw	18-1598	908668, 341013	6	45	Gear Set, 21:19 (includes 38 & 45)	NSS	984012	AR
24	Gasket, Plate to Adapter	18-2916	911702	1	46	Bearing, Bearing Carrier	18-1172	983877	1
25	Plate, Water Pump	18-3121	911703	1	47	O-Ring, Bearing Carrier	18-7169	911686	1
26	Impeller	18-3058	983895, 777128	1	48	Shim, Bearing Carrier, 0.003", Green	18-0227	911678	AR
27	Liner, Water Pump Cover	18-3145	911844	1	48	Shim, Bearing Carrier, 0.004", Tan	18-0229	911679	AR
28	Seal, Water Pump Housing	18-2541	911704	1	48	Shim, Bearing Carrier, 0.005", Blue	18-02060	911680	AR
29	Impeller Housing	18-3206	984744	1	48	Shim, Bearing Carrier, 0.010", Brown	18-02061	911681	AR
30	Screw	NSS	912238	3	49	Gear Bearing Carrier	18-4838	911683	1
31	Shim, Bearing Carrier 0.010	18-0207	911668	AR	50	Seal, Bearing Carrier	18-2067	911685	1
31	Shim, Bearing Carrier 0.001	18-0209	911669, 911670, 611671, 911672, 911673, 911674, 911675, 911676, 911677	AR	51	U-Joint & Water Pump Shaft Assy	18-2338	983880	1
					52	Stub & Water Pump Shaft	18-6399	984264	1
					53	U-Joint Assy	18-2104	912214	2
					54	Yoke Shaft	18-2146	912212	1
					55	O-Ring, U-Joint Shaft	18-7153	911851, 3852565	2
					56	Gear Housing Cover	18-4838	911845, 986363	1
					57	Oil Indicator	18-8369	914488	1
					58	O-Ring, Oil Indicator	18-7116	303067	1
					59	Screw, Gear Housing Cover	18-1599	123018	4
					60	Cover, Water Pump Access	18-4750	983967	1
31	Shim, Bearing Carrier 0.003	18-0211	911669, 911670, 611671, 911672, 911673, 911674, 911675, 911676, 911677	AR	61	Screw, Water Pump Access Cover	18-4749-9	911859, 3852568	3
						Water Pump Repair Kit w/housing	18-3348	984461, 984744	1

AR As required

NSS Not Sold Separate



GEAR HOUSINGS

Part No.	OE No.	Description	Application
18-4804	984770, 986381	Upper Gear Housing Complete, 21: 16 Ratio	5.7L(1986-93), 5.8L(1986-89,1991-93)
18-4805	984771, 986382	Upper Gear Housing Complete, 21: 18 Ratio	2.5L (1986-89), 3.0L(1986-93), 5.0L(1989-93)
18-4806	984765, 986380	Upper Gear Housing Complete, 21: 19 Ratio	4.3L, 3.0L high altitude OMC Cobra (1986-93)



SCREWS

Part No.	OE No.	Application
18-1279	317624	20, 25, 35 HP (1978-86) 120, 140, 275, 300 HP (1986-86) Cobra Drives
18-1598	341013	Fits: OMC Cobra (1986-93) without cone clutch
18-1599	123018	Fits: OMC Cobra (1986-93) without cone clutch
18-3135	306643	Cobra Drives
18-4749-9	3852568	For Cover Assembly: (3 Pack)(Fits: 2.3L (1987-90), 2.5L (1986), 2.6L (1989), 3.0L (1986-93), 4.3L (1986-93), 5.0L (1986-94), 5.7L (1986-92), 5.8L (1989-93), 7.4L (1988)

① PKG of 3, priced per package



**18-4801
COMPLETE LOWER UNIT ASSEMBLY**
Replaces: 5000356
Fits: 85-140hp Crossflow (1978-94) w/o Upper Driveshaft
Primered only



SHIMS

Part No.	O.E. No.	Size	Part No.	O.E. No.	Size
18-0207	① 911668	0.010	18-02065	③ 911665	0.010
18-0209	① 911669, 911670, 911671, 911672, 911673, 911674, 911675, 911676, 911677	0.001	18-02066	③ 911666	0.012
18-0211	① 911669, 911670, 911671, 911672, 911673, 911674, 911675, 911676, 911678	0.003	18-02067	③ 911667	0.015
18-0227	① ② 911678	0.003	18-2229	323362	0.003
18-0229	① ③ 911679	0.004	18-2230	323361	0.004
18-1713	① 3852563	0.015	18-2231	314745	0.005
18-02060	① ④ 911680	0.005			
18-02061	① ⑤ 911681	0.010			
18-02062	① 911662	0.003			
18-02063	① 911663	0.005			

- ① Fits: OMC Cobra (1986-93) without cone clutch
- ② Green
- ③ Tan
- ④ Blue
- ⑤ Brown
- ⑥ Kit includes 1 each of 18-2229, 18-2230 & 18-2231

NOTE: For shim sizes larger than .010" use shim 18-0207 and appropriate combination of .001" shim (18-0209), and .003" shim (18-0211) to reach desired shim thickness.



**18-9876
SHIM GAUGE TOOL**
Replaces: 349957

**MARINE GRADE 316 STAINLESS STEEL
WORM GEAR HOSE CLAMPS**

All components are manufactured from Marine Grade 316 stainless steel.
These clamps are designed to fit many applications from 3/4" to 7" diameter hoses.



STAINLESS STEEL CLAMPS

Part #	Diameter Size	Std. #	Part #	Diameter Size	Std. #
18-710-06-2	5/16" to 7/8"	006	118-710-32-2	1 9/16" to 2 1/2"	032
118-710-10-2	9/16" to 1 1/16"	010	118-710-48-2	2 9/16" to 3 1/2"	048
18-710-12-2	9/16" to 1 1/4"	012	18-710-64-2	2 1/2" to 4 1/2"	064
18-710-16-2	1 1/16" to 1 1/2"	016	18-710-72-2	3" to 5"	072
118-710-20-2	3/4" to 1 3/4"	020	118-710-104-2	5" to 7"	104
118-710-24-2	1 1/16" to 2"	024			



**18-4442
ENGINE ALIGNMENT TOOL**
Used to verify engine alignment on Cobra models.



**18-2100
LINK BELT HEAVY
DUTY GIMBAL BEARING**
Replaces: 983937
Uses seal 18-8349
Fits all OMC Cobra and King Cobra Drives



**18-3763
SHIFT SHAFT**
Replaces: 322941
For: V-4/V-6, Cobra, Stringer



**18-2337
STUB SHAFT**
Replaces: 3850814

Fits: All Cobra 1994-Up except King Cobra



**18-6399
SHAFT & STUB ASSEMBLY**

Replaces: 984264
For: Cobra Drives- 232, 302(1986-90), 252(1986), 262, 350, 460(1989), 432, 434, 502(1986-92), 504(1986-88), 574(1986-92), 584(1989-93), 754(1987-88)



**18-2104
U-JOINT
Heavy Duty**

Replaces: 912214, 915716
Fits OMC Cobra Drives (1986-89) Includes straight grease fitting and 90° fitting



**18-2174
U-JOINT
Heavy Duty**

Replaces: 915717, 3850812
Fits OMC Cobra and King Cobra Drives (1990 & ABOVE)
Includes straight grease fitting and 90° fitting.



**18-2338
U-JOINT**

Replaces: 983880
For: 1986-93 OMC Cobra



**18-2339
U-JOINT ASSEMBLY**

Replaces: 3852384
Fits: All Cobra 1994-Up except King Cobra



**18-2146
UNIVERSAL YOKE ASSEMBLY**

Replaces: 912212, 3850815
For: All Cobra (1986-Up)



**18-3770
U-JOINT NUT**

Replaces: 911937
For: 232, 252, 262, 302, 350, 432, 434, 460, 502, 504, 574, 584, 744, 754, (1987-93)

Model	Year	U-Joint #	U-Joint Assy. OE #	Long Yoke #	Long Yoke OE #	Short Yoke #	Short Yoke OE #
2.3L	1986 ①	18-2338	983880	18-2146	912212	18-6399	984264
3.0L	1986 ①	18-2338	983880	18-2146	912212	18-6399	984264
4.3L	1986 ①	18-2338	983880	18-2146	912212	18-6399	984264
5.7L	1986 ①	18-2338	983880	18-2146	912212	18-6399	984264
2.3L	1987-1988 ①	18-2338	983880	18-2146	912212	18-6399	984264
3.0L	1987-1988 ①	18-2338	983880	18-2146	912212	18-6399	984264
4.3L	1987-1988 ①	18-2338	983880	18-2146	912212	18-6399	984264
5.0L	1987-1988 ①	18-2338	983880	18-2146	912212	18-6399	984264
5.7L	1987-1988 ①	18-2338	983880	18-2146	912212	18-6399	984264
7.5L	1987-1988 ①	18-2338	983880	18-2146	912212	18-6399	984264
2.3L	1989 ①	18-2338	983880	18-2146	912212	18-6399	984264
3.0L	1989 ①	18-2338	983880	18-2146	912212	18-6399	984264
4.3L	1989 ①	18-2338	983880	18-2146	912212	18-6399	984264
5.0L	1989 ①	18-2338	983880	18-2146	912212	18-6399	984264
5.7L	1989 ①	18-2338	983880	18-2146	912212	18-6399	984264
7.5L	1989 ①	18-2338	983880	18-2146	912212	18-6399	984264
2.3L	1990 ②	18-2338	983880	18-2146	912212	18-6399	984264
3.0L	1990 ②	18-2338	983880	18-2146	912212	18-6399	984264
4.3L	1990 ②	18-2338	983880	18-2146	912212	18-6399	984264
5.0L	1990 ②	18-2338	983880	18-2146	912212	18-6399	984264
5.7L	1990 ②	18-2338	983880	18-2146	912212	18-6399	984264
5.8L	1990 ②	18-2338	983880	18-2146	912212	18-6399	984264

APPLICATION CONTINUED ON NEXT PAGE

① Used where raw w/p is located on outdrive ② Used where raw w/p is located on engine ③ Excludes Model 58FBDPMDA, used where raw w/p is located on engine
④ Used where raw w/p is located on engine, incl. Model 58FBDPMDA

Model	Year	U-Joint #	U-Joint Assy. OE #	Long Yoke #	Long Yoke OE #	Short Yoke #	Short Yoke OE #
6.7L	1990 ①	18-2338	983880	18-2146	912212	18-6399	984264
7.4L	1990 ①	18-2338	983880	18-2146	912212	18-6399	984264
7.5L	1990 ①	18-2338	983880	18-2146	912212	18-6399	984264
3.0L	1991 ①	18-2338	983880	18-2146	912212	18-6399	984264
4.3L	1991 ①	18-2338	983880	18-2146	912212	18-6399	984264
5.7L	1991 ①	18-2338	983880	18-2146	912212	18-6399	984264
5.8L	1991 ①	18-2338	983880	18-2146	912212	18-6399	984264
7.4L	1991 ②	N/A	986191	18-2146	912212	N/A	914646
3.0L	1992-1993 ①	18-2338	983880	18-2146	912212	18-6399	984264
3.2L	1992-1993 ①	18-2338	983880	18-2146	912212	18-6399	984264
4.3L	1992-1993 ①	18-2338	983880	18-2146	912212	18-6399	984264
5.0L	1992-1993 ①	18-2338	983880	18-2146	912212	18-6399	984264
5.7L	1992-1993 ①	18-2338	983880	18-2146	912212	18-6399	984264
5.9L	1992-1993 ①	18-2338	983880	18-2146	912212	18-6399	984264
3.0L	1992-1993 ②	N/A	986191	18-2146	912212	N/A	914646
3.2L	1992-1993 ②	N/A	986191	18-2146	912212	N/A	914646
4.3L	1992-1993 ②	N/A	986191	18-2146	912212	N/A	914646
5.0L	1992-1993 ②	N/A	986191	18-2146	912212	N/A	914646
5.7L	1992-1993 ②	N/A	986191	18-2146	912212	N/A	914646
5.9L	1992-1993 ②	N/A	986191	18-2146	912212	N/A	914646
7.4L	1992-1993 ②	N/A	986191	18-2146	912212	N/A	914646
8.2L	1992-1993 ②	N/A	986191	18-2146	912212	N/A	914646
3.0L	1994 ③	18-2339	3852384	18-2146	3850815	18-2337	3850814
4.3L	1994 ③	18-2339	3852384	18-2146	3850815	18-2337	3850814
5.0L	1994 ③	18-2339	3852384	18-2146	3850815	18-2337	3850814
5.7L	1994 ③	18-2339	3852384	18-2146	3850815	18-2337	3850814
5.8L	1994 ③	18-2339	3852384	18-2146	3850815	18-2337	3850814
5.9L	1994 ④	N/A	3853937	18-2146	3850815	N/A	3853563
7.4L	1994 ④	N/A	3853937	18-2146	3850815	N/A	3853563
3.0L	1995 ⑤	18-2339	3852384	18-2146	3850815	18-2337	3850814
4.3L	1995 ⑤	18-2339	3852384	18-2146	3850815	18-2337	3850814
5.0L	1995 ⑤	18-2339	3852384	18-2146	3850815	18-2337	3850814
5.8L	1995 ⑤	18-2339	3852384	18-2146	3850815	18-2337	3850814
7.4L	1995 ⑤	N/A	3853937	18-2146	3850815	N/A	3853563
3.0L	1996 ⑥	18-2339	3852384	18-2146	3850815	18-2337	3850814
4.3L	1996 ⑥	18-2339	3852384	18-2146	3850815	18-2337	3850814
5.0L	1996 ⑥	18-2339	3852384	18-2146	3850815	18-2337	3850814
5.7L	1996 ⑥	18-2339	3852384	18-2146	3850815	18-2337	3850814
5.9L	1996 ⑥	18-2339	3852384	18-2146	3850815	18-2337	3850814
7.4L	1996 ⑥	18-2339	3852384	18-2146	3850815	18-2337	3850814
3.0L	1997 ⑦	18-2339	3852384	18-2146	3850815	18-2337	3850814
4.3L	1997 ⑦	18-2339	3852384	18-2146	3850815	18-2337	3850814
5.7L	1997 ⑦	18-2339	3852384	18-2146	3850815	18-2337	3850814
7.4L	1997 ⑦	18-2339	3852384	18-2146	3850815	18-2337	3850814
3.0L	1998 ⑧	18-2339	3852384	18-2146	3850815	18-2337	3850814
4.3L	1998 ⑧	18-2339	3852384	18-2146	3850815	18-2337	3850814
5.0L	1998 ⑧	18-2339	3852384	18-2146	3850815	18-2337	3850814
5.7L	1998 ⑧	18-2339	3852384	18-2146	3850815	18-2337	3850814
7.4L	1998 ⑧	18-2339	3852384	18-2146	3850815	18-2337	3850814
8.2L	1998 ⑧	18-2338	3852384	18-2146	3850815	18-2337	3850814
43APHUB	1995	18-2339	3852384	18-2146	3850815	18-2337	3850814
43FAPMCA	1995	18-2339	3852384	18-2146	3820815	18-2337	3850814
43FBPBYC	1998	18-2339	3852384	18-2146	3820815	18-2337	3850814
43FBPLKD	1997	18-2339	3852384	18-2146	3820815	18-2337	3850814
43FBPNCS	1996	18-2339	3852384	18-2146	3820815	18-2337	3850814
50FBPBYC	1998	18-2339	3852384	18-2146	3820815	18-2337	3850814
50FACPMDA	1994	18-2339	3852384	18-2146	3820815	18-2337	3850814

APPLICATION CONTINUED ON NEXT PAGE

① Used where raw w/p is located on outdrive ② Used where raw w/p is located on engine ③ Excludes Model 58FBPMDA, used where raw w/p is located on engine
 ④ Used where raw w/p is located on engine, incl. Model 58FBPMDA

Model	Year	U-Joint #	U-Joint Assy. OE #	Long Yoke #	Long Yoke OE #	Short Yoke #	Short Yoke OE #
50FACPMDM	1994	18-2339	3852384	18-2146	3820815	18-2337	3850814
50FACPMDA	1994	18-2339	3852384	18-2146	3820815	18-2337	3850814
50FAPMDM	1994	18-2339	3852384	18-2146	3820815	18-2337	3850814
50FAPHUB	1995	18-2339	3852384	18-2146	3850815	18-2337	3850814
50FAPHUE	1995	18-2339	3852384	18-2146	3850815	18-2337	3850814
50FAPNCA	1996	18-2339	3852384	18-2146	3820815	18-2337	3850814
50FAPNCS	1996	18-2339	3852384	18-2146	3820815	18-2337	3850814
50FBPBYC	1998	18-2339	3852384	18-2146	3820815	18-2337	3850814
57FAPLKD	1997	18-2339	3852384	18-2146	3850815	18-2337	3850814
57FAPNCA	1996	18-2339	3852384	18-2146	3850815	18-2337	3850814
57FAPNCS	1996	18-2339	3852384	18-2146	3850815	18-2337	3850814
57FCPBYC	1998	18-2339	3852384	18-2146	3820815	18-2337	3850814
57FCPBYD	1998	18-2339	3852384	18-2146	3820815	18-2337	3850814
57FCPLKD	1997	18-2339	3852384	18-2146	3850815	18-2337	3850814
57FCPLKD	1997	18-2339	3852384	18-2146	3850815	18-2337	3850814
58FACPMDA	1994	18-2339	3852384	18-2146	3820815	18-2337	3850814
58FACPMDM	1994	18-2339	3852384	18-2146	3820815	18-2337	3850814
58FAPMDA	1994	18-2339	3852384	18-2146	3820815	18-2337	3850814
58FAPMDM	1994	18-2339	3852384	18-2146	3820815	18-2337	3850814
58FAPHUB	1995	18-2339	3852384	18-2146	3820815	18-2337	3850814
58FAPHUE	1995	18-2339	3852384	18-2146	3820815	18-2337	3850814
58FBMDA	1994	18-2339	3852384	18-2146	3820815	18-2337	3850814
58FBPHUB	1995	18-2339	3852384	18-2146	3820815	18-2337	3850814
58FBPHUE	1995	18-2339	3852384	18-2146	3820815	18-2337	3850814
58FBPNCA	1996	18-2339	3852384	18-2146	3820815	18-2337	3850814
58FBPMDA	1994	18-2339	3852384	18-2146	3820815	18-2337	3850814
58FCPMDA	1996	18-2339	3852384	18-2146	3820815	18-2337	3850814
58FCPNCS	1996	18-2339	3852384	18-2146	3820815	18-2337	3850814
74FEPHUB	1995	18-2339	3852384	18-2146	3820815	18-2337	3850814
74FFPNCA	1996	18-2339	3852384	18-2146	3850815	18-2337	3850814
74FCPLKD	1997	18-2339	3852384	18-2146	3820815	18-2337	3850814
74FCPNCS	1996	18-2339	3852384	18-2146	3850815	18-2337	3850814
74FHPYC	1998	18-2339	3852384	18-2146	3820815	18-2337	3850814
74FHPBYC	1998	18-2339	3852384	18-2146	3820815	18-2337	3850814
74FJIBYC	1998	18-2339	3852384	18-2146	3820815	18-2337	3850814
74FJPYC	1998	18-2339	3852384	18-2146	3820815	18-2337	3850814
74FJIBYD	1998	18-2339	3852384	18-2146	3820815	18-2337	3850814
74FJPYD	1998	18-2339	3852384	18-2146	3820815	18-2337	3850814
82FCPBYC	1998	18-2339	3852384	18-2146	3820815	18-2337	3850814
302CCPMDA	1994	18-2339	3852384	18-2146	3820815	18-2337	3850814
302CCPMDA	1994	18-2339	3852384	18-2146	3820815	18-2337	3850814
302CMBYC	1998	18-2339	3852384	18-2146	3820815	18-2337	3850814
302CMBYM	1998	18-2339	3852384	18-2146	3820815	18-2337	3850814
302CMHUB	1995	18-2339	3852384	18-2146	3820815	18-2337	3850814
302CMLKD	1997	18-2339	3852384	18-2146	3850815	18-2337	3850814
302CMNCA	1996	18-2339	3852384	18-2146	3820815	18-2337	3850814
302CMNCS	1996	18-2339	3852384	18-2146	3820815	18-2337	3850814
302CPBYC	1998	18-2339	3852384	18-2146	3820815	18-2337	3850814
302CPBYM	1998	18-2339	3852384	18-2146	3820815	18-2337	3850814
302CPHUB	1995	18-2339	3852384	18-2146	3820815	18-2337	3850814
302CPLKD	1997	18-2339	3852384	18-2146	3850815	18-2337	3850814
302CPNCA	1996	18-2339	3852384	18-2146	3820815	18-2337	3850814
302CPNCS	1996	18-2339	3852384	18-2146	3820815	18-2337	3850814
302DCMMDA	1994	18-2339	3852384	18-2146	3820815	18-2337	3850814
302DGMMDA	1994	18-2339	3852384	18-2146	3820815	18-2337	3850814
432ACMMDA	1994	18-2339	3852384	18-2146	3820815	18-2337	3850814
432ACPMDA	1994	18-2339	3852384	18-2146	3820815	18-2337	3850814
432AGMMDA	1994	18-2339	3852384	18-2146	3820815	18-2337	3850814

APPLICATION CONTINUED ON NEXT PAGE

- ① Used where raw w/p is located on outdrive
- ② Used where raw w/p is located on engine
- ③ Excludes Model 58FBPMDA, used where raw w/p is located on engine
- ④ Used where raw w/p is located on engine, incl. Model 58FBPMDA

Model	Year	U-Joint #	U-Joint Assy. OE #	Long Yoke #	Long Yoke OE #	Short Yoke #	Short Yoke OE #
432AGPMDA	1994	18-2339	3852384	18-2146	3820815	18-2337	3850814
432APNCA	1995	18-2339	3852384	18-2146	3820815	18-2337	3850814
432BPLKD	1997	18-2339	3852384	18-2146	3820815	18-2337	3850814
432BPNC	1996	18-2339	3852384	18-2146	3820815	18-2337	3850814
502APHUB	1995	18-2339	3852384	18-2146	3820815	18-2337	3850814
502APHUE	1995	18-2339	3852384	18-2146	3820815	18-2337	3850814
432ACMMDA	1994	18-2339	3852384	18-2146	3820815	18-2337	3850814
432ACPMDA	1994	18-2339	3852384	18-2146	3820815	18-2337	3850814
432AGMMDA	1994	18-2339	3852384	18-2146	3820815	18-2337	3850814
432AGPMDA	1994	18-2339	3852384	18-2146	3820815	18-2337	3850814
432BPBYC	1998	18-2339	3852384	18-2146	3820815	18-2337	3850814
432BPLKD	1997	18-2339	3852384	18-2146	3820815	18-2337	3850814
434APNCA	1996	18-2339	3852384	18-2146	3820815	18-2337	3850814
434BPBYC	1998	18-2339	3852384	18-2146	3820815	18-2337	3850814
434BPLKD	1997	18-2339	3852384	18-2146	3820815	18-2337	3850814
434BPNC	1996	18-2339	3852384	18-2146	3820815	18-2337	3850814
502ACPMDA	1994	18-2339	3852384	18-2146	3820815	18-2337	3850814
502AGPMDA	1994	18-2339	3852384	18-2146	3820815	18-2337	3850814
502APHUB	1995	18-2339	3852384	18-2146	3850815	18-2337	3850814
502APHUE	1995	18-2339	3852384	18-2146	3850815	18-2337	3850814
502APNCA	1996	18-2339	3852384	18-2146	3820815	18-2337	3850814
502APNC	1996	18-2339	3852384	18-2146	3820815	18-2337	3850814
502BPBYC	1998	18-2339	3852384	18-2146	3820815	18-2337	3850814
572ACPMDA	1994	18-2339	3852384	18-2146	3820815	18-2337	3850814
572AGPMDA	1994	18-2339	3852384	18-2146	3820815	18-2337	3850814
572BPBYC	1998	18-2339	3852384	18-2146	3820815	18-2337	3850814
572BPLKD	1997	18-2339	3852384	18-2146	3820815	18-2337	3850814
572BPLKR	1997	18-2339	3852384	18-2146	3820815	18-2337	3850814
572BPNC	1996	18-2339	3852384	18-2146	3820815	18-2337	3850814
574BPLKD	1997	18-2339	3852384	18-2146	3820815	18-2337	3850814
584ACPMDA	1994	18-2339	3852384	18-2146	3820815	18-2337	3850814
584AGPMDA	1994	18-2339	3852384	18-2146	3820815	18-2337	3850814
584APHUB	1995	18-2339	3852384	18-2146	3820815	18-2337	3850814
584APHUE	1995	18-2339	3852384	18-2146	3820815	18-2337	3850814
584APNCA	1996	18-2339	3852384	18-2146	3820815	18-2337	3850814
584APNC	1996	18-2339	3852384	18-2146	3820815	18-2337	3850814
744DCPMDM	1994	18-2339	3852384	18-2146	3820815	18-2337	3850814
744DCPMDA	1994	18-2339	3852384	18-2146	3820815	18-2337	3850814
744DOPMDA	1994	18-2339	3852384	18-2146	3820815	18-2337	3850814
744DOPMDM	1994	18-2339	3852384	18-2146	3820815	18-2337	3850814
744DGPMDA	1994	18-2339	3852384	18-2146	3820815	18-2337	3850814
744DGPMDM	1994	18-2339	3852384	18-2146	3820815	18-2337	3850814
744DJPMDA	1994	18-2339	3852384	18-2146	3820815	18-2337	3850814
744DJPMDM	1994	18-2339	3852384	18-2146	3820815	18-2337	3850814
744DPHUB	1995	18-2339	3852384	18-2146	3820815	18-2337	3850814
744EPNCA	1996	18-2339	3852384	18-2146	3850815	18-2337	3850814
744FPLKD	1997	18-2339	3852384	18-2146	3850815	18-2337	3850814
744FPNC	1996	18-2339	3852384	18-2146	3850815	18-2337	3850814

Ⓜ Excludes Model 58FBPMDA, used where raw w/p is located on engine

Ⓜ Used where raw w/p is located on engine, incl. Model 58FBPMDA

**18-2772-1
TRANSOM
SEAL KIT**

For: SX Cobra Drives with cone clutch

— CONTAINS —

Part #	Description	O.E. #	Qty.
18-2100	Gimbal Bearing	3853807	1
18-2765	Bellows	3854127	1
18-1074	Bellows	3850426-2	1
18-2996	Seal	3852560, 911823	1
18-710-64-2	Hose Clamp	853012-3	1

**18-2771
BELLOWS KIT**
Replaces: 3854270

For: OMC Cobra without cone clutch

— CONTAINS —

Part #	Description	O.E. #
18-2613	Outdrive Gasket Set	—
18-2765	U-Joint Bellows	983973, 987467
18-2764	Exhaust Bellows	914036
18-2763	Shift Cable Bellows	911826
18-2100	Gimbal Bearing	983937
18-710-64-2	Hose Clamp	—



 <p>18-2128 CENTER SOCKET Replaces: 912213, 3850813 Fits all OMC Cobra</p>	 <p>18-2745 EXHAUST BOOT Replaces: 912374 Fits 5.7L & 7.5L (1986 & later)</p>	 <p>18-1074 EXHAUST BELLOW I.D. 2 5/8" x O.D. 3" x L 7.5" Replaces: 3850426 All cone clutch models (1994-up) not using exhaust boot</p>	 <p>18-2763 SHIFT CABLE BELLOWS Replaces: 911826 ALL COBRA</p>
 <p>18-2764 EXHAUST BELLOWS Replaces: 914036 All clutch dog Cobra models (1986-93)</p>	 <p>18-2765 U-JOINT BELLOWS I.D. 3 1/2" x O.D. 4" x L 6" Replaces: 983973, 987467, 3854127 All clutch dog Cobra models (1986-93)</p>	 <p>18-21754 ENGINE COUPLER Replaces: 986232, 984537 Fits: 7.5L / 460 King Cobra 1987-90</p>	 <p>18-21751 ENGINE COUPLER Replaces: 3853962, 983902, 986338 Fits: 2.5L (1986), 3.0L (1986-90), (4.3L, 5.0L, 5.7L) (1986) KW & KWB suffix only, 7.4L (1990-98), 8.2L (1992-93, 1998)</p>
 <p>18-21752-1 ENGINE COUPLER Replaces: 3858437, 984290, 986120, 3853917 Fits: 4.3L (1986-98), 5.0L (1986-88, 1998) 5.7 (1986-92, 1994, 1996-98)</p>	 <p>18-21753 ENGINE COUPLER Replaces: 3853862 Fits: 5.0L & 5.8L (1989-96)</p>	 <p>18-21755 ENGINE COUPLER Replaces: 984629 2.3L Cobra</p>	 <p>18-2533 TRANSOM SEAL Replaces: 911797</p>
 <p>18-2767 TRANSOM SEAL 16 hole Replaces: 313080 (1967-77) 120 HP and UP</p>	 <p>18-2768 TRANSOM SEAL 22 hole Replaces: 909527 (1978-86) — ALL</p>	 <p>18-2245-1 SHIFT CABLE ASSEMBLY Replaces: 987661 Wire: 68" • Jacket: 58 1/2" For: 1988-1993 OMC Cobra (except King) without cone clutch</p>	 <p>18-2246 SHIFT CABLE ASSEMBLY Replaces: 987678 Wire: 59" For: King Cobra</p>



**18-3769
PINION NUT**
Replaces: 911753
For: 115 (1984-97), 232 (1987-90),
252 (1986), 262, 350, 460 (1989),
302, 374 (1989-92), 432 (1986-93),
502 (1988-93), 504, 754 (1986-89),
584 (1989-93), 744 (1988), 90 Jet
(1994-95)



**18-3719
PINION NUT**
Replaces: 314730
(⁵/₈ - 18)



**18-2176
BALL GEAR
(Intermediate Housing)**
Replaces: 908063
1973-86



**18-2177
BALL GEAR
(Upper Gear Case)**
Replaces: 908069
1973-86

PKG. OF 5



**18-3725
18-3725-9①
BALL GEAR NUT**
Replaces: 908064

PKG. OF 2



**18-3731
18-3731-9①
LOCKNUT**
Replaces: 907866
³/₄ - 16

PKG. OF 5



**18-4251
18-4251-9①
PLUG**
Replaces: 908062
O.D. 1.748



**18-4835
CENTERING CONE**
Replaces: 912029
Fits: OMC Cobra (1986-93)
without cone clutch



**18-1750
COMPLETE BEARING
HOUSING**
For: Cobra Drives & V6



**18-1154
BALL BEARING**
Replaces:
377139



**18-1161
TAPERED ROLLER
BEARING**
Replaces: 983891



**18-1170
LOWER PINION BEARING**
Replaces: 983892



**18-1171
U-JOINT SHAFT
BEARING**
Replaces: 983878



**18-1172
CARRIER BEARING**
Replaces: 983877
For: 1986-95 Cobra



**18-1158
CARRIER BEARING**
Replaces: 387247



**18-1350
CARRIER BEARING**
Replaces: 379504



**18-1351
CARRIER BEARING**
Replaces: 382407
COBRA



**18-1117
PINION BEARING**
Replaces: 387817



**18-1357
PINION BEARING**
Replaces: 384195
COBRA



**18-1358
REVERSE GEAR
BEARING**
Replaces: 389039
COBRA



**18-1365
THRUST BEARING**
Replaces: 387656
COBRA DRIVE SHAFT



**18-1366
THRUST BEARING**
Replaces: 382408
COBRA REVERSE GEAR



**18-1370
THRUST FORWARD
BEARING**
Replaces: 389042



**18-1371
THRUST FORWARD
BEARING**
Replaces: 385043
COBRA

OMC 400 & 800 SERIES GEARCASE BEARINGS

HP	Year	Pinion Bearing	Drive Shaft Bearing	Carrier Aft Bearing	Carrier Fore Bearing	Forward Thrust Bearing	Reverse Thrust Bearing	Housing Bearing
120	1978-81	18-1357	18-1365	18-1350	18-1351	18-1371	18-1366	—
2.5L	1982-86	18-1357	18-1365	18-1350	18-1351	18-1371	18-1366	18-1351
140	1978-81	18-1357	18-1365	18-1350	18-1351	18-1371	18-1366	—
3.0L	1982-86	18-1357	18-1365	18-1350	18-1351	18-1371	18-1366	18-1351
185/3.8L	1978-85	18-1117	18-1365	18-1158	18-1351	18-1370	18-1366	18-1358
4.3L	1985-86	18-1117	18-1365	18-1158	18-1351	18-1370	18-1366	18-1358
200/5.0L	1979-86	18-1117	18-1365	18-1158	18-1351	18-1370	18-1366	18-1358
225	1978	18-1117	18-1365	18-1158	18-1351	18-1370	18-1366	18-1358
230/530L	1979-86	18-1117	18-1365	18-1158	18-1351	18-1370	18-1366	18-1358
240	1978	18-1117	18-1365	18-1158	18-1351	18-1370	18-1366	18-1358
250	1979	18-1117	18-1365	18-1158	18-1351	18-1370	18-1366	18-1358
260/5.7L	1979-86	18-1117	18-1365	18-1158	18-1351	18-1370	18-1366	18-1358

OMC COBRA GEAR HOUSING BEARINGS

Model	Liter	Year	Pinion Bearing	Drive Shaft Bearing	Carrier Aft Bearing	Carrier Fore Bearing	Forward Thrust Bearing	Reverse Thrust Bearing	Housing Bearing
2.3L	2.3L	1987	18-1357	18-1365	18-1350	18-1351	18-1371	18-1366	18-1351
2.3L	2.3L	1988-1990	18-1357	18-1365	18-1350	18-1351	18-1371	18-1366	N/A
2.5L	2.5L	1986	18-1357	18-1365	18-1350	18-1351	18-1371	18-1366	18-1351
3.0L	3.0L	1986-1987	18-1357	18-1365	18-1350	18-1351	18-1371	18-1366	18-1351
3.0L	3.0L	1988-1989	18-1357	18-1365	18-1350	18-1351	18-1371	18-1366	N/A
3.0L	3.0L	1990-1991	18-1117	18-1365	18-1158	18-1351	18-1370	18-1366	N/A
3.0L	3.0L	1992-1993	18-1117	18-1365	N/A	18-1351	18-1370	18-1366	N/A
3.0L HO	3.0L	1992-1993	18-1117	18-1365	N/A	18-1351	18-1370	18-1366	N/A
4.3L	4.3L	1986-1987	18-1117	18-1365	18-1158	18-1351	18-1370	18-1366	18-1358
4.3L	4.3L	1988-1991	18-1117	18-1365	18-1158	18-1351	18-1370	18-1366	N/A
4.3L	4.3L	1992-1993	18-1117	18-1365	N/A	18-1351	18-1370	18-1366	N/A
4.3L HO	4.3L	1992-1993	18-1117	18-1365	N/A	18-1351	18-1370	18-1366	N/A
5.0L	5.0L	1986-1987	18-1117	18-1365	18-1158	18-1351	18-1370	18-1366	18-1358
5.0L	5.0L	1988-1991	18-1117	18-1365	18-1158	18-1351	18-1370	18-1366	N/A
5.0L	5.0L	1992-1993	18-1117	18-1365	N/A	18-1351	18-1370	18-1366	N/A
5.0L HO	5.0L	1992-1993	18-1117	18-1365	N/A	18-1351	18-1370	18-1366	N/A
5.7L	5.7L	1986-1987	18-1117	18-1365	18-1158	18-1351	18-1370	18-1366	18-1358
5.7L	5.7L	1988-1991	18-1117	18-1365	N/A	18-1351	18-1370	18-1366	N/A
5.7L	5.7L	1992-1993	18-1117	18-1365	N/A	18-1351	18-1370	18-1366	N/A
5.8L	5.8L	1988-1991	18-1117	18-1365	N/A	18-1351	18-1370	18-1366	N/A
5.8L	5.8L	1992-1993	18-1117	18-1365	N/A	18-1351	18-1370	18-1366	N/A



18-0195
THRUST WASHER
Replaces: 314731
COBRA



18-0198
FORWARD GEAR THRUST WASHER
Replaces: 324766

PKG. OF 2



18-2243
18-2243-9
DETENT BALL
Replaces: 316506
For: V-4 & V-6 gearcase
OMC Sterndrive 400 Series (1978-79);
800 Series (1978)



18-1501
DETENT BALL
Replaces: 160084
For: Cobra drives (1980& Earlier)



18-1701
LOWER DRIVE SHAFT
Replaces: 911693
For: Cobra Drives 262, 302, 350,
432, 434, 502, 504, 574, 584



18-2183
DRIVE SHAFT
Replaces: 909121

① Priced per Package



18-2184
DRIVE SHAFT
Replaces: 908087



18-2185
DRIVE SHAFT
Replaces: 909753



18-2186
DRIVE SHAFT
Replaces: 982424
800 Drives



18-2187
PROP SHAFT
Replaces: 395209
Cobra & Late Model 800 Drives



18-2251
PROP SHAFT
Replaces: 435022, 433017, 436740



18-2252
PROP SHAFT
Replaces: 387818, 436888



18-2216
SLIDING CLUTCH
Replaces: 337772, 337774,
334516, 336562, 910995



18-2220
SLIDING CLUTCH
Replaces: 323664, 320630



18-2383
SLIDING CLUTCH
Replaces: 914716, 915272
For: 3.0L (GM), 4.3L (GM), 5.0L (Ford), 5.7L (Ford),
5.8L (Ford) (1990-91)



18-2218
FORWARD GEAR SET
Replaces: 434063, 987966,
985050, 436746



18-2219
REVERSE GEAR
Replaces: 333077,
317838, 340490



18-1600
UPPER GEAR KIT
with bearing
Replaces: 983825
For: 5.7, 5.8L V-8 Cobra drives (21:16 ratio)

18-1601
UPPER GEAR KIT
with bearing
Replaces: 983826
For: 5.0L V-8 engines-Cobra drives (21:1)



SHAFT/GEAR/SLIDING CLUTCH APPLICATION

Model	Year	Bearing Carrier Shaft	Short/Long Water Pump Shaft	Drive Shaft	Prop Shaft	Forward Gear	Reverse Gear	Sliding Clutch
100 thru 165	1973	—	18-2185	—	—	—	—	—
120 thru 190	1974-75	—	18-2185	—	—	—	—	—
120 thru 235 ⑤	1976-77	—	18-2184	—	—	—	—	—
120 thru 190 ⑤	1976	—	18-2185	—	—	—	—	—
120/140 ⑤	1977	—	18-2185	—	—	—	—	—
120/140	1978-81	18-2183	18-2185	—	18-2252	—	—	18-2220
120 thru 235 ⑤	1977	—	18-2184	—	—	—	—	—
175/190/235 ⑤	1977	18-2183	18-2185	—	—	—	—	—
185	1978	18-2183	18-2185	18-2186	—	—	—	—
185	1980-81	18-2183	18-2185	18-2186	—	—	—	—
200	1979	18-2183	18-2185	18-2186	—	—	—	—
200	1980-81	18-2183	18-2185	18-2186	—	—	—	—
225/245	1973-75	—	18-2184	—	—	—	—	—
225	1978	18-2183	18-2185	18-2186	—	—	—	—
225	1979	—	—	18-2186	—	—	—	—
225	1980	—	—	18-2186	—	—	—	—
225	1981	—	—	18-2186	—	—	—	—
230	1979	18-2183	18-2185	18-2186	—	—	—	—
230	1980-81	18-2183	18-2185	18-2186	—	—	—	—
235	1975	18-2183	18-2185	—	—	—	—	—
235 ⑤	1976-77	18-2183	18-2185	—	—	—	—	—
240	1978	18-2183	18-2185	18-2186	—	—	—	—
240	1979	—	—	18-2186	—	—	—	—
240	1980-81	—	—	18-2186	—	—	—	—
250	1979	18-2183	18-2185	18-2186	—	—	—	—
260	1979	18-2183	18-2185	18-2186	—	—	—	—
260	1980-81	18-2183	18-2185	—	—	—	—	—
262	1989	—	—	—	18-2187	—	—	—
2.3/3.0	1987-89	—	—	—	18-2252	—	18-2219	—
2.3	1990	—	—	—	18-2252	—	—	—
2.5	1986	18-2183	18-2185	—	18-2252	—	18-2219	—
2.5	1982-87	18-2183	18-2185	—	18-2252	18-2218	18-2219	—
350 ①	1988-89	—	—	—	18-2187	18-2218	—	—
3 ①	1982-86	18-2183	18-2185	—	18-2252	18-2218	18-2219	18-2216
3.0/4.3 ①	1990-91	—	—	—	18-2187	—	—	18-2383
3.0/4.3	1992-93	—	—	—	18-2251	—	—	18-2383
3.0 H.O.	1990-91	—	—	—	18-2187	—	—	18-2383
3.0 H.O.	1992-93	—	—	—	18-2251	—	—	18-2383
3.8	1982-86	18-2183	18-2185	18-2186	18-2187	—	—	18-2216
460 ①	1988-89	—	—	—	18-2187	—	—	18-2216
4.3 ①	1985-86	18-2183	18-2185	18-2186	18-2187	—	—	18-2216
4.3 ②	1986-87	—	—	—	18-2187	—	—	—
4.3 ③	1988-91	—	—	—	18-2187	—	—	18-2383 ⑤
4.3 H.O.	1990-91	—	—	—	18-2187	—	—	18-2383
4.3 H.O.	1992-93	—	—	—	18-2251	—	—	18-2383
5.0/5.7	1982-83	18-2183	18-2185	18-2186	—	—	—	18-2216
5.0/5.7 ①	1984-86	18-2183	18-2185	18-2186	18-2187	—	—	18-2216
5 ②	1986-87	—	—	—	18-2187	—	—	—
5	1988	—	—	—	18-2187	—	—	—
5 ③	1988-91	—	—	—	18-2187	—	—	18-2383 ⑤
5.0/5.7	1992	—	—	—	18-2251	—	—	18-2383
5.0 H.O.	1990-91	—	—	—	18-2187	—	—	18-2383
5.0 H.O.	1992-93	—	—	—	18-2251	—	—	18-2383
5.7	1987-88	—	—	—	18-2187	—	—	—
5.7 ③	1988-89	—	—	—	18-2187	—	—	—
5.7 ④ ③	1990-92	—	—	—	18-2187	—	—	18-2383
5.8 ③	1989-90	—	—	—	18-2187	—	—	18-2383 ⑤
5.8	1991	—	—	—	18-2187	—	—	18-2383
5.8	1992-93	—	—	—	18-2251	—	—	18-2383
7.5	1987	—	—	—	18-2187	—	—	18-2216

① Except Cobra
② Cobra

③ Right hand rotation drive
④ Low profile

⑤ High profile
⑥ Except L.E. models

⑦ 1990-93 models only



**18-1702
CARRIER BEARING**
Replaces: 438039, 5000074
For: 1 3/16" diameter prop shaft-Cobra drives (1986-90) Fits all stringer mounts except 2.5L & 3.0L (1978-85)



**18-1703
CARRIER BEARING**
Replaces: 434400, 435096, 438040, 5000363, 5004257
For: 1 1/4" diameter prop shaft-Cobra drives (1991-93)



18-4828
PINION BEARING CARRIER
 Replaces: 911750
 Fits: OMC Cobra (1986-93) without cone clutch



18-1099
BEARING HOUSING & SEAL ASSEMBLY
 Replaces: 982422
 For: OMC Stringer Drive-120, 140, 170, 200, 230, 260, (1981), 252, 302, 382, 502, 504 & 574 (1982-85), 432 (1985)



18-1343
BEARING CARRIER RETAINING TAB
 Replaces: 333957
 For: Cobra drives & V-6



18-0655
SHIFT ROD
 Replaces: 914736
 3.0L (1990-1993), 4.3L, 5.0L, 5.7L, 5.8L (1986-1993)



18-0647
SHIFT ROD ASSEMBLY
 Replaces: 986658
 3.0L (1990-1993), 4.3L, 5.0L, 5.7L, 5.8L (1986-1993)



18-0652
ROD END, SHIFT
 Replaces: 914723
 3.0L (1990-1993), 4.3L, 5.0L, 5.7L, 5.8L (1986-1993)



18-0653
SCREW, SHIFT ROD END
 Replaces: 308825
 3.0L (1990-1993), 4.3L, 5.0L, 5.7L, 5.8L (1986-1993)



18-0654
NUT, SHIFT ROD END
 Replaces: 914743
 3.0L (1990-1993), 4.3L, 5.0L, 5.7L, 5.8L (1986-1993)



18-3766
SHIFT CRADLE
 Replaces: 334163
 For: V-4/V-6, Cobra, Stringer



18-3610
RETAINER NUT
 Replaces: 911752
 Fits: OMC Cobra (1986-93) without cone clutch



18-3768
COVER NUT
 Replaces: 911751
 For: Cobra Drives 115 (1994-97), 232 (1987-90), 252 (1986) 262 (1989), 302 (1987)



18-1500
INTAKE WATER SCREEN
 Replaces: 337778
 For: 100, 120, 125, 140, 150, 175, 200, 225 (1993) (OMC Cobra & V6)



18-4750
COVER ASSEMBLY
 Replaces: 983967
 Fits: 2.3L (1987-90), 2.5L (1986), 2.6L (1989), 3.0L (1986-93), 4.3L (1986-93), 5.0L (1986-94), 5.7L (1986-92), 5.8L (1989-93), 7.4L (1988)



18-1714
CLUTCH DOG PIN
 Replaces: 313448
 For: 50-85, 100, 135, 140, 150, 175, 200, 235 (1969-82) (OMC Stringer drive)

 <p>18-2399 CLUTCH DOG Replaces: 324369 For: V-4 & V-6</p>	 <p>18-4222 THRUST WASHER Replaces: 318841</p>	 <p>18-4223 THRUST WASHER Replaces: 333592</p>	 <p>18-4228 PROP SPACER Replaces: 315810</p>											
 <p>18-4194 PROP SPACER Replaces: 3852350 For: 1994 King Cobra Lower Units</p>	 <p>18-4231 PROP SPACER Replaces: 320570</p>	<p>PKG. OF 5</p>  <p>18-3705 18-3705-9① PROP NUT Replaces: 314503</p>	 <p>18-3708-1 PROP NUT & KEEPER Replaces: 398042</p>											
 <p>18-3730 LOCK NUT Replaces: 3852648 For: Cobra & King Cobra 1987-94</p>	<p>② 18-3733D Display Package</p>  <p>18-3733 PROP NUT KIT For: SX Cobra</p>	<p>② 18-3715D Display Package</p>  <p>18-3715 PROP NUT KIT — CONTAINS —</p> <table border="1"> <thead> <tr> <th>Part #</th> <th>O.E. #</th> <th>Description</th> </tr> </thead> <tbody> <tr> <td>18-3708-1</td> <td>398042</td> <td>Prop Nut/Keeper</td> </tr> <tr> <td>18-3741</td> <td>309955</td> <td>Cotter Pin</td> </tr> <tr> <td>18-4231</td> <td>320570</td> <td>Prop Spacer</td> </tr> </tbody> </table>	Part #	O.E. #	Description	18-3708-1	398042	Prop Nut/Keeper	18-3741	309955	Cotter Pin	18-4231	320570	Prop Spacer
Part #	O.E. #	Description												
18-3708-1	398042	Prop Nut/Keeper												
18-3741	309955	Cotter Pin												
18-4231	320570	Prop Spacer												
<p>② 18-3716D Display Package</p>  <p>18-3716 PROP NUT KIT Replaces: 175267 — CONTAINS —</p> <table border="1"> <thead> <tr> <th>Part #</th> <th>O.E. #</th> <th>Description</th> </tr> </thead> <tbody> <tr> <td>18-3705</td> <td>314503</td> <td>Prop Nut</td> </tr> <tr> <td>18-3742</td> <td>314502</td> <td>Cotter Pin</td> </tr> <tr> <td>18-4238</td> <td>315810</td> <td>Prop Spacer</td> </tr> </tbody> </table>	Part #	O.E. #	Description	18-3705	314503	Prop Nut	18-3742	314502	Cotter Pin	18-4238	315810	Prop Spacer	 <p>18-4444 PROP WRENCH FOR ALL COBRA</p>	 <p>18-2156 TILT SHAFT Replaces: 980183 I/O 1964-86 EXCEPT COBRA</p>
Part #	O.E. #	Description												
18-3705	314503	Prop Nut												
18-3742	314502	Cotter Pin												
18-4238	315810	Prop Spacer												
<p>PKG. OF 10</p>  <p>COTTER PINS</p> <table> <tr> <td>18-3741</td> <td>18-3742</td> </tr> <tr> <td>18-3741-9①</td> <td>18-3742-9①</td> </tr> <tr> <td>Replaces: 309955</td> <td>Replaces: 314502</td> </tr> </table>	18-3741	18-3742	18-3741-9①	18-3742-9①	Replaces: 309955	Replaces: 314502	 <p>18-9098 TRAILING CLIPS Replaces: 174448 Set of 2 For all Cobra Stern Drives</p>  <p>Display Package</p>							
18-3741	18-3742													
18-3741-9①	18-3742-9①													
Replaces: 309955	Replaces: 314502													
<p style="text-align: center;">APPLICATION BEGINS ON NEXT PAGE</p> <p>① Priced per Package ② Items ending in "D" are Display Packaged - Regular number is Non-Display</p>														

NUT/SPACER/WASHER/COTTER PIN/PROP NUT KIT APPLICATION

Model	Year	Nut	Spacer	Washer	Cotter Pin	Prop Nut Kit	Model	Year	Nut	Spacer	Washer	Cotter Pin	Prop Nut Kit
120	1978-81	18-3705	18-4228	18-4222	18-3742	18-3716	460	1989-90	18-3708-1	18-4231	18-4223	18-3741	18-3715
140	1978-81	18-3705	18-4228	18-4222	18-3742	18-3716	502	1992	18-3708-1	18-4231	18-4223	18-3741	18-3715
185	1978-80	18-3708-1	18-4231	18-4223	18-3741	18-3715	2.3	1987-90	18-3705	18-4228	18-4222	18-3742	18-3716
200	1979-81	18-3708-1	18-4231	18-4223	18-3741	18-3715	2.5	1982-86	18-3705	18-4228	18-4222	18-3742	18-3716
225	1978	18-3708-1	18-4231	18-4223	18-3741	18-3715	3	1982-89	18-3705	18-4228	18-4222	18-3742	18-3716
230	1979	18-3708-1	18-4231	18-4223	18-3741	18-3715	3	1990-92	18-3708-1	18-4231	18-4223	18-3741	18-3715
240	1978	18-3708-1	18-4231	18-4223	18-3741	18-3715	3.8	1981-85	18-3708-1	18-4231	18-4223	18-3741	18-3715
260	1979-81	18-3708-1	18-4231	18-4223	18-3741	18-3715	4.3	1985-92	18-3708-1	18-4231	18-4223	18-3741	18-3715
262	1987-89	18-3708-1	18-4231	18-4223	18-3741	18-3715	5	1982-92	18-3708-1	18-4231	18-4223	18-3741	18-3715
350	1988-91	18-3708-1	18-4231	18-4223	18-3741	18-3715	5.7	1979-92	18-3708-1	18-4231	18-4223	18-3741	18-3715
351	1992	18-3708-1	18-4231	18-4223	18-3741	18-3715	5.8	1989-92	18-3708-1	18-4231	18-4223	18-3741	18-3715
454	1990-92	18-3708-1	18-4231	18-4223	18-3741	18-3715	7.5	1987	18-3708-1	18-4231	18-4223	18-3741	18-3715

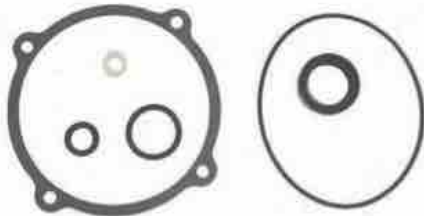

18-2698
CLUTCH HOUSING SEAL KIT

Fits: All models 1977 & below

— CONTAINS —

Part #	Desc.	O.E. #	Qty.
18-7114	O-RING	302540	1
18-7400	O-RING	908194	1
18-7852	OIL SEAL	911019	1
18-2863	GASKET, COVER	308799	1
18-4248	GASKET, OIL DRAIN	311598	1
18-0939	GASKET, DIPSTICK	315189	1



18-8360
CLUTCH HOUSING SEAL KIT

Fits: All models 1978 & above

— CONTAINS —

Part #	Desc.	O.E. #	Qty.
18-2060	OIL SEAL	321467	2
18-7114	O-RING	302540	1
18-7168	O-RING	202893	2
18-7400	O-RING	908194	1
18-2863	GASKET, COVER	308799	1
18-4248	GASKET, OIL DRAIN	311598	2
18-0939	GASKET, DIPSTICK	315189	1

HP	Year	Clutch Pack Seal Kit	HP	Year	Clutch Pack Seal Kit	HP	Year	Clutch Pack Seal Kit	HP	Year	Clutch Pack Seal Kit
80	1968-1969	18-2698	140	1980-1981	18-8360 ^③	190	1974-1977	18-2698	230	1980-1981	18-8360 ^②
90	All	18-2698	3.0L	1982-1985	18-8360	200	1966-1968	18-2698	235	All	18-2698
100	1972-1973	18-2698	155	1967-1972	18-2698	200	1979-1980	18-2698 ^①	240	1978	18-2698
120	1965-1978	18-2698	165	1972-1976	18-2698	200	1980-1981	18-8360 ^②	245	1972-1975	18-2698
120	1979-1980	18-2698 ^①	3.8L	1981-1983	18-8360	5.0L	1982-1985	18-8360	250	1979	18-2698
120	1980-1985	18-8360 ^③	170	1974	18-2698	210	1968-1970	18-2698	260	1979-1980	18-2698 ^①
2.5L	1982-1985	18-8360	175	1975-1977	18-2698	215	1971	18-2698	260	1980-1981	18-8360 ^②
140	1973-1978	18-2698	185	1967-1968	18-2698	225	All	18-2698	5.7L	1982-1985	18-8360
140	1979-1980	18-2698 ^①	185	1978	18-2698	230	1979-1980	18-2698 ^①			

① 1980 Models with the "C" suffix

② 1980 Models with "K" or "U" suffix

③ 1980 Models with "C1" suffix

Zinc is for saltwater only applications.
Magnesium is for fresh water only applications.
Aluminum is for brackish water, or if boat is used in both fresh and salt environments.



⑤ **18-6019**
ANODE
Replaces: 982277, 982438
For intermediate housing on Stringer Drive models



⑤ **18-6020**
ANODE
Replaces: 976669
For Stringer Drive models with central grounding point on boat hull



⑤ **18-6024**
④ **18-6024A**
ANODE
Replaces: 393023, 436745
(1982-87) For use on gearcases

④ Aluminum ⑤ Zinc

 <p>③ 18-6025 ANODE Replaces: 433458, 398331</p>	 <p>③ 18-6027 ANODE Replaces: 392123 For exhaust housing, V4 & V6 (1983-90)</p>	 <p>③ 18-6028 ① 18-6028A ② 18-6102 ANODE Replaces: 984513, 3853818, 3855412 For use on Gearcases: 2.3L (1987-90), 2.6L/3.5L/4.6L (1989), 3.0L/4.3L/5.0L/5.8L (1987-93), 5.7L (1987-92), 7.4L (1987-88)</p>	
 <p>③ 18-6029 ANODE Replaces: 397768</p>	 <p>③ 18-6095 ① 18-6095A ANODE Replaces: 431708 For use on gearcases (1988-90)</p>	 <p>③ 18-6101 ANODE Replaces: 983494 For: Cobra Lower Unit (1987) 2.5, 3.0, 4.3, 5.0, 5.7</p>	
 <p>③ 18-6103 ① 18-6103A ANODE Replaces: 984547 For use on Transom Mounts: 2.3L/3.0L (1987-89), 2.6L (1989)</p>	 <p>③ 18-6155Z ANODE KIT For: Cobra Drives except King Cobra</p>	<p>PKG. OF 5</p>  <p>18-3722 18-3722-9④ STAINLESS STEEL LOCKNUT Replaces: 121731 (1/4"—28)</p>	
 <p>18-2454 DRAIN PLUG Replaces: 3854539 3/8" - 16 thread Uses O-ring 18-7145 For: Cobra SX drives</p>	 <p>18-2138 PIVOT PIN BEARING Replaces: 911787 COBRA (2 per Drive)</p>	 <p>18-7634 TRIM SENDER Replaces: 984748 Fits: OMC Cobra</p>	
<p>① Aluminum ② Magnesium ③ Zinc ④ Priced per Package</p>			



**18-2663
LOWER UNIT
SEAL KIT**
Replaces: 981797
100-245 Stringer Unit (1968-77)

— CONTAINS —

Part #	Desc.	O.E. #	Qty.
18-0188	Grommet	908594	1
18-2012	Oil Seal	310599	4
18-2020	Oil Seal	310649	1
18-2058	Oil Seal	313353	2
18-2851	Swivel Bearing To Lower Gear Case Gsk.	313368	1
18-4248	Washer	311598	2
18-7120	O-Ring	307853, 322598	4
18-7129	O-Ring	314491	1
18-7135	O-Ring	310584	1
18-7167	O-Ring	310414	1



**18-2664
LOWER UNIT
SEAL KIT**
Replaces: 982947
4 cyl (400) Stringer Unit (1978-86)

— CONTAINS —

Part #	Desc.	O.E. #	Qty.
18-0110	Shift Housing Gasket	324670	1
18-3133	Housing Screw	908158	2
18-0188	Washer	909748	1
18-2020	Oil Seal	310649	1
18-2058	Oil Seal	313353	2
18-2060	Oil Seal	321467	2
18-3722	Locknut	121731	4
18-4248	Washer	311598	2
18-7101	O-Ring	305739	1
18-7102	O-Ring	307450	1
18-7120	O-Ring	307853, 322598	1
18-7127	O-Ring	313446	1
18-7130	O-Ring	314728	1
18-7178	O-Ring	320140	1
18-7404	O-Ring	909747	1
18-7475	Quad Ring	332583	4
18-7168	O-Ring	202893	1
18-7409	O-Ring	911871	2
18-2001	Oil Seal	330137	2
18-7479	O-Ring	—	1
18-3153	S.S. Bolt	908158	2

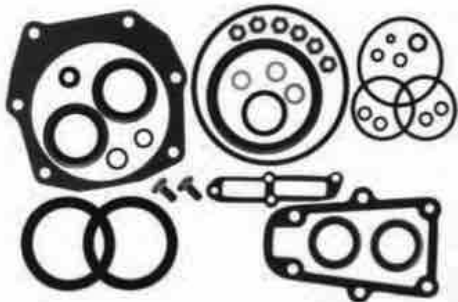

**18-2665
LOWER UNIT
SEAL KIT**
Replaces: 982946
V6, V8 (800) Stringer Unit (1978-86)

— CONTAINS —

Part #	Desc.	O.E. #	Qty.
18-0110	Shift Housing Gasket	324670	1
18-3133	Housing Screw	908158	2
18-0188	Washer	909748	1
18-2002	Oil Seal	320862	2
18-2020	Oil Seal	310649	1
18-2058	Oil Seal	313353	2
18-2060	Oil Seal	321467	2
18-2911	Swivel Bearing Housing Gasket	910236	1
18-3722	Locknut	121731	6
18-4248	Washer	311598	2
18-7101	O-Ring	305739	1
18-7102	O-Ring	307450	1
18-7120	O-Ring	307853, 322598	1
18-7130	O-Ring	314728	1
18-7142	O-Ring	322119	1
18-7178	O-Ring	320140	1
18-7403	O-Ring	909316	2
18-7404	O-Ring	909747	1
18-7475	Quad Ring	332583	4
18-7168	O-Ring	202893	1
18-7479	O-Ring	—	1
18-3153	S.S. Bolt	908158	2



**18-2666
UPPER UNIT SEAL KIT**
Replaces: 981799
100-245 Stringer Unit (1968-72)

— CONTAINS —

Part #	Desc.	O.E. #	Qty.
18-0939	Upper Gearcase Gasket	315189	1
18-2073	Oil Seal	981268	4
18-3111	Rubber Seal	907774	1
18-4248	Washer	311598	2
18-7103	O-Ring	308624	4
18-7107	O-Ring	313175	1
18-7121	O-Ring	308621	1
18-7134	O-Ring	303059	1
18-7146	O-Ring	554545	1
18-7173	O-Ring	910582	1
18-7198	O-Ring	308626	2
18-7158	O-Ring	310585, 310967	1
18-7172	O-Ring	553126	1

— CONTAINS —

Part #	Desc.	O.E. #	Qty.
18-0939	Upper Gearcase Gasket	315189	1
18-2072	Oil Seal	0765461	2
18-2073	Oil Seal	981268	2
18-3111	Rubber Seal	907774	1
18-3725	Locknut	908064	1
18-4248	Washer	311598	2
18-4251	Plug	908062	1
18-7107	O-Ring	313175	1
18-7114	O-Ring	302540	1
18-7121	O-Ring	308621	1
18-7129	O-Ring	314481	1
18-7477	Quad Ring	909048	1
18-7168	O-Ring	202893	1
18-7172	O-Ring	553126	1
18-7173	O-Ring	910582, 310327	1



18-2667
UPPER UNIT SEAL KIT
 Replaces: 982949
 All Stringer Unit (1973-86)

— CONTAINS —

Part #	Desc.	O.E. #	Qty.
18-0917	Tilt Motor Gasket	311508	1
18-0923	Seal Gasket	313244	2
18-0939	Upper Gearcase Gasket	315189	1
18-0949	Trunion Cap Gasket	316499	2
18-2004	Oil Seal	—	1
18-2016	Oil Seal	0764337	2
18-2066	Oil Seal	911019	1
18-2071	Oil Seal	981195	2
18-3725	Locknut	908064	1
18-4248	Washer	311598	1
18-4251	Plug	908062	1
18-7114	O-Ring	302540	1
18-7162	O-Ring	302337	1
18-7400	O-Ring	908194	1
18-7401	O-Ring	908383	1
18-7198	O-Ring	308626	2
18-2863	Tilt Clutch Cover Gasket	306799	1



18-2669
INTERMEDIATE HOUSING SEAL KIT
 Replaces: 981801
 100-245 Stringer Unit (1973-77)

— CONTAINS —

Part #	Desc.	O.E. #	Qty.
18-0880	Shift Cover Gasket	911878	1
18-0166	Grommet	911705	2
18-0190	Wiper	912157	1
18-4248	Washer	311598	2
18-7127	O-Ring	313446	1
18-7130	O-Ring	314728	1
18-7137	O-Ring	318372	1
18-7138	O-Ring	318717	3
18-7145	O-Ring	333572	2
18-7475	Quad Ring	332584	5
18-2001	Oil Seal	330137	2



18-2671
LOWER UNIT SEAL KIT
 Replaces: 985612
 All 4 cyl. Cobra (1986-89)

— CONTAINS —

Part #	Desc.	O.E. #	Qty.
18-0880	Shift Cover Gasket	911878	1
18-0166	Grommet	911705	2
18-0190	Wiper	912157	1
18-2002	Oil Seal	320862	2
18-4248	Washer	311598	2
18-7130	O-Ring	314728	1
18-7137	O-Ring	318372	1
18-7138	O-Ring	318717	3
18-7142	O-Ring	322119	1
18-7145	O-Ring	333572	2
18-7475	Quad Ring	332584	5
18-0440	Water Passage Gasket	915719	1

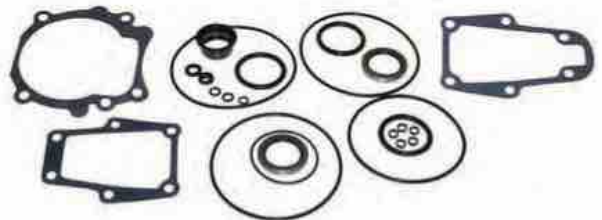

18-2672
LOWER UNIT SEAL KIT
 Replaces: 984458, 985613, 439967
 All V6/V8 Cobra (1986-1991)



18-2673

UPPER UNIT SEAL KITReplaces: 984459, 986364, 987603
All Cobra (1986-89)

— CONTAINS —

Part #	Desc.	O.E. #	Qty.
18-0911	Water Pump Base Gasket	911698	1
18-0884	Water Cover Gasket	911733	1
18-0166	Grommet	911705	2
18-2067	Oil Seal	911685	1
18-2068	Oil Seal	3853655	1
18-2541	Rubber Seal	911704	1
18-2918	Water Pump Housing Gasket	911702	1
18-2918	Outdrive Gasket	915840	1
18-2996	Seal	911823	1
18-7107	O-Ring	313175	1
18-7116	O-Ring	303067	1
18-7138	O-Ring	318717	2
18-7153	O-Ring	—	2
18-7169	O-Ring	911686	1
18-7403	O-Ring	909316	1
18-7407	O-Ring	911700	1

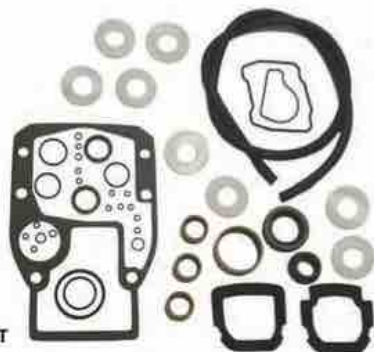

18-2674

TRANSOM MOUNT SEAL KITReplaces: 985518, 986423
All Cobra (1986-89)

— CONTAINS —

Part #	Desc.	O.E. #	Qty.
18-2070	Oil Seal	911795	1
18-2138	Bearing	911787	3
18-2139	Bearing	911794	1
18-2533	Foam Seal	911797	1
18-2918	Outdrive Gasket	915840, 911836	1
18-2996	Seal	911823	1
18-4250	Washer	911820	2
18-7141	O-Ring	321117	12
18-7143	O-Ring	322501	1
18-7162	O-Ring	302337	1
18-7165	O-Ring	304174	1
18-7406	O-Ring	911311	3
18-7408	O-Ring	911718	2
18-7409	O-Ring	911871	1
18-7168	O-Ring	202893	1
18-8349	Seal	3852548	1



18-2783

LOWER UNIT SEAL KITReplaces: 986629
King Cobra Lower Unit - 1990

18-2791

GEARCASE SEAL KITReplaces: 987251, 3850597
Fits: 3.0L, 4.3L, 5.0L (1994), 3.2L (1992-93),
5.7L (1992-94), 7.4L (1992-95), 8.2L (1992-93)

APPLICATION ON NEXT PAGE



SEAL KIT APPLICATION

Model	Year	Lower Gearcase Seal Kit	Upper Gearcase Seal Kit	Intermediate Housing Seal Kit	Transom Mount Seal Kit	Model	Year	Lower Gearcase Seal Kit	Upper Gearcase Seal Kit	Intermediate Housing Seal Kit	Transom Mount Seal Kit
2.3	1987-90	18-2671	18-2673	18-2674	18-2674	165	1972	18-2663	18-2666	18-2668	N/A
2.5 ①	1982-86	18-2664	18-2667	N/A	N/A	165	1973-76	18-2663	18-2667	18-2669	N/A
2.5 ②	1986	18-2671	18-2673	N/A	18-2674	170	1974	18-2663	18-2667	18-2669	N/A
3 ①	1982-86	18-2664	18-2667	N/A	N/A	175	1975-77	18-2663	18-2667	18-2669	N/A
3 ②	1986-91	18-2671	18-2667	N/A	N/A	185	1968	18-2663	18-2666	18-2668	N/A
4.3 ①	1985-86	18-2665	18-2667	N/A	N/A	185	1978-80	18-2665	18-2667	N/A	N/A
4.3 ②	1986-91	18-2672	18-2673	N/A	18-2674	190	1974-77	18-2663	18-2667	18-2669	N/A
3.8	1981-86	18-2665	18-2667	N/A	N/A	200	1968	18-2663	18-2666	18-2668	N/A
5 ①	1982-86	18-2665	18-2667	N/A	N/A	200	1979-81	18-2665	18-2667	N/A	N/A
5 ②	1986-91	18-2672	18-2673	N/A	18-2674	210	1968-70	18-2663	18-2666	18-2668	N/A
5.7 ①	1982-86	18-2665	18-2667	N/A	N/A	215	1971	18-2663	18-2666	18-2668	N/A
5.7 ②	1986-89	18-2672	18-2673	N/A	18-2674	225	1972	18-2663	18-2666	18-2668	N/A
5.7 ③	1990-91	18-2672	18-2673	N/A	18-2674	225	1973-76	18-2663	18-2667	18-2669	N/A
5.8	1989-90	18-2672	18-2673	N/A	18-2674	225	1978	18-2665	18-2667	N/A	N/A
7.5	1987	—	18-2673	N/A	18-2674	230	1979-81	18-2665	18-2667	N/A	N/A
80	1969	18-2663	18-2666	18-2668	N/A	235	1971	18-2663	18-2666	18-2668	N/A
90	1970	18-2663	18-2666	18-2668	N/A	235	1975-77	18-2663	18-2667	18-2669	N/A
100	1972	18-2663	18-2666	18-2668	N/A	240	1978	18-2665	18-2667	N/A	N/A
100	1973	18-2663	18-2667	18-2669	N/A	245	1972	18-2663	18-2666	18-2668	N/A
120	1968-72	18-2663	18-2666	18-2668	N/A	245	1973-75	18-2663	18-2667	18-2669	N/A
120	1973-77	18-2663	18-2667	18-2669	N/A	250	1979	18-2665	18-2667	N/A	N/A
120	1978-81	18-2664	18-2667	N/A	N/A	260	1979-81	18-2665	18-2667	N/A	N/A
140	1973-77	18-2663	18-2667	18-2669	N/A	262	1989	18-2672	18-2673	N/A	18-2674
140	1978-81	18-2664	18-2667	N/A	N/A	350	1988-89	18-2672	18-2673	N/A	18-2674
155	1968-72	18-2663	18-2666	18-2668	N/A	460	1988-89	—	18-2673	N/A	18-2674

① Except Cobra ② Cobra ③ Except L.E. N/A Not Applicable

OIL SEALS



Part #	O.E. #	Shaft Size	Dimensions (in)		Part #	O.E. #	Shaft Size	Dimensions (in)	
			O.D.	Width				O.D.	Width
18-0542	321831, 315288	0.750	1.253	0.186	18-2061	329922	0.822	1.375	0.195
18-0543	321895,	1.540	1.926	0.243	18-2062	329923	0.875	1.375	0.207
	313507,				18-2063	330327	0.625	1.124	0.188
18-0559	332585	0.285	0.357	0.940	18-2064	332205	0.730	1.130	0.194
18-2000	309989	1.375	2.000	0.313	18-2065	332261	0.625	1.375	0.195
18-2001	330137	1.125	1.624	0.250	18-2066	911019	1.000	1.375	0.435
18-2002	320862	1.188	1.692	0.250	18-2067	911685	2.000	2.509	0.315
18-2005	313284	0.625	1.128	0.250	18-2068	3853655	0.500	0.905	0.250
18-2012	310599	1.000	1.499	0.250	18-2068	915702	0.500	0.905	0.250
18-2016	0764337	1.187	1.875	0.250	18-2068	916058	0.500	0.905	0.250
18-2018	0767970	1.000	1.375	0.250	18-2068	3853655	0.500	0.905	0.200
18-2020	310649	2.500	3.000	0.250	18-2071	908065, 908852	1.500	2.125	0.250
18-2022	303345	0.554	1.000	0.375	18-2072	0765461, 908894, 908070	1.750	2.502	0.250
18-2023	313282	0.554	1.062	0.312	18-2073	907967, 981268	1.625	2.502	0.250
18-2024	314167	0.425	0.937	0.312	18-8349	3852548	1.375	2.186	0.500
18-2025	318972	0.500	0.875	0.250					
18-2027	305306, 321459	0.625	1.125	0.250					
18-2030	321786	0.625	1.125	0.188					
18-2031	321787	0.625	1.125	0.312					
18-2033	321928	0.625	1.375	0.250					
18-2034	324639	0.437	0.937	0.188					
18-2058	313353	1.938	2.438	0.250					
18-2059	318223	0.750	1.126	0.200					
18-2060	321467	1.000	1.375	0.250					



UPPER GEARCASE (Cobra)				
ENGINE	YEAR	OIL SEAL	DESC.	QTY
262 - 460	1988-89	18-2067	BC	1
262 - 460	1988-90	18-2068	WPS	1
2.3 - 7.5	1986-90	18-2068	WPS	1
2.3 - 7.5	① 1986-90	18-2067	BC	1

① 5.7 '90 574 AMPWS, ARPWS
BC Bearing Carrier Seal
WPS Water Pump Seal

LOWER GEARCASE (Stringer)				
ENGINE	YEAR	OIL SEAL	DESC.	QTY
80/90	1968-71	18-2066	BR,L	2
80/90	1968-71	18-2066	PS	2
88/90	1964-68	18-2012	BR	1
80 - 260	1968-81	18-2020	BR,U	1
80 - 260	1968-81	18-2058	BR,M	2
110 - 200	① 1964-67	18-2012	BR	2
110 - 245	② 1964-77	18-2012	PS	2
110/120	③ 1964-67	18-2012	BR	1
120 - 245	1968-77	18-2012	BR,L	2
120 - 260	1978-81	18-2060	BR,L	2
120/140	1978-81	18-2001	PS	2
155	④ 1967	18-2058	BR,M	2
155	⑤ 1967	18-2020	BR,U	1
185 - 260	1978-81	18-2002	PS	2
210 - 260	⑥ 1972-75	18-2066	IH	1
230/260	⑦ 1976	18-2060	IH	1
305/350/454	⑧ 1977-78	18-2060	IH	1
2.5/3.0	1982-86	18-2001	PS	2
2.5 - 5.7	1981-86	18-2020	BR,U	1
2.5 - 5.7	1981-86	18-2058	BR,M	2
2.5 - 5.7	1981-86	18-2060	BR,L	2
3.8 - 5.7	1981-86	18-2002	PS	2

- ① 110, 120 HP '64-67 Hvy. Duty Dr.
- ② Standard Drive
- ③ HU, HUE 16 C Models
- ④ Inboard
- BR** Driveshaft Bearing Retainer Seal
- BR,U** Driveshaft Bearing Retainer Upper Seal
- BR,M** Driveshaft Bearing Retainer Middle Seal
- BR,L** Driveshaft Bearing Retainer Lower Seal
- IH** Impeller Housing Seal
- PS** Prop Shaft Seal

UPPER GEARCASE (Stringer)				
ENGINE	YEAR	OIL SEAL	DESC.	QTY
80 - 245	1968-72	18-2073	BGS	1
80 - 260	1969-81	18-2073	IH	2
88 - 200	1964-66	18-2000	BGS	1
90	③ 1967	18-2000	BGS	1
90	④ 1967	18-2073	BGS	1
100 - 245	1972-73	18-2073	BGS	1
100 - 260	1973-81	18-2072	BGS	2
120	① 1967	18-2073	BGS	1
120	② 1967	18-2000	BGS	1
120	③ 1967	18-2073	IH	2
120 - 210	1968	18-2073	IH	2
155	1967	18-2073	IH	2
155	⑤ 1967	18-2000	BGS	1
155	1967	18-2073	BGS	1
185	1967	18-2000	BGS	1
200	⑥ 1967	18-2000	BGS	1
200	⑦ 1967	18-2073	IH	2
200	⑧ 1967	18-2073	BGS	1
2.5 - 5.7	1981-86	18-2072	BGS	2
2.5 - 5.7	1981-86	18-2073	IH	2

- ① CU, CUE 16C Models
- ② CU15S Models
- ③ DU, DUE 14D Models
- ④ DU, DUE 15S Models
- ⑤ HU, HUE 15S Models
- ⑥ TU, TUE 15S Models
- ⑦ TU, TUE 16C Models
- BGS** Ball Gear Shaft Seal
- IH** Impeller Housing Seal

LOWER GEARCASE (Cobra)				
ENGINE	YEAR	OIL SEAL	DESC.	QTY
262 - 460	1988-89	18-2002	PS	2
2.3	1990	18-2001	PS	2
2.3 - 3.0	1986-89	18-2001	PS	2
3	1990	18-2002	PS	2
4.3 - 7.5	1986-90	18-2002	PS	2

PS Prop Shaft Seal

INTERMEDIATE HOUSING (Stringer)				
ENGINE	YEAR	OIL SEAL	DESC.	QTY
80 - 235	1964-71	18-2000	BG,O	1
80 - 245	1964-72	18-2001	BG,I	1
80 - 260	② 1964-80	18-2066	CL	1
100 - 245	1972	18-2000	BG,O	2
100 - 260	1973-79	18-2016	BG,I	1
100 - 260	1973-81	18-2071	BG,O	2
120 - 260	1980-81	18-2016	BG,I	2
120 - 260	① 1980-81	18-2060	CL	2
2.5 - 5.7	1981-86	18-2060	CL	2
2.5 - 5.7	1981-86	18-2016	BG,I	2
2.5 - 5.7	1981-86	18-2071	BG,O	2

- CL** Clutch
- ① 120, 140 '80C Models/185—260
- '80 K&U Models
- ② C Models in '80
- BG,I** Driveshaft Ball Gear Inner Seal
- BG,O** Driveshaft Ball Gear Outer Seal



O-RINGS

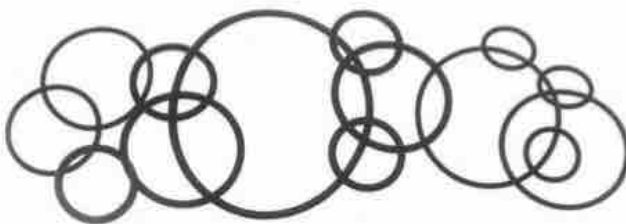

Part #	O.E. #	Dimensions (in)		Part #	O.E. #	Dimensions (in)			
		I.D.	Width			I.D.	Width		
18-7100	② ⑤	301877	.245	.155	18-7150	③ ⑤	331380	.225	.115
18-7101	② ⑤	305739	.250	.065	18-7150	③ ⑤	334913	.225	.115
18-7102	② ⑤	307450	.430	.065	18-7152	② ⑤	307082	2.625	.135
18-7103	② ⑤	308624	.920	.100	18-7153	①	3852565,		
18-7104	② ⑤	308627	2.210	.135			911851	.0860	.100
18-7105	② ⑤	311338	.750	.065	18-7155	② ⑤	305270	1.620	.135
18-7107	② ⑤	313175	4.750	.135	18-7156	② ⑤	309731	1.185	.100
18-7108	② ⑤	313893	2.550	.100	18-7158	② ⑤	310585	.740	.100
18-7108	② ⑤	338518	2.550	.100	18-7162	② ⑤	302337	2.025	.135
18-7109	② ⑤	317178	.214	.048	18-7164	② ⑤	302537	1.375	.100
18-7111	①	301824	.197	.113	18-7165	② ⑤	304174	.500	.065
18-7112	①	302493	1.170	.135	18-7167	② ⑤	310414	3.625	.135
18-7114	② ⑤	302540	1.000	.135	18-7168	② ⑤	202893	.370	.065
18-7115	①	302588	1.735	.135	18-7169	② ⑤	911686	3.500	.135
18-7116	①	303067	.360	.100	18-7170	①	307239	1.365	.135
18-7117	①	303360	1.060	.135	18-7172	② ⑤	553126	3.250	.135
18-7118	② ⑤	305242	.300	.135	18-7173	② ⑤	310327	1.875	.135
18-7120	①	307853	.215	.065	18-7174	② ⑤	326649	.620	.100
18-7120	①	332598	.215	.065	18-7178	② ⑤	320140	.920	.135
18-7121	①	308621	3.100	.135	18-7180	② ⑤	303347	.445	.090
18-7123	①	308876	2.235	.100	18-7198	② ⑤	308626	1.430	.100
18-7126	①	313340	1.690	.100	18-7400	② ⑤	908194	4.000	.100
18-7127	①	313446	3.315	.135	18-7401	② ⑤	908383	2.485	.100
18-7128	①	313754	1.835	.100	18-7403	② ⑤	909316	1.500	.100
18-7129	② ⑤	314491	.970	.065	18-7404	② ⑤	909747	.300	.100
18-7130	①	314728	2.125	.100	18-7406	② ⑤	911311	0.250	.065
18-7133	② ⑤	305123	3.780	.135	18-7407	② ⑤	911700	4.125	.135
18-7134	② ⑤	303059	.500	.100	18-7407	② ⑤	3852531	4.125	.135
18-7135	①	310584	.750	.135	18-7408	② ⑤	911718	1.060	.100
18-7137	② ⑤	318372	0.320	.155	18-7409	② ⑤	911871	1.175	.100
18-7138	② ⑤	318717	1.500	.210	18-7413	② ⑤	303191	.301	.070
18-7139	② ⑤	319085	1.080	.210	18-7416	② ⑤	329380	.612	.103
18-7140	② ⑤	320303	2.750	.135	18-7417	② ⑤	329381	.362	.103
18-7141	② ⑤	321117	.180	.065	18-7418	② ⑤	326741	4.484	.139
18-7142	② ⑤	322119	3.940	.135	18-7440-1	④	301967	.799	.103
18-7143	② ⑤	322501, 331188	1.310	.100	18-7457	①	319662	1.799	.103
18-7144	② ⑤	326849	4.250	.135	18-7461	①	308458	1.612	.103
18-7145	② ⑤	333572	.250	.100	18-7475	② ⑤	332584	.250	.065
18-7146	② ⑤	554545	1.120	.100	18-7477	② ⑤	909048	.480	.100
18-7150	③ ⑤	303598	.225	.115	18-7510	①	321163	2.750	.070

① Pkg. of 1 ② Pkg. of 5 ③ Pkg. of 10 ④ Indicates Quad Rings rather than O-Rings

TRANSOM MOUNT (Cobra)

TRANSOM MOUNT (Cobra) (Cont.)

ENGINE	YEAR	O-RING	DESC.	QTY.	ENGINE	YEAR	O-RING	DESC.	QTY.	
262 - 460	1988-89	18-7165	SCS	1	2.3 - 7.5	①	1986-90	18-7165	SCS	1
262 - 460	1988-89	18-7408	NP	2	2.3 - 7.5	①	1986-90	18-7409	SC	1
262 - 460	1988-89	18-7409	SC	1	2.3 - 7.5		1986-90	18-7143	MB	1
262 - 460	1988-89	18-7406	PL	1						
262 - 460	1988-89	18-7168	BC	1						
262 - 460	1988-90	18-7162	UG	1						
262 - 460	1988-90	18-7143	MB	1						
2.3 - 7.5	①	1986-90	18-7168	BC	1					
2.3 - 7.5		1986-90	18-7162	UG	1					
2.3 - 7.5	①	1986-90	18-7406	PL	1					
2.3 - 7.5	①	1986-90	18-7408	NP	2					

① 5.7 '90 574 AMPWS, ARPWS
BC Bell Crank Seal
MB Manifold Block Seal
UG Upper Gimbal Seal
SCS Shift Cable Seal
PL Plug Seal
NP Nipple Seal
SC Sleeve and Connector Seal

⑤ This product is priced per piece. To order priced per package, please add -9 to the part number.

UPPER GEARCASE (Cobra)

ENGINE	YEAR	O-RING	DESC.	QTY
262 - 460	1988-89	18-7403	A,S	1
262 - 460	1988-89	18-7107	GHC	1
262 - 460	1988-89	18-7407	A,L	1
262 - 460	1988-90	18-7169	BC	1
350 - 460	1990	18-7116	OPF	1
350 - 460	1990	18-7407	BC	1
350 - 460	1990	18-7406	WDP	1
370	1988	18-7407	AB	1
460	1990	18-7407	BC	1
2.3 - 5.8	1990	18-7116	OPF	1
2.3 - 7.5	① 1986-90	18-7107	GHC	1
2.3 - 7.5	① 1986-90	18-7407	A,L	1
2.3 - 7.5	1986-90	18-7169	BC	1
2.3 - 7.5	① 1986-90	18-7403	A,S	1
5.7	② 1990	18-7406	WDP	1
5.7	② 1990	18-7407	BC	1

- ① 5.7 '90 574 AMPWS, ARPWS
- ② 574 PEPWS
- GHC** Gear Hsg. Cover Seal
- OPF** Oil Fill Plug Seal
- BC** Bearing Carrier Seal
- A,S** Adaptor, Small Seal
- A,L** Adaptor, Large Seal
- WDP** Water Drain Plug Seal
- AB** Anchor Block Seal

LOWER GEARCASE (Cobra)

ENGINE	YEAR	O-RING	DESC.	QTY
262/350	1988-89	18-7475	PBHS	4
262/350	1988-89	18-7142	PBH	1
262 - 460	1988-89	18-7130	DS B	1
262 - 460	1988-89	18-7475	BSS	1
262 - 460	1988-89	18-7138	DS BH	3
262 - 460	1988-89	18-7137	SR	1
350 - 460	1990	18-7145	PL	1
370	1988	18-7130	SL	2
370/460	1988-89	18-7145	D&F S	2
2.3	1987	18-7145	D&F S	2
2.3	1990	18-7127	PBH	1
2.3 - 3.0	1986-89	18-7127	PBH	1
2.3/3.0	1988-90	18-7145	D&F S	2
2.5 - 5.7	1986	18-7145	D&F S	2
2.3 - 5.8	① 1986-90	18-7475	PBHS	4
2.3 - 7.5	① 1986-90	18-7475	BSS	1
2.3 - 7.5	① 1986-90	18-7138	DS BH	3
2.3 - 7.5	① 1986-90	18-7137	SR	1
2.3 - 7.5	① 1986-90	18-7130	DS B	1
3.0 - 5.8	① 1990	18-7142	PBH	1
4.3 - 5.8	1989-89	18-7142	PBH	1
5.7	② 1990	18-7145	PLUG	1

- ① 5.7 '90 574 AMPWS, ARPWS
- ② 574 PEPWS
- BSS** Bearing Setscrew Seal
- DS BH** Driveshaft Bearing Hsg. Seal
- DS B** Driveshaft Bearing Seal
- D&F S** Drain & Fill Screw Seal
- PBH** Prop Bearing Hsg. Seal
- PBHS** Prop Bearing Hsg. Screw Seal
- PL** Plug Seal
- SR** Shift Rod Seal
- SL** Sleeve Seal

POWER TILT AND TRIM (Cobra)

ENGINE	YEAR	O-RING	DESC.	QTY
262 - 460	1988-90	18-7141	OL	12
262 - 460	1988-90	18-7102	PL	1
350 - 460	1988	18-7174	VSH	1
350 - 460	1988	18-7168	VS	4
350 - 460	1988	18-7174	VA,L	2
350 - 460	1988	18-7165	VA,S	2
2.3 - 7.5	1986-88	18-7174	VSH	1
2.3 - 7.5	1986-88	18-7168	VS	4
2.3 - 7.5	1986-88	18-7174	VA,L	2
2.3 - 7.5	1986-88	18-7165	VA,S	2
2.3-7.5	1986-90	18-7102	PL	1
2.3-7.5	1986-90	18-7141	OL	12

- PL** Plug Seal
- VS** Valve Seat Assy. Seal
- VA,L** Valve Assy., Large Seal
- VA,S** Valve Assy., Small Seal
- VSH** Valve Seat Hsg. Seal
- OL** Oil Line Seal

OIL AND COOLING SYSTEM (Cobra)

ENGINE	YEAR	O-RING	DESC.	QTY
262/454	1989-90	18-7135	AR	1
262 - 460	1988-90	18-7116	ODF	1
350/460	1988-90	18-7135	AR	1
370	1988	18-7162	THERM	1
2.3 - 5.8	1988-90	18-7116	ODF	1
4.3	① 1990	18-7135	AR	1
7.5	1987	18-7135	AR	1

- ① V-4 Only
- ODF** Oil Drain Fitting Seal
- AR** Adapter Retainer Seal
- THERM** Thermostat Seal

POWERHEAD (Stringer)

ENGINE	YEAR	O-RING	DESC.	QTY
80/90	1969-71	18-7108	WP	1
88	1964	18-7133	CCH	3
88/90	1964-68	18-7120	CCHS	4
90	1965-68	18-7133	CCH	4
120/140	1977-80	18-7114	CP	1
120 - 235	1976	18-7114	CP	1

- WP** Water Pump Seal
- CCH** Crankcase Head Seal
- CCHS** Crankcase Head Screw Seal
- CP** Coupling Seal

INTERMEDIATE HOUSING (Stringer)

ENGINE	YEAR	O-RING	DESC.	QTY
80	1968	18-7162	SL	1
80 - 90	1964-68	18-7174	WT	1
80 - 210	1964-70	18-7123	BGR	1
80 - 245	① 1964-72	18-7174	PS	1
80 - 260	1964-81	18-7198	COV	2
80 - 260	1964-81	18-7114	WR	1
80 - 260	1969-81	18-7162	SL	1
88	1964	18-7104	TH	1
88	1964	18-7174	TC	1

INTERMEDIATE HOUSING (Stringer) (Cont.)				
ENGINE	YEAR	O-RING	DESC.	QTY
90 - 235	1970-71	18-7158	DS	1
90 - 235	② 1971	18-7123	BGR	1
100 - 260	1973-81	18-7401	BGR	1
100 - 260	1973-81	18-7400	TUC	1
120	③ 1967	18-7162	SL	1
120 - 210	1968	18-7162	SL	1
120/140	1981	18-7168	FS	3
155	④ 1967	18-7162	SL	1
2.5 - 5.7	1981-86	18-7400	TUC	1
2.5 - 5.7	1981-86	18-7198	COV	2
2.5 - 5.7	1981-86	18-7114	WR	1
2.5 - 5.7	1981-86	18-7401	BGR	1
2.5 - 5.7	1981-86	18-7162	SL	1
2.5 - 5.7	1982	18-7168	FS	3

- ① Rope or Pull-Pull Steering Models
- ② All 90/120, 155, 210 EX Models/235 XUFM20S prior to S/N 202880 and 235 XUFM20S prior to S/N 204600
- ③ CU, CUE 16C
- ④ 120, 155, 215, 20D Models/235 XUFR20S S/N 202880 & up and 235 XUFM20S S/N 204600 & up 235 20D all Models
- COV** Pivot Cap Cover Seal
- BGR** Ball Gear Retainer Seal
- DS** Driveshaft to Hsg. Seal
- TC** Driveshaft Tube Cover Seal
- TH** Driveshaft Tube to Hsg.
- FS** Fill Screw Seal
- PS** Pulley Shaft
- SL** Sleeve to Hsg. Seal
- TUC** Tilt Unit Cover Seal
- WT** Water Tube Seal
- WR** Worm Gear Retainer Seal

UPPER GEARCASE (Stringer)

ENGINE	YEAR	O-RING	DESC.	QTY
80 - 90	1968-71	18-7158	BG	1
80 - 90	1964-68	18-7174	IH	1
80 - 245	① 1964-72	18-7103	WG	1
80 - 245	① 1964-74	18-7134	G	1
80 - 260	1964-81	18-7172	IH	1
80 - 260	1964-81	18-7121	BGR	1
80 - 260	1968-80	18-7173	WW	1
80 - 260	② 1968-81	18-7107	WW	1
90	③ 1967	18-7107	WW	1
90 - 200	1964-67	18-7128	CAP	1
90 - 200	1965-67	18-7173	WW	2
90 - 245	④ 1967-72	18-7146	BG	1
100 - 245	1973-75	18-7114	WS	1
100 - 260	1973-81	18-7129	DS IH	1
110 - 120	⑤ 1964-67	18-7158	IH	1
110 - 120	⑥ 1964-67	18-7174	IH	1
120 - 200	⑦ 1967	18-7107	WW	1
120 - 235	1968-71	18-7158	IH	1
120 - 260	1975-81	18-7477	G	1
150 - 210	1964-67	18-7158	IH	1
2.5/3.0	1982	18-7168	OP	1
2.5 - 5.7	1981-86	18-7477	G	1
2.5 - 5.7	1981-86	18-7172	IH	1
2.5 - 5.7	1981-86	18-7107	WW	1
2.5 - 5.7	1981-86	18-7121	BGR	1
2.5 - 5.7	1981-86	18-7129	DS IH	1

UPPER GEARCASE (Stringer) (Cont.)

- ① Rope or Pull-Pull Steering Models
- ② 155 HP 1968 HU, HUE 16C
- ③ DU, DUE 15S
- ④ 90 HP '67 DU, DUE 15S/120 and 200 '67 16C Models
- ⑤ Heavy Duty Drive
- ⑥ Standard Gearcase
- ⑦ 16C Models
- BG** Ball Gear Seal
- BGR** Ball Gear Retainer Seal
- DS IH** Driveshaft Impeller Hsg. Seal
- IH** Impeller Hsg. Seal
- CAP** Gear Hsg. Cap Seal
- OP** Oil Plug Seal
- WR** Steering Worm Wheel Retainer Seal
- WS** Steering Worm Wheel Spacer Seal
- WG** Steering Worm Wheel Gear Seal
- WW** Steering Worm Wheel Seal
- G** Gear Seal

LOWER GEARCASE (Stringer)

ENGINE	YEAR	O-RING	DESC.	QTY
80 - 90	1964-69	18-7120	PBH S	4
80 - 90	1964-71	18-7152	PBH	1
80 - 90	1964-71	18-7115	BR	1
80 - 90	1964-71	18-7174	DS	1
88/90	1964-68	18-7173	DSB	2
90 - 245	1970-77	18-7120	PBH S	4
100 - 245	1968-72	18-7135	BR	1
100 - 245	1969-77	18-7167	PBH	1
110/120	② 1964-67	18-7167	PBH	1
110/120	① 1964-67	18-7174	DS	1
110/120	② 1964-67	18-7135	BR	1
110/120	① 1964-67	18-7152	PBH	1
110/120	① 1964-67	18-7173	DSB	2
110/120	① 1964-67	18-7115	BR	1
120	① 1964-67	18-7120	PBH S	4
120/140	1978-81	18-7127	PBH	1
120/140	1978	18-7156	SA,L	2
120 - 235	1977	18-7129	DS	1
120 - 240	1978	18-7178	SA,S	1
120 - 260	1978-81	18-7130	BR	1
120 - 260	1978-81	18-7102	PIN	1
120 - 260	1978-81	18-7109	PBH S	4
120 - 260	1978-81	18-7404	PIN	1
120 - 260	1979-81	18-7120	BSS	1
120 - 260	1981	18-7168	D&F S	1
150 - 200	1964-67	18-7135	BR	1
150 - 210	1964-68	18-7167	PBH	1
185 - 240	1978	18-7403	SA,L	2
185 - 260	1978-81	18-7142	PBH	1
2.5 - 5.7	1981-82	18-7168	D&F S	1
2.5 - 5.7	1981-83	18-7109	PBH S	4
2.5 - 5.7	1981-86	18-7130	BR	1
2.5 - 5.7	1981-86	18-7102	PIN	1
2.5 - 5.7	1981-86	18-7404	PIN	1
2.5 - 5.7	1981-86	18-7120	BSS	1
2.5 - 5.7	1981-86	18-7142	PBH	1
2.5/3.0	1982-86	18-7127	PBH	1
3.8	1981	18-7101	OSV	1

- ① Standard Drive
- ② Heavy Duty Drive
- OSV** Oil Stem Valve Seal
- PIN** Pinion Shaft Seal
- BR** Driveshaft Bearing Retainer Seal
- DS** Driveshaft Seal
- PBH** Prop Bearing Hsg. Seal
- DSB** Driveshaft Bushing Seal
- PBH S** Prop Bearing Hsg. Screw Seal
- D&F S** Drain & Fill Screw Seal
- SA,L** Shift Assy., Large Seal
- SA,S** Shift Assy., Small Seal
- BSS** Bearing Set Screw Seal

TUNE-UP APPLICATION FOR GAS ENGINE MODELS



Model No.	Oil Filter	Fuel Filter	Impeller	Drive Belt
MB 10 A	18-7878-1	—	18-3080	—
BB 30	18-7878-1	—	18-3080	—
BB 100	18-7878-1	—	18-3080	—
MB 18	18-7878-1	—	18-3080	—
AQ 60 F	18-7878-1	—	18-3080	—
MB 18 F	18-7878-1	—	18-3080	—
AQ 90	18-7878-1	—	18-3080	—
AQ 95	18-7878-1	—	18-3080	—
AQ 100	18-7878-1	—	18-3080	—
AQ 95A	18-7878-1	—	18-3080	—
AQ 110	18-7878-1	—	18-3080	—
AQ 120	18-7878-1	—	18-3080	—
BB 115 A	18-7878-1	—	18-3080	—
BB 115 B	18-7878-1	—	18-3080	—
BB 115 C	18-7878-1	—	18-3080	—
MB 20 A	18-7878-1	—	18-3080	—
MB 20 B	18-7878-1	—	18-3080	—
MB 20 C	18-7878-1	—	18-3080	—
AQ 115 A	18-7878-1	—	18-3080	—
AQ 115 B	18-7878-1	—	18-3080	—
AQ 130 A	18-7878-1	—	18-3080	—
AQ 130 B	18-7878-1	—	18-3080	—
AQ 130 C	18-7878-1	—	18-3080	—
AQ 130 D	18-7878-1	—	18-3080	—
BB 165 A	18-7878-1	—	18-3075	18-4044
BB 170 A	18-7878-1	—	18-3075	18-4044
BB 170 B	18-7878-1	—	18-3075	18-4044
BB 170 C	18-7878-1	—	18-3075	18-4044
AQ 165 A	18-7878-1	—	18-3075	18-4044
AQ 170 A	18-7878-1	—	18-3075	18-4044
AQ 170 B	18-7878-1	—	18-3075	18-4044
AQ 170 C	18-7878-1	—	18-3075	18-4044
AQ 120 B	18-7878-1	18-7862 18-7858	18-3075	18-4044
AQ 125 A	18-7878-1	18-7862 18-7858	18-3075	18-4044
AQ 125 B	18-7878-1	18-7862 18-7858	18-3075	18-15435
AQ 131 A	18-7878-1	18-7862 18-7858	18-3075	18-15435
AQ 131 B	18-7878-1	18-7862 18-7858	18-3075	18-15435
AQ 131 C	18-7878-1	18-7862 18-7858	18-3075	18-15435
AQ 131 D	18-7878-1	18-7862 18-7858	18-3075	18-15435
230A	18-7878-1	18-7862 18-7858	18-3075	18-15435
230B	18-7878-1	18-7862 18-7858	18-3075	18-4044

Model No.	Oil Filter	Fuel Filter	Impeller	Drive Belt
BB 140 A	18-7878-1	18-7862 18-7858	18-3075	18-4044
AQ 140 A	18-7878-1	18-7862 18-7858	18-3075	18-4044
BB 145 A	18-7878-1	18-7862 18-7858	18-3075	18-4044
AQ 145 A	18-7878-1	18-7862 18-7858	18-3075	18-4044
AQ 145 B	18-7878-1	18-7862 18-7858	18-3075	18-15435
AQ 151 A	18-7878-1	18-7862 18-7858	18-3075	18-15435
AQ 151 B	18-7878-1	18-7862 18-7858	18-3075	18-15435
AQ 151 C	18-7878-1	18-7862 18-7858	18-3075	18-15435
250 A	18-7878-1	18-7862 18-7858	18-3075	18-4044
250 B	18-7878-1	18-7862 18-7858	18-3075	18-4044
AQ 171 A	18-7878-1	18-7862 18-7858	18-3075	18-15435
AQ 171 C	18-7878-1	18-7862 18-7858	18-3075	18-15435
251 A	18-7878-1	18-7862 18-7858	18-3075	18-4044
3.0 GL	18-7824-2	—	18-3060	—
3.0 GS	18-7824-2	—	18-3060	—
AQ 175 A	18-7879-1	18-7862 18-7858	18-3081	18-4046
430 A	18-7879-1	18-7862 18-7858	18-3081	18-4046
430 B	18-7879-1	18-7862 18-7858	18-3081	18-4046
AQ 190A	18-7875	—	18-3061	—
AQ 200 B	18-7824-2	18-7862 18-7858	18-3060	18-4046 Ⓢ
AQ 200 C	18-7824-2	18-7862 18-7858	18-3060	18-4046 Ⓢ
AQ 200 D	18-7824-2	18-7862 18-7858	18-3081	18-4046
AQ 200 F	18-7824-2	18-7862 18-7858	18-3081	18-4046
AQ 205 A	18-7879-1	18-7845 18-7858 18-7845	—	18-4046
431 A	18-7879-1	18-7858	—	18-4046
431 B	18-7879-1	18-7845 18-7858	18-3081	18-4046
432 A	18-7879-1	18-7845 18-7858	18-3081	—
434 A	18-7879-1	18-7845 18-7858	18-3081	—
4.3 GL	18-7879-1	—	18-3060	—

Ⓢ Alternator

TUNE-UP APPLICATION FOR GAS ENGINE MODELS



Model No.	Oil Filter	Fuel Filter	Impeller	Drive Belt
4.3 GS	18-7879-1	—	18-3060	—
4.3 GI	18-7879-1	—	18-3081	—
AQ 211 A	18-7824-2	18-7858	18-3081	18-4046
500 A	18-7824-2	18-7845 18-7858	18-3081	18-4046
500 B	18-7824-2	18-7845 18-7858	18-3081	18-4046
AQ 225 B	18-7824-2	18-7862	18-3060	18-4046 Ⓢ
AQ 225 C	18-7824-2	18-7862 18-7858	18-3060	18-4046 Ⓢ
AQ 225 D	18-7824-2	18-7862 18-7858	—	18-4046
AQ 225 E	18-7824-2	18-7862 18-7858	—	18-4046
AQ 225 F	18-7824-2	18-7862 18-7858	—	18-4046
BB 225 A	18-7824-2	18-7862 18-7858	18-3081	—
BB 225 B	18-7824-2	18-7862 18-7858	18-3081	18-4046
BB 225 C	18-7824-2	18-7845 18-7858	18-3081	18-4046
AQ 231 A	18-7824-2	18-7845 18-7858	18-3081	18-4046
AQ 231 B	18-7824-2	18-7845 18-7858	18-3081	18-4046
BB 231 A	18-7824-2	18-7845 18-7858	—	18-4046
501 A	18-7824-2	18-7845 18-7858	18-3081	18-4046
501 B	18-7824-2	18-7845 18-7858	18-3081	18-4046
5.0 FL	18-7875	—	18-3060	18-3081
5.0 FI	18-7875	—	18-3060	18-3081
5.7 GL	18-7824-2	—	18-3060	—
5.7 GI	18-7824-2	—	18-3060	—
5.8 FL	18-7875	—	18-3060	18-3081
5.8 FI	18-7875	—	18-3060	18-3081
5.8 FSI	18-7875	—	18-3060	18-3081
AQ 240 A	18-7875	—	18-3061	—
AQ 255 A	18-7824-2	18-7862 18-7858	—	18-4046
AQ 255 B	18-7824-2	18-7862 18-7858	18-3081	18-4046

Model No.	Oil Filter	Fuel Filter	Impeller	Drive Belt
AQ 260 A	18-7824-2	18-7862 18-7858	18-3081	18-4046
AQ 260 B	18-7824-2	18-7862 18-7858	—	18-4046
BB 260 A	18-7824-2	18-7862 18-7858	18-3081	18-4046
BB 260 B	18-7824-2	18-7862 18-7858	18-3081	18-4046
BB 260 C	18-7824-2	18-7862 18-7858	18-3081	18-4046
BB 261 A	18-7824-2	18-7845 18-7858	18-3081	18-4046
AQ 271 A	18-7824-2	18-7845 18-7858	18-3081	18-4046
AQ 271 B	18-7824-2	18-7845 18-7858	18-3081	18-4046
AQ 271 C	18-7824-2	18-7845 18-7858	18-3081	18-4046
AQ 271 D	18-7824-2	18-7845 18-7858	18-3081	18-4046
570 A	18-7824-2	18-7845 18-7858	18-3081	18-4046
572 A	18-7824-2	18-7845 18-7858	18-3081	18-4046
570 A/MS 4A	18-7824-2	18-7845 18-7858	18-3081	18-4046
AQ 280 A	18-7824-2	18-7862 18-7858	18-3081	18-4046
AQ 290 A	18-7824-2	18-7862 18-7858	18-3081	18-4046
AQ 311 A	18-7824-2	18-7845 18-7858	18-3081	18-4046
AQ 311 B	18-7824-2	18-7845 18-7858	18-3081	—
571 A	18-7824-2	18-7858	18-3081	18-4046
740 A	—	18-7845	—	—
740 B	18-7824-2	18-7845	—	—
7.4 GL	18-7824-2	—	18-3081 18-3060	—
7.4 GI	18-7824-2	—	18-3081	—
7.4 GSI	18-7824-2	—	18-3081	—
8.2 GL	18-7824-2	—	18-3081 18-3060	—

Ⓢ Alternator

VOLVO PENTA APPLICATION GUIDE























TUNE-UP APPLICATION FOR DIESEL ENGINE MODELS



Model No.	Oil Filter	Fuel Filter	Impeller	Drive Belt
2001, B	18-7884	18-7858	18-3076	—
2002, B	18-7884	18-7858	18-3076	—
2003, B	18-7884	18-7858	18-3076	—
2003 T,TB	18-7884	18-7858	18-3081	—
MD 2010 A,B	—	18-7858	18-3079	—
MD 2020 A,B	—	18-7858	18-3079	—
MD 2030 A,B	—	18-7858	18-3080	—
MD 2040 A,B	—	18-7858	18-3080	—
MD 1	—	—	18-3079 ②	—
MD 1 B	18-7884	—	18-3079	—
MD 2	18-7884	—	18-3079 ③	—
MD 2 B	18-7884	—	18-3079	—
AQD 2 B	18-7884	—	18-3079	—
MD 3 B	18-7884	—	18-3080	—
MD 5 A	18-7884	—	18-3076	—
MD 5 B	18-7884	—	18-3076	—
MD 5 C	18-7884	—	18-3076	—
MD 6 A	18-7884	—	18-3079	—
MD 6 B	18-7884	—	18-3076	—
MD 7 A	18-7884	—	18-3076	—
MD 7 B	18-7884	—	18-3076	—
MD 11 C	18-7884	—	18-3076	—
MD 11 D	18-7884	—	18-3076	—
MD 17 C	18-7884	—	18-3080	—
MD 17 D	18-7884	—	18-3080	—
MD 22 A	—	—	18-3081	—
MD 22 L-A	—	—	18-3081	—
TMD 22 A	—	—	18-3081	—
AQD 21 A	—	18-7858	18-3081 ④ 18-3075 ⑤	18-15460
MD 21 A	—	18-7858	18-3081 ④ 18-3075 ⑤	18-15460
AQD 21 B	—	18-7858	18-3081 ④ 18-3075 ⑤	18-15460
MD 21 B	—	18-7858	18-3081 ④ 18-3075 ⑤	18-15460
AQD 32 A	—	18-7858	18-3077	—
MD 32 A	—	18-7858	18-3077	—
MD 30 A	18-7878-1	—	18-3077	—
TMD 30 A	18-7878-1	—	18-3077	—
TAMD 30 A	18-7878-1	—	18-3077	—
AQAD 30 A	18-7878-1	—	18-3077	—
MD 31 A	18-7878-1	—	18-3077	—
TMD 31 A	18-7878-1	—	18-3077	—
AQAD 31 A	18-7878-1	—	18-3077	—
AD 31 A	18-7878-1	—	18-3077	—
TMD 31 B	18-7878-1	—	18-3077	—
TAMD 31 B	18-7878-1	—	18-3077	—
AD 31 B	18-7878-1	—	18-3077	—

Model No.	Oil Filter	Fuel Filter	Impeller	Drive Belt
TMD 31 D	18-7878-1	—	18-3077	—
TAMD 31 D	18-7878-1	—	18-3077	—
AD 31 D	18-7878-1	—	18-3077	—
AD 31 XD	18-7878-1	—	18-3077	—
TMD 31 L-A	18-7878-1	—	18-3077	—
TAMD 31 P,L,M-A	18-7878-1	—	18-3077	—
AD 31 P,L-A	18-7878-1	—	18-3077	—
MD 40 A	—	—	18-3077	—
TMD 40 A	—	—	18-3077	—
AQD 40 A	—	—	18-3077	—
TAMD 40 A	—	—	18-3078	—
AQAD 40 A	—	—	18-3078	—
TMD 40 B	—	—	18-3077	—
TAMD 40 B	—	—	18-3078	—
AQAD 40 B	—	—	18-3078	—
TMD 40 C	—	—	18-3077	—
TMD 41 A	—	—	18-3077	—
AQD 41 A	—	—	18-3077	—
D 41 A	—	—	18-3077	—
TAMD 41 A	—	—	18-3077	—
AQAD 41 A	—	—	18-3077	—
AD 41 A	—	—	18-3077	—
TMD 41 B	—	—	18-3077	—
D 41 B	—	—	18-3077	—
TAMD 41 B	—	—	18-3077	—
AD 41 B	—	—	18-3077	—
KAMD 42 A	—	—	18-3077	—
KAD 42 A	—	—	18-3077	—
TMD 41 D	—	—	18-3077	—
D 41 D	—	—	18-3077	—
TAMD 41 D	—	—	18-3077	—
AD 41 D	—	—	18-3077	—
TMD 41 L-A	—	—	18-3077	—
D 41 L-A	—	—	18-3077	—
TAMD 41 P,L,M,H-A	—	—	18-3077	—
KAMD 42 B	—	—	18-3077	—
KAD 42 B	—	—	18-3077	—
KAMD 42 P-A	—	—	18-3077	—
KAD 42 P-A	—	—	18-3077	—

- ② S/N 14016 & up
- ③ S/N 4211- & up
- ④ S/N 103386 & below
- ⑤ S/N 103387 & up

 <p>18-5246 TUNE-UP KIT For: Delco HVS V-6 Distributors</p>	 <p>18-5247 TUNE-UP KIT Replaces: 898253T29 For: Delco HVS V-8 Distributors</p>	 <p>18-5256 TUNE-UP KIT — CONTAINS — Part # O.E.# Description 18-5314 835304 Contact Set 18-5338 835308-8 Condenser 18-5411 841243 Rotor</p>	 <p>18-5260 TUNE-UP KIT — CONTAINS — Part # O.E.# Description 18-5303 835705, 855846-2 Contact Set 18-5345 835704 Condenser 18-5403 855845 Rotor Prestolite</p> <p>①18-5260D Display Package</p>	
 <p>18-5264 TUNE-UP KIT — CONTAINS — Part # O.E.# Description 18-5303 835705, 855846-2 Contact Set 18-5345 835704 Condenser 18-5425 834975 Rotor V-8 with Prestolite clip-down cap</p>	 <p>18-5265 TUNE-UP KIT — CONTAINS — Part # O.E.# Description 18-5305 243799, 1306169, Contact Set 243460 18-5348 834560 Condenser 18-5428 243903 Rotor</p>	 <p>18-5266 TUNE-UP KIT Fits: Flame Thrower Distributors 18-5481, 18-5482, 18-5483, 18-5477, 18-5478, 18-5479</p> <p>Flame Thrower</p>	 <p>18-5284 TUNE-UP KIT — CONTAINS — Part # O.E.# Description 18-5305 243799, 1306169, Contact Set 243460 18-5349 841262 Condenser 18-5428 243903 Rotor Bosch 4 cyl.</p> <p>①18-5284D Display Package</p>	
 <p>18-5303 CONTACT SET Replaces: 835705, 855846-2</p>	 <p>18-5305 CONTACT SET Replaces: 241664, 243460, 243799, 1306169</p>	 <p>18-5306 CONTACT SET Replaces: 240149</p>	 <p>18-5310 CONTACT SET Replaces: 818701-5</p>	
 <p>18-5314 CONTACT SET Replaces: 835304</p>	 <p>18-5319 CONTACT SET Replaces: 243801</p>	 <p>18-5338 CONDENSER Replaces: 835308</p>	 <p>18-5345 CONDENSER Replaces: 835704</p>	 <p>18-5349 CONDENSER Replaces: 841262 For: Bosch Distributors</p>
 <p>18-5348 CONDENSER Replaces: 834560</p>	 <p>18-5245 ROTOR Replaces: 3858977 For: Delco HVS Distributors</p>	 <p>18-5402 ROTOR Replaces: 3862014 For: Delco EST V-8 Distributors</p>	 <p>18-5403 ROTOR Replaces: 855845, 841907, 3853801</p>	 <p>18-5404-1 ROTOR</p>

SEE PAGES 954-956 FOR APPLICATION

① Items ending in "D" are Display Packaged - Regular number is Non-Display

 <p>18-5474 DISTRIBUTOR CAP Red Distributor Cap with Male Terminals for Flamethrower Distributors</p>	 <p>18-5243 DISTRIBUTOR CAP Replaces: 3859019 For: Delco HVS V-6 Distributors</p>	 <p>18-5244 DISTRIBUTOR CAP Replaces: 3858975 For: Delco HVS V-8 Distributors</p>	 <p>18-7492 COIL Replaces: 3854161 For: 1998 applications</p>	 <p>18-7493 COIL Replaces: 3859078 For: 8.1L 2001-2007</p>
 <p>18-5745 IGNITION COIL Replaces: 3287677 Fits: AQ171A, AQ171C 251A (1988-92)</p>	 <p>18-7648 IGNITION COIL Replaces: 3861267 Fits: 8.1GI-A, 8.1GI-B, 8.1GI-BF, 8.1GI-C, 8.1GI-CF, 8.1GI-D, 8.1GI-DF, 8.1GSI-A, 8.1GXI-A, 8.1GXI-AF, 8.1GXI-B, 8.1GXI-BF, 8.1GXI-C</p>	 <p>18-5433 IGNITION COIL Replaces: 835998 Uses External Resistor</p>	 <p>18-5436 IGNITION COIL 3.0 ohm Replaces: 35254 Has Internal Resistor</p>	 <p>18-5437 IGNITION COIL Replaces: 3852217 Metal Encased - 12 Volt Uses External Resistor (For All Applications) For: 1990 & prior star drives with breaker point ignition</p>
 <p>18-5467 IGNITION COIL Replaces: 21436799 Fits: Engines equipped with Delco HVS distributor w/ extended bracket.</p>	 <p>18-5443 IGNITION COIL Replaces: 3854002 3.0L/4.3L/5.7L/7.4L</p>	 <p>18-5107-1 IGNITION MODULE Replaces: 3854003</p>	 <p>18-5108 PICK-UP COIL SENSOR Replaces: 3854001 For: GM EST</p>	
 <p>18-7757 THROTTLE POSITION SENSOR Replaces: 3855296 Fits: 1995-2001</p>	 <p>18-7642 PICK-UP ASSEMBLY Replaces: 3863130 Fits: 3.0, 4.3, 5.0, 5.7L models (2002-07)</p>	 <p>18-7643 CAMSHAFT SENSOR 3-pin Replaces: 3859082 Fits: 8.1GI-A, 8.1GI-B, 8.1GI-BF, 8.1GI-C, 8.1GI-CF, 8.1GI-D, 8.1GI-DF, 8.1GSI-A, 8.1GXI-A, 8.1GXI-AF, 8.1GXI-B, 8.1GXI-BF, 8.1GXI-C, 8.1GI-E, 8.1GI-EF, 8.1GXI-D, 8.1GXI-DF, 8.1OSI-A, 8.1OSI-AF, 8.1GI-E, 8.1GXI-D (2001-07)</p>	 <p>18-7706 CRANKSHAFT POSITION SENSOR Replaces: 3858979 Fits: 4.3, 5.0, 5.7L models</p>	

FEATURES

- ★ Oil filled for better cooling and long life
- ★ Low resistance and improved turn ratios produces the higher voltage needed to run larger spark plug gaps for added power and better fuel economy
- ★ More windings maximize energy and reliability over the full RPM range
- ★ Fits existing brackets for easy installation

 <p>18-5466 HI-PERFORMANCE IGNITION COIL 1.5 ohm (oil filled), black - 8 cylinder; Flame-Thrower 40,000 volt coil. ★ Designed for use with the original Ignitor Electronic Conversion Kits ★ Can be used with other inductive ignition systems</p>	 <p>18-5469 HI-PERFORMANCE IGNITION COIL 3.0 ohm (oil filled), black - 4 & 6 cylinder; Flame-Thrower 40,000 volt coil. ★ Designed for use with the original Ignitor Electronic Conversion Kits ★ Can be used with other inductive ignition systems</p>	 <p>18-5472 HI-PERFORMANCE IGNITION COIL 0.5 ohm (oil filled), black - 4, 6, & 8 cylinder; Flame-Thrower 45,000 volt coil. ★ Super low 0.6 ohm resistance coil designed for use with the Ignitor II Hi Performance Electronic Conversion Kits ★ Compatible with capacitive discharge systems</p>
--	--	--

Part #	Description	Recommended Coil	Resistance Ohms	Part #	Description	Recommended Coil	Resistance Ohms
18-5294	Electronic Conversion Kit	18-5469	3.0	18-5289	Hi Performance Electronic Conversion Kit	18-5472	0.6
18-5295	Electronic Conversion Kit	18-5469	3.0	18-5483	Flame-Thrower Distributor	18-5472	0.6
18-5299	Electronic Conversion Kit	18-5466	1.5				



FEATURES

- ★ *Distributors feature the Ignitor II ignition module with adaptive dwell control adjusts the spark timing over the entire RPM range to maximize performance*
- ★ *Upper roller bearing and oil impregnated bronze sintered bottom bushing are installed and aligned bored for accuracy for maximum durability*
- ★ *Machined heat treated gear with tight tolerances insures durability and consistent timing to maximize horsepower and performance. Complete with high dielectric strength cap and rotor for years of performance*

Standard Rotation

CCW Rotation

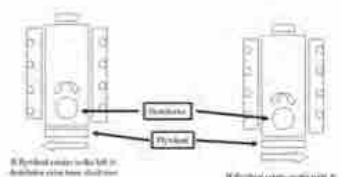

18-5483 HI-PERFORMANCE ELECTRONIC DISTRIBUTOR

Fits: Chevrolet Marine Small and Big Block engines
(Standard Deck Height)
Replacement cap/rotor kit 18-5286



**18-5498-2
DISTRIBUTOR**
Replaces: 9-26307; Mallory YLM624BV
For GM V8, 482, 502, 540 CID (Except 348, 409 & Tall Deck Big Block)



18-5475 DISTRIBUTOR

Fits: 4 Cyl GM w/ Delco EST Ignition
Tune-Up Kit 18-5280



18-5476 DISTRIBUTOR

Fits: GM V6 Engines with Delco EST Ignition HEI
Tune-Up Kit 18-5278



18-5484-1 ELECTRONIC DISTRIBUTOR (Late HEI)

Replaces: 3857449
For Conventional Rotation V6/LH 262-454 & 502
(Except 348/409 and Tall Block Engines)
• Designed as plug-in replacement for GM-style fuel
ignition system distributor
Tune-Up Kit 18-5281

— CONTAINS —
Description Part #
Distributor Cap 18-5354
Rotor 18-5405



18-5494-2 ELECTRONIC DISTRIBUTOR

Replaces: Mallory YLM624AV
Conventional Rotation

For Chevrolet all V8 includes 482, 502, 540 CID
(Except 348, 409 & Tall Deck Big Block)

— CONTAINS —

Part #	Description
18-5376	Distributor Cap
18-5488	Module
18-5404-1	Rotor



18-5480 COMPLETE IGNITION CONVERSION KIT

Fits: GM SB & BB with Standard Deck Height

— CONTAINS —

Part #	Description
18-5472	Coil
18-8803-2	Wire Set
18-5483	Distributor



18-5477 ELECTRONIC DISTRIBUTOR

Fits: Ford 302 V-8 engines
Replacement Cap/Rotor Kit 18-5266



18-5478
ELECTRONIC DISTRIBUTOR
Fits: Chrysler LA series V-8 engines
Replacement Cap/Rotor Kit 18-5266



18-5479
ELECTRONIC DISTRIBUTOR
Fits: GM V-8 engines-reverse rotation
Replacement Cap/Rotor Kit 18-5266

Ignitor® II
ELECTRONIC IGNITION

FEATURES

- ★ Senses current levels in the coil and adjusts the dwell to maintain peak energy throughout the entire RPM range.
- ★ Develops, on average, 4 times more available energy between 3000 and 5000 RPM's and twice as much plug voltage as point-type systems.
- ★ Ignition energy is sustained and coil life is increased when peak current level is reached just prior to spark.
- ★ More stable timing.
- ★ Use with 18-5472 "Flame Thrower II" Coil for optimum performance



18-5240
HI-PERFORMANCE ELECTRONIC CONVERSION KIT
Fits: Prestolite IDU-7801 Distributors



18-5288
HI-PERFORMANCE ELECTRONIC CONVERSION KIT
Fits: Most Prestolite V-8 Distributors with snap down cap



18-5289
HI-PERFORMANCE ELECTRONIC CONVERSION KIT
Fits: Most Prestolite V-8 Distributors with screw down cap

IGNITOR
ELECTRONIC IGNITION

FEATURES

- ★ Replaces points & condensers for true solid state ignition.
- ★ Uses standard coil, cap and rotor.
- ★ Easy to install, one-piece, 2-wire hook-up.
- ★ Accurate to within 1/4° timing accuracy 0 to 6000 RPM range.

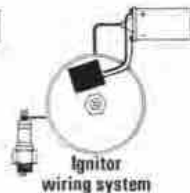

18-5239
ELECTRONIC CONVERSION KIT
Fits: Prestolite IDU-7801 Distributors



18-5292
ELECTRONIC CONVERSION KIT
Fits: 4 Cylinder Volvo AQ Models with Bosch Ignition(Dist # 0231178017)



18-5294
ELECTRONIC CONVERSION KIT
Fits: (6 Cyl.) Delco distributors



18-5295
ELECTRONIC CONVERSION KIT
Fits: Most 4 Cyl. Prestolite distributors (except IBM7026) For: Onan, Universal, Waukesha, Wisconsin



18-5299D Display Package
ELECTRONIC CONVERSION KIT
Fits: 8 (Cyl.) AQ200A, B, AQ225A, B and All 8 Cyl. w/Prestolite Dist # IBM-7013A
Use with 18-5403 style rotor

① Items ending in "D" are Display Packaged - Regular number is Non-Display

PREMIUM MARINE IGNITION WIRES

Sierra's MAGFORCE Ignition Wires are "Electronics Friendly" protecting all of your electronic devices and electronic engine controls from RFI and EMI while delivering the maximum amount of voltage. Exact fit design ensures easy installation and years of trouble - free service.



VOLVO MARINE IGNITION WIRES APPLICATION

Model	Cyl.	Distributor	Year Start	Year End	Plug Wire Set
AQ115A, B	4	Volvo	1969	1975	18-28050
AQ120B	4	Volvo	1977	1980	18-8813-1
AQ125A, B	4	Volvo	1981	1985	18-8813-1
AQ130A, B, C, D	4	Volvo	1968	1977	18-28050
AQ131A, B, C, D	4	Volvo	1985	1989	18-8813-1
AQ140A	4	Volvo	1975	1979	18-8813-1
AQ145A, B	4	Volvo	1979	1985	18-8813-1
AQ151A, B, C	4	Volvo	1985	1989	18-8813-1
AQ175A	6	Volvo	1981	1985	18-8801-1
AQ190A	8	Volvo	1976	1977	18-8802-1
AQ200B	8	Mallory (Tail Cap)	1974	1976	18-8802-1
AQ200B	8	Mallory (Flat Cap)	1974	1976	18-8823-1
AQ200C	9	Mallory (Tail Cap)	1976	1977	18-8802-1
AQ200C	8	Mallory (Flat Cap)	1976	1977	18-8823-1
AQ205A	6	Volvo	1988	1989	18-8801-1
AQ211A	8	Volvo	1986	1989	18-8802-1
AQ225B	8	Mallory (Tail Cap)	1974	1976	18-8802-1
AQ225B	8	Mallory (Flat Cap)	1974	1976	18-8823-1

VOLVO MARINE IGNITION WIRES APPLICATION

Model	Cyl.	Distributor	Year Start	Year End	Plug Wire Set
AQ231A, B	8	Volvo	1986	1989	18-8802-1
AQ240A	8	Volvo	1976	1977	18-8802-1
AQ255A	8	Mallory (Flat Cap)	1977	1978	18-8823-1
AQ255B	8	Mallory (Tail Cap)	1978	1978	18-8802-1
AQ255B	8	Mallory (Flat Cap)	1978	1978	18-8823-1
AQ260A	8	Mallory (Tail Cap)	1979	1985	18-8802-1
AQ260A	8	Mallory (Flat Cap)	1979	1985	18-8823-1
AQ260B	8	Mallory (Tail Cap)	1985	1986	18-8802-1
AQ271A, B, C, D	8	Volvo	1986	1989	18-8802-1
AQ280A	8	Mallory (Tail Cap)	1978	1979	18-8802-1
AQ280A	8	Mallory (Flat Cap)	1978	1979	18-8823-1
AQ290A	8	Mallory (Tail Cap)	1979	1985	18-8802-1
AQ290A	8	Mallory (Flat Cap)	1979	1985	18-8823-1
AQ311A, B	8	Volvo	1986	1989	18-8802-1
BB140A	4	Volvo	1975	1979	18-8813-1
BB145A	4	Volvo	1979	1985	18-8813-1
BB225A, AV, B, C	8	Volvo	1973	1977	18-8802-1
BB231A	8	Volvo	1987	1987	18-8802-1

APPLICATION CONTINUED ON NEXT PAGE

VOLVO MARINE IGNITION WIRES APPLICATION

Model	Cyl.	Distributor	Year Start	Year End	Plug Wire Set
BB260A, AV, B, C	8	Volvo	1978	1985	18-8802-1
BB261A	8	Volvo	1988	1989	18-8802-1
230A, B	4	Volvo	1989	1992	18-8813-1
250A, B	4	Volvo	1988	1992	18-8813-1
432A	6	Delco EST	1992	1993	18-8835-1
434A	6	Delco EST	1992	1993	18-8835-1
3.0GLM	4	Delco EST	1993	1994	18-8833-1
3.0GLM	4	Delco EST	2002	2004	18-8833-1
3.0GLP	4	Delco EST	2002	2010	18-8833-1
3.0GSM	4	Delco EST	1994	2002	18-8833-1
3.0GSP	4	Delco EST	1993	2002	18-8833-1
3.0GXl	4	Delco EST	2008	2009	18-8833-1
4.3GI	6	Delco EST	1994	2000	18-8835-1
4.3GL	6	Delco EST	1993	2010	18-8835-1
4.3GS	6	Delco EST	1993	1999	18-8835-1
4.3GXl	6	Delco HVS	2001	2015	18-8829-1
4.3GXl	6	Delco EST	2001	2002	18-8835-1
4.3GXIE	6	Delco HVS	2009	2015	18-8829-1
4.3SI	6	Delco HVS	2001	2009	18-8829-1
4.3SI-BF	6	Delco HVS	2001	2002	18-8829-1
5.0FI	8	Ford	1994	1996	18-8820-1
5.0FL	8	Prestolite	1994	1996	18-8802-1
5.0GI	8	Delco EST	1997	2000	18-8836-1
5.0GL	8	Prestolite	1997	2001	18-8802-1
5.0GL	8	Delco EST	2001	2006	18-8836-1
5.0GXl	8	Delco HVS	2001	2015	18-8828-1
5.0GXl-A	8	Delco EST	2001	2002	18-8836-1
5.0GXIC	8	Delco HVS	2007	2009	18-8828-1
5.0GXIE	8	Delco HVS	2007	2015	18-8828-1
5.0OSI	8	Delco HVS	2001	2009	18-8828-1
5.0OSIE	8	Delco HVS	2008	2009	18-8828-1
5.7GI	8	Delco EST	1993	1997	18-8836-1
5.7GI	8	Delco HVS	2001	2015	18-8828-1
5.7GI	8	Delco EST	2004	2005	18-8836-1
5.7GiC	8	Delco HVS	2008	2009	18-8828-1
5.7GICE	8	Delco HVS	2008	2009	18-8828-1
5.7GiE	8	Delco HVS	2007	2015	18-8828-1
5.7GIL	8	Delco HVS	2002	2009	18-8828-1
5.7GIL-A	8	Delco EST	2001	2001	18-8836-1
5.7GL	8	Prestolite	1993	1997	18-8802-1
5.7GL	8	Delco EST	1993	1997	18-8836-1
5.7GL	8	Delco EST	2001	2004	18-8836-1
5.7GL-A	8	Mallory	2001	2001	18-8802-1
5.7GSI	8	Delco EST	1996	2001	18-8836-1
5.7GSP	8	Prestolite	1996	2000	18-8802-1

VOLVO MARINE IGNITION WIRES APPLICATION

Model	Cyl.	Distributor	Year Start	Year End	Plug Wire Set
5.7GXl	8	Delco HVS	2001	2015	18-8828-1
5.7GXl-A, B	8	Delco EST	2000	2002	18-8836-1
5.7GXIC	8	Delco HVS	2007	2008	18-8828-1
5.7GXICE	8	Delco HVS	2007	2010	18-8828-1
5.7GXIE	8	Delco HVS	2007	2015	18-8828-1
5.7GXIL	8	Delco HVS	2001	2008	18-8828-1
5.7GXIL-A, B	8	Delco EST	2000	2002	18-8836-1
5.7OSI	8	Delco HVS	2001	2009	18-8828-1
5.7OSIE	8	Delco HVS	2008	2009	18-8828-1
5.7OSXI	8	Delco HVS	2001	2009	18-8828-1
5.7OSXIE	8	Delco HVS	2008	2009	18-8828-1
5.8FI	8	Ford	1994	1996	18-8820-1
5.8FL	8	Prestolite	1994	1996	18-8803-1
5.8FSI	8	Prestolite	1994	1996	18-8803-1
7.4GI	8	Delco EST	1994	2000	18-8836-1
7.4GL	8	Prestolite	1993	1997	18-8802-1
7.4GLI	8	Prestolite	1993	1996	18-8802-1
7.4GLP	8	Prestolite	1993	1997	18-8802-1
7.4GLP	8	Prestolite	1994	1997	18-28051
7.4GLP	8	Delco EST	1995	1996	18-8836-1
7.4GSI	8	Delco EST	1994	2000	18-8836-1
8.1GI-A	8	Distributorless	1999	2015	18-8838-1
8.1GiC	8	Distributorless	2007	2015	18-8838-1
8.1GiCE	8	Distributorless	2007	2015	18-8838-1
8.1GiE	8	Distributorless	2007	2015	18-8838-1
8.1GIL	8	Distributorless	2000	2008	18-8838-1
8.1GSI	8	Distributorless	2000	2001	18-8838-1
8.1GXl	8	Distributorless	2001	2015	18-8838-1
8.1GXIE	8	Distributorless	2007	2015	18-8838-1
8.1GXil	8	Distributorless	2001	2008	18-8838-1
8.1IPSCE	8	Distributorless	2006	2015	18-8838-1
8.1OSI	8	Distributorless	2003	2009	18-8838-1
8.1OSIE	8	Distributorless	2008	2009	18-8838-1
8.2GLI	8	Prestolite	1993	1994	18-8803-1
8.2GLP	8	Prestolite	1993	1994	18-8803-1
8.2GSI	8	Delco EST	1995	2000	18-8836-1
DPX375	8	Distributorless	2000	2002	18-8838-1
DPX385	8	Delco EST	1996	2000	18-8836-1
DPX415	8	Delco EST	1996	2000	18-8836-1
DPX420	8	Distributorless	2000	2002	18-8838-1
V6-200	6	Delco HVS	2012	2015	18-8828-1
V6-225	6	Delco HVS	2012	2015	18-8828-1
V6-270	8	Delco HVS	2012	2015	18-8829-1
V8-300	8	Delco HVS	2012	2015	18-8829-1
V8-320	8	Delco HVS	2012	2015	18-8829-1



BATTERY CABLES
Gauge cable with soldered lug terminals on each end to accept a 3/8" stud.

Part No.	Size	Color	Gauge
BC88523	2'	red	4
BC88533	2'	black	4
BC88543	4'	red	2
BC88553	4'	black	2
BC88563	6'	red	2
BC88573	6'	black	2
BC88583	8'	red	1
BC88593	8'	black	1



18-5225 SPARK PLUG WIRE KIT
Replaces: Mercury 84-99215A26, 84-813706A26
Kit includes 25 ft. roll of 7mm Hypalon Ignition Wire With a Metallic Core and a large assortment of three different end fittings.



18-5226
IGNITION WIRE
Metallic Core
100' Spool
7mm Hypalon



18-26810
GM HEI 4 TERMINAL
PIGTAIL
Fits: GM HEI Distributors w/4 terminals



18-26811
GM HEI 2 TERMINAL
PIGTAIL
Fits: GM HEI Distributors w/2 terminals



18-26812
HEI COIL GRAY
CONNECTOR



18-26813
HEI COIL BLACK
CONNECTOR

PKG. OF 10



18-5224
18-5224-9
SPARK PLUG WIRE
TERMINAL
Replaces: Mercury 20121
OMC 510364

PKG. OF 10



18-5750
18-5750-9
UNIVERSAL SPARK
PLUG BOOTS
Supplied complete w/Terminal
Connector
Replaces: OMC 581027,
580339



18-5752
UNIVERSAL
SPARK PLUG BOOT
8mm



18-5657
PROTECTING SLEEVE
Replaces: 855798
Fits: Most Volvo gas & diesel
engines

① Priced per Package

VOLVO PENTA IGNITION APPLICATION

Model	Distributor	Spark Plug Wire Set	Distributor Cap	Rotor	Pick-Up Coil	ICM	Ignition Coil	Condenser	Contact Points	Tune-Up Kit
AQ100	BOSCH	-	18-5357	18-5428	N/A	N/A	18-5436	-	18-5306	-
AQ110	BOSCH	-	18-5357	18-5428	N/A	N/A	18-5436	-	18-5306	-
AQ115A	0231153010	18-28050	18-5357	18-5428	N/A	N/A	18-5436	-	18-5305	-
AQ115A	0231153012	18-28050	18-5356	18-5428	N/A	N/A	18-5436	-	18-5305	-
AQ115B	0231153010	18-28050	18-5357	18-5428	N/A	N/A	18-5436	-	18-5305	-
AQ115B	0231153012	18-28050	18-5356	18-5428	N/A	N/A	18-5436	-	18-5305	-
AQ120	BOSCH	-	18-5357	18-5428	N/A	N/A	18-5436	-	18-5306	-
AQ120B	0231178017	18-8813-1	18-5358	18-5428	N/A	N/A	18-5436	18-5349	18-5305	18-5284
AQ120B	0231178016	18-8813-1	18-5356	18-5428	N/A	N/A	18-5436	18-5349	18-5305	18-5284
AQ120B	0231178018	18-8813-1	18-5356	18-5428	N/A	N/A	18-5436	18-5349	18-5305	18-5284
AQ125A	ALL	18-8813-1	18-5358	18-5428	N/A	N/A	18-5436	18-5349	18-5305	18-5284
AQ125B	ALL	18-8813-1	18-5358	18-5428	N/A	N/A	18-5436	18-5349	18-5305	18-5284
AQ130A	0231153010	18-28050	18-5357	18-5428	N/A	N/A	18-5436	-	18-5305	-
AQ130A	0231153012	18-28050	18-5356	18-5428	N/A	N/A	18-5436	-	18-5305	-
AQ130B	0231153010	18-28050	18-5357	18-5428	N/A	N/A	18-5436	-	18-5305	-
AQ130B	0231153012	18-28050	18-5356	18-5428	N/A	N/A	18-5436	-	18-5305	-
AQ130C	0231153010	18-28050	18-5357	18-5428	N/A	N/A	18-5436	-	18-5305	-
AQ130C	0231153012	18-28050	18-5356	18-5428	N/A	N/A	18-5436	-	18-5305	-
AQ130D	0231153010	18-28050	18-5357	18-5428	N/A	N/A	18-5436	-	18-5305	-
AQ130D	0231153012	18-28050	18-5356	18-5428	N/A	N/A	18-5436	-	18-5305	-
AQ131A	ALL	18-8813-1	18-5358	18-5428	N/A	N/A	18-5436	-	18-5305	-
AQ131B	ALL	18-8813-1	18-5358	18-5428	N/A	N/A	18-5436	-	18-5305	-
AQ131C	ALL	18-8813-1	18-5358	18-5428	N/A	N/A	18-5436	-	18-5305	-
AQ131D	ALL	18-8813-1	18-5358	18-5428	N/A	N/A	18-5436	-	18-5305	-
AQ140A	0231178017	18-8813-1	18-5358	18-5428	N/A	N/A	18-5436	18-5349	18-5305	18-5284
AQ140A	0231178016	18-8813-1	18-5356	18-5428	N/A	N/A	18-5436	18-5349	18-5305	18-5284
AQ140A	0231178018	18-8813-1	18-5356	18-5428	N/A	N/A	18-5436	18-5349	18-5305	18-5284
AQ145A	ALL	18-8813-1	18-5358	18-5428	N/A	N/A	18-5436	18-5349	18-5305	18-5284
AQ145B	ALL	18-8813-1	18-5358	18-5428	N/A	N/A	18-5436	18-5349	18-5305	18-5284
AQ151A	ALL	18-8813-1	18-5358	18-5428	N/A	N/A	18-5436	18-5349	18-5305	18-5284
AQ151B	ALL	18-8813-1	18-5358	18-5428	N/A	N/A	18-5436	18-5349	18-5305	18-5284
AQ151C	ALL	18-8813-1	18-5358	18-5428	N/A	N/A	18-5436	18-5349	18-5305	18-5284

APPLICATION CONTINUED ON NEXT PAGE

VOLVO PENTA IGNITION APPLICATION (Cont.)

Model	Distributor	Spark Plug Wire Set	Distributor Cap	Rotor	Pick-Up Coil	ICM	Ignition Coil	Condenser	Contact Points	Tune-Up Kit
AQ165A	Q231116054		18-5393	18-5428	N/A	N/A	-	-	-	
AQ165A	Q231116060		18-5393	18-5428	N/A	N/A	-	-	-	
AQ165A	Q231121008		18-5393	18-5428	N/A	N/A	-	-	18-5305	-
AQ165A	Q231311002		18-5394	18-5428	N/A	N/A	-	-	18-5319	-
AQ170A	Q231116054		-	18-5428	N/A	N/A	-	-	-	-
AQ170A	Q231116060		-	18-5428	N/A	N/A	-	-	-	-
AQ170A	Q231121008		-	18-5428	N/A	N/A	-	-	18-5305	-
AQ170A	Q231311002		-	-	N/A	N/A	-	-	18-5319	-
AQ170B	Q231116054		-	18-5428	N/A	N/A	-	-	-	-
AQ170B	Q231116060		-	18-5428	N/A	N/A	-	-	-	-
AQ170B	Q231121008		-	18-5428	N/A	N/A	-	-	18-5305	-
AQ170B	Q231311002		-	-	N/A	N/A	-	-	18-5319	-
AQ170C	Q231116054		18-5393	18-5428	N/A	N/A	-	-	-	-
AQ170C	Q231121008		-	18-5428	N/A	N/A	-	-	18-5305	-
AQ171A	ALL		-	-	N/A	N/A	-	N/A	N/A	-
AQ171C	ALL		-	-	N/A	N/A	-	N/A	N/A	-
AQ175A	ALL	18-8801-1	18-5369	18-5425	N/A	N/A	18-5433	18-5345	18-5303	18-5264
AQ190A	ALL	18-8802-1	18-5369	18-5425	N/A	N/A	-	18-5345	18-5303	18-5264
AQ200B	MALLORY FLAT CAP	18-8823-1	18-5375	18-5411	N/A	N/A	-	18-5338	18-5314	18-5256
AQ200B	MALLORY TALL CAP	18-8802-1	18-5352	18-5403	N/A	N/A	-	18-5345	18-5303	18-5260
AQ200C	MALLORY FLAT CAP	18-8823-1	18-5375	18-5411	N/A	N/A	18-5433	18-5338	18-5314	18-5256
AQ200C	MALLORY TALL CAP	18-8802-1	18-5352	18-5403	N/A	N/A	18-5433	18-5345	18-5303	18-5260
AQ200D	S/N 20459 & BELOW		18-5369	18-5425	N/A	N/A	18-5433	18-5345	18-5303	18-5264
AQ200D	S/N 20460 & UP		18-5352	18-5403	N/A	N/A	18-5433	18-5345	18-5303	18-5260
AQ200F	ALL		18-5352	18-5403	N/A	N/A	18-5433	18-5345	18-5303	18-5260
AQ205A	ALL	18-8801-1	18-5353	18-5403	N/A	N/A	-	-	-	-
AQ211A	ALL	18-8802-1	18-5352	18-5403	N/A	N/A	18-5433	18-5345	18-5303	18-5260
AQ225B	MALLORY FLAT CAP	18-8823-1	18-5375	18-5411	N/A	N/A	-	18-5338	18-5314	18-5256
AQ225B	MALLORY TALL CAP	18-8802-1	18-5352	18-5403	N/A	N/A	-	18-5345	18-5303	18-5260
AQ225C	ALL		18-5375	18-5411	N/A	N/A	18-5433	18-5338	18-5314	18-5256
AQ225D	S/N 20459 & BELOW		18-5369	18-5425	N/A	N/A	18-5433	18-5345	18-5303	18-5264
AQ225D	S/N 20460 & UP		18-5352	18-5403	N/A	N/A	18-5433	18-5345	18-5303	18-5260
AQ225E	ALL		18-5352	18-5403	N/A	N/A	18-5433	18-5345	18-5303	18-5260
AQ225F	ALL		18-5352	18-5403	N/A	N/A	18-5433	18-5345	18-5303	18-5260
AQ231A	ALL	18-8802-1	18-5352	18-5403	N/A	N/A	18-5433	18-5345	18-5303	18-5260
AQ231B	ALL	18-8802-1	18-5352	18-5403	N/A	N/A	18-5433	18-5345	18-5303	18-5260
AQ240A	ALL	18-8802-1	18-5369	18-5403	N/A	N/A	-	18-5345	18-5303	18-5260
AQ255A	MALLORY FLAT CAP	18-8823-1	18-5375	18-5411	N/A	N/A	18-5433	18-5338	18-5314	18-5256
AQ255B	MALLORY FLAT CAP	18-8823-1	18-5375	18-5411	N/A	N/A	18-5433	18-5338	18-5314	18-5256
AQ255B	MALLORY TALL CAP	18-8802-1	18-5352	18-5403	N/A	N/A	18-5433	18-5345	18-5303	18-5260
AQ260A	MALLORY FLAT CAP	18-8823-1	18-5375	18-5411	N/A	N/A	18-5433	18-5338	18-5314	18-5256
AQ260A	MALLORY TALL CAP	18-8802-1	18-5352	18-5403	N/A	N/A	18-5433	18-5345	18-5303	18-5260
AQ260B	MALLORY TALL CAP	18-8802-1	18-5352	18-5403	N/A	N/A	18-5433	18-5345	18-5303	18-5260
AQ271A	ALL	18-8802-1	18-5352	18-5403	N/A	N/A	18-5433	-	-	-
AQ271B	ALL	18-8802-1	18-5352	18-5403	N/A	N/A	-	-	-	-
AQ271C	ALL	18-8802-1	18-5352	18-5403	N/A	N/A	-	-	-	-
AQ271D	ALL	18-8802-1	18-5352	18-5403	N/A	N/A	-	-	-	-
AQ280A	MALLORY FLAT CAP	18-8823-1	18-5375	18-5411	N/A	N/A	-	18-5338	18-5314	18-5256
AQ280A	MALLORY TALL CAP	18-8802-1	18-5352	18-5403	N/A	N/A	-	18-5345	18-5303	18-5260
AQ290A	MALLORY FLAT CAP	18-8823-1	18-5375	18-5411	N/A	N/A	18-5433	18-5338	18-5314	18-5256
AQ290A	MALLORY TALL CAP	18-8802-1	18-5352	18-5403	N/A	N/A	18-5433	18-5345	18-5303	18-5260
AQ311A	ALL	18-8802-1	18-5352	18-5403	N/A	N/A	-	-	-	-
AQ311B	ALL	18-8802-1	18-5352	18-5403	N/A	N/A	-	-	-	-
AQ60F	BOSCH	-	18-5357	18-5428	N/A	N/A	18-5436	-	18-5306	-

APPLICATION CONTINUED ON NEXT PAGE

VOLVO PENTA IGNITION APPLICATION (Cont.)

Model	Distributor	Spark Plug Wire Set	Distributor Cap	Rotor	Pick-Up Coil	ICM	Ignition Coil	Condenser	Contact Points	Tune-Up Kit
AQ90	BOSCH	-	18-5357	18-5428	N/A	N/A	18-5436	-	18-5306	-
AQ95	BOSCH	-	18-5357	18-5428	N/A	N/A	18-5436	-	18-5306	-
AQ95A	BOSCH	-	18-5357	18-5428	N/A	N/A	18-5436	-	18-5306	-
BB100	BOSCH	-	18-5357	18-5428	N/A	N/A	18-5436	-	18-5306	-
BB115A	0231153010	18-28050	18-5357	18-5428	N/A	N/A	18-5436	-	18-5305	-
BB115A	0231153012	18-28050	18-5356	18-5428	N/A	N/A	18-5436	-	18-5305	-
BB115B	0231153010	18-28050	18-5357	18-5428	N/A	N/A	18-5436	-	18-5305	-
BB115B	0231153012	18-28050	18-5356	18-5428	N/A	N/A	18-5436	-	18-5305	-
BB115C	0231153010	18-28050	18-5357	18-5428	N/A	N/A	18-5436	-	18-5305	-
BB115C	0231153012	18-28050	18-5356	18-5428	N/A	N/A	18-5436	-	18-5305	-
BB140A	0231178017	18-8813-1	18-5358	18-5428	N/A	N/A	18-5436	18-5349	18-5305	18-5284
BB140A	0231178016	18-8813-1	18-5356	18-5428	N/A	N/A	18-5436	18-5349	18-5305	18-5284
BB140A	0231178018	18-8813-1	18-5356	18-5428	N/A	N/A	18-5436	18-5349	18-5305	18-5284
BB145A	ALL	18-8813-1	18-5358	18-5428	N/A	N/A	18-5436	18-5349	18-5305	18-5284
BB165A	023116054		18-5393	18-5428	N/A	N/A		-	-	-
BB165A	023116060		18-5393	18-5428	N/A	N/A		-	-	-
BB165A	0231121008		18-5393	18-5428	N/A	N/A		-	18-5305	-
BB165A	0231311002		18-5394	18-5428	N/A	N/A		-	18-5319	-
BB170A	023116054		18-5393	18-5428	N/A	N/A		-	-	-
BB170A	023116060		18-5393	18-5428	N/A	N/A		-	-	-
BB170A	0231121008		18-5393	18-5428	N/A	N/A		-	18-5305	-
BB170A	0231311002		18-5394	18-5428	N/A	N/A		-	18-5319	-
BB170B	023116054		18-5393	18-5428	N/A	N/A		-	-	-
BB170B	023116060		18-5393	18-5428	N/A	N/A		-	-	-
BB170B	0231121008		18-5393	18-5428	N/A	N/A		-	18-5305	-
BB170B	0231311002		18-5394	18-5428	N/A	N/A		-	18-5319	-
BB170C	023116054		18-5393	18-5428	N/A	N/A		-	-	-
BB170C	023116060		18-5393	18-5428	N/A	N/A		-	-	-
BB170C	0231121008		18-5393	18-5428	N/A	N/A		-	18-5305	-
BB170C	0231311002		18-5394	18-5428	N/A	N/A		-	18-5319	-
BB225A	ALL	18-8802-1	18-5352	18-5403	N/A	N/A	18-5433	18-5345	18-5303	18-5260
BB225AV	ALL	18-8802-1	18-5352	18-5403	N/A	N/A	18-5433	18-5345	18-5303	18-5260
BB225B	ALL	18-8802-1	18-5352	18-5403	N/A	N/A	18-5433	18-5345	18-5303	18-5260
BB225C	ALL	18-8802-1	18-5352	18-5403	N/A	N/A	18-5433	18-5345	18-5303	18-5260
BB231A	ALL	18-8802-1	18-5352	18-5403	N/A	N/A	18-5433	18-5345	18-5303	18-5260
BB260A	ALL	18-8802-1	18-5352	18-5403	N/A	N/A	18-5433	18-5345	18-5303	18-5260
BB260AV	ALL	18-8802-1	18-5352	18-5403	N/A	N/A	18-5433	18-5345	18-5303	18-5260
BB260B	ALL	18-8802-1	18-5352	18-5403	N/A	N/A	18-5433	18-5345	18-5303	18-5260
BB260C	ALL	18-8802-1	18-5352	18-5403	N/A	N/A	18-5433	18-5345	18-5303	18-5260
BB261A	ALL	18-8802-1	18-5352	18-5403	N/A	N/A	18-5433	18-5345	18-5303	18-5260
BB30	BOSCH	-	18-5357	18-5428	N/A	N/A	18-5436	-	18-5306	-
MB10A	ALL		-	18-5428	N/A	N/A	18-5436	-	18-5305	-
MB18	BOSCH	-	18-5357	18-5428	N/A	N/A	18-5436	-	18-5306	-
MB18F	BOSCH	-	18-5357	18-5428	N/A	N/A	18-5436	-	18-5306	-
MB20A	ALL		18-5356	18-5428	N/A	N/A	18-5436	-	18-5305	-
MB20B	0231110043	-	18-5357	18-5428	N/A	N/A	18-5436	-	18-5306	-
MB20B	0231178005		18-5356	18-5428	N/A	N/A	18-5436	-	18-5305	-
MB20C	0231110043	-	18-5357	18-5428	N/A	N/A	18-5436	-	18-5306	-
MB20C	0231178005		18-5356	18-5428	N/A	N/A	18-5436	-	18-5305	-
230A	ALL	18-8813-1	18-5358	18-5428	N/A	N/A	18-5436	18-5349	18-5305	18-5265
230B	ALL	18-8813-1	18-5358	18-5428	N/A	N/A	18-5436	18-5349	18-5305	18-5265
250A	ALL	18-8813-1	18-5358	18-5428	N/A	N/A	18-5436	18-5349	18-5305	18-5265
250B	ALL	18-8813-1	18-5358	18-5428	N/A	N/A	18-5436	18-5349	18-5305	18-5265
251A	ALL		-	-	N/A	N/A	-	N/A	N/A	N/A

APPLICATION CONTINUED ON NEXT PAGE

VOLVO PENTA IGNITION APPLICATION (Cont.)

Model	Distributor	Spark Plug Wire Set	Distributor Cap	Rotor	Pick-Up Coil	ICM	Ignition Coil	Condenser	Contact Points	Tune-Up Kit
430A	ALL		18-5353	18-5403	-	N/A	-	N/A	N/A	N/A
430B	ALL		18-5353	18-5403	-	N/A	-	N/A	N/A	N/A
431A	ALL		18-5353	18-5403	-	N/A	-	N/A	N/A	N/A
431B	ALL		18-5353	18-5403	-	N/A	-	N/A	N/A	N/A
432A	DELCO EST	18-8835-1	18-5362	18-5408	18-5108	18-5107-1	-	N/A	N/A	18-5278
434A	DELCO EST	18-8835-1	18-5362	18-5408	18-5108	18-5107-1	-	N/A	N/A	18-5278
500A	ALL		18-5352	18-5403	-	N/A	-	N/A	N/A	N/A
500B	ALL		18-5352	18-5403	-	N/A	-	N/A	N/A	N/A
501A	ALL		18-5352	18-5403	-	N/A	-	N/A	N/A	N/A
501A/MS4	ALL		18-5352	18-5403	-	N/A	-	N/A	N/A	N/A
501B	ALL		18-5352	18-5403	-	N/A	-	N/A	N/A	N/A
570A	ALL		18-5352	18-5403	-	N/A	-	N/A	N/A	N/A
571A	ALL		18-5352	18-5403	-	N/A	-	N/A	N/A	N/A
572A	ALL		18-5352	18-5403	-	N/A	-	N/A	N/A	N/A
740A	ALL		18-5352	18-5403	-	N/A	-	N/A	N/A	N/A
740A/MS5	ALL		18-5352	18-5403	-	N/A	-	N/A	N/A	N/A
740B	ALL		18-5352	18-5403	-	N/A	-	N/A	N/A	N/A
3.0GL	DELCO EST	18-8841-1	18-5361	18-5406	18-5108	18-5107-1	18-5443	N/A	N/A	18-5280
3.0GS	DELCO EST	18-8841-1	18-5361	18-5406	18-5108	18-5107-1	18-5443	N/A	N/A	18-5280
3.0GX	DELCO EST	18-8841-1	18-5361	18-5406	18-5108	18-5117	18-5465	N/A	N/A	18-5280
4.3Gi	DELCO HVS	18-8829-1	18-5243	18-5245	18-7642	18-5117	18-5467	N/A	N/A	18-5246
4.3Gi	DELCO EST	18-8835-1	18-5362	18-5408	18-5108	18-5107-1	18-7648	N/A	N/A	18-5278
4.3GL	DELCO EST	18-8835-1	18-5362	18-5408	18-5108	18-5107-1	18-7648	N/A	N/A	18-5278
4.3GS	DELCO EST	18-8835-1	18-5362	18-5408	18-5108	18-5107-1	18-7648	N/A	N/A	18-5278
4.3GX	DELCO EST	18-8835-1	18-5362	18-5408	18-5108	18-5107-1	18-7648	N/A	N/A	18-5278
4.3GX	DELCO HVS	18-8829-1	18-5243	18-5245	18-7642	18-5117	18-5467	N/A	N/A	18-5246
4.3Si	DELCO HVS	18-8829-1	18-5243	18-5245	18-7642	18-5117	18-5467	N/A	N/A	18-5246
5.0Fi	FORD	18-8820-1	18-5248	18-5413	-	N/A	18-7492	N/A	N/A	N/A
5.0FL	PRESTOLITE	18-8802-1	18-5352	18-5403	-	N/A	18-5437	N/A	N/A	N/A
5.0GIC	DELCO HVS	18-8828-1	18-5244	18-5245	18-7642	18-5117	18-5467	N/A	N/A	18-5247
5.0GI	DELCO EST	18-8836-1	18-5354	18-5405	18-5108	18-5107-1	18-5443	N/A	N/A	18-5281
5.0GL	PRESTOLITE	18-8802-1	18-5352	18-5403	-	N/A	18-5437	N/A	N/A	N/A
5.0GL	DELCO EST	18-8836-1	18-5354	18-5405	18-5108	18-5107-1	18-5443	N/A	N/A	18-5281
5.0GX	DELCO EST	18-8836-1	18-5354	18-5405	18-5108	18-5107-1	18-7648	N/A	N/A	18-5281
5.0GX	DELCO HVS	18-8828-1	18-5244	18-5245	18-7642	18-5117	18-5467	N/A	N/A	18-5247
5.0GXIE	DELCO HVS	18-8828-1	18-5244	18-5245	18-7642	18-5117	18-5467	N/A	N/A	18-5247
5.0OSIE	DELCO HVS	18-8828-1	18-5244	18-5245	18-7642	18-5117	18-5467	N/A	N/A	18-5247
5.0OSI	DELCO HVS	18-8828-1	18-5244	18-5245	18-7642	18-5117	18-5467	N/A	N/A	18-5247
5.7Gi	DELCO EST	18-8836-1	18-5354	18-5405	18-5108	18-5107-1	18-7648	N/A	N/A	18-5281
5.7GIC	DELCO HVS	18-8828-1	18-5244	18-5245	18-7642	18-5117	18-5467	N/A	N/A	18-5247
5.7GICE	DELCO HVS	18-8828-1	18-5244	18-5245	18-7642	18-5117	18-5467	N/A	N/A	18-5247
5.7GIE	DELCO HVS	18-8828-1	18-5244	18-5245	18-7642	18-5117	18-5467	N/A	N/A	18-5247
5.7GI	DELCO HVS	18-8828-1	18-5244	18-5245	18-7642	18-5117	18-5467	N/A	N/A	18-5247
5.7GI	DELCO EST	18-8836-1	18-5354	18-5405	18-5108	18-5107-1	18-5443	N/A	N/A	18-5281
5.7GL	MALLORY	18-8802-1	18-5352	18-5403	-	-	-	N/A	N/A	N/A
5.7GL	DELCO EST	18-8836-1	18-5354	18-5405	18-5108	18-5107-1	18-5443	N/A	N/A	18-5281
5.7GL	PRESTOLITE	18-8802-1	18-5352	18-5403	-	N/A	18-5437	N/A	N/A	N/A
5.7GSI	DELCO EST	18-8836-1	18-5354	18-5405	18-5108	18-5107-1	18-5443	N/A	N/A	18-5281
5.7GSI	DELCO EST	18-8836-1	18-5354	18-5405	18-5108	18-5107-1	18-5443	N/A	N/A	18-5281
5.7GSP	PRESTOLITE	18-8802-1	18-5352	18-5403	-	N/A	18-5437	N/A	N/A	N/A
5.7GX	DELCO EST	18-8836-1	18-5354	18-5405	18-5108	18-5107-1	18-7648	N/A	N/A	18-5281
5.7GXICE	DELCO HVS	18-8828-1	18-5244	18-5245	18-7642	18-5117	18-5467	N/A	N/A	18-5247
5.7GXIC	DELCO HVS	18-8828-1	18-5244	18-5245	18-7642	18-5117	18-5467	N/A	N/A	18-5247
5.7GXIE	DELCO HVS	18-8828-1	18-5244	18-5245	18-7642	18-5117	18-5467	N/A	N/A	18-5247

APPLICATION CONTINUED ON NEXT PAGE

VOLVO PENTA IGNITION APPLICATION (Cont.)

Model	Distributor	Spark Plug Wire Set	Distributor Cap	Rotor	Pick-Up Coil	ICM	Ignition Coil	Condenser	Contact Points	Tune-Up Kit
5.7GX	DELCO HVS	18-8828-1	18-5244	18-5245	18-7642	18-5117	18-5467	N/A	N/A	18-5247
5.7GXII	DELCO HVS	18-8828-1	18-5244	18-5245	18-7642	18-5117	18-5467	N/A	N/A	18-5247
5.7GXII	DELCO EST	18-8836-1	18-5354	18-5405	18-5108	18-5107-1	18-5443	N/A	N/A	18-5281
5.70SI	DELCO HVS	18-8828-1	18-5244	18-5245	18-7642	18-5117	18-5467	N/A	N/A	18-5247
5.70SXI	DELCO HVS	18-8828-1	18-5244	18-5245	18-7642	18-5117	18-5467	N/A	N/A	18-5247
5.8FI	FORD	18-8820-1	18-5248	18-5413	-	N/A	18-7492	N/A	N/A	N/A
5.8FL	PRESTOLITE	18-8803-1	18-5352	18-5403	-	N/A	18-5437	N/A	N/A	N/A
5.8FSI	PRESTOLITE	18-8803-1	18-5352	18-5403	-	N/A	18-5437	N/A	N/A	N/A
7.4GI	DELCO EST	18-8836-1	18-5354	18-5405	18-5108	18-5107-1	18-5443	N/A	N/A	18-5281
7.4GL	PRESTOLITE	18-8802-1	18-5352	18-5403	-	N/A	18-5437	N/A	N/A	N/A
7.4GL	DELCO EST	18-8836-1	18-5354	18-5405	18-5108	18-5107-1	18-5443	N/A	N/A	18-5281
7.4GSI	DELCO EST	18-8836-1	18-5354	18-5405	18-5108	18-5107-1	18-5443	N/A	N/A	18-5281
8.1GI	DELCO	18-8838-1	N/A	N/A	N/A	N/A	18-7493	N/A	N/A	N/A
8.1GI-A	DELCO	18-8838-1	N/A	N/A	N/A	N/A	18-7648	N/A	N/A	N/A
8.1GI-B	DELCO	18-8838-1	N/A	N/A	N/A	N/A	18-7648	N/A	N/A	N/A
8.1GI-BF	DELCO	18-8838-1	N/A	N/A	N/A	N/A	18-7648	N/A	N/A	N/A
8.1GI-C	DELCO	18-8838-1	N/A	N/A	N/A	N/A	18-7493	N/A	N/A	N/A
8.1GIC-400	DELCO	18-8838-1	N/A	N/A	N/A	N/A	18-7493	N/A	N/A	N/A
8.1GICE	DELCO	18-8838-1	N/A	N/A	N/A	N/A	18-7493	N/A	N/A	N/A
8.1GIE	DELCO	18-8838-1	N/A	N/A	N/A	N/A	18-7493	N/A	N/A	N/A
8.1GI-A	DELCO	18-8838-1	N/A	N/A	N/A	N/A	18-7648	N/A	N/A	N/A
8.1GI-B	DELCO	18-8838-1	N/A	N/A	N/A	N/A	18-7648	N/A	N/A	N/A
8.1GI	DELCO	18-8838-1	N/A	N/A	N/A	N/A	18-7493	N/A	N/A	N/A
8.1GSI-A	DELCO	18-8838-1	N/A	N/A	N/A	N/A	18-7648	N/A	N/A	N/A
8.1GX	DELCO	18-8838-1	N/A	N/A	N/A	N/A	18-7493	N/A	N/A	N/A
8.1GXII	DELCO	18-8838-1	N/A	N/A	N/A	N/A	18-7493	N/A	N/A	N/A
8.1GX-A	DELCO	18-8838-1	N/A	N/A	N/A	N/A	18-7648	N/A	N/A	N/A
8.1GX-AF	DELCO	18-8838-1	N/A	N/A	N/A	N/A	18-7648	N/A	N/A	N/A
8.1GXII-A	DELCO	18-8838-1	N/A	N/A	N/A	N/A	18-7648	N/A	N/A	N/A
8.1IPS	DELCO	18-8838-1	N/A	N/A	N/A	N/A	18-7493	N/A	N/A	N/A
8.10SI	DELCO	18-8838-1	N/A	N/A	N/A	N/A	18-7493	N/A	N/A	N/A
8.2GL	PRESTOLITE	18-8803-1	18-5352	18-5403	-	N/A	18-5437	N/A	N/A	N/A
8.2GSI	DELCO EST	18-8836-1	18-5354	18-5405	18-5108	18-5107-1	18-5443	N/A	N/A	18-5281
DPX375	DELCO	18-8838-1	N/A	N/A	N/A	N/A	18-7648	N/A	N/A	N/A
DPX375-CF	DELCO	18-8838-1	N/A	N/A	N/A	N/A	18-7493	N/A	N/A	N/A
DPX385	DELCO EST	18-8836-1	18-5354	18-5405	18-5108	18-5107-1	18-5443	N/A	N/A	18-5281
DPX415	DELCO EST	18-8836-1	18-5354	18-5405	18-5108	18-5107-1	18-5443	N/A	N/A	18-5281
DPX420	DELCO	18-8838-1	N/A	N/A	N/A	N/A	18-7648	N/A	N/A	N/A
DPX420-CF	DELCO	18-8838-1	N/A	N/A	N/A	N/A	18-7493	N/A	N/A	N/A
V6-200	DELCO HVS	18-8829-1	18-5243	18-5245	18-7642	18-5117	18-5467	N/A	N/A	18-5246
V6-225	DELCO HVS	18-8829-1	18-5243	18-5245	18-7642	18-5117	18-5467	N/A	N/A	18-5246
V8-225	DELCO HVS	18-8828-1	18-5244	18-5245	18-7642	18-5117	18-5467	N/A	N/A	18-5247
V8-270	DELCO HVS	18-8828-1	18-5244	18-5245	18-7642	18-5117	18-5467	N/A	N/A	18-5247
V8-300	DELCO HVS	18-8828-1	18-5244	18-5245	18-7642	18-5117	18-5467	N/A	N/A	18-5247
V8-320	DELCO HVS	18-8828-1	18-5244	18-5245	18-7642	18-5117	18-5467	N/A	N/A	18-5247
V8-350	N/A	18-8838-1	N/A	N/A	N/A	N/A	-	N/A	N/A	N/A
V8-380	N/A	18-8838-1	N/A	N/A	N/A	N/A	-	N/A	N/A	N/A
V8-430	N/A	18-8838-1	N/A	N/A	N/A	N/A	-	N/A	N/A	N/A

APPLICATION CONTINUED ON NEXT PAGE

VOLVO PENTA IGNITION APPLICATION (Cont.)

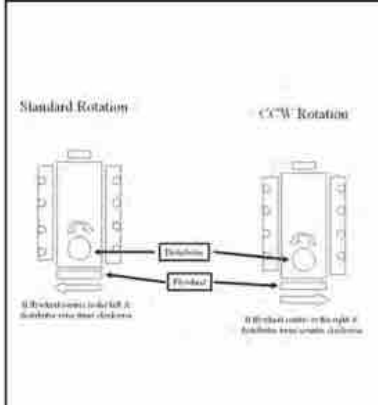

**18-5920
STARTER**
PMGR, Ford



**18-5927
STARTER**
PMGR, Ford



**18-5911
STARTER**
(Heavy-Duty) (No Core) Clockwise
For GM engines, bottom mount straight
across bolt pattern. Standard rotation.
Replaces: 834893, 855326
Replacement Solenoid: 18-5837
SAEJ1171



**18-5903
STARTER**
Replaces: 841066-4
(No Core) Clockwise
Bottom mount two bolt pattern for
standard rotation FORD engines.
Replacement Solenoid: 18-5801



**18-5906
STARTER**
Replaces: 840808, 872241
• Inboard
• Gear Reduction Starter
• Permanent Magnet, 12 Volt
• CW Rotation
• Aluminum Pinion Housing w/2 Threaded
Mounting Holes
Fits : Volvo Penta 4 Cylinder and 6 Cylin-
der Gas Engines



**18-5913-1
STARTER**
Replaces: 3856004, 3860764,
3587625, 3853982, 3854751, 3885317
(Clockwise)
Delco permanent magnet gear reduction 2
bolt starter. 12V - 11 Tooth Offset Bolt Pattern
For: Late model GM 14" Flywheel
SAEJ1171
1.7 KW



**18-5919-1
STARTER**
Replaces: 3856003
Permanent magnet I/O starter
Fits: Chevy Engines with 12 3/4" flywheels
Straight across bolt pattern
SAEJ1171
Fcr: 3.0 GS
1.7 KW



**18-5920
STARTER**
Replaces: 3854190
Clockwise/Standard rotation
Permanent magnet starter
Replacement Solenoid: 18-6291
For: 5.0 & 5.8 litre Ford engines



**18-6275-1
STARTER**
Replaces: 3857747, 3860566
• Inboard
• Permanent Magnet Gear Reduction Starter
• 2 Long Bolt Offset Pattern
• CW Rotation
• Use w/ Late Model 3.0L Engines with 14"
Flywheel
Replacement Solenoid: 18-5811
Fits : Volvo Penta, Mercruiser, Marine Power



**18-6834
STARTER**
Replaces: GM Engines Universal
Used on all GM Engines with either 14 1/4"
or 12 3/4" flywheels



**18-6835
STARTER**
Replaces: GM Engines Universal
Used on all GM Engines with either 14 1/4"
or 12 3/4" flywheels



**18-6839
STARTER**
Replaces: 1357199, -7, 3523301, -4,
5003564, -1
Fits: 240,740,760,780,940 series 2.3L



**18-6872
STARTER**
(12 Volt)
Replaces: 233991, 240501, 837924,
842775, 843511, 847306-8, 881681
Fits: 12V; TAMD, MD, AOD Models



**18-6956
STARTER**
Replaces: 3803227, -2, 834625-6,
841378-3, 841380, 841762, 63, 65, 66,



**18-6958
STARTER**
(24 Volt)
Replaces: 847308-4, 870998, 881682
Fits: 24V; MD, TMD, TAMD Models



**18-59710
ALTERNATOR**
Replaces: 820652, 822454,
827303, 847651, 849561, 849602
Fits: 24V; AQ Series gas and diesel
24V systems



**18-5882
ALTERNATOR**
Replaces: 3884950
75A, 12V, Serpentine
3.0L, 4.3L, 5.0L, 5.7L, 8.1L (2007 - Current)



**18-5957
ALTERNATOR**
Replaces: 3860769
(3-Wire) (68 AMP)
Replaces Mando, Motorola and Original Equipment Delco.
Uses same electrical connections and mounting method.
Equipped with fan and drive pulley.
SAEJ1171

CE



**18-59700
ALTERNATOR**
Replaces: 3803227, -2, 834625-6,
841378-3, 841380, 841762, 63, 65, 66



**18-5979
ALTERNATOR**
Replaces: 3860082, Mando AC165622,
Lester 12391
65 amp, 3.0GSM-A/B/C, 3.0GSP-A/B/C, 3.0GLM-A/B,
3.0GLP-A/B, 4.3GX1-A/B/BF/C, CF, D, DF, 4.3QSI-B/BF/C/
CF/D/DF, 5.0GX1-A



**18-5959
ALTERNATOR**
Replaces: 826495, 834609,
834963, 841762, 841765, 841766.
Valeo A13N1M, 2M, 147M, 148M
14V/50 AMP: AQ120-AQ145, AQ200D-AD290-TMD40-
MD21-9070-MD5C, MD18-7D-MD30-TMD30-TAM30,
MD18-MD2B-MD2BHY-MD3B-MD21A, MD32A,
AQD32A/270D (Mot V8S), MD5-MD7-MD11-MD17-B21-
B22 Mot. TMD40), Series 2002-2003-R,V,S.



**18-6261
ALTERNATOR**
Replaces: 3856600-6, 3857561
Mando for Late Model Volvo
Penta, 12 Volt, 65 Amp,
Internal Regulator, Single
Groove Pulley



**18-6265
ALTERNATOR**
Replaces: 3857813
Mando for Late Model Volvo Penta, 12 Volt,
65 Amp, Internal Regulator, Single Groove
Pulley



**18-5939
ALTERNATOR**
Replaces: 872235, 3803260, 873770
Valeo: A13N234, 2541451
14V/60 AMP: AQ115, AQ120B, AQ125, AQ130, AQ140, AQ145, AQ165, AQ170, AQ200, AQ225, AQ255, AQ260, AQ280, AQ290, BB115, BB145, MB20: Diesel Engine Application: AQD2B, AQD21A, AQD21B, AQD27, AQD29, AQD32A, MD11C, MD11D, MD17C, MD17D, MD2B, MD2010A, MD2010B, MD2030A, MD2030B, MD2040A, MD2040B, MD21A, MD21B, MD27, MD29, MD3B, MD32A, MD6A, MD6B, MD7, TAM71A, TAM71B, TAM72A, TAMD72W1-A.



**18-5943
ALTERNATOR**
Replaces: 872926, 3803227
Valeo: A13N259, 541663
14V/50 AMP: 431, 500, 501, 570, 740DP, 740MSS, AQ131, AQ145B, AQ175, AQ200, AQ205, AQ211, AQ225, AQ260, AQ271, AQ290, AQ311, BB165, BB170, BB225, BB231, BB260, BB261, Diesel Engine Application: 2001, 2002, 2003, 2003T, AD31A, AQAD30A, AQAD31A, AQAD40A, AQAD41, AQAD41A, AQD40A, AQD41, AQD41A, KAD42A, KAMD42A, MD30A, MS31A, MD40A, MD7B, TAMD40A, TAMD41A, TAMD41B, TAMD41D, TAMD70E, TMD30A, TMD31A, TMD40A, TMD41A.



**18-6845
ALTERNATOR**
Replaces: 3862613, 3862665, 3884950
Fits: 3.0GLM, 3.0GLP Engines



**18-6846
ALTERNATOR**
Replaces: Volvo Penta 1502272, 3803270-2, 5001677, 845940, 72021, 872022, 872757, 873635, 873757, 873757-9, 873771,



**18-6847
ALTERNATOR**
Replaces: 3862613, 2655301,
Fits: 2000-07 3.0GLP, GSP, GSM, 4.3GXl, 5.0GXl, Si, 5.7G, GXl, Osi, Sxi



**18-5976
ALTERNATOR**
Replaces: Motorola 9AR3743G, 510-821, 510-802, 510-835, 510-836, 510-856, 510-861, 510-862
Valeo 2937430
28V/45 AMP: TAMD120, TMD100, TMD120



**18-6975
ALTERNATOR (Universal)**
Fits: High amp 160A alternator, universal mounting pattern based on Delco CS1300 design, v-belt and 5 groove serpentine pulley included



**18-6848
ALTERNATOR**
Replaces: Volvo 3862612, 2656299, Valeo A0002655299
Fits: 2000 and on Volvo Penta Models w/ 4.3, 5.0, and 5.7 GM engines



**18-6953
ALTERNATOR**
Replaces: Volvo
Fits: Diesel D3 Models



**18-6955
ALTERNATOR**
Replaces: Caterpillar 3001117, 10-258, Prestolite 110-258, 110-258A, Volvo 849748-9
Fits: Volvo Diesel 6 cylinder models

ALTERNATOR/STARTER APPLICATION

GASOLINE ENGINES

Model	Engine	Year	Starter	Alternator	Model	Engine	Year	Starter	Alternator
AQ115			18-5918	N/A	AQ131D	4 cyl.	1985-1989	18-5906	18-5959
AQ120B			18-5918 ①	N/A	AQ140A			18-5918 ③	18-5959
AQ120B			18-5906	N/A	AQ140A			18-5906 ②	18-5959
AQ125A			18-5918 ①	18-5959	AQ145			18-5918	18-5959
AQ125A	4 cyl	1981-1985	18-5906 ④	18-5959	AQ145A	4 cyl	1979-1985	18-5918 ③	18-5959
AQ125B	4 cyl	1981-1985	18-5906 ②	18-5959	AQ145A	4 cyl	1979-1985	18-5906 ⑤	18-5959
AQ130			18-5918	N/A	AQ145B	4 cyl	1979-1985	18-5906 ⑥	18-5959
AQ131A	4 cyl	1985-1989	18-5906	18-5959	AQ151A	4 cyl	1985-1989	18-5906	18-5959
AQ131B	4 cyl	1985-1989	18-5906	18-5959	AQ151B	4 cyl	1985-1989	18-5906	18-5959
AQ131C	4 cyl	1985-1989	18-5906	18-5959	AQ151C	4 cyl	1985-1989	18-5906	18-5959

① Below SN 7679/013489

② AQ125A beginning with S/N 7679/013489

③ Below SN 7705/001557

④ AQ145A & BB145A beginning with SN 7705/001557

⑤ 18-5959 14V/50AMP

⑥ Mounting screw threads into bracket

⑦ 18-5939 14V 50 AMP

Model	Engine	Year	Starter	Alternator	Model	Engine	Year	Starter	Alternator
AQ165			18-5918	N/A	BB115			18-5918	N/A
AQ170			18-5918	N/A	BB140A			18-5918 ③	18-5959
AQ171A	4 cyl	1986-1994	18-5906	18-5959 ⑤	BB140A			18-5906	N/A
AQ171C	4 cyl	1986-1994	18-5906	18-5959 ⑤	BB145			18-5918	N/A
AQ175A			18-5911 ⑤	N/A	BB145A	4 cyl	1979-1985	18-5918 ③	18-5959
AQ190A			18-5903	N/A	BB145A			18-5906 ⑤	N/A
AQ200B			18-5911	18-5959	BB165			18-5918	N/A
AQ200C			18-5911	18-5959	BB170			18-5918	N/A
AQ200D			18-5911	18-5959	BB225A			18-5911	18-5959
AQ200F			18-5911	18-5959	BB225B			18-5911	18-5959
AQ205A			18-5911	N/A	BB225C			18-5911	18-5959
AQ211A			18-5911	N/A	BB260A			18-5911	18-5959
AQ225A			18-5911	18-5959	BB260B			18-5911	18-5959
AQ225B			18-5911	18-5959	BB260C			18-5911	18-5959
AQ225C			18-5911	18-5959	230			18-5906	18-5943
AQ225D			18-5911	18-5959	250			18-5906	18-5943 ⑦; 18-5939 ⑧
AQ225E			18-5911	18-5959	251A			18-5906	N/A
AQ225F			18-5911	18-5959	430			18-5911	18-5943 ⑦
AQ231A			18-5911	N/A	431			18-5911	18-5943 ⑦
AQ231B			18-5911	N/A	432			18-5911	18-5943 ⑦
AQ240A			18-5903	N/A	434			N/A	N/A ⑦; 18-5939 ⑧
AQ255A			18-5911	N/A	500-570			18-5911	18-5943 ⑦; 18-5939 ⑧
AQ255B			18-5911	N/A	571A			18-5911	N/A N/A
AQ260A			18-5911	18-5959	572			18-5911	18-5943; 18-5939 ⑧
AQ260B			18-5911	18-5959	740B			18-5911	18-5943; 18-5939 ⑧
AQ271A			18-5911	N/A	3.0L			18-5919-1	N/A
AQ271B			18-5911	N/A	4.3L			18-5913-1	N/A
AQ271C			18-5911	N/A	5.0L (GM)	V-8	1994-2007	18-5913-1	N/A
AQ271D			18-5911	N/A	5.7L (GM)	V-8	1994-2007	18-5913-1	N/A
AQ280			18-5911	N/A	7.4L (GM)	V-8	1994-2007	18-5913-1	N/A
AQ290A			18-5911	18-5959	8.2L (GM)	V-8	1994-2007	18-5913-1	N/A
AQ311A			18-5911	N/A	5.0L (FORD)	V-8	1994	18-5920	N/A
AQ311B			18-5911	N/A	5.8L (FORD)	V-8	1994	18-5920	N/A

① Below SN 7679/013489 ② AQ125A beginning with S/N 7679/013489 ③ Below SN 7705/001557 ④ AQ145A & BB145A beginning with SN 7705/001557
 ⑤ 18-5959 14V/50AMP ⑥ Mounting screw threads into bracket ⑦ 18-5939 14V 50 AMP



18-6291
SOLENOID
 Replaces: 3854194-2, OMC 3854194
 Fits: Ford Gear Reduction Starters on Late Model 5.0L, 5.8L, OMC and Volvo Penta



18-5806
SOLENOID
 Replaces: 834520
 BOSCH 0331-302-050, 0331-302-081, 0331-302-085, 0331-302-581, 0331-302-585
 For starters with aluminum nose.
 Slot in end of solenoid shaft is 13/32" long.



18-5811
STARTER SOLENOID
 Replaces: 3850216, 3859054
 For: PG 260 series starters, GM V6 & V8 (1983-Up)



18-5837
SOLENOID
 Replaces: 3853869, 3853998
 For: 3.0; GL, GS, 4.3L GL, GS, 5.7L GL, GL, 7.4L GL, 8.2L GL



18-9802
TIMING LIGHT
 Self-powered accurate up to 10,000 RPM's



18-69550
CIRCUIT BREAKER
 Replaces: 3854164
 Fits: Volvo Multiple Gasoline Engine Applications

 <p>18-6271 RELAY Replaces: 870670, 6643474, 876038, 241812 12 Volt, 30 Amp</p>	 <p>18-6268 RELAY Replaces: 841177, 872272 12 Volt, 30 Amp</p>	 <p>18-6266 RELAY Replaces: 876040, 872300 12 Volt, 30 Amp/20 Amp continuous</p>
 <p>18-5705D <small>Display Package</small></p> <p>18-5705 POWER TRIM RELAY Replaces: 876039 5 Terminal For: AQ 175, 200, 225D, 260, 290A</p>	 <p>18-5700 TRIM RELAY Replaces: 3858081, 3858809 For: (1996 SX-M-MAC, MDA, MLT), 3.0GLP-D, 4.3GL-E, 4.3GL-EF, 4.3GX-F, 4.3GX-FF, 4.3OSI-F, 4.3OSI-FF, 5.0GL-F, 5.0GL-FF, 5.0GX-F, 5.0GX-FF, 5.0SI-F, 5.0SI-FF, 5.7GI-F/FF, 5.7GX-G/GF, 5.7OSI-E/ EF, 5.7OX-E/EF, 5.7GI-F, 5.7GI-G, 8.1GI-G/GF, 8.1GX-F/FF, 8.1OSI-C/GF, 8.1GI-G, 8.1GXII-F, DPH-A, DPH-B, DPR-A, DPH-B, EF drives, SX-M TSKs 1999- 05, SX-M, DP-SM, (WT drives, PJX-C, PJX-S SX-M, -MACLT, -MDA, -MDB, -MHP, -MTD, DP-E, DP-S, -S1, -S2, DP-SM, -SM)XDP-B</p>	 <p>18-5704 POWER TRIM RELAY Replaces: 876037 20 Amps Resistive 15 Amps Inductive Single Pull 5 Terminal For: AQ270, 280</p>
<p>PKG. OF 5</p>  <p>18-6951 18-6951-9[Ⓛ] POWER TILT FUSE (30 Amp) Replaces: 851120</p>	 <p>18-6770 TILT/TRIM PUMP Replaces: 854346 Oildyne For: Early Version SX Drive with 2.5" bolt centers and fine threads Motor 18-6817</p>	 <p>18-6806 TRIM PUMP ASSEMBLY Replaces: 3587079, 3857489, 3860879 For: SX - Late Model with Coarse Thread Motor 18-6804</p>
 <p>18-6822 TRIM PUMP Replaces: Volvo Penta 852928, 820545, OMC 172543, 382715 Motor 18-6838</p>	 <p>18-6804 TRIM MOTOR Replaces: 3861575 For: SX Drives - Later Version / 2.3" Bolt Centers w/ Coarse Thread</p>	 <p>18-6817 TRIM MOTOR Replaces: 854525-3, 3858071 Fits: Late model Volvo Penta For: SX - Early Version / Fine thread & 2.5" bolt centers</p>
 <p>18-6838 TRIM MOTOR Replaces: 3586765, 852928, 872449, 873051 Fits: DP, DPX Drives Replacement pump 18-6822</p>	 <p>18-6881 TRIM MOTOR WITH PUMP Replaces: Volvo 852928, 872449, 873051, Fits: DP, DPX Drives Motor 18-6838 Pump 18-6822</p>	 <p>18-6823 WIRING HARNESS Replaces: Universal Converts 3-wire Tilt and Trim motors to 2-Wire design</p>

Ⓛ Items ending in "D" are Display Packaged - Regular number is Non-Display
Ⓜ Priced per package



**18-6274
TILT/TRIM MOTOR**
Replaces: 852928, 3857265
Replaces : Prestolite HYK4001
Includes Hydraulic Valve Body



**18-6758
TILT/TRIM MOTOR**
Replaces: 850834
Electrolux KP5024/120



**18-6779
TRIM MOTOR**
Replaces: 986280, 3853945
For: P,JX, SX, DPB, DP, DPX, 3.0L GS,
GL, 4.3L GL, GS, GI, 5.0L FL, FI, 5.7L
GL, GI, 5.8L FL, FI, FSI



**18-6790
TILT MOTOR**
Replaces: 839430,
Electrolux KS3448/290
Fits: Older model Volvo



**18-6791
TILT MOTOR**
Replaces: 850046, 853520
Fits: Older model Volvo



**18-6792
TILT MOTOR**
Replaces: 897720, 854329
Fits: Older model Volvo



**18-7641
CARBURETOR
(Remanufactured)**
Replaces: 841047-4, 841313-0, 3856393
AQ225B,C,D,E,F; 225A,B; AQ260A,B; 290A; BB225A,AV,
BB225B,C; 260A,AV,B,C; 501A, 501A/MS4A; 570/MS4A
Use Replacement Carb Kit **18-7095**



**18-7998
CARBURETOR
(Remanufactured)**
Replaces: R80316
Fits: 3.0L GL, GS



**18-80008
CARBURETOR
(Remanufactured)**
Replaces: R7044289
Fits: 7.4L w/ 4bbl Rochester



**18-7000
CARB KIT**
Replaces: 841836-0, 841292
SOLEX DOWN DRAFT
(856471 + 856472 = 18-7000)



**18-7001
CARB KIT**
Replaces: 841293-4
SOLEX SIDE DRAFT



**18-7008
CARB KIT**



**18-7040
CARB KIT**
Contains adjustable needle & seats



**18-7072
CARB KIT**
Replaces: 855889



**18-7085
CARB KIT**
Replaces: 875407

 <p>18-7086 CARB KIT Replaces: 841994</p>	 <p>18-7095 CARB KIT Replaces: 834985-4</p>	 <p>18-7237 CARB KIT</p>	
 <p>18-7238 CARB KIT Replaces: 3854020 For: 4.3L GL, GS, 5.0L GL, 5.7L GL</p>	 <p>18-7241 CARB KIT Replaces: 3855017 For: 7.4L GL, 8.2L GL</p>	 <p>18-7242 CARB KIT Replaces: 3854105</p>	
 <p>18-7244 CARB KIT Replaces: 3854106</p>	 <p>18-7245 CARB KIT Replaces: 3854107</p>	 <p>18-7246 CARB KIT Replaces: 3854116 For: 3.0L GLM, GLP, GSM, GSP, GS, GL</p>	 <p>18-7099 CARB GASKET SET Replaces: 824803, 856470</p>
 <p>18-7200 FLOAT Replaces: 841634-9 (ALCOHOL RESISTANT) Plastic</p>	 <p>18-7201 FLOAT (ALCOHOL RESISTANT) Brass</p>	 <p>18-7202 FLOAT (ALCOHOL RESISTANT) Brass</p>	 <p>18-36905 FLOAT Replaces: 3854018 Fits: 3.0L GLM, GLP w/2 bbl Holley Carb</p>
 <p>18-8114 FUEL LINE HOSE For fuel pump to carburetor connection. Replaces copper or steel tubing 3/8" X 31' PTFE composite hose with 5/8"-18 male inverted flare straight one end, 5/8"-18 90° one end. SAE J1527 type A1</p>	 <p>18-8115 FUEL LINE HOSE For fuel pump to carburetor connection. Replaces copper or steel tubing 3/8" X 25' PTFE composite hose with 5/8"-18 male inverted flare straight one end, 5/8"-18 90° one end. SAE J1527 type A1</p>		

CARBURETOR KIT/FLOAT/CARBURETOR GASKET KIT APPLICATION

Model	Cyl.	Mfg Code	Carb Model	Carburetor #	Carb Kit ①	Carb Float	Carb Gasket Kit
AQ115A,B,125A,B,130C,D, AQ131A,B,C,D,145A,B AQ151A,B,C,171A,C BB115B,C,145A	4	—	—	SOLEX 44 PA1	18-7000	—	18-7099
AQ120B,140A,BB140A	4	—	—	SOLEX 44 PHN-3	18-7001	—	—
AQ80	4	—	—	ZENITH 34VN	18-7008	—	—
AQ95,95A,100,105A,110, 115 W/109", (1780cc) Dual Carb. Installation	4	ZS-1	150CD	150CD-SE (C1865F,R, C304D,F,R)	18-7085	—	—
AQ120, AQ130A,B,BB115A,w. 121" (1986cc) Dual Carb. Installation	4	ZS-1	175CD	175CD-2S, (C3098F,R, C3200 F,R,C,3231 F,R)	18-7085	—	—
3.0L GL,GS	4	H-2	2300	R-80316A,R-80316-1A	18-7246	—	—
AQ170A,B,C,BB170A,B,C	6	—	—	SOLEX 44 PA1	18-7000	—	18-7099
AQ165A,BB165A (3 Carb. Installation)	6	ZS-1	175CD	175CD-2S, (C3201F,M, R,C,3232F,M,R)	18-7085	—	—
AQ175A	6	R-2	2GE	17059059	18-7086	18-7200	—
4.3L GL,GS	6	H-2	2300	R-80312A,R-80312-1A	18-7238	—	—
4.3L GL,GS	6	H-4	4160	R-80403A,R-80403-1A	18-7237	—	—
AQ200D,F and 500A	8	R-2	2GE	17057133, 17059059	18-7086	18-7200	—
AQ225B,C,D,E,F,255A,B, AQ260A,B,290A,BB225A,AV, BB225B,C,260A,AV,B,C	8	R-4	4ME	17059283,296,298	18-7095	18-7201	—
501A,501AMS4A,570/MS4A 305" (5.0L),307" (5.0L),350" (5.7),	8	R-4	4MC, 4MV	7044288,7044289, 1705,628717,057,290	18-7072	18-7201	—
5.0L, 5.8L (FI, FL, SX) (Ford)	8	H-2	2300	R-80382A,R-80382-1A	18-7244	—	—
5.0L, 5.8L (FI, FL) (Ford)	8	H-4	4150	R-80383A,R-80383-1A	18-7245	—	—
740A/MS5A	8	H-4	4011	R84026AA	18-7040	—	—
454" (7.4L)	8	R-4	4MC, 4MV	7044288,7044289, 1705,628717,057,290	18-7072	18-7201	—
7.4L GL	8	H-4	4150	R-80378A,R-80378-1A	18-7242	—	—
8.2L GL	8	H-4	4150	R-80378A,R-80378-1A	18-7242	—	—

① Does not include metering rods



**18-7326
ELECTRIC FUEL PUMP**
Replaces: 3850809,
3858261, 3854620, 3857986



**18-7330
ELECTRIC FUEL PUMP**
Replaces: 3857650, 3855958



**18-7331
ELECTRIC FUEL PUMP**
Replaces: 3850810,
3857985, 3858714

ELECTRIC FUEL PUMP APPLICATION

Year	Engine	Application	OE #	#'s Superseded from	Part #
1994-99	262/4.3L (HU-WT)	High Pressure pump	3857650		18-7330
1994-99	262/4.3L GL/GS (All)	Carbureted - Low Pressure	3858261	3850809	18-7326
1994-99	262/4.3L GI (HU-WT)	W.Elec. Pump - Low Pressure	3858261	3850809	18-7326
1994-99	454/7.4L & 502/8.2L (HU-WT)	Low pressure system	3858714	3850810, 3857985	18-7331
1993-99	350/5.7L, 454/7.4L, & 502/8.2L	Engines w/MPI - High Pressure	3857650		18-7330
1996-99	454/7.4L & 502/8.2L (HU-WT)	Engines w/MPI - High Pressure	3857650		18-7330
1994-99	5.0L thru 5.8L	Low pressure electric fuel pump	3858261	3850809	18-7326
1994-99	454/7.4L & 502/8.2L (HU-WT)	GM Mark V Eng. - Low Pressure	3858714	3850810, 3857985	18-7331
1992-93	454/7.4L	GM Mark V Eng. - Low Pressure	3858714	3850810, 3857985	18-7331



**18-7268
FUEL PUMP**
Replaces: 3855276
For: 5.7L Liter Engines
Dual Diaphragm requires sight glass



**18-7281
FUEL PUMP**
Replaces: 826493
For: GM (V-8) 305, 350
(Includes gasket)



**18-7286
FUEL PUMP**
Replaces: B41161
For: XP stamped steel pump
AQ120B (spec# 867465), AQ125A/B, AQ131A/B/C/D,
AQ140A (spec# 867464), BB140A, AQ145A, BB145A,
AQ151A/B/C, AQ171A/C, AQ230A/B, AQ250A/B, AQ251A



**18-35442
FUEL PUMP**
Replaces: 859428
Fits: Volvo Late 2000 Series Engines

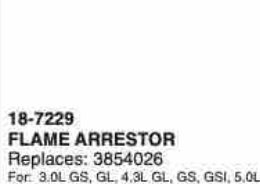

**18-7229
FLAME ARRESTOR**
Replaces: 3854026
For: 3.0L GS, GL, 4.3L GL, GS, GSI, 5.0L
FL, FI, 5.7L GL, GI, 5.8L FL, FI, FSI



- UNIVERSAL DESIGN -

FUEL WATER SEPARATOR BRACKETS



Bracket Type	Part #	Bracket Type	Part #
1/4" Stainless Steel	18-7777	1/4" Aluminum	18-7853-1
3/8" Stainless Steel	18-7776	3/8" Aluminum	18-7775

FUEL WATER SEPARATOR KITS



21 MICRON FILTER KITS FOR CARBURETED ENGINES

Kit Type	Part #	Micron Rating	Contents
1/4" Aluminum (Short Filter)	18-7848-1	21	1 - 18-7844 filter & 1 18-7853-1 bracket 2 - 18-4256 1/4" pipe plugs
1/4" Aluminum Bonus Pack Contains spare filter	18-7848-2	21	2 - 18-7844 filter & 1 18-7853-1 bracket 2 - 18-4256 1/4" pipe plugs
1/4" Aluminum (Tall Filter)	18-7852-1	21	1 - 18-7845 filter & 1 18-7853-1 bracket 2 - 18-4256 1/4" pipe plugs
1/4" Aluminum Bonus Pack Contains spare filter	18-7852-2	21	2 - 18-7845 filter & 1 18-7853-1 bracket 2 - 18-4256 1/4" pipe plugs
3/8" Aluminum (Tall Filter)	18-7775-1	21	1 - 18-7845 filter & 1 18-7775 bracket 2 - 18-4264 3/8" pipe plugs
1/4" Stainless Steel (Tall Filter)	18-7777-1	21	1 - 18-7845 filter & 1 18-7777 bracket 2 - 18-4256 1/4" pipe plugs
3/8" Stainless Steel (Tall Filter)	18-7776-1	21	1 - 18-7845 filter & 1 18-7776 bracket 2 - 18-4264 3/8" pipe plugs

10 MICRON FILTER KITS FOR FUEL INJECTED ENGINES



Kit Type	Part #	Micron Rating	Contents
1/4" Aluminum (Short Filter)	18-7983-1	10	1 - 18-7944 filter & 1 18-7853-1 bracket 2 - 18-4256 1/4" pipe plugs
1/4" Aluminum Bonus Pack Contains spare filter	18-7983-2	10	2 - 18-7944 filter & 1 18-7853-1 bracket 2 - 18-4256 1/4" pipe plugs
1/4" Aluminum (Tall Filter)	18-7982-1	10	1 - 18-7945 filter & 1 18-7853-1 bracket 2 - 18-4256 1/4" pipe plugs
1/4" Aluminum Bonus Pack Contains spare filter	18-7982-2	10	2 - 18-7945 filter & 1 18-7853-1 bracket 2 - 18-4256 1/4" pipe plugs
1/2" Aluminum (High Capacity Filter)	18-7966-1	10	1 - 18-7866 filter & 1 18-7853-1 bracket 2 - 18-4256 1/4" pipe plugs
3/8" Aluminum (Tall Filter)	18-7986-1	10	1 - 18-7945 filter & 1 18-7775 bracket 2 - 18-4264 3/8" pipe plugs
1/4" Stainless Steel (Tall Filter)	18-7984-1	10	1 - 18-7945 filter & 1 18-7777 bracket 2 - 18-4256 1/4" pipe plugs
3/8" Stainless Steel (Tall Filter)	18-7985-1	10	1 - 18-7945 filter & 1 18-7776 bracket 2 - 18-4264 3/8" pipe plugs

* Display Packaged



10 MICRON FILTER KITS WITH DRAIN BOWLS

Sierra AquaVue™ and metal bowl separator filters allow water to be drained from the filter to extend service life. Use the AquaVue™ bowl for outboard, above deck installations. USCG regulations require the use of the flame resistant metal bowl below deck.

Kit Type	Part #	Micron Rating	Contents
1/4" Aluminum w/ metal drain bowl	18-7951	10	1 - 18-7919 filter & 1 18-7853-1 bracket 1 - 18-7924 metal bowl 2 - 18-4256 1/4" pipe plugs
1/4" Stainless Steel w/ metal drain bowl	18-7938	10	1 - 18-7919 filter & 1 18-7777 bracket 1 - 18-7924 metal bowl 2 - 18-4256 1/4" pipe plugs

VOLVO STYLE BRACKETS AND SEPARATOR KITS

18-7778
VOLVO ALUMINUM
REPLACEMENT BRACKET
Replaces: 3850861



COMPACT BRACKET AND SEPARATOR KIT - FOR SMALL OUTBOARDS AND FRESH WATER APPLICATIONS

18-7774
COMPACT ALUMINUM BRACKET



18-7965-1
10 MICRON COMPACT
SEPARATOR KIT
Contains:
1 - 18-7774 bracket
1 - 18-7865 filter



REPLACEMENT FILTERS



UNIVERSAL DESIGN

10 MICRON REPLACEMENT FILTERS			21 MICRON REPLACEMENT FILTERS		
Part #	Description		Part #	Description	
18-7944	Short - 3.875"		18-7844	Short - 3.875"	
18-7945	Long - 4.35"			Long - 4.35"	
18-7866	High Capacity - 6"		18-7845	Short - 3.875"	
18-7865	Compact 10 Micron			Long - 4.35"	

REPLACEMENT FILTERS FOR VOLVO

10 MICRON REPLACEMENT FILTERS			21 MICRON REPLACEMENT FILTERS		
Part #	Description	Replaces	Part #	Description	Replaces
18-7946	OMC thread		18-7846	OMC thread	
18-7989	Volvo SX/EFI Cobra EFI	Volvo 3851218-2, 3852413, 3862228	18-7789	Volvo SX/EFI Cobra EFI	Volvo 3851218-2, 3852413



10 MICRON REPLACEMENT FILTERS AND KITS WITH DRAIN BOWLS

REPLACEMENT FILTERS			REPLACEMENT BOWLS	
Part #	Description	Replaces	Part #	Description
18-7919	Spin on replacement	Racor S3213	18-7924	Metal Collection Bowl
18-7920	Spin on replacement	Racor S3214		
18-7947	Spin on replacement Fits - 120RRAC01	Racor S3240	FILTER & BOWL KITS	
18-7948	Spin on replacement Fits - 320RRAC01	Racor S3227	Part #	Description
18-7949	Spin on replacement Fits - 660RRAC02	Racor S3232	18-7929	Filter & Metal Bowl Contains: 18-7919 filter, 18-7924 bowl

**18-8125
DIESEL FUEL FILTER**

Replaces: 3583443

D4-180I-B, D4-180I-C, D4-210A-A, D4-210A-B, D4-210I-A, D4-210I-B, D4-225A-B, D4-225A-C, D4-225I-B, D4-225I-C, D4-260A-A, D4-260A-B, D4-260A-C, D4-260D-B, D4-260D-C, D4-260I-A, D4-260I-B, D4-260I-C, D4-300A-A, D4-300A-C, D4-300D-A, D4-300D-C, D4-300I-A, D4-300I-C, D6-280A-A, D6-280A-B, D6-280I-A, D6-280I-B, D6-310A-A, D6-310A-B, D6-310D-A, D6-310D-B, D6-310I-A, D6-310I-B, D6-330A-B, D6-330A-C, D6-330D-B, D6-330D-C, D6-330I-B, D6-330I-C, D6-350A-A, D6-350A-B, D6-370A-B, D6-370A-C, D6-370D-A, D6-370D-B, D6-370D-C, D6-370I-A, D6-370I-B, D6-370I-C, D6-435D-A, D6-435D-C, D6-435I-A, D6-435I-C



**18-8126
DIESEL FUEL FILTER**

Replaces: 861477

D1-13 A, D1-13 B, D1-20 A, D1-20 B, D1-30 A, D1-30 B, D2-40 A, D2-40 B, D2-55 A, D2-55 B, D2-55 C, D2-55 D, D2-55 E, D2-55F, D2-75 A, D2-75 B, D2-75 C, D2-75F, MD2010A, MD2010B, MD2020A, MD2020B, MD2030A, MD2030B, MD2040A, MD2040B



**18-7858
FUEL FILTER**

Replaces: 858201
For CAV Type Unit

AQ120B, 125A, B, 131A, 140A, 145AB, 151, BB, 140, 145A.



**18-7862
FUEL FILTER
ELEMENT**

Replaces: 841162
(Includes Gasket)



**18-8149
HIGH CAPACITY
FUEL WATER SEPARATING FILTER**

Replaces: Volvo 3847644
Fits most gasoline applications with electric fuel pump. (some height restrictions may occur when using with 18-7778, Volvo 3850861)

**18-7942
FUEL FILTER**

Replaces:

466987, 3825133

For: MD100A, TMD100A, MD100B, MD120A, TMD120A, TAMD120A, MD120B, TMD120B, TAMD120B, MD70B, TMD70B, TAMD70B, THAMD70B, AQAD70B, MD70C, TMD70C, TAMD70C, AQD70C, TAMD60A, TAMD60B, TAMD60C, D5/ D7 MARINE GENSET, D5A-T, D5A-TA, D7A-T, D7A-TA, D7C-TA, D63 MARINE, D71/73 MARINE, KAD32P, TAMD42WJ, KAD43P/44P/300, KAMD43P/44P/300, TAMD103A, TAMD61A, TAMD62A, TAMD71A, TAMD72A, TAMD72P, TAMD72WJ, TAMD74, TAMD75 MARINE, TMD102A, TAMD102A, TAMD102D, TMD122A, TAMD122A, TAMD122P, TMD31L, TAMD31P/L/M/S, AD31P/L, TMD41L, TAMD41P/L/M/H



**18-7709
FUEL FILTER**

Replaces: 3840335

Fits: KAD42P-A, KAMD42P-1, KAD44P-B, KAD44P-C, KAMD44P-A, KAMD44P-B, KAMD44P-C, TAMD42WJ-A, KAD43P-A, KAMD43P-A, KAT44P-C, KAD300-A, KAMD300-A, MD6A, MD6B, MD7A, MD7B, D41L-A, TAMD41H-B, TMD41L-A, AD41L-A, AD41P-A, TAMD41H-A, TAMD41P-A, MD22A, MD22A-A, MD22L-A, TMD22A, TMD22-A, D3-110I-A, D3-130A-A, D3-130I-A, D3-160A-A, D3-160I-A, D3-110I-B, D3-110I-C, D3-130A-B, D3-130I-B, D3-130A-C, D3-130I-C, D3-160A-B, D3-160I-B, D30160A-B, D3-160A-C, D3-160I-C, D3-190A-B, D3-190I-B, D3-190A-C, D3-190I-C, KKAD42A, KAMD42A, AD41D, D41D, TAMD41D, TMD41D, MD22L-B, MD22P-B, TMD22-B, TMD22P-C, TAMD22P-B



**18-7859
FUEL FILTER**

Replaces: 835576

For: AQ175, 200, 226, 266, 290
BB200, 225, 260



**18-8124
DIESEL FUEL FILTER**

Replaces: 829913

Fits: 2001, 2001B, 2002, 2002B, 2003, 2003B/7/7B, AQD2B, MD11C/D, MD17C/D, MD1B, MD2B, MD3B, MD5A/B/C, MD7/B



**18-7792
FUEL FILTER**

Replaces: 3855104

For: Volvo 3.0L (1994-99), OMC 3.0L (1995-98)





18-7964-1
TRANSMISSION
FILTER KIT
For: Mercruiser V-8 Inboard
with Hurth Transmission



18-7717
FILTER ELEMENT
For: Rochester 2 bbl &
4 bbl Carburetors



18-79007
AIR FILTER
Replaces: 3825038
Fits: TAMD63L-1, TAMD63P-A



18-7689
FUEL INJECTOR
Replaces: 3855182
Fits: 5.7GLPMDA, 5.7GIPMDA, 5.7GIPMDACE, 5.7GLIM-
DA, 5.7GIIMDA, 4.3GLPHUB, 4.3GSPHUB, 4.3GSPHUS,
4.3GIPHUSCE, 5.7GIPHUS, 4.3GLPNCA, 4.3GLPNCB,
4.3GLPNCS, 4.3GSJNCC, 4.3GSJNCS, 4.3GSPNCA,
4.3GSPNCB, 4.3GSPNCM, 4.3GSPNCS, 4.9GIPNCA,
4.3GIPNCA, 4.3, 5.7GLPNCS, 5.7GIPNCA, 5.7GIPNCS,
5.7GIPNCSCE, 5.7GIPNCSCE, 5.7GIPNCSCE,
5.7GIINCCCE, 5.7GIINCSCE, 4.3GLPLKD, 4.3GLPLKE,
4.3GSPDKD, 4.3GSPDKCE, 4.3GIPDKCE, 4.3GSPDKCE,
4.3GSPDKD, 5.7GLPLKA, 5.7GLPLKD, 5.7GLPLKE,
5.7GLPLKR, 5.7GSPDKD, 5.7GSPDKCE, 5.7GIPDKD,
5.7GIPDKCE, 5.7GIPDKCE, 5.7GIPDKCE, 5.7GIPDKCE,
4.3GLBYC, 4.3GSPBYC, 4.3GIPBYC, 4.3GSPBYA,
4.3GLBYA (1994-07)



18-7685
TBI INJECTOR
Replaces: 3858941
Fits: 4.3GX-A, 4.3GLPWT, 4.3GLPWTR,
4.3GSPWT, 4.3GSPWTR, 4.3GIPWT, 4.3GIPWTR,
4.3GJWTR, 4.3GSJWTR, 4.3GLPEFS, 4.3GIPPEFS



18-7702
AIR CHARGE
TEMPERATURE SENDER
Replaces: 3854527
Fits: 5.0L Gxi-A(2001-02), 5.7L GIL-A
(2001), 5.7L Gi-A(2000-01), 5.7L GSIL-A
(2000-01), 5.7L Gxi-A(00-01), 5.7L XIL-A
(00-01), 5.7L Gxi-B(01-02), Many 7.4L
(1994-00), Many 8.1L (2005-Current)



18-7601
AIR CHARGE
TEMPERATURE SENSOR
Replaces: 3854158
For: 5.0 FI/5.8 FI (1994-96) &
5.0 FL/5.8 FL/5.8 FSi (1995-96)



18-7513
TEMPERATURE SENSOR
Replaces: 3862500



18-7647
TEMPERATURE SENDER
Replaces: 872066
Fits: 4.3GL-A, 4.3GL-B, 4.3GL-C, 4.3GL-D,
5.7GL-A, 5.7GL-B, 5.7GL-C, 5.7GL-D, 5.7GL-E,
5.0GL-A, 5.0GL-B, 5.0GL-C, 5.0GL-D, 5.0GL-E,
3.0GLP-A, 3.0GLP-B, 3.0GLM-A, 3.0GLM-B,
3.0GSP-A, 3.0GSP-B, 3.0GSP-C, 3.0GSM-A,
3.0GSM-B, 3.0GSM-C, 3.0GLM-C, 3.0GLP-C,
3.0GLP-D, 4.3GL-E, 4.3GL-EF, 5.0GL-F, 5.0GL-
FF, 3.0GLP-E, 4.3GL-G, 4.3GL-GF, 4.3GL-J,
4.3GL-JF, 5.0GL-H, 5.0GL-HF, 3.0GLP-J,
3.0GLP-N, 5.0GL-J, 5.0GL-JF (1998-2007)



18-5897
TEMPERATURE SENDER
Replaces: 3853787
For: 5.0L FL, FI, 5.8L FL, FI, FSi



18-5894
OIL PRESSURE LIGHT SWITCH
Replaces: 3852215



18-7700
THROTTLE POSITION SENSOR
Replaces: 3857487
Fits: 4.3, 5.0, 5.7, 8.1, 8.2L models



18-5899
OIL PRESSURE SENDER
Replaces: 3857532
For: 230, 250, 3.0L GLM, GLP, GSM,
GSP, 4.3L GL, GXI, OSI, 5.0L GL, GXI,
OSI, 5.7L GL, GI, GXI, GIL, GXIL, OSI,
OSXI, 8.1L GI, GXI, OSI, GIL



18-7704
IAC MOTOR
Replaces: 3855194



18-7705
IAC MOTOR
Replaces: 3843751



18-7684
MAP SENSOR
Replaces: 3850396
Fits: 4.3, 5.0, 5.7, 7.4L models
(1994-2007)



18-7677
KNOCK SENSOR
Replaces: 3850357
Fits: 4.3, 5.0, 5.7L models (2002-07)



18-7703
KNOCK SENSOR
Replaces: 3854512
Fits: 7.4, 8.2L (1999-2001)



18-7679
KNOCK SENSOR
Replaces: 3854905
Fits: 4.3L (1994-2002), 5.0L Gxi-A
(2001-02), 5.7L GIL-A(2001), 5.7Gi-A,
5.7GX-A, 5.7GX-B, 5.7Gi-A, 5.7GSII-A,
5.7GXII-A, 5.7GXII-B(2000-03), 5.7GLPNCS,
5.7GIPNCA, 5.7GIPNCS, 5.7GIPNCS,
5.7GIPNCSCE, 5.7GIPNCSCE,
5.7GIINCCCE, 5.7GIINCSCE(1995-96)



18-33800
PCV VALVE
Replaces: 3856884
Fits: 4.3L EFI

 <p>18-7888 DRAIN PLUG & GASKET Replaces: 826648, 862293 For CAV Filter</p>	<p>PKG OF 10</p>  <p>SNAPPER CLAMPS</p> <table border="1"> <thead> <tr> <th>Part #</th> <th>Range</th> <th>Size</th> </tr> </thead> <tbody> <tr> <td>18-8200 ①</td> <td>.360 - .406</td> <td>2</td> </tr> <tr> <td>18-8201 ①</td> <td>.410 - .468</td> <td>4</td> </tr> <tr> <td>18-8202 ①</td> <td>.475 - .536</td> <td>6</td> </tr> <tr> <td>18-8020 ①</td> <td>.538 - .608</td> <td>8</td> </tr> <tr> <td>18-8021 ①</td> <td>.597 - .665</td> <td>10</td> </tr> <tr> <td>18-8034 ①</td> <td>.670 - .780</td> <td>12</td> </tr> <tr> <td>18-8203 ①</td> <td>.750 - .875</td> <td>14</td> </tr> <tr> <td>18-8204 ①</td> <td>.875 - .975</td> <td>19</td> </tr> </tbody> </table>	Part #	Range	Size	18-8200 ①	.360 - .406	2	18-8201 ①	.410 - .468	4	18-8202 ①	.475 - .536	6	18-8020 ①	.538 - .608	8	18-8021 ①	.597 - .665	10	18-8034 ①	.670 - .780	12	18-8203 ①	.750 - .875	14	18-8204 ①	.875 - .975	19	 <p>18-3506 CIRCULATING PUMP Replaces: 21124846</p>
Part #	Range	Size																											
18-8200 ①	.360 - .406	2																											
18-8201 ①	.410 - .468	4																											
18-8202 ①	.475 - .536	6																											
18-8020 ①	.538 - .608	8																											
18-8021 ①	.597 - .665	10																											
18-8034 ①	.670 - .780	12																											
18-8203 ①	.750 - .875	14																											
18-8204 ①	.875 - .975	19																											
 <p>18-3513 CIRCULATING PUMP Replaces: 22844837 (Stainless Steel Impeller) Fits: 5.3L and 6.2L GM Engines</p>	 <p>18-3586-1 WATER PUMP Replaces: 841640 (Crank Shaft Mounted) Fits: 431A, 500A/B, 501A, 570A, 571A, AQ180, AQ200, AQ200B/C/D/F, AQ250A, AQ211A, AQ225, AQ231A/B, AQ260, AQ255B, AQ260A, AQ271A/B/C/D/, AQ280A, AQ290A.</p>	 <p>18-3577-2 CIRCULATING WATER PUMP Replaces: 3855991, 856609 For: GM Big Block V8 Uses gasket 18-0903 (included) (Bi-Directional)</p>																											
 <p>18-3593 CIRCULATING WATER PUMP Replaces: 3854017, 3858340 Fits: 3.0L 4 cyl. engines, GM 4 cyl. & in-line 6 cyl. Uses gasket 18-0327 (included) (Bi-Directional)</p>	 <p>18-3599-2 CIRCULATING WATER PUMP Replaces: 3853850, 835390, 856364 For GM V-6 & small block V-8 engines Uses gasket 18-0981 (included)</p>	 <p>18-0368 WATER CIRCULATING PUMP GASKET SET Fits: B21, B23, AQ120B, AQ125A, AQ140A, BB140A, AQ145A, BB145A</p>																											
 <p>18-2779 EXHAUST HOSE Replaces: 3852696 I.D. 4" x For: 4.3L GL, GS, Gi, GXI, OSI, 5.0L FI, GL, FL, GXI, OSI, 5.7L GL, Gi, GIL, OSI, GXI, OSXI, 5.8L FL, FI, FSI, 7.4L GL, Gi, 8.1L Gi, GXI, OSI, 8.2L GL</p>	 <p>18-2780-1 HOSE Replaces: 3852741, 3863450 I.D. 4" x For: 3.0L GL, GS, Gi, GLM, GLP, GSM, GSP, GS, 4.3L GL, GS, Gi, GXI, OSI, 5.0L FL, FI, GL, GXI, OSI, 5.7L GL, Gi, GXI, OSI, OSXI, GIL, GXIL, 5.8L FL, FI, FSI, 7.4L GL, Gi, GSI, 8.2L GSI</p>	 <p>18-2781 EXHAUST HOSE Replaces: 3852742 I.D. 4" x For: 5.0L FL, GL, GXI, OSI, 5.7L GL, Gi, GXI, GIL, GXIL, OSI, OSXI, 5.8L FL, FSI, 7.4L GL, Gi, GSI, 8.1L, 8.2L GL, GSI</p>	 <p>New</p> <p>18-31602 PUMP, SEA WATER Replaces: 3593654, 3580944 For: MD, D1</p>																										
 <p>New</p> <p>18-31604 SEA WATER PUMP Replaces: 3583115, 3581558 For: KAD, KAMD, AD, TAMD</p>	 <p>18-3106 WATER PUMP COUPLER Replaces: 806256, 831009 AQ90, 95, 100, 110, 120A, 115, 130, MB3B, 17C, D</p>	 <p>18-3175 WATER PUMP COUPLER Replaces: 858467 Fits: D31, D32, D41, D42, D43, D44, D300, AD31A, AD31B, AD31D, AD31L-A, AD31P-A, AD31XD, AQAD31A, MD31A, TAMD31A, TAMD31B, TAMD31D, TAMD31L-A, TAMD31M-A, TAMD31P-A, TMD31A, TMD31B, TMD31D, TMDL-A, KAD32P-A, AD41A, AD41B, AD41D, AD41L-A, AD41P-A, AQAD41A, D41A, D41B, D41D, D41L-A, TAMD41A, TAMD41B, TAMD41D, TAMD41H-A, TAMD41L-A, TAMD41M-A, TAMD41P-A, TMD41A, TMD41B, TMD41D, TMD41L-A, KAD42A, KAD42B, KAD42P-A, TAMD42B, TAMD42WJ-A, KAD43P-A, KAMD43P-A, KAD44P-A, KAD44P-B, KAD44P-C, KAMD44P-A, KAMD44P-B, KAMD44P-C, KAD300A, KAMD300A</p>																											

① This product is priced per piece. To order priced per package, please add -9 to the part number.



18-3274
IMPELLER KEY
 Replaces: 808007
 MD21B, AQD21B, 230A/SP-A/
 MT, 230A, 230B, 250A, 250B,
 AQ125B, AQ145B, AQ131A,
 AQ151, AQ151A, AQ151B,
 AQ151C, AQ171, AQ171A,
 AQ171C, 251A



18-3275
IMPELLER KIT
 Volvo 877066
 Fits: TAMD74A, A-A, A-B (2000-2005); TAMD74C-A, C-B (2000-
 2005); TAMD74L-A, B (1999-2005); TAMD74P-A, P-B (1998-2005);
 TAMD75P-A (1998-2005); TAMD71B (1989-2000); TAMD73P-A
 (1997-1998); TAMD73WJ-A (1997-1999).



18-3504
IMPELLER KIT
 Volvo 3588475
 Fits: D4-180I-B, D4-180I-C, D4-180I-D, D4-210A-A, D4-210A-B,
 D4-210I-A, D4-210I-B, D4-225A-B, D4-225A-C, D4-225A-D,
 D4-225I-B, D4-225I-C, D4-225I-D, D4-260A-A, D4-260A-B,
 D4-260A-C, D4-260A-D, D4-260D-B, D4-260D-C, D4-260D-
 D, D4-260I-A, D4-260I-B, D4-260I-C, D4-260I-D, D4-300A-A,
 D4-300A-C, D4-300A-D, D4-300I-A, D4-300I-C, D4-300D-D,
 D4-300I-A, D4-300I-C, D4-300I-D



18-3276-1
IMPELLER KIT
 Replaces: 3862567, 21213660
 Fits: Volvo (1999 and Later)



18-3277
IMPELLER KIT
 Replaces: 3862281, Yanmar
 192470-42530, 192470-42532
 Fits: Volvo (1998 and Earlier),
 Johnson Pump 09-812B-1



18-3047
IMPELLER KIT
 Replaces: 835874
 Sherwood 10615K,
 Jabsco 18948-0001
 12 FINS



18-3060
IMPELLER
 Replaces: 835512, 3854286
 Sherwood 9959,
 Jabsco 18838-0001
 Oberdorfer 132-0317
 OMC 3854286
 Neoprene, 12 FINS



18-3046
IMPELLER
 Replaces: 3854286



18-3061
IMPELLER
 Replaces: 835874,
 Sherwood 0615K,
 Jabsco 18948-0001
 Neoprene
 12 FINS
 For: GM engines with V-Belt



18-3077
IMPELLER
 Replaces: 21213664
 Fits: Gas GM engines 2005 & Up



18-3075
IMPELLER KIT
 Replaces: 875575, Jabsco 2877-0001,
 4568-0001, Johnson 09-801B,
 Oberdorfer B6620
 12 FINS
 Neoprene



18-3076
IMPELLER KIT
 Replaces: 875583, 833995
 Jabsco 22405-0001
 Johnson Pump 09-45589,
 09-808B
 6 FINS, Neoprene



18-3077 (Neoprene)
18-3038 (Nitrile)
WATER PUMP KIT
 Replaces: 877061-2, 3841697
 For: AQ 30, 31, 40, 41 AQD 19, 27, 29, 32, KAD/KAMD
 42A, B, P, MD, 19, 27, 29, 32, TAMD 60A, B, C



18-3078 (Neoprene)
18-3037 (Nitrile)
WATER PUMP KIT
 Replaces: 875736, 875660, 2430184
 Jabsco 836-0003,
 Johnson Pump 09-1029B-9
 For: AQ, AD 40 A, B, TAMD 40 A, B, TAMD 61-62 A, 71-72A



18-3287
IMPELLER KIT
 Replaces: 876120
 Fits: 431A, BB231A, 570A, 571A, 572A, 740A, 740B,
 AQ200D, AQ205A, AQ225D, AQ255B, AQ260A, AQ260B,
 AQ271A, AQ271B, AQ271C, AQ271D, AQ280A, AQ290A,
 AQ311A, AQ311B, BB225A, BB225AV, BB225B, BB260A,
 BB260AV, BB261A

Ⓛ Items ending in "D" are Display Packaged - Regular number is Non-Display



18-3079
IMPELLER KIT
 Replaces: 875807-0, 3586498
 Johnson Pump 09-806B Sherwood 9979K
 6 FINS
 Neoprene
 Jabsco 4528-0001
 Side Width 3/4" Dia. 1 1/16"



18-3080
(Neoprene)
WATER PUMP KIT
 Volvo 875808, 3593659
 Jabsco 673-0001
 Johnson Pump 09-1026B-1
 For: AQ 60, 60, 90, 95, 100, 105, 110, 115, 120A, 130, B 16, BB 25, 30, 70, 100, MB 18, 20, MD 3B, 17C, D, ND2010B, 2020B, 2030B, 2040BC

18-3036
(Nitrile)
 Volvo 875808-8
 Jabsco 673-0003
 Johnson Pump 09-1026B-9



18-3081D Display Package
18-3081
IMPELLER KIT
 Replaces: 875811-2, 3858256, 3862281
 OMC 3858256
 Johnson Pump 09-1027B
 Neoprene
 12 SPLINES 12 FINS
 Jabsco 1210-0001



18-3089
WATER PUMP KIT
 Replaces: 09-45825
 Johnson Pump
 For 18-3587-1 Pump



18-3205
WATER PUMP REPAIR KIT
 Replaces: 875574
 AQ120B, 125A, B, 131A, 140A, 145A, B, 151A, B



18-3208
WATER PUMP REPAIR KIT
 Replaces: 875584
 MD5A, B, C, MD6B, MD7A, B, MD11C, D



18-3209
WATER PUMP REPAIR KIT
 Replaces: 875383
 AQ165A, 170A, B, C, MD21A
 (S/N MD103387 & UP), MD21B



18-3261
WATER PUMP REPAIR KIT
 Replaces: 875769
 Fits: D40, AD40B, AQAD40A, AQAD40B, TAMD40A, TAMD40B

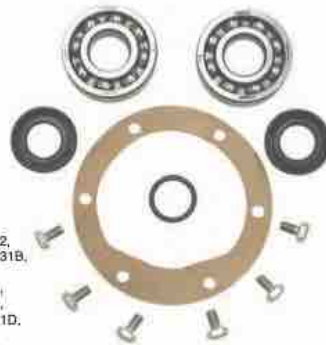

18-3262
WATER PUMP REPAIR KIT
 Replaces: 875759
 For sea water pumps: Fits: D30, D31, D32, D40, D41, D42, D43, D44, AD30A, AQAD30A, TAMD30A, TMD30A, AD31A, AD31B, AD31D, AD31XD, AQAD31A, MD31A, TAMD31A, TAMD31B, TAMD31D, TMD31A, TMD31B, TMD31D, KAD32P-A, AQD40A, MD40A, TMD40A, TMD40B, TMD40C, AD41A, AD41B, AD41D, AQAD41A, D41A, D41B, D41D, TAMD41A, TAMD41B, TAMD41D, TMD41A, TMD41B, TMD41D, KAD42A, KAD42B, KAD42P-A, KAMD42A, KAMD42B, KAMD42P-A, TAMD42B, TAMD42WJ-A, KAD43P-A, KAMD43P-A, KAD44P-A, KAMD44P-A



18-3263
WATER PUMP REPAIR KIT
 Replaces: 875698
 For sea water pumps: Fits: B18, B20, D3, D17, AQ60F, AQ90, AQ95A, AQ110, AQ120, BB30, BB100, MB18, AQ105A, AQ115A, AQ115B, AQ130A, AQ130B, AQ130C, AQ130D, BB115, BB115B, BB115C, MB20A, MB20B, MB20C, MD3B, MD17C, MD17D,

① Items ending in "D" are Display Packaged - Regular number is Non-Display

SINGLE DIAMETER HOSE

18-70021
MOLDED HOSE
¾" ID



4 ¾"

18-70704
MOLDED HOSE
1 ¼" ID



5"

18-70924
MOLDED HOSE
1 ¾" ID



5"

18-71218
MOLDED HOSE
1" ID



12 ½"

18-71337
MOLDED HOSE
1 ¾" ID



12 ¾"

STRAIGHT HOSE

18-75100
MOLDED HOSE
Straight 48"
1" ID



18-75125
MOLDED HOSE
Straight 48"
1 ¼" ID



V-BELTS



- 1 High strength synthetic cords resist shockload failure. Their low stretch properties assure uniform performance over the life of the belt.
- 2 The compression section is a special rubber compound that assures smooth and even transfer of load forces to the cords.
- 3 Cogs are molded to precise engineering tolerances to improve flexibility and maintain cord support. Cog geometry provides a large area for air circulation to keep the belt cool and prevent damaging heat build up in the cushion section.
- 4 Rubber edges maintain positive, no-slip contact with pulley grooves for reliable energy transfer.

BELT SIZE LISTING BY NUMBER

Part #	Effective Length (Inches)	Top Width (Inches)	Part #	Effective Length (Inches)	Top Width (Inches)	Part #	Effective Length (Inches)	Top Width (Inches)
18-15290	29	29/64	18-15405	40 1/2	29/64	18-15460	46	29/64
18-15300	30	29/64	18-15410	41	29/64	18-15470	47	29/64
18-15325	32 1/2	29/64	18-15415	41 1/2	29/64	18-15480	48	29/64
18-15345	34 1/2	29/64	18-15430	43	29/64	18-15495	49 1/2	29/64
18-15370	37	29/64	18-15435	43 1/2	29/64	18-15500	50	29/64
18-15380	38	29/64	18-15440	44	29/64	18-15520	52	29/64
18-15390	39	29/64	18-15450	45	29/64	18-15550	55	29/64
18-15400	40	29/64	18-15455	45 1/2	29/64	18-17570	57	17/32

V-BELT INTERCHANGE

Part #	Volvo #	Part #	Volvo #	Volvo #	Part #	Volvo #	Part #
18-15325	958303	18-15460	829207	829207	18-15460	985357	18-15415
18-15390	958310	18-15460	950818	841821	18-15430	958498	18-4046
18-15405	958311	18-15495	958320	950813	18-15410	966694-2	18-4044
18-15410	950813	18-15500	952141	950818	18-15460	966857	18-4046
18-15415	985357	18-4046	958498	952141	18-15500		
18-4044	966694-2	18-4046	966857	958303	18-15325		
18-15430	841821			958310	18-15390		
18-15435	958314			958311	18-15405		
18-15435	966382			958314	18-15435		
18-15450	3858462			958320	18-15495		
18-15455	3852464			966382	18-15435		

HOSE INTERCHANGE

Part #	Volvo #	Part #	Volvo #	Volvo #	Part #	Volvo #	Part #
18-70704	838513	18-75125	826423	826423	18-75125	845792	18-75125
18-70704	856306	18-75125	845792	838513	18-70704	856306	18-70704

**Fits GM Small Block V8 305-350 cu. in.
Models AQ & BB 200, 205, 211, 231, 225,
260, 271, 290, 311, 500, 501, 570, 571 & 572**

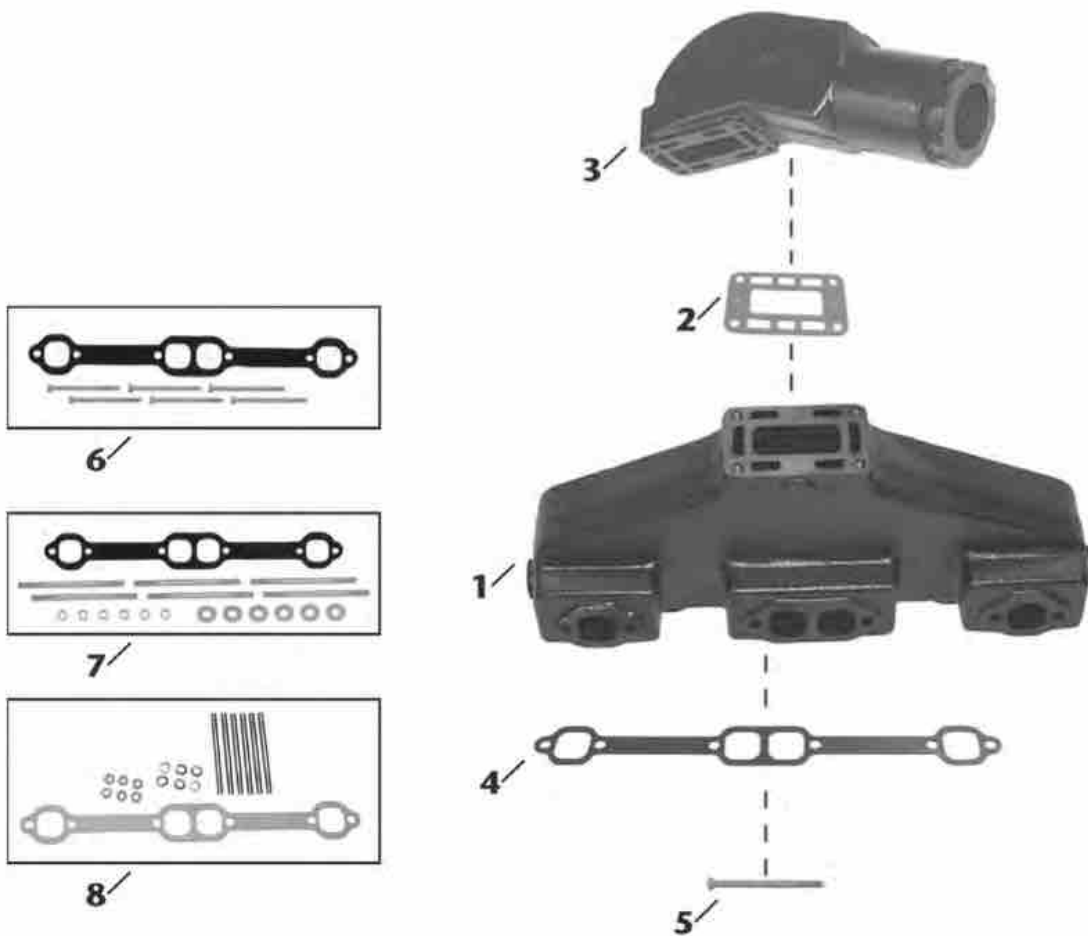

Item No	Description	OE No.	Application
1	18-1931-1 MANIFOLD	835804-6	GM Small Block (V8) 305-350 cu.in. Model AQ & BB 200, 205, 231, 225, 260, 271, 290, 311, 500, 501, 570, 571, & 572. Use with Manifold Gasket: 18-2949; Mounting Kit: 18-8511.
2	18-2971-1 ELBOW GASKET	856039-3	Use with Manifold: 18-1931-1; Elbow: 18-1935-1
3	18-1935-1 ELBOW	855384-4	Use with Manifold: 18-1931-1; Elbow Gasket: 18-2971-1.
4	18-2949 MANIFOLD GASKET	N/A	Use with Manifold: 18-1931-1; Included in 18-8511 mounting kit.
5	NSS MOUNTING BOLT	N/A	Included in 18-8511 mounting kit.
6	18-8511 MOUNTING KIT	N/A	Use with Manifold: 18-1931-1.
7	18-8502 MOUNTING KIT	N/A	Use with Manifold: 18-1931-1. Includes mounting studs and hardware.
8	18-8502 MOUNTING KIT	N/A	Use with Manifold: 18-1931-1. Includes mounting studs and hardware.

Fits GM V6 (1993 & Before) AQ 175, 205, 430A/B, 431, 434

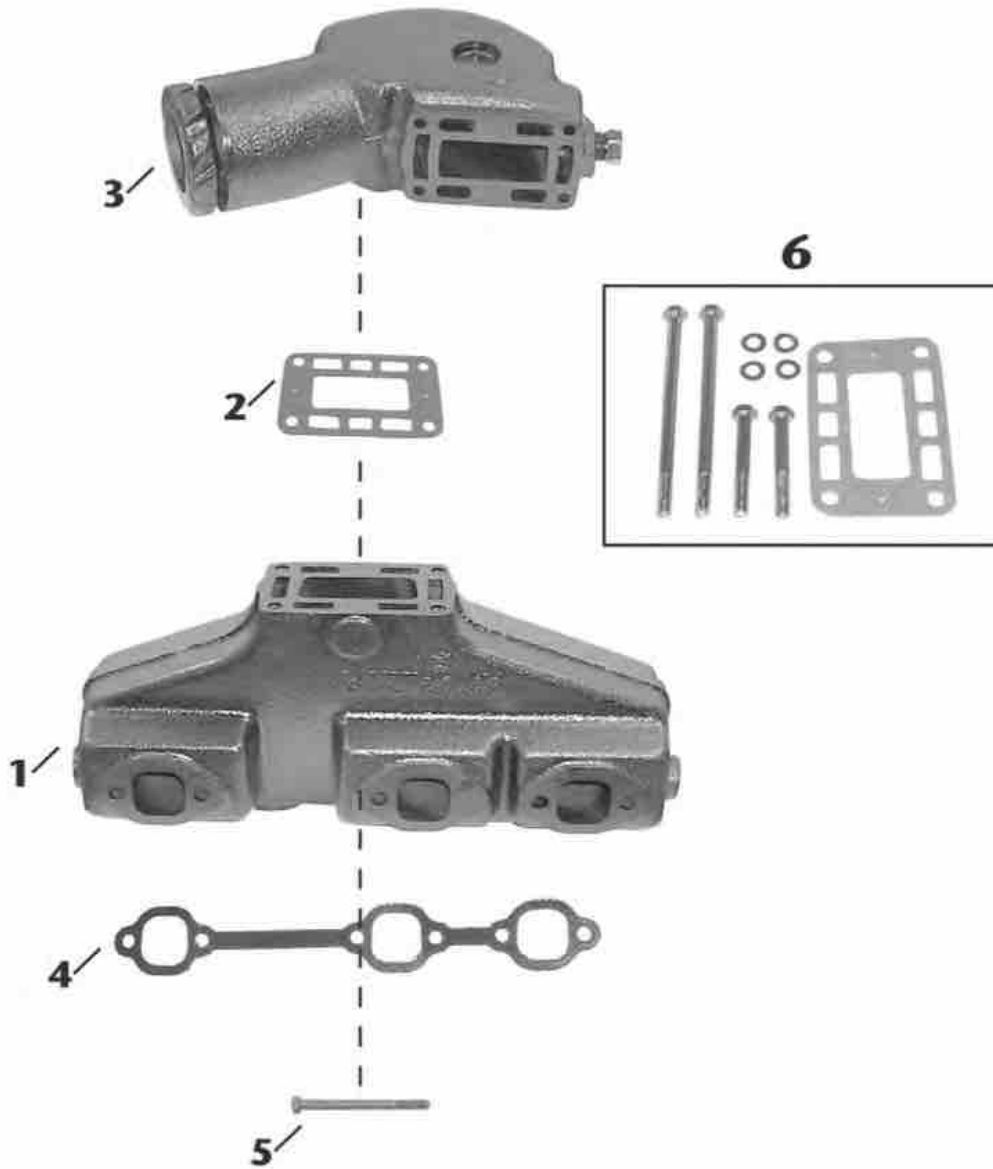

Item No	Description	OE No.	Application
1	18-1932 MANIFOLD	856894-1	GM (V6) (1993 & Before) Model AQ 175, 205, 430 A/B, 432, 434. Use with 18-2909 Manifold Gasket.
2	18-2971-1 ELBOW GASKET	856039-3	Use with Manifold: 18-1932; Elbow: 18-1936.
3	18-1936 ELBOW	857037-6	Use with Manifold: 18-1932; Elbow Gasket: 18-2971-1
4	18-2909 MANIFOLD GASKET	N/A	Use with Manifold: 18-1932.
5	NSS MOUNTING BOLT	N/A	Use to secure 18-2909 to 18-1932.
6	18-19360 HARDWARE KIT	N/A	Use with 18-1936 Elbow

**SIERRA MANIFOLDS
ARE PAINTED, PACKAGED & LEAK TESTED**



**18-1848
MANIFOLD**
Replaces: 3857656, 3847499
Fits: Volvo 4.3L V-6



**18-1898
MANIFOLD**
Port & Starboard
Replaces: Barr CHVA-1-84, Marine Power 0991-110
Fits 454 cu.in. GM big block V8 engines
Use with:
Exhaust Manifold Gasket: 18-0418
***For Exploded View - See Pages 654-655**



**18-1930-2
MANIFOLD**
Replaces: 855387, 834438-4
FITS: Volvo AQ120B, 125A, 140A, 145A, BB140A, 145A
Supplied with Mounting Package
Use with:
Exhaust Manifold Gasket: 18-2991-1
Mounting Kit: 18-8539



**18-1931-1
MANIFOLD**
Port & Starboard
Replaces: 835804, 856883
FITS: Volvo AQ200D, 200F, 225D, 225E, 225F, 255B, 260A, 271A, 280A, 290A, 311A, AQ500, 570; BB225, 225AV, 225B, 260A, 260AV, 260B, 260C
Supplied with Mounting Package
Use with:
Mounting Kit: 18-8511



**18-1986-1
MANIFOLD**
Port & Starboard
Replaces: 3852374-2, 3857723, 3847501
Barr OMC-1-914035
For: 5.0L & 5.7L GM (New Style)
Use with:
Exhaust Manifold Gasket: 18-2949
Mounting Kit: 18-8502



**18-1932
MANIFOLD**
Port & Starboard
Replaces: 856894
For: 4.3L Fits: AQ175, AQ430, AQ431A, AQ431B, AQ432, AQ434
Use with:
Exhaust Manifold Gasket: 18-2909



**18-1997-1
MANIFOLD**
Port & Starboard
Replaces: Barr CHV-1-83
Universal Center Riser Manifold
FITS: GM 283, 305, 307 and 350 CID engines
Use with:
Exhaust Manifold Gasket Set: 18-0604
***For Exploded View - See Pages 656-657**



**18-1936
RISER**
Replaces: 857037
For: 4.3L Fits: AQ175, AQ430, AQ431A, AQ431B, AQ432, AQ434
Use with:
Riser Gasket: 18-2971-1
Mounting Kit: 18-19360



**18-1999
ELBOW**

Replaces: Barr 20-0082
Comes with 18-4364 Exhaust Elbow Kit (open)
If blocked mounting kit is required use 18-8535
Replaces: Barr 20-0082-P

Use with:
Manifold: 18-1997-1
Riser Gasket: 18-2854-1 open or 18-0476-1 blocked



**18-1935-1
RISER**

Replaces: 855384-4, 856891

Use with:
Manifold: 18-1931-1
Exhaust Riser Gasket: 18-2971-1
Mounting Kit: 18-8510



**18-1909-1
RISER**

Replaces: OMC 913784, 3855270, 3850456, Volvo 3855270-9, 3863061
OMC Riser, 4" outlet 7"
Fits many GM & Ford center rise manifolds.

Use with:
Manifold: 18-1986-1 & 18-1848
Riser Gasket: 18-0943-2 open
Mounting Kit: 18-8507 open



**18-1939
RISER**

For use with 4" I.D. exhaust hose
Replaces: Barr 20-0100, Marine Power 0992-593 Barr, Indmar, and Marine Power Ford Small Block V8 302-351cu.in., GM Small Block V8 305-350cu.in., GM Big Block V8 454cu.in.

Use with:
Manifold: 18-1997-1, 18-1998-1
Riser Gasket: 18-2854-1 open or 18-0476-1 blocked
Mounting Kit: 18-4364 open or 18-8535 blocked



**18-1907
RISER**

For use with 3" I.D. exhaust hose
Replaces: Barr 20-0102, Indmar 53-2009, 53-2018 Barr and Indmar Ford Small Block V8 302-351cu.in.

Use with:
Manifold: 18-1997-1, 18-1998-1
Riser Gasket: 18-2854-1 open or 18-0476-1 blocked
Mounting Kit: 18-4364 open or 18-8535 blocked



**18-1876
RISER**

Replaces: 980617

Use with:
Manifold: 18-1904
Riser Gasket: 18-2850
Fits: 170 (1974), 175 (1975-76), 190 (1974-76), 235 (1975-76)



**18-1991
ELBOW ADAPTER**

Replaces: Barr 200089P
For use with 3" I.D. Exhaust Hose

Use with:
Manifold Riser: 18-1999
30°



**18-1992-1
ELBOW ADAPTER**

Replaces: Barr 200087P
For 3" I.D. Exhaust Hose
(As used in 18-1987 Exhaust Manifold Conversion Kit)
80°



**18-1949
MANIFOLD SPACER**

Barr CM 20-0097
Barr, Indmar and Marine Power Ford Small Block V8 302-351cu.in., GM Small Block V8 305-350cu.in., GM Big Block V8 454cu.in.
Used with:
Manifolds: 18-1998-1, 18-1997-1, 18-1898



**18-4364 (Open)
EXHAUST ELBOW KIT**

Replaces: Barr 20-0082-P
Use with:
Riser: 18-1999, 18-1907, 18-1939

PKG. OF 2



**18-0943-2
18-0943-2-9①
EXHAUST ELBOW GASKET**















Replaces: 3850496
Use with:
Riser: 18-1909-1

PKG. OF 2

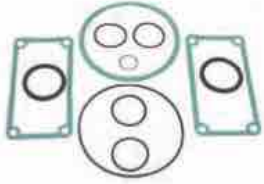
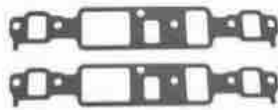

**18-2909
18-2909-9①
EXHAUST
MANIFOLD GASKET**

Replaces: 856116, 3853412
For: Volvo 4.3GL, GS, GI, GXI, OSI

 <p>18-8502 EXHAUST MANIFOLD MOUNTING KIT OMC GM Small Block V8 305-350cu.in. (1979-89) OMC/Volvo GM Small Block 305-350cu.in. Used with: Manifold: 18-1931-1, 18-1902, 18-1903 & 18-1986-1</p>	 <p>18-8507 EXHAUST ELBOW MOUNTING KIT Replaces: Barr 20 6674JP OMC/Volvo GM Small Block V8 305-350cu.in. Used with: Riser: 18-1909-1</p>	 <p>18-8510 EXHAUST ELBOW MOUNTING KIT Volvo GM Small Block V8 305-350cu.in. (Models: AQ and BB200, 205, 211, 231, 225, 260, 271, 290, 311, 500, 501, 570, 571, 572) Used with: Riser: 18-1935-1</p>
 <p>18-8511 EXHAUST MANIFOLD MOUNTING KIT Volvo GM Small Block V8 305-350cu.in. (Models: AQ and BB200, 205, 211, 231, 225, 260, 271, 290, 311, 500, 501, 570, 571, 572) Used with: Manifold 18-1931-1</p>	 <p>18-8535 (Blocked) EXHAUST ELBOW MOUNTING KIT Barr, Indmar and Marine Power Ford Small Block V8 302-351cu.in., GM Small Block V8 305-350cu.in., GM Big Block V8 454cu.in. Used with: Riser: 18-1939, 18-1999, and 18-1907</p>	 <p>18-8536 EXHAUST ELBOW MOUNTING KIT Barr, Indmar and Marine Power GM Small Block V8 305-350cu.in. Used with: Manifold: 18-1997-1</p>
 <p>18-8538 EXHAUST MANIFOLD MOUNTING KIT Barr and Indmar Ford Small Block V8 302-351cu.in. Used with: Manifold: 18-1998-1</p>	 <p>18-8539 EXHAUST MANIFOLD MOUNTING KIT Volvo 4 Cylinder B20 2.3 and 2.5L (Models: AQ 120, 125, 131, 140, 145, and 151, BB140, 145, 230, and 250) Volvo 4 Cylinder B20 2.3 and 2.5L (Models: AQ 120, 125, 131, 140, 145, and 151, BB140, 145, 230, and 250) Used with: Manifold: 18-1930-2</p>	 <p>18-19360 HARDWARE KIT Used with: Riser: 18-1936</p>
 <p>18-0146 HEAT EXCHANGER GASKET SET Fits: B21, B23, AQ120B, AO125A, AO140A, BB140A, AQ125B, AO145A, AO145B, BB145A</p>	 <p>18-0337 HEAT EXCHANGER GASKET SET Fits: AD40B, AQAD40A, AQAD40B, TAMD40A, TAMD40B, TMD40B, TMD40C</p>	 <p>18-4408 INTAKE MANIFOLD GASKET SET Replaces: 3850379 Fits: 4.3L GL, GS, GI</p>
 <p>18-0476-1 (Blocked) RISER BLOCKOFF GASKET Replaces: Barr 01-0105 Indmar & Marine Power Ford Small Block V8 302-351cu.in. Used with: Riser: 18-1939, 18-1999 & 18-1907</p>	<p>PKG. OF 2</p>  <p>18-2854-1 (Open) 18-2854-9 EXHAUST ELBOW GASKET Replaces: Barr 01-0107 Used with: Manifold: 18-1999, 18-1939, 18-1907</p>	<p>PKG. OF 2</p>  <p>18-2875-1 18-2875-1-9 EXHAUST ELBOW GASKET Replaces: 3850495 For: 3.0L GS, GL, GLM, GLP, GSM, GSP</p>

① Priced per Package



**18-0418
EXHAUST
MANIFOLD GASKET**
Replaces: 3852472
For: Volvo 7.4L GL, G1, GSI,
8.2L GL, G1, GSI



**18-0680
EXHAUST
MANIFOLD GASKET**
Replaces: 3853256



PKG. OF 2
**18-2902-1
18-2902-1-9**
MANIFOLD GASKET
Replaces: 3852468
For: 5.0L GL, GXI, OSI, 5.7L GL, G1, GXI,
GIL, GXIL, OSI, GXIL, OSXI



PKG. OF 2
**18-2949
18-2949-9**
EXHAUST MANIFOLD GASKET
Replaces:
Barr CHV-47-000
Used with:
Manifold: 18-1986-1,
18-1997-1 and 18-1931-1
AQ200, 225, 260, 271, 290, 311



**18-2971-1
EXHAUST MANIFOLD GASKET**
Replaces: 835908-5, 856039-3
Used with:
Riser: 18-1935-1



PKG. OF 4
**18-2991-1
18-2991-1-9**
EXHAUST MANIFOLD GASKET
Replaces: 855967, 855383
Used with:
Manifold: 18-1930-2
AQ200, 225, 260, 271, 290, 311



**18-4461
HOSE BARB**
3/4" - 14 NPT x 1" Hose
Corrosion Resistant Brass Fitting



PIPE PLUGS

Part #	Thread Size
18-4256	1/4"
18-4257	1/4"
18-4258	3/4"
18-4263	1/8" - 27 NPT
18-4264	3/8" - 18 NPT

DRAIN TAPS

Part #	Replaces:
18-4216	807036
18-4218	82745
18-4218D	
18-4697	



18-3223-9
Bulk pack of 12 (18-4218)
Use with most OEM manifolds

DRAIN TAP APPLICATION

Model	Thread Size	Location	Tap
MD1A,B,2A,B,3B,5A,B,MD6A	10 x 1	Cyl Block	18-4216
AQ90,95,100,110,115,120,125A,B,130,131A,140A,145A,B, 151A,B,171A,MB18,MB20,BB30,100,AQD40,AQAD40,TMD40	1/4" NPT	Cyl Block	18-4218
MD5C,11C,D,17C,D	1/8" NPT	Cyl Block	-
D40, 2001, 2002, 2003 V6, B23, B25, D30, D31, D40, D41	1/4" NPT	Oil Cooler	18-4697

① Priced per Package

② Items ending in "D" are Display Packaged - Regular number is Non-Display

③ This product is priced per piece. To order priced per package, please add -9 to the part number

















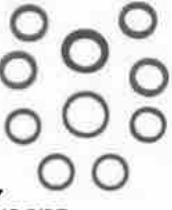

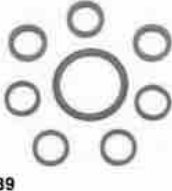
Model	Exhaust Manifold	Exhaust Elbow	Manifold Mounting Kits	Exhaust Elbow Kits	Manifold Gasket	Elbow Gasket
230	18-1930-2	-	18-8539	-	18-2991-1	-
250	18-1930-2	-	18-8539	-	18-2991-1	-
AQ120B	18-1930-2	-	18-8539	-	18-2991-1	-
AQ125A	18-1930-2	-	18-8539	-	18-2991-1	-
AQ131A,B,C,D	18-1930-2	-	18-8539	-	18-2991-1	-
AQ140A	18-1930-2	-	18-8539	-	18-2991-1	-
AQ145A,B	18-1930-2	-	18-8539	-	18-2991-1	-
AQ151A,B,C	18-1930-2	-	18-8539	-	18-2991-1	-
AQ200C,D/280	18-1931-1	18-1935-1	18-8511/18-8502	18-8510	18-2949	18-2971-1
AQ200D,F	18-1931-1	18-1935-1	18-8511/18-8502	18-8510	18-2949	18-2971-1
AQ225C,D/280	18-1931-1	18-1935-1	18-8511/18-8502	18-8510	18-2949	18-2971-1
AQ225D,E,F	18-1931-1	18-1935-1	18-8511/18-8502	18-8510	18-2949	18-2971-1
AQ255A,B/280	18-1931-1	18-1935-1	18-8511/18-8502	18-8510	18-2949	18-2971-1
AQ260A,B	18-1931-1	18-1935-1	18-8511/18-8502	18-8510	18-2949	18-2971-1
AQ290A	18-1931-1	18-1935-1	18-8511/18-8502	18-8510	18-2949	18-2971-1
AQ430	18-1932	18-1936	-	-	18-2909	18-2971-1
AQ431	18-1932	18-1936	-	-	18-2909	18-2971-1
AQ432	18-1932	18-1936	-	-	18-2909	18-2971-1
AQ434	18-1932	18-1936	-	-	18-2909	18-2971-1
BB140A	18-1930-2	-	18-8539	-	18-2991-1	-
BB145A	18-1930-2	-	18-8539	-	18-2991-1	-
BB225A,B,C	18-1931-1	18-1935-1	18-8511/18-8502	18-8510	18-2949	18-2971-1
BB260A,B,C	18-1931-1	18-1935-1	18-8511/18-8502	18-8510	18-2949	18-2971-1
500B	-	18-1936	-	-	18-2909	18-2971-1
501B	-	18-1936	-	-	18-2909	18-2971-1
570	18-1931-1	18-1935-1	-	-	18-2909	18-2971-1
572	-	18-1936	-	-	18-2909	18-2971-1
740B	-	18-1936	-	-	18-2909	18-2971-1
LK 4.3L	-	18-1936	-	-	18-2909	18-2971-1
LK 5.7L	18-1986-1	18-1909-1	18-8502	18-4364/18-8535	18-2949	18-2854-1/18-0476-1
HU 5.7 Gi	18-1986-1	18-1909-1	18-8502	18-4364/18-8535	18-2949	18-2854-1/18-0476-1
MD 5.7GL / 5.7Gi	18-1986-1	18-1909-1	18-8502	18-4364/18-8535	18-2949	18-2854-1/18-0476-1
NC5.7 GL / 5.7Gi	18-1986-1	18-1909-1	18-8502	18-4364/18-8535	18-2949	18-2854-1/18-0476-1

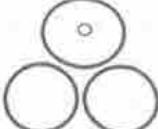
④ Volvo Configuration Match (Bolts Used in Hardware Kit)

⑤ OMC Configuration Match (Studs Used in Hardware Kit)

⑦ Open Gasket

⑧ Closed Gasket

<p>PKG. OF 5</p>  <p>18-4236 18-4236-9[Ⓛ] WASHER Replaces: 941907</p>	 <p>18-4150 WATER PUMP SHAFT Replaces: 812994 For Pump Without Ball Bearing AQ90, 95, 100, 105, 110, 115, 120, 130, MD3B, 17C</p>	 <p>18-2774 MOLDED HOSE Replaces: 875847 AQ290, AQ290DP Includes (2) 18-7306 Clamps</p>	 <p>18-2775 MOLDED HOSE Replaces: 875822 AQDRIVE UNITS 200, 250, 270, 270T, 275, 280, 280T, 280PT, DP UNIT: 280 Includes (2) 18-7306 Clamps</p>	
 <p>18-2776 MOLDED HOSE Replaces: 832831 AQ270T, 280T Includes (2) 18-7306 Clamps</p>	 <p>18-0163 COOLING PIPE GASKET SET For: B30, AQ165A, AQ170A, AQ170B, AQ170C, BB165A, BB170A, BB170B, BB170C</p>	 <p>18-0376 COOLING PIPE GASKET SET Fits: D6, D7, MD6A, MD6B, MD7A, MD7B</p>	 <p>18-0377 COOLING PIPE GASKET SET Fits: B21, B23, AQ120B, AQ125A, AQ140A, BB140A, AQ125B, AQ145A, AQ145B, BB145A</p>	
 <p>18-0590 COOLING PIPE GASKET SET Fits: B20, AQ125A, AQ115B, AQ130A, AQ130B, AQ130C, AQ130D, BB115A, BB115B, BB115C</p>	 <p>18-0648 COOLING PIPE GASKET SET Fits: D11, D17, MD11C, MD11D, MD17C, MD17D</p>	 <p>18-3889 COOLING PIPE GASKET SET Fits: B23, B25, 230A, 230B, AQ131A, AQ131B, AQ131C, AQ131D, 250A, 250B, 251A, AQ151A, AQ151B, AQ151C, AQ171A, AQ171C</p>	 <p>18-0606 COOLING PIPE GASKET SET Fits: B18, B20, AQ06F, AQ90, AQ95, AQ95A, AQ110, AQ120, BB30, BB100, MB18, AQ105A, MB20A, MB20B, MB20C</p>	
 <p>18-0907 OIL DRAIN PLUG GASKET SET For oil plugs: Fits: 200, 250, 270, 270T, 275, 275A</p>	 <p>18-3890 OIL COOLER GASKET SET Fits: B20, B21, B23, B25, B30, AQ115A, AQ115B, AQ130A, AQ130B, AQ130C, AQ130D, BB115A, BB115B, BB115C, MB20A, MB20B, MB20C, AQ120B, AQ125A, AQ140A, BB140A, 230A, 230B, AQ145A, AQ145B, BB145A, 250A, 250B, 251A, AQ151A, AQ151B, AQ151C, AQ171A, AQ171C, AQ185A, AQ170A, AQ170B, AQ170C, BB165A, BB170A, BB170B, BB170C</p>	 <p>18-2777 WATER HOSE CONNECTION Replaces: 854031 *AQ120B, *AQ125A, B, AQ130A, B, D, *AQ130C, *AQ131A, AQ140A, AQ145A, *AQ165A, *AQ170A, B, C, *AQ175A, AQ200D, AQ225D, *AQ225E, AQ260A, AQ260B, AQ290A, *AQAD31A, AQD40A, AQD21A, AQAD40A * Models with Power Trim</p>	 <p>18-2778 WATER HOSE CONNECTION Replaces: 832846 AQ140A, AQ145A, AQ165A, AQ170A, *AQ175D, AQ200D, AQ225D, AQ260A, AQ290A, *AQ280, *AQ280L, AQAD30A, AQAD40A, B * Models with Power Trim</p>	
 <p>18-3557 THERMOSTAT Replaces: 21148403 143°</p>	 <p>18-3558 THERMOSTAT Replaces: 3853799 160°</p>	 <p>18-3679 THERMOSTAT Replaces: 3840816, 3584474 For: D3</p>	 <p>18-3680 THERMOSTAT Replaces: 3580365 For: MD, D2</p>	 <p>18-3681 THERMOSTAT Replaces: 8149182 For: DH, TD, TAD, TWD, D4, D6, TAMD</p>

Ⓛ Priced per Package



18-3682
THERMOSTAT KIT
Replaces: 21613426, 21412639,
21237213
For: TAD, TWD, , D12, D13, D9, D16



18-3683
THERMOSTAT KIT
Replaces: 3839110, 1661993
For: TD, TWD, TAMD



18-3654
THERMOSTAT KIT
(60°C)
Replaces: 875779
140°



18-3539
THERMOSTAT KIT
Closed Cooling System
(Includes sealing ring)
Replaces: 3831426
160°



18-3538
THERMOSTAT KIT
(Includes sealing ring)
Replaces: 3831424



① **18-3676D** Display Package
18-3676
THERMOSTAT KIT
Replaces: 3853983
140°

— **CONTAINS** —

Part #	OE#	Description
18-7170	3852071	O-Ring
18-0398	835417	Gasket
—	3853983	Thermostat



① **18-3670D** Display Package
18-3670
THERMOSTAT KIT
160°
— **CONTAINS** —

Part #	O.E.#	Desc.
18-3558	3853799	Thermostat
18-2858	3852127	Thermostat Housing
—	—	Cover Gasket
18-0929	3852120	Thermostat Gasket



① **18-3677D** Display Package
18-3677
THERMOSTAT KIT
Replaces: 3856961
160°
— **CONTAINS** —

Part #	OE#	Description
18-7170	3852071	O-Ring
18-0398	835417	Gasket
—	3856961	Thermostat



18-3656
THERMOSTAT KIT
140°
Replaces: 876097, 875781



Display Package
18-3658
THERMOSTAT KIT
165°
Replaces: 875784, 877349



18-3659
THERMOSTAT KIT
160°
Replaces: 875785



18-3660
THERMOSTAT KIT
170°
Replaces: 875787, 3831425



18-3662
THERMOSTAT KIT
145°
Replaces: 875794, 876305



18-3663
THERMOSTAT KIT
130°
Replaces: 875791



18-3664
THERMOSTAT KIT
165°
Replaces: 875795



18-3665
THERMOSTAT KIT
140°
Replaces: 875796



① **18-3666D** Display Package
18-3666
THERMOSTAT KIT
(82°C)
Replaces: 875580
180°



18-3615
THERMOSTAT - RAW WATER
Replaces: 3587597
150°



18-3617
THERMOSTAT KIT



18-3620
THERMOSTAT KIT
180°



18-3621
THERMOSTAT KIT
160°



18-3626
THERMOSTAT KIT
145°



18-3618
THERMOSTAT KIT -
RAW WATER COOLED
150°



18-3619
THERMOSTAT KIT -
FRESH WATER COOLED
150°

THERMOSTAT APPLICATION ON NEXT PAGE

① Items ending in "D" are Display Packaged - Regular number is Non-Display

RAW WATER (OPEN) COOLING SYSTEM - RAW (RIVER, LAKE, SEA) WATER RUNS THROUGH CYLINDER BLOCK								
Model	Version	Identifier	Model Year	Thermostat	Seal	Gasket	Thermostat & Seal Kit	Complete Kit Thermostat Seal Gasket
AQ90			1962-1964	NSS	18-2933		18-3656	
AQ95			1964-1968	NSS	18-2933		18-3656	
AQ100			1961-1963	NSS	18-2933		18-3656	
AQ130	A, B, C, D		1968-1977	NSS	18-2933		18-3656	
AQ115	A, B		1969-1975	NSS	18-2933		18-3656	
AQ140	A		1975-1979	NSS	18-2933	18-7181	18-3666	18-3620
AQ120	B		1977-1980	NSS	18-2933	18-7181	18-3666	18-3620
AQ145	A, B		1979-1985	NSS	18-2933	18-7181	18-3666	18-3620
AQ125	A, B		1981-1985	NSS	18-2933	18-7181	18-3666	18-3620
AQ131	A, B, C, D		1985-1989	NSS	18-2933	18-7181	18-3666	18-3620
230	A, B		1989-1993	NSS	18-2933	18-7181	18-3666	18-3620
AQ151	A, B, C		1985-1989	NSS	18-2933	18-7181	18-3666	18-3620
AQ171	A, C		1986-1989	NSS	18-2933	18-7181	18-3666	18-3620
250	A, B		1986-1993	NSS	18-2933	18-7181	18-3666	18-3620
251	A		1989-1992	NSS	18-2933	18-7181	18-3666	18-3620
3.0 GL, GS		MD,HU,NC	1993-1996	18-3558	18-0929	18-2858		18-3670
3.0 GL, GL, GSP, GLP, GLM		LK,BY,WT,EF	1996-2000	18-3558	NSS	18-0164		18-3621
3.0 GLP, GLM, GSP, GSM	A, B, C, D, E, J		2000-Current	18-3558	NSS	18-0164		18-3621
3.0 GXi, 3.0GXiC	J		2009-Current	18-3557	NSS	18-0164		18-3626
AQ175			1981-1985	18-3551	18-2933	18-0398		18-3662
AQ205	A		1988-1989	18-3551	18-2933	18-0398		18-3662
431	A, B		1989-1991	18-3551	18-2933	18-0398		18-3662
430	A, B		1990-1991	18-3551	18-2933	18-0398		18-3662
432	A		1992-1993	18-3551	18-2933	18-0398		18-3662
434	A		1992-1993	18-3551	18-2933	18-0398		18-3662
4.3 (All Models)		MD,HU,NC,LK, BY,WT,EF	1993-2000	NSS	18-7170	18-2917		18-3677
4.3 (All Models)	A, B		2001-2002	NSS	18-7170	18-2917		18-3677
4.3 (All Models)	C, D, E, F, G, J		2002-Current	NSS	NSS	18-2917	18-3615	18-3618
AQ190	A		1976-1977	18-3551		18-0398		18-3662
AQ200	B,C		1974-1976	18-3551		18-0398		18-3662
AQ225	B, C		1974-1976	18-3551		18-0398		18-3662
AQ200	D, F		1977-1986	18-3551		18-0398		18-3662
AQ225			1977-1986	18-3551	18-2933	18-0398		18-3662
AQ211	A		1986-1989	18-3551	18-2933	18-0398		18-3662
AQ231			1986-1989	18-3551	18-2933	18-0398		18-3662
500			1989-1993	18-3551	18-2933	18-0398		18-3662
501			1989-1993	18-3551	18-2933	18-0398		18-3662
5.0 FiP, FLP		MD,HU,NC	1993-1996	NSS	18-7170	18-2917		18-3677
5.0 GiP, GLP		BY,WT,EF	1997-2000	NSS	18-7170	18-2917		18-3677
5.0 GL, GXi, OSi	A, B		2001-2003	NSS	18-7170	18-2917		18-3677
5.0 (All Models)	C, D, E, F, G, H, J, K		2002-Current	NSS	NSS	18-2917	18-3615	18-3618
AQ271	A, B		1986	18-3551	18-2933	18-0398		18-3662
AQ260	A, B		1979-1985	18-3551	18-2933	18-0398		18-3662
AQ311	A		1986-1987	18-3551	18-2933	18-0398		18-3662
AQ271	C		1986-1989	18-3551	18-2933	18-0398		18-3662
AQ255	A, B		1977-1978			18-0398		
571	A		1989-1992	18-3551	18-2933	18-0398		18-3662
5.7 (All Models)		MD, HU, NC, LK, BY, WT, EF	1993-2000	NSS	18-7170	18-2917		18-3677
5.7 (All Models Except OSi)	A, B, C		2001-2003	NSS	18-7170	18-2917		18-3677
5.7 OSi, OSXi	B, C		2001-2003	NSS	NSS	18-2917	18-3615	18-3618
5.7 (All Models)	D, E, F, G, H, J, K		2002-Current	NSS	NSS	18-2917	18-3615	18-3618
5.8 (All Models)		HU, NC	1993-1996	NSS	18-7170	18-2917		18-3677
740	A, B		1991-1993	18-3551	18-2933	18-0398		18-3662
7.4 (All Models)		MD, HU, NC, LK, BY, WT, EF	1993-2000	NSS	18-7170	18-2917		18-3676
8.1 (All Models)			2000-Current	NSS	18-7170	NSS		18-3617
8.2 (All Models)		MD, HU, NC, LK, BY, WT, EF	1993-2000	NSS	18-7170	18-2917		18-3676
FRESH WATER (CLOSED) COOLING SYSTEM - ENGINE IS EQUIPPED WITH RESEVOIR TO HOLD ANTI-FREEZE								
4.3, 5.0, 5.7 (All Models)			1993 - Current	NSS	18-2933	18-2917	18-3539	18-3619
5.8 (All Models)			1993 - 1996	NSS	18-2933	18-2917	18-3539	18-3619
7.4 (All Models)			1991 - 2000	NSS	18-2933	18-2917	18-3539	18-3619
8.1 (All Models)			2000-Current	NSS	18-2933	18-2917	18-3539	18-3619
8.2 (All Models)			1993 - 2000	NSS	18-2933	18-2917	18-3539	18-3619



**18-1476
CAMSHAFT KIT**

Fits: AQ165A, AQ170A, AQ170B, AQ170C, BB165A, BB170A, BB170B, BB170C



**18-1477
CAMSHAFT KIT**

Fits: B18, B20, AQ60F, AQ90, AQ95, AQ110, AQ120, BB30, BB100, MB18, AQ105, AQ115A, AQ115B, AQ130A, AQ130B, AQ130C, AQ130D, BB115A, BB115B, BB115C, MB20A, MB20B, MB20C



**18-1478
CAMSHAFT**

Replaces: 1218674
Fits: B18, B20, AQ60F, AQ90, AQ95, AQ95A, AQ110, AQ120, BB30, BB100, MB18, AQ105A, AQ115A, AQ115B, AQ130A, AQ130B, AQ130C, AQ130D, BB115A, BB115B, MB20A, MB20B, MB20C



**18-1479
CAMSHAFT**

Replaces: 461511
Fits: B30, AQ165A, AQ170A, AQ170B, AQ170C, BB165A, BB170A, BB170B, BB170C



VALVES

Part #	Type	O.E. #	Application
18-4464	Exhaust	829620	D1, D2, D3, 3AA, D17, AQD2B, MD1B, MD2B, MD3B, MD11C, MD11D, MD17C, MD17D
18-4469	Exhaust	1542389	D40, AD40B, AQAD40A, AQAD40B, AQD40A, MD40A, TAMD40A, TAMD40B, TMD40A, TMD40B, TMD40C
18-4470	Exhaust	419735	B20, B30, AQ105A, AQ115A, AQ115B, AQ130A, AQ130B, AQ130C, AQ130D, BB115A, BB115B, BB115C, MB20A, MB20B, MB20C
18-4471	Exhaust	838638	D31, D32, D41, D42, D43, AD31L-A, AD31P-A, TAMD31L-A, TAMD31M-A, TAMD31P-A, TMD31L-A, KAD32PA, AD41L-A, AD41P-A, D41L-A, TAMD41H-A, TAMD341L-A, TAMD41P-A, TMD41A, TMD41L-A, KAD42A, KAD42P-A, KAMD42A, KAMD42B, KAMD42P-A, TAMD42B, TAMD42WJ-A, KAD43P-A, KAMD43P-A
18-4463	Intake	833188	D1, D2, D3, 3AA, D17, AQD2B, MD1B, MD2B, MD3B, MD11C, MD11D, MD17C, MD17D
18-4466	Intake	838637	D31, D32, D41, D42, D43, AD31L-A, AD31P-A, TAMD31L-A, TAMD31M-A, TAMD31P-A, TMD31L-A, KAD32PA, AD41L-A, AD41P-A, D41L-A, TAMD41H-A, TAMD341L-A, TAMD41P-A, TMD41A, TMD41L-A, KAD42A, KAD42P-A, KAMD42A, KAMD42B, KAMD42P-A, TAMD42B, TAMD42WJ-A, KAD43P-A, KAMD43P-A
18-4467	Intake	1542472	D40, AD40B, AQAD40A, AQAD40B, AQD40A, MD40A, TAMD40A, TAMD40B, TMD40A, TMD40B, TMD40C
18-4468	Intake	419734	B20, B30, AQ105A, AQ115A, AQ115B, AQ130A, AQ130B, AQ130C, AQ130D, BB115A, BB115B, BB115C, MB20A, MB20B, MB20C



**18-4465
VALVE GUIDE**

Replaces: 3582609
for exhaust, 230, 250, AQ115, BB115, MB20, AQ130, AQ165, BB165, AQ170, BB170, AQD21A, MD21A, AQ130B, AQ125A, AQ140A, BB140A, AQ135B, AQ131A, AQ131B, AQ131C, AQ131D, AQ145A, BB145A, AQ145B, AQ151A, AQ151B, AQ151C, MB10



**18-4472
VALVE LIFTER**

Replaces: 1218630
Fits: B18, B20, B30, AQ120, AQ90, AQ95, AQ110, AQ120, BB30, BB100, MB18, AQ105A, AQ115A, AQ115B, AQ130A, AQ130B, AQ130C, AQ130D, BB115A, BB115B, BB115C, MB20A, MB20B, MB20C, AQ165A, AQ170A, AQ170C, BB165A, BB170A, BB170B, BB170C



**18-4473
VALVE GUIDE**

Replaces: 419653, 3582561
Fits: AQ115, BB115, MB20, AQ130, AQ165, AQ170, BB170, AQD21A, MD21A, KAMD42A, KAD42A, KAMD42P, KAD42P, MD11, MD17, MD1B, MD2B, MD3B, MD30, TMD30, TAMD30, AQAD30, MD31A, TMD31B, TAMD40, AQAD40, TAMD42B, KAMD42B, KAD42B, TMD31D, TAMD31D, AD31D, AD31XD, TMD41B, TAMD41B, D41B, TMD41D, TAMD41D, D41D, AD41D



**18-4474
VALVE GUIDE**

Replaces: 419652, 3582606
For Intake: Fits: 230, 250, AQ115, BB115, MB20, AQ130, AQ165, BB165, AQ170, BB170, AQD21A, MD21A, AQ120B, AQ125A, AQ140A, BB140A, AQ125B, AQ131A, AQ131B, AQ131C, AQ131D, AQ145A, BB145A, AQ145B, AQ151A, AQ151B, AQ151C, MB10

TIMING BELTS

Part #	Replaces	Fits
18-4029	463377	4AQ120B, 125A,B, 131A,B,C,D 140, 145, 151A,B,C, 230, 250, 6B140A, 145A,B # Cyl.
18-4030	3135958B, 3125830S	D3-110I-G, D3-140A-G, D3-140I-G, D3-150I-G, D3-170A-G, D3-170I-G, D3-170I-G, D3-200A-G, D3-200I-G, D3-220A-G, D3-220I-G, D3-110I-H, D3-140I-H, D3-150I-H, D3-170I-H, D3-200I-H, D3-220I-H, D3-140A-H, D3-170A-H, D3-200A-H, D3-220A-H, D3-110I-A, D3-110I-B, D3-110I-C, D3-130A-A, D3-130I-A, D3-130A-B, D3-130I-B, D3-130A-C, D3-130I-C, D3-160A-A, D3-160I-A, D3-160A-B, D3-160I-B, D3-160A-C, D3-160I-C, D3-190A-B, D3-190I-B, D3-190A-C, D3-190I-C, D3-190I-A, D3-110I-D, D3-110I-E, D3-110I-F, D3-140I-E, D3-140I-F, D3-140A-D, D3-140A-E, D3-140A-F, D3-150I-D, D3-150I-E, D3-150I-F, D3-170I-D, D3-170I-E, D3-170I-F, D3-170A-D, D3-170A-E, D3-170A-F, D3-200I-D, D3-200I-E, D3-200I-F, D3-200I-A, D3-200A-E, D3-200A-F, D3-220I-D, D3-220I-E, D3-220I-F, D3-220A-D, D3-220A-E, D3-220A-F, D3-140I-D



**18-4044
DRIVE BELT**

Replaces: 834548, 966694-2
Generator: AQ120B, 125A, 140A, 145A, 155, 170A, B, C



**18-4046
DRIVE BELT**

Replaces: 958498, 966857
Generator: AQ175A, 200A, B, C, D, 225A,B, 260A, B, 280A, 290A
Water Pump AQ210
V-6, V-8



**18-8964
POWER STEERING PUMP
PULLEY**
Replaces: 3853804
Fits: Many Volvo sterndrive applications



NEW
**18-7514
POWER STEERING PUMP**
Replaces: 22797780
Fits: Early Production, SN-2004033423
D4-180I-B, D4-210A-A, D4-210A-B,
D4-210I-A, D4-210I-B, D4-225I-B,
D4-260A-A, D4-260A-B, D4-260I-A,
D4-260I-B, D4-300A-A, D4-300I-A
Sierra power steering pumps are built to meet or exceed OEM performance. All pumps are leak and efficiency tested to ensure a quality performance.*



EXPANSION PLUGS

Part #	Pkg.	O.E. #	Size
18-4200 ① ②	5	477024	39MM (1.375")
18-4201 ① ②	5	182212	45MM (1.770")
18-4245 ③	5	463902	42MM (1.655")
18-4246 ③	5	463903-5	35MM (1.375")

① Stainless Steel
② This product is priced per piece. To order priced per package, please add .9 to the part number.



**18-2367
CYLINDER HEAD NUT**
Replaces: 943414
For cylinder head: Fits: D1, D2, D3, D11, D17, MD1B, AOD2B, MD2B, MD11C, MD11D, MD3B, MD17C, MD17D



**18-4005
ENGINE MOUNT**
Replaces: 833950
Fits: D5, D6, D7, D11, D17, MB10, MB10A, MD5A, MD5B, MD5C, MD6A, MD6B, MD7A, MD7B, MD11C, MD11D, MD17C, MD17D



**18-57702
CRANKCASE FILTER**
Replaces: 876069
Fits: Volvo MD30A, TMD30A, TAMD30A, MD31A, TMD31A, TAMD31A, MD40A, TMD40A, TMD40B, TAMD40A, TAMD40B, TMD41A, TAMD41A



**18-2793
SEAL RING KIT**
Replaces: 875550
For cylinder liner: Fits: D11, D17, MD11C, MD11D, MD17C, MD17D; NOTE: Model MD11 requires two
18-2793 and Model MD17 requires three
18-2793



**18-1727
RUBBER CUSHION**
Replaces: 803762
For propeller shaft coupler: Fits: B18, B20, B30, MB10, 2001, 2002, 2003, 2010, 2020, 2030, 2040, D1, D2, D3, D5, D6, D7, D11, D17, D21, D22, D29, D32, B830, BB100, BB115, BB165, BB170, MB10A, MB18, MB20, MD1, MD2, MD3, MD5, MD6, MD7, MD11, MD17, MD21, MD22, MD29, MD32



**18-7907
AIR FILTER**
Replaces: 858488
Fits: D31, D41, D42, AD31A, AD31B, AD31D, AD31L-A, AD31P-A, AD31XD, AQAD31A, MD31A, TAMD31A, TAMD31B, TAMD31D, TAMD31L-A, TAMD31M-A, TAMD31P-A, TMD31A, TMD31B, TMD31D, TMD31L-A, AD41A, AD41B, AD41D, AD41L-A, AD41P-A, AQAD41A, D41A, D41B, D41D, D41L-A, TAMD41A, TAMD41B, TAMD41D, TAMD41H-A, TAMD41L-A, TAMD41M-A, TAMD41P-A, TMD41A, TMD41B, TMD41D, TMD41L-A, TMD41P-A, TAMD42B, TAMD42WJ-A



**18-7908
AIR FILTER**
Replaces: 3582358
Fits: D31, D41, AD31A, AD31B, AD31D, AD31L-A, AD31P-A, AD31XD, AQAD31A, TAMD31A, TAMD31B, TAMD31D, TAMD31L-A, TAMD31M-A, TAMD31P-A, TMD31A, TMD31B, TMD31D, TMD31L-A, AD41D, AD41L-A, AD41P-A, AQAD41A, AQD41A, D41A, D41B, D41D, D41L-A, TAMD41A, TAMD41B, TAMD41D, TAMD41H-A, TAMD41L-A, TAMD41M-A, TAMD41P-A, TMD41A, TMD41B, TMD41D, TMD41L-A



**18-7890
AIR FILTER**
Replaces: 463505, 876185
MD30, MD40, KAD42A, KAMD42A
Diesel



**18-7890
AIR FILTER**
Replaces: 463505, 876185
MD30, MD40, KAD42A, KAMD42A
Diesel



**18-0035
DIESEL OIL FILTER, FULL FLOW**
Replaces: 3582732
Fits: D4-180I-B, D4-180I-C, D4-210A-A, D4-210A-B, D4-210I-A, D4-210I-B, D4-225A-B, D4-225A-C, D4-225I-B, D4-225I-C, D4-260A-A, D4-260A-B, D4-260A-C, D4-260D-B, D4-260D-C, D4-260I-A, D4-260I-B, D4-260I-C, D4-300A-A, D4-300A-C, D4-300D-A, D4-300D-C, D4-300I-A, D4-300I-C, D6-280A-A, D6-280A-B, D6-280I-A, D6-280I-B, D6-310A-A, D6-310A-B, D6-310D-A, D6-310D-B, D6-310I-A, D6-310I-B, D6-330A-B, D6-330A-C, D6-330D-B, D6-330D-C, D6-330I-B, D6-330I-C, D6-350A-A, D6-350A-B, D6-370A-B, D6-370I-B, D6-370D-B, D6-370D-C, D6-370I-A, D6-370I-B, D6-370I-C, D6-435D-A, D6-435D-C, D6-435I-A, D6-435I-C



**18-0036
DIESEL OIL FILTER, BYPASS**
Replaces: 3582733
Fits: D4-180I-B, D4-180I-C, D4-210A-A, D4-210A-B, D4-210I-A, D4-210I-B, D4-225A-B, D4-225A-C, D4-225I-B, D4-225I-C, D4-260A-A, D4-260A-B, D4-260A-C, D4-260D-B, D4-260D-C, D4-260I-A, D4-260I-B, D4-260I-C, D4-300A-A, D4-300A-C, D4-300D-A, D4-300D-C, D4-300I-A, D4-300I-C, D6-280A-A, D6-280A-B, D6-280I-A, D6-280I-B, D6-310A-A, D6-310A-B, D6-310D-A, D6-310D-B, D6-310I-A, D6-310I-B, D6-330A-B, D6-330A-C, D6-330D-B, D6-330D-C, D6-330I-B, D6-330I-C, D6-350A-A, D6-350A-B, D6-370A-B, D6-370I-B, D6-370D-B, D6-370D-C, D6-370I-A, D6-370I-B, D6-370I-C, D6-435D-A, D6-435D-C, D6-435I-A, D6-435I-C



**18-7974
DIESEL OIL FILTER**
Replaces: 3827069
Thread Specs: 18mm x 1.5
Fits: Diesel Models AQD21A-B, AQD32A, MD21A/B, MD32A, TAMD61A, TAMD62A, TAMD63L-A, TAMD63P-A, TAMD71A/B, TAMD72A, TAMD73P-A, TAMD73WJ-A, TAMD74A-A, TAMD74A-B, TAMD74C-A, TAMD74C-B, TAMD74P-B, TAMD75P-A



**18-7974
DIESEL OIL FILTER**
Replaces: 3827069
Thread Specs: 18mm x 1.5
Fits: Diesel Models AQD21A-B, AQD32A, MD21A/B, MD32A, TAMD61A, TAMD62A, TAMD63L-A, TAMD63P-A, TAMD71A/B, TAMD72A, TAMD73P-A, TAMD73WJ-A, TAMD74A-A, TAMD74A-B, TAMD74C-A, TAMD74C-B, TAMD74P-B, TAMD75P-A

OIL FILTERS

SEE PAGES 200-202 & 1167-1190 FOR
ADDITIONAL INFORMATION

OIL FILTERS

Part #	D.E. #	Application
18-9003-1	8692305	---
18-7824-2	835440	Short GM Filter
18-7876-1	3850559	Long GM Filter
18-7878-1	430143, 1266286, 3517857	Short Ford Filter
18-7879-1	841750	V-6 GM

DIESEL OIL FILTER

18-0032	847741	---
18-0033	21707133	---
18-0034	477556	---
18-7880	486634	TAMD100, TMD102, TMD121, TMD122, TAMD122 & TAMD162
18-7884	834337	---
18-7974	3827069	---



New



18-7962 OIL FILTER

Replaces: 3840525

Anti-Drain Back Valve

Engineered with premium grade materials that will excel in the extreme marine environment

Fits: D1-30A, D2-40A, D2-55A, D2-55B, D2-55C, D2-75A

New



18-8701 OIL FILTER

Replaces: 861476

Anti-Drain Back Valve

Engineered with premium grade materials that will excel in the extreme marine environment

Fits: MD22A, L-A, TMD22

New



18-8702 OIL FILTER

Replaces: 30788490

Anti-Drain Back Valve. Epoxy coated for corrosion resistance.

Heavy-wall steel canister for further corrosion protection

Fits: D3-110I-G, D3-140A-G, D3-140I-G, D3-150I-G, D3-170A-G, D3-170I-G, D3-200A-G, D3-200I-G, D3-220A-G, D3-220I-G, D3-110I-H, D3-140I-H, D3-150I-H, D3-170I-H, D3-200I-H, D3-220I-H, D3-140A-H, D3-170A-H, D3-200A-H, D3-220A-H, D3-110I-D, D3-110I-E, D3-110I-F, D3-140I-E, D3-140I-F, D3-140A-D, D3-140A-E, D3-140A-F, D3-150I-D, D3-150I-E, D3-150I-F, D3-170I-D, D3-170I-E, D3-170I-F, D3-170A-D, D3-170A-E, D3-170A-F, D3-200I-D, D3-200I-E, D3-200I-F, D3-200A-D, D3-200A-E, D3-200A-F, D3-220I-D, D3-220I-E, D3-220I-F, D3-220A-D, D3-220A-E, D3-220A-F, D3-140I-D

CYLINDER HEAD ASSEMBLIES

All cylinder heads are new castings and complete assemblies with new - stainless steel valves, hardened steel exhaust seats, valve springs, valve locks, and retainers.

All GM cylinder heads utilize high performance screw-in rocker arm studs in place of factory press in rocker arm studs.



18-4486HP CYLINDER HEAD ASSEMBLY

Fits: Vortec GM small block 5.7L high performance

Completely assembled with revised runner and combustion chambers. Add 30hp to stock motor with no additional modifications.



18-4501HP CYLINDER HEAD

Fits: Vortec GM small block 5.0L

Completely assembled with revised runner and combustion chambers. Add 30hp to stock motor with no additional modifications.



18-1400
HYDRAULIC LIFTER
Replaces: 3856127
GM 4.3L/V-6 Late/5.0L/5.7L



18-1401
HYDRAULIC LIFTER
Replaces: 3853847, 985316
Ford 302/351
Ford 5.0L & 5.8L



18-1402
HYDRAULIC LIFTER
Replaces: 3854033, 502036
GM 2.5L/120
For: Volvo 3.0L/181 CID GM 3.0L, 4.3L, 5.0L & 5.7L

**ALL PISTONS
ARE SUPPLIED COMPLETE WITH PISTON RINGS AND WRIST PIN.**



PISTONS	
STD	OMC / VOLVO #
18-4161	3853340, 914816
18-4173	*14077948
18-4173	3911020
0.02	
18-4160	3853477, 915236
0.03	
18-4164	*14077949, 3911023

* OMC References GM Number

PISTON RINGS	
STD	OMC / VOLVO #
18-3937	*14089025
18-3937	328506
18-3937	3853960
18-3937	914555
18-3937	3853268
18-3937	985083, 986336
18-3944	370409

PISTON RINGS	
0.02	
18-3939	3854252
18-3939	914556
0.03	
18-3938	*14089026
18-3938	328516
18-3938	914557

PISTON / RING APPLICATION

VOLVO		PISTONS			RINGS			Qty.
Model	Serial Number	Std.	.020	.030	Std.	.020	Per .030	Eng.
GM								
2.5L/153 CID		18-4180	18-4183	-	18-3942	-	-	4
3.0L/181 CID		18-4161	18-4160	18-4191	18-3937	18-3939	18-3938	4
4.3L/V-6		18-4173	18-4188	18-4164	18-3937	18-3939	18-3938	6
5.0L/305 CID		-	-	18-4178	18-3944	-	-	8
5.7L/350 CID		18-4173	18-4188	18-4164	18-3937	18-3939	18-3938	8
7.4L/454 CID		18-4171	18-4189	18-4172	-	-	-	8
FORD								
5.0L/302 CID		-	-	-	18-3937	18-3939	18-3938	8



ROD BEARINGS

Part #	Size
18-1308	Std.
18-1309	.010
18-1327	Std.
18-1332	.020
18-1333	.010
18-1334	Std.
18-1337	.010
18-1341	.020

Rod bearings sold individually,
1 per rod.



MAIN BEARINGS

Part #	Per Eng.	Size
18-1311	②	Std.
18-1317	②	Std.

BEARING APPLICATION

Model	ROD BEARING			MAIN BEARING			CAM BEARING
	Std.	.010	.020	Std.	.010	.020	
VOLVO							
GM							
3.0L/181 CID	18-1308	18-1309	18-1341	18-1317	-	-	-
4.3L/V-6	18-1327	18-1337	-	18-1311	-	-	-
5.0L/305 CID	18-1308	18-1309	18-1341	-	-	-	-
5.7L/350 CID	18-1308	18-1309	18-1341	-	-	-	-
7.4L/454 CID	18-1334	18-1333	18-1332	-	-	-	-
FORD							
5.0L/302 CID	-	-	-	-	-	-	-



18-0518
VALVE STEM SEAL
Replaces: 3854956,
914323, 3853132
For: most inline 4 and 6 cyl. GM (Early)
and 305-350 CID GM

PKG. OF 8



18-4024
18-4024-9①
VALVE STEM SEAL
Replaces:
3853226, 914445
For: Chevy 4.3L/5.0L/5.7L



18-4031
VALVE STEM SEAL
Replaces: 1306630
A0120B, 125A, B, 131A, 140A, 145A, B,
151A, B, MD19, 2B, 3B, 5A, 2001, 2002, 2003,
MD59, C, 11C, D, 17C, D, 30, 31, 40, 41



ONE PIECE REAR MAIN SEALS
18-1234
Replaces: 3853528
For: 7.4L, GL, GI, GSI; 8.2L, GL
18-0519
Replaces: 3852657, 912957
4.3L/3.0L/5.0L 5.7L



TWO PIECE REAR MAIN SEALS
18-0528 **18-1211**
Replaces:
3852805



TIMING COVER SEALS
18-1213 **18-1230**
Replaces:
3853341 Replaces:
3853827

VOLVO SEAL APPLICATION

Engine Model	2 Piece Rear Main Crankshaft Seal Conv. Rotation (LH)	Timing Cover Seal
GM		
3.0L/181 CID	18-1211 ②	18-1213
4.3L/V-6	18-1211 ②	18-1213
5.0L/305 CID	18-1211 ③	18-1213
5.7L/350 CID	18-1211 ③	18-1213
7.4L/454 CID	③	18-1233
FORD		
5.0L/302 CID	18-0528	18-1230
5.8L/351 CID	—	18-1230

① Large Journal Crankshaft GM Engine ② For one piece seal (LH) models use 18-0519 ③ For one piece seal (LH) models use 18-1234

FOR MODULAR GASKET SETS SEE PAGES 671-678



**18-0252
CONVERSION GASKET SET**
Replaces: 876314
Fits: D6, D7, MD6A, MD6B, MD7A, MD7B



**18-0489
CONVERSION GASKET SET**
Replaces: 876384
Fits: D11, MD11C, MD11D

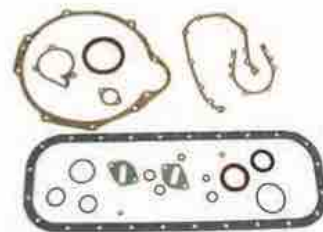

**18-2814
SHORT BLOCK GASKET SET**
Replaces: 876306
(6 CYL.)

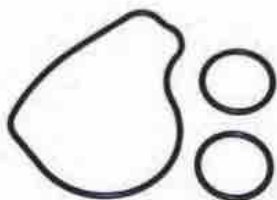

**18-2699
OUTDRIVE
GASKET**
For: SX and DP-SM Drives thru 2006
— CONTAINS —

Part #	Description	O.E. #	Qty.
18-7153	O-Ring	911851	2
18-2996	Outdrive Seal	911823	1



**18-2596
HEAD GASKET SET**
Replaces: 875422
Fits: D1, D2, D1A, MD1A, D2A, MD2, MD2A:
NOTE: Model MD2A requires two 18-2596

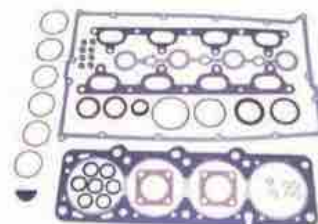

**18-3670
HEAD GASKET SET**
Replaces: 876303
Fits: B25, 251A, AQ171A, AQ171C



**18-4341
HEAD GASKET SET**
Replaces: 876380
Fits: D17, MD17C, MD17D



**18-4342
HEAD SET**
Replaces: 876376
Fits: D11, MD11C, MD11D



**18-2813
HEAD GASKET SET**
Replaces: 876302
(4 CYL.)

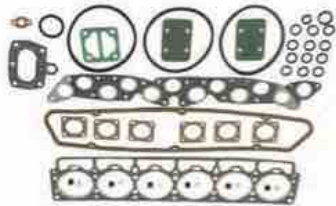

18-2817
HEAD GASKET SET
Replaces: 876359
(6 CYL.)



18-2818
OIL PAN GASKET SET
Replaces: 876433
(4 CYL.)



18-2980
HEAD GASKET SET
Replaces: 875401 (Old), 876356
(4 CYL.)



18-2982
HEAD GASKET SET
Replaces: 875569 (Old), 876358
(4 CYL.)



18-2983
SHORT BLOCK GASKET SET
Replaces: 875400 (Old), 876342
(4 CYL.)



18-2998
HEAD GASKET SET
Replaces: 876300
(4 CYL.)



18-0410
INTAKE MANIFOLD GASKET SET
Replaces: 3853912, 3853913, 3854406
For: Volvo 5.0L FL, FI, 5.8L FL, FI, FSI



18-0868
INTAKE MANIFOLD GASKET SET
Replaces: 3854269

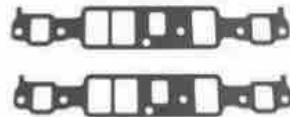

18-1238
INTAKE GASKET SET
Replaces: 3850379, 912979
For: Volvo 4.3GL/GS 1994-96, 4.3Gi 1995-97



18-0498
HEAD GASKET
Replaces: 3580309
Fits: MD2030A, MD2030B



18-2946
HEAD GASKET
Replaces: 3853336, 908611
Fits: GM 181 (3.0L) CID Eng.



18-2965
HEAD GASKET
Replaces: 419310, 419763-8
(4 CYL.)



18-2966
HEAD GASKET
Replaces: 462623
(4 CYL.)



18-2968
HEAD GASKET
Replaces: 1378645
(4 CYL.)



18-2970
HEAD GASKET
Replaces: 1378646
(4 CYL.)

		
<p>18-3834 HEAD GASKET Replaces: 833453</p>	<p>18-3842 HEAD GASKET Replaces: 833274 Fits:D1,D2, MD1A, MD2A</p>	<p>18-3867 HEAD GASKET Replaces: 859647 Fits:MD22A, MD22L-A, MD22L-B, MD22P-B, TAMMD22P-B, TMD22A, TMD22B</p>



	
<p>18-3868 HEAD GASKET Replaces: 3583786 Fits:D41, D42, D43, D44, AD41A, AD41B, AD41D, AD41L-A, AD41P-A, AQAD41A, D41A, D41B, D41D, D41L-A, TAMMD41A, TAMMD41B, TAMMD41D, TAMMD41H-A, TAMMD41L-A, TAMMD41M-A, TAMMD41P-A, TMD41A, TMD41B, TMD41D, TMD41LA, KAD42A, KAD42B, KAD42P-A, KAMD42A, KAMD42B, KAMD42P-A, TAMMD42B, TAMMD42WJ-A, KAD43P-A, KAMD43P-A, KAD44P-A, KAD44P-B, KAD44P-C, KAMD44P-A, KAMD44P-B, KAMD44P-C</p>	<p>18-3869 HEAD GASKET Replaces: 3584202 Fits:MD2040A, MD2040B</p>

		
<p>18-3876 HEAD GASKET Replaces: 841207-4, 856474-2 Fits: GM 305 (5.0L)/350 (5.7L) CID Eng.</p>	<p>18-3879 HEAD GASKET Replaces: 3854299, 912227, 914930 Fits: GM 262 (4.3L) CID Eng.</p>	<p>18-3883 HEAD GASKET Replaces: 3853732 Fits: Ford 302 (5.0L) 351 (5.8L) CID Eng.</p>

	<p>18-3887 HEAD GASKET Replaces: 3853511 For: Volvo 7.4L</p>
--	--



















HEAD GASKET SET/GASKET SET/HEAD GASKET APPLICATION

Model	Head Gasket Set	Gasket Set	Head Gasket	Model	Head Gasket Set	Gasket Set	Head Gasket	Model	Head Gasket Set	Gasket Set	Head Gasket
AQ60	—	18-2983	—	AQ140A	18-2998	18-2818	18-2968	BB115C	—	—	18-2966
AQ90	—	18-2983	—	AQ145A	—	18-2818	18-2970	BB140A	18-2998	18-2818	18-2968
AQ95	—	18-2983	—	AQ145B	18-2813	—	18-2970	BB145A	18-2999	18-2818	—
AQ100	—	18-2983	—	AQ151A,B,C	18-2813	—	18-2970	BB165	—	18-2814	—
AQ105	—	18-2983	—	AQ165	—	18-2814	—	BB170C	18-2817	18-2814	18-2811
AQ110	—	18-2983	—	AQ170A	—	18-2814	—	BB30	—	18-2983	—
AQ115	—	18-2983	—	AQ170B	—	18-2814	—	MB18	—	18-2983	—
AQ115A	18-2980	—	18-2965	AQ170C	18-2817	18-2814	18-2811	MB20	—	18-2983	—
AQ115B,C	—	18-2982	18-2966	AQD2B	18-2985	—	18-3833	MB20A	18-2981	—	—
AQ120A	—	18-2983	—	B20 (0.8MM)	—	—	18-2965	MB20B	18-2980	—	18-2965
AQ120B	18-2998	18-2818	18-2968	B20 (1.2MM)	—	—	18-2966	MB20C	18-2982	—	18-2966
AQ125A	18-2998	18-2818	18-2968	B21	—	—	18-2968	MD11C,D	—	—	18-3834
AQ125B	18-2813	—	18-2970	B23	—	—	18-2970	MD17C,D	—	—	18-3834
AQ130	—	18-2983	—	B30 (0.8MM)	—	—	—	MD1B	—	—	—
AQ130A	18-2980	—	18-2965	B30 (1.2MM)	—	—	18-2811	MD2B	18-2985	—	—
AQ130B	—	—	—	BB30	—	18-2983	—	MD3B	—	—	—
AQ130C	18-2980	—	18-2965	BB100	—	18-2983	—	230A,B	18-2813	—	—
AQ130D	18-2982	—	18-2966	BB115A,B	—	—	—	250A,B	18-2813	—	—
AQ131A,B,C,D	18-2813	—	18-2970								

<p>PKG. OF 2</p>  <p>18-0876 18-0876-9① FUEL PUMP GASKET For GM 4.3L, 5.0L & 5.7L Replaces: 3852113</p>	<p>PKG. OF 2</p>  <p>18-0889 18-0889-9① FUEL PUMP GASKET For GM 4.3L, 5.0L & 5.7L Replaces: 3852095</p>	<p>PKG. OF 2</p>  <p>18-2989 18-2989-9① CARB MOUNTING GASKET Replaces: 824677 AQ115, 125A, B, 130C, D, 131A, 145A, B, 151A, B, 170, 171A</p>	<p>PKG. OF 2</p>  <p>18-0398 18-0398-9① THERMOSTAT GASKET Replaces: 835417</p>
<p>PKG. OF 2</p>  <p>18-2933 THERMOSTAT GASKET Replaces: 416033, 1317466 Used with most Volvo thermostats (Except AQ175, V-8, MD1A)</p>	<p>PKG. OF 2</p>  <p>18-2858 18-2858-9① THERMOSTAT HOUSING COVER GASKET Replaces: 3852127 For: 3.0L GS, GL, GLM, GLP, GSM, GSP</p>	<p>PKG. OF 2</p>  <p>18-0164 18-0164-9① THERMOSTAT HOUSING GASKET Replaces: 3852096 For: 3.0L GS, GL</p>	<p>PKG. OF 2</p>  <p>18-0929 18-0929-9① THERMOSTAT GASKET Replaces: 3852120 For: 3.0L GS, GL</p>
 <p>18-0183-1 EXHAUST MANIFOLD GASKET Replaces: 3853742, 3852455</p>	 <p>18-2971-1 EXHAUST MANIFOLD GASKET Replaces: 856039, 835908 AQ200, 225, 260, 271, 290, 311</p>	 <p>18-2925 EXHAUST MANIFOLD GASKET Replaces: 461092 (Old), 1378913 AQ165, 170B, BB165, 170 6 Cyl.</p>	
 <p>18-2815 PUSH ROD COVER GASKET Replaces: 3852692 For: 3.0L</p>	 <p>18-1231 INTAKE GASKET Replaces: 3854095 For: Volvo 7.4L GL, GI, GSI, 8.2L GL</p>	<p>PKG. OF 2</p>  <p>18-2995 18-2995-9① HEAT EXCHANGE GASKET Replaces: 856037 AQ120B, 125A, B, 140A, 145A, B</p>	 <p>18-2928 EXHAUST MANIFOLD GASKET Replaces: 824633, 856044 AQ105, 115, 130, BB115, MB20 4 Cyl.</p>
 <p>18-2930 EXHAUST MANIFOLD GASKET Replaces: 1266796 (Old), 1378879 AQ125A, B, 145A, B, 131A, 151A, B, 120B, 140A</p>	<p>PKG. OF 2</p>  <p>18-2949 18-2949-9① EXHAUST MANIFOLD GASKET Replaces: 835966, 856034 AQ200, 225, 260, 271, 290, 311 V-8</p>	<p>PKG. OF 4</p>  <p>18-2991-1 18-2991-1-9① EXHAUST MANIFOLD GASKET Replaces: 855967, 855383 AQ120B, 125A, B, 131, 140, 145, 151, B21, B23</p>	<p>PKG. OF 2</p>  <p>18-2974 DISTRIBUTOR GASKET Replaces: 418265 AQ90, 95, 100, 105, 110, 115, 120, 130, 165, 170, MB18, 20, BB30, 100</p>

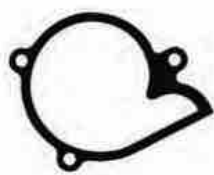
SEE PAGE 219 FOR OUR COMPLETE LINE OF GASKET SEALANTS

① Priced per Package

 <p>18-0311 VALVE COVER GASKET Replaces: 3854942 For: 4.3 Litre 262 CID</p>	 <p>18-0347 VALVE COVER GASKET Replaces: 3852693 For: GM 153 & 181 CID (2.5L & 3.0L)</p>	 <p>18-0352 VALVE COVER GASKET Replaces: 3852818 For: Ford 302/351 CID (5.0L & 5.8L)</p>	 <p>18-0664 VALVE COVER GASKET Replaces: 3852687 For: GM 305/350, 5.0 & 5.7L</p>
 <p>18-2923 VALVE COVER GASKET Replaces: 419678 AQ105, 115, 120, 130, BB115, MB20 4 Cyl.</p>	 <p>18-2924 VALVE COVER GASKET Replaces: 430039 AQ165, 170, BB165, 170 6 Cyl.</p>	 <p>18-2927 VALVE COVER GASKET Replaces: 463999 (Old), 1378909 AQ120B, 125A, 140A, 145A, BB140, 145A 4Cyl.</p>	 <p>18-2972 VALVE COVER GASKET Replaces: 1378870 AQ125B, 145B, 131A, 151A, B</p>
 <p>18-2926 OIL PAN GASKET Replaces: 463587 (Old), 1378864 AQ90, 95, 100, 105, 110, 115, 120, 120B, 125A, B, 130, 131A, 140A, 145A, B, 151A, B, 171A</p>	 <p>18-0307 OIL PAN GASKET Replaces: 861250 Fits: D30, D31, D32, AD300A, AQAD30A, MD30A, TAMD30A, TMD30A, AD31A, AD31B, AD31D, AD31L-A, AD31P-A, AD31XD, AQAD31A, MD31A, TAMD31A, TAM- D31B, TAMD31D, TAMD31L-A, TAMD31M-A, TAMD31P-A, TMD31A, TMD31B, TMD31D, TMD31L-A, KAD32P-A</p>	 <p>18-0310 OIL PAN GASKET Replaces: 861251 Fits: D40, D41, D42, D43, D44, D300, AD40A, AQAD40A, AQAD40B, AQD40A, MD40A, TAMD40A, TAMD40B, TMD40A, TMD40B, TMD40C, AD41A, AD41B, AD41D, AD41L-A, AD41P-A, AQAD41A, D41A, D41B, D41D, D41L-A, TAMD41A, TAMD41B, TAMD41D, TAMD41H- A, TAMD41L-A, TAMD41M-A, TAMD41P-A, TMD41A, TMD41B, TMD41D, TMD41L-A, KAD42A, KAD42B, KAD42P-A, KAMD42A, KAMD42B, KAMD42P-A, TAM- D42B, TAMD42WJ-A, KAD43P-A, KAMD43P-A, KAD44P- A, KAD44P-B, KAD44P-C, KAMD44P-C, KAMD44P-B, KAMD44P-C, KAD300, KAMD300A</p>	
 <p>18-1237 OIL PAN GASKET Replaces: 3856138 For: GM 5.7L</p>	 <p>18-1239 OIL PAN GASKET Replaces: 3853343 For: Volvo 3.0L</p>	 <p>18-0405 OIL PAN GASKET Replaces: 3852655 For: Volvo 4.3L</p>	 <p>18-1232 OIL PAN GASKET Replaces: 3853510 For: Volvo 7.4L GL, GI, GSI, 8.2L GL</p>
 <p>18-2518 CIRCULATION PUMP GASKET Replaces: 430017 For: Volvo AQ185A, 170A, B, C</p>	<p>PKG. OF 2</p>  <p>18-0903 18-0903-9① WATER PUMP GASKET Replaces: 3853361 454 CID</p>	 <p>18-0327 WATER PUMP GASKET Replaces: 3853342 4 & 6 Cyl.</p>	<p>PKG. OF 2</p>  <p>18-0891 18-0891-9① WATER PUMP MOUNTING GASKET Replaces: 3852477 For: GM 4.3L, 5.0L & 5.8L</p>

<p>PKG. OF 2</p>  <p>18-0893 18-0893-9① WATER PUMP BACK-IN PLATE GASKET Replaces: 3850595 GM 4.3L, 5.0L & 5.7L</p>	<p>18-0147 WATER PUMP GASKET For Ford V-8 Replaces: 3852824</p> 	<p>PKG. OF 2</p>  <p>18-2979-9① WATER PUMP GASKET Replaces: 1378906 AQ120B, 125A, 140A, 145A</p>	 <p>18-0468 TIMING COVER GASKET Replaces: 3852654, 3853512 GM 4.3L, 5.0L & 5.7L</p>
<p>PKG. OF 2</p>  <p>18-0887 18-0887-9① TIMING COVER GASKET Replaces: 3852691 4 & 6 Cyl.</p>	 <p>18-2531 CLAMP RING Replaces: 834476 Fits: AQ120B, 125A, B, 140A, 145A, B</p>	 <p>18-25250 SEALING RING Replaces: 3863085 Fits: Volvo SX-ADPS-A (2007 & Up)</p>	 <p>18-25251 SEALING RING Replaces: 853868 Fits: Volvo SX Thru 2006</p>
<p>PKG. OF 2</p>  <p>18-2519 18-2519-9① SEAL RING Replaces: 831622 For cooling water pipe 120B, 125A, B, 131A, 140A, 145A, B, 151A, B, 171A</p>	 <p>18-2525 18-2525-9① SEAL RING Replaces: 430018 Circulation pump to cylinder head AQ165A, 170A, B, C</p>	 <p>18-2526 SEAL RING Replaces: 430172 Circulation pump to cylinder head AQ165A, 170A, B, C</p>	 <p>18-2527 18-2527-9① SEAL RING Replaces: 831617 For cooling water pipe AQ165A, 170A, B, C, MD21A (S/N MD-103387 & UP), MD21B</p>
<p>PKG. OF 5</p>  <p>18-2528 SUPPORT RING Replaces: 831891 AQ120B, 125A, B, 140A, 145A, B</p>	 <p>18-2529 SEAL RING Replaces: 831892 AQ120B, 125A, B, 140A, 145A, B</p>	 <p>18-4259 WASHER Replaces: 804261</p>	 <p>18-2530 18-2530-9① SEAL RING Replaces: 1336255, 3547991 Circulation pump to cylinder head AQ120B, 125A, B, 131A, 140A, 145A, B, 151A, B, 171A</p>
<p>PKG. OF 2</p>  <p>18-2934 18-2934-9① RUBBER SEAL Replaces: 829714 AQ90, 95, 100, 105, 110, 115, 120, 130, MD5A, B, C, 7A, B, 11D, MD2001, 2002, 2003T</p>	 <p>18-2935 18-2935-9① RUBBER SEAL Replaces: 418411 AQ90, 95, 100, 105, 110, 115, 120, 130, MB18, 20, BB30, 100, MD11C, D, 17C, D, MD2001, 2002, 2003, 2003T</p>	<p>PKG. OF 2</p>  <p>18-2936 18-2936-9① RUBBER SEAL Replaces: 418445 AQ90, 95, 100, 105, 110, 115, 120, 130, MB18, 20, BB30, 100, MD11C, D, 17C, D, 2001, 2002, 2003, 2003T</p>	<p>PKG. OF 2</p>  <p>18-2937 18-2937-9① RUBBER SEAL Replaces: 418412 AQ90, 95, 100, 110, 120B, 125A, B, 131A, 140A, 145A, B, 151A, B, 165A, 170, 171A, MD21A, B</p>

① Priced per Package

<p>PKG. OF 5</p>  <p>18-2996 18-2996-9① OUTDRIVE SEAL Replaces: 3852560 3.0L GL, GS, 4.3L GL, GS, GI, 5.0L FL, FI, 5.7L GL, GI, 5.8L FL, FI, FSI</p>	<p>PKG. OF 2</p>  <p>18-0322 18-0322-9① REAR SEAL GASKET Replaces: 3852656 GM 5.0L & 5.7L</p>	
<p>PKG. OF 2</p>  <p>18-2929 18-2929-9① COVER PLATE GASKET Replaces: 856028 AQ105, 115, 130, BB115, MB20</p>	<p>PKG. OF 2</p>  <p>18-2939 18-2939-9① RUBBER SEAL Replaces: 814356 AQ200, 250, 270, 275, 280, 290</p>	<p>PKG. OF 2</p>  <p>18-0874 18-0874-9① DISTRIBUTOR GASKET For GM V6 & V8 Replaces: 3852109</p>
<p>PKG. OF 2</p>  <p>18-0943-2 18-0943-2-9① EXHAUST ELBOW GASKET Replaces: 3850496 Late Model Volvo Applications</p>	<p>PKG. OF 2</p>  <p>18-2990 18-2990-9① UPPER GEAR HOUSING GASKET Replaces: 832669 AQ270, 275, 280, 290</p>	 <p>18-2199 SHORT YOKE SPACER Replaces: 832675 AQ270, 275, 280, 290</p>
 <p>18-2945 18-2945-1-9① (PKG. OF 50) DRAIN SCREW GASKET For: use with 18-2944 drain screw</p>	 <p>18-2432 POWER TRIM HOSE Replaces: 873228 For: DP, DPX</p>	 <p>18-2433 POWER TRIM HOSE Replaces: 873229 For: DP, DPX</p>
 <p>18-21751 ENGINE COUPLER Replaces: 3853962-3 Fits: 2.5L (1988), 3.0L (1986-90), 4.3L, 5.0L, 5.7L (1986) KW & KWB suffix only, 7.4L (1990-98), 8.2L (1992-93, 1998)</p>	 <p>18-21752-1 ENGINE COUPLER Replaces: 3858437-1 Fits: 4.3L (1986-Current), 5.0L (1986-88, 1998-Current), 5.7 (1986-92, 1994, 1995-Current)</p>	 <p>18-21753 ENGINE COUPLER Replaces: 985727, 3853862-5 Fits: Ford Engines 5.0L & 5.8L (1989-96)</p>

① Priced per Package



18-9096
TRAILERING CLIP
 Volvo 3B47547
 Fits: Volvo SX-A, DPS-A (2007-Up)



18-9098
TRAILERING CLIPS
 Replaces: 174448
 Set of 2
 For all SX Models thru 2006

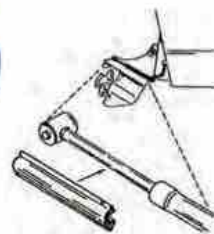

Display Package



STAINLESS STEEL CLAMPS

Part #	Sizes	O.E. #
18-7300 ① ②	50MM	—
18-7306 ① ②	38MM	853548
118-710-48-2	—	3852604
18-710-64-2	122MM	853012

18-2772-1
TRANSOM SEAL KIT

For: SX Drives



— CONTAINS —

Part #	Description	O.E. #	Qty.
18-2100	Gimbal Bearing	3853807	1
18-2765	Bellows	3854127	1
18-1074	Bellows	3850426-2	1
18-2996	Seal	3852560, 911823	1
18-710-64-2	Hose Clamp	853012-3	1



18-2744
DRIVE BELLOWS KIT

Replaces: 875826, 876294
 (with ridge)
 AQ200, 250, 270, 270T, 275, 280, 280T,
 PT, 290 DP UNIT: 280, 290



18-2755
DRIVE BELLOWS KIT
 Replaces: 875827
 SAIL DRIVE: 100S, AQ DRIVE: 100, 100B



18-2757
EXHAUST BELLOWS KIT
 with flapper valve
 Replaces: 875828, 876633
 AQ175, 280, 280DP, T, PT, AOD40,
 AQAD40, V-8



18-2758
EXHAUST BELLOWS KIT
 Replaces: 875848, 876631
 AQ200, 250, 270, 275, 280, 280DP,
 290, 290DP



18-1074
EXHAUST BELLOWS
 Replaces: 3850426
 For: SX Drives includes 302, 432,
 434, 502, 572, 584, 744 (1994-98)
 Uses 18-710-48-2 Clamp



18-2765
U-JOINT BELLOWS
 Replaces: 3854127
 For: DP-S, SX



18-2766
EXHAUST HOSE
 Replaces: 834751
 (I.D. 95MM, LENGTH 160 MM)
 V-8

① This product is priced per piece. To order priced per package, please add -9 to the part number.
 ② Priced per Package



**18-6523
SPRING SET**
For reverse tilt lock: Fits: AQ250, 270, 275, 275A, 280, 280DP, 280L, 285A, 290, 290A, 290DP, SP-A, SP-A/MT, SP-A1, SP-A2, DP-A, DP-A1, DP-A2, DP-B, DP-B1



**18-0184
RUBBER RING**
Replaces: 804190
For clamp ring: Fits: 230A/SP-A/MT, 250A/SP-A/MT, 500A, 501A, 571A, 740A, AQ100, AQ105, AQ110, AQ115A, AQ110B, AQ120A, AQ120B, AQ125A/B, AQ130A/B, AQ131A/D, AQ175A, AQ190A, AQ200A/C/D/F, AQ210A, AQ211A, AQ225A/B/C/D/E/F, AQ231A/B, AQ240A, AQ255A/B, AQ260A/B, AQ271A/B/C/D, AQ280A, AQ290A, AQ311A/B, AQ60F, AQ80, AQ85, AQ95, AQD19, AQD29A, AQD32A



**18-8368
RUBBER RING**
Replaces: 813967
For clamp ring: 230A/SP-A/SP, A1, 230B, 250A/B, 251A, 430A/B, 431A/B, 432A, 434A, 500B, 501B, 570A, 572A, 740B, AD31A/B/D/XD, AD40B, AD41A/B/D, AQ100, AQ105, AQ110, AQ115A/B, AQ130A/B, AQ131B/C, AQ140A, AQ145A/B, AQ151A/B/C, AQ171A/C, AQ205A, AQ60F, AQ90, AQ95, AQAD30A, AQAD31A, AQAD40A/B, AQAD41A, AQD19, AQD21A/B, AQD40A, D41A/B/D, KAD32, KAD42A/B/P, KAD43P, KAD44P, KAMD42A, TAMD41A



**HEAVY DUTY U-JOINTS
(Rockwell Style)**

Part #	O.E. #	Application
18-2104	897707, 853255	AQ200, 250, 270, 280, 290
18-2174	3850812	3.0L GS, GL, 4.3L GL, GS, GI, 5.0L GL, GI, 5.7L GL, GI, 5.8L FL, FI, FSI



**18-6406
U-JOINT**
Replaces: 3860232
GKN new style with external clips.



**18-2100
LINK BELT
GIMBAL BEARING**
Replaces: 3853807
Fits: OMC/Volvo- 3.0L, 4.3L, 5.0L, 5.7L, 7.4L (1994-1998), 5.8L (1994-1996), 8.2L (1998)



**18-2146
UNIVERSAL U-JOINT
ASSEMBLY**
Replaces: 3850815



**18-2339
U-JOINT ASSEMBLY**
Replaces: 3852384



**18-2337
YOKE**
Replaces: 3850814
Fits: 3.0L GS, GL, 4.3L GS, GL, GI, 5.0L FL, FI, 5.7L GL, GI, 5.8L FL, FI, FSI



**18-2128
CENTER SOCKET**
Replaces: 3850813, 912213

Drive Model	U-joint Assy. #	O.E. U-joint Assy. #	Long Yoke #	O.E. Long Yoke #	Short Yoke #	O.E.Short Yoke #	Double Yoke #	O.E. Double Yoke #
SX, DP-SM	18-2339	3852384	18-2146	3850815	18-2337	3850814	18-2128	3850813



**18-4204
PLASTIC BUSHING**
Replaces: 826341, 876278
AQ200, 250, 270, 275, 280, 280DP, 290DP,
NOT FOR 270T, 280T, AND 290



**18-2366
LOWER
GEARCASE SEAL**
Replaces: 876279
290, 290A, 290DP, SP-A, SP-A1 & SP-A2



**18-4205
PLASTIC BUSHING**
Replaces: 832820
A270T, 280T



**18-4206
STERNDRIVE COVER**
Replaces: 832570
AQ200, 250, 270, 275, 280, 290



**FISH LINE
PROTECTOR SPACER**

Part #	O.E. #	Application
18-4208	839423	AQ280, 290
18-4209	839534	AQ250, 270, 275
18-4234	832965	AQ110S, 200



**18-4210
PROP CONE**
Replaces: 850785, 854045
AQ200, 250, 270, 270T, 275, 280, 280T, 280PT, 290



**18-4211
PLASTIC WASHER**
Replaces: 850888



**18-3730
LOCK NUT**
Replaces: 3852648-9
For: SX Drives



**18-4212
PROP CONE SCREW**
Replaces: 850889
(5/16" - 18 thread)



**18-4213
SPACER**
Replaces: 851261,
854047
AQ275, 280, 290



**18-4214
LOCKING WASHER**
Replaces: 897367
AQ Drive Units: 200, 250,
270, 270T (TID UTF) 275, 280,
280T, 280PT (TID UTF)



**18-4215
COVER SCREW**
Replaces: 941816
(1/4" — 20)



**18-2153
SETTING PIVOT PIN**
Replaces: 814301
AQ200, 250, 270, 275, 280



**18-2454
DRAIN PLUG**
3/8" - 16 thread
Replaces: 3854539
For: Volvo SX drives
Use o-ring 18-7145



**18-3733
PROP NUT KIT**

For: SX Cobra

— Contains —

Part #	Description	Qty.
18-4194	Spacer	1
18-3708-1	Nut & Keeper	1
18-3741	Cotter Pin	1

Ⓜ18-3733D



**18-4194
PROP SPACER**
Replaces: 3852350
For: Lower gearcase models SX-M (1994)



**18-3708-1
PROP NUT & KEEPER**
Replaces: 3850984



**18-3744
18-3744-9[Ⓜ]
COTTER PIN**
Replaces: 3852255
For: XDP, MDSSL, MD22P, TMD22,
TMD22P, TAMD22P, P,JX, SX, DPS,
DP, 3.0L GS, GL, 4.3L GL, GS, GI,
5.0L FL, FI, 5.7L GL, GI, 5.8L FL, FI, FSI



**18-3745
18-3745-9[Ⓜ]
COTTER PIN**
Replaces: 17253-6



**18-4238
18-4238-9[Ⓜ]
LOCK CATCH SCREW**
For Stern Drive Cover 18-4206
Replaces: 943218
AQ200, 250, 270, 275, 280, 290



**18-4239
LOCK CATCH**
For Stern Drive Cover 18-4206
Replaces: 897873
AQ200, 250, 270, 275, 280, 290



**18-4241
ROLL PIN**
Replaces: 951924
AQ200, 250, 270, 275, 280, 290



**18-1501
DETENT BALL**
Replaces: 3852023
For: 3.0L GS, GL, 4.3L GL, GS, GI,
5.0L FL, FI, 5.7L GL, GI, 5.8L FL, FI, FSI



**18-3722
18-3722-9[Ⓜ]
STAINLESS STEEL LOCKNUT**
Replaces: 3852005
For: P,JX, SX, DPS, DP, DPX, 3.0L GL, GS,
4.3L GL, GS, GI, 5.0L FL, FI, 5.7L GL, GI,
5.8L FL, FI, FSI, 7.4L GL, GI, GSI, 8.2L GL



**18-0549
PLUG OFF CAP
1"**
Replaces: 3852476
For: 4.3L GL, GS, GI, GSI, 5.0L FL, FI, 5.7L GL,
GI, 5.8L FL, FI, FSI, 7.4L GL, GI, GSI, 8.3L GI,
GSI, GXI, 8.2L GL, GSI



**18-2138
PIVOT PIN BEARING**
Replaces: 3852544
For: 3.0L GS, GL, 4.3L GL, GS, GI,
5.0L FL, FI, 5.7L GL, GI, 5.8L FL, FI, FSI

Ⓜ Priced per Package

Ⓜ Items ending in "D" are Display Packaged - Regular number is Non-Display

Zinc is for saltwater only applications.
 Magnesium is for fresh water only applications.
 Aluminum is for brackish water, or if boat is used in both fresh and salt environments.



③ 18-6123Z
ANODE
 Replaces: 873395
 Transom Shield



③ 18-6124Z
ANODE
 Replaces: 872793
 DPS Steering Arm



① 18-6125A
 ② 18-6125M
 ③ 18-6125Z
TRANSOM PLATE
 Replaces:
 3586461 (Aluminum)
 3855610 (Magnesium)
 3854130 (Zinc)



① 18-6126A
 ② 18-6126M
 ③ 18-6126Z
TRANSOM ANODE
 (with bolt)
 Replaces:
 3888816 (Aluminum)
 3888818 (Magnesium)
 3888817 (Zinc)
 SX-A, DPS-A, DPS-A Oxi



① 18-6127A
 ② 18-6127M
 ③ 18-6127Z
TRANSOM ANODE
 (with bolt)
 Replaces:
 3888813 (Aluminum)
 3888815 (Magnesium)
 3888814 (Zinc)
 SX-A, DPS-A, DPS-A Oxi



③ 18-6000
 ① 18-6000A
 ② 18-6104
ANODE
 Replaces: 832598,
 873179
 For 200, 250, 250C, 250D, 270,
 270B, 270C, 270D, 275, 280,
 280C, 280D, 280DP, 280L, 280PT



③ 18-6001
ANODE
 Replaces: 838929
 AQ200 (For shield), MD19, 21,
 27, 29, 32, 2003, AQ30, 31, 40, 41
 For Fresh Water Cooler



③ 18-6004
 ① 18-6004A
 ② 18-6105
ANODE
 Replaces: 852835,
 873178
 For 290, 290A, 290ADP, 290B



③ 18-6005
ANODE
 Replaces: 875805
 AQ250, 270, 270T, 275



③ 18-6009
 ① 18-6009A
ANODE
 Replaces: 875815



③ 18-6028
 ① 18-6028A
 ② 18-6102
ANODE
 Replaces: 3855411, 984513
 (18-6028), 3863193 (18-6028A),
 3855412 (18-6102)
 For use on Gearcases: 2.3L (1987-90), 2.6L/
 3.5L/4.6L (1989), 3.0L/4.3L/5.0L/5.8L (1987-
 93), 5.7L (1987-92), 7.4L (1987-88)



③ 18-6010
 ① 18-6010A
 ② 18-6106
ANODE
 Replaces: 875821
 280DP, 290DP



18-6130
ANODE
Replaces: Volvo
Fits: Volvo IPS Drives



18-6131
ANODE
Replaces: Volvo
Fits: Volvo IPS Drives



18-6128A
ANODE KIT
Replaces: Volvo
Fits: Volvo SX-A & DPS Drives



18-6128M
ANODE KIT
Replaces: Volvo
Fits: Volvo SX-A & DPS Drives



18-6128Z
ANODE KIT
Replaces: Volvo
Fits: Volvo SX-A & DPS Drives



18-6129A
ANODE KIT
Replaces: Volvo
Fits: Volvo DPH Drives



18-6129M
ANODE KIT
Replaces: Volvo
Fits: Volvo DPH Drives



18-6129Z
ANODE KIT
Replaces: Volvo
Fits: Volvo DPH Drives



18-1076
BELLOWS
Replaces: Volvo 3888916
Fits: Volvo SX-A & DPS-A Drives



18-6021
ANODE PLUG
Replaces: 838928
AQ30, 31, 40, 41, MD10, 21,
27, 29, 32, 2003



18-2598
LOWER UNIT SEAL KIT
Replaces: 3855275
Fits: Volvo SX Thru 2006



18-2586
UPPER UNIT SEAL KIT
Replaces: 3850594
Fits: Volvo SX Thru 2006



18-2726
UPPER UNIT SEAL KIT
Replaces: 3888917
Fits: Volvo SX-A/DPS-A (2007 & Up)

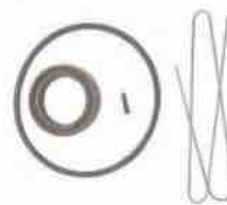

18-3893
GEAR SHIFT MECHANISM GASKET SET
Fits: 275A, 290, 280DP, 280T, 285A, 290, 290A, 290DP, SP-A, SP-A/MT, SP-A1, SP-A2, SP-C, SP-C1, DP-A, DP-A1, DP-A2, DP-B, DP-B1, DP-C, DP-C1, DP-D, DP-D1, DP-E, DP-G, DPX, DPX-S, XDP-B

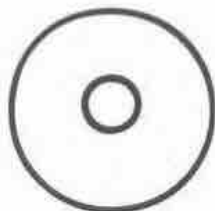

**18-2597
UPPER GEAR
UNIT SEAL KIT**

For intermediate housing: Fits: 200, 250, 270, 270T, 275, 275A, 280, 280DP, 280T, 285A, 290, 290A, 290DP, SP-A, SP-A/MT, SP-A1, SP-A2, SP-C, SP-C1, DP-A, CP-A1, DP-B, DP-B1, DP-C, DP-C1, DP-D, DP-D1, DP-E, DP-G, DPX, DPX-S, DPX-S1



**18-3888
LOWER GEAR
UNIT SEAL KIT**

For intermediate housing: Fits: 200, 250, 270, 270T, 275, 275A, 280, 280DP, 280T, 285A, 290, 290A, 290DP, SP-A, SP-A/MT, SP-A1, SP-A2, SP-C, SP-C1, DP-A, CP-A1, DP-B, DP-B1, DP-C, DP-C1, DP-D



**18-8357
COMPLETE
GEARCASE SEAL KIT**
Replaces: 875741
For: 280DP/290DP

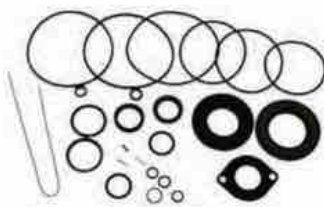

**18-8361
UPPER SEAL KIT**
Replaces: 576266-8
For: AQ200-AQ290

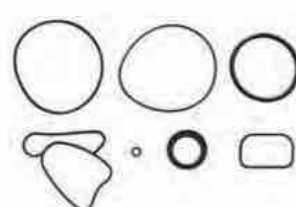

**18-2583
LOWER UNIT SEAL KIT**
Replace: 3888821
Fits: SX-A Drives (2007 and UP)



**18-2584
LOWER UNIT SEAL KIT**
Replaces: 3888822
Fits: DPS-A Drives (2007 and UP)

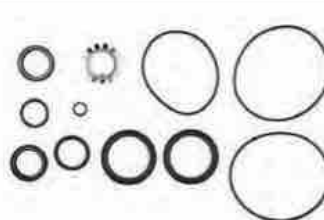

**18-8358
LOWER UNIT SEAL KIT**
Replaces: 876267
For: 280DP/290DP



**18-8359
LOWER GEARCASE
SEAL KIT**
Replaces: 876268
For: AQ200-AQ290



**18-2791
LOWER UNIT SEAL KIT**
Replaces: 3850597



**18-2625
STERNDRIVE GASKET KIT**
Replaces: 875192
AQ200, 250, 270, 275, 280, 290



**18-32882
WATER TUBE SEAL**
Replaces: 3852315



OIL SEALS

Part #	O.E. #	Dimensions (mm)		
		I.D.	O.D.	Width
18-0558	851407	44	58.33	7
18-2039	804695	13	25.4	6
18-2040	853670	45	75	8
18-2041	897426	33	45.25	7
18-2043	958838	25	35	7
18-2044	833996	12	24	7
18-2045	827247	16	28	7
18-2048	946242	35	55	10
18-2047	958860	35	62	7
18-2057	181620	34	42	4

O-RINGS														
Part #	Pkg.	O.E. #	Dimensions (mm)		Part #	Pkg.	O.E. #	Dimensions (mm)		Part #	Pkg.	O.E. #	Dimensions (mm)	
			I.D.	Width				I.D.	Width				I.D.	Width
18-7122		925095	—	—	18-7181	5	90591	50.5	3					
18-7154		949656	—	—	18-7182	5	925092	55	3					
18-7102	5	3852073	430	.065	18-7183	5	925093	69.5	3					
18-7116		3852045	360	.10	18-7184	5	925256	79	3					
18-7135		3852089	750	.135	18-7186	5	925259	102	3					
18-7141	5	3852165	180	.065	18-7187	5	925261	106	3					
18-7143	5	3852169	1,310	.100	18-7188	5	955963	9.1	1.6					
18-7147	5	949658	24	.3	18-7190	5	925065	34	3					
18-7149	5	955989	15	1.5	18-7192	5	955995	25.1	1.6					
18-7162	5	3852044	2,025	.135	18-7193	5	955974	10.3	2.4					
18-7168	5	3852033	370	.065	18-7194	5	956000	37.1	1.6					
18-7178	5	125017	23.5	.3	18-7406	5	3852523	250	.065					
18-7179	5	925054	9.3	2.4	18-7407	5	3852531	4,125	.135					
18-7180	5	925055	11.3	2.4										

Ⓢ This product is priced per piece. To order priced per package, please add -9 to the part number.



**18-3060
IMPELLER**
Replaces: 835512, 3854286
Sherwood 9959,
Jabscos 18838-0001
Oberdorfer 132-0317
OMC 3854286
Neoprene, 12 FINS



**18-5280
COMPLETE TUNE-UP KIT**
For: In-line 4

— CONTAINS —

Part #	Description	Qty.
18-5361	DISTRIBUTOR CAP	1
18-5406	ROTOR	1



**18-5278
COMPLETE TUNE-UP KIT**
For: V-6



**18-5301
TUNE-UP KIT**
Replaces:
Fits: male cap v-8 flamethrower distributors



**18-5302
TUNE-UP KIT**
Replaces:
Fits: male cap v-8 flamethrower distributors



**18-59640
ALTERNATOR**
Replaces: Prestolite



**18-6843
ALTERNATOR**
Replaces: Mando A000B0341,
TA000B0341,
Yamaha 19-1400-10
Fits: Crusader and Yamaha Sterndrive
engines



**18-6834
STARTER**
Replaces: GM Engines Universal
Used on all GM Engines with either 14 1/4"
or 12 3/4" flywheels



**18-6835
STARTER**
Replaces: GM Engines Universal
Used on all GM Engines with either 14 1/4" or 12 3/4"
flywheels

PREMIUM MARINE SPARK PLUG WIRE LEADS

Sierra's MAGFORCE Ignition Wires are "Electronics Friendly" protecting all of your electronic devices and electronic engine controls from RFI and EMI while delivering the maximum amount of voltage. Exact fit design ensures easy installation and years of trouble - free service.



YAMAHA STERNDRIVE APPLICATION						
Model	Cyl.	Distributor	Year Start	Year End	Plug Wire Set	
3.0L	4	Delco EST	1990	1993	18-8835-1	
4.3L	6	YEMS	1989	1989	18-8835-1	
4.3L	6	Delco EST	1990	1990	18-8835-1	
5.0L	8	YEMS	1989	1989	18-8836-1	
5.7L	8	Delco EST	1989	1990	18-8836-1	
7.4L	8	Delco EST	1992	1992	18-8836-1	



FUEL WATER SEPARATORS



Sierra offers a complete line of 10 and 21 micron fuel water separating filters including drainable bowl filters to protect your carbureted and fuel injected engine.

Refer to pages 136-140 for a complete listing of OEM and universal applications.

Sierra fuel water separators remove over 99.8% of emulsified water from your gasoline. Sierra's 10 micron filters are over 90% efficient at removing particles as small as 10 micron. All filters flow @ 90 GPH to feed even the hungriest motor. Sierra 10 micron filters are recommended to prevent damage to sensitive inboard and outboard fuel injection systems.



STERNDRIVE & INBOARD OIL FILTERS

All 3.0L	YSC-13231-20-0C	18-7824-2
All V-8 5.0L, 5.7L (Spin on Lube)	YSC-14231-20-0C	18-7876-1
All V-8 5.0L, 5.7L, 7.4L	YSC-16231-20-0C	18-7875

SEE PAGES 182-184 & 1147-1170 FOR ADDITIONAL INFORMATION

V-BELTS



- 1 High strength synthetic cords resist shockload failure. Their low stretch properties assure uniform performance over the life of the belt.
- 2 The compression section is a special rubber compound that assures smooth and even transfer of load forces to the cords.
- 3 Cogs are molded to precise engineering tolerances to improve flexibility and maintain cord support. Cog geometry provides a large area for air circulation to keep the belt cool and prevent damaging heat build up in the cushion section.
- 4 Rubber edges maintain positive, no-slip contact with pulley grooves for reliable energy transfer.

Part #	OE #	Application
18-15109	YSC-22260-00-0C	V-8 Sterndrive 7.4L (For: alternator)
18-15111	YSC-10260-00-0C	V-6 Sterndrive 4.3L/V-8 5, 5.7L (For: crank/pump alternator)

YAMAHA STERNDRIVE GASKETS

<p>PKG. OF 2</p>  <p>18-0164 18-0164-9^① THERMOSTAT GASKET Replaces: YSC-13080-00-0C, GM 3789161</p>	<p>PKG. OF 2</p>  <p>18-0876 18-0876-9^① FUEL PUMP GASKET Replaces: YSG-10108-43-8G</p>	<p>PKG. OF 2</p>  <p>18-0889 18-0889-9^① FUEL PUMP GASKET Replaces: YSG-10114-14-1G</p>	<p>PKG. OF 2</p>  <p>18-0891 18-0891-9^① WATER PUMP MOUNTING GASKET Replaces: YSG-37545-87-G0</p>	<p>PKG. OF 2</p>  <p>18-0874 18-0874-9^① DISTRIBUTOR GASKET Replaces: YSG-10108-44-5G</p>
<p>PKG. OF 2</p>  <p>18-2909 18-2909-9^① EXHAUST MANIFOLD GASKET Replaces: YSC-12190-00-AC For: 262 CID (4.3L)</p>	<p>PKG. OF 2</p>  <p>18-0903 18-0903-9^① WATER PUMP GASKET Replaces: YSG-38600-39-G0</p>	<p>PKG. OF 2</p>  <p>18-0887 18-0887-9^① TIMING COVER GASKET Replaces: YSG-14096-15-6G</p>	<p>PKG. OF 2</p>  <p>18-0905 18-0905-9^① OIL PAN DRAIN PLUG GASKET Replaces: YSG-14090-90-8G</p>	<p>PKG. OF 2</p>  <p>18-4698 18-46981-9^① (PKG. OF 50) DRAIN FILL WASHER Replaces: 90430-08020-00</p>

① Priced per Package

MALLORY DISTRIBUTOR PARTS GUIDE

Distributor No.	Cyl. & Rotation	Description	Contact Set	Condenser	Dist. Cap.	Rotor	Tune-Up Kit
ZD345A, B	8RH	Crusader	18-5314	18-5344	18-5376	18-5404-1	—
ZD347A	8LH	Crusader	18-5314	18-5344	18-5375	18-5411	—
ZD347B	8RH	Crusader	—	18-5344	18-5375	18-5411	—
YD349A	4LH	Burmeister & Wain	18-5314	18-5338	18-5355	18-5427	—
YD350A	8LH	Dearborn	18-5314	18-5338	18-5375	18-5411	18-5256 ①
YL350A	8LH	262, 272, 292, 312 Eng.	18-5314	18-5338	18-5376	18-5404-1	18-5251 ②
ZD352	8RH	Crusader	18-5314	18-5344	18-5375	18-5411	—
YD356A	8RH	Flagship Owens	18-5314	18-5338	18-5375	18-5411	18-5256 ①
YL356A	8RH	Flagship Owens	18-5314	18-5338	18-5375	18-5411	18-5256 ①
YL356A-2	8RH	Flagship	18-5314	18-5338	18-5375	18-5411	18-5256 ①
ZD358A	8LH	Crusader	18-5314	18-5344	18-5375	18-5411	—
YD359C, D, E, F	8LH	Gray (250, 327) AM Mtrs.	18-5314	18-5338	18-5376	18-5404-1	18-5251 ②
YL362A, B	8LH	Dearborn 390 Eng.	18-5314	18-5338	18-5375	18-5411	18-5256 ①
YD362A, B	8LH	Dearborn 390 Eng.	18-5314	18-5338	18-5375	18-5411	18-5256 ③
YL362C, D, E, F, G, H	8LH	390, 427 Eng.	18-5314	18-5338	18-5375	18-5411	18-5256 ①
YL362AV, BV, CV, DV	8LH	Dearborn 390 Eng.	18-5314	18-5338	18-5375	18-5411	18-5256 ①
ZD366A, B	8LH	Crusader (Cadillac 275 Eng.)	18-5314	18-5344	18-5375	18-5411	—
YD370A	4RH	Universal Mts.	18-5314	18-5338	18-5355	18-5427	—
YD370B	6RH	Universal Mts.	18-5314	18-5338	—	18-5427	—
YD370C	4RH	Universal Mts.	18-5314	18-5338	18-5355	18-5427	—
YL370A	4RH	Universal Mts.	18-5314	18-5338	18-5355	18-5427	—
YL370B	6RH	Universal Mts.	18-5314	18-5338	—	18-5427	—
YD372A, B, C, D	8LH	Chris Craft 430 Eng.	18-5314	18-5338	18-5375	18-5411	18-5256 ①
YL372C, D	8LH	Chris Craft 430 Eng.	18-5314	18-5338	18-5375	18-5411	18-5256 ①
YD372F-2	8LH	431 Eng.	18-5314	18-5338	18-5375	18-5411	18-5256 ①
YD375A	8RH	Chrysler M80	18-5314	18-5338	18-5376	18-5404-1	18-5251 ②
YD377A	6LH	Palmer	18-5314	18-5338	—	18-5427	—
YL387A	8LH	Dearborn	18-5314	18-5338	18-5376	18-5404-1	18-5251 ②
YD396A	6RH	Palmer 308 Eng.	18-5314	18-5338	—	18-5427	—
YD397A	6RH	Palmer 308 Eng.	18-5314	18-5338	—	18-5427	—
YD410A	4RH	Gray	18-5314	18-5338	18-5355	18-5427	—
YD410C	6RH	Gray	18-5314	18-5338	—	18-5427	—
YD411A	4RH	Gray	18-5314	18-5338	18-5355	18-5427	—
YD411B	4LH	Gray	18-5314	18-5338	18-5355	18-5427	—
YD411C	6RH	Gray	18-5314	18-5338	—	18-5427	—
YD411D	6LH	Gray	18-5314	18-5338	—	18-5427	—
YL411A	4RH	F-4 Turbo	18-5314	18-5338	18-5355	18-5427	—
YL411B	4LH	F-4 Turbo	18-5314	18-5338	18-5355	18-5427	—
YL411C	6RH	F-6 Turbo	18-5314	18-5338	—	18-5427	—
YL411D	6LH	F-6 Turbo	18-5314	18-5338	—	18-5427	—
YL414D, E, J, K	6RH	Dearborn	18-5314	18-5338	—	18-5427	—
YD420A, B, C, D	8RH	Palmer 345 Eng.	18-5314	18-5338	18-5375	18-5411	18-5256 ①
YL420E	8RH	IHC 304, 345, 392 Eng.	18-5314	18-5338	18-5375	18-5411	18-5256 ①
YD429A, B	8LH	Gray	18-5314	18-5338	18-5376	18-5404-1	18-5251 ②
YD429C, D	8LH	Gray	18-5314	18-5338	18-5375	18-5411	18-5256 ①
YL429C, D	8LH	138, 175 Eng.	18-5314	18-5338	18-5375	18-5411	18-5256 ①
ZD430A	8RH	170, 220, 225 HP	—	18-5338	18-5375	18-5411	—
YL431A	8RH	Crusader	18-5314	18-5338	18-5375	18-5411	18-5256 ①
ZYLD431A	8RH	185, 220, 230 HP	18-5314	18-5338	18-5375	18-5411	18-5256 ①
YL436A, B	6RH	Dorsett	18-5314	18-5338	—	18-5427	—

① 18-5272 Kit with distributor cap

② 18-5271 Kit with distributor cap

MALLORY DISTRIBUTOR PARTS GUIDE (CONT.)

Distributor No.	Cyl. & Rotation	Description	Contact Set	Condenser	Dist. Cap	Rotor	Tune-Up Kit
YL445A, B, BD, JV, KV	8LH	Dearborn	18-5314	18-5338	18-5375	18-5411	18-5256 ①
YP451A, B, C, D, E, F, G, H	6 RH	Chrysler M170 & M225 Engs.	18-5314	18-5338	—	—	—
YL455A, B,	8RH	Gray	18-5314	18-5338	18-5376	18-5404-1	18-5251 ②
YL457AC,AV, BV, CV, DV	8LH	Dearborn	18-5314	18-5338	18-5375	18-5411	18-5256 ①
YL458B	8RH	Gray	18-5314	18-5338	18-5376	18-5404-1	18-5251 ②
YL459A	8RH	Gray	18-5314	18-5338	18-5375	18-5411	18-5256 ①
YL461A, B	8RH	Crusader 409 Eng.	18-5314	18-5338	18-5376	18-5404-1	18-5251 ②
YL461A-2, B-2	8RH	427 Eng.	18-5314	18-5338	18-5376	18-5404-1	18-5251 ②
YL467A	8RH	Daytona (283, 327 Chevy Eng.)	18-5314	18-5338	18-5376	18-5404-1	18-5251 ②
YL469A	8RH	Chris-Craft (283, 327 Chevy Eng.)	18-5314	18-5338	18-5375	18-5411	18-5256 ①
YL474D, E	6RH	Dearborn (200 Ford Eng.)	18-5314	18-5338	—	18-5427	—
YL481A, B	6RH	Chevy 230, 292 Engs.	18-5314	18-5338	—	18-5427	—
YL486A,B,	6RH	Crusader (230, 292 Chevy Eng.)	18-5314	18-5338	—	18-5427	—
YL486C,D,	4 RH	Crusader 153 Eng.	18-5314	18-5338	18-5355	18-5427	—
YL487A	8RH	Crusader (283, 327 Chevy Eng.)	18-5314	18-5338	18-5376	18-5404-1	18-5251 ②
YL494A, BO	8LH	Dearborn	18-5314	18-5338	18-5376	18-5404-1	18-5251 ②
YL494A-2, B-2	8LH	427 Eng.	18-5314	18-5338	18-5376	18-5404-1	18-5251 ②
YL495A,B	6RH	Dearborn (170 Ford Eng.)	18-5314	18-5338	—	18-5427	—
YL496A, B,	8LH	Holman & Moody	18-5314	18-5338	18-5375	18-5411	18-5256 ①
YL501AV, CV, EV, GV	8LH	Oldsmobile Eng.	18-5314	18-5338	18-5375	18-5404-1	18-5251 ②
YL502A, B	8LH	Chris-Craft (427 Ford Eng.)	18-5314	18-5338	18-5375	18-5411	18-5256 ①
YL512A	8LH	289 Eng.	18-5314	18-5338	18-5376	18-5404-1	18-5251 ②
YL512CV, DV	8LH	Ford 302 Eng.	18-5314	18-5338	18-5376	18-5404-1	18-5251 ②
YL513A, B	8LH	Dearborn (289 Ford Eng.)	18-5314	18-5338	18-5376	18-5404-1	18-5251 ②
YL513CV, DV	8LH	Ford 289, 302 Engs.	18-5314	18-5338	18-5376	18-5404-1	18-5251 ②
YL514A, B, C, D	8LH	352, 390, 427, 428 Engs.	18-5314	18-5338	18-5376	18-5404-1	18-5251 ②
YL515A, B	8RH	283, 327 Engs.	18-5314	18-5338	18-5375	18-5411	18-5256 ①
YL519A, B, AV, BV	8LH	Dearborn (289 Ford Eng.)	18-5314	18-5338	18-5375	18-5411	18-5256 ①
YL520AV, BV, CV, CV2, DV, EV, JV	8RH	OMC	18-5314	18-5338	18-5375	18-5411	18-5256 ①
YL524AV, BV	6RH	300 Eng.	18-5314	18-5338	—	18-5427	—
YL529A, B	8RH	Crusader (283, 327 Engs.)	18-5314	18-5338	18-5375	18-5411	18-5256 ①
YL539AV	8RH	Chris-Craft (327 Chevy Eng.)	18-5314	18-5338	18-5375	18-5411	18-5256 ①
YL554CV, DV, EV, FV	8LH	Ford 351W Eng.	18-5314	18-5338	18-5376	18-5404-1	18-5251 ②
YL555CV, DV	8LH	Ford 351W Eng.	18-5314	18-5338	18-5376	18-5404-1	18-5251 ②
YL558AV, BV	8LH	Ford 351C Eng.	18-5314	18-5338	18-5375	18-5411	18-5256 ①
YL566AV	8RH	Chris-Craft (327 Chevy Eng.)	18-5314	18-5338	18-5375	18-5411	18-5256 ①
YL567CV, DV	8LH	Ford 351 Eng.	18-5314	18-5338	18-5376	18-5404-1	18-5251 ②
YL585AV, CV-2	8RH	Chris-Craft	18-5314	18-5338	18-5375	18-5411	18-5256 ①
YL623AV	8	Chris-Craft Thermo-Electron	18-5314	18-5338	18-5376	18-5404-1	18-5251 ②
YL623AV-2	8	Chris-Craft, Mercury	18-5314	18-5338	18-5375	18-5404-1	18-5251 ②
YL624AV	8	Gale Banks, Maritec,Mercury	18-5314	18-5338	18-5375	18-5404-1	18-5251 ②
YL624AV-2	8	Harmin	18-5314	18-5338	18-5375	18-5404-1	18-5251 ②
YL624JV	8	O.M.C.	18-5314	18-5338	18-5376	18-5404-1	18-5251 ②
YL624MV	8	Mercury (Mercuriser)	18-5314	18-5338	18-5376	18-5404-1	18-5251 ②
YL670AV	8	Chevy - Exc 348, 409 Eng.	18-5314	18-5338	18-5376	18-5404-1	18-5251 ②
YL673AV	4	Chevy 153 Eng.	18-5314	18-5338	18-5397	18-5404-1	18-5251 ②
YL676AV	6	Chevy In Line	18-5314	18-5338	—	—	18-5251 ②
YL677AV	6	Chevy Odd Fire	18-5314	18-5338	—	18-5404-1	—
YL/YS700AV	6	Chevy Even Fire	18-5314	18-5338	—	18-5404-1	18-5251 ②
YL703AV	8	Crusader/Thermo-Electron	18-5314	18-5338	18-5376	18-5404-1	18-5251 ②

① 18-5272 Kit with distributor cap

② 18-5271 Kit with distributor cap

PRESTOLITE DISTRIBUTOR PARTS GUIDE

Distributor Number	Contact Set	Condenser ③	Rotor	Cap	Ignition Coil	Tune-Up Kit
IAD-6004-2F, 2N, 2P	18-5307	18-5345	—	—	18-5435 ①	—
IAO-4109-1M	18-5307	18-5345	18-5430	18-5392	18-5435 ①	—
IAO-4113-1M	18-5307	18-5345	18-5430	18-5392	18-5435 ①	—
IAO-4114-1M	18-5307	18-5345	18-5430	18-5392	18-5435 ①	—
IAY-4010, A	18-5307	18-5345	18-5427	—	18-5435 ①	—
IAY-4014	18-5307	—	18-5427	—	18-5435 ①	—
IAY-4014C	18-5307	18-5345	18-5427	—	18-5435 ①	—
IBB-4205	18-5303 ②	—	18-5407	—	18-5435 ①	—
IBB-4301B	18-5303 ②	18-5345	18-5407	18-5369	18-5433	18-5255 ②
IBB-7003	18-5303 ②	18-5345	18-5407	18-5369	18-5435 ①	18-5255 ②
IBM-4106	18-5303	18-5345	18-5407	18-5369	—	18-5255 ②
IBM-4107, A	18-5303	18-5345	18-5407	18-5369	18-5435 ①	18-5255 ②
IBM-4108, A, B, C	18-5303	18-5345	18-5407	18-5369	—	18-5255 ②
IBM-4109, A	18-5303	18-5345	18-5407	18-5369	—	18-5255 ②
IBM-4110	18-5303	18-5345	18-5429	18-5391	—	18-5259
IBM-4112	18-5303	18-5345	18-5429	18-5391	18-5435 ①	18-5259
IBM-4115	18-5303	18-5345	18-5429	18-5391	18-5435	18-5258
IBM-4116	18-5303	18-5345	18-5429	18-5391	18-5435	18-5258
IBM-4117A	18-5303	18-5345	18-5407	18-5369	18-5435 ①	18-5255 ②
IBM-4118A	18-5303	18-5345	18-5429	18-5391	18-5435 ①	18-5259
IBM-4119, A	18-5303	18-5345	18-5429	18-5391	18-5435 ①	18-5259
IBM-4120	18-5303	18-5347	18-5429	18-5391	18-5433	18-5259
IBM-4122	18-5303	18-5347	18-5407	18-5369	18-5435 ①	18-5258 ②
IBM-7003B, BS	18-5303	18-5345	18-5407	18-5369	18-5433	18-5255 ②
IBM-7004A, AS, B, BS	18-5303	18-5345	18-5407	18-5369	18-5435 ①	18-5255 ②
IBM-7007, A, AS, S	18-5303	18-5345	18-5407	18-5369	18-5435 ①	18-5255 ②
IBM-7008, A, AS, B, BS, C, CS, S	18-5303	18-5345	18-5407	18-5369	18-5435 ①	18-5255 ②
IBM-7010	—	18-5345	18-5407	18-5369	18-5433	—
IBM-7011	18-5303	18-5345	18-5407	18-5369	18-5433	18-5255 ②
IBM-7011A	18-5303	18-5345	18-5407	18-5369	18-5435 ①	18-5255 ②
IBM-7011B	—	18-5345	18-5407	18-5369	18-5435 ①	—
IBM-7011C, D	18-5303	18-5345	18-5407	18-5369	18-5435 ①	18-5255 ②
IBM-7013	18-5303	18-5345	18-5403	18-5352	—	18-5260 ③
IBM-7013A	18-5303	18-5345	18-5403	18-5352	18-5433	18-5260 ③
IBM-7013B	—	18-5345	18-5403	18-5352	—	—
IBM-7013C, D, E	18-5303	18-5345	18-5403	18-5352	—	18-5260 ③
IBM-7014	18-5303	18-5345	18-5403	18-5353	—	18-5260 ③
IBM-7014A	18-5303	18-5347	18-5403	18-5353	18-5433	18-5258 ③
IBM-7016	18-5303	18-5345	18-5409	18-5352	—	18-5260 ③
IBM-7017	18-5303	18-5345	18-5409	18-5352	—	18-5260 ③
IBM-7018	18-5303	18-5345	18-5409	18-5353	—	18-5260 ③
IBM-7019, A, AS, S	18-5303	18-5345	18-5403	18-5352	18-5435 ①	18-5260 ③
IBM-7020, A, AS, B, BS, C, CS, S	18-5303	18-5345	18-5403	18-5352	18-5435 ①	18-5260 ③
IBM-7021	18-5303	18-5345	18-5403	18-5353	—	18-5260
IBP-4105, A	—	18-5345	18-5407	18-5369	18-5435 ①	—
IBP-4110, A, B	—	18-5345	18-5429	18-5391	18-5435 ①	—
IBP-4111A	—	18-5345	18-5407	18-5369	18-5435 ①	—
IBP-4112A, B	—	18-5345	18-5429	18-5391	18-5435 ①	—
IBP-4113A, B, C	—	18-5345	18-5429	18-5391	18-5435 ①	—
IBR-4205, A, S	—	18-5347	—	—	18-5435 ①	—
IBR-7002, A, AS, S	18-5307	18-5345	18-5430	18-5392	18-5433	—
IDD-7001	N/A	N/A	18-5407	18-5369	—	N/A
IDH-7001, S	N/A	N/A	18-5407	18-5369	—	N/A
IDH-7002, S	N/A	N/A	18-5407	18-5369	—	N/A
IDH-7003A, AS, S	N/A	N/A	18-5407	18-5369	—	N/A
IDH-7004	N/A	N/A	18-5409	18-5352	—	N/A
IDH-7005	N/A	N/A	18-5409	18-5352	—	N/A
IDH-7006, A	N/A	N/A	18-5403	18-5352	—	N/A
IDH-7902	N/A	N/A	18-5403	—	18-5433	N/A
IDU-7601	N/A	N/A	18-5403	18-5353	—	N/A
IDU-7801, A, B	N/A	N/A	18-5403	18-5352	18-5433	N/A
IGC-5501A	18-5307	18-5345	18-5430	—	18-5435 ①	—
IGW-4056	—	—	—	—	18-5433	—
IGW-4118A	—	—	—	—	18-5435 ①	—
IGW-4199B, C	—	—	—	—	18-5435 ①	—
IGW-4301	—	—	—	—	18-5435 ①	—
IGW-4409A	—	—	—	—	18-5435 ①	—

N/A Not Applicable ① 12 Volt System Only ② 2 Required ③ Condensers 18-5340 (Wire Conductor) and 18-5347 (Strap Conductor) are interchangeable.
 ④ 18-5275 Kit with distributor cap ⑤ 18-5276 Kit with distributor cap ⑥ 18-5277 Kit with distributor cap

Chrysler Outboard			Chrysler Outboard			Chrysler Outboard			Chrysler Outboard		
MODEL NO.	HP	YEAR	MODEL NO.	HP	YEAR	MODEL NO.	HP	YEAR	MODEL NO.	HP	YEAR
32 H1,H2,H3	3.5	1981-83	255 HA,HB	25	1973-76	923-24-33-34	9.9	1968-69	35501-02-31	35	1965
32 HA,HB,HC	3.6	1970-76	256 HA,H8	25	1975-78	1006 H0,H1	100	1980-81	35601-02-31	35	1966
33 HA,HB,HC	3.6	1970-76	257 HA,H8,H3	25	1975-78	1007 H9	100	1979	35701-02-21-22	35	1967
42 HB,H8,H9, H0,H1,H2,H3	4	1977-83			1983	1008 H0,H1,H3	100	1980-81	35731-32-41-42	35	1967
43 H0,H1	4	1980-81	301,02	3.5	1969			1983	35751-52	35	1967
47 HB,H8,H9	4	1977-79	302 HA,HB,H9	30	1973-75, 1979	1056 HA-HF,H0	105	1970-74, 1980	40001-11-21	40	1960
52 HA	5	1970	303 HA,HB,H9	30	1973-75, 1979	1057 HA-HF	105	1970-74	40031-61-71	40	1960
53 HA	5	1970				1058 H2	105	1983	40101-02-03-04	40	1961-62
54 HB,HC,HD	5	1975-76	303-04	3.5	1968-69	1059 HD-HG	105	1975-77	40111-12-13-14	40	1961
55 HB,HC,HD	5	1975-76	304 HA,HB	30	1973-75	1156 H0,H1	115	1980-81	40121-22	40	1961-62
60 H8,H0	6	1978,1980	305 HA,HB	30	1973-75	1157 H8,H9	115	1978-79	40131-32	40	1961
61 H8,H0	6	1978,1980	306 HA,H9,H0	30	1975, 1979-80	1158 H0,H1,H2,H3	115	1980-83	40161-62	40	1961-62
62 HA-HH,H8	6	1971-78				1159 H8,H9	115	1978-79	40171-72	40	1961
63 HA-HH	6	1971-77	307 HA,H9, H0,H1,H2	30	1975, 1979-82	1206 HA-HD	120	1970-74	45321-22-31-32	45	1963
64 H9,H0,H1,H2	6	1979-82				1207 HA-HD	120	1970-74	45361-62-71-72	45	1963
65 H0	6	1980	311	3.5	1969	1208 HA-HD	120	1970-71	45421-22-23-24	45	1964
67 H8	6	1978	313	3.5	1968-69	1209 HD-HG	120	1975-77	45431-32-33-34	45	1964
70 H9	7.5	1979	350 HA-HK,H8	35	1970-78	1258 H2	125	1982	45521-22-31-32	45	1965
71 H9,H1,H2,H3	7.5	1979, 1981-83	351 HD-HK,H8	35	1972-78	1306 HA	130	1972-73	45621-22-31-32	45	1966
			352 HA-HH	35	1970-75	1307	130	1972-73	45701-02-11-12	45	1967
			353 HA-HH,H0,H1	35	1970-75, 1980-81	1358 HA-HG	135	1969-71	45721-22-31-32	45	1967
72 H9,H0,H1, H2,H3	7.5	1979-83				1359 HD-HG	135	1975-77	45761-62-71-72	45	1967
72 HA	7	1970	354 HA-HH	35	1970-75	1406 H0,H1	140	1980-81	45781-82	45	1967
73 HA	7	1970	355 HA-HH	35	1970-75	1407 H8,H9	140	1978-79	50421-22-23	50	1964
77 H9,H0,H1	7.5	1979-81	356 HA-HK,H8	35	1970-78	1408 H0,H1,H2,H3	140	1980-83	50431-32-33	50	1964
82 HA-HH,H8	8	1971-78	357 HA-HK,H8,H3	35	1971-78, 1983	1409 H9	140	1979	50461-62-63	50	1964
83 HA-HH	8	1971-77				1508 HA Racing	150	1972	50471-72-73	50	1964
87 H8	8	1978	450 HA-HH	45	1970-75	1508 HB Racing	150	1973	50521-22-31-32	50	1965
91 H0,H3	9.9	1980,1983	451 HA-HHY	45	1970-75	1508 HC Racing	150	1974-75	50561-62-71-72	50	1965
92 H0,H1,H2,H3	9.9	1980-83	452 HA-HH	45	1970-75	1509 HC Racing	150	1974-75	50621-22-31-32	50	1966
92 HA,HB,HD	9.9	1970-73	453 HA-HH	45	1970-75	2003-04-13-14	20	1968-69	50661-62-71-72	60	1966
93 HA,HB,HD,H0	9.9	1970- 73,1980	454 HA-HH	45	1970-75	2023-24-33-34	20	1968-69	55721-22-31-32	55	1967
			455 HA-HH	45	1970-75	2101-02	2	1961	55761-62-71-72	55	1967
94 HA,HB,HD	9.9	1970-73	456 HA-HH	45	1970-75	2201-02	3.5	1962	75618-38-48	75	1968
95 H0,H1,H2,H3	9.9	1980-83	456 H8,H9,H0,H1	45	1978-81	2251-52	3.5	1963	75661-62	75	1966
95 HA,HB,HD	9.9	1970-73	457 H8,H9,H0, H1,H2,H3	45	1978-83	2901	2	1959-60	75671-72-73-74	75	1966
98 H1,H2	9.9	1981-82	457 HA-HH	45	1970-77	3018-28	3.5	1968-69	75718-38-48	75	1968
100 HA	10	1976-77	458 HA-HF,H8	45	1971-78	3118	3.5	1968-69	75761-62-63-64	75	1967
101 H8	10	1978	459 HA-HF,H8	45	1971-78	3501-02-11	3.5	1965	75771-72-73-74	75	1967
102 HA-HA,H8	10	1974-78	502-02-11-12	5	1969	3401-02-03-13	3.5	1964	80161	80	1961
103 HA-HD,H8	10	1974-78	503 H3	50	1983	3525-26-35-37-45	35	1968-69	80162-63-64-65	80	1961-62
104 HA,HB,HC	10	1974-75	507 H1,H2,H3	50	1981-83	3546-55-56-85-86	35	1968-69	80241-42-52	80	1962-63
105 HA,HB,HC	10	1974-75	511-12	5	1969	3601-02-11	3.5	1966	80353-61-62-63	80	1963
108 HA,H8	10	1976-78	554 HA-HG	55	1970-75	3701-02-11	3.5	1967	80461-62-71- 72-91	80	1964
109 HA,H8	10	1976-78	555 HA-HG	55	1970-75	4018-28	4.4	1968	80561-71-72	80	1965
121 H9	12	1979	556 HA-HG	55	1970-76	4118-28	4.4	1968	10565-66-75-76	105	1968-69
122 H9	12	1979	557 HA-HG	55	1970-76	4505-06-25-26-35	45	1968-69	105661-62-71-72	105	1966
122 HA,HC	12.9	1971-73	558 HA-HG	55	1970-76	4536-45-46-55-56	45	1968-69	105761-62-63-64	105	1967
123 H9	12	1979	559 HA-HH,H8, H9,H0,H1,H2,H3	55	1970-83	4565-66-75-76	45	1968-69	105771-72-73-74	105	1967
123 HA,HC	12.9	1971-73	608 HA	60	1974-75	5545-46-55-56	55	1968-69			
124 HA,HC	12.9	1971-73	609 HA	60	1974-76	5565-66-75-76	55	1968-69			
125 HA,HC	12.9	1971-73	659 H8	65	1978	5581-82-91-92	55	1969			
128 H9	12	1979	703-04-13-14	7	1969	6018-28	6.6	1968			
129 H9	12	1979	706 HA-HE	70	1970-73	6118-28	6.6	1968			
152 HB,H0, H1,H2,H3	15	1978, 1980-83	707 HA-HF	70	1970-73	6401-02	6	1964			
152 HA,HB,HC	15	1974-77	709 H9	70	1979	6501-02	6	1965			
153 HA,HB, HC,H8,H0	15	1974-78, 1980	711,12	7	1969	6601-02-03	6	1966			
154 HA,HB	15	1974-75	750 H	75	1974	6701-02	6	1967			
155 AH,H0	15	1974-75	756 HA,H0, H1,H2,H3	75	1974, 1980-83	7001	7.5	1960-61			
158 HA,H8,H3	15	1976-78, 1983				7061-62-71-72	70	1969			
			757 HA,HB, HC,H8,H9	75	1974-79	7301-02	7.5	1963			
159 HA,H8	15	1976-78				7201-02	7.5	1962			
200 HA-HG	20	1970-75	758 H0,H1,H2,H3	75	1980-83	8001	8	1960			
202 H9,H0,H1,H2	20	1979-82	850 H0,H1	85	1980-81	8561-62-71-72	85	1969			
203 H9,H0,H1	20	1979-81	856 HA-HD,H0,H1	85	1970-73, 1980-81	10583-84	105	1968-69			
203 HA-HG	20	1970-75				12101-02	12	1961-62			
204 HA-HG	20	1970-75	857 H8,H9	85	1978-79	12301-02-11-12	12	1963			
205 HA-HG	20	1970-75	858 H0,H1,H2,H3	85	1980-83	18001-11	18	1960			
206 H9,H1	20	1979,1981	859 H8,H9	85	1978-79	18101-02-11-12	18	1961-62			
207 H9,H1	20	1979,1981	901,02	9.9	1969	20301-02-03-04	20	1963			
252 HA,HB, H8,H2,H3	25	1973-78, 1982-83	906 HA	90	1974	20401-02-11	20	1964			
			907 HA-HC	90	1974-77	20501-02-11	20	1965			
253 HA,HB,H8	25	1973-78	907-08-17-18	9.9	1968-69	20601-02-11-41-42	20	1966			
254 HA,HB	25	1973-76	908 H3	90	1983	20701-02-11	20	1967			
			911,12	9.9	1969	20741-42-51-52	20	1967			
						25021-31	25	1961-62			
						30301-02-11-12	30	1963			
						30321	30	1963			
						35401-02-31	35	1964			

Evinrude Outboards
1950-1979

1002	1.5	1970
1802	1.5	1968
1902	1.5	1969
2102	2	1971
2202	2	1972
2302	2	1973
2402	2	1974
2502	2	1975
2602	2	1976
2702	2	1977
2802	2	1978
2902	2	1979
3034	3	1960
3035	3	1960
3036	3	1960
3038	3	1961
3039	3	1961
3040	3	1961
3042	3	1962
3043	3	1962
3043	3	1964
3044	3	1962
3053	3	1965
3302	3	1963
3303	3	1963
3312	3	1963

Evinrude Outboards 1950-1979			Evinrude Outboards 1950-1979			Evinrude Outboards 1950-1979			Evinrude Outboards 1950-1979		
MODEL NO.	HP	YEAR	MODEL NO.	HP	YEAR	MODEL NO.	HP	YEAR	MODEL NO.	HP	YEAR
3402	3	1964	6203	6	1972	10925	9.9	1979	25702	25	1977
3412	3	1964	6302	6	1973	10935	9.9	1979	25703	25	1977
3432	3	1964	6303	6	1973	10954	9.9	1979	25752	25	1977
3433	3	1964	6402	6	1974	10955	9.9	1979	25753	25	1977
3502	3	1965	6403	6	1974	15032	18	1960	25802	25	1978
3512	3	1965	6502	6	1965	15033	18	1960	25803	25	1978
3532	3	1965	6503	6	1965	15034	18	1961	25852	25	1978
3533	3	1965	6504	6	1975	15035	18	1961	25853	25	1978
3602	3	1966	6505	6	1975	15036	18	1962	25902	25	1969
3603	3	1966	6602	6	1966	15037	18	1962	25903	25	1969
3606	3	1966	6603	6	1966	15404	15	1974	25904	25	1979
3612	3	1966-67	6604	6	1976	15405	15	1974	25905	25	1979
3632	3	1966	6605	6	1976	15454	15	1974	25952	25	1979
3633	3	1966	6702	6	1967	15455	15	1974	25953	25	1979
3636	3	1966	6703	6	1967	15504	15	1975	28202	28	1962
3702	3	1967	6704	6	1977	15505	15	1975	28203	28	1962
3703	3	1967	6705	6	1977	15554	15	1975	28302	28	1963
3706	3	1967	6802	6	1968	15555	15	1975	28303	28	1963
3707	3	1967	6803	6	1968	15604	15	1976	28352	28	1963
3712	3	1967	6804	6	1978	15605	15	1975	28402	28	1964
3716	3	1967	6805	6	1978	15654	15	1976	28403	28	1964
3732	3	1967	6902	6	1969	15655	15	1976	28452	28	1964
3733	3	1967	6903	6	1969	15704	15	1977	33002	33	1970
3736	3	1967	6904	6	1979	15705	15	1977	33003	33	1970
3737	3	1967	6905	6	1979	15754	15	1977	33052	33	1970
3802	3	1968	9022	9.5	1970	15755	15	1977	33053	33	1970
3803	3	1968	9023	9.5	1970	15804	15	1978	33502	33	1965
3806	3	1968	9122	9.5	1971	15805	15	1978	33503	33	1965
3807	3	1968	9123	9.5	1971	15854	15	1978	33552	33	1965
3832	3	1968	9222	9.5	1972	15855	15	1978	33553	33	1965
3833	3	1968	9223	9.5	1972	15904	15	1979	33602	33	1966
3836	3	1968	9322	9.5	1973	15905	15	1979	33603	33	1966
3837	3	1968	9323	9.5	1973	15954	15	1979	33652	33	1966
4006	4	1970	9422	9.5	1964	15955	15	1979	33653	33	1966
4036	4	1970	9423	9.5	1964	18002	18	1970	33702	33	1967
4106	4	1971	9522	9.5	1965	18003	18	1970	33703	33	1967
4136	4	1971	9523	9.5	1965	18102	18	1971	33752	33	1967
4206	4	1972	9622	9.5	1966	18103	18	1971	33753	33	1967
4236	4	1972	9623	9.5	1966	18202	18	1972	33802	33	1968
4306	4	1973	9722	9.5	1967	18203	18	1972	33803	33	1968
4336	4	1973	9723	9.5	1967	18302	18	1963	33852	33	1968
4406	4	1974	9822	9.5	1968	18303	18	1963	33853	33	1968
4436	4	1974	9823	9.5	1968	18304	18	1973	33902	33	1969
4506	4	1975	9922	9.5	1969	18305	18	1973	33903	33	1969
4536	4	1975	9923	9.5	1969	18402	18	1964	33952	33	1969
4606	4	1976	10020	10	1960	18403	18	1964	33953	33	1969
4636	4	1976	10021	10	1960	18502	18	1965	35018	40	1960
4706	4	1977	10022	10	1961	18503	18	1965	35019	40	1960
4736	4	1977	10023	10	1961	18602	18	1966	35022	40	1961
4806	4	1978	10024	10	1962	18603	18	1966	35023	40	1961
4836	4	1978	10025	10	1962	18702	18	1967	35028	40	1962
4837	4	1978	10302	10	1963	18703	18	1967	35029	40	1962
4902	4	1969	10303	10	1963	18802	18	1968	35520	40	1960
4904	4	1979	10422	9.5	1964	18803	18	1968	35521	40	1960
4906	4	1969	10424	9.9	1974	18902	18	1969	35524	40	1961
4932	4	1979	10425	9.9	1974	18903	18	1969	35525	40	1961
4933	4	1979	10454	9.9	1974	25002	25	1970	35530	40	1962
4936	4	1969	10455	9.9	1974	25003	25	1970	35531	40	1962
5302	5.5	1963	10522	9.5	1965	25102	25	1971	35602	35	1976
5303	5.5	1963	10524	9.9	1975	25103	25	1971	35603	35	1976
5402	5.5	1964	10525	9.9	1975	25202	25	1972	35652	35	1976
5403	5.5	1964	10554	9.9	1975	25203	25	1972	35653	35	1976
5502	5	1965	10555	9.9	1975	25252	25	1972	35702	35	1977
5503	5	1965	10622	9.5	1966	25253	25	1972	35703	35	1977
5520	5.5	1960	10624	9.9	1976	25302	25	1973	35752	35	1977
5521	5.5	1960	10625	9.9	1976	25303	25	1973	35753	35	1977
5522	5.5	1961	10654	9.9	1976	25352	25	1973	35802	35	1978
5523	5.5	1961	10655	9.9	1976	25353	25	1973	35803	35	1978
5524	5.5	1962	10722	9.5	1967	25402	25	1974	35852	35	1978
5525	5.5	1962	10724	9.9	1977	25403	25	1974	35853	35	1978
5602	5	1966	10725	9.9	1977	25452	25	1974	35902	35	1979
5603	5	1966	10754	9.9	1977	25453	25	1974	35903	35	1979
5702	5	1967	10755	9.9	1977	25502	25	1975	35932	40	1962
5703	5	1967	10822	9.5	1968	25503	25	1975	35933	40	1962
5802	5	1968	10824	9.9	1978	25552	25	1975	35952	35	1979
5803	5	1968	10825	9.9	1978	25553	25	1975	35953	35	1979
6002	6	1970	10835	9.9	1978	25602	25	1976	40002	40	1970
6003	6	1970	10854	9.9	1978	25603	25	1976	40003	40	1970
6102	6	1971	10855	9.9	1978	25652	25	1976	40052	40	1970
6202	6	1972	10924	9.9	1979	25653	25	1976	40053	40	1970

Evinrude Outboards 1950-1979			Evinrude Outboards 1950-1979			Evinrude Outboards 1950-1979			Evinrude Outboards 1950-1979		
MODEL NO.	HP	YEAR	MODEL NO.	HP	YEAR	MODEL NO.	HP	YEAR	MODEL NO.	HP	YEAR
40072	40	1970	50272	50	1972	70573	70	1975	100693	100	1966
40073	40	1970	50273	50	1972	70673	70	1976	100782	100	1967
40102	40	1971	50302	50	1973	70773	70	1977	100783	100	1967
40103	40	1971	50303	50	1973	70873	70	1978	100882	100	1968
40152	40	1971	50372	50	1973	70973	70	1979	100883	100	1968
40153	40	1971	50373	50	1973	75352	75	1963	100990	100	1979
40202	40	1972	50442	50	1974	75353	75	1963	100993	100	1979
40203	40	1972	50443	50	1974	75382	75	1963	100999	100	1979
40252	40	1972	50472	50	1974	75383	75	1963	115083	115	1970
40253	40	1972	50473	50	1974	75392	75	1963	115393	115	1973
40302	40	1963	50522	75	1960	75393	75	1963	115493	115	1974
40303	40	1963	50523	75	1960	75432	75	1964	115499	115	1974
40304	40	1973	50524	75	1961	75433	75	1964	115593	115	1975
40305	40	1973	50525	75	1961	75452	75	1964	115693	115	1976
40352	40	1963	50528	75	1962	75453	75	1964	115699	115	1976
40353	40	1963	50529	75	1962	75482	75	1964	115742	115	1967-68
40354	40	1973	50542	50	1975	75483	75	1964	115790	115	1977
40355	40	1973	50543	50	1975	75492	75	1964	115793	115	1977
40362	40	1963	50572	50	1975	75493	75	1964	115799	115	1977
40363	40	1963	50573	50	1975	75532	75	1965	115890	115	1978
40372	40	1963	50802	50	1978	75533	75	1965	115893	115	1978
40373	40	1963	50803	50	1978	75542	75	1975	115899	115	1978
40402	40	1964	50902	50	1979	75543	75	1975	115983	115	1969
40403	40	1964	50903	50	1979	75552	75	1965	115990	115	1979
40404	40	1974	50926	75	1961	75553	75	1965	115993	115	1979
40405	40	1974	50927	75	1961	75582	75	1965	115999	115	1979
40452	40	1964	50930	75	1962	75583	75	1965	125183	125	1971
40453	40	1964	50931	75	1962	75592	75	1965	125283	125	1972
40454	40	1974	55642	55	1976	75593	75	1965	135342	135	1973
40455	40	1974	55643	55	1976	75642	75	1976	135383	135	1973
40462	40	1964	55672	55	1976	75643	75	1976	135443	135	1974
40463	40	1964	55673	55	1976	75742	75	1977	135483	135	1974
40472	40	1964	55772	55	1977	75743	75	1977	135489	135	1974
40473	40	1964	55773	55	1977	75842	75	1978	135543	135	1975
40502	40	1965	55872	55	1968	75843	75	1978	135583	135	1975
40503	40	1965	55873	55	1968	75942	75	1979	135589	135	1975
40504	40	1975	55874	55	1978	75943	75	1979	135643	135	1976
40505	40	1975	55875	55	1978	80652	80	1966	135683	135	1976
40552	40	1965	55902-55903	55	1979	80653	80	1966	140740	140	1977
40553	40	1965	55972	55	1969	80682	80	1966	140743	140	1977
40554	40	1975	55973	55	1969	80683	80	1966	140783	140	1977
40555	40	1975	55974	55	1979	80692	80	1966	140840	140	1978
40562	40	1965	55975	55	1979	80693	80	1966	140843	140	1978
40563	40	1965	60062	60	1970	80752	80	1967	140883	140	1978
40572	40	1965	60063	60	1970	80753	80	1967	140940	140	1979
40573	40	1965	60072	60	1970	80792	80	1967	140943	140	1979
40602	40	1966	60073	60	1970	80793	80	1967	140983	140	1979
40603	40	1966	60162	60	1971	85093	85	1970	150840	150	1978
40604	40	1976	60163	60	1971	85193	85	1971	150849	150	1978
40605	40	1976	60172	60	1971	85293	85	1972	150940	150	1979
40652	40	1966	60173	60	1971	85393	85	1973	150949	150	1979
40653	40	1966	60432	60	1964	85493	85	1974	175740	175	1977
40654	40	1976	60433	60	1964	85593	85	1975	175749	175	1977
40655	40	1976	60452	60	1964	85693	85	1976	175840	175	1978
40662	40	1966	60453	60	1964	85699	85	1976	175849	175	1978
40663	40	1966	60532	60	1965	85790	85	1977	175940	175	1979
40672	40	1966	60533	60	1965	85793	85	1977	175949	175	1979
40673	40	1966	60552	60	1965	85799	85	1977	200640	200	1976
40702	40	1967	60553	60	1965	85852	85	1968	200649	200	1976
40703	40	1967	60632	60	1966	85853	85	1968	200740	200	1977
40752	40	1967	60633	60	1966	85890	85	1978	200749	200	1977
40753	40	1967	60652	60	1966	85892	85	1968	200840	200	1978
40772	40	1967	60653	60	1966	85893	85	1968	200849	200	1978
40773	40	1967	60732	60	1967	85895	85	1978	200940	200	1979
40802	40	1968	60733	60	1967	85899	85	1978	200949	200	1979
40803	40	1968	60752	60	1967	85990	85	1979	235840	235	1978
40852	40	1968	60753	60	1967	85993	85	1969	235849	235	1978
40853	40	1968	65272	65	1972	85995	85	1979	235940	235	1979
40872	40	1968	65273	65	1972	85999	85	1979	235949	235	1979
40873	40	1968	65372	65	1973	90482	90	1964	Johnson Outboards 1960-1979		
40902	40	1969	65373	65	1973	90483	90	1964			
40903	40	1969	65832	65	1968	90492	90	1964			
40952	40	1969	65833	65	1968	90493	90	1964			
40953	40	1969	65852	65	1968	90582	90	1965			
40972	40	1969	65853	65	1968	90583	90	1965			
40973	40	1969	70442	70	1974	90592	90	1965			
50172	50	1971	70443	70	1974	90593	90	1965			
50173	50	1971	70472	70	1974	100193	100	1971			
50202	50	1972	70473	70	1974	100293	100	1972			
50203	50	1972	70572	70	1975	100683	100	1966			

Johnson Outboards 1960-1979			Johnson Outboards 1960-1979			Johnson Outboards 1960-1979			Johnson Outboards 1960-1979		
MODEL NO.	HP	YEAR	MODEL NO.	HP	YEAR	MODEL NO.	HP	YEAR	MODEL NO.	HP	YEAR
2R76	2	1976	25E75-25EL75	25	1975	85EL76	85	1976	235TXL79	235	1979
2R77	2	1977	25E76-25EL76	25	1976	85EL77	85	1977	CD-17	5.5	1960
2R78	2	1978	25E77-25EL77	25	1977	85ESL69	85	1969	CD-18	5.5	1961
2R79	2	1979	25E78-25EL78	25	1978	85ESL70	85	1970	CD-19	5.5	1962
4R69-4RL69	4	1969	25E79-25EL79	25	1979	85ESL71	85	1971	CD-20	5.5	1963
4R70-4RL70	4	1970	25R69-25RL69	25	1969	85ESL72	85	1972	CD-21	5.5	1964
4R71-4RL71	4	1971	25R70-25RL70	25	1970	85ESL73	85	1973	CD-22	6	1965
4R72-4RL72	4	1972	25R71-25RL71	25	1971	85ESL74	85	1974	CD-23	6	1966
4R73-4RL73	4	1973	25R72-25RL72	25	1972	85ESL75	85	1975	CD-24	6	1967
4R74-4RL74	4	1974	25R73-25RL73	25	1973	85ETLR76	85	1976	CD-25	6	1968
4R75-4RL75	4	1975	25R74-25RL74	25	1974	85ETLR77	85	1977	FD-14	18	1960
4R76-4RL76	4	1976	25R75-25RL75	25	1975	85ETLR78	85	1978	FD-15	18	1961
4R77-4RL77	4	1977	25R76-25RL76	25	1976	85ML78	85	1978	FD-16	18	1962
4R78-4RL78	4	1978	25R77-25RL77	25	1977	85ML79	85	1979	FD-17	18	1963
4R79-4RL79	4	1979	25R78-25RL78	25	1978	85TL79	85	1979	FD-18	18	1964
4W69	4	1969	25R79-25RL79	25	1979	85TXL79	85	1979	FD-19	18	1965
4W70-4WL70	4	1970	33E69-33EL69	33	1969	85TXLR77	85	1977	FD-20	20	1966
4W71-4WL71	4	1971	33E70-33EL70	33	1970	85TXLR78	85	1978	FD-21	20	1967
4W72	4	1972	33R69-33RL69	33	1969	100ESL71	100	1971	FD-22	20	1968
4W73	4	1973	33R70-33RL70	33	1970	100ESL72	100	1972	JH-19	3	1964
4W74	4	1974	35E76-35EL76	35	1976	100ML79	100	1979	JH-20	3	1965
4W75	4	1975	35E77-35EL77	35	1977	100TLR79	100	1979	JH-21	3	1966
4W76	4	1976	35E78-35EL78	35	1978	100TXLR79	100	1979	JH-22	3	1967
4W77	4	1977	35E79-35EL79	35	1979	115EL76	115	1976	JH-23	3	1968
4W78	4	1978	35R76-35RL76	35	1976	115EL77	115	1977	JHF-21	3	1967
4W79	4	1979	35R77-35RL77	35	1977	115ESL69	115	1969	JHF-22	3	1967
6R69-6RL69	6	1969	35R78-35RL78	35	1978	115ESL70	115	1970	JHF-23	3	1968
6R70-6RL70	6	1970	35R79-35RL79	35	1979	115ESL73	115	1973	JW-16	3	1960
6R71-6RL71	6	1971	40E69-40EL69	40	1969	115ESL74	115	1974	JW-17	3	1961-62
6R72-6RL72	6	1972	40E70-40EL70	40	1970	115ESL75	115	1975	JW-18	3	1963
6R73-6RL73	6	1973	40E71-40EL71	40	1971	115ETL74	115	1974	JW-19	3	1964
6R74-6RL74	6	1974	40E72-40EL72	40	1972	115ETL75	115	1975	JW-20	3	1965
6R75-6RL75	6	1975	40E73-40EL73	40	1973	115ETL76	115	1976	JW-21	3	1966
6R76-6RL76	6	1976	40E74-40EL74	40	1974	115ETL77	115	1977	JW-22	3	1967
6R77-6RL77	6	1977	40E75-40EL75	40	1975	115ETL78	115	1978	JW-23	3	1968
6R78-6RL78	6	1978	40E76-40EL76	40	1976	115ML78	115	1978	JWF-21	3	1967
6R79-6RL79	6	1979	40ES69-40ESL69	40	1969	115ML79	115	1979	JWF-23	3	1968
8RC1-8RLC1	7.5	1981	40ES70-40ESL70	40	1970	115TL79	115	1979	LD-10	5	1965
8RCN-8RLCN	7.5	1982	40R69-40RL69	40	1969	115TXL77	115	1977	LD-11	5	1966
8RCS-8RLCS	7.5	1980	40R70-40RL70	40	1970	115TXL78	115	1978	LD-12	5	1967
8RCT-8RLCT	7.5	1983	40R71-40RL71	40	1971	115TXL79	115	1979	LD-13	5	1968
9R69-9RL69	9.5	1969	40R72-40RL72	40	1972	125ESL71	125	1971	MQ-10	9.5	1964
9R70-9RL70	9.5	1970	40R73-40RL73	40	1973	125ESL72	125	1972	MQ-11	9.5	1965
9R71-9RL71	9.5	1971	40R74-40RL74	40	1974	135EL76	135	1976	MQ-12	9.5	1966
9R72-9RL72	9.5	1972	40R75-40RL75	40	1975	135ESL73	135	1973	MQ-13	9.5	1967
9R73-9RL73	9.5	1973	40R76-40RL76	40	1976	135ESL74	135	1974	MQ-14	9.5	1968
10E74-10EL74	9.9	1974	50ES71-50ESL71	50	1971	135ESL75	135	1975	QD-21	10	1960
10E75-10EL75	9.9	1975	50ES72-50ESL72	50	1972	135ETL74	135	1974	QD-22	10	1961
10E76-10EL76	9.9	1976	50ES73-50ESL73	50	1973	135ETL75	135	1975	QD-23	10	1962
10E77-10EL77	9.9	1977	50ES74-50ESL74	50	1974	135ETL76	135	1976	QD-24	10	1963
10E78-10EL78	9.9	1978	50ES75-50ESL75	50	1975	140ML77	140	1977	RD-22	40	1960
10E79-10EL79	9.9	1979	50R72-50RL72	50	1972	140ML78	140	1978	RD-23	40	1961
10R74-10RL74	9.9	1974	50R73-50RL73	50	1973	140ML79	140	1979	RD-24	40	1962
10R75-10RL75	9.9	1975	50R77-50RL77	50	1977	140TL77	140	1977	RD-25	40	1963
10R76-10RL76	9.9	1976	50R78-50RL78	50	1978	140TL78	140	1978	RD-26	40	1964
10R77-10RL77	9.9	1977	50R79-50RL79	50	1979	140TL79	140	1979	RD-27	40	1965
10R78-10RL78	9.9	1978	55E76-55EL76	55	1976	140TXL77	140	1977	RD-28	40	1966
10R79-10RL79	9.9	1979	55E77-55EL77	55	1977	140TXL78	140	1978	RD-29	40	1967
10SEL78	9.9	1978	55E78-55EL78	55	1978	140TXL79	140	1979	RD-30	40	1968
10SEL79	9.9	1979	55E79-55EL79	55	1979	150TL78	150	1978	RDS-22	40	1960
15E74-15EL74	15	1974	55ES69-55ESL69	55	1969	150TL79	150	1979	RDS-23	40	1961
15E75-15EL75	15	1975	55R79-55RL79	55	1979	150TXL78	150	1978	RDS-24	40	1962
15E76-15EL76	15	1976	60ES70-60ESL70	60	1970	150TXL79	150	1979	RDS-25	40	1963
15E77-15EL77	15	1977	60ES71-60ESL71	60	1971	175L77	175	1977	RDS-26	40	1964
15E78-15EL78	15	1978	65ES72-65ESL72	65	1972	175TL78	175	1978	RDS-27	40	1965
15E79-15EL79	15	1979	65ES73-65ESL73	65	1973	175TL79	175	1979	RDS-28	40	1966
15R74-15RL74	15	1974	65ESLR72	65	1972	175TXL77	175	1977	RDS-29	40	1967
15R75-15RL75	15	1975	65ESR73-65ESLR73	65	1973	175TL78	175	1978	RDS-30	40	1968
15R76-15RL76	15	1976	70EL76	70	1976	175TXL79	175	1979	RK-24	40	1962
15R77-15RL77	15	1977	70EL77	70	1977	200TL76	200	1976	RK-25	40	1963
15R78-15RL78	15	1978	70EL78	70	1978	200TL77	200	1977	RK-26	40	1964
15R79-15RL79	15	1979	70EL79	70	1979	200TL78	200	1978	RK-27	40	1965
20R69-20RL69	20	1969	70ES74-70ESL74	70	1974	200TL79	200	1979	RK-28	40	1966
20R70-20RL70	20	1970	70ES75-70ESL75	70	1975	200TXL76	200	1976	RK-29	40	1967
20R71-20RL71	20	1971	70ESLR74	70	1974	200TXL77	200	1977	RK-30	40	1968
20R72-20RL72	20	1972	75ER76-75ELR76	75	1976	200TXL78	200	1978	RX-10	28	1962
20R73-20RL73	20	1973	75ER77-75ELR77	75	1977	200TXL79	200	1979	RX-11	28	1963
25E72-25EL72	25	1972	75ER78-75ELR78	75	1978	235TL78	235	1978	RX-12	28	1964
25E73-25EL73	25	1973	75ER79-75ELR79	75	1979	235TL79	235	1979	RX-13	33	1965
25E74-25EL74	25	1974	75ESR75-75ESLR75	75	1975	235TXL78	235	1978	RX-14	33	1966

Johnson Outboards 1960-1979			Johnson Outboards 1980 & Later			Johnson Outboards 1980 & Later			Johnson Outboards 1980 & Later		
MODEL NO.	HP	YEAR	MODEL NO.	HP	YEAR	MODEL NO.	HP	YEAR	MODEL NO.	HP	YEAR
RX-15	33	1967	4RCC-4RLCC	4	1988	8RCT-8RLCT	7.5	1983	15RCS-15RLCS	15	1980
RX-16	33	1968	4RCE-4RLCE	4	1989	8RCU-8RLCU	8	1987	15RCT-15RLCT	15	1983
RXE-11	28	1963	4RCU-4RLCU	4	1987	8RES-8RLES	8	1990	15RCU-15RLCU	15	1987
RXE-12	28	1964	4RDCD-4RDLCD	4	1986	8RLCC	8	1988	15RELES	15	1990
RXE-13	33	1965	4RDCO-4RDLO	4	1985	8RLCD	8	1986	15RES-15RLES	15	1990
RXE-14	33	1966	4RDCR-4RDLCR	4	1984	8SRLCN	7.5	1982	15SPCE-15SPLCE	15	1989
RXE-15	33	1967	4RDHCC-4RDHLCC	4	1988	8SRLCO	8	1985	15SPES-15SPLES	15	1990
RXE-16	33	1968	4RDHCD-4RDHLCD	4	1986	8SRLCR	8	1984	20BFCO-20BFLCO	20	1988
SC-10	1.5	1968	4RDHCE-4RDHLCE	4	1989	8SRLCT	7.5	1983	20BFCD-20BFLCD	20	1986
TR-10	55	1968	4RDHCO-4RDHLCO	4	1985	8SRLCU	8	1987	20BFCE-20BFLECE	20	1989
V4A-13	75	1961	4RDHCR-4RDHLCR	4	1984	10BACC-10BALCC	9.9	1988	20BFCCO-20BFCLCO	20	1985
V4A-14	75	1962-63	4RDHCU-4RDHLCU	4	1987	10BACD-10BALCD	9.9	1986	20BFCCR-20BFCLCR	20	1984
V4A-15	75	1962-63	4RDHES-4RDHLES	4	1990	10BACE-10BALCE	9.9	1989	20BFCCU-20BFCLCU	20	1987
V4A-16	75	1964	4RES-4RLES	4	1990	10BACO-10BALCO	9.9	1985	20BFTES-20BFLES	20	1990
V4A-17	75	1965	4RLCS	4	1980	10BACR-10BALCR	9.9	1984	20BICD-20BILCD	20	1986
V4A-18	80	1966	4WCI	4	1981	10BACU-10BALCU	9.9	1987	20BICR-20BILCR	20	1985
V4A-19	80	1967	4WCN	4	1982	10BAES-10BALES	9.9	1990	20BICR-20BILCR	20	1984
V4A-20	85	1968	4WCS	4	1980	10ECC-10ELCC	9.9	1988	20CRCC-20CRLCC	20	1988
V4H-16	75	1964	5BFCO-5BFLO	5	1986	10ECD-10ELCD	9.9	1986	20CRCD-20CRLCD	20	1986
V4H-17	75	1965	5BFCC-5BFCLC	5	1985	10ECE-10ELCE	9.9	1989	20CRCE-20CRLCE	20	1989
V4H-18	75	1966	5BFCCR-5BFCLCR	5	1984	10ECO-10ELCO	9.9	1985	20CRCN-20CRLCN	20	1982
V4M-10	90	1964	5BFCCU-5BFCLCU	5	1987	10ECS-10ELCS	9.9	1980	20CRCO-20CRLCO	20	1985
V4M-11	90	1965	5DRCC-5DRLCC	5	1988	10ECU-10ELCU	9.9	1987	20CRCR-20CRLCR	20	1984
V4ML-12	100	1966	5DRCE-5DRLECE	5	1989	10EES-10ELES	9.9	1990	20CRCT-20CRLCT	20	1983
V4S-12	75	1960	5DRES-5DRLES	5	1990	10ELCI	9.9	1981	20RCU-20RCLU	20	1987
V4S-13	75	1961	5RCI-5RLCI	4.5	1981	10ELCN	9.9	1982	20RCR-20RCLR	20	1990
V4S-14	75	1962	5RCN-5RLCN	4.5	1982	10ELCR	9.9	1984	20ECC-20ELCC	20	1988
V4S-15	75	1963	5RCS-5RLCS	4.5	1980	10RCC-10RLCC	9.9	1988	20ECD-20ELCD	20	1986
V4S-16	75	1964	5RCT-5RLCT	4.5	1983	10RCD-10RLCD	9.9	1986	20ECE-20ELCE	20	1989
V4S-17	75	1965	5RHCD	4.5	1986	10RCE-10RLCE	9.9	1989	20ECO-20ELCO	20	1985
V4S-18	80	1966	5RHCI-5RHLCI	4.5	1981	10RCI-10RLCI	9.9	1981	20ECU-20ELCU	20	1987
V4S-19	80	1967	5RHCN-5RHLCN	4.5	1982	10RCN-10RLCN	9.9	1982	20EES-20ELES	20	1990
V4S-20	85	1968	5RHCO	4.5	1985	10RCO-10RLCO	9.9	1985	20TECC-20TELCC	20	1988
V4T-13	100	1967	5RHCR	4.5	1984	10RCR-10RLCR	9.9	1984	20TECD	20	1986
V4T-14	100	1968	5RHCS-5RHCLS	4.5	1980	10RCS-10RLCS	9.9	1980	20TECE-20TELCE	20	1989
V4TL-13	100	1967	5RHCT-5RHCLT	4.5	1983	10RCT-10RLCT	9.9	1983	20TECU	20	1987
V4TL-14	100	1968	5RHCU	4.5	1987	10RCU-10RLCU	9.9	1987	20TEES-20TELES	20	1990
VX-10	60	1964	6BACC-6BALCC	6	1988	10RELES	9.9	1990	25BACC-25BALCC	25	1988
VX-11	60	1965	6BACD-6BALCD	6	1986	10RES-10RLES	9.9	1990	25BACD-25BALCD	25	1986
VX-12	60	1966	6BACE-6BALCE	6	1989	10SELCC	9.9	1988	25BACO-25BALCO	25	1985
VX-13	60	1967	6BACO-6BALCO	6	1985	10SELCD	9.9	1986	25BACR-25BALCR	25	1984
VX-14	65	1968	6BACR-6BALCR	6	1984	10SELCE	9.9	1989	25BACU-25BALCU	25	1987
VXH-10	60	1964	6BACU-6BALCU	6	1987	10SELCI	9.9	1981	25BECO-25BELCO	25	1986
VXH-11	60	1965	6BAES-6BALES	6	1989	10SELGN	9.9	1982	25BECO-25BELCO	25	1985
VXH-12	60	1966	6BFCD-6BFLO	6	1986	10SELCO	9.9	1985	25BECR-25BELCR	25	1984
VXH-13	60	1967	6BFCCO-6BFCLCO	6	1985	10SELCR	9.9	1984	25BFCD-25BFLCD	25	1986
VXH-14	65	1968	6BFCCR-6BFCLCR	6	1984	10SELCS	9.9	1980	25BFCCO-25BFCLCO	25	1985
			6BFCCU-6BFCLCU	6	1987	10SELCT	9.9	1983	25BFCCR-25BFCLCR	25	1984
			6DRCC-6DRLCC	6	1988	10SELCU	9.9	1987	25DECE-25DELCE	25	1989
			6DRCE-6DRLECE	6	1989	10SELES	9.9	1990	25DEES-25DELES	25	1990
			6DRES-6DRLES	6	1990	10SPCC-10SPGCC	9.9	1988	25DRCE-25DRLECE	25	1989
			6RCC-6RLCC	6	1988	10SPCE-10SPGCE	9.9	1989	25DRES-25DRLES	25	1990
			6RCD-6RLCD	6	1986	10SPES-10SPLES	9.9	1990	25DTLCE	25	1989
			6RCE-6RLCE	6	1989	14RCC	14	1988	25DTLES	25	1990
			6RCO-6RLCO	6	1985	14RCE	14	1989	25ECC-25ELCC	25	1988
			6RCR-6RLCR	6	1984	15BACC-15BALCC	15	1988	25ECD-25ELCD	25	1986
			6RCU-6RLCU	6	1987	15BACD-15BALCD	15	1986	25ECE-25ELCE	25	1989
			6RES-6RLES	6	1990	15BACE-15BALCE	15	1989	25ECI-25ELCI	25	1981
			6SLCC	6	1988	15BACO-15BALCO	15	1985	25ECN-25ELCN	25	1982
			6SLCD	6	1986	15BACR-15BALCR	15	1984	25ECO-25ELCO	25	1985
			6SLCE	6	1989	15BACU-15BALCU	15	1987	25ECC-25ELCC	25	1988
			6SLCO	6	1985	15BAES-15BALES	15	1990	25ECC-25ELCC	25	1987
			6SLCR	6	1984	15ECC-15ELCC	15	1988	25EES-25ELES	25	1990
			6SLCU	6	1987	15ECD-15ELCD	15	1986	25IECC-25IELCC	25	1988
			6SLES	6	1990	15ECE-15ELCE	15	1989	25IECE-25IELCE	25	1989
			8BACC-8BALCC	8	1988	15ECI	15	1981	25IECU-25IELCU	25	1987
			8BACD-8BALCD	8	1986	15ECN	15	1982	25IECU-25IELCU	25	1987
			8BACE-8BALCE	8	1989	15ECO-15ELCO	15	1985	25IEES-25IELES	25	1990
			8BACO-8BALCO	8	1985	15ECCR-15ELCR	15	1984	25IES-25IRLES	25	1990
			8BACR-8BALCR	8	1984	15ECS-15ELCS	15	1980	25IRCC-25IRLCC	25	1988
			8BACU-8BALCU	8	1987	15ECT-15ELCT	15	1983	25IRCU-25IRLCU	25	1987
			8BAES-8BALES	8	1990	15ECU-15ELCU	15	1987	25RACC-25RALCC	25	1988
			8RCC-8RLCC	8	1988	15EES-15ELES	15	1990	25RACD-25RALCD	25	1986
			8RCD-8RLCD	8	1986	15RCC-15RLCC	15	1988	25RACE-25RALCE	25	1989
			8RCE-8RLCE	8	1989	15RCD-15RLCD	15	1986	25RACU-25RALCU	25	1987
			8RCI-8RLCI	7.5	1981	15RCE-15RLCE	15	1989	25RAES-25RALES	25	1990
			8RCN-8RLCN	7.5	1982	15RCI-15RLCI	15	1981	25RCC-25RLCC	25	1988
			8RCO-8RLCO	8	1985	15RCN-15RLCN	15	1982	25RCD-25RLCD	25	1986
			8RCR-8RLCR	8	1984	15RCO-15RLCO	15	1985	25RCC-25RLCC	25	1988
			8RCS-8RLCS	7.5	1980	15RCR-15RLCR	15	1984	25RCD-25RLCD	25	1986

Johnson Outboards 1980 & Later		
2RCI	2	1981
2RCN	2	1982
2RCO	2	1985
2RCR	2	1984
2RCS	2	1980
2RCT	2	1983
3BRC	3	1989
3BRE	3	1990
3RCC	2.5	1988
3RCU	2.5	1987
4BRCC-4BLRCC	4	1988
4BRCD-4BRLCD	4	1986
4BRCI-4BRLCI	4	1981
4BRCN-4BRLCN	4	1982
4BRCO-4BRLCO	4	1985
4BRCR-4BRLCR	4	1984
4BRCT-4BRLCT	4	1983
4BRCU-4BRLCU	4	1987
4BRES-4BRLES	4	1990
4BRHCC-4BRHLCC	4	1988
4BRHCD-4BRHLCD	4	1986
4BRHCE-4BRHLCE	4	1989
4BRHCI-4BRHLCI	4	1981
4BRHCN-4BRHLCN	4	1982
4BRHCO-4BRHLCO	4	1985
4BRHCR-4BRHLCR	4	1984
4BRHCT-4BRHLCT	4	1983
4BRHCU-4BRLCU	4	1987
4BRHES-4BRHLES	4	1990

Johnson Outboards 1980 & Later			Johnson Outboards 1980 & Later			Johnson Outboards 1980 & Later			Johnson Outboards 1980 & Later		
MODEL NO.	HP	YEAR	MODEL NO.	HP	YEAR	MODEL NO.	HP	YEAR	MODEL NO.	HP	YEAR
25RCI-25RLCI	25	1981	35RCU-35RLCU	35	1987	60ELCD	60	1986	100MLCS	100	1980
25RCN-25RLCN	25	1982	35RELC	35	1983	60ELCE	60	1989	100SLES	100	1980
25RCO-25RLCO	25	1985	35RES-35RELES	35	1990	60ELCU	60	1987	100STLCC	100	1988
25RCR-25RLCR	25	1984	35TELCN	35	1982	60ELES	60	1990	100STLCE	100	1989
25RCS-25RLCS	25	1980	35TELCR	35	1984	60TLCC	60	1988	100STLES	100	1990
25RCT-25RLCT	25	1983	40AELCC	40	1988	60TLCD	60	1986	100TLCS	100	1980
25RCU-25RLCU	25	1987	40ARLCC	40	1988	60TLCE	60	1989	100TXCS	100	1980
25RES-25RLES	25	1990	40ATLCC	40	1988	60TLCI	60	1981	110MLCC	110	1988
25SECC-25SELCC	25	1988	40BACC-40BALCC	40	1988	60TLCN	60	1982	110MLCD	110	1986
25SECE-25SELCE	25	1989	40BACD-40BALCD	40	1986	60TLCO	60	1985	110MLCE	110	1989
25SEES-25SELES	25	1990	40BACE-40BALCE	40	1989	60TLCR	60	1984	110MLCU	110	1987
25SRCC-25SRGCC	25	1988	40BACO-40BALCO	40	1985	60TLCT	60	1983	110TLAE	110	1989
25SRCE-25SRCE	25	1989	40BACU-40BALCU	40	1987	60TLCU	60	1987	110TLCC-110TXCC	110	1988
25SRCS-25SRCS	25	1990	40BAES-40BALES	40	1990	60TLCS	60	1990	110TLCD	110	1986
25TECC-25TELCC	25	1988	40ECC-40ELCC	40	1988	60TLCE	60	1989	110TLCE-110TXCE	110	1989
25TECD-25TELCD	25	1986	40ECD-40ELCD	40	1986	60TLCS	60	1990	110TLCU-110TXCU	110	1987
25TECE-25TELCE	25	1989	40ECE-40ELCE	40	1989	60TLCC	60	1988	115MLCI	115	1981
25TECI-25TELCI	25	1981	40ECC-40ELCC	40	1988	70ELCC	70	1988	115MLCN	115	1982
25TECN-25TELCN	25	1982	40ECC-40ELCC	40	1988	70ELCD	70	1986	115MLCO	115	1985
25TECO-25TELCO	25	1985	40ECC-40ELCC	40	1988	70ELCE	70	1989	115MLCR	115	1984
25TECR-25TELCR	25	1984	40EES-40ELES	40	1990	70ELCI	70	1981	115MLCS	115	1980
25TECS-25TELCS	25	1980	40RCC-40RLCC	40	1988	70ELCN	70	1982	115MLCT	115	1983
25TECT-25TELCT	25	1983	40RCD-40RLCD	40	1986	70ELCO	70	1985	115MLES	115	1990
25TECU-25TELCU	25	1987	40RCE-40RLCE	40	1989	70ELCR	70	1984	115TLCI-115TXCI	115	1981
25TEES-25TELES	25	1990	40RCO-40RLCO	40	1985	70ELCS	70	1980	115TLCN-115TXCN	115	1982
28ELCD	28	1986	40RCU-40RLCU	40	1987	70ELCT	70	1983	115TLCO	115	1985
28ESLCC	28	1988	40RES-40RLES	40	1990	70ELCU	70	1987	115TLCR-115TXCR	115	1984
28ESLCE	28	1989	40TECC-40TELCC	40	1988	70ELES	70	1990	115TLCS-115TXCS	115	1980
28ESLCU	28	1987	40TECD-40TELCD	40	1986	70TLCC	70	1988	115TLCT-115TXCT	115	1983
28ESLES	28	1990	40TECE-40TELCE	40	1989	70TLCD	70	1986	115TLCS-115TXCS	115	1990
30BACC-30BALCC	30	1988	40TECO-40TELCO	40	1985	70TLCE	70	1989	120TLAE	120	1989
30BACD-30BALCD	30	1986	40TECR-40TELCR	40	1984	70TLCI	70	1981	120TLAS	120	1990
30BACO-30BALCO	30	1985	40TECU-40TELCU	40	1987	70TLCN	70	1982	120TLCC-120TXCC	120	1988
30BACU-30BALCU	30	1987	40TEES-40TELES	40	1990	70TLCO	70	1985	120TLCD-120TXCD	120	1986
30BAES-30BALES	30	1990	40TLCC	40	1988	70TLCR	70	1984	120TLCE-120TXCE	120	1989
30ECC-30ELCC	30	1988	40TLCD	40	1986	70TLCT	70	1983	120TLCO-120TXCO	120	1985
30ECC-30ELCC	30	1986	40TLCE	40	1989	70TLCS	70	1990	120TLCU-120TXCU	120	1987
30ECE-30ELCE	30	1989	40TLCE	40	1987	75ECC	75	1988	120TLCS-120TXCS	120	1990
30ECO-30ELCO	30	1985	40TLCS	40	1990	75ECD	75	1986	140CXCC	140	1988
30ECCR-30ELCCR	30	1984	40TLCC	40	1988	75ECO	75	1985	140CXCE	140	1989
30ECU-30ELCU	30	1987	40TLCE	40	1989	75ECC	75	1984	140CXES	140	1990
30EES-30ELES	30	1990	40TLCS	40	1990	75ECU	75	1987	140MLCI	140	1981
30RCC-30RLCC	30	1988	48ESLCC	48	1988	75ELCO	75	1985	140MLCN	140	1982
30RCD-30RLCD	30	1986	48ESLCE	48	1989	75ELCR	75	1984	140MLCR	140	1984
30RCE-30RLCE	30	1989	48ESLCU	48	1987	75ERCI-75ERLCI	75	1981	140MLCS	140	1980
30RCO-30RLCO	30	1985	48ESLES	48	1990	75ERCN-75ERLCN	75	1982	140MLCT	140	1983
30RCU-30RLCU	30	1987	50BECC-50BELCC	50	1988	75ERCS-75ERLCS	75	1980	140TLAE	140	1989
30RES-30RLES	30	1990	50BECD-50BELCD	50	1986	75ERCT-75ERLCT	75	1983	140TLAS	140	1990
30TECC-30TELCC	30	1988	50BECE-50BELCE	50	1989	75TLCO	75	1985	140TLCC-140TXCC	140	1988
30TECD-30TELCD	30	1986	50BECI-50BELCI	50	1981	75TLCR	75	1984	140TLCE-140TXCE	140	1989
30TECE-30TELCE	30	1989	50BECN-50BELCN	50	1982	75TLCI	75	1981	140TLCO-140TXCO	140	1985
30TECO-30TELCO	30	1985	50BECC-50BELCC	50	1985	75TLCS	75	1980	140TLCR-140TXCR	140	1984
30TECU-30TELCU	30	1987	50BECC-50BELCC	50	1984	75TLCT	75	1983	140TLCU-140TXCU	140	1987
30TEES-30TELES	30	1990	50BECS-50BELCS	50	1980	85MLCS	85	1980	140TLCS-140TXCS	140	1990
35AEC-35AELC	35	1986	50BECT-50BELCT	50	1983	85TLCS-85TXCS	85	1980	140TLCI-140TXCI	140	1981
35AELCU	35	1987	50BECC-50BELCC	50	1987	88MSLCC	88	1988	140TLCN-140TXCN	140	1982
35ARCD-35ARLCD	35	1986	50BEES-50BELES	50	1990	88MSLCE	88	1989	140TLCS-140TXCS	140	1980
35ARLCU	35	1987	50ECS-50ELCS	50	1990	88MSLCU	88	1987	140TLCT-140TXCT	140	1983
35ATECD-35ATELCD	35	1986	50TECC	50	1988	88MSLES	88	1990	150ANCO	150	1985
35ATECU-35ATELCU	35	1987	50TELCD	50	1986	90MLCC	90	1988	150CXCC	150	1988
35ATLCU	35	1987	50TELCE	50	1989	90MLCD	90	1986	150CXCE	150	1989
35BACI-35BALCI	35	1981	50TELCO	50	1985	90MLCE	90	1989	150CXES	150	1990
35BACN-35BALCN	35	1982	50TELCR	50	1984	90MLCI	90	1981	150GTLCU	150	1987
35BACR-35BALCR	35	1984	50TELC	50	1983	90MLCN	90	1982	150SLCE	150	1989
35BACS-35BALCS	35	1980	50TELCU	50	1987	90MLCO	90	1985	150SLES	150	1990
35BACT-35BALCT	35	1983	50TELES	50	1990	90MLCR	90	1984	150STLCC	150	1988
35ECI-35ELCI	35	1981	50TLCC	50	1988	90MLCT	90	1980	150STLCD	150	1986
35ECN-35ELCN	35	1982	50TLCD	50	1986	90MLCU	90	1987	150STLCE	150	1989
35ECCR-35ELCCR	35	1984	50TLCE	50	1989	90TLAE	90	1990	150STLCO	150	1985
35ECS-35ELCS	35	1980	50TLCO	50	1985	90TLAS	90	1989	150STLCR	150	1984
35ECT-35ELCT	35	1983	50TLCR	50	1984	90TLCC-90TXCC	90	1988	150STLCT	150	1983
35RCC-35RLCC	35	1988	50TLCU	50	1987	90TLCD-90TXCD	90	1986	150STLCU	150	1987
35RCD-35RLCD	35	1986	50TLCS	50	1990	90TLCE-90TXCE	90	1989	150STLES	150	1990
35RCE-35RLCE	35	1989	60ECI-60ELCI	60	1981	90TLCI-90TXCI	90	1981	150TLAE	150	1989
35RCI-35RLCI	35	1981	60ECN-60ELCN	60	1982	90TLCN-90TXCN	90	1982	150TLAS	150	1990
35RCN-35RLCN	35	1982	60ECO-60ELCO	60	1985	90TLCO-90TXCO	90	1985	150TLCC-150TXCC	150	1988
35RCO-35RLCO	35	1985	60ECR-60ELCR	60	1984	90TLCR-90TXCR	90	1984	150TLCD-150TXCD	150	1986
35RCR-35RLCR	35	1984	60ECS-60ELCS	60	1980	90TLCT-90TXCT	90	1983	150TLCE-150TXCE	150	1989
35RCS-35RLCS	35	1980	60ECT-60ELCT	60	1983	90TLCU	90	1987	150TLCO-150TXCO	150	1985
35RCT-35RLCT	35	1983	60ELCC	60	1988	90TLCS-90TXCS	90	1990	150TLCR-150TXCR	150	1984

Johnson Outboards 1980 & Later			Johnson Outboards 1980 & Later			Johnson Evinrude Commercial			Johnson Evinrude Commercial		
MODEL NO.	HP	YEAR	MODEL NO.	HP	YEAR	MODEL NO.	HP	YEAR	MODEL NO.	HP	YEAR
150TLCU-150TXCU	150	1987	300CXES	300	1990	10RSC-M	10	1983	25RWA-25RWLA	25	1988
150TLES-150TXES	150	1990	300PLCC-300PXCC	300	1988	10RSD-10RSLD	10	1985	25RWCD-25RWLCD	25	1986
150TRLCI-150TRXCI	150	1981	300PLCE-300PXCE	300	1989	10RSE-10RSE	10	1987	25RWCI-25RWLCI	25	1981
150TRLCN-150TRXCN	150	1982	300PLCU-300PXC	300	1987	10RSG-2-10RSLG-2	10	1981	25RWCN-25RWLCN	25	1982
150TRLCS-150TRXCS	150	1980	300PLES-300PXES	300	1990	10RSJ-10RSLJ	10	1989	25RWCO-25RWLCO	25	1985
150TRLCT-150TRXCT	150	1983	300PTLC-300PTXCD	300	1986	10RSLC-M	10	1983	25RWCR-25RWLCR	25	1984
175STLAC	175	1988	300TLCO-300TXCO	300	1985	10RSN-10RSLN	10	1990	25RWCT-25RWLCT	25	1983
175STLCC	175	1988	C-275TLCO	275	1985	10RSR-10RSLR	10	1986	25RWCU-25RWLUC	25	1987
175STLCE	175	1990	C-275TXCO	275	1985	10RSU-10RSLU	10	1988	25RWES-25RWLES	25	1990
175TLCC-175TXCC	175	1988	C-300TLCO	300	1985	10RSW-10RSLW	10	1982	25RWK-25RWLK	25	1989
175TLCD-175TXCD	175	1986	C-300TXCO	300	1985	10RSY-M	10	1983	35RSP-35RSLP	35	1981
175TLCE-175TXCE	175	1989	C-E275PTLCD	275	1986	10RSYD	10	1985	40R78B-40RL78B	40	1978
175TLCO-175TXCO	175	1985	C-E275PTXCD	275	1986	10RSYR	10	1986	40R79E-40RL79E	40	1979
175TLCU-175TXCU	175	1987	C-E300PTLCD	300	1986	10RSYZ	10	1984	40RCA-40RCLA	40	1989
175TLES-175TXES	175	1990	C-E300PTXCD	300	1986	10RSZ-10RSLZ	10	1984	40RCB-40RCLB	40	1986
175TRLCI-175TRXCI	175	1981	CO-CC	1.2	1988	11KCA-11KCLA	11	1983	40RCH-40RCLH	40	1985
175TRLCN-175TRXCN	175	1982	CO-CD	1.2	1986	11KCG-11KCLG	11	1985	40RCK-40RCLK	40	1990
175TRLCS-175TRXCS	175	1980	CO-CE	1.2	1990	11KCS-11KCLS	11	1984	40RCP-40RCLP	40	1984
175TRLCT-175TRXCT	175	1983	CO-CU	1.2	1987	11KCW-11KCLW	11	1986	40RCT-40RCLT	40	1987
185ESXES	185	1990	CO-ES	1.2	1990	11KSLW-11KSYW	11	1986	40RCY-40RCLY	40	1983
185ESXW	185	1989	JR-CC	1.2	1988	12K79S	12	1979	40RCY-40RCLY	40	1988
185TLCO-185TXCO	185	1985	JR-CD	1.2	1986	12KCCSC	12	1980	40RCYA	40	1989
185TLCR-185TXCR	185	1984	JR-CE	1.2	1989	12KCLCSC	12	1980	40RCYB	40	1986
200CXCE	200	1989	JR-CU	1.2	1987	12KXCSC	12	1980	40RCYH	40	1985
200CXES	200	1990	JR-ES	1.2	1990	12KXL79S	12	1979	40RCYK	40	1990
200SLES	200	1990	KT-11C	15A	1987	12L79S	12	1979	40RCYP	40	1984
200STLAC	200	1988	KT-12R	15A	1988	12R78S	12	1978	40RCYT	40	1987
200STLCC	200	1988	KT-13A	15A	1989	12RL78S	12	1978	40RCYV	40	1983
200STLCD	200	1986	KT-14M	15A	1990	12RL79C-R	12	1979	40RCYY	40	1988
200STLCE	200	1989	RTE-11C	45SS	1987	12RSCSA	12	1980	40RSCSD	40	1980
200STLCO	200	1987	RTE-12R	45SS	1988	12RSLCSA	12	1980	40RSD-R	40	1981
200STLES	200	1990	RTE-13A	45SS	1989	12RSXCSA	12	1980	40RSLCSD	40	1980
200TLCT-200TRXCT	200	1983	RTE-14M	45SS	1990	12RXL78S	12	1978	40RSLD-R	40	1981
200TRLCI-200TRXCI	200	1981	STE-13A	SST-60	1989	12RXL79R	12	1979	40RSR-40RSLR	40	1982
200TRLCN-200TRXCN	200	1982	STE-14M	SST-60	1990	14RSB-14RSLB	14	1990	40RWCD-40RWLCD	40	1986
200TRLCS-200TRXCS	200	1980	Johnson Evinrude Commercial			14RSE-14RSE	14	1982	40RWCI-40RWLCI	40	1981
200TXCC	200	1988				14RSF-14RSLF	14	1985	40RWCN-40RWLCN	40	1982
200TXCD	200	1986	14RSH-14RSLH	14	1989	40RWCO-40RWLCO	40	1985			
200TXCE	200	1989	14RSLR-2	14	1981	40RWCR-40RWLCR	40	1984			
200TXCU	200	1987	14RSLU-J	14	1983	40RWCT-40RWLCT	40	1983			
200TXES	200	1990	14RSN-14RSLN	14	1984	45RCCD-45RCLCD	45	1986			
225CLCU-225CXCU	225	1987	14RSP-14RSLP	14	1988	45RCCU-45RCLCU	45	1987			
225CXCC	225	1988	14RSQ-14RSLQ	14	1986	45RCE-45RCLE	45	1989			
225CXCE	225	1989	14RSR-2	14	1981	45RCR-45RCLR	45	1988			
225CXES	225	1990	14RSU-J	14	1983	45RSD-45RSLD	45	1986			
225PLAE	225	1989	14RSV-14RSLV	14	1987	45RSE-45RSE	45	1988			
225PLAS	225	1990	14RSYF	14	1985	45RSJ-45RSLJ	45	1990			
225PLCC-225PXCC	225	1988	14RSYN	14	1984	45RSR-45RSLR	45	1987			
225PLCU-225PXCU	225	1987	14RSYQ	14	1986	45RSU-45RSLU	45	1989			
225PLES-225PXES	225	1990	14RSYU-J	14	1983	45RSYD	45	1986			
225PLES-225PXES	225	1990	15RSH-B	15	1983	45RSYE	45	1988			
225PTLC-225PTXCD	225	1986	15RSLH-B	15	1983	45RSYJ	45	1990			
225SCXES	225	1990	15RSP-15RSLP	15	1982	45RSYR	45	1987			
225SLES	225	1990	23R79C-R	12	1979	45RSYU	45	1989			
225STLES	225	1990	25KCG-25KCLG	25	1986	45RSYZ	45	1985			
225TLAE	225	1989	25KCS-25KCLS	25	1985	45RSZ-45RSLZ	45	1985			
225TLAS	225	1990	25KCV-25KCLV	25	1987	45RWD-45RWLD	45	1986			
225TLCC-225TXCC	225	1988	25RPB-25RPLB	25	1984	45RWLE-45RWLE	45	1988			
225TLCD-225TXCD	225	1986	25RPD	25	1989	45RWLJ-45RWYJ	45	1990			
225TLCE-225TXCE	225	1989	25RPH-25RPLH	25	1982	45RWLR-45RWYR	45	1987			
225TLCO-225TXCO	225	1987	25RPL	25	1990	45RWLU-45RWYU	45	1989			
225TLES-225TXES	225	1990	25RS78C-25RSL78C	25	1978	45RWYD	45	1986			
235STLCO	235	1985	25RS79R-25RSL79R	25	1979	45RWZ-45RWLZ	45	1985			
235STLCR	235	1984	25RSA-25RSLA	25	1981	45WMLE	45	1989			
235STLCT	235	1983	25RSC-25RSLC	25	1986	45WMLES	45	1990			
235TLCO-235TXCO	235	1985	25RSCSA-25RSLCSA	25	1980	50RS78C-G	50	1978			
235TLCR-235TXCR	235	1984	25RSG-2-25RSLG-2	25	1984	50RS79R-50RSL79R	50	1979			
235TRLCI-235TRXCI	235	1981	25RSK-25RSLK	25	1982	50RSL78C-G	50	1978			
235TRLCN-235TRXCN	235	1982	25RSM-25RSLM	25	1987	55AWQ-55AWLQ	55	1985			
235TRLCS-235TRXCS	235	1980	25RSR-25RSLR	25	1990	55RCI-55RSLC	55	1981			
235TRLCT-235TRXCT	235	1983	25RSS-25RSLS	25	1983	55RCN-55RSLCN	55	1982			
275CLCU-275CXCU	275	1987	25RSW-25RSLW	25	1985	55RCT-55RSLCT	55	1983			
275CXCC	275	1988	25RSY	25	1986	55RLCS	55	1980			
275PLCC-275PXCC	275	1988	25RSYD	25	1989	55RSB-55RSLB	55	1989			
275PLCU-275PXCU	275	1987	25RSY-2	25	1984	55RSCS-55RSLCS	55	1980			
275PTLC-275PTXCD	275	1986	25RSYF	25	1987	55RSF-55RSLF	55	1984			
275TLCO-275TXCO	275	1985	25RSYR	25	1983	55RSH-55RSLH	55	1988			
300CLCUR-300CXCU	300	1987	25RSYU	25	1985	55RSJ-55RSLJ	55	1982			
300CXCC	300	1988	25RSYZ	25	1988	55RSN-55RSLN	55	1983			
300CXCE	300	1989	25RSZ-25RSLZ	25	1988	55RSP-55RSLP	55	1987			

Johnson Evinrude Commercial			Johnson Evinrude Commercial			McCulloch Outboard			McCulloch Outboard			
MODEL NO.	HP	YEAR	MODEL NO.	HP	YEAR	MODEL NO.	HP	YEAR	MODEL NO.	HP	YEAR	
55RSQ-55RSLQ	55	1985	125WPLG-125WTPXG	125	1988	80355	7.5	1966-68	65302810	28	1965	
55RST-55RSLT	55	1990	125WTPLS-125WTPXS	125	1987	80370	14	1966-67	65302830	28	1965	
55RSU-55RSLU	55	1981	125WTPWL-125WTPXW	125	1989	80373	14	1966-67	65304510	45	1965	
55RSV-55RSLV	55	1986	155WWTALA	155	1990	80378	45	1966-69	65304511	45	1965	
55RSYB	55	1989	155WWTALY	155	1989	80382	45	1966-69	65304520	45	1965	
55RSYF	55	1984	155WTLCD-155WTXCD	155	1986	80386	45	1966-67	65304521	45	1965	
55RSYH	55	1988	155WTLCO-155WTXCO	155	1985	80450	75	1966-68	65304530	45	1965	
55RSYN	55	1983	155WTLCR-155WTXCR	155	1984	80454	75	1966-68	65304531	45	1965	
55RSYV	55	1987	155WTLCU-155WTXCU	155	1987	80914	28	1966-67	65304540	45	1965	
55RSYQ	55	1985	155WTLCS-155WTXCS	155	1990	80915	28	1966-67	65304541	45	1965	
55RSYT	55	1990	155WTLTM-155WXTM	155	1988	80916	45	1966-67	65307530	75	1965	
55RSYV	55	1986	155WTLTLZ-155WXTXZ	155	1989	81605	7.5	1968	65307531	75	1965	
55RWCR-55RWLCR	55	1984	155WTPLA-155WTPXA	155	1990	81635	7.5	1969	65307540	75	1965	
55RWLCD	55	1986	155WTPLB-155WTPXB	155	1987	81660	9	1967-69	661301210-20	14	1961	
55RWLCO	55	1985	155WTPPLH-155WTPXH	155	1986	81680	9	1967-69	Mercury Outboard			
55RWLCU	55	1987	155WTPPLP-155WTPXP	155	1985	81700	9	1967-69				
55RWLE	55	1989	155WTPPLT-155WTPXT	155	1988	81710	4	1966-68	HP	CYL	BEG.S/N	YEAR
55RWLES	55	1990	155WTPPLV-155WTPXV	155	1984	6530310	3.5	1965	2.2	1	8075603	1984
55RWLR	55	1988	155WTPPLY-155WTPXY	155	1989	6530710	7.5	1965	2.2	1	8087123	1985
65RELCR	65	1984	200WTPLV-200WTPXV	200	1990	6530720	7.5	1965	2.2	1	A800761	1986
65RSLA-65RSYA	65	1990	6834B	6	1978	6530750	7.5	1965	2.2	1	A805221	1987
65RSLB-65RSYB	65	1987	6835B	6	1978	6530760	7.5	1965	2.2	1	A817421	1988
65RSLH	65	1986	6912S	6	1979	10700305C	4	1969	2.2	1	A837101	1989
65RSLP-65RSYP	65	1985	6913S	6	1979	10700325D	7.5	1969	2.2	1	A855097	1990
65RSLT-65RSYT	65	1988	6934E	6	1979	10700395D	7.5	1969	3	1	A855097	1990
65RSLV-65RSYV	65	1984	6935E	6	1979	10800305C	4	1969	3.4 L	6	6436883	1984
65RSLY-65RSYY	65	1989	9800S	9	1978	10800395D	7.5	1969	3.4 L	6	A129445	1985
65RWLCD	65	1986	9802S	9	1978	61300310	3.6	1961	3.4 L	6	A912426	1986
65RWLCO	65	1985	9803S	9	1978	61300610-710	7.5	1961	3.5	1	6202173	1983
65RWLCR	65	1984	9900R	9	1979	61302510-20	27	1961	3.5	1	6434771	1984
65TELCD	65	1986	9901S	9	1979	61302530-40	27	1961	3.5	1	6594744	1985
65TELCO	65	1985	9902C-R	9	1979	61304010-11	43	1961	3.6	1	5404657	1980-81
65WMLA-65WMYA	65	1990	9903C-R	9	1979	61304020-21	43	1961	3.6	1	5910968	1982
65WMLB-65WMYB	65	1987	9912S	9	1979	61304030-31	43	1961	3.9	1	1655013	1964
65WMLCD	65	1986	9913S	9	1979	61304040-41	43	1961	3.9	1	1738941	1965
65WMLCO	65	1985	12800S	12	1978	61304050-51	43	1961	3.9	1	1865633	1966
65WMLCU	65	1987	12802S	12	1978	61307030-40	75	1961	3.9	1	2098037	1967
65WMLC	65	1986	12803S	12	1978	61307050-70	75	1961	3.9	1	2278851	1968
65WMLM	65	1986	12900R	12	1979	61307080-90	75	1961	4	1	2498136	1969
65WMLM	65	1988	12902C-R	12	1979	62300310	3.6	1962	4	1	2771662	1970
65WMLP-65WMYP	65	1985	12903C-R	12	1979	62300610-710	7.5	1962	4	1	3028361	1971
65WMLT-65WMYT	65	1988	12910S	12	1979	62301410-20	14	1962	4	1	3296137	1972
65WMLY-65WMYT	65	1989	12912S	12	1979	62302810-20	27	1962	4	1	3529446	1973
65WMLZ	65	1990	12913S	12	1979	62302830-40	27	1962	4	1	3764825	1974
65WTLCO	65	1985	25832C	25	1978	62304411-21	43	1962	4	2	5589202	1980-81
65WTLCR	65	1984	25833C	25	1978	62304431-41	43	1962	4	2	9075839	1976
100TEMLH-100TEMXH	100	1986	25932R	25	1979	62304450-60	43	1962	4	2	9172806	1978
100WMLCD	100	1986	25933R	25	1979	62304450-60	43	1962	4	1	A818721	1988
100WMLCO	100	1985	40804B	40	1978	62307030-40	75	1962	4	1	A837101	1989
100WMLCR	100	1984	40805B	40	1978	62307530-40	75	1962	4	1	A855097	1990
100WMPLA	100	1990	40904E	40	1979	63104060-61	43	1961	4	1	A906702	1986
100WMPLB	100	1987	40905E	40	1979	63300311	3.5	1963	4	1	B114109	1987
100WMPLH	100	1986	50832C-G	50	1978	63300411	3.5	1963	4.5	1	4108120	1975
100WMPLP	100	1985	50833C-G	50	1978	63300711	7.5	1963	4.5	1	4377557	1976
100WMPLT	100	1988	50932R	50	1979	63300712	7.5	1963	4.5	1	4597262	1977
100WMPLV	100	1984	50933R	50	1979	63301411	14	1963	4.5	1	4869518	1978
100WMPY	100	1989	McCulloch Outboard			63301412	14	1963	4.5	1	5270784	1979
100WTLCD-100WTXCD	100	1986				63302811	28	1963	63301412	14	1963	4.5
100WTLCO	100	1985	63302821	28	1963	63302811	28	1963	4.5	1	6025119	1982
100WTLCR	100	1984	63302831	28	1963	63302821	28	1963	4.5	1	6232381	1983
100WTLCU-100WTXCU	100	1987	63302841	28	1963	63302831	28	1963	4.5	1	6428076	1984
100WTLCS-100WTXCS	100	1990	63304511	45	1963	63302841	28	1963	4.5	1	6608536	1985
100WTLTM-100WTM	100	1988	63304521	45	1963	63304511	45	1963	5	1	A819951	1988
100WTLTLZ-100WXTXZ	100	1989	63304531	45	1963	63304521	45	1963	5	1	A837101	1989
100WTPLA	100	1990	63304541	45	1963	63304531	45	1963	5	1	A855097	1990
100WTPLB	100	1987	63307531	75	1963	63304541	45	1963	6	2	1408611	1961
100WTPLH	100	1986	63307541	75	1963	63307531	75	1963	6	2	1485612	1962
100WTPLP	100	1985	63507541	75	1965	63307541	75	1963	6	2	1551443	1963
100WTPLT	100	1988	64300310	3.5	1964	63507541	75	1965	6	2	1607513	1964
100WTPLV	100	1984	64300710	7.5	1964	64300310	3.5	1964	6	2	1745521	1965
100WTPY	100	1989	64300720	7.5	1964	64300710	7.5	1964	6	2	1958278	1966
125ESXES	125	1990	64301410	14	1964	64300720	7.5	1964	6	2	2096171	1967
125ESXW	125	1989	64301420	14	1964	64301410	14	1964	6	2	2284857	1968
125RWLC-125RWYC	125	1990	64302810	28	1964	64301420	14	1964	6	2	A910596	1986
125RWLG-125RWXG	125	1988	64302820	28	1964	64302810	28	1964	6	2	B114231	1987
125RWLS-125RWXS	125	1987	64304510	45	1964	64302830	28	1964	6	2	B233200	1988
125RWLW-125RWYW	125	1989	64304530	45	1964	64304510	45	1964	7.5	2	B385500	1989
125RWYWG	125	1988	64304540	45	1964	64304530	45	1964	7.5	2	2529895	1969
125RWYS	125	1987	78500	4	1966-67	64304540	45	1964	7.5	2	2810637	1970
125WTPLC-125WTPXC	125	1990	80000	7.5	1966-67	64307530	75	1964	7.5	2	3016581	1971
			80351	7.5	1966-67	65301410	14	1965	7.5	2	3274633	1972
						65301420	14	1965	7.5	2	3488153	1973
									7.5	2	3801458	1974

Mercury Outboard				Mercury Outboard				Mercury Outboard				Mercury Outboard			
HP	CYL	BEG./S/N	YEAR	HP	CYL	BEG./S/N	YEAR	HP	CYL	BEG./S/N	YEAR	HP	CYL	BEG./S/N	YEAR
7.5	2	4087015	1975	25	2	6593849	1985	65	4	2119749	1967	115	6	4112635	1975
7.5	2	4314385	1976	25	2	A911346	1986	65	4	2309311	1968	115	6	4310785	1976
7.5	2	4691222	1977	25	2	B114231	1987	65	4	2503991	1969	115	6	4567952	1977
7.5	2	4851693	1978	25	2	B238464	1988	65	4	2803562	1970	115	6	4855153	1978
7.5	2	5226935	1979	25	2	B385500	1989	65	4	2997339	1971	115	6	5168574	1979
7.5	2	5524660	1980-81	25	2	C221500	1990	65	3	3293184	1972	115	6	5600967	1980-81
7.5	2	5936301	1982	35	4	1570507	1963	65	3	3547987	1973	115	6	6006834	1982
7.5	2	6239857	1983	35	2	1628795	1964	65	3	3807833	1974	115	6	6262961	1983
7.5	2	6430041	1984	35	2	1755799	1965	65	3	4136685	1975	115	6	6440183	1984
7.5	2	6611886	1985	35	2	1960827	1966	65	3	4382057	1976	115	6	6630171	1985
8	2	A197112	1986	35	2	2097800	1967	70	3	1296411	1960	115	6	A907777	1986
8	2	B114231	1987	35	2	2300972	1968	70	3	1413611	1961	115	6	B117567	1987
8	2	B233200	1988	35	2	2487558	1969	70	3	1503459	1962	115	6	B239242	1988
8	2	B385500	1989	35	2	6445653	1984	70	3	4382057	1976	115	4	C100000	1989
8	2	C221500	1990	35	2	6626696	1985	70	3	4571652	1977	115	4	C221500	1990
9.8	2	5206550	1979	35	2	A922171	1986	70	3	4825249	1978	125	6	2314956	1968
9.8	2	5541280	1980-81	35	2	B110789	1987	70	3	5128280	1979	125	6	2536210	1969
9.8	2	5965263	1982	35	2	B238644	1988	70	3	5579017	1980-81	135	6	2839369	1970
9.8	2	6263906	1983	35	2	B393190	1989	70	3	5974683	1982	135	6	3036066	1971
9.8	2	6438338	1984	35 (300)	4	1271885	1960	70	3	6279960	1983	V-135	6	A909997	1986
9.8	2	6620196	1985	40	2	2874704	1970	70	3	B110054	1987	V-135	6	B116662	1987
9.8 (100)	2	1397581	1961	40	2	3043031	1971	70	3	B240451	1988	V-135	6	B241881	1988
9.8 (110)	2	1455240	1962	40	2	3219678	1972	70	3	C100000	1989	V-135	6	C100861	1989
9.8 (110)	2	1474328	1963	40	2	3474578	1973	75	4	6432901	1984	V-135	6	C221500	1990
9.8 (110)	2	1607083	1964	40	2	3859435	1974	75	4	6613221	1985	140	6	3293234	1972
9.8 (110)	2	1742746	1965	40	2	4118385	1975	75	4	A197882	1986	140	6	4865678	1978
9.8 (110)	2	1865779	1966	40	2	4362215	1976	75	3	C100000	1989	140	6	5189788	1979
9.8 (110)	2	2098352	1967	40	2	4564002	1977	75	3	C221500	1990	140	6	5625108	1980-81
9.8 (110)	2	2290663	1968	40	2	4860103	1978	80	4	1335465	1960	150	6	3502806	1973
9.8 (110)	2	2508759	1969	40	2	5174089	1979	80	4	1398630	1961	150	6	3752620	1974
9.8 (110)	2	2798057	1970	40	2	5556230	1980-81	80	4	2559001	1969	150	6	4125985	1975
9.8 (110)	2	3002814	1971	40	2	5991215	1982	80	4	2783253	1970	150XS	6	4319880	1976
9.8 (110)	2	3263263	1972	40	2	6228285	1983	80	4	2986444	1971	150XS	6	4602012	1977
9.8 (110)	2	3482753	1973	40	4	C159200	1989	80	4	3186263	1972	150XS	6	4868648	1978
9.8 (110)	2	3795658	1974	40	4	C221500	1990	80	4	4831999	1978	V-150	6	4868998	1978
9.8 (110)	2	4079675	1975	40 350	2	1356948	1961	80	4	5141097	1979	V-150	6	5129480	1979
9.8 (110)	2	4304785	1976	45	4	1476510	1962	80	4	5582562	1980-81	V-150	6	5503247	1980-81
9.8 (110)	2	4605112	1977	45	4	A914859	1986	80	4	5867161	1982	V-150	6	5944791	1982
9.8 (110)	2	4839254	1978	45	4	B110789	1987	80	4	6232941	1983	V-150	6	6220254	1983
9.9	2	A918999	1986	45	4	B238644	1988	80	3	A966142	1987	V-150	6	6443213	1984
9.9	2	B114231	1987	45	4	B393190	1989	80	3	B240451	1988	V-150	6	6616991	1985
9.9	2	B233200	1988	45 (400)	4	1279685	1960	80	3	C100000	1989	V-150	6	A904666	1986
9.9	2	B385500	1989	45 (400)	4	1384806	1961	85	6	1460999	1963	V-150	6	B116662	1987
9.9	2	C221500	1990	50	4	1421113	1961	85	6	1648888	1964	V-150	6	B242881	1988
10	2	1290910	1960	50	4	1477910	1962	85	4	3493913	1973	V-150	6	C100861	1989
15	2	1288910	1960	50	4	1552535	1963	85	4	3865695	1974	V-150	6	C221500	1990
15	2	1346448	1961	50	4	1605952	1964	85	4	4092965	1975	V-150XR2	6	A905191	1986
15	2	B293117	1988	50	4	1755549	1965	85	4	4590512	1977	V-150XR2	6	B289430	1988
15	2	B385500	1989	50	4	1870389	1966	85XS	4	4366802	1976	V-150XR4	6	B242885	1988
15	2	C221500	1990	50	4	2097445	1967	90	6	1755444	1965	V-175	6	4301235	1976
18	2	5860332	1980-81	50	4	2305101	1968	90	6	4854301	1978	V-175	6	4563802	1977
18	2	5954911	1982	50	4	2514919	1969	90	6	5160324	1979	V-175	6	4838074	1978
18	2	6171607	1983	50	4	2738807	1970	90	6	5594657	1980-81	V-175	6	5180109	1979
18	2	6443973	1984	50	4	3009934	1971	90	6	5996390	1982	V-175	6	5488752	1980-81
18	2	6617631	1985	50	4	3235063	1972	90	6	6246856	1983	V-175	6	6618751	1985
20	2	1558310	1963	50	4	3478003	1973	90	6	6436123	1984	V-175	6	A918329	1986
20	2	1606903	1964	50	4	3816308	1974	90	6	6623151	1985	V-175	6	B116662	1987
20	2	1755849	1965	50	4	4141450	1975	90	6	A902436	1986	V-175	6	B241881	1988
20	2	1866496	1966	50	4	4357650	1976	90	3	B110054	1987	V-175	6	C100861	1989
20	2	1997990	1967	50	4	4576237	1977	90	3	B240451	1988	V-175	6	C221500	1990
20	2	2296267	1968	50	4	4962056	1978	90	3	C100000	1989	V-200	6	4839034	1978
20	2	2550065	1969	50	4	5193259	1979	90	3	C221500	1990	V-200	6	5158929	1979
20	2	2827677	1970	50	4	5531630	1980-81	90cc	2	A907702	1986	V-200	6	5464486	1980-81
20	2	2991679	1971	50	4	5949386	1982	90cc	2	B114231	1987	V-200	6	6073192	1982
20	2	3226958	1972	50	4	6275323	1983	95	6	1869776	1966	V-200	6	6203991	1983
20	2	3537531	1973	50	4	6448808	1984	95	6	2097280	1967	V-200	6	6435503	1984
20	2	3755885	1974	50	4	6586624	1985	100	6	1503332	1962	V-200	6	6625221	1985
20	2	4103290	1975	50	3	A912478	1986	100	6	1518384	1963	V-200	6	A913228	1986
20	2	4293920	1976	50	3	B110789	1987	100	6	1665002	1964	V-200	6	B116662	1987
20	2	4580036	1977	50	3	B239242	1988	100	6	1755459	1965	V-200	6	B241881	1988
20	2	4819249	1978	50	3	B396036	1989	100	6	2318586	1968	V-200	6	C100861	1989
20	2	5183393	1979	50	3	C221500	1990	100	6	2484633	1969	V-200	6	C221500	1990
20	2	5606492	1980-81	60	3	1303411	1960	100	4	B209468	1988	210cc	2	A918999	1986
20	2	A910971	1986	60	3	6428681	1984	100	4	C100000	1989	210cc	2	B114231	1987
20	2	B114231	1987	60	3	6609651	1985	100	4	C221500	1990	210cc	2	B233405	1988
20	2	B238464	1988	60	3	A197392	1986	102cc	2	A819211	1988	210cc	2	B385500	1989
20	2	B385500	1989	60	3	B110789	1987	102cc	2	A837101	1989	V-220	6	B241881	1988
20	2	C221500	1990	60	3	B239242	1988	110	6	1870204	1966	V-225	6	5615282	1980-81
22 (200)	2	1292910	1960	60	3	B396036	1989	110	6	2097385	1967	V-250	6	C139860	1989
22 (200)	2	1339948	1961	60	3	C221500	1990	115	6	2836019	1970	V-250	6	C221500	1990
25	2	1467499	1962	65	4	1542745	1963	115	6	3023086	1971	V-275	6	C139860	1989
25	2	5705532	1980-81	65	4	1606282	1964	115	6	3270480	1972	V-275	6	C221500	1990
25	2	5942041	1982	65	4	1765044	1965	115	6	3525441	1973	V-300	6	5611648	1980-81
25	2	6185159	1983	65	4	1869564	1966	115	6	3761035	1974	V-300	6	6239853	

Mercruiser Inboard/Outdrive			
Sea Ray			
MODEL NO.	MERC. NO.	S/N	YEAR
3.0L	3.0L	B787205-B917529	88
4.3L2	4.3L	B785483-B921276	88
4.3L4	4.3LX	B785981-B922330	88
5.7L	5.7L	B784799-B917017	88
SRX5.7L	350 Mag	B785241-B919012	88
SRX7.4L	454 Mag		
	Alpha	B785149-B924857	88
SRX7.4L-H	454 Mag		
	Bravo	B721206-B919343	88

Stern Drives			
3.0L-			
SRX7.4L	Alpha	B803866-C348032	88
SRX7.4L-H	Bravo	B803872-B999972	88

Inboard Engines			
5.7L	5.7L	B788204-B919356	88
7.4L	7.4L	B788179-B913769	88

Renault 4 Cylinder (Stern Drive)			
MODEL	S/N	YEAR	
80	1887079-2049044	65-88	
80	2049045-2851423	66-69	
90	2851424-3226957	70-72	

GM 4 Cylinder (Stern Drive)			
MODEL	S/N	YEAR	
110	1537370-2044033	63-66	
120	1666601-3377340	64-72	
120	3377341-3770649	72-73	
120	3770650-4952700	74-77	
120	4952701-5192048	78	
120	5192049-6229717	79-82	
120	6229718-6853913	83-84	
120	6853914-8531853	85-86	
120/2.5L	B531854-C853255	87-89	
140	2508261-6229717	68-82	
140/3.0L	6229718-C856558	82-89	
3.0L/LX	C856559-UP	90-	

Mercury Marine 4 Cylinder (Stern Drive)			
MODEL	S/N	YEAR	
470 (2bbl.)	4208730-5520114	76-79	
470 (2bbl.)	5520115-6218036	80-82	
470 (2bbl.)	6218037-6916778	83-84	
170 (2bbl.)	6916779-UP	85-86	
165/3.7L (2bbl.)	6916779-UP	87-89	
485 (2bbl.)	5685394-6218036	80-82	
488 (4bbl.)	6170297-6916778	83-84	
190 (4bbl.)	6916779-UP	85-86	
180/3.7LX (4bbl.)	6916779-UP	87-89	

Mercruiser Inboard/Outdrive		
GM Inline 6 Cylinder (Stern Drive)		
MODEL	S/N	YEAR
140	1538930-1725960	63
150	1666495-2048046	64-66
160	2048022-2770031	67-69
165	2770032-5178958	70-78
165	5178959-5813433	79-81
200	2453769-2712072	69

GM V6 (Stern Drive)		
MODEL	S/N	YEAR
185 (4bbl.)	6330183-6919655	83-84
185 (2bbl.)	A331455-B527954	85-87
175/4.3L (2bbl.)	B527955-D714106	87-92
4.3L (GEN II)(2bbl.)	D714107-F000877	92-93
4.3L (GEN II)(2bbl.)	F000878-F601126	93-95
4.3L (GEN II)(2bbl.)	F601127-F000878	96
4.3LX (GEN+)(2bbl.)	F803000-K999999	96-97
4.3L (GEN+)(2bbl.)	L010044-UP	98-
4.3L EFI (GEN+)(TBI)	L012009-UP	98-
205 (4bbl.)	A331455-B527954	85-87
205/4.3LX (4bbl.)	B527955-D714369	87-91
4.3LX (GEN II)(4bbl.)	D714370-F001219	92-93
4.3LX (GEN II)(4bbl.)	F001220-F601126	93-95
4.3LX (GEN II)(4bbl.)	F601127-F802999	96
4.3LXH (GEN+)(4bbl.)	F803114-UP	96-97
4.3LH(GEN+)(4bbl.)	L010044-UP	98
262 Mag. (TBI)(GEN+)	F803800-K999999	96-97

Ford V8 (Stern Drive)		
MODEL	S/N	YEAR
888 (2bbl.)	3108723-4887829	71-77
215 (4bbl.)	2781153-3385720	70-72
225 (4bbl.)	3385721-4166999	73-74
225-S (4bbl.)	3385721-4166999	73-74
233	4173000-4902304	75-77
255	3258728-4175499	71-74

Mercruiser Inboard/Outdrive		
GM V8 283, 327, 305 & 350 CID (Stern Drive)		
MODEL	S/N	YEAR
190	1564539-1730903	63-64
898 (2bbl.)	4762210-6218461	77-82
898 (2bbl.)	6218462-B525981	83-84
200/5.0L (2bbl.)	6218462-F600999	85-95
5.0L (2bbl.)	L015751-UP	98-
5.0L EFI	L012052-L340000	98-99
228 (4bbl.)	4765100-5170008	77-78
228 (4bbl.)	5170009-6218461	79-82
228 (4bbl.)	6218462-B525981	82-84
230 (4bbl.)	6218462-B525981	85-86
230/5.0LX (4bbl.)	B525982-F600999	87-95
225	1539620-2694014	63-69
250	2314301-2639854	68-69
255	4175500-4767999	75-76
250	4768000-4908849	77
260/5.7L	4908850-6218461	78-82
260/5.7L	621462-B525981	82-86
260/5.7L	B525982-F600999	87-95
5.7L (2bbl.)	F601000-UP	96-98
5.7L EFI	F225560-UP	95-
5.7LX (4bbl.)	F601000-K999999	96-97
5.7LX EFI	F752400-K999999	96-97
5.7LX Bravo EFI	F800300-K999999	96-97
350 Mag. Alpha	A635178-B525981	86-87
350 Mag. Alpha	B525982-F600999	87-95
350 Mag. Alpha	F601000-K001526	96
350 Mag. Alpha	K001527-K999999	97
350 Mag. Alpha EFI	F800300-K999999	96-97
350 Mag. Bravo MPI	F415189-K999999	95-97
350 Mag. MPI (GEN +)	F602000-K999999	96-97
350 Mag. MPI (GEN+)	L010019-UP	98-
270	2851074-3385720	69-72
280TRS	4176250-4770199	75-76
300 Tempest	6668677-B430367	85-86
320 (EFI)	A543604-C622418	87-89

Mercruiser Inboard/Outdrive			Mercruiser Inboard/Outdrive			Mercruiser Inboard/Outdrive			
GM V8 427, 454, 502, 540 & 572 (Stern Drive)			MCM 4, 5, 6 & V8 Cylinder Diesel Stern Drive Engines			GM MIE V8 427, 454, 482 & 502 CID (Inboard)			
MODEL	S/N	YEAR	MODEL	HP	S/N	YEAR	MODEL	S/N	YEAR
325	2278747-3780449	69-72	Rover	60	3140000F-UP	65-67	325	2278747-3780449	68-74
330	4623115-6083144	77-81	530 D-TA	150	B993000-B993492	89	330	4623115-5889913	77-80
330	6083145-B816450	82-87	636 D-TA	180	B993500-C696047	89			
7.4L Bravo	B771113-D603117	88-91	D183	140	B993493-D725149	90-93	340/7.4L		
7.4L Bravo (Gen.V)	D803118-F800699	92-96	D219	170	C696048-D850124	90-93	w/B/W MK4	5889914-UP	81-92
7.4L Bravo (Gen.VI)	F800700-K999999	96-97	D254	200	C849484-D554729	90-93	7.4L w/Hurth (LH) MK4	C391564-D715493	89-92
7.4LX Bravo (MPI)(Gen.V)	F602010-F801999	96	D3.0L	140	D725150-UP	94-	7.4L (LH)	D715494-K999999	92-97
7.4LX Bravo (MPI)(Gen.VI)	F802000-K999999	96-97	D3.6L	170	D850125-UP	94-	7.4L MPI (LH)	F563052-K999999	95-97
7.4L MPI (Gen.VI)	L010003-UP	98	D4.2L	200	D554730-UP	94-	7.4L MPI (L29) Gen VI	L002006-UP	98
7.4LX Bravo (TBI)(Gen.VI)	F820000-K999999	96-97	D7.3L	238	F060000-UP	94-	7.4L TBI (LH) Gen VI	F874815-K999999	96-97
454 Mag. Alpha	A631894-UP	86-88	Mercury Marine MIE 4 Cylinder (Inboard)				454 Mag. MPI		
454 Mag. Bravo (Gen.V)	D805069-F304999	92-94	MODEL	S/N	YEAR	Horizon	L002200-L086049	98-99	
454 Mag. Bravo (Gen.V)	F305000-F801699	95-96	470	5520115-6218036	80-81	454 EFI (SKI) (Gen.V)	F215800-F820099	95-96	
454 Mag. Bravo (Gen.VI)	F801700-K999999	96-97	Ford MIE V8 (Inboard)			454 Mag. MPI (SKI)(Gen.VI)	F820100-K999999	96-97	
454 EFI (Gen.V)	F115700-F802349	94-96	MODEL	S/N	YEAR	350	9780450-4623109	74-76	
454 Mag. MPI (Gen.VI)	F802350-K999999	96-97	215	2781153-3563181	70-72	390	2781129-2825059	69-70	
454 Mag. MPI (Gen.VI)	L010029-L085399	98	225	3385721-4176999	70-72	8.2L w/ Hurth	C878221-D857199	90-92	
454 Mag. MPI (Gen.VI)	L085400-UP	99-	233	4173000-4775784	75-76	8.2L (Gen.V)	D857200-F819619	93-96	
370 TRS	4179554-6721527	78-85	255	3258728-4178299	73-74	8.2L MPI (LH) Gen VI	F819620-K999999	96-97	
370 TRS	6721528-B714586	85-87	GM MIE V8 305,327,350 CID (Inboard)			8.2L MPI (LH) Gen VI	L002450-L0086012	98	
400 TRS	4179554-B457644	80-86	MODEL	S/N	YEAR	8.2L MPI (LH) Gen VI	L0086013-UP	99	
420	A398941-D937011	87-89	198	4762210-6218461	77				
425	A398941-D937011	90-93	228	4765100-5170008	77-78				
440 TRS	4179554-B485220	83-86	228	5170009-5907057	79-80				
450 (Gen.V)	F347100-F347277	95-96	230/5.0L (4bbl.)	5907058-B788151	81-87				
525 SC	D456000-F348963	91-92	225	2278647-2694014	68				
525 SC (Gen.V)	D456000-F348963	92-95	250	2314301-2639854	68-69				
525 SC (Gen.V)	F615814-F745215	96	255	4175500-5907057	75-80				
525 SC (Gen.VI)	F745260-UP	96-97	260/5.7L	5907058-F024999	81-93				
390	2781129-3042731	69-70	270	2851074-3077735	69-72				
460 TRS	4719554-6181046	83-86	5.7L	F025000-K999999	94-97				
465	C849992-F213244	90-92	5.7L (Gen+)	L002003-UP	98				
465 (Gen.V)	C849992-F213244	92-94	5.7L MPI	K040300-K999999	97				
500 (Gen.V)	F213293-F745159	94-96	350 Mag. MPI (Gen+)	L002008-L304499	98				
500 (Gen.VI)	F745195-L001772	97-98	350 Mag. MPI (Gen+)	L304500-UP	99				
502 Mag. Bravo	C878221-D824588	90-92	350 Horizon	L304700-UP	99-				
502 Mag. Bravo (Gen.V)	D824589-F114528	92-93	5.7L Ski	A338533-B514626	85-87				
502 EFI (Gen.V)	D840650-F802599	93-96	5.7L Competition Ski	B514627-F775199	87-95				
502 Mag. MPI (Gen.VI)	F802600-K999999	96-97	5.7L Competition Ski	F775200-K040003	96				
500 EFI	L001477-UP	99-	5.7L Competition Ski (Gen+)	L002005-UP	98-				
502 Mag. MPI (Gen.VI)	L085433-UP	98	350 Mag. Ski	D505450-K999999	91-97				
600 SC	D456489-F877642	91-92	350 Mag. EFI Ski	F215561-K999999	94-97				
600 SC (Gen.V)	D456489-F877642	92-96	350 Mag. MPI Ski	F350583-F799999	95-98				
600 SC (Gen.VI)	K000227-UP	97	Black Scorpion Ski	F800000-UP	96-98				
500 Bulldog	C577254-F745405	90-96							
500 Bulldog	K000248-UP	97							
575	A677429-D763716	86-92							
800 SC (Gen.V)	D763836-UP	93-96							

Mercruiser Inboard/Outdrive				Mercruiser Inboard/Outdrive				Mercruiser Inboard/Outdrive			
MIE 5, 6 & V8 Cylinder Diesel Inboard Engines				MC 120, 140, 160 & 165				MC Bravo & Blackhawk			
MODEL	HP	S/N	YEAR	MODEL	S/N	YEAR	MODEL	S/N	YEAR		
530 D-TA	150	B993002-C539258	89	120/140	2062141-378049	67-73	Bravo One B664190-UP		88-		
636 D-TA	180	B993750-C696011	89	120/140	3780850-4893634	74-77	Bravo Two C564952-UP		89-		
D183	150	C539259-D725149	90-93	120/140	4893635-6225576	78-82	Bravo Three D763691-UP		93-		
D219	180	C696012-D850124	90-93	160	2065190-2763441	67-69	Blackhawk F186717-UP		94-		
D254	210	C849461-D554729	90-93	165	2763442-3780849	70-73					
D3.0L	150	D725150-UP	94-	165	3780849-4890459	74-77					
D3.6L	180	D850125-UP	94-	165	4890460-6268064	78-82					
D4.2L	210	D554730-UP	94-								
D7.3L	262	F060000-UP	94-								
MC 60, 80 & 90 Stern Drives & Transom Plates				MC 470 & 485				MC 215E & 215H			
MODEL		S/N	YEAR	MODEL	S/N	YEAR	MODEL	S/N	YEAR		
60 (O)		1830753-2063740	65-66	470	4208730-4893834	76-77	215H	2782203-2909034	70		
80		2063741-2898029	66-69	470	4893835-6225576	78-82	215E	2782203-2909034	70-72		
90		2898020-3225967	70-72	485	5487437-6225576	80-82					
MC I, II & III				MC 888, 225S & 233				MC TR & TRS			
MODEL		S/N	YEAR	MODEL	S/N	YEAR	MODEL	S/N	YEAR		
I		1534570-1684187	63	888	3106717-3784374	71-73	TR	3377316-3787239	73		
II (1.33:1)		1474909-2278488	62-67	888	3784375-4782329	74-77	TR	3787240-4794899	74-76		
II (1.78:1)		2398798-2671321	68-69	225S	3856268-4200499	74	TR	4794900-5009866	77		
III		2373127-3002613	68-72	233	4200500-4782329	75-77	TR	5009867-UP	78-		
III		5128065-UP	78-				TRS	3787240-4203749	74-75		
							TRS	4203750-4795399	76		
							TRS	4795400-UP	77-		
MC 1A, 1B & 1C				MC 898, 228, 250 & 260				MC II, III, IV & V SSM			
MODEL		S/N	YEAR	MODEL	S/N	YEAR	MODEL	S/N	YEAR		
1A, 1B & 1C		1684188-1777798	64	898/228	4782330-4898729	77	II SSM	Z2021100C-Z2021313C	82-84		
1A, 1B & 1C (E-Z Shift)		1776349-2065189	65-66	898/228	4898730-6229157	78-82		A544504Z-C576702Z	85-90		
				250	4791300-4898729	77	III SSM	Z38022378C-X38092085C	78-84		
				260	4898730-6229157	78-82		A568120-UP	86-		
							IV SSM	A568120-UP	86-		
							V SSM	C576812-UP	89-		
							VI SSM	D456231-UP	91-		
MC R, MR, Alpha One, Alpha One SS & Alpha One Gen II											
MODEL		S/N	YEAR								
R		6152230-6847029	83-84								
MR		6810538-A479506	85								
Alpha One		A470165-UP	86-90								
Alpha One SS		A545004-UP	86-89								
Alpha One Gen II		D489859-UP	91-								

ARCO		ARCO (Cont.)		ARCO (Cont.)		BARR (Cont.)			
ARCO No.	Sierra No.	ARCO No.	Sierra No.	ARCO No.	Sierra No.	BARR No.	Sierra No.		
3410	18-6418	6266	18-6789	R211	18-5729	CM-1-6677A	18-1940		
3412	18-6432	6267	18-6259	R473	18-5705	CM-1-6672-B	18-1941		
3420	18-6410	6270	18-6765	R670	18-6271	CM-1-6672-J	18-0472		
3421	18-6420	6275	18-6769-1	R832	18-5704	CM-20-2847405	18-1913		
3422	18-6411	6276	18-6777	SR102	18-6250	CM-20-4142411	18-1944		
3423	18-6421	6277	18-6757	SR104	18-6251	CM-20-6672	18-1946		
3424	18-6412	6278	18-6273-1	SR410	18-56001	CM206672JP	18-4360		
3425	18-6422	7325	18-5618	SR412	18-56003	CM-20-6674	18-1945		
3426	18-6413	7326	18-6282	SR420	18-56003	CM-20-6674P	18-4361		
3427	18-6423	10112	18-5906	SR422	18-56003	CM206674P	18-4361		
3428	18-6415	10113	18-6292	SR423	18-56003	CM-20-9234	18-1948		
3429	18-6424	20102	18-5950	SR425	18-56003	CM-20-9234 P	18-8501		
3430	18-6425	20104	18-5951	SR426	18-56005	CM-20-6674JP	18-8506		
3431	18-6426	20800	18-6293	SR429	18-56007	CR 20 97169	18-1916		
3432	18-6427	20800	18-6298	SR444	18-56009	CR 20 97386	18-1918		
3440	18-6414	20810	18-5983	SW054	18-5816	CR 20 97387	18-1919		
3442	18-6417	20820	18-5984	SW058	18-5817	CR 20 97624	18-1924		
3444	18-6416	20825	18-6288	SW064	18-5818	CR 20 97772	18-1927		
5360	18-6435	20830	18-6299	SW079	18-5840	CR 20 98068	18-1934		
5362	18-6436	20840	18-6454	SW081	18-5807	CR-1-97752	18-1925		
5364	18-6437	20850	18-6455	SW090	18-5805	CR-1-97992	18-1929		
5365	18-6438	30119	18-5900	SW091	18-5806	CR-1-97993	18-1933		
5366	18-5601	30121	18-5901	SW092	18-5809	CR-1-97753	18-1926		
5367	18-5611	30122	18-5902	SW097	18-5819	CR-20-97296	18-1917		
5368	18-5623	30140	18-5905	SW099	18-5820	CR2097924	18-1928		
5369	18-5617	30450	18-5910	SW109	18-5834	FM183	18-1998-1		
5369	18-6434	30456	18-5907	SW125	18-6291	MC-1-65603	18-1962-1		
5370	18-5635	30457	18-5908	SW268	18-5812	MC-1-65604	18-1958-1		
5371	18-5630	30459	18-5603	SW268	18-5812	MC-1-77234	18-1950-1		
5372	18-5634	30460	18-5911	SW268	18-5812	MC-1-77235	18-1951-1		
5373	18-5600	30462	18-6443	SW275	18-5815	MC-1-87114	18-1953-2		
5374	18-5602	30470	18-6275-1	SW288	18-5814	MC-1-89011	18-1957-1		
5375	18-5604	40112	18-5954	SW295	18-5835	MC-1-99746	18-1952-1		
5376	18-5629	40152	18-5964	SW394	18-5801	MC199798	18-1956-1		
5377	18-5636	50143	18-6272	SW412	18-5842	MC-20-12076	18-1975-1		
5379	18-5605	60050	18-5957	SW424	18-5843	MC-20-44354	18-1976-1		
5380	18-5608	60055	18-5967	SW450	18-6287	MC-20-55538	18-1973		
5381	18-6283	60060	18-5960	SW580	18-5823	MC2060426P	18-4362		
5382	18-6439	60065	18-5965	SW580	18-5823D	MC-20-60426	18-1971		
5386	18-5628	60070	18-6261	SW590	18-5833	MC-20-61851A2	18-1906		
5387	18-5619	60071	18-6265	SW590	18-5833D	MC-20-76325	18-1972		
5388	18-5606	60072	18-5979	SW622	18-5808	MC-20-76771	18-1978		
5389	18-5624	60108	18-6263	SW661	18-5836	MC-20-90880	18-1905		
5390	18-5627	60122	18-6262	SW774	18-5803	MC-20-93320A3	18-1908		
5391	18-5612	60125	18-6260	SW917	18-5841	MC-20-98502	18-1974-1		
5392	18-5610	70100	18-5903	SW926	18-5822	MC-20-98504	18-1970-2		
5393	18-5613	70101	18-5904	SW945	18-5821	MC-20-60207	18-4008		
5393	18-5613	70110	18-5914	SW975	18-5838	MC2947441	18-1977-1		
5394	18-5622	70111	18-5915	SW981	18-5802	MC47-27-33395	18-0872		
5395	18-5620	70112	18-6276	SW984	18-5837	MC47-27-33395A2	18-4394		
5396	18-5621	70114	18-5916	TAK217	18-6253	MC472735898	18-0332		
5397	18-5614	70116	18-5917	TR208	18-6252	MC47273589A4	18-4395		
5398	18-5631	70125	18-5920	VR404	18-5711	MC472739915	18-2819		
5399	18-5632	80108	18-5939	VR405	18-5710	MC472739917	18-1209		
5400	18-6440	84135	18-6284	VR406	18-5727	MC472739923	18-1210		
5551	18-6441	84150	18-6278	VR407	18-5712	MC-47-27-41811	18-0672		
6204	18-6755	5381X	18-5609	VR785	18-5740	MC47-27-41813	18-0887		
6206	18-6781	AR103	18-5708	BARR				MC47-27-46401	18-2830
6208	18-6767-1	AR104	18-5709					MC47-27-46401A1	18-4396
6209	18-6754	AR351	18-5707	BARR No. Sierra No.				MC47-27-46820	18-0418
6211	18-6764	BK900	18-5697					MC472747590	18-2831
6212	18-6279	DV366	18-5650	10107	18-2854	MC472747644	18-0342		
6214	18-6257	DV373	18-5674	147638	18-1995	MC472748042	18-0885		
6216	18-6762	DV374	18-5656	160252	18-4009	MC47-27-48043	18-2832		
6217	18-6763	DV376	18-5655	200082	18-1999	MC472748818	18-2844		
6218	18-6772	DV381	18-5658	1-73813	18-1990	MC472752546	18-2896		
6220	18-6759	DV389	18-5678	1-54870	18-1912	MC47-27-53354	18-2912		
6223	18-6758	DV390	18-5671	200087P	18-1992-1	MC47-27-53354A1	18-4398		
6224	18-6274	DV394	18-5679	200089P	18-1991	MC472754014	18-2847		
6227	18-6770	DVK68	18-5679	20-0097	18-1949	MC47-27-54566A1	18-4399		
6228	18-6756	M525	18-6771	20-0100	18-1939	MC47-27-58764	18-0353		
6238	18-6281	PWB 1000	18-6442	CC-1 1650 05944	18-0470	MC472760208	18-2834		
6239	18-6258	PWK440	18-6294	CC-1-07686	18-1914	MC472764692	18-0351		
6241	18-6780	PWK650	18-6295	CC47-1650-06022	18-0473	MC47-27-68715	18-0992		
6242	18-6280	PWP650	18-6296	CHV-1-83	18-1997-1	MC472770143	18-0994		
6243	18-6285	PWY500	18-6289	CHV470000	18-2902	MC472770905	18-0158		
6244	18-6277	PWY650	18-6290	CHVA470000	18-0418	MC472773814	18-0928		
6245	18-6779	R036	18-6264	CM-1-5972-A	18-1915	MC47-27-73866	18-0183-1		
6250	18-6773	R040	18-6266	CM-1-5972B	18-1911	MC472774830	18-2843		
6255	18-6286	R177	18-6268			MC47-27-87105	18-2849		

BARR (Cont.)		CDI/RAPAIR (Cont.)		COLE-HERSEE (Cont.)		COLE-HERSEE (Cont.)	
BARR No.	Sierra No.	CDI/RAPAIR No.	Sierra No.	COLE-HERSEE No.	Sierra No.	COLE-HERSEE No.	Sierra No.
MC47-27-89657	18-0111	114-7778	18-5775	5520BP	TG21020-2	M482-BP	MP39380
MC47-27-92720	18-0954	114-9052	18-5791	5582-30-BP	TG19560	M484-BP	TG21160
MC472796429	18-1204	123-9898-P	18-5888	56027-01BP	RK40140	M485-BP	MP39320
MC47-27-97542	18-0113	123-9898-P	18-5889	56327-01BP	RK19650	M489-BP	MP39020
MC47-27-99757	18-2909	123-9898-P	18-5890	57000-23	RK40140W	M490-BP	MP39420
MC472799777	18-2833	134-6453	18-5797	57001-15	RK40150W	M491-BP	MP39410
MC47-27-99777A1	18-4367	134-6456	18-5795	57003-16	RK40170W	M492-BP	MP39310
OMC-1-912441	18-1902	134-6456	18-5798	58027-02BP	RK40150	M493-BP	TG21030-1
OMC-1-912442	18-1903	153-1778	18-5709	58027-03BP	RK40170	M527-BP	MP39600
OMC-1-980959	18-1904	153-3408	18-5708	58027-04BP	RK40350	M531-BP	MP39640
OMC-1-984054	18-1901	154-6770	18-5707	58027-07BP	RK40480	M532-BP	MP39620
OMC-20-913784	18-1909	173-3117	18-5869	58027-11BP	RK40470	M54111-01BP	TG40300
OMC-20-982680	18-1921	173-3668	18-5868	58327-01BP	RK19660	M54111-02-BP	TG40320
OMC47308799	18-2863	174-3996	18-5855	58327-06BP	RK40110	M550-14-BP	MP39080
OMC47311121	18-2861	174-5255	18-5856	58328-01-BP	RK19510R	M550-BP	MP39060
OMC47311130	18-2860	174-5454K1	18-5859	58328-02	RK19510G	M58031-01BP	RK19400S
OMC47311131	18-2859	174-5456	18-5854	58328-04	RK19500R	M58031-02BP	RK19420S
OMC47313368	18-2851	174-5456-16	18-5860	58328-05	RK19530RC	M58031-04BP	RK19560S
OMC47314809	18-2858	174-6617K1	18-5863	58328-06	RK19520RC	M58031-07BP	RK19410S
OMC47315055	18-0937	174-6617K1	18-5864	58328-07	RK19520GC	M584-BP	TG21050-1
OMC47907761	18-0114	174-832075K1	18-5874	58328-08	RK19580K	M-597	MP40970-1
OMC47907775	18-2883-1	174-832075K2	18-5870	58328-09	RK19510C	M-598	MP40990
OMC47908013	18-2875	174-9610K2	18-5875	58328-10	RK19510A	M606-BP	MP39390B
OMC47-908079	18-2912	174-9610K2	18-5876	58328-100BP	RK19500K	M608-BP	MP39350
OMC47908935	18-2850	183-2091	18-5192	58328-101BP	RK19510K	M612-BP	MP39360
OMC-47-909314	18-2902	183-2508	18-5179	58328-102BP	RK19580K	M626-BP	UN42000
OMC47909515	18-0548	183-3737	18-5176	58328-103BP	RK19520C	M628-BP	MP39530
OMC-47-909786	18-0943	183-4632	18-5194	58328-104BP	RK19530K	M630-BP	MP39400
VO-1-835804	18-1931-1	193-3689	18-5832	58328-11	RK19500G	M-641-01-BP	FS40600-1
VO-1-855387	18-1930-1	193-4093	18-5828	58328-12	RK19500C	M-643-01	FS40610-1
VO-20-855384	18-1935-1	193-4476	18-5827	58328-13	RK19500A	M-649-04-BP	FS40670
VO47-835908	18-2971	193-4641	18-5831	58328-14	RK19580K	M-649-06BP	FS40680
VO47855383	18-2991	193-5204	18-5825	58328-15	RK19580K	M-649-08BP	FS40690
		193-6048	18-5829	58328-16	RK19580K	M656-BP	FS40560-1
		194-5279	18-5741	58328-17	RK19580K	M674-BP	FS40550-1
		194-5279	18-5743	58328-18	RK19580K	M676-BP	MP39010
		194-8736K1	18-5824	58328-19	RK19580K	M712-09BP	MP39070
		832-9809	18-6774	58328-20	RK19580K	M712-BP	MP41020
		R584642	18-5773	58328-21	RK19580K	M832BP	MP39090
				58328-22	RK19580K	M850BP	MP39200
				58328-25	RK19520K		
				58328-26	RK19520K		
				58328-33	RK19520AG		
				58328-34	RK19520K		
				58328-35	RK19520K		
				58328-36	RK19520K		
				58328-39	RK19530K		
				58328-40	RK19530K		
				58328-47	RK19530AG		
				58328-48	RK19530GC		
				58328-49	RK19530K		
				58328-50	RK19530K		
				58328-51	RK19530K		
				81255-BP	MP39220		
				81264-BP	MP39030		
				82065-BP	UN19690		
				82159-02BP	UN19750		
				82159-03BP	UN19730		
				82159-1-BP	UN19740		
				82159-2	UN19750		
				83280-03BP	MP39260		
				9187-01BP	MP39670		
				9187-BP	MP39680		
				9187-O2BP	MP39690		
				96101-BP	MP39300		
				M-115BP	TC43624		
				M-121BP	TC43604		
				M200-BP	BA58050		
				M284-01BP	MP39050		
				M284-09 BP	MP38910		
				M320-RCBP	UN22190		
				M40177BP	MP41400		
				M412BP	FS40500		
				M-414-01	FS40590		
				M414BP	FS40510-1		
				M-426BP	FS45620		
				M-427BP	FS45630		
				M-429BP	FS45650		
				M-449	FS40750		
				M476-BP	MP39560		

CDI/RAPAIR		COLE-HERSEE		FRAM	
CDI/RAPAIR No.	Sierra No.	COLE-HERSEE No.	Sierra No.	FRAM No.	Sierra No.
113-1397	18-5755	4099	MC33501	C1110PL	18-7930
113-2115	18-5762	24059	BA58003	C1175PL	18-7931
113-2125	18-5759	11134BP	TC43654	C1191A	18-7858
113-2138	18-5760	11172BP	TC43634	CC1133PL	18-7934
113-2285	18-5763	11173BP	WH10320	CCS1136	18-7935
113-2285	18-5765	24059-08BP	BA58060	CG11	18-7855
113-2453	18-5758	24106-BP	18-5840	CG20DP	18-7862
113-2556	18-5760	24106-BP	BA58040	CG7	18-7860
113-2651	18-5769	24117-01	BA58010	CH33APL	18-7920
113-2705	18-5782	24117-01BP	BA58010	CH836PL	18-7921
113-2811	18-5783	26100-BP	UN22200	G12	18-7830
113-3101	18-5892	30147BP	FS45410	G15	18-7831
113-3110	18-5784	3031-0BP	FS45400	G15(Plastic)	18-7857-1
113-3114	18-5761	30410-10 BP	CB42100	G2	18-7856-1
113-3241	18-5764	30410-15 BP	CB42110	G3	18-7831
113-3605	18-5891	30410-20 BP	CB42120	G3(Plastic)	18-7857-1
113-3748	18-5766	30410-25 BP	CB42130	G3870	18-7936
113-3865	18-5885	30410-30 BP	CB42140	G8174	18-7830
113-4028	18-5770	407-01-BP	MP39170	P1115	18-7937
113-4032	18-5771	407-03-BP	MP39140	P1116	18-7938
113-4037	18-5893	46377-10BP	FS40740	P1146G	18-7829
113-4041	18-5772	46377-14	FS40440	P1146G	18-7867
113-4489	18-5794-1	46377-6BP	FS40420	P3726	18-7939
113-4767	18-5768	46377-8	FS40450	P4102A	18-7942
113-4783	18-5767	46379-10-BP	FS40740	P8043	18-7940
113-4808	18-5774-1	54003-BP	RK19630	P8263	18-7802
113-4985	18-5887	54010-BP	RK19640	PH16	18-7878
113-5316	18-5785	54100-01	TG40020-1	PH25	18-7923
113-6212	18-5781	54101-01	TG40030-1	PH2821	18-7886
113-6367	18-5886	54103-01	TG40040-1	PH2821A	18-7886
113-7123	18-5747	54104-01	TG40050-1	PH2870A	18-7925
113-7123	18-5749	54107-01-BP	TG40450-1	PH30	18-7824
113-8362	18-5748	54109-01	TG40060	PH3306A	18-7926
114-2986	18-5779	54110-01	TG40010	PH3545	18-7927
114-4911	18-5786	55020-11-BP	TG19540	PH3593A	18-7910
114-4911	18-5787	55036-14-BP	TG19550		

FRAM (Cont.)		GLM (Cont.)		GLM (Cont.)		GLM (Cont.)	
FRAM No.	Sierra No.	GLM No.	Sierra No.	GLM No.	Sierra No.	GLM No.	Sierra No.
PH3612	18-7874	11500	18-2171	12501	18-3350	13050	18-3552
PH3614	18-7884	11510	18-2173	12502	18-3351	13060	18-3554
PH3614	18-7915	11520	18-2172	12510	18-3117	13070	18-3558
PH3980	18-7879-1	11610	18-5967	12520	18-3107	13080	18-3557
PH43	18-7878	11620	18-2372	12540	18-3139	13100	18-3649
PH4743	18-7886	11800	18-8210	12550	18-3127	13101	18-3647
PH4967	18-7906	11810	18-8211	12560	18-3126	13120	18-3549
PH4967	18-7916	12000	18-3315-2	12590	18-3141	13124	18-3569
PH49A	18-7880	12010	18-3507	12610	18-3178	13150	18-3561
PH5046	18-7917	12020	18-3423	12620	18-3343	13170	18-3500
PH6017A	18-7902	12030	18-3424	12670	18-6011	13200	18-3556
PH6017A	18-7910	12041	18-3151	12675	18-6068	13220	18-1977-1
PH6017A	18-7911	12042	18-3214	12680	18-6014	13230	18-1994
PH6607	18-7910	12043	18-3154	12690	18-6249	13270	18-3673
PH6607	18-7911	12050	18-3327	12700	18-6015-9	13280	18-3674
PH7317	18-7914	12060	18-3363	12702	18-6093	13350	18-3672
PH7575	18-7884	12061	18-3401	12703	18-6067	13370	18-3650
PH7575	18-7915	12070	18-3382	12703	18-6114	13380	18-3646
PH8842	18-7880	12071	18-3381	12704	18-6089	13380	18-3651
PH8A	18-7875	12082	18-3216	12704	18-6092	13381	18-3662
PH977A	18-7887	12084	18-3237	12710	18-6016	13390	18-3668
PH977A	18-7899	12085	18-3309	12711	18-6080	13400	18-3652
PS3808	18-7844	12088	18-3150	12712	18-6094	13410	18-3671
PS3808	18-7845	12091	18-3212-1	12713	18-6066	13420	18-3667
		12100	18-3324	12730	18-6017	13430	18-3653
		12101	18-3393	12731	18-6018	13440	18-3670
		12102	18-3392	12733	18-6027	13450	18-3669
		12103	18-3391	12736	18-6025	13520	18-3678
		12104	18-3390	12737	18-6095	13540	18-3531
		12105	18-3211	12738	18-6026	13550	18-3532
		12106	18-3210	12739	18-6115	13950	18-8112
		12107	18-3215	12740	18-6012	13984	18-4461
		12108	18-3201	12741	18-6029	13990	18-4224
		12110	18-3317	12743	18-6113	13991	18-4227
		12120	18-3320	12744	18-6097	13992	18-4226
		12130	18-3321	12745	18-6034	13993	18-4218
		12140	18-3314	12750	18-6013	14010	18-4500
		12150	18-3316	12760	18-3121	14020	18-4505
		12170	18-3322	12770	18-6020	14030	18-4515
		12180	18-3323	12772	18-6019	14040	18-4520
		12190	18-3386	12773	18-6101	14110	18-4510
		12200	18-3219	12774	18-6028	14115	18-4010
		12202	18-3220	12775	18-6103	14120	18-4545
		12210	18-3378	12776	18-6024	14125	18-4011
		12211	18-3380	12780	18-6000	14130	18-4525
		12221	18-3385	12781	18-6023	14135	18-4012
		12243	18-3994	12782	18-6004	14140	18-4560
		12244	18-3368	12784	18-6005	14145	18-4013
		12246	18-3387	12787	18-6009	14160	18-4575
		12250	18-3207	12788	18-6010	14165	18-4015
		12251	18-3400	12789	18-6001	14190	18-4090
		12260	18-3252	12810	18-3114	14210	18-3918
		12270	18-3239	12812	18-3358	14220	18-3919
		12280	18-3517	12813	18-3179	14230	18-3920
		12290	18-3217	12817	18-3113	14240	18-3921
		12305	18-3149-1	12820	18-3109	14250	18-3922
		12310	18-3417	12821	18-3226	14260	18-3923
		12320	18-3420	12822	18-3197	14270	18-3924
		12330	18-3421	12824	18-3151	14275	18-3927
		12341	18-2354	12825	18-3222	14280	18-3925
		12350	18-3416	12826	18-2722	14315	18-4600
		12352	18-3445	12829	18-3221	14320	18-4555
		12360	18-3419	12830	18-3110	14330	18-4565
		12370	18-3414	12836	18-2728	14410	18-4635
		12380	18-3422	12840	18-3106	14430	18-4637
		12390	18-3119	12860	18-3115	14440	18-4636
		12391	18-3145	12880	18-3346	14470	18-4628
		12395	18-3405	12881	18-6070	14480	18-4627
		12400	18-3129	12883	18-6112	14490	18-4628
		12405	18-3206	12884	18-6091	14600	18-4055
		12410	18-3116	12885	18-6090	14610	18-4056
		12415	18-3571	12886	18-6036	14640	18-4059
		12416	18-3572	12887	18-6032	14650	18-4060
		12420	18-3118	12888	18-6098	14660	18-4623
		12430	18-3130	12889	18-6033	14670	18-4624
		12440	18-3363	12930	18-2715	14680	18-4625
		12450	18-3336	13010	18-3553	14910	18-3979
		12460	18-3180	13020	18-3550	14920	18-3980
		12470	18-3367	13030	18-3551	14930	18-3981
		12500	18-3122	13040	18-3555	14940	18-3982
GLM							
GLM No.	Sierra No.						
1056	18-7315						
1070	18-7314						
1073	18-7307						
1100	18-7316						
10561	18-3290						
10562	18-3566						
11013	18-2408						
11020	18-2409						
11030	18-2286						
11040	18-2130						
11050	18-2348						
11051	18-2398						
11052	18-2399						
11055	18-1502						
11060	18-2202						
11061	18-2236						
11071	18-3293						
11091	18-2406						
11100	18-2410						
11110	18-2167						
11120	18-2180						
11131	18-2324						
11140	18-2261						
11150	18-2166						
11151	18-2239						
11155	18-2166						
11163	18-2181						
11190	18-3719						
11210	18-2201						
11215	18-2256						
11216	18-2358						
11220	18-2203						
11225	18-2257						
11226	18-2364						
11230	18-2204						
11235	18-2258						
11236	18-2365						
11238	18-6353						
11240	18-2205						
11245	18-2259						
11246	18-2363						
11300	18-2200						
11312	18-2407						
11380	18-2299						
11381	18-2298						
11405	18-2191						
11406	18-1702						
11410	18-1158						
11416	18-1708						
11420	18-1157						
11430	18-1356						

GLM (Cont.)		GLM (Cont.)		GLM (Cont.)		GLM (Cont.)	
GLM No.	Sierra No.	GLM No.	Sierra No.	GLM No.	Sierra No.	GLM No.	Sierra No.
14950	18-3983	21360	18-3714	21894	18-4264	22616	18-2290
14960	18-3984	21370	18-2462	21896	18-4265	22620	18-2217
15100	18-3575	21380	18-2463	21900	18-2100	22625	18-2216
15201	18-3583	21419	18-3749	21910	18-2461	22630	18-2221
15201	18-3599	21420	18-2169	21930	18-2148	22631	18-2218
15301	18-3574	21421	18-2322	21951	18-8205	22633	18-2220
15400	18-3584-1	21423	18-3236	21960	18-8206	22661	18-2310
15500	18-3581	21424	18-2395	21961	18-8212	22662	18-2309
15600	18-3582	21425	18-2464	21962	18-2771	22663	18-2308
15700	18-3578	21430	18-2149	21980	18-2142	22670	18-2210
16100	18-4035	21432	18-3754	22010	18-2176	22671	18-2207
16120	18-4036	21433	18-2303	22020	18-2177	22672	18-2208
16150	18-4037	21440	18-2600	22030	18-4251	22673	18-2209
16200	18-1194	21450	18-2603	22031	18-4273	22681	18-2289
16210	18-4038	21451	18-2190	22040	18-2156	22683	18-2287
16220	18-1374	21453	18-2604	22050	18-2178	22700	18-1362
16230	18-1376	21460	18-2159	22090	18-2380	22710	18-1377
16240	18-1375	21480	18-2396	22100	18-3740	22720	18-1099
16300	18-1366	21481	18-2397	22110	18-3741	22750	18-1112
16310	18-1371	21510	18-1165	22120	18-3742	22760	18-1113
16320	18-1367	21511	18-1179	22130	18-3743	22770	18-1114
16330	18-1365	21512	18-1129	22140	18-3744	22780	18-1115
16340	18-1370	21520	18-1160	22150	18-3705	22800	18-1352
16350	18-1363	21540	18-1161	22160	18-3706	22810	18-1353
16360	18-1364	21541	18-1170	22170	18-3707	22820	18-1361
16370	18-1368	21542	18-1172	22185	18-3708-1	22830	18-1378
16400	18-4039	21543	18-1171	22190	18-4231	22840	18-1359
16470	18-1347	21560	18-1142	22191	18-4274	22850	18-1360
16520	18-1196	21570	18-1164	22200	18-3715	22860	18-1350
17000	18-2402	21580	18-1143	22220	18-4223	22870	18-1351
18000	18-2401	21584	18-1193	22230	18-4222	22880	18-1357
18100	18-2443	21590	18-1159	22240	18-4230	22890	18-1354
19100	18-2450	21591	18-1173	22250	18-4228	22900	18-1355
19200	18-2451	21592	18-1130	22252	18-4194	22910	18-1358
19300	18-2452	21593	18-1197	22260	18-4232	22920	18-1372
19310	18-3729	21610	18-1117	22280	18-0550	22930	18-1373
19350	18-3728	21620	18-1155	22290	18-0549	22940	18-1369
19400	18-2453	21622	18-1346	22300	18-2377	22960	18-1118
21010	18-2154	21623	18-1345	22317	18-4244	22980	18-1121
21015	18-2353	21625	18-1398	22320	18-3153	22990	18-1122
21020	18-2155	21630	18-1162	22321	18-4276	23010	18-2778
21030	18-2150	21641	18-0193	22322	18-4277	23011	18-2777
21031	18-2320	21642	18-0195	22323	18-3133	23020	18-2939
21032	18-0647	21643	18-0194	22325	18-3365	23030	18-2199
21033	18-0655	21644	18-0198	22330	18-3725	23040	18-4210
21040	18-2193	21645	18-0200	22340	18-3717	23050	18-4213
21060	18-2164	21646	18-0199	22350	18-3716	23060	18-4214
21070	18-2165	21647	18-0196	22360	18-3369	23070	18-4211
21080	18-2141	21648	18-0197	22370	18-3135	23080	18-2153
21090	18-2163	21649	18-0201	22380	18-3136	23090	18-4204
21100	18-2151	21710	18-2157	22388	18-0653	23100	18-4206
21110	18-3750	21711	18-2145	22390	18-0190	23110	18-2194
21111	18-3768	21715	18-2245-1	22391	18-3233	23140	18-2342
21120	18-3751	21725	18-4236	22407	18-9219	23141	18-3759
21130	18-2152	21731	18-2375	22408	18-2279	23150	18-4208
21131	18-2357	21731	18-23751-9	22409	18-2277	23160	18-4209
21136	18-4295	21731	18-2378	22410	18-2185	23200	18-2346
21140	18-2161	21731	18-23781-9	22411	18-2184	23203	18-7296
21160	18-3720	21740	18-3245	22412	18-2183	23210	18-2294
21161	18-2344	21740	18-6245	22413	18-2186	23220	18-2285
21170	18-3721	21750	18-2170	22414	18-2187	23230	18-4215
21180	18-3722	21770	18-4289	22416	18-2252	23240	18-4212
21190	18-3723	21771	18-2345	22417	18-2251	23260	18-2283
21210	18-3200	21780	18-2160	22420	18-2244	23261	18-2282
21220	18-3204	21790	18-7321	22420	18-22441-9	23270	18-2293
21230	18-3700	21791	18-7311	22420	18-2387	23280	18-2292
21231	18-3737	21800	18-4267	22420	18-23871-9	23300	18-2295
21240	18-3704	21811	18-2140	22421	18-2288	23510	18-2231
21241	18-3726	21820	18-1156	22430	18-2361	23580	18-2230
21242	18-3703	21830	18-1166	22433	18-2326	23590	18-2229
21245	18-0654	21840	18-1153	22435	18-2327	23710	18-3931
21250	18-3701	21850	18-2101	22436	18-2330	23800	18-4122
21251	18-3782	21860	18-1154	22440	18-3229	23810	18-4121
21260	18-3702	21870	18-3199	22445	18-8551	23810	18-4294
21261	18-3781	21880	18-3198	22490	18-2243	23820	18-4112
21290	18-4233	21885	18-1500	22491	18-1501	23830	18-4111
21300	18-4220	21887	18-8111	22500	18-4040	23840	18-4102
21321	18-8348	21890	18-3232	22520	18-1600	23850	18-4101
21330	18-7426	21892	18-4258	22560	18-1601	23910	18-4107
21350	18-4221	21893	18-4263	22612	18-2217	23930	18-4127

GLM (Cont.)		GLM (Cont.)		GLM (Cont.)		GLM (Cont.)	
GLM No.	Sierra No.	GLM No.	Sierra No.	GLM No.	Sierra No.	GLM No.	Sierra No.
23940	18-4123	26490	18-2466-9	30740	18-0359	31640	18-0988
23950	18-4113	27700	18-3767	30760	18-0918	31650	18-2572
23960	18-4103	27720	18-1731	30770	18-0131	31660	18-0356
24010	18-4120	27782	18-1712	30790	18-0410	31670	18-2552
24020	18-4110	27931	18-2192	30800	18-0922	31680	18-2501
24030	18-4100	28020	18-2104	30850	18-4366	31690	18-2509
24040	18-4124	28030	18-2174	30860	18-0868	31710	18-0992
24050	18-4065	28040	18-2097	30870	18-0363	31720	18-2835
24060	18-4114	28050	18-9218	30880	18-0926	31730	18-2573
24080	18-4104	28060	18-6401	30890	18-2513	31740	18-0434
24090	18-4067	28100	18-2128	30900	18-0133	31750	18-0158
24100	18-4066	28180	18-1152	30920	18-0928	31770	18-0903
24110	18-4125	28190	18-1151	30930	18-2512	31780	18-0942
24112	18-4115	28300	18-3231	30940	18-0932	31790	18-0137
24130	18-4105	28310	18-2125	30970	18-0866	31810	18-2804
24140	18-4068	28315	18-2146	30980	18-0372	31820	18-0685
24210	18-3904	28317	18-2337	30990	18-0103	31830	18-0389
24240	18-3910	28318	18-2339	31000	18-0938	31840	18-2843
24250	18-3975	28325	18-2338	31010	18-2914	31850	18-0365
24260	18-3911	28330	18-3712	31020	18-2915	31860	18-2800
24280	18-3912	28340	18-6400	31030	18-2801	31870	18-0369
24290	18-3974	28350	18-3752	31040	18-2826	31880	18-0151
24300	18-3905	28360	18-3713	31050	18-2919	31890	18-2507
24310	18-3913	28370	18-0577	31060	18-2823	31900	18-0147
24330	18-3915	28380	18-2296	31070	18-2824	31900	18-0747
24410	18-4106	28390	18-4296	31080	18-2825	31920	18-2805
24430	18-3933	28400	18-2381	31090	18-2827	31930	18-2836
24430	18-4126	28402	18-2382	31100	18-0872	31940	18-0934
24570	18-3907	30010	18-2340	31100	18-2949	31950	18-2837
24590	18-3908	30020	18-0681	31101	18-2902	31960	18-0371
24830	18-7826	30030	18-2316	31105	18-8536	31970	18-0373
24840	18-7859	30050	18-0123	31110	18-2829	31980	18-0139
24841	18-7869	30060	18-0870	31120	18-2847	31990	18-0936
24880	18-7860	30090	18-2564-1	31130	18-2820	32000	18-2561
24900	18-7861	30100	18-0328	31141	18-2743	32010	18-2500
24910	18-7862	30120	18-0329	31150	18-0894	32030	18-5399
24930	18-7846	30160	18-0895	31160	18-2840	32040	18-0422
24940	18-7845	30170	18-0333	31170	18-29451-9	32050	18-2839
24941	18-7844	30180	18-0334	31171	18-42481-9	32070	18-0946
24950	18-7852-1	30190	18-1209	31180	18-2948	32080	18-2849
24951	18-7848-1	30220	18-0672	31190	18-2841	32090	18-2504
24970	18-7854	30230	18-0893	31200	18-2828	32100	18-2555
24980	18-7855	30240	18-0897	31210	18-2560	32110	18-0385
25000	18-7853-1	30260	18-2810	31220	18-2558	32120	18-2803
25110	18-8207	30270	18-2809	31230	18-2559	32130	18-0357
25115	18-2404	30290	18-2563	31260	18-2568	32140	18-0360
25120	18-8208	30290	18-2566	31270	18-2569	32150	18-2502
25125	18-2405	30300	18-4380	31280	18-2570	32160	18-0667
26030	18-2119	30320	18-2565	31300	18-2571	32170	18-2909
26040	18-2105	30330	18-0344	31310	18-2567	32175	18-8533
26050	18-2106	30350	18-0464	31330	18-4261	32180	18-0994
26060	18-2107	30351	18-1238	31340	18-0164	32190	18-2575
26070	18-2108	30353	18-0428	31350	18-0327	32200	18-2910
26080	18-2109	30353	18-2845	31360	18-0889	32210	18-0347
26090	18-2120	30354	18-0322	31370	18-0874	32220	18-0320
26100	18-2103	30357	18-0664	31380	18-0891	32280	18-2574
26110	18-2112	30359	18-0311	31390	18-0332	32300	18-0948
26120	18-2113	30360	18-0887	31400	18-0879	32320	18-2807
26130	18-2110	30363	18-0740	31410	18-2819	32330	18-0952
26140	18-2111	30370	18-0905	31420	18-1210	32350	18-0384
26170	18-2123	30380	18-2848	31430	18-2831	32360	18-2562
26180	18-2124	30381	18-0435	31440	18-2830	32370	18-0111
26190	18-2114	30390	18-0419	31450	18-2846	32390	18-0185
26200	18-2134	30410	18-0867	31460	18-2553	32400	18-0160
26200	18-2137	30430	18-2514	31470	18-0342	32420	18-2505
26210	18-2116	30440	18-0980	31480	18-0885	32440	18-2808
26220	18-2126	30450	18-0350	31490	18-2832	32450	18-2510
26240	18-2115	30470	18-0352	31500	18-2802	32460	18-0113
26250	18-2136	30480	18-0982	31510	18-2844	32470	18-0881
26310	18-2701	30490	18-0898	31520	18-2833	32480	18-0950
26320	18-2336	30510	18-0353	31530	18-0378	32500	18-0388
26330	18-2702-1	30530	18-0976	31540	18-0462	32510	18-2511
26340	18-4288	30570	18-0904	31550	18-2896	32520	18-2506
26350	18-2341	30580	18-0354	31560	18-2917	32530	18-2503
26400	18-2427	30610	18-0182	31570	18-2912	32540	18-2508-1
26410	18-2426	30640	18-0910	31580	18-2515	32560	18-0945
26440	18-0652	30670	18-0129	31590	18-0568	32580	18-0114
26460	18-2425	30680	18-2806	31600	18-2838	32600	18-0318
26470	18-2424	30700	18-0912	31620	18-2834	32630	18-0954
26480	18-2465-9	30730	18-0149	31630	18-2554	32640	18-2815

GLM (Cont.)		GLM (Cont.)		GLM (Cont.)		GLM (Cont.)	
GLM No.	Sierra No.	GLM No.	Sierra No.	GLM No.	Sierra No.	GLM No.	Sierra No.
32650	18-7106	33780	18-0401	34800	18-1218	36830	18-2854
32680	18-0431	33790	18-0183-1	34850	18-1224	36840	18-0475
32730	18-0386	33795	18-8509	34870	18-0953	37000	18-4313
32740	18-0916	33800	18-0956	34880	18-0957	37010	18-4312
32750	18-0876	33810	18-0943	34890	18-0397	37020	18-4314
32760	18-0323	33820	18-0673	34910	18-3827	37100	18-2991
32770	18-0324	33830	18-2961	34920	18-3829	37110	18-0962
32780	18-0336	33840	18-2947	34930	18-3830	37120	18-0869
32800	18-2343	33850	18-2884	34940	18-3831	37130	18-0154
32820	18-0339	33860	18-2888	34950	18-3805	37150	18-0960
32830	18-0670	33870	18-2964	34960	18-3832	37190	18-0968
32840	18-0341	33880	18-3804	34970	18-0959	37200	18-0119
32870	18-0930	33890	18-3828	34980	18-0961	37210	18-0853
32880	18-0135	33900	18-0548	34990	18-0967	37220	18-0855
32890	18-0374	33910	18-0884	35020	18-2929	37240	18-0857
32920	18-0380	33930	18-0104	35030	18-0391	37250	18-0861
32930	18-0940	33950	18-0913	35060	18-0398	37260	18-0141
32940	18-0944	33960	18-0880	35070	18-0346	37290	18-0863
32950	18-0107	33970	18-0440	35070	18-0349	37310	18-0873
32960	18-0970	34000	18-0679	35080	18-2971	37320	18-0314
32980	18-2850	34010	18-3841-2	35090	18-2729	37330	18-0115
32990	18-2883-1	34020	18-2889	35180	18-0983	37360	18-0958
33010	18-2851	34030	18-2959	35190	18-0112	37370	18-0915
33020	18-0110	34040	18-2891	35200	18-0120	37400	18-0315
33030	18-0430	34050	18-2892	35320	18-0122	37410	18-0854
33050	18-0939	34080	18-0850	35330	18-0126	37430	18-0415
33060	18-2863	34090	18-2893	35340	18-0128	37470	18-0622
33080	18-2907	34120	18-0882	35360	18-0136	37490	18-0345
33090	18-2862	34140	18-2963	35370	18-0138	37500	18-0416
33100	18-2890	34150	18-2895	35380	18-0140	37520	18-0624
33110	18-2879	34200	18-2897	35390	18-0142	37530	18-0644
33120	18-2908	34220	18-2881	35400	18-0144	37540	18-0645
33130	18-2903	34230	18-0917	35410	18-0441	37550	18-0646
33140	18-2906	34240	18-3801	35420	18-0851	37560	18-0642
33150	18-2709	34250	18-3802	35430	18-1205	37570	18-0643
33170	18-2901	34260	18-0929	35440	18-1202	37590	18-0641
33180	18-2867	34280	18-3836	35460	18-0150	37630	18-2942
33190	18-2904	34290	18-2866	35480	18-0157	37640	18-2821
33210	18-2887	34300	18-0117	35540	18-0161	37650	18-2741
33220	18-2880	34310	18-2543	35620	18-0633	37660	18-2740
33230	18-2871	34320	18-2853	35650	18-3898	37670	18-2943
33280	18-2876	34330	18-0969	35730	18-0978	37680	18-2611
33330	18-2861	34340	18-0971	35740	18-0130	37690	18-2610
33340	18-2860	34350	18-2878	35750	18-0987	37760	18-2582
33370	18-2900	34370	18-2544	35780	18-0965	37795	18-0626
33400	18-2960	34380	18-0979	35800	18-0963	37796	18-0628
33410	18-2865	34390	18-0981	35830	18-3895	37797	18-0627
33420	18-2855	34400	18-3837	35840	18-2954	39010	18-4386
33430	18-2877	34410	18-0189	35850	18-3861	39020	18-4387
33440	18-2858	34420	18-0975	35860	18-3862	39030	18-4385
33450	18-2874	34430	18-0989	35870	18-3864	39040	18-4381
33460	18-0973	34440	18-0675	35880	18-3863	39050	18-4383
33470	18-0947	34450	18-2547	35890	18-3871	39060	18-4384
33480	18-0949	34460	18-2550	35900	18-3872	39080	18-4303-1
33500	18-0677	34470	18-0995	35930	18-3866	39090	18-4304-1
33510	18-0955	34480	18-0997	35940	18-3896	39100	18-4358
33511	18-0108	34490	18-0999	35950	18-3838	39110	18-4382
33530	18-2873	34520	18-0124	35960	18-3897	39130	18-0340
33540	18-2956	34530	18-1212	35990	18-2957	39140	18-4350
33560	18-2856	34540	18-0134	36080	18-2968	39150	18-4351
33570	18-1204	34550	18-2865	36090	18-2970	39160	18-0407
33580	18-0680	34560	18-3360	36100	18-3879	39170	18-0465
33590	18-2545	34570	18-3803	36100	18-7879-1	39180	18-4352
33600	18-2546	34580	18-2905	36110	18-3877	39190	18-4353
33610	18-0148	34590	18-3839	36120	18-3878	39230	18-0153
33620	18-2549	34610	18-2913	36130	18-3880	39240	18-4357
33630	18-0985	34620	18-2938	36140	18-3881	39250	18-4319
33640	18-2864	34630	18-2548	36150	18-2946	39260	18-0411
33650	18-0977	34640	18-0933	36160	18-3876	39270	18-4396
33660	18-0991	34650	18-0927	36170	18-3883	39280	18-4394
33680	18-0102	34700	18-0937	36180	18-3887	39290	18-4395
33690	18-0106	34710	18-0188	36200	18-3825	39300	18-4398
33700	18-3899	34720	18-2911	36220	18-3822	39310	18-4399
33710	18-2852	34730	18-2918	36230	18-3823	39320	18-4367
33730	18-2557	34740	18-0935	36240	18-3824	39330	18-4355
33740	18-0118	34750	18-0923	36250	18-3820	39331	18-4340
33750	18-2857	34770	18-2916	36260	18-3814	39332	18-4339
33760	18-0418	34771	18-0911	36290	18-3855	39333	18-4336
33765	18-8532	34780	18-0941	36300	18-3857	39335	18-4334
33770	18-2875	34790	18-0424	36820	18-0476	39336	18-4326

GLM (Cont.)		GLM (Cont.)		GLM (Cont.)		GLM (Cont.)	
GLM No.	Sierra No.	GLM No.	Sierra No.	GLM No.	Sierra No.	GLM No.	Sierra No.
39337	18-4325	40600	18-7219	51430	18-1986	71540	18-5385
39338	18-4338	40610	18-7212	51442	18-1901	71550	18-5389
39340	18-4315	40620	18-7213	51480	18-1848	71560	18-5352
39350	18-4300	40630	18-7214	51510	18-1935-1	71570	18-5369
39350	18-4302	40640	18-7215	51520	18-1936	71580	18-5375
39354	18-4310	40650	18-7750-1	51610	18-1930-1	71590	18-5376
39355	18-4324	40651	18-7226	51630	18-1931-1	71600	18-5353
39360	18-4301	40710	18-7093	51640	18-1932	71710	18-5269
39370	18-4305	40720	18-7094	52080	18-1938	71720	18-5268
39380	18-4306	40800	18-7801	52090	18-1984	71730	18-5275
39390	18-4321	40810	18-7823	52230	18-1983	71740	18-5277
39400	18-4322	40820	18-7820	52240	18-1982	71750	18-5276
39410	18-4323	40830	18-7821	53100	18-4362	71760	18-5271
39420	18-4307	40840	18-7822	53300	18-8529	71770	18-5267
39430	18-4309	40850	18-7800	53330	18-8554	71780	18-5273
39440	18-4317	40860	18-7805	53360	18-8556	71790	18-5274
39470	18-0466	40870	18-7806-1	53430	18-8555	71800	18-5272
39490	18-0348	40900	18-7233	53770	18-8539	71810	18-5281
39500	18-0611	40910	18-7061	54110	18-1899	71820	18-5278
39520	18-4359	40920	18-7057	54250	18-1996	71830	18-5280
39550	18-4356	40930	18-7041	56030	18-1949	72010	18-5179
39560	18-4316	40950	18-7062	56110	18-1999	72020	18-5196
39590	18-2614	40970	18-7295	56120	18-1907	72030	18-5172
39600	18-2620	41120	18-7477	56140	18-1939	72040	18-5192
39620	18-2619-1	44990	18-7956	56230	18-1997-1	72050	18-5194
39630	18-2613	45010	18-4217	56240	18-1898	72060	18-5170
39640	18-2615	45020	18-7179	56250	18-1998-1	72080	18-5176
39650	18-4388	45030	18-7180	70010	18-5303	72100	18-5181
39660	18-4389	45050	18-7190	70020	18-5311	72110	18-5433
39670	18-4390	45060	18-7181	70030	18-5310	72113	18-5443
39690	18-4392	45080	18-7183	70040	18-5318	72114	18-5442
39700	18-4393	45090	18-7184	70050	18-5317	72115	18-5434
39710	18-4375	45100	18-7186	70060	18-5314	72120	18-5178
39720	18-4376	45160	18-7194	70070	18-5156	72130	18-5108
39730	18-4337	45170	18-7185	70080	18-5157	72240	18-5740
39750	18-4379	45180	18-7187	70082	18-5305	72260	18-5711
39770	18-4369	45200	18-7137	70100	18-5306	72310	18-5707
39790	18-4371	45230	18-7100	70110	18-5148	72320	18-5708
39800	18-4372	45250	18-0298	70160	18-5153	72350	18-5709
39810	18-4373	45280	18-7405	70170	18-5140	72360	18-5801
39820	18-4374	46100	18-1219	70200	18-5141	72370	18-5815
39830	18-4368	46110	18-1221	70500	18-5349	72380	18-5820
39840	18-0405	46120	18-3562	70510	18-5347	72390	18-5816
39850	18-1237	46130	18-1222	70520	18-5344	72400	18-5817
39870	18-4347-1	46140	18-3567	70530	18-5345	72402	18-5819
39880	18-4349	46150	18-1243	70540	18-5346	72403	18-5812
39890	18-4348	46160	18-3565	70570	18-5199	72410	18-5802
39910	18-0604	46170	18-3564	70580	18-5338	72420	18-5807
39920	18-0603	46180	18-3563	70590	18-5200	72430	18-5808
40130	18-7832	47110	18-3602	70591	18-5348	72440	18-5814
40130	18-7838	47120	18-3601	70640	18-5205	72460	18-5837
40140	18-7829	47130	18-3603	70660	18-5169	72480	18-5836
40150	18-7830	50006	18-4008	70670	18-5212	72490	18-5838
40160	18-7831	50310	18-1908K	70680	18-5206	72500	18-5834
40280	18-7818-1	50330	18-1906	71000	18-5428	72510	18-5297
40290	18-7817	50610	18-1985	71020	18-5418	72520	18-5296-2
40310	18-7804	51010	18-4009	71030	18-5420	72530	18-5298
40320	18-7807	51030	18-1990	71040	18-5404-1	72540	18-5299
40330	18-7808	51110	18-1970-2	71050	18-5407	72550	18-5295
40340	18-7809	51120	18-1971	71050	18-5425	72570	18-5294
40350	18-7811	51130	18-1972	71060	18-5403	72590	18-5285
40360	18-7812	51140	18-1976-1	71070	18-5432	72600	18-5284
40370	18-7813	51160	18-1975-1	71080	18-5431	72610	18-5250
40380	18-7814	51180	18-1937	71090	18-5411	72620	18-5251
40390	18-7810	51190	18-1978	71100	18-5405	72630	18-5252
40410	18-7004	51210	18-1956-1	71110	18-5408	72640	18-5253
40420	18-7005	51212	18-1955-1	71120	18-5406	72650	18-5260
40435	18-7006-1	51220	18-1952-1	71130	18-5403	72660	18-5258
40460	18-7007	51224	18-1960-1	71400	18-5354	72660	18-5264
40470	18-7013	51230	18-1953-2	71410	18-5362	72670	18-5254
40480	18-7021	51237	18-1950-1	71420	18-5361	72680	18-5256
40490	18-7211-1	51238	18-1951-1	71450	18-5393	72800	18-5011
40500	18-7033	51240	18-1957-1	71460	18-5394	72810	18-5006
40501	18-7037	51250	18-1958-1	71470	18-5356	72820	18-5002
40510	18-7043	51252	18-1962-1	71480	18-5358	72830	18-5003
40530	18-7024	51320	18-1921	71490	18-5357	72840	18-5001
40550	18-7223	51330	18-1909	71500	18-5396	72970	18-5012
40560	18-7042	51340	18-1922	71510	18-5395	72980	18-5008
40570	18-7046	51410	18-1902	71520	18-5384	73010	18-5705
40580	18-7220	51420	18-1903	71530	18-5386	73020	18-5704

GLM (Cont.)		GLM (Cont.)		GLM (Cont.)		GLM (Cont.)	
GLM No.	Sierra No.	GLM No.	Sierra No.	GLM No.	Sierra No.	GLM No.	Sierra No.
73110	18-5116-1	80070	18-7421	82320	18-7140	86100	18-3111
73120	18-5115-1	80080	18-7141	82340	18-7151	86120	18-2025
73180	18-6769-1	80090	18-7120	82350	18-7121	86130	18-2536
73190	18-5107-1	80100	18-7101	82360	18-7172	86140	18-2532
74000	18-5750	80100	18-7109	82370	18-7127	86150	18-2027
74000	18-5950	80100	18-7406	82380	18-7169	86160	18-2059
74000	18-5956	80110	18-7413	82390	18-7167	86170	18-2028
74001	18-5951	80120	18-7168	82400	18-7133	86180	18-2029
74001	18-5957	80130	18-7102	82430	18-7407	86190	18-2031
74100	18-5903	80140	18-7165	82440	18-7144	86200	18-2033
74110	18-5904	80160	18-7166	82460	18-7418	86210	18-2537
74140	18-5905	80160	18-7466	82480	18-7107	86230	18-2539
74140	18-5910	80170	18-7410	82900	18-7957	86240	18-2061
74150	18-5900	80180	18-7105	83200	18-7139	86250	18-2062
74150	18-5911	80220	18-7129	83250	18-7138	86270	18-2063
74170	18-5902	80330	18-7414	83340	18-7160	86300	18-2996
74170	18-5908	80350	18-7412	83410	18-7157	86310	18-2516
74180	18-5901	80380	18-7177	83440	18-7159	86350	18-2021
74180	18-5907	80390	18-7195	84026	18-7474	86360	18-2022
74190	18-5913-1	80420	18-7161	85010	18-2016	86370	18-2000
75370	18-5755	81030	18-7197	85020	18-2049	86380	18-2018
75380	18-5759	81070	18-7111	85030	18-2003	86390	18-2023
75390	18-5760	81080	18-7145	85040	18-2013	86400	18-2024
75400	18-5758	81090	18-7404	85040	18-2026	86410	18-2005
76068	18-7070	81100	18-7116	85050	18-2009	86420	18-2030
76068	18-7746	81100	18-7417	85060	18-2056	86430	18-2032
76081	18-7081	81120	18-7134	85070	18-2014	86440	18-2074
76082	18-7080	81140	18-7174	85080	18-2011	86450	18-2035
76082	18-7089	81140	18-7416	85090	18-0523	86460	18-2064
76083	18-7076	81160	18-7158	85100	18-2019	86470	18-2075
76084	18-7078	81170	18-7440-1	85110	18-2012	86480	18-2704
76085	18-7097	81180	18-7153	85120	18-2051	86481	18-2391
76086	18-7098	81190	18-7103	85130	18-2002	86490	18-2703
76088	18-7017	81210	18-7408	85130	18-2077	86491	18-2705
76096	18-7096	81220	18-7146	85140	18-2944	86492	18-3329
76101	18-7000	81230	18-7156	85150	18-0521	86494	18-3337
76102	18-7001	81230	18-7409	85160	18-0583	86496	18-2392
76103	18-7008	81240	18-7411	85170	18-0522	86497	18-2708
76104	18-7040	81250	18-7143	85200	18-0563	86500	18-2706
76105	18-7085	81260	18-7164	85210	18-2015	86510	18-2034
76107	18-7075	81270	18-7198	85230	18-0514	86520	18-2065
76111	18-7071	81280	18-7403	85260	18-0515	86530	18-2067
76120	18-7086	81290	18-7461	85270	18-0516	86540	18-2769
76123	18-7077	81310	18-7126	85290	18-2017	86570	18-7481
76150	18-7095	81320	18-7457	85330	18-2006	86610	18-2068
76160	18-7072	81340	18-7128	85380	18-0525	86620	18-0166
77010	18-1256	81360	18-7171	85440	18-0517	86630	18-2541
77010	18-7256	81380	18-7130	85460	18-0527	86640	18-7475
77011	18-7286	81390	18-7176	85480	18-2008	86654	18-8352
77040	18-7267	81400	18-7123	85490	18-1211	86660	18-7963
77050	18-7266	81430	18-0858	85520	18-2052	86700	18-2767
77060	18-7265	81430	18-7163	85530	18-2053	86710	18-2768
77070	18-7274	81440	18-7401	85580	18-2055	86711	18-2724
77080	18-7269	81450	18-7108	85581	18-2054	86712	18-2692
77090	18-7275	81470	18-7419	85590	18-2599	86720	18-1240
77101	18-7263	81510	18-7467	85600	18-2007	86740	18-0173
77102	18-7268	81520	18-0860	85610	18-2010	86750	18-0174
77103	18-7270	81540	18-7110	85630	18-0539	86760	18-0542
77105	18-7260	81550	18-7400	85680	18-2048	86760	18-0592
77106	18-7272	81570	18-7449	85700	18-2076	86770	18-0543
77108	18-7271	82030	18-7118	85790	18-0519	86790	18-8307
77113	18-7284	82050	18-7472	85800	18-0526	86810	18-8367
77114	18-7278	82060	18-7959	85810	18-0531	86840	18-0584
77115	18-7289	82080	18-7490	85830	18-0540	87010	18-2990
77116	18-7288	82100	18-7135	85840	18-8353	87020	18-2047
77200	18-4200	82110	18-7420	85850	18-2349	87030	18-2040
77200	18-7200	82130	18-7178	85860	18-1508	87050	18-2043
77220	18-7201	82140	18-7114	85910	18-2094	87060	18-2041
77230	18-7202	82150	18-7117	85960	18-0520	87070	18-2057
77250	18-7208	82170	18-7112	86010	18-2071	87120	18-2093
77260	18-72000	82200	18-7170	86011	18-8300	87130	18-8351
77290	18-7210	82230	18-7155	86012	18-8301	87140	18-8350
79110	18-7605	82240	18-7115	86013	18-8325	87400	18-2649
79120	18-7615	82240	18-7464	86030	18-2001	87410	18-2291
79120	18-7618	82250	18-7173	86040	18-2020	87480	18-2643
79140	18-7616	82260	18-7162	86050	18-2058	87490	18-2645
79150	18-7617	82270	18-7196	86060	18-2060	87500	18-2648
79180	18-7609	82280	18-7104	86070	18-2066	87501	18-2644
79190	18-7608	82280	18-7459	86080	18-2072	87510	18-2652
79210	18-7603	82310	18-7152	86090	18-2073	87511	18-2646-1

GLM (Cont.)		GLM (Cont.)		MALLORY		MALLORY (Cont.)	
GLM No.	Sierra No.	GLM No.	Sierra No.	GLM No.	Sierra No.	MALLORY No.	Sierra No.
87513	18-2642	89230	18-2781	9-01102	18-01000	9-15042	18-6282
87520	18-2653	89240	18-4456	9-01103	18-01100	9-15043	18-5627
87530	18-2654	89250	18-4457	9-01208	18-01302	9-15044	18-6828
87540	18-2655	89260	18-4458	9-01209	18-01308	9-15045	18-6829
87550	18-2590	89450	18-3030	9-01210	18-01311	9-15046	18-6422
87561	18-2622	89451	18-3062	9-01211	18-01312	9-15048	18-6432
87562	18-3760	89480	18-3006	9-01212	18-01313	9-15049	18-6411
87573	18-2627	89490	18-3090	9-01213	18-01314	9-15050	18-6421
87574	18-2628	89500	18-3091	9-01214	18-01301	9-15051	18-6416
87575	18-2629	89510	18-3079	9-01301	18-01200	9-15052	18-6410
87576	18-2697-1	89520	18-3080	9-01302	18-01202	9-15053	18-6430
87580	18-8371	89530	18-3075	9-01412	18-01404	9-15054	18-6417
87590	18-2626	89540	18-3081	9-01413	18-01406	9-15055	18-6425
87600	18-2623	89550	18-3077	9-01414	18-01408	9-15056	18-6414
87601	18-2660	89560	18-3078	9-01416	18-01402	9-15057	18-3423
87602	18-2656	89570	18-3059	9-01417	18-01416	9-15058	18-6427
87603	18-2659	89580	18-3001	9-01418	18-01418	9-15059	18-6426
87604	18-2679	89590	18-3299	9-01419	18-01707	9-15060	18-6433
87605	18-2682	89592	18-3138	9-01420	18-01422	9-15061	18-15061
87606	18-2684	89583	18-3295	9-01504	18-03200	9-15062	18-6418
87607	18-2686	89595	18-3108	9-01505	18-03206	9-15063	18-6833
87608	18-2689	89596	18-3326	9-01506	18-03208	9-15070	18-6873
87609	18-2690	89600	18-3012	9-01601	18-01500	9-15074	18-6868
87611	18-2691	89610	18-3060	9-01703	18-03400	9-15075	18-6868
87614	18-2694	89611	18-3061	9-01704	18-03404	9-15076	18-6906
87616	18-2680	89612	18-3044	9-01805	18-01600	9-15077	18-6867
87617	18-2681	89614	18-8903	9-01806	18-01602	9-15078	18-6862
87618	18-2683	89615	18-8901	9-02003	18-03600	9-15080	18-15080
87619	18-2685	89620	18-3046	9-02004	18-03602	9-15100	BA58003
87620	18-2663	89621	18-3047	9-02005	18-03606	9-15101	18-5806
87621	18-2687	89630	18-3056	9-02006	18-03608	9-15102	18-5837
87622	18-2688	89640	18-3057	9-02108	18-01701	9-15103	18-5836
87630	18-2665	89650	18-3002	9-02109	18-01703	9-15104	18-5808
87640	18-2664	89660	18-3083	9-02110	18-01705	9-15104-10	18-5808
87650	18-2667	89680	18-3043	9-02201	18-07400	9-15105	18-5801
87651	18-2666	89690	18-3055	9-02412	18-09200	9-15106	18-5802
87652	18-2669	89710	18-3053	9-02413	18-09202	9-15107	18-5812
87653	18-2670	89740	18-3087	9-02416	18-09400	9-15108	18-5814
87654	18-2673	89750	18-3051	9-02418	18-09602	9-15109	18-5807
87655	18-2671	89760	18-3086	9-02419	18-09606	9-15110	18-5810
87656	18-2672	89770	18-3050	9-15000	18-5640	9-15111	18-5815
87660	18-2698	89780	18-3368	9-15001	18-5601	9-15112	18-5817
87670	18-8360	89790	18-3104	9-15002	18-5642	9-15112-10	18-5817
87680	18-2658	89800	18-3054	9-15003	18-5608	9-15113	18-5816
87690	18-2657	89810	18-3039	9-15004	18-5613	9-15115	18-5819
87700	18-2625	89820	18-3052	9-15005	18-5629	9-15116	18-5820
87800	18-2630	89830	18-3007	9-15006	18-5630	9-15117	18-5834
87802	18-2637	89840	18-3017	9-15007	18-5634	9-15118	18-5823
87803	18-2632	89850	18-3072	9-15008	18-5648	9-15119	18-5833
87804	18-2638	89860	18-3073	9-15009	18-5636	9-15120	18-5853
87805	18-2639	89870	18-3066	9-15010	18-6441	9-15121	18-5821
87806	18-2633	89880	18-3074	9-15011	18-5617	9-15122	18-5879
87807	18-2640	89890	18-3067	9-15012	18-6439	9-15125	18-5811
87808	18-2624	89900	18-3068	9-15013	18-5622	9-15200	18-5705
87809	18-2635	89910	18-3069	9-15014	18-5618	9-15200-10	18-5705
87810	18-2636	89920	18-3070	9-15015	18-5622	9-15201	18-6271
88170	18-7175	89930	18-3071	9-15016	18-5621	9-15202	18-6268
89010	18-2757	89940	18-3082	9-15017	18-6437	9-15203	18-5821
89020	18-2758	89950	18-3058	9-15018	18-6438	9-15210	18-5849
89030	18-2744	89990	18-3366	9-15019	18-6436	9-15211	18-5851
89040	18-2752	90050	18-4442	9-15020	18-5619	9-15212	18-5852
89050	18-2751	90065	18-4446	9-15021	18-6434	9-15213	18-5850
89060	18-2759	90070	18-9099	9-15022	18-5611	9-15214	18-15214
89070	18-2762	90100	18-9803	9-15023	18-6415	9-15450	18-65450
89080	18-2753-2	90110	18-9806E	9-15024	18-5602	9-15500	18-69550
89090	18-2761	90140	18-9817	9-15025	18-5605	9-15501	18-15501
89100	18-2750	90160	18-9853	9-15026	18-5606	9-15510	18-8220
89120	18-2748	90170	18-9855	9-15027	18-5610	9-15900	18-5913-1
89130	18-2746	90180	18-9856	9-15028	18-5620	9-15901	18-5919
89140	18-2756	90190	18-9858	9-15029	18-5636	9-15902	18-5920
89150	18-2760	90200	18-9861	9-15030	18-6825	9-15903	18-5910
89160	18-2733	90210	18-9857	9-15031	18-6283	9-15904	18-5910
89170	18-2732	90220	18-9854	9-15032	18-5612	9-15905	18-5907
89180	18-2747	90230	18-9868	9-15034	18-5624	9-15906	18-6937
89190	18-2764	90240	18-9842	9-15036	18-5628	9-15907	18-6275-1
89200	18-2765	90260	18-9837	9-15037	18-6826	9-15908	18-5603
89210	18-2763	90270	18-9829	9-15038	18-6413	9-17100	18-5707
89220	18-2745	90280	18-9819	9-15039	18-6440	9-17101	18-5743
89222	18-2780			9-15040	18-5631	9-17200	18-5708
89224	18-2779			9-15041	18-6863	9-17201	18-5709

MALLORY (Cont.)		MALLORY (Cont.)		MALLORY (Cont.)		MALLORY (Cont.)	
MALLORY No.	Sierra No.	MALLORY No.	Sierra No.	MALLORY No.	Sierra No.	MALLORY No.	Sierra No.
9-17202	18-5827	9-19109	18-5983	9-25510	18-5874	9-28029	18-8820-1
9-17203	18-5825	9-19110	18-6293	9-25511	18-5875	9-28030	18-8802-1
9-17204	18-5829	9-19111	18-6298	9-25512	18-5876	9-28031	18-8838-1
9-17205	18-5831	9-19112	18-6454	9-25601	18-5183	9-28032	18-8801-1
9-17206	18-5828	9-19113	18-5957	9-25602	18-25602	9-28035	18-8807-1
9-17207	18-5832	9-19114	18-5943	9-25604	18-25604	9-28039	18-8817-1
9-17208	18-5830	9-19115	18-5959	9-25605	18-25605	9-28042	18-28042
9-17300	18-17300	9-19116	18-19116	9-25650	18-25650	9-28043	18-8823-1
9-18100	18-6756	9-19200	18-6960	9-25651	18-25651	9-28044	18-28044
9-18101	18-6767-1	9-19201	18-6455	9-25652	18-25652	9-28046	18-28046
9-18102	18-6761	9-19202	18-5929	9-26000	18-5480	9-28050	18-28050
9-18103	18-6780	9-19203	18-6844	9-26002	18-26002	9-28056	18-8833-1
9-18104	18-6759	9-19204	18-6455	9-26101	18-5309-1	9-28057	18-8829-1
9-18105	18-6285	9-23100	18-5192	9-26102	18-5312-1	9-28060	18-8818-1
9-18106	18-6281	9-23101	18-5196	9-26103	18-5339-1	9-28080	18-28080
9-18107	18-6277	9-23102	18-5181	9-26104	18-26104-1	9-28081	18-28081
9-18108	18-6816	9-23103	18-5176	9-26105	18-5313-1	9-28082	18-28082
9-18110	18-5632	9-23104	18-5170	9-26106	18-5315-1	9-28083	18-28083
9-18200	18-6279	9-23105	18-5194	9-26107	18-26107-1	9-28084	18-28084
9-18201	18-6774	9-23106	18-5172	9-26110	18-26110-1	9-28085	18-28085
9-18202	18-6775	9-23107	18-5179	9-26111	18-26111-1	9-28086	18-28086
9-18203	18-6777	9-23200	18-5186	9-26112	18-26112-1	9-28090	18-8840-1
9-18204	18-6773	9-23201	18-5187	9-26301	18-5495-2	9-28091	18-8810-1
9-18205	18-6273-1	9-23204	18-5185	9-26302	18-5489-2	9-28092	18-8839-1
9-18206	18-6273-1	9-23206	18-5180	9-26303	18-5496-2	9-28100	18-28100
9-18207	18-6772	9-23250	18-23250	9-26305	18-5497-2	9-28101	18-28101
9-18208	18-18208	9-23251	18-23251	9-26306	18-5494-2	9-28102	18-28102
9-18209	18-6279	9-24500	18-5888	9-26307	18-5498-1	9-28120	18-5225
9-18210	18-6799	9-24501	18-5889	9-26308	18-5496-2	9-28122	18-5224
9-18211	18-6286	9-24502	18-5890	9-26309	18-5487-2	9-28123	18-5752
9-18212	18-6765	9-25000	18-5759	9-26310	18-26310-2	9-28124	18-5750
9-18213	18-6273-1	9-25001	18-5760	9-26311	18-26311-2	9-28150	18-28150
9-18214	18-6757	9-25002	18-5758	9-26700	18-5484-1	9-28151	18-28151
9-18215	18-6774	9-25004	18-5782	9-26702	18-5476	9-28175	18-28175
9-18300	18-6785	9-25005	18-5783	9-26750	18-5350	9-29000	18-5317
9-18301	18-6786-1	9-25006	18-5784	9-26751	18-5351	9-29001	18-5148
9-18302	18-6793	9-25007	18-5761	9-26800	18-26800	9-29002	18-5307
9-18303	18-18303	9-25008	18-5762	9-26804	18-26804	9-29003	18-5310
9-18304	18-18304	9-25009	18-5763	9-26807	18-26807	9-29004	18-5303
9-18305	18-18305	9-25010	18-5764	9-26810	18-26810	9-29005	18-5314
9-18306	18-6822	9-25011	18-5766	9-26811	18-26811	9-29006	18-5311
9-18400	18-6782	9-25012	18-5767	9-26812	18-26812	9-29008	18-5156
9-18401	18-6789	9-25013	18-5785	9-26813	18-26813	9-29009	18-5318
9-18402	18-6783	9-25017	18-5772	9-26815	18-26815	9-29100	18-5345
9-18403	18-6821	9-25018	18-5773	9-26820	18-26820	9-29101	18-5338
9-18405	18-6760	9-25019	18-5781	9-26821	18-26821	9-29102	18-5169
9-18406	18-6259	9-25020	18-5893	9-26823	18-26823	9-29103	18-5344
9-18407	18-6781	9-25021	18-5770	9-26825	18-26825	9-29104	18-5345
9-18408	18-6788	9-25022	18-5891	9-26900	18-5297	9-29107	18-5348
9-18409	18-18409	9-25023	18-5892	9-26901	18-5294	9-29108	18-5347
9-18410	18-6787	9-25024	18-5885	9-26902	18-5299	9-29109	18-5206
9-18411	18-6798	9-25026	18-5794-1	9-26903	18-5298	9-29110	18-5207
9-18412	18-6836	9-25027	18-5887	9-26904	18-5296-2	9-29114	18-5346
9-18500	18-6769-1	9-25028	18-5774-1	9-28000	18-8803-2	9-29200	18-5431
9-18540	18-6823	9-25029	18-5780	9-28001	18-8804-1	9-29201	18-5407
9-18600	18-6755	9-25030	18-5884	9-28002	18-8804-1	9-29202	18-5418
9-18601	18-6257	9-25100	18-5775	9-28003	18-8802-1	9-29203	18-5403
9-18602	18-6779	9-25101	18-5776	9-28004	18-8811-1	9-29204	18-5419
9-18603	18-6758	9-25102	18-5777	9-28005	18-5228-1D	9-29205	18-5428
9-18604	18-6274	9-25103	18-5778	9-28006	18-5231-1	9-29206	18-5102
9-18607	18-6754	9-25104	18-5881	9-28009	18-8828-1	9-29207	18-5404-1
9-18608	18-6790	9-25105	18-5787	9-28010	18-8803-2	9-29208	18-5430
9-18609	18-6791	9-25107	18-5790	9-28011	18-8832-1	9-29209	18-5405
9-18610	18-6792	9-25108	18-5791	9-28012	18-8803-2	9-29210	18-5411
9-18611	18-6771	9-25109	18-5793	9-28013	18-8813-1	9-29211	18-5427
9-18612	18-6778	9-25110	18-5792	9-28014	18-8808-2	9-29212	18-5428
9-18613	18-6822	9-25200	18-25200	9-28015	18-8801-1	9-29213	18-5429
9-18614	18-6804	9-25201	18-25201	9-28016	18-8810-1	9-29214	18-5403
9-18615	18-6806	9-25300	18-25300	9-28017	18-8809-1	9-29217	18-5245
9-18616	18-6274	9-25302	18-5132	9-28018	18-28018	9-29218	18-5432
9-18618	18-18618	9-25400	18-25400	9-28019	18-8845-1	9-29220	18-5406
9-19100	18-5956	9-25500	18-5854	9-28020	18-8800-1	9-29221	18-5408
9-19101	18-5966	9-25502	18-5857	9-28021	18-8803-2	9-29222	18-5402
9-19102	18-5967	9-25503	18-5859	9-28022	18-8823-1	9-29223	18-5413
9-19103	18-5965	9-25504	18-5860	9-28023	18-8835-1	9-29300	18-5250
9-19104	18-5960	9-25505	18-5864	9-28024	18-8830-1	9-29301	18-5251
9-19105	18-6927	9-25506	18-5865	9-28025	18-8805-1	9-29303	18-5256
9-19106	18-5959	9-25507	18-5870	9-28026	18-8806-1	9-29304	18-5260
9-19107	18-6299	9-25508	18-5871	9-28027	18-8814-1	9-29305	18-5264
9-19108	18-5984	9-25509	18-5873	9-28028	18-8811-1	9-29307	18-5284

MALLORY (Cont.)		MALLORY (Cont.)		MALLORY (Cont.)		MALLORY (Cont.)	
MALLORY No.	Sierra No.	MALLORY No.	Sierra No.	MALLORY No.	Sierra No.	MALLORY No.	Sierra No.
9-29308	18-5281	9-32100	18-7655	9-34602	18-34602	9-37107	18-7222
9-29309	18-5260	9-32101	18-7656	9-34603	18-34603	9-37108	18-7221
9-29310	18-5258	9-32150	18-32150	9-34604	18-34604	9-37109	18-7219
9-29311	18-5268	9-32151	18-32151	9-34605	18-34605	9-37110	18-7220
9-29312	18-5272	9-32201	18-7658	9-35000	18-35000	9-37300	18-7005
9-29313	18-5271	9-33100	18-33100	9-35102	18-35102	9-37302	18-7013
9-29314	18-5276	9-33102	18-7688	9-35300	18-7334	9-37303	18-7211-1
9-29315	18-5275	9-33104	18-33104	9-35301	18-7349	9-37304	18-7212
9-29316	18-5277	9-33105	18-7686	9-35302	18-35302	9-37305	18-7213
9-29317	18-5274	9-33106	18-7685	9-35305	18-7334	9-37306	18-7007
9-29318	18-5247	9-33107	18-7689	9-35325	18-7839	9-37307	18-7007
9-29319	18-5246	9-33200	18-7652	9-35326	18-7843	9-37308	18-7006-1
9-29320	18-5280	9-33201	18-33201	9-35327	18-7788	9-37309	18-7354
9-29321	18-5278	9-33202	18-7683	9-35328	18-7787	9-37310	18-7355
9-29323	18-5012	9-33207	18-33207	9-35329	18-7822	9-37311	18-7356
9-29324	18-5283	9-33208	18-7683	9-35345	18-0849	9-37400	18-7752
9-29330	18-5012	9-33209	18-33209	9-35350	18-7350	9-37401	18-7773
9-29350	18-5273	9-33210	18-7682	9-35351	18-7351	9-37402	18-7753
9-29351	18-5012	9-33211	18-33211	9-35352	18-7352	9-37403	18-7754
9-29400	18-5396	9-33301	18-7695	9-35353	18-7353	9-37404	18-7755
9-29401	18-5385	9-33302	18-7692	9-35400	18-7254	9-37500	18-7293
9-29402	18-5376	9-33303	18-7696	9-35401	18-7255	9-37501	18-7291
9-29403	18-5395	9-33304	18-7693	9-35402	18-7256	9-37502	18-7766
9-29404	18-5393	9-33305	18-7690	9-35404	18-7258	9-37503	18-7768
9-29405	18-5394	9-33306	18-7694	9-35405	18-7260	9-37504	18-7747
9-29406	18-5356	9-33400	18-7697	9-35408	18-7264	9-37505	18-7765
9-29407	18-5386	9-33401	18-7632	9-35409	18-7265	9-37506	18-7769
9-29408	18-5384	9-33402	18-7704	9-35410	18-7266	9-37507	18-7772
9-29409	18-5357	9-33403	18-7705	9-35411	18-7267	9-37508	18-7737
9-29410	18-5358	9-33500	18-7703	9-35412	18-7268	9-37509	18-7756
9-29411	18-5354	9-33503	18-7677	9-35414	18-7270	9-37510	18-7738
9-29412	18-5352	9-33504	18-7679	9-35416	18-7272	9-37511	18-7736
9-29413	18-5369	9-33600	18-7688	9-35417	18-7274	9-37512	18-7743
9-29414	18-5359	9-33601	18-7684	9-35418	18-7275	9-37513	18-7741
9-29416	18-5375	9-33602	18-7682	9-35419	18-7278	9-37514	18-7747
9-29417	18-29417	9-33603	18-7688	9-35421	18-7281	9-37515	18-7742
9-29418	18-5397	9-33604	18-7680	9-35422	18-7282	9-37516	18-7759
9-29419	18-5244	9-33700	18-7757	9-35423	18-7283	9-37517	18-7739
9-29420	18-5243	9-33701	18-7630	9-35424	18-7284	9-37518	18-7744
9-29421	18-5389	9-33702	18-7700	9-35425	18-7286	9-37519	18-7740
9-29423	18-5248	9-33800	18-33800	9-35426	18-7288-1	9-37600	18-7000
9-29424	18-5361	9-33850	18-7513	9-35427	18-7289	9-37601	18-7001
9-29425	18-5362	9-34000	18-7609-1	9-35428	18-7326	9-37602	18-7008
9-29426	18-5353	9-34001	18-7608-1	9-35429	18-7326	9-37603	18-7085
9-29700	18-5433	9-34002	18-7610-1	9-35430	18-7330	9-37604	18-7071
9-29701	18-5438	9-34003	18-7603-1	9-35431	18-7331	9-37605	18-7075
9-29702	18-5434	9-34004	18-7615-1	9-35433	18-35433	9-37606	18-7076
9-29703	18-5435	9-34005	18-7616-1	9-35434	18-7333	9-37607	18-7078
9-29704	18-7492	9-34006	18-7617-1	9-35435	18-35435	9-37608	18-7081
9-29705	18-5437	9-34007	18-7605-1	9-35436	18-35436	9-37610	18-7086
9-29707	18-5436	9-34008	18-7618-1	9-35437	18-35437	9-37611	18-7096
9-29708	18-5443	9-34009	18-7604-1	9-35438	18-35438	9-37612	18-7098-1
9-29709	18-7648	9-34010	18-7619-1	9-35439	18-35439	9-37613	18-7727
9-29710	18-7493	9-34011	18-7613-1	9-35440	18-35440	9-37614	18-7728
9-29711	18-5465	9-34013	18-7611-2	9-36700	18-8115	9-37615	18-7729
9-29716	18-29716	9-34040	18-7665	9-36800	18-7094	9-37616	18-7070
9-29717	18-29717	9-34041	18-7664	9-36801	18-7093	9-37617	18-7077
9-29720	18-29720	9-34064	18-7609-1	9-36802	18-7061	9-37618	18-7097
9-29722	18-29722	9-34066	18-7611-2	9-36803	18-7296	9-37619	18-7080
9-29723	18-29723	9-34068	18-7611-2	9-36850	18-36850	9-37620	18-7072
9-29800	18-5107-1	9-34069	18-7605-1	9-36900	18-7210	9-37621	18-7095
9-29801	18-5488	9-34070	18-7604-1	9-36901	18-7201	9-37622	18-7236
9-29804	18-5116-1	9-34071	18-7618-1	9-36903	18-7202	9-37623	18-7237
9-29806	18-7642	9-34074	18-7618-1	9-36905	18-36905	9-37624	18-7238
9-29807	18-5117	9-34075	18-34075	9-36906	18-36906	9-37625	18-7239
9-29808	18-5103	9-34076	18-7615-1	9-36950	18-7209	9-37626	18-7241
9-29809	18-5105	9-34077	18-7615-1	9-36951	18-7381	9-37627	18-7242
9-29820	18-7706	9-34078	18-7615-1	9-36952	18-7380	9-37628	18-7243
9-29821	18-7646	9-34081	18-7489	9-36953	18-36953	9-37629	18-7244
9-29822	18-7643	9-34082	18-7605-1	9-36954	18-7382	9-37630	18-7245
9-29900	18-5450	9-34084	18-7640	9-36955	18-7208	9-37631	18-7246
9-29901	18-5451	9-34085	18-7640	9-36956	18-36956	9-37632	18-7017
9-29904	18-29904	9-34086	18-7604-1	9-37000	18-7037	9-37633	18-7040
9-31100	18-7228	9-34100	18-34100	9-37100	18-7046	9-37637	18-79900
9-31101	18-7234	9-34110	18-34110	9-37101	18-7223	9-37638	18-79901
9-31102	18-31102	9-34120	18-34120	9-37102	18-7247	9-37639	18-7748
9-31103	18-31103	9-34140	18-34140	9-37103	18-7248	9-37640	18-7749
9-31107	18-31107	9-34500	18-34500	9-37104	18-7024	9-37700	18-7821
9-31108	18-7231	9-34600	18-34600	9-37105	18-7042	9-37701	18-7800
9-31109	18-7232	9-34601	18-34601	9-37106	18-7043	9-37702	18-7820

MALLORY (Cont.)		MALLORY (Cont.)		MALLORY (Cont.)		MALLORY (Cont.)	
MALLORY No.	Sierra No.	MALLORY No.	Sierra No.	MALLORY No.	Sierra No.	MALLORY No.	Sierra No.
9-37750	18-7808	9-38011	18-8091	9-40473	18-8524	9-42500	18-1989
9-37751	18-7812	9-38012	18-80402	9-40475	18-8536	9-42501	18-3531
9-37752	18-7813	9-38013	18-8062	9-40478	18-8519	9-42502	18-1994
9-37753	18-7814	9-38014	18-8056	9-40477	18-8523	9-42503	18-1977-1
9-37754	18-7818-1	9-38015	18-8092	9-40478	18-8547	9-42506	18-1977-1
9-37755	18-7810	9-38016	18-8055	9-40479	18-8547	9-42601	18-3573
9-37756	18-7811	9-38016-25	18-8055	9-40500	18-1960-1	9-42602	18-3581
9-37800	18-7844	9-38017	18-8042	9-40501	18-1962-1	9-42604	18-3574
9-37801	18-7845	9-38017-25	18-8042	9-40502	18-1958-1	9-42605	18-3575
9-37803	18-7846	9-38018	18-8074	9-40503	18-1950-1	9-42606	18-3583
9-37804	18-7789	9-38018-25	18-8074	9-40504	18-1951-1	9-42607	18-3584-1
9-37805	18-7967	9-38019	18-8054	9-40505	18-1952-1	9-42608	18-42608
9-37806	18-7968	9-38020	18-8073	9-40506	18-1957-1	9-42700	18-2766
9-37807	18-7866	9-38021	18-8109	9-40507	18-1953-2	9-42720	18-0549
9-37808	18-7865	9-38022	18-8108	9-40530	18-1908	9-42721	18-0550
9-37810	18-7948	9-38023	18-8043	9-40531	18-1985	9-42800	18-2727
9-37811	18-7919	9-38030	18-80403	9-40532	18-1906	9-42801	18-2733
9-37812	18-7947	9-38031	18-8070	9-40540	18-4008	9-42802	18-2732
9-37815	18-7861	9-38032	18-8069	9-40541	18-4009	9-43000	18-3552
9-37820	18-7860	9-38033	18-8082	9-40543	18-1995	9-43001	18-3555
9-37821	18-7784	9-38034	18-8068	9-40545	18-4256	9-43002	18-3649
9-37822	18-7854	9-38039	18-8078	9-40546	18-4264	9-43004	18-3662
9-37823	18-7859	9-38040	18-8075	9-40550	18-1905	9-43005	18-3663
9-37825	18-7717	9-38041	18-8083	9-40551	18-1937	9-43006	18-3658
9-37826	18-7721	9-38100	18-8004EP-1	9-40552	18-1972	9-43007	18-3654
9-37827	18-7977	9-38120	18-8013EP-1	9-40553	18-1973	9-43008	18-3660
9-37850	18-7848-1	9-38121	18-8032EP-1	9-40554	18-1974-1	9-43009	18-3539
9-37851	18-7852-1	9-38140	18-8015EP-1	9-40555	18-1975-1	9-43010	18-3666
9-37852	18-7775-1	9-40100	18-1999	9-40556	18-1978	9-43011	18-3664
9-37853	18-7848-1	9-40102	18-1898	9-40557	18-1970-2	9-43012	18-3659
9-37855	18-7777-1	9-40110	18-1997-1	9-40558	18-1971	9-43013	18-3551
9-37856	18-7776-1	9-40111	18-1998-1	9-40559	18-1976-1	9-43014	18-3549
9-37857	18-7965-1	9-40112	18-1907	9-40570	18-8512	9-43015	18-43015
9-37860	18-7853-1	9-40113	18-1939	9-40573	18-8520	9-43016	18-3555
9-37861	18-7775	9-40120	18-1992-1	9-40574	18-8531	9-43017	18-43017
9-37862	18-7777	9-40130	18-1949	9-40575	18-8532	9-43018	18-3656
9-37863	18-7776	9-40170	18-4362	9-40576	18-8533	9-43019	18-3553
9-37880	18-7932	9-40171	18-4364	9-40577	18-8500	9-43020	18-3550
9-37881	18-7951	9-40172	18-8538	9-40578	18-8505	9-43021	18-3554
9-37882	18-7928	9-40173	18-8535	9-40579	18-8514	9-43022	18-3559
9-37883	18-7929	9-40174	18-8536	9-40580	18-8529	9-43023	18-3561
9-37884	18-7922	9-40200	18-1914	9-40581	18-8530	9-43024	18-3557
9-37885	18-7924	9-40270	18-8516	9-40582	18-8554	9-43025	18-3556
9-37886	18-7937	9-40300	18-1915	9-40583	18-8555	9-43026	18-3676
9-37887	18-7938	9-40301	18-1941	9-40584	18-8556	9-43027	18-3560
9-37903	18-8124	9-40302	18-1942	9-40585	18-8551	9-43028	18-3677
9-37905	18-7942	9-40303	18-1940	9-40586	18-4362	9-43029	18-3534
9-37906	18-7940	9-40310	18-1913	9-40601	18-1903	9-43030	18-3546
9-37907	18-37907	9-40311	18-1944	9-40602	18-1902	9-43031	18-3545
9-37908	18-7858	9-40312	18-1945	9-40610	18-1921	9-43032	18-3544
9-37950	18-7828-1	9-40313	18-1946	9-40611	18-1922	9-43035	18-3540
9-37951	18-7720	9-40314	18-1948	9-40670	18-8534	9-43036	18-3544
9-37952	18-7786	9-40315	18-6600	9-40671	18-8502	9-43037	18-3541
9-37952-10	18-7786	9-40340	18-1911	9-40672	18-8507	9-43038	18-3609
9-37953	18-7785	9-40370	18-8517	9-40770	18-8535	9-43051	18-43051
9-37954	18-7790	9-40371	18-8526	9-40800	18-1996	9-43052	18-43052
9-37955	18-7791	9-40372	18-8527	9-40810	18-1899	9-43100	18-3648
9-37956	18-8225	9-40373	18-4360	9-40870	18-8503	9-43101	18-3672
9-37957	18-8226	9-40375	18-8501	9-40871	18-8504	9-43150	18-3668
9-37958	18-7829	9-40376	18-8506	9-40900	18-1930-1	9-43151	18-3646
9-37959	18-7830	9-40377	18-8518	9-40901	18-1931-1	9-43152	18-3651
9-37960	18-7831	9-40400	18-1926	9-40902	18-1986-1	9-43153	18-3650
9-37961	18-7979	9-40401	18-1927	9-40910	18-1935-1	9-43154	18-3671
9-37965	18-79910	9-40402	18-1933	9-40911	18-1909-1	9-43155	18-3569
9-37966	18-79907	9-40403	18-1982	9-40970	18-8511	9-43156	18-3653
9-37967	18-79900	9-40404	18-1983	9-40971	18-8539	9-43157	18-3647
9-37968	18-79901	9-40410	18-1916	9-40972	18-8510	9-43175	18-43175
9-37969	18-7713	9-40411	18-1918	9-41100	18-9010	9-43176	18-3624
9-37970	18-7981	9-40412	18-1919	9-41200	18-4224	9-43177	18-3608
9-37980	18-7113-9	9-40413	18-1924	9-41201	18-4218	9-43178	18-3609
9-38001	18-80406	9-40414	18-1925	9-41202	18-4227	9-43200	18-3206
9-38002	18-8079	9-40415	18-1928	9-41203	18-4226	9-43201	18-3119
9-38003	18-8085	9-40416	18-1929	9-41203-10	18-4226	9-43202	18-3118
9-38004	18-8076	9-40417	18-1934	9-41205	18-4258	9-43203	18-3405
9-38005	18-80420	9-40418	18-8112	9-42400	18-5897	9-43204	18-3336
9-38006	18-8071	9-40419	18-1938	9-42401	18-5898	9-43205	18-3367
9-38007	18-80400	9-40430	18-1984	9-42402	18-7600	9-43206	18-3363
9-38008	18-38008	9-40440	18-1917	9-42404	18-7601	9-43208	18-3129
9-38009	18-80401	9-40470	18-8515	9-42406	18-7702	9-43209	18-3180
9-38010	18-8063	9-40471	18-8521	9-42407	18-7647	9-43211	18-3116

MALLORY (Cont.)		MALLORY (Cont.)		MALLORY (Cont.)		MALLORY (Cont.)	
MALLORY No.	Sierra No.	MALLORY No.	Sierra No.	MALLORY No.	Sierra No.	MALLORY No.	Sierra No.
9-43212	18-43212	9-44066	18-75125	9-45309	18-3062	9-48220	18-3400
9-43220	18-1398	9-44067	18-70945	9-45309-10	18-3062	9-48222	18-3388
9-43250	18-3170	9-44068	18-70946	9-45310	18-3016-1	9-48300	18-3207
9-43251	18-3171	9-44069	18-70947	9-45310-10	18-3016-1	9-48301	18-3507
9-43252	18-3173	9-44070	18-70948	9-45311	18-3052	9-48302	18-3323
9-43254	18-3356	9-44072	18-71218	9-45312	18-45312	9-48303	18-3322
9-43262	18-3185	9-44073	18-70957	9-45375	18-3087	9-48304	18-3217
9-43263	18-43263	9-44074	18-70958	9-45375-10	18-3087	9-48305	18-3317
9-43300	18-3424	9-44075	18-70949	9-45400	18-8923	9-48306	18-3319
9-43301	18-3423	9-44077	18-70950	9-45401	18-8920	9-48307	18-3320
9-43302	18-3422	9-44079	18-70952	9-45402	18-8924	9-48308	18-3321
9-43304	18-3414	9-44080	18-70953	9-45404	18-45404	9-48309	18-3314
9-43305	18-3416	9-44081	18-70954	9-45500	18-3099	9-48310	18-3316
9-43306	18-3417	9-44083	18-70955	9-45501	18-3094	9-48311	18-3517
9-43307	18-3419	9-44084	18-70956	9-45502	18-3095	9-48312	18-3324
9-43308	18-3420	9-44092	18-44092	9-45503	18-3023	9-48313	18-3214
9-43309	18-3421	9-45000	18-8901	9-45504	18-3097	9-48314	18-3571
9-43330	18-3445	9-45001	18-3030	9-45507	18-3035	9-48315	18-3147
9-43400	18-3117	9-45001-10	18-3030	9-45600	18-3067	9-48316	18-3237
9-43401	18-3141	9-45003	18-45003	9-45601	18-3068	9-48317	18-48317
9-43403	18-3343	9-45004	18-8903	9-45601-10	18-3068	9-48350	18-3150
9-43404	18-3178	9-45100	18-3245	9-45602	18-3069	9-48600	18-3148
9-43407	18-3107	9-45101	18-3246	9-45602-10	18-3069	9-48601	18-3310
9-43408	18-3126	9-45102	18-3247	9-45603	18-3070	9-48602	18-3370
9-43413	18-3122	9-45103	18-3248	9-45603-10	18-3070	9-48603	18-3395
9-43500	18-3145	9-45104	18-3250	9-45604	18-3072	9-48604	18-3397
9-43502	18-3114	9-45105	18-3249	9-45605	18-3074	9-48605	18-3148
9-43504	18-3358	9-45106	18-3031	9-45606	18-3088	9-48606	18-3370
9-43505	18-3346	9-45200	18-3051	9-45607	18-3040	9-48608	18-3451
9-43508	18-3182	9-45200-10	18-3051	9-45608	18-3063	9-48609	18-3433
9-43525	18-3179	9-45201	18-3050	9-45609	18-3071	9-48610	18-3440
9-43601	18-3113	9-45201-10	18-3050-10	9-45609-10	18-3071	9-48611	18-3442
9-43603	18-3329	9-45202	18-3055	9-45610	18-3066	9-48612	18-3430
9-43604	18-3110	9-45203	18-3043	9-45611	18-3073	9-48613	18-3450
9-43612	18-2705	9-45204	18-3104	9-45612	18-3042	9-48614	18-3311
9-43613	18-3337	9-45204-10	18-3104	9-45613	18-3065	9-48615	18-3313
9-43615	18-2392	9-45205	18-3091	9-45614	18-8910	9-48616	18-3371
9-43622	18-7139	9-45206	18-3059	9-45615	18-8911	9-48617	18-3433
9-43623	18-3109	9-45206-10	18-3059-10	9-45616	18-9825	9-48618	18-3396
9-43624	18-2708	9-45207	18-3053	9-45617	18-45617	9-48619	18-48619
9-43628	18-2599	9-45207-10	18-3053	9-45700	18-3089	9-48700	18-3279
9-43629	18-2948	9-45208	18-3368	9-45701	18-3075	9-48701	18-3280
9-43631	18-7116	9-45209	18-3083	9-45702	18-3080	9-48702	18-3282
9-43632	18-7481	9-45209-10	18-3083	9-45703	18-3081	9-48703	18-3278
9-43700	18-3326	9-45210	18-3090	9-45704	18-3306	9-50000	18-50000
9-43702	18-3293	9-45211	18-3104	9-45705	18-3205	9-50001	18-50001
9-43703	18-3108	9-45212	18-3366	9-45706	18-3047	9-51000	18-51000
9-43711	18-9075	9-45213	18-3082	9-45707	18-3060	9-51001	18-51001
9-43712	18-9076	9-45214	18-3091	9-45707-10	18-3060	9-51002	18-51002
9-43713	18-9078	9-45215	18-3002	9-45708	18-3061	9-51003	18-51003
9-43714	18-9077	9-45215-10	18-3002	9-45709	18-3076	9-51100	18-1361
9-43715	18-9079	9-45216	18-3001	9-45710	18-3077	9-51103	18-1374
9-43716	18-43716	9-45216-10	18-3001	9-45711	18-3078	9-51104	18-1360
9-43720	18-3293	9-45217	18-3006	9-45712	18-45712	9-51105	18-1391
9-43801	18-3136	9-45219	18-3096	9-45713	18-45713	9-51106	18-1395
9-43813	18-2379	9-45220	18-3044	9-45714	18-45714	9-51200	18-1346
9-43814	18-2377	9-45221	18-45221	9-45715	18-3078	9-51202	18-1154
9-44000	18-4456	9-45222	18-3006	9-45716	23-2000	9-51204	18-1345
9-44001	18-4457	9-45280	18-3058	9-45717	18-3079	9-51207	18-1347
9-44002	18-4458	9-45281	18-3086	9-45800	18-3586	9-51209	18-1196
9-44003	18-2778	9-45283	18-3212-1	9-48200	18-3315-2	9-51211	18-4038
9-44004	18-2775	9-45284	18-3286	9-48201	18-3327	9-51300	18-1414
9-44005	18-2774	9-45285	18-3348	9-48202	18-3211	9-51302	18-1415
9-44010	18-3221	9-45286	18-3386	9-48203	18-3392	9-51303	18-1412
9-44050	18-70931	9-45300	18-3007	9-48204	18-3378	9-51304	18-1417
9-44051	18-70934	9-45300-10	18-3007-10	9-48205	18-3381	9-51306	18-1416
9-44052	18-71337	9-45301	18-8900	9-48206	18-3384	9-51401	18-1411
9-44053	18-70944	9-45301-10	18-8900	9-48207	18-3399	9-51403	18-4077
9-44054	18-70935	9-45302	18-3098	9-48208	18-3393	9-51406	18-4078
9-44055	18-70933	9-45302-10	18-3098	9-48209	18-3394	9-52100	18-1752
9-44056	18-70925	9-45303	18-3057	9-48210	18-3390	9-52101	18-1753
9-44057	18-70938	9-45303-10	18-3057	9-48211	18-3382	9-52300	18-1757
9-44058	18-70940	9-45304	18-3054	9-48212	18-3383	9-52301	18-1759
9-44059	18-70932	9-45305	18-3039	9-48213	18-3389	9-52302	18-1758
9-44060	18-70939	9-45305-10	18-3039	9-48214	18-2704	9-52400	18-1755
9-44061	18-70941	9-45306	18-3017	9-48215	18-2706	9-52401	18-1756
9-44062	18-75100	9-45306-10	18-3017-10	9-48216	18-2703	9-52404	18-4157
9-44063	18-70942	9-45307	18-3056	9-48217	18-7963	9-53200	18-4620
9-44064	18-70943	9-45307-10	18-3056-10	9-48218	18-3133	9-53202	18-4622
9-44065	18-70930	9-45308	18-3012	9-48219	18-3135	9-53210	18-4018

MALLORY (Cont.)		MALLORY (Cont.)		MALLORY (Cont.)		MALLORY (Cont.)	
MALLORY No.	Sierra No.	MALLORY No.	Sierra No.	MALLORY No.	Sierra No.	MALLORY No.	Sierra No.
9-53224	18-4530	9-54417	18-3906	9-60005	18-2553	9-60324	18-99021
9-53232	18-4635	9-54418	18-3905	9-60006	18-2554	9-60325	18-99023
9-53233	18-4636	9-54420	18-3901	9-60007	18-2917	9-60326	18-99024
9-53246	18-4623	9-54422	18-3905	9-60007-10	18-2917	9-60328	18-99032
9-53248	18-4625	9-54424	18-4088	9-60008	18-2552	9-60329	18-99033
9-53250	18-4626	9-54425	18-4089	9-60009	18-0398	9-60330	18-99034
9-53252	18-4628	9-54426	18-4090	9-60010	18-2844	9-60335	18-99005
9-53256	18-4643	9-54432	18-3975	9-60011	18-2834	9-60336	18-99009
9-53257	18-4644	9-54434	18-3974	9-60012	18-2831	9-60339	18-99017
9-53260	18-4639	9-54436	18-3907	9-60016	18-2858	9-60340	18-99020
9-53261	18-4640	9-54438	18-3908	9-60017	18-2947	9-60341	18-99026
9-53265	18-4575	9-54804	18-3963	9-60020	18-2564-1	9-60342	18-0618
9-53401	18-4115	9-54808	18-3960	9-60021	18-2563	9-60343	18-0656
9-53412	18-4107	9-54812	18-3969	9-60022	18-2565	9-60344	18-99047
9-53413	18-4117	9-54816	18-3934	9-60023	18-2566	9-60345	18-99047
9-53416	18-4124	9-54817	18-3936	9-60026	18-2593	9-60346	18-99028
9-53417	18-4114	9-54904	18-4294	9-60027	18-0622	9-60347	18-99028
9-53418	18-4104	9-55000	18-15550	9-60028	18-2801	9-60348	18-99028
9-53420	18-4120	9-55001	18-15520	9-60029	18-2824	9-60353	18-99001
9-53421	18-4110	9-55002	18-15460	9-60030	18-2825	9-60354	18-99004
9-53422	18-4100	9-55003	18-15480	9-60031	18-2919	9-60356	18-99013
9-53424	18-4112	9-55004	18-15410	9-60033	18-2841	9-60357	18-99079
9-53425	18-4111	9-55005	18-15370	9-60034	18-2914	9-60358	18-99015
9-53426	18-4102	9-55006	18-15440	9-60035	18-2915	9-60360	18-99022
9-53427	18-4101	9-55007	18-15490	9-60036	18-2826	9-60361	18-99025
9-53430	18-4122	9-55020	18-18000	9-60037	18-0894	9-60362	18-99030
9-53432	18-4063	9-55021	18-18100	9-60038	18-2562	9-60365	18-99045
9-53434	18-4064	9-55022	18-15113	9-60039	18-2823	9-60366	18-99046
9-53436	18-4195	9-55023	18-15115	9-60040	18-0315	9-60378	18-0239
9-53437	18-4086	9-55025	18-15113	9-60041	18-0115	9-60380	18-0756-1
9-53438	18-4165	9-55026	18-15102	9-60042	18-0879	9-60382	18-0240
9-53439	18-4087	9-55027	18-15104	9-60043	18-0670	9-60395	18-0785
9-53442	18-4190	9-56000	18-95560	9-60044	18-2835	9-60396	18-0813
9-53443	18-4079	9-56005	18-95605	9-60045	18-0378	9-60398	18-99037
9-53445	18-4058	9-56006	18-95606	9-60046	18-2506-1	9-60399	18-99038
9-53462	18-4067	9-56481	18-56481	9-60047	18-2807	9-60400	18-0880
9-53463	18-4068	9-56482	18-56482	9-60048	18-0324	9-60401	18-2557
9-53466	18-4065	9-56871	18-4514	9-60049	18-2513	9-60402	18-0969
9-53467	18-4066	9-57700	18-7907	9-60050	18-2513	9-60404	18-2855
9-53468	18-4123	9-57701	18-7890	9-60051	18-0642	9-60406	18-0882
9-53469	18-4113	9-57702	18-57702	9-60052	18-0131	9-60408	18-4248
9-53470	18-4103	9-57725	18-7997	9-60053	18-0918	9-60408-50	18-42481-9
9-53805	18-4144	9-57726	18-7999	9-60054	18-0970	9-60409	18-2709
9-53806	18-4145	9-57800	18-7913	9-60056	18-0645	9-60410	18-2911
9-53807	18-4146	9-57801	18-7824-2	9-60057	18-0936	9-60413	18-2864
9-53810	18-4141	9-57802	18-7875	9-60058	18-0968	9-60414	18-0965
9-53811	18-4142	9-57803	18-7879-1	9-60059	18-0139	9-60415	18-0933
9-53812	18-4143	9-57804	18-7911-1	9-60060	18-2501	9-60416	18-0979
9-53815	18-4097	9-57806	18-7878-1	9-60061	18-0320	9-60417	18-0985
9-53817	18-4099	9-57807	18-7903	9-60062	18-0129	9-60418	18-0989
9-53820	18-4128	9-57808	18-7906-1	9-60063	18-0870	9-60419	18-0975
9-53821	18-4129	9-57809	18-7902	9-60065	18-0891	9-60420	18-2550
9-53822	18-4130	9-57810	18-7910-1	9-60066	18-0903	9-60421	18-0128
9-53823	18-4131	9-57814	18-7896	9-60067	18-0327	9-60422	18-0136
9-53825	18-4133	9-57815	18-7897	9-60074	18-0164	9-60423	18-0138
9-53830	18-4080	9-57816	18-7918	9-60100	18-4698	9-60424	18-2865
9-53831	18-4081	9-57817	18-7915-1	9-60100-50	18-46981-9	9-60425	18-1205
9-54200	18-3966	9-57818	18-7895	9-60101	18-2945	9-60426	18-2876
9-54202	18-3968	9-57819	18-7905	9-60101-50	18-29451-9	9-60427	18-0118
9-54208	18-4019	9-57820	18-8003-1	9-60102	18-2945	9-60428	18-0134
9-54210	18-4021	9-57821	18-7921	9-60102-50	18-29451-9	9-60429	18-0983
9-54216	18-3927	9-57822	18-7758	9-60103	18-60103	9-60430	18-2913
9-54217	18-3902	9-57823	18-7918	9-60103-50	18-60103-50	9-60431	18-2938
9-54219	18-3916	9-57824	18-57824	9-60104	18-0905	9-60432	18-1207
9-54225	18-3982	9-57825	18-7824-2	9-60105	18-2430	9-60433	18-2545
9-54229	18-3979	9-57826	18-57826	9-60202	18-8331	9-60434	18-2866
9-54231	18-3981	9-57902	18-7871	9-60202-50	18-8331	9-60435	18-0117
9-54233	18-3921	9-57905	18-7926	9-60301	18-99027	9-60436	18-0850
9-54235	18-3923	9-57906	18-0032	9-60309	18-0757	9-60437	18-0424
9-54237	18-4050	9-57907	18-7878-1	9-60312	18-99000	9-60438	18-2867
9-54239	18-4052	9-57908	18-7974	9-60313	18-99002	9-60439	18-1212
9-54400	18-3913	9-57909	18-7926	9-60314	18-99003	9-60440	18-0963
9-54401	18-3914	9-57910	18-7880	9-60315	18-99006	9-60441	18-0148
9-54402	18-3915	9-57911	18-7884	9-60317	18-99008	9-60442	18-0142
9-54404	18-3931	9-58000	18-2193	9-60318	18-99010	9-60443	18-0161
9-54406	18-3933	9-59020	18-4495	9-60319	18-99012	9-60444	18-0122
9-54412	18-3910	9-60001	18-2933	9-60320	18-99014	9-60445	18-2852
9-54413	18-3911	9-60002	18-0182	9-60321	18-99016	9-60446	18-0130
9-54414	18-3912	9-60003	18-0844	9-60322	18-99018	9-60447	18-0144
9-54416	18-3904	9-60004	18-0339	9-60323	18-99019	9-60448	18-0977

MALLORY (Cont.)		MALLORY (Cont.)		MALLORY (Cont.)		MALLORY (Cont.)	
MALLORY No.	Sierra No.	MALLORY No.	Sierra No.	MALLORY No.	Sierra No.	MALLORY No.	Sierra No.
9-60449	18-2546	9-61308	18-0609	9-63700	18-2946	9-64213	18-4356
9-60450	18-0987	9-61311	18-25001	9-63701	18-3877	9-64214	18-4325
9-60451	18-0941	9-61312	18-2815	9-63702	18-3878	9-64215	18-4326
9-60452	18-2544	9-61313	18-0685	9-63703	18-3874	9-64216	18-4338
9-60453	18-0440	9-61315	18-25002	9-63704	18-3880	9-64217	18-64217
9-60454	18-2873	9-61316	18-0311	9-63705	18-3881	9-64401	18-4419
9-60455	18-0110	9-61317	18-0347	9-63706	18-3876	9-64402	18-4427
9-60463	18-2857	9-61318	18-0346	9-63707	18-3879	9-64404	18-4405
9-60464	18-2549	9-61319	18-61319	9-63708	18-3883	9-64406	18-4403
9-60501	18-99040	9-61400	18-0418	9-63709	18-3860	9-64407	18-4415
9-60503	18-99039	9-61401	18-0872	9-63711	18-3878	9-64410	18-4400
9-60505	18-99091	9-61402	18-4394	9-63800	18-3855	9-64411	18-4411
9-60508	18-60508	9-61403	18-4395	9-63801	18-3857	9-64412	18-99103
9-60510	18-0829	9-61404	18-4396	9-63803	18-3852	9-64415	18-64415
9-60511	18-99124	9-61405	18-4398	9-63804	18-3854	9-64418	18-99073
9-60512	18-60512	9-61406	18-4367	9-63805	18-3853	9-65100	18-2875
9-60513	18-60513	9-61407	18-2833	9-63806	18-3858	9-65200	18-0470
9-60518	18-60518	9-61409	18-1210	9-63807	18-3851	9-65300	18-2941
9-60519	18-60519	9-61411	18-0113	9-63820	18-3837	9-65301	18-0471
9-60520	18-60520	9-61412	18-0881	9-63821	18-3836	9-65302	18-0472
9-60521	18-60521	9-61413	18-0897	9-63822	18-3838	9-65400	18-0305
9-60522	18-60522	9-61414	18-2849-1	9-63823	18-2888	9-65401	18-0309
9-60523	18-60523	9-61415	18-0954	9-63825	18-3839	9-65402	18-0475
9-60525	18-99075	9-61416	18-2830	9-63826	18-3866	9-65500	18-0476
9-60526	18-99070	9-61417	18-2912	9-63827	18-2960	9-65501	18-2854
9-60527	18-60527	9-61418	18-0956	9-63828	18-2956	9-65700	18-0677
9-60528	18-60528	9-61419	18-1204	9-63829	18-2964	9-65800	18-2971
9-60529	18-60529	9-61420	18-0183-1	9-63830	18-3803	9-65801	18-2991
9-60530	18-60530	9-61421	18-2909	9-63832	18-2963	9-71102	18-71102
9-60532	18-60532	9-61422	18-0672	9-63833	18-3802	9-71500	18-2103
9-60534	18-60534	9-61423	18-2819	9-63834	18-7110	9-71501	18-2105
9-60535	18-60535	9-61424	18-2832	9-63850	18-7400	9-71502	18-2106
9-60536	18-99069	9-61426	18-2896	9-63851	18-3861	9-71503	18-2107
9-60537	18-99074	9-61428	18-0680	9-63852	18-3872	9-71504	18-2108
9-60538	18-0754	9-61450	18-4369	9-63853	18-3862	9-71505	18-2109
9-60539	18-0836	9-61451	18-4371	9-63854	18-3864	9-71506	18-2112
9-60540	18-60540	9-61452	18-0943-1	9-63855	18-3863	9-71507	18-2113
9-60541	18-60541	9-61453	18-4347-1	9-63856	18-3871	9-71508	18-2114
9-60915	18-60915	9-61455	18-4349	9-63900	18-3808	9-71509	18-2115
9-60916	18-60916	9-61500	18-1239	9-63902	18-3810	9-71510	18-2116
9-60917	18-60917	9-61501	18-0348	9-63903	18-3809	9-71512	18-2436
9-60918	18-60918	9-61502	18-0407	9-63950	18-3891	9-71514	18-2136
9-60919	18-60919	9-61503	18-0340	9-63951	18-3894	9-71515	18-2137
9-60920	18-60920	9-61504	18-1237	9-63952	18-3831	9-71516	18-2435
9-61001	18-0467	9-61505	18-0405	9-63953	18-3830	9-71702	18-2432
9-61003	18-0462	9-61507	18-1235	9-63955	18-99140	9-71703	18-2433
9-61004	18-2848	9-61508	18-1232	9-63956	18-3892	9-72001	18-3722
9-61005	18-0353	9-61509	18-0466	9-63958	18-3805	9-72001-10	18-3722
9-61006	18-0354	9-61511	18-0322	9-63959	18-3832	9-72002	18-3720
9-61007	18-0356	9-61513	18-61513	9-63960	18-3804	9-72002-10	18-3720
9-61008	18-0360	9-61600	18-0976	9-63961	18-3848	9-72003	18-3723
9-61009	18-0357	9-61602	18-0887	9-63962	18-3828	9-72003-10	18-3723
9-61010	18-4380	9-61603	18-4375	9-63963	18-99062	9-72004	18-3721
9-61011	18-0994	9-61610	18-1213	9-63964	18-3827	9-72004-10	18-3721
9-61012	18-2743	9-61612	18-1233	9-63965	18-3829	9-72005	18-72005
9-61041	18-0889	9-61620	18-1211	9-63966	18-63966	9-72009	18-2560
9-61042	18-0876	9-61621	18-0519	9-64002	18-4312	9-72100	18-2803
9-61051	18-61051	9-61622	18-1234	9-64006	18-4314	9-72101	18-2604
9-61100	18-4374	9-61623	18-0864	9-64100	18-4402	9-72140	18-2192
9-61101	18-4384	9-61650	18-4024	9-64101	18-4321	9-72150	18-2149
9-61102	18-4387	9-61652	18-4022	9-64102	18-4302	9-72151	18-2162
9-61103	18-4383	9-61653	18-4024	9-64106	18-4428	9-72152	18-2163
9-61104	18-4385	9-61700	18-1271	9-64107	18-4406	9-72153	18-2161
9-61105	18-4373	9-61701	18-1270	9-64108	18-4323	9-72154	18-3752
9-61200	18-0868	9-61702	18-1275	9-64109	18-4322	9-72155	18-3751
9-61201	18-0465	9-61703	18-1256	9-64110	18-4310	9-72156	18-2145
9-61202	18-1231	9-61704	18-1273	9-64111	18-4304-1	9-72157	18-2190
9-61204	18-0410	9-61705	18-1274	9-64112	18-4303-1	9-72158	18-2158
9-61208	18-0607	9-61706	18-1265	9-64113	18-4305	9-72159	18-2159
9-61210	18-4388	9-61707	18-1266	9-64114	18-4307	9-72160	18-2157
9-61211	18-4365	9-61708	18-1267	9-64115	18-4309	9-72161	18-2622
9-61212	18-4389	9-62601	18-2619-1	9-64117	18-4301	9-72162	18-3760
9-61213	18-0488	9-62601-25	18-2619-1	9-64200	18-4317	9-72164	18-2303
9-61214	18-0487	9-62602	18-2614	9-64201	18-4319	9-72200	18-2176
9-61217	18-0403	9-62602-25	18-2614	9-64204	18-4359	9-72201	18-2177
9-61221	18-61221	9-62603	18-2617	9-64207	18-4337	9-72202	18-6399
9-61300	18-2845	9-62604	18-2615	9-64209	18-4336	9-72203	18-3725
9-61302	18-0464	9-62605	18-2613	9-64210	18-4339	9-72204	18-2178
9-61305	18-0664	9-62606	18-2699	9-64211	18-4340	9-72352	18-2239
9-61307	18-0352	9-62650	18-2918	9-64212	18-4319	9-72400	18-2125

MALLORY (Cont.)		MALLORY (Cont.)		MALLORY (Cont.)		MALLORY (Cont.)	
MALLORY No.	Sierra No.	MALLORY No.	Sierra No.	MALLORY No.	Sierra No.	MALLORY No.	Sierra No.
9-72401	18-2146	9-72901	18-8205	9-73991	18-3781	9-75113	18-1153
9-72402	18-6400	9-72902	18-2601-1	9-73992	18-3782	9-75114	18-1155
9-72403	18-2128	9-72903	18-8219	9-73994	18-73994	9-75115	18-1173
9-72404	18-2104	9-72904	18-8206-1	9-74000	18-8366	9-75117	18-1165
9-72405	18-2174	9-72905	18-8212-1	9-74001	18-8365	9-75118	18-1156
9-72406	18-2097	9-72906	18-8218	9-74002	18-8362-1	9-75119	18-1197
9-72408	18-6402	9-72907	18-8219	9-74100	18-2656	9-75120	18-1159
9-72409	18-9218	9-72930	18-2771	9-74101	18-2658	9-75121	18-1117
9-72410	18-2100	9-72931	18-2772-1	9-74102	18-2659	9-75122	18-1161
9-72412	18-21005	9-73001	18-3601	9-74103	18-2660	9-75123	18-1160
9-72413	18-6406	9-73002	18-3602	9-74104	18-2694	9-75125	18-1193
9-72414	18-6406	9-73003	18-3603	9-74105	18-2684	9-76100	18-2016
9-72415	18-21006	9-73100	18-7311	9-74106	18-2623	9-76101	18-2076
9-72420	18-2724	9-73101	18-7314	9-74107	18-8341	9-76102	18-2003
9-72425	18-21005K	9-73102	18-7316	9-74108	18-74108	9-76103	18-2007
9-72426	18-2100K	9-73103	18-7315	9-74109	18-8373	9-76104	18-2008
9-72450	18-2166	9-73104	18-7312	9-74110	18-8374	9-76105	18-2009
9-72460	18-2180	9-73115	18-7321	9-74111	18-8337	9-76106	18-2010
9-72462	18-2324	9-73117	18-1728	9-74112	18-2657	9-76107	18-2011
9-72463	18-2331	9-73118	18-1710	9-74113	18-2692	9-76108	18-2013
9-72475	18-2169	9-73130	18-1705	9-74114	18-2691	9-76109	18-2014
9-72476	18-2150	9-73131	18-73131	9-74115	18-2685	9-76110	18-2048
9-72477	18-2320	9-73410	18-1551	9-74200	18-2626	9-76111	18-2049
9-72500	18-2172	9-73420	18-1550	9-74201	18-2655	9-76112	18-2050
9-72501	18-2173	9-73431	18-1550	9-74202	18-2654	9-76113	18-2051
9-72502	18-2171	9-73432	18-1560	9-74203	18-2653	9-76114	18-2052
9-72503	18-2412	9-73450	18-1551	9-74204	18-2635	9-76115	18-2053
9-72504	18-2413	9-73451	18-1564	9-74205	18-2624	9-76116	18-2054
9-72505	18-2414	9-73452	18-1566	9-74206	18-2646-1	9-76117	18-2055
9-72506	18-2321	9-73454	18-1565	9-74207	18-2640	9-76119	18-2077
9-72507	18-2323	9-73464	18-2236	9-74208	18-8382	9-76127	18-0579
9-72510	18-72510	9-73474	18-2202	9-74209	18-2642	9-76128	18-0580
9-72600	18-2370	9-73500	18-2210	9-74210	18-2697-1	9-76129	18-0583
9-72601	18-2191	9-73501	18-2207	9-74212	18-2628	9-76130	18-2056
9-72602	18-2376	9-73502	18-2208	9-74300	18-2645	9-76131	18-0500
9-72640	18-2298	9-73504	18-2209	9-74301	18-2643	9-76133	18-2154
9-72641	18-2299	9-73510	18-2315	9-74302	18-2644	9-76134	18-2155
9-72642	18-2354	9-73511	18-2310	9-74303	18-2648	9-76136	18-2353
9-72643	18-2298	9-73512	18-2309	9-74304	18-2652	9-76200	18-2018
9-72644	18-0557	9-73514	18-2308	9-74400	18-2665	9-76201	18-2025
9-72650	18-2244	9-73520	18-2289	9-74401	18-2671	9-76202	18-2002
9-72650-10	18-22441-9	9-73530	18-2290	9-74402	18-2672	9-76203	18-2026
9-72651	18-2375	9-73534	18-2216	9-74501	18-74501	9-76204	18-2027
9-72652	18-2374	9-73540	18-1293	9-74502	18-0021	9-76205	18-2059
9-72653	18-2371	9-73541	18-1287	9-74503	18-0028	9-76206	18-2060
9-72654	18-2378	9-73542	18-1288	9-74504	18-74504	9-76207	18-2028
9-72655	18-2387	9-73543	18-1289	9-74507	18-74507	9-76208	18-2030
9-72656	18-72656	9-73544	18-1290	9-74510	18-74510	9-76209	18-2031
9-72657	18-8331	9-73550	18-1291	9-74511	18-99073	9-76210	18-2032
9-72659	18-1236	9-73560	18-2221	9-74512	18-74512	9-76211	18-2033
9-72660	18-4249	9-73561	18-2218	9-74513	18-74513	9-76212	18-2001
9-72700	18-2752	9-73564	18-2220	9-74514	18-0023	9-76213	18-2064
9-72701	18-2751	9-73890	18-73890	9-74515	18-74515	9-76214	18-2065
9-72702	18-2756	9-73891	18-73891	9-74516	18-0024	9-76217	18-8326
9-72703	18-2750	9-73892	18-73892	9-74518	18-99104	9-76218	18-2029
9-72704	18-2747	9-73900	18-3200	9-74526	18-74526	9-76219	18-2061
9-72705	18-2753-2D	9-73901	18-3704	9-74527	18-74527	9-76220	18-2062
9-72706	18-2764	9-73902	18-3714	9-74528	18-0030	9-76221	18-8300
9-72707	18-2765	9-73903	18-3705	9-74529	18-0031	9-76222	18-2058
9-72708	18-2758	9-73904	18-4194	9-74530	18-0027	9-76228	18-2020
9-72709	18-2763	9-73905	18-4231	9-74531	18-0026	9-76230	18-2094
9-72710	18-2744	9-73906	18-3773	9-74534	18-0025	9-76410	18-0554
9-72711	18-1074	9-73907	18-73907	9-74535	18-74535	9-76411	18-0296
9-72721	18-8368	9-73908	18-3732	9-74539	18-2794-1	9-76412	18-0265
9-72800	18-2780-1	9-73909	18-3726	9-74540	18-74540	9-76413	18-0297
9-72801	18-2781	9-73911	18-2380	9-74544	18-74544	9-76414	18-0587
9-72802	18-2779	9-73912	18-3735	9-74546	18-74546	9-76421	18-0265
9-72803	18-2757	9-73914	18-73914	9-74700	18-8335	9-76422	18-0266
9-72804	18-2770	9-73915	18-4274	9-74701	18-8338	9-76423	18-0267
9-72805	18-2748	9-73918	18-73918	9-74702	18-8339	9-76500	18-7145
9-72806	18-2745	9-73951	18-3717	9-74703	18-8340	9-76501	18-7173
9-72807	18-2759	9-73952	18-3716	9-74805	18-74805	9-76502	18-7170
9-72808	18-2762	9-73953	18-3715	9-75100	18-1190	9-76503	18-2516
9-72809	18-2761	9-73960	18-3701	9-75104	18-1397	9-76504	18-7198
9-72810	18-2760	9-73961	18-3702	9-75106	18-1179	9-76505	18-7153
9-72811	18-2746	9-73963	18-3703	9-75107	18-1143	9-76506	18-7105
9-72812	18-2768	9-73964	18-73964	9-75108	18-1162	9-76507	18-7117
9-72813	18-2767	9-73978	18-73978	9-75110	18-1166	9-76508	18-2996
9-72814	18-2780-1	9-73979	18-73979	9-75111	18-1157	9-76509	18-7100
9-72900	18-8218	9-73990	18-73990	9-75112	18-1158	9-76511	18-7134

MALLORY (Cont.)		MALLORY (Cont.)		MALLORY (Cont.)		MALLORY (Cont.)	
MALLORY No.	Sierra No.	MALLORY No.	Sierra No.	MALLORY No.	Sierra No.	MALLORY No.	Sierra No.
9-76512	18-2944	9-77902	18-8361	9-81006	18-81006	33430-10	18-8055
9-76516	18-0858	9-77903	18-8358	9-81102	18-81102	33432-10	18-8054
9-76517	18-2536	9-77904	18-8359	9-81103	18-81103	33434-10	18-8073
9-76518	18-2769	9-78001	18-1240	9-82100	18-9550-0	33436-10	18-8040
9-76519	18-7101	9-78002	18-4261	9-82101	18-9550-3	33450-10	18-8078
9-76520	18-7102	9-78003	18-2742	9-82150	18-9750-0	33451-10	18-8088
9-76521	18-7104	9-78005	18-2715	9-82151	18-9750-0	33461-10	18-8071
9-76522	18-7108	9-78007	18-2534	9-82200	18-9013	33463-10	18-8078
9-76525	18-7118	9-78009	18-2539	9-82201	18-9024	33464-10	18-8062
9-76526	18-7120	9-78013	18-4251	9-82202	18-9080	33467-10	18-8079
9-76527	18-7127	9-78100	18-0577	9-82250	18-9570-0	33470-10	18-8077
9-76528	18-7130	9-78103	18-3719	9-82275	18-9775	33473-10	18-8070
9-76529	18-7133	9-78105	18-4296	9-82276	18-9065	33475-10	18-8069
9-76530	18-7135	9-78106	18-2342	9-82300	18-9500-1	33476-10	18-8094
9-76531	18-7137	9-78107	18-3712	9-82301	18-9500-2	33477-10	18-80402
9-76532	18-7128	9-78108	18-2343	9-82302	18-9500-3	33480-10	18-8092
9-76533	18-7138	9-78109	18-4295	9-82303	18-9500-4	33481-10	18-8076
9-76535	18-7140	9-78110	18-3151	9-82305	18-9500-7	33482-10	18-8076
9-76536	18-7142	9-78111	18-2357	9-82311	18-8798	33484-10	18-8062
9-76537	18-7143	9-78112	18-2261	9-82350	18-9420-2	33485-10	18-4462
9-76539	18-7146	9-78114	18-3198	9-82351	18-9420-3	33486-10	18-8085
9-76540	18-7151	9-78115	18-3199	9-82352	18-9420-7	33487-10	18-80405
9-76541	18-7155	9-78117	18-3713	9-82360	18-9410-2	33491-10	18-8078
9-76542	18-7157	9-78120	18-2382	9-82361	18-9410-4	33492-10	18-8088
9-76543	18-7158	9-78121	18-2381	9-82363	18-9410-7	33496-10	18-80406
9-76544	18-7159	9-78126	18-2346	9-82380	18-9400-2	33497-10	18-80403
9-76545	18-7160	9-78127	18-3229	9-82382	18-9400-4	33498-10	18-80401
9-76546	18-7161	9-78129	18-3231	9-82383	18-9400-7	33501-10	18-80400
9-76547	18-7162	9-78130	18-3197	9-82390	18-9440-2	33502-10	18-80401
9-76549	18-7167	9-78132	18-2130	9-82391	18-9440-3	33503-10	18-8071
9-76550	18-7168	9-78133	18-2286	9-82392	18-9440-4	34391-10	18-8058
9-76551	18-7169	9-78134	18-2349	9-82393	18-9440-7	34394-10	18-8017
9-76552	18-7172	9-78135	18-2348	9-82400	18-9600-0	34395-10	18-8013
9-76553	18-7174	9-78137	18-4267	9-82401	18-9600-2	34590-10	18-8005
9-76554	18-7176	9-78138	18-4270	9-82402	18-9600-5	34690-10	18-8004
9-76555	18-7178	9-78139	18-3219	9-82403	18-9600-6	99076-10	18-9010
9-76556	18-7180	9-78140	18-3220	9-82404	18-9600-7	99077-00	18-8998
9-76557	18-7183	9-78141	18-4273	9-82500	18-9650-0	99082-00	18-8999
9-76559	18-7188	9-78212	18-0605	9-82501	18-9650-2	106	18-1941
9-76562	18-7426	9-78213	18-0619	9-82502	18-9650-5	121	18-0471
9-76564	18-7419	9-79000	18-9098	9-82503	18-9650-6	150	18-1911
9-76565	18-7420	9-79001	18-9099	9-82504	18-9650-7	188	18-1922
9-76567	18-7403	9-79101	18-2411	9-82601	18-9620-2	402	18-6600
9-76569	18-7961	9-79126	18-2415	9-82602	18-9620-5	480	18-2841
9-76571	18-7475	9-79127	18-2401	9-82700	18-9200	639	18-1913
9-76573	18-7485	9-79200	18-2405	9-82750	18-9710-1	689	18-1945
9-76574	18-7440-1	9-79202	18-2256	9-82751	18-9710-0	794	18-1946
9-76578	18-7956	9-79203	18-2259	9-82752	18-9700-2	826	18-1940
9-76579	18-7956	9-79800	18-4442	9-82801	18-9680-2	879	18-1905
9-76581	18-7449	9-79801	18-9803	9-82802	18-9680-5	992	18-1999
9-76586	18-8325	9-79802	18-9802	9-82804	18-9680-7	994	18-1997-1
9-76615	18-7436	9-79803	18-9801			1851	18-1906
9-76651	18-7121	9-79804	18-9800			2018	18-1907
9-76652	18-7401	9-79805	18-9861			2076	18-1975-1
9-76653	18-4253-9	9-79806	18-9806-1			2441	18-1902
9-76654	18-7404	9-79807	18-9842			2442	18-1903
9-76689	18-76689	9-79808	18-9868	33418	18-8083	3320	18-1908
9-76690	18-76690	9-79809	18-9854	33421	18-8084	3322	18-1985
9-76691	18-76691	9-79810	18-9809	33480	18-8092	4354	18-1976-1
9-76692	18-76692	9-79811	18-9847	33481	18-8076	5538	18-1973
9-76693	18-76693	9-79812	18-9872	33482	18-8085	5603	18-1962-1
9-76694	18-76694	9-79813	18-79813	33484	18-8106	5604	18-1958-1
9-76695	18-76695	9-79814	18-79814	33485	18-4462	5639	18-1944
9-77000-20	18-2702	9-79815	18-79815	33486	18-8085	5805	18-1931-1
9-77001	18-4288	9-79816	18-79816	34313	18-8000	5862	18-1954-1
9-77001-20	18-4288	9-79816-24	18-79816-24	34375	18-8049	5944	18-0470
9-77002	18-2341-1	9-79817	18-79817	33212-10	18-7307	6022	18-0473
9-77002-20	18-2341-1	9-79820	18-79820	33319-10	18-7790	6108	18-0305
9-77003	18-2701	9-79821	18-9870	33320-10	18-7775-1	6325	18-1972-1
9-77004	18-2701-04	9-79822	18-9896	33321-10	18-7776-1	6351	18-1971
9-77100	18-2461	9-79823	18-79823	33323-10	18-7844	6562	18-0309
9-77101	18-2464	9-79824	18-9141	33324-10	18-7845	6705	18-1955-1
9-77102	18-2462	9-79825	18-79825	33325-10	18-7789	6771	18-1978
9-77103	18-2463	9-79833	18-79833	33389-10	18-8032	7056	18-1914
9-77200	18-2465-9	9-79834	18-79834	33400-10	18-8063	7081	18-1915
9-77200-20	18-2465	9-81000	18-9783	33401-10	18-8042	7169	18-1916
9-77201	18-2466-9	9-81001	18-9782	33405-10	18-8074	7296	18-1917
9-77201-20	18-2466	9-81002	18-9781	33418-10	18-8083	7386	18-1918
9-77900	18-8357	9-81003	18-9794	33419-10	18-8082	7387	18-1919
9-77901	18-2625	9-81004	18-9788	33420-10	18-8068	7624	18-1924
				33421-10	18-8084		

MOELLER

MOELLER No. Sierra No.

SEADOG (Cont.)		SEADOG (Cont.)			
SEADOG No.	Sierra No.	SEADOG No.	Sierra No.		
3023P3	18-4515	3544KD	18-3934		
3023PS	18-4500	3625KD	18-3907		
3027P3	18-4127	3685KD	18-3975		
3027PS	18-4107	3715KD	18-3974		
3030KD	18-3912	B1029	18-1375		
3030KD	18-3912	CW24	18-4292		
3030P2	18-4142	S474	18-4281		
3030P3	18-4143	S493	18-4280		
3030PS	18-4141	W4958	18-4294		
3031P3	18-4099	W5217	18-1374		
3031PS	18-4097	W5263	18-4290		
3032PS	18-4091				
3036P3	18-4126				
3036PS	18-4106				
3072P3	18-4064				
3072PS	18-4063				
3073P3	18-4100				
3073PS	18-4120				
3102PS	18-4600				
3108P2	18-4525				
3108P3	18-4540				
3108PS	18-4510				
3108S2	18-4560				
3108S3	18-4575				
3108SS	18-4545				
3109P2	18-4520				
3109PS	18-4505				
3111P3	18-4105				
3111PS	18-4125				
3115P2	18-4114				
3115P3	18-4104				
3115PS	18-4124				
31164P4	18-4132				
3116PS	18-4128				
3116S4	18-4133				
3116SS	18-4129				
3118P3	18-4102				
3118PS	18-4122				
3118S3	18-4101				
3118SS	18-4121				
3119P3	18-4067				
3119PS	18-4065				
3119S3	18-4068				
3119SS	18-4066				
3121P3	18-4103				
3121PS	18-4123				
3123P2	18-4530				
3123P3	18-4515				
3123PS	18-4500				
3125KD	18-3921				
3127P3	18-4127				
3127PS	18-4107				
3130P2	18-4142				
3130P3	18-4143				
3130PS	18-4141				
3131P3	18-4099				
3131PS	18-4097				
3132PS	18-4091				
3136P3	18-4126				
3136PS	18-4106				
3145KD	18-3922				
3155KD	18-3923				
3172P3	18-4064				
3172PS	18-4063				
3173P3	18-4100				
3173PS	18-4120				
3184P2	18-4139				
3184P3	18-4140				
3184PS	18-4138				
3187KD	18-3913				
3190P2	18-4136				
3190P3	18-4137				
3190PS	18-4135				
3217KD	18-3915				
3228KD	18-3969				
3312KD	18-3951				
3375KD	18-3927				
3500KD	18-3904				
3520KD	18-3906				
3530KD	18-3905				

WIX

WIX No.	Sierra No.
33003	18-7857-1
33012	18-7830
33031	18-7829
33032	18-7856-1
33033	18-7831
33044	18-7855
33118	18-7867
33225	18-7844
33225	18-7845
33398	18-7802
33943	18-7860
51036	18-7879-1
51064	18-7910
51068	18-7878
51069	18-7824
51307	18-7878
51334	18-7910
51348	18-7884
51348	18-7915
51356	18-7914
51358	18-7902
51365	18-7911
51394	18-7916
51515	18-7875
51773	18-7887
51791	18-7880
51806	18-7886
51970	18-7874
51970	18-7899

GENERATOR PRODUCTS

FISCHER PANDA			NORTHERN LIGHTS			Westerbeke (Cont.)		
O.E. #	SIERRA #	PAGE #	O.E. #	SIERRA #	PAGE #	O.E. #	SIERRA #	PAGE #
IC78.460.000B	23-1104	126, 14	11-10015	23-0830	132	26488	23-3600	130, 138, 140
IC78.460.000A	23-1105	126, 149	24-22009	23-1102	126, 151	35736	23-3601	130, 138, 140
J009-46840	23-3311	129, 148, 150	24-28003	23-1103	126, 149	37387	23-3602	130, 138, 140
J009-1027B-1	23-3312	129, 148, 150	25-12009	23-2005	128, 148	39378	23-3603	130, 140
JABSCO			25-12009	23-3315	129, 148	46097	23-3604	130, 130
22799-0001	23-2003	128, 142	132-0349	23-3300	128, 146	24680	23-3605	130, 138, 140
JOHNSON PUMP			ONAN			24688 & 24323	23-3650	132, 139
09-808B-1	23-2001	128, 138, 140, 148	132-0436	23-3309	129, 148	35736 & 34196	23-3651	132, 139, 141
KOHLER			541-1519	23-3310	129, 148	35736 & 33417	23-3652	132, 14
267718	23-0809	131, 147	309-0130	23-3606	130, 148	24688 & 34196	23-3653	132, 139
229432	23-0810	131, 143, 145	130-4434	23-6401	136	39378 & 42260	23-3654	132, 141
249865	23-0811	131, 143, 145	149-1445	23-6402	136	39378 & 46124	23-3655	132, 141
229433	23-0812	132, 145	149-0428	23-7720	127, 138, 140	46097 & 33417	23-3656	132, 141
229963	23-0813	132, 145, 147	149-2106	23-7750	127, 148	24688 & 33966	23-3657	132, 141
352031	23-0814	132, 145	A026K278	23-7760	127, 146, 148	37387 & 37922	23-3658	133, 139, 141
267709	23-1100	126	185-7444	23-7760	127, 146, 148	24690 & 33373	23-3659	133, 139
278857	23-1130	126, 143, 145	122-0810	23-7804	134, 147, 149	35736 & 40434	23-3660	133, 141
229826	23-2002	128, 142, 144, 146	185-5835	23-7840	135, 147, 149	24688 & 40434	23-3661	133, 141
250872	23-2003	128, 142	SHERWOOD			39181	23-4000	136
359978	23-2004	128, 146	10077K	23-2000	128, 138, 140, 148	11672	23-4001	136
229826	23-3303	128, 142, 144, 146	09000K	23-2002	128, 142, 144, 146	30592	23-4002	136
229955	23-3304	128, 144	WESTERBEKE			45232	23-4003	136
352122	23-3308	129, 144	42260	23-0800	131, 141	30475	23-4004	136
352018	23-3607	130, 144	46124	23-0801	131, 141	13810	23-4005	129
249930	23-3608	130, 146	34196	23-0802	131, 139, 141	31152	23-4006	130
252896	23-3609	130, 142, 144	33417	23-0803	131, 141	30376	23-4007	130
267717	23-3610	Obsolote	33373	23-0804	131, 139	43060	23-4500	134, 190
267717 & 267718	23-3663	133, 147	40434	23-0805	131, 141	46596	23-4501	134, 190
249930 & 29963	23-3664	133, 147	24323	23-0806	131, 139	30593	23-5600	136, 138
252896 & 229432	23-3665	133, 143, 145	33966	23-0807	131, 139	24639	23-5800	136, 139
352018 & 352031	23-3666	133, 145	37922	23-0808	131, 139, 141	35109	23-5840	127
260085	23-6400	136	24353	23-1000	127, 139	24132	23-5880	127, 139, 141
GM24510	23-7202	126, 147	39705	23-1101	126, 139, 143, 147	30594	23-5900	Obsolote
252898	23-7740	126, 142, 144	40859	23-2700	133	11885	23-6400	136
229715	23-7751	126, 142, 144, 150	35608	23-2702	133	36450	23-7200	126, 141
GM32359	23-7761	127, 144	46592	23-2703	133	38100	23-7201	126, 139, 141
26987	23-7762	127, 146	40860	23-2802	134	35920	23-7220	127, 138, 140
249433	23-7771	127, 146	43050	23-2803	134	24363	23-7764	127, 138
GM34570	23-7780	127, 146	11907	23-3301	128, 138, 140	30200	23-7770	127, 138, 140, 142
326817	23-7803	134, 147	33112	23-3302	128, 138, 140	47060	23-7770	127, 138, 140, 142
279449	23-7820	134, 147	32620	23-3305	128, 138, 140, 148	36918	23-7800	134
359771	23-7821	135, 147	46622	23-3306	129, 140	35595	23-7801	134, 139, 141, 149, 151
229678	23-7822	135, 143	34440	23-3307	129, 138	48076	23-7802	134, 139
267714	23-7823	135, 147	33104	23-3313	129, 138	35828	23-7825	135, 139
GM47465	23-7824	135, 143, 145				40154	23-7826	135, 139
359978	23-3314	129, 146						

SIERRA MARINE PRODUCTS

A.C. DELCO			Barr (Cont.)			Barr (Cont.)		
O.E. #	SIERRA #	PAGE #	O.E. #	SIERRA #	PAGE #	O.E. #	SIERRA #	PAGE #
GF-61	18-7856-1	158	CM-1-6672-H	18-1942	605	FM-1-83	18-1996	648
GF-61P	18-7857-1	158	CM-20-414211	18-1944	604	CHV-1-83	18-1997-1	587, 604, 625, 648, 660, 794, 915, 987
ARCTIC CAT			CM-20-6674	18-1945	604	FM-1-83	18-1998-1	587, 625, 648, 660, 794, 915
0436-879	72-5100-3	211	CM-20-6672	18-1946	604	20-0082	18-1999	587, 625, 648, 660, 796, 916, 988
1436-434	72-5101-2	211	CM-20-9234	18-1948	605	01-0107	18-2854-1	589, 629, 649, 800, 918
1436-435	72-5101-3	211	CM-20-0097	18-1949	587, 627, 660, 797, 988	CHV-47-000	18-2949	918
1436-159	72-5102-2	212	MC-1-77234	18-1950-1	794	MC-20-60207	18-4008	798
0436-901	72-5102-4	212	MC-1-77235	18-1951-1	794	160252	18-4009	798
4639-349	72-5103-2	211	MC-1-99746	18-1952-1	794	CM206672JP	18-4360	605
5639-469	72-5103-3	211	MC 1 96705	18-1955-1	795	CM-20-6674P	18-4361	605
ARCTIC CAT PWC			MC 1 99798	18-1956-3	795	MC20-60426P	18-4362	796, 798
3008-093	18-6919	570	MC-1-65604	18-1958-1	795	FM-1-83-P	18-4363	588, 627, 648, 659, 660, 798, 917
3008-327	18-6919	570	MC 1 58759	18-1960-1	795	20-0082-P	18-4364	648
3008-462	18-6919	570	MC-1-65603	18-1962-1	795	CM-20-9234 P	18-8501	Obsolote
3008-536	18-6919	570	CHV-1-83	18-1964	657	CM-20-6674JP	18-8506	606
BARR			MC-20-98504	18-1970-2	796	CM-20-6674JP	18-8507	606, 917, 989
01-0105	18-0476-1	655, 657, 661, 917, 989	MC-20-76325	18-1972	796	CM-20-9232P	18-8518	606
CHVA-1-84	18-1898	587, 604, 625, 660, 794, 915, 987	MC-20-55538	18-1973	796	CM-1-6677SS P	18-8527	606
20-0100	18-1907	660	MC-20-98502	18-1974-1	797	BORG-WARNER		
20-0102	18-1907	587, 604, 627, 916, 988	MC-20-44354	18-1976-2	797	A4876HA	18-2590	577
20-0100	18-1939	587, 604, 627, 660, 797, 916, 988	MC-20-76771	18-1978	759	BOSCH		
CM-1-6677A	18-1940	604	MC-20-93322A3	18-1985	797	0331-302-050	18-5806	972
CM-1-6672-B	18-1941	605	OMC-1-914035	18-1986-1	987			
			1-73813	18-1990	798			
			200089P	18-1991	587, 626, 648, 796, 916, 988			
			200087P	18-1992-1	587, 626, 648, 796, 916, 988			

Bosch (Cont.)			Chrysler Force (Cont.)			Chrysler Force (Cont.)		
O.E. #	SIERRA #	PAGE #	O.E. #	SIERRA #	PAGE #	O.E. #	SIERRA #	PAGE #
0331-302-081	18-5806	972	26-99325	18-0586	257	700-834794A4	18-4630	251
0331-302-085	18-5806	972	26-F318307	18-0592	257	700-834794A5	18-4631	251
0331-302-581	18-5806	972	26-F901307-2	18-0593	257	700-834800A4	18-4632	251
0331-302-585	18-5806	972	27-19701	18-0622	254	700-834800A5	18-4633	251
0-001-109-035	18-6944	680	27-F476067	18-0854	254	700-834800A6	18-4634	251
BRP			27-F85168-2	18-0855	253	F12044	18-5149	239
5007987	18-8387	364	27-F85748-2	18-0861	253	FP2437A	18-5149	239
420956741	18-8880	570	27-820500A3	18-0869	253	817764A2	18-5150	Obsolete
CAN-AM			27-F40223	18-0869	253	FA305310-2	18-5150	Obsolete
XPS #779139	72-5101-2	211	27-819377	18-0873	254	F12042-1	18-5169	239
XPS #779140	72-5101-3	211	27-F97067	18-0873	254	339-7370A13	18-5186	239
CATERPILLAR			27-F406406	18-0915	253	339-7370B13	18-5186	239
163-3361	18-6944	680	27-F372154-1	18-0958	253	339-832757B4	18-5186	239
3001117	18-6955	679, 971	27-F85906	18-0960	253	F12181-1	18-5241	240
10-258	18-6955	679, 971	19291A3	18-2370	254, 451	F438955-1	18-5613	242
1R-0658	18-7880	200, 690	F184122-1	18-2534	254	F480955	18-5613	242
1R-0714	18-7927	200, 691	26-85090A2	18-2624	254	F490955	18-5613	242
CERLIST DIESEL			26-43035A4	18-2626	254	F616955	18-5613	242
1512904	18-7934	157	26-85090A1	18-2629	460	F85955-1	18-5613	242
1512903	18-7970	157	FK1060	18-2630	255	FA85955	18-5613	242
CHRIS-CRAFT			FK1061	18-2631	255	FK616955	18-5613	242
16.50-00232	18-0868	589	FK1063-1	18-2632	255	FS438955	18-5613	242
16.50-00162	18-0874	589	FK1063-2	18-2632	255	FS438955	18-5613	242
16.50-05756	18-0876	589	FK1127	18-2633	255	FS480955	18-5613	242
16.50-00074	18-0889	589	26-814669A1	18-2635	255	FS489955	18-5613	242
16.50-00078	18-0891	589	26-814669A2	18-2635	255	FS490955	18-5613	242
16.11-01236	18-2845	589	FK1234	18-2635	255	50-819968	18-5618	242
16.50-00204	18-2946	589	26-820645A	18-2636	255	50-8199681	18-5618	242
16.50-00250	18-3876	589	FK1074	18-2636	255	50-819968-2	18-5618	242
16.50-00259	18-3877	589	FK1064	18-2637-1	255	50-8199683	18-5618	242
16.69-00049	18-5311	579	FK1065	18-2638	255	50-8199684	18-5618	242
16.69-00039	18-5314	579	FK1068	18-2639	255	50-898265003	18-5618	242
16.69-00040	18-5338	579	FK1203	18-2640	255	50-820193	18-5622	242
16.69-00050	18-5345	579	FK1203-1	18-2640	255	50-820193T1	18-5622	242
1869704	18-5346	579	26-41365A3	18-2697-1	255	F15150	18-5655	243
16.69-00100	18-5375	579	47-803631T	18-3017	247	819222	18-5673	Obsolete
FI6900165	18-5375	579	47-89984T4	18-3017	247	F15100	18-5673	Obsolete
16.69-00148	18-5376	579	47-F694065	18-3017	247	F15110	18-5673	Obsolete
16.69-00052	18-5385	579	47-803630T	18-3030	247	811902	18-5677	243
16.69-00149	18-5404-1	579	F523065	18-3030	247	75384	18-5697	242
16.69-00042	18-5411	579	F523065-1	18-3030	247	F15164	18-5697	242
16.69-00051	18-5418	579	47-430262	18-3066	247	817411	18-5742	242
16.69-0022	18-5427	579	47-85089-3	18-3067	247	8152792	18-5742	242
16.61-00042	18-5911	583	47-42038-2	18-3062	248	815279T2	18-5742	242
16.83-08758	18-7265	167, 169, 585, 901	47-F40065-2	18-3084	248	815279T3	18-5742	242
FI8308762	18-7265	167, 169, 585, 901	47-F84065	18-3085	248	830179A2	18-5742	242
16.81-08746	18-7824-2	589	F697140	18-3200	457	F718470	18-5742	242
16.83-90006	18-7860	586	46-43024A7	18-3214	248	F746470	18-5742	242
16.81-06536	18-7875	201, 589	F84068-2	18-3550	247	8152794	18-5744	242
CHRYSLER FORCE			F85068	18-3550	247	8174111	18-5744	242
27-F307279-2	18-0115	253	F85068-1	18-3550	247	815279T4	18-5744	242
27-F85154-1	18-0119	253	F85068-2	18-3550	247	815279T5	18-5744	242
27-F85762	18-0141	253	F97068-2	18-3556	247	830179A1	18-5744	242
27-F481836	18-0152	Obsolete	F335068	18-3557	247	854514A1	18-5744	242
27-F40279-1	18-0154	254	F528068	18-3559	247	856747T1	18-5744	242
27-828316	18-0314	253	11-35921	18-3719	256	883071A1	18-5744	242
27-F178168	18-0314	253	11-47411	18-3719	256	332-7778A12	18-5775	239
27-F178168-1	18-0314	253	11-826375	18-3719	256	18495A26	18-5790	239
F178168	18-0314	253	11-F694188	18-3719	256	F177917	18-5803	239
27-F440906	18-0315	251, 253	27-F286529-3	18-3851	252	89-817109A2	18-5834	239
27-F523031	18-0415	524	27-F513529	18-3852	252	89-803822T	18-5835	239
27-F894830	18-0416	248, 254	27-F691529-1	18-3853	252	89-817109A3	18-5835	239
27-F84031	18-0417	255, 257	27-F658529	18-3854	252	89-F460917-1	18-5835	239
26-817472	18-0500	255, 257, 460	27-820438	18-3855	252	F460917-1	18-5835	239
26-819396	18-0502	255, 257	27-F201529-1	18-3856	252	398-832075A4	18-5870	239
26-F40307-2	18-0503	255, 257	27-824615	18-3857	253	398-832075A6	18-5873	239
26-F84307-1	18-0512	255, 257	27-824615-2	18-3857	253	332-5772A5	18-5881	239, 377
26-41131	18-0579	257	27-F476529-4	18-3857	253	332-5772A7	18-5881	239, 377
26-41132	18-0580	257	F476529	18-3857	253	820545	18-6279	242
26-43035	18-0583	257	F476529-1	18-3857	253	F694541-1	18-6279	242
26-66022	18-0584	257	F476529-2	18-3857	253	827675A1	18-6286	242
26-F346118	18-0584	257	27-819138-2	18-3859	253	50-803903T	18-6439	242
			39-817869A1	18-39010	251	50-F575955	18-6439	242
			FA663260	18-39010	251	50-803900T	18-6441	242
			39-820457A2	18-3998	251	50-F514955	18-6441	242
			39-820641A1	18-3999	251	455541	18-6762	242
			47-F433065	18-45003	248	449541-3	18-6762	242
			700-834794T3	18-4629	251	824051	18-6775	242

Chrysler Force (Cont.)			Chrysler Inboard (Cont.)			Crusader (Cont.)		
O.E. #	SIERRA #	PAGE #	O.E. #	SIERRA #	PAGE #	O.E. #	SIERRA #	PAGE #
19217A1	18-6777	242	3675826	18-1942	605	96653	18-0418	629
19217A5	18-6777	242	24695566	18-1942	605	20129	18-0976	630
818903A1	18-6777	242	2847404	18-1944	604	R130012	18-15214	615
819479A1	18-6777	242	2847623	18-1944	604	97169	18-1916	626
819480A1	18-6777	242	3745639	18-1944	604	97296	18-1917	629
819762A4	18-6777	242	E9923M	18-1944	604	97386	18-1918	626
819762A7	18-6777	242	2846689	18-1945	604	97387	18-1919	628
81977A8	18-6777	242	3527794	18-1946	604	97624	18-1924	626
81977A9	18-6777	242	E9234M	18-1948	605	96120	18-1925	625
822870A1	18-6777	242	3745215	18-28019	190	97752	18-1925	625
830250A3	18-6777	242	2469559	18-2941	606	96121	18-1926	625
830250T3	18-6777	242	2847480	18-2941	606	97753	18-1926	625
832021A1	18-6777	242	10927	18-3188	Obsolete	97772	18-1927	626
832021A2	18-6777	242	4142885	18-3551	596	97924	18-1928	626
832021T2	18-6777	242	3004886	18-3581	597	97114	18-1929	625
832021T4	18-6777	242	3619542	18-3581	597	97992	18-1929	625
855654A1	18-6777	242	3745985	18-3581	597	97115	18-1933	625
855654T2	18-6777	242	4417905	18-3581	597	97993	18-1933	625
FK10003	18-7033	243	3619859	18-3582	597	98068	18-1934	626
FK10026	18-7033	243	2463441	18-3645	596	98126	18-1938	624
FK10053	18-7033	243	4142880	18-3860	597	RO29015	18-1938	624
FK10102-1	18-7033	243	4417375	18-3878	597	98125	18-1982	625
FK10004	18-7037	243	3745220	18-4346	599	98128	18-1984	627
FK10005	18-7037	243	3656017	18-5102	592	96938	18-2434	576, 615
FK10007	18-7037	243	3780600	18-5103	593	91351	18-2845	630
FK10008	18-7037	243	3874020	18-5105	593	97498	18-2909	629
FK10027	18-7037	243	2421173	18-5303	590	96306	18-2949	629
FK10057	18-7037	243	2808870	18-5303	590	1003062	18-3046	628
FK10108	18-7037	243	1274092	18-5307	590	22212	18-3060	618
FRK739	18-7037	243	2084074	18-5307	590	1003026	18-3060	618
FO10790	18-7041	245	2421178	18-5307	590	20300	18-3061	628
FO16311	18-7041	245	2421820	18-5314	590	20502	18-3140	618
FO10790	18-7057	243	2098058	18-5345	590	20309	18-3168	Obsolete
25-85594	18-7100	254	2279949	18-5345	590	40057	18-3169	Obsolete
25-F498618	18-7120		1818757	18-5347	590	96319	18-3551	619
25-32507	18-7127	257	3420600	18-5347	590	96358	18-3552	619
25-F84305	18-7127	257	4142817	18-5352	590	30103	18-3577-2	619
F83404	18-7127	257	4142408	18-5369	590	20318	18-3599-2	619
25-20195	18-7134	257	868096	18-5404-1	590	7142520	18-3599-2	619
25-201951	18-7134	257	1658535	18-5407	590	97895	18-3649	619
25-F24278	18-7169	257	2098611	18-5429	590	97361	18-3671	619
25-F74305	18-7176	257	868095	18-5430	590	31137	18-3874	630
3745414	18-7254	167, 596	201522	18-5433	592	7057500	18-3876	630
3745415	18-7255	167, 596	2495531	18-5433	592	30266	18-3877	630
1736073	18-7264	167, 596	200691	18-5435	592	33408	18-3879	630
2279913	18-7264	167, 596	4106140	18-5450	592	31136	18-3887	630
25-F45530	18-7457	257	3874767	18-5451	592	33393	18-4408	629
F24747-1	18-7805	243	2098300	18-5710	597	7243110	18-5107-1	614
21-42990A10	18-7817	243	2847527	18-5710	597	41058	18-5303	609
21-42990A7	18-7817	243	2095946	18-5723	595	705788	18-5307	609
21-42990A8	18-7817	243	1692658	18-5841	594	12525	18-5310	609
21-42990A9	18-7817	243	3527501	18-5954	595	37061	18-5313-1	613
21-857005A1	18-7817	243	3527502	18-5954	595	20117	18-5314	609
L-319	18-7879-1	201, 597	3744870	18-5954	595	3000124	18-5318	609
25-45258	18-7950	255, 257, 430, 460	4142886	18-7230	596	12530	18-5338	609
25-88657	18-7952	255, 257	3745414	18-7254	167, 596	12526	18-5344	609
25-85549	18-7956	257	3745415	18-7255	167, 596	41057	18-5345	609
FS409752	18-8011EP-2	159, 247	1736073	18-7264	167, 596	705787	18-5345	609
197787-3	18-8062	247	2279913	18-7264	167, 596	41076	18-5352	610
26-76384	18-8347	257	7087-OR	18-7512	Obsolete	41069	18-5353	610
26-816464	18-8347	257	56874	18-7875	201, 597	38070	18-5354	610
26-8164641	18-8347	257	1851658	18-7875	201, 597	41052	18-5369	610
26-828627	18-8354	257	F724002	18-7875	201, 597	12532	18-5375	611
47-19453	18-8900	248, 411	3549957	18-7878-1	201, 597	1003317	18-5375	611
47-F462065	18-8901	248	L-1008	18-7878-1	201, 597	20222	18-5376	611
47-F436065-2	18-8903	248	L-19	18-7878-1	201, 597	12528	18-5384	611
CHRYSLER INBOARD			CHRYSLER FORCE					
10612	18-0499	597	31-F523901	18-1112	257	3000121	18-5389	611
3745217	18-0607	605	31-F523143	18-1113	257	41061	18-5399	592
4273129	18-0609	597	44-850308	18-2254	256	41074	18-5403	609
118-614	18-0956-1	605	398-176	18-5206	241	41089	18-5403	609
2469556	18-1913	605	CRUSADER			20223	18-5404-1	610
2469639	18-1913	605	96108	18-0305-1	629	38071	18-5405	610
2847405	18-1913	605	96216	18-0306-1	629	41059	18-5407	610
3675826	18-1940	604	96582	18-0309-1	629	12531	18-5411	610
4142322	18-1940	604	97686	18-0311	630	1003318	18-5411	610
2846106	18-1941	605				3000122	18-5420	610
						705786	18-5427	610
						37068	18-5433	614

Crusader (cont.)			Electrolux (cont.)			Honda (Cont.)		
O.E. #	SIERRA #	PAGE #	O.E. #	SIERRA #	PAGE #	O.E. #	SIERRA #	PAGE #
51080	18-5433	614	KS3448/290	18-6790	974	37510-PNB-003	18-25201	261
41080	18-5435	614	EVINRUDE			19232-ZV1-A10	18-2524	265
37068	18-5438	614				587078	18-5909	282
7243200	18-5443	614	587291	18-5909	282	19234-ZW1-003	18-2564	S/S to 18-2564-1
42001	18-5717	615	FRAM			19234-ZW1-003	18-2564-1	265
707125	18-5717	615				CCS 1136	18-7935	157, 688
700427	18-5898	619	GLM			19232-881-850	18-2608	265
700425	18-5899	619				21090	18-2163E-9	851
42090	18-5907	615	GM			90752-ZW9-A30	18-3022	263
42091	18-5908	615				3701777	18-2917	925
45334	18-7095	616	6269358	18-3577-2	905	19210-ZY3-003	18-3031	262
45303	18-7200	617	6269577	18-3876	650	19210-ZW1-003	18-3056	262
97214	18-7231	617	14089026	18-3937	921, 997	19210-ZW9-003	18-3100	262
97595	18-7231	617	14089026	18-3938	997	19210-ZW9-013	18-3100	262, 263
33628	18-7232	617	14077949	18-4164	921	19231-ZW1-003	18-3122	262
32722	18-7256	167, 617	14077948	18-4173	921, 997	06192-ZW1-305	18-3187	262
21140	18-7270	167, 169, 618	10482803	18-5117	698	90508-ZW1-003	18-3200	268
21141	18-7271	169	6414989	18-7258	168	19021-ZW1-003	18-3214	262
97039	18-7272	167, 169, 618	HITACHI			35655-ZY3-C01	18-32153	261
47002	18-7600	616				S114-837	18-6831	479
47032	18-7630	616	S114-837A	18-6831	479	19210-881-A01	18-3245	262
47033	18-7632-1	616	S114-559B	18-6861	496	19210-881-A02	18-3245	262
201104	18-7824-2	201, 630	S114-257	18-6880	680	19210-ZW9-A02	18-3245	262
98041	18-7846	618	S114-257G	18-6880	680	19210-ZW9-A31	18-32455	262
22687	18-7852-1	618	S114-483	18-6880	680	19210-ZW9-A32	18-32455	262
91606	18-7862	618	S114-483A	18-6880	680	19210-ZV4-013	18-3246	262
9002514	18-7875	201, 630	LR135-105	18-6925	679	19210-ZV4-651	18-3246	262
201104	18-7876-1	201, 589	LR135-74	18-6928	679	19210-ZV4-651	18-3247	262, 263
47047	18-7958	618	LR135-74B	18-6928	679	19210-ZV5-003	18-3248	262
23250	18-7976	Obsolete	129470-77200	18-6929	679	19210-ZV5-003	18-3249	262
97854	18-8112	621, 622, 624, 627	LR180-03A	18-6929	679	19210-ZV7-003	18-3249	262
RP061022	18-8926	618	LR180-03B	18-6929	679	19210-ZW1-B04	18-3250	262, 263
CUMMINS			LR180-03C	18-6929	679	90752-ZV4-650	18-3268	262
650607	18-3077	574	S13-68	18-6934	680	90752-ZV7-000	18-3269	262
160596	18-3078	573	S13-68A	18-6934	680	90752-ZV5-003	18-3270	262
166758	18-3078	573	S13-68C	18-6934	680	90752-ZV1-B02	18-3271	262
556540	18-3078	573	S13-86	18-6934	680	90752-ZY3-003	18-3273	263
556850	18-3078	573	S114-303	18-6937	680	06192-ZV1-C00	18-3278	263
21601R	18-3078	573	S114-303A	18-6937	680	06192-881-C00	18-3279	263
216040	18-5982	679	S114-682	18-6942	496	06192-ZV4-000	18-3280	263
3604234RX	18-5982	679	HONDA			06192-ZV7-000	18-3281	263
214169	18-6952	679				19242-ZV5-000	18-0176	265
3920618	18-6952	679	17151-ZW5-000	18-0248	266	06192-ZV1-000	18-3283	263
3603853RX	18-6952	679	17105-ZY6-000	18-0300	266	06192-ZY6-000	18-3284	263
DELCO			17109-XY6-000	18-0382	266	06192-ZV4-000	18-3288	266
1115202	18-5433	678	17105-ZY3-004	18-0390	266	06192-ZV7-000	18-3478	263
1114356	18-5838	893	17109-ZY3-004	18-0396	266	06192-ZV5-003	18-3489	263
1114458	18-5838	893	19234-ZW1-B00	18-0481	263	06192-ZV5-003	18-3492	263
1100077	18-6952	679	19242-ZW1-800	18-0482	263	19300-881-761	18-3627	262
1100093	18-6952	679	91254-ZW1-003	18-0522	268	19300-ZW9-003	18-3628-1	262
1100211	18-6952	679	91251-ZW1-003	18-0583	268	19300-881-741	18-3629	262
1100274	18-6952	679	16176-POA-004	18-0737	266	19300-ZY5-043	18-3630	262
1105474	18-6952	679	91051-ZW1-003	18-1156	267	17660-ZV5-902	18-38008	260
1105475	18-6952	679	91057-ZW1-003	18-1157	267	06192-ZV4-A00	18-4536	263
1105476	18-6952	679	91053-ZW1-003	18-1158	267	41107-ZW1-003ZA	18-6011	268
10459244	18-6952	679	31200-ZW1-004	18-15061	259	41107-ZW1-003ZA	18-6011A	268
DENSO			91251-ZW1-B04	18-1820	263	41109-ZW1-003	18-6068	267
101211-3460	18-6844	721	91252-ZW1-003	18-2002	268	41107-ZV5-00-00	18-6165A	268
101211-9940	18-6849	679	91253-ZW1-003	18-2054	268	41107-ZW1-003ZA	18-6241	268
228000-4550	18-6867	569	30520-PWC-003	18-23251	258	36120-ZV5-821	18-6258	259
995435	18-6868	569	16221-ZV4-610	18-2470	266	31200-ZV5-013	18-6433	259
128000-4860	18-6868	569	16221-ZW9-000	18-2471	266	31200-ZW9-802	18-6445	259
128000-4861	18-6868	569	16221-ZW1-000	18-2472	266	31630-ZW5-003	18-6475	258
128000-4862	18-6868	569	16201-881-850	18-2473	266	31630-ZY6-003	18-6476	258
128000-4863	18-6868	569	16010-ZV4-005	18-2480	265	36120-ZY3-023	18-6742	259
128000-4864	18-6868	569	16010-ZW9-003	18-2481	265	36120-ZY9-003	18-6743	259
128000-4865	18-6868	569	16010-881-003	18-2482	266	36120-ZY6-013	18-6745	259
128000-4866	18-6868	569	19232-ZV4-610	18-2495	263, 265	36120-ZY6-822	18-6793	259
428000-0081	18-6873	569	19233-ZV5-000	18-2496	265	31200-ZY6-003	18-6959	259
101211-3020	18-6960	721	19234-ZY3-000	18-2499	265	31200-ZY9-003	18-6959	259
101211-3021	18-6960	721	37500-PNB-003	18-25200	261	31200-ZY9A-0031	18-6959	259
DETROIT DIESEL						16011-ZV4-005	18-7047	261
5574508	18-7931	157, 688				16011-881-741	18-7048	261
ELECTROLUX						91301-ZG3-000	18-71335	263
5024/120	18-6758	974				91353-ZW1-003	18-7198	268
						30520-PNA-007	18-7494	258
						16910-ZVL-003	18-7521	260

Honda (Cont.)			JABSCO			Johnson/Evinrude (Cont.)		
O.E. #	SIERRA #	PAGE #	O.E. #	SIERRA #	PAGE #	O.E. #	SIERRA #	PAGE #
37830-PGK-A01	18-7552	261	92700-0060	18-2005	574	339720	18-4569	297
30530-PPL-A01	18-7558	261	1210-0003	18-3020	574	360347	18-4571	297
30530-PBF-A01	18-7559	261	4598-0001	18-3021	574	324640	18-4578	303
35655-ZY3-013	18-7657	Obsolete	673-0003	18-3036	573	338485	18-4579	302, 303
35655-ZY9-003	18-7658	261	836-0003	18-3037	573	355169	18-5701	294, 302
35655-ZY6-013	18-7659	261	17937-0003	18-3038	573	355209	18-5703	294, 302
16910-GB2-005	18-7712	260	920-0003	18-3038	573	5005831	18-6815	278
16900-SR3-004	18-7720	260	18838-0001	18-3046	573	586768	18-6826	284
16010-ST5-993	18-7785	260	18948-0001	18-3047	573	302035	18-71336	302, 303
16900-SA5-004	18-7786	260	18838-0001	18-3060	982, 1012	346865	18-71338	302
15400-PLM-A01PE	18-7909	202, 267	18948-0001	18-3061	982	342370	18-71340	303
15400-POH-305	18-7909	202, 267	124310-46090	18-3075	573	354578	18-9084	302
15400-POH-305PE	18-7909	202, 267	14510-46090	18-3075	573	325040	18-99156	303
15400-ZJI-004	18-7909	202, 267	2877-0001	18-3075	573	KAWASAKI		
15400-PFB-007	18-7911-1	202, 267	4568-0001	18-3075	573	21163-3715	18-6873	569
15400-PFB-014	18-7913	202, 267	22405-0001	18-3076	573	21163-3719	18-6873	569
17670-ZW1-030GH	18-7947	157, 260	920-0001	18-3077	573	21163-3720	18-6904	569
17670-ZW1-801AH	18-7948	157, 260	836-0001	18-3078	573	21163-3720	18-6904	569
16911-ZY3-010	18-79908	261	4528-0001	18-3079	573	21163-3720	18-6904	569
16901-ZY3-003	18-79909	261	673-0001	18-3080	573	K61021-208A	72-5103-2	211
16977-ZV5-A00	18-80400	260	1210-0001	18-3081	573	21174-3703	18-6875	570
16977-ZV5-900	18-80406	260	3101-0000	18-3125	574	MALIBU		
17710-ZW9-033	18-80407	260	17935-0001	18-3275	573	S556162	18-32152	633
17650-ZW9-003	18-80408	260	6760-0001	18-3304	573	MALLORY		
17650-921-003ZB	18-80420	260	13554-0001	18-3306	573	9-72152	18-2163E-9	851
17700-ZW9-010	18-81042EP-2	159, 260	17636-0001	18-45712	574	YL567EV	18-26104-1	183, 703, 887
17700-ZW9-020	18-81042EP-2	159, 260	21676-0001	18-45712	574	YL700AV	18-26107-1	183
16910-ZV4-015	18-8226	260	18653-0001	18-45713	573	YL579AV	18-26110-1	183, 703
91252-935-004	18-8298	266	JOHNSON			YL648AV	18-26111-1	183, 701
91356-ZY3-003	18-8299	266	5036972	18-6945	284	YLM700AV	18-26310-2	182
19232-ZW9-000	18-99153	263	JOHNSON PUMP			YLM566AV	18-26311-2	182
19234-ZX2-C00	18-99154	263	09-1027B-9	18-3020	575	670	18-26800	183
HP4	72-5100-2	211	09-1026B-9	18-3036	574	29349	18-26815	183
08208-0080	72-5102-2	212	09-1029B-9	18-3037	574	29716	18-29716	662
HP2	72-5103-2	211	09-1028B-9	18-3038	575	29217	18-29717	662
HP2	72-5103-3	211	09-801B	18-3075	574	29440M	18-29720	662
HP2	72-5103-4	211	09-45589	18-3076	575	4110M	18-34110	665
HP2	72-5103-5	211	09-808B	18-3076	575	5110MFI	18-34120	665
HP2	72-5103-7	211	09-1028B	18-3077	574	4140M	18-34140	665
HONDA PWC			09-1029B	18-3078	574	5421	18-35101	Obsolete
31200-HW1-871	18-8877	569	09-806B	18-3079	574	54212	18-35102	665
ILMOR			09-1026B	18-3080	574	YL512CV	18-5309-1	183, 613, 640
S556162	18-32152	633	09-1026B-1	18-3080	983	YL554CV	18-5312-1	183, 640, 702, 887
MV8V1021	18-57824	201	09-1026B-9	18-3080	574	YL624AV	18-5313-1	183, 702
ILMOR / MASTERCRAFT			09-1027B	18-3081	574	YL624MW	18-5313-1	582, 613, 640, 887
550022689	18-9558-2	208	09-45825	18-3089	575, 983	YL673AV	18-5315-1	183, 702, 887
550046126	18-9558-4	208	3298-0000	18-3125	575	YL624BV	18-5316-1	183, 702, 887
INDMAR			09-819B	18-3275	574	9-26103	18-5339-1	703, 887
53-2009	18-1907	587, 604, 627, 660, 797, 988,	09-1028B	18-3277	982	YL566AV	18-5339-1	183, 703, 887
53-2018	18-1907	587, 604, 627, 660, 797, 988,	01-42401	18-3303	575	9-29418	18-5397	697, 882
S525009	18-31104	Obsolete	09-802-B	18-3304	634	YLM673AV	18-5486-2	182, 886
S556162	18-32152	633	09-812B	18-3306	574	YLM673AV	18-5486-2	182, 886
685011	18-3586-1	634	09-45589	18-3510	575	YLM676AV	18-5487-2	182, 702, 704, 886
685001	18-3587-1	634	10-24228-1	18-3586-1	575	YLM554CV	18-5489-2	182, 886
S556050	18-42608	634	10-24232-1	18-3587-1	575	YLM512CV	18-5495-2	182, 641, 886
S985009	18-43017	634	09814B	18-45712	575	YLM567CV	18-5496-2	182, 702, 886
755021	18-5277	631	09-810B	18-45713	575	YLM624BV	18-5498-2	182, 703, 887, 960
751007	18-5303	633	JOHNSON/EVINRUDE			9-34081	18-7489	666
755017	18-5345	631	328725	18-1596	303	MANDO		
573001	18-5603-1	633	302325	18-1597	302, 303	A000B0341	18-6843	1012
0170-000	18-5603-1	636	353690	18-1821	303	TA000B0341	18-6843	1012
575011	18-5984	633	354580	18-1822	302	MARINE POWER		
575010	18-6288	633	5007770	18-1823	302	0991-110	18-1898	587, 604, 625, 660, 794, 915, 987,
575014	18-6451	633	349354	18-1824	302	0992-593	18-1939	587, 604, 627, 660, 797, 916, 988
50-1001	18-7824-2	201	340811	18-1825	303	612011	18-1985	797
S556003	18-7976	Obsolete	338601	18-1826	302	0100-000	18-2434	576
501022S	18-8623	Obsolete	321129	18-1827	303	0170-000	18-5603	S/S to 18-5603-1
872025	18-8779	201, 634	328754	18-2147	302, 303	50-808011A4	18-5603-1	714, 716
872005	18-9554-2	208	331130	18-3026	303	402001	18-6299	636
872006	18-9554-4	208	331894	18-3566	307	0994-000	18-8536	636
872003	18-9555-2	208	5005034	18-3753	347			
872004 (7QT)	18-9555-4	208	5008967	18-4539	294			
			338486	18-4549	302, 303			
			324641	18-4551	303			
			5007554	18-4568	297			

MARINER			Mercury (Cont.)			Mercury (Cont.)		
O.E. #	SIERRA #	PAGE #	O.E. #	SIERRA #	PAGE #	O.E. #	SIERRA #	PAGE #
27-99049M	18-74501	462	864493	18-43015	758	861425	18-7551	728
McCULLOCH			863358T	18-43017	758	808015T	18-7553	728
1340135	18-5153	372	8M0074922	18-43017	758	878187	18-7554	728
36550135	18-5153	372	8M0076464	18-43017	758	864297001	18-7556	698
75101A	18-5153	372	14586A3	18-43052	408	35-866594K01	18-7596	407
38850115	18-5241	240	75962A10	18-43052	408	25-803513007	18-76695	467
MERC / EVINRUDE			75962A11	18-43052	408	91-896661	18-79814	223
881150K1	18-9895	220	75962A9	18-43052	408	91-879172T28	18-79816	216
MERCUISER			855676002	18-43175	408	35-8M0079962	18-79911	153, 407, 750
27-864549A02	18-0720	801	46-803750A2	18-43212	412	35-8M0082290	18-79912	153
27-864549A1	18-0720	801	32-861635	18-44092	771	3310-866142A03	18-79994N	733
27-864547A02	18-0721	801	821354A2	18-4531	416	3310-866142A04	18-79994N	733
27-864547A1	18-0721	801	47-95289	18-45312	411	3310-866143A03	18-79995N	Obsolete
27-864547A1	18-0722	801	47-952892	18-45312	411	92-8M0062765	18-8606	217
27-864850A02	18-0722	801	8213542	18-4577	411, 416	22-8M0001721	18-8956	400
26-11973	18-1213	818	46-803750A03	18-48317	416, 476	22-818994	18-8957	400
26-42750	18-1213	818	728374-92605	18-55503	689	22-424254	18-8958	400
26-54799	18-1213	818	8M0142679	18-55505	392	92-802859A1	18-9240-0	215, 858
26-97335	18-1213	818	8M0137769	18-55505	392	92-802863A1	18-9240-1	215, 858
27-75611A03	18-1254	822	59341A1	18-56870	Obsolete	92-802833Q1	18-9420-2P	206
864308T01	18-1843	796	893640T01	18-5732	386	92-802835Q1	18-9420-3P	206
865049T01	18-1843	796	807057	18-5851	387	92-802835Q1	18-9420-30	206
865735A02	18-1843	796	807057T	18-5851	387	92-802835Q1	18-9420-30P	206
864591T02	18-1845	797	865202T	18-5851	387	92-802836A1	18-9420-7P	206
11-88462	18-2460	864	27-850838001	18-60916	435	91-47448A1	18-9896	223
22-88847A1	18-2460	864	27-803508017	18-60917	440	91-75132	18-9896	223
92-802837Q1	18-9400-2P	206	27-835427003	18-60918	441, 477	91-878232	18-9896	223
92-857389A1	18-9400-4P	206	27-834952001	18-60919	441, 477	91-90455	18-9896	223
92-802841A1	18-9400-7P	206	27-853702005	18-60920	441	91-904551	18-9896	223
92-858057K01	18-9440-7P	206	27-827154	18-61319	Obsolete	91-90455T	18-9896	223
MERCURY			27-142471	18-61513	Obsolete	91-90455T1	18-9896	223
88-93582	18-15501	720	27-14247T1	18-61513	Obsolete	91-895343A02	18-9897	223
43023	18-1838	411, 416	27-815791A00	18-64217	435	91-895343T01	18-9897	223
8235471	18-1839	411, 416	27-835427A04	18-64221	Obsolete	91-895343T02	18-9897	223
864612T01	18-1842	796	50-86976	18-6825	392	27-822217	18-99155	416
806867A12	18-1966-1	796	50-41583	18-6828	392	MERCURY MARINE		
806867A2	18-1966-1	796	859168	18-6829	392	92-809819	37478	Obsolete
806867A3	18-1966-1	796	50-859168T	18-6829	392	92-809820	37479	219
806867A8	18-1966-1	796	50-852570	18-6829	392	92-59327-1	37509	Obsolete
806867A9	18-1966-1	796	50-852570T	18-6829	392	92-809824	37509	Obsolete
816329A3	18-1966-1	796	50-857065	18-6829	392	FT8935	37509	Obsolete
860235A03	18-1966-1	796	50-859168	18-6829	392	92-41669-1	37534	Obsolete
99798A18	18-1966-1	796	859168T	18-6829	392	92-802882A1	37534	Obsolete
339-859738T1	18-23205	Obsolete	50-897755T	18-6840	390	92-823506 1	37534	Obsolete
18066004	18-25400	376	897755T	18-6840	390	92-34227	1525607	Obsolete
803844T01	18-25513	Obsolete	50-819271	18-6864	392	92-342271	1525607	Obsolete
84-821945A56	18-28080	381	50-820193A1	18-6864	392	92-34227Q02	1525607	Obsolete
84-813706A56	18-28081	381	50-805833	18-6870	680	92-802881A1	1525607	Obsolete
84-813715A8	18-28082	381	50-893894	18-6943	392	27-73397	18-0101	Obsolete
84-881908T	18-28083	189, 381	882571	18-6948	679	27-76952	18-0101	Obsolete
84-881908T	18-28084	189, 381	8M0084523	18-6948	721	27-37725	18-0103	432, 433, 440
84-881908T	18-28085	189, 381	50-831001671	18-6954	680	27-72496	18-0103	432, 433, 440
84-881908T	18-28086	189, 381	50-831001672	18-6954	680	27-79650	18-0103	432, 433, 440
27-860232	18-2849-1	827	50-831002051	18-6954	680	27-85489-2	18-0105	432, 438
27-863726	18-2849-1	827	50-831002052	18-6954	680	27-64203	18-0107	432, 438
27-87105	18-2849-1	827	684311	18-7083	404	27-72510	18-0107	432, 438
802632	18-33104	728	816877	18-7083	404	27-85498-1	18-0107	432, 438
802632T	18-33104	728	858763	18-7083	404	27-89657	18-0111	823, 8827
860349A1	18-33207	727	8168771	18-7083	404	27-856705	18-0113-1	827
892681	18-33211	727	8168772	18-7083	404	27-97542	18-0113-1	823, 823, 827
21-806118	18-33800	727	8168773	18-7083	404	27-65744	18-0129	438
42725A3	18-35437	743	98230A1	18-73131	849	27-657441	18-0129	438
861676A1	18-35437	743	14307T01	18-7328	399	27-657442	18-0129	438
861676T09	18-35437	743	888733T02	18-7336	399	27-657443	18-0129	438
8M0073435	18-35437	743	898101T67	18-7337	399	27-64857	18-0131	438
892864T04	18-3631	409	880596T55	18-7338	399	27-69525	18-0131	438
8M0090819	18-3633	409	880596T58	18-7346	399	27-695251	18-0131	438
892864T06	18-3635	409	8M0065218	18-7347	399	27-695252	18-0131	438
804540	18-3638	409	809569	18-7380	396	27-52892	18-0133	438
8M0117413	18-3640	409	16253	18-7381	396	27-73665	18-0133	438
855676A1	18-3642	409	804184	18-7382	396	27-78246	18-0135	440
811536	18-36906	739	35-880084T01	18-7523	408	27-782461	18-0135	440
811536T	18-36906	739	861249	18-7550	727	27-85492-2	18-0137	438
1395-9267	18-36956	396	861249A1	18-7550	727	27-76589	18-0139	440

Mercury Marine (Cont.)			Mercury Marine (Cont.)			Mercury Marine (Cont.)		
O.E. #	SIERRA #	PAGE #	O.E. #	SIERRA #	PAGE #	O.E. #	SIERRA #	PAGE #
27-78623	18-0139	440	F11100229	18-0348	823	26-34217	18-0518	464, 818
27-88451	18-0139	440	F15000229	18-0348	823	26-58094	18-0518	818
27-884511	18-0139	440	F15000245	18-0348	823	26-72564	18-0518	818
27-56880	18-0147	829	27-56173	18-0352	828	26-75413	18-0518	818
27-75952	18-0151	439	27-58784	18-0353	799	26-75624	18-0518	818
27-76636	18-0151	439	27-60715	18-0354	825	26-14240	18-0519	464, 818, 875
27-72627	18-0153	823	27-32910	18-0356	825	F11101300	18-0519	818
27-85817A1	18-0153	823	27-64692	18-0356	825	26-36557	18-0521	443
F15110032	18-0153	823	27-56884	18-0357	825	26-43036	18-0522	464, 875
F15110037	18-0153	823	27-65577	18-0357	825	26-43993	18-0523	464, 875
27-70905	18-0158	827	27-67275	18-0359	438	26-45587	18-0525	464, 875
26-97530	18-0172	464, 875	27-672751	18-0359	438	26-48443	18-0526	464, 875
25-26543	18-0175	823	27-70142	18-0360	826	26-56397	18-0527	464, 875
27-62386	18-0182	441	27-75450	18-0365	827	26-56868	18-0528	818
27-54566	18-0183-1	661, 799, 827	27-75909	18-0369	440	26-62818	18-0529	464, 875
27-73866	18-0183-1	661, 799, 827	27-39316	18-0371	438	26-72785	18-0531	464, 875
27-91892	18-0185	823, 829	27-72915	18-0371	438	26-85107	18-0537	464, 875
8227731	18-0202-9	456	27-78409	18-0371	438	37721	18-0539	443
12-25410	18-0203	831	27-52579	18-0372	439	26-84613M	18-0554	464
12-35935	18-0203	831	27-72916	18-0372	439	888909A1	18-0557	451
23-1761515	18-0208	844	27-78410	18-0372	439	26-896600	18-0560	464
23-1761516	18-0210	844	27-45088	18-0373	438	26-36556	18-0563	443, 873
23-1761517	18-0212	844	27-72917	18-0373	438	26-888483	18-0564	464
23-1761518	18-0214	844	27-78411	18-0373	438	23-43045	18-0568-9	443
23-1761519	18-0216	844	27-823142	18-0378	440	35993A1	18-0577	850
23-1761520	18-0218	844	27-823142 2	18-0378	440	66081A1	18-0577	850
23-1761522	18-0222	844	27-83940M	18-0380	438	66081A2	18-0577	850
23-1761523	18-0224	844	27-817533	18-0384	437	66081A4	18-0577	850
23-1761524	18-0226	844	27-89221	18-0384	437	26-67388	18-0578	818, 875
23-1761526	18-0230	844	27-892211	18-0384	437	26-41131	18-0579	464
27-81031M	18-0232	439	27-8M0027781	18-0384	437	26-41132	18-0580	464
26-82257M	18-0267	464	27-30803	18-0385	440	26-41365	18-0581	464
27-81417M	18-0292	441	27-31557	18-0385	440	26-43035	18-0583	464
27-81421M	18-0294	441	27-45748	18-0385	440	26-66022	18-0584	464
26-854017M	18-0296	464	27-89937	18-0385	440	26-821928	18-0585	464
26-82234M	18-0297	564	27-72780	18-0386	829	26-99325	18-0586	464
25-82275M	18-0298	467	27-94914	18-0386	829	26-66303	18-0595	464
25-82289M	18-0299	467	27-98823	18-0388	830	27-75483	18-0611	824
27-11988	18-0311	828	27-988231	18-0388	830	14259	18-0612	808
12-815472	18-0318	831	27-99960	18-0389	827	809910	18-0612	808
27-828553	18-0319	430, 440	27-33918	18-0398	827	F11101295	18-0612	808
27-13937-6	18-0320	438	27-8M2021920	18-0398	827	93476	18-0613	808
27-14241	18-0322	830	27-52571	18-0403	820	811549	18-0614	808
27-881715	18-0322	830	27-61782	18-0403	820	850458	18-0614	808
F1101656	18-0322	830	27-805722A1	18-0403	820	845668T	18-0614	808
27-14318 3	18-0323	441	27-812712	18-0403	820	14760	18-0615	808
27-14318-2	18-0323	441	27-805403A1	18-0404	820	75639	18-0615	808
27-15172	18-0324	437	27-14247	18-0405	823	93477	18-0615	808
27-15172-3	18-0324	430	27-883964	18-0405	823	93477T	18-0615	808
27-151724	18-0324	437	27-883964T	18-0405	823	14244	18-0616	808
27-93214	18-0324	437	27-56870A1	18-0407	824	14244T	18-0616	808
27-33956	18-0327	829	27-64798	18-0407	824	27-19701	18-0622	442
F15000200	18-0327	829	27-75648	18-0410	824	27-188891	18-0624	438
F15000219	18-0327	829	27-90458	18-0411	824	27-19206	18-0633	437
27-34208	18-0328	829	27-90458A1	18-0411	824	27-192061	18-0633	437
27-34209	18-0329	829	F15000178	18-0411	824	27-41449	18-0633	437
27-39401	18-0333	440	F15000183	18-0411	824	27-414491	18-0633	437
27-39402	18-0334	440	27-46820	18-0418	661	27-42178	18-0633	437
27-41670-3	18-0336	440	391-5076	18-0422	826	27-828292	18-0641	437
27-41670-5	18-0336	440	27-48399	18-0462	826	27-19050	18-0642	439
27-43006-2	18-0339	441	27-814210	18-0463	826	27-190502	18-0642	439
27-430066	18-0339	441	27-49121	18-0464	828	27-190503	18-0642	439
27-43008	18-0341	440	27-91831	18-0464	828	27-190505	18-0642	439
27-430082	18-0341	440	27-65184	18-0465	822	27-18307-1	18-0643	434, 440
27-430083	18-0341	440	27-8M0050224	18-0465	822	27-183076	18-0643	440
27-430085	18-0341	440	27-14901	18-0466	823	27-146972	18-0644	438
27-430086	18-0341	440	27-14901A1	18-0466	823	27-167371	18-0645	438
27-47644	18-0342	830	27-52144	18-0466	823	27-813859	18-0646	434, 438
27-47644	18-0342	830	27-41610	18-0467	826	27-858935	18-0649	440
27-476441	18-0342	830	27-49814	18-0467	826	27-17467	18-0664	828
27-822189	18-0345	442	27-811572	18-0468	828	F11101287	18-0664	828
27-34042	18-0346	828	27-824326002	18-0487	824	27-99506	18-0667	826
27-49936	18-0346	828	27-8243261	18-0487	824	27-995061	18-0667	826
27-34041	18-0347	828	27-807473A1	18-0488	824	27-43007	18-0670	440
27-52145	18-0347	828	26-25329	18-0514	443	27-430073	18-0670	440
27-806452	18-0347	828	26-30530	18-0515	464, 875	27-430075	18-0670	440
27-49107	18-0348	823	26-30913	18-0516	464, 875	27-41811	18-0672	800
27-52550	18-0348	823	26-32911	18-0517	464, 875	27-860231	18-0672	800

Mercury Marine (Cont.)			Mercury Marine (Cont.)			Mercury Marine (Cont.)		
O.E. #	SIERRA #	PAGE #	O.E. #	SIERRA #	PAGE #	O.E. #	SIERRA #	PAGE #
27-863725	18-0672	800	27-738141	18-0928-1	827	68704A1	18-1148	813
27-8637251	18-0672	800	27-807218	18-0928-1	827	31-92366	18-1150	Obsolete
27-815528	18-0680	828	27-76862	18-0932	439	31-92366A1	18-1150	Obsolete
12-32834	18-0681	831	27-768621	18-0932	439	30-20066	18-1151	377
12-8M2001219	18-0681	831	27-78069	18-0934-1	441	30-23679	18-1152	377
12-93416	18-0681	831	27-78690	18-0936	441	30-20464	18-1153	424, 450, 863
12-934161	18-0681	831	27-55308	18-0940	439	30-49313	18-1153	424, 450, 863
27-73666	18-0685	825	27-78027	18-0940	439	30-54215	18-1153	424, 450, 863
25-809086	18-0715	396	27-85488	18-0940	439	30-63326	18-1153	424, 450, 863
27-805396	18-0740-1	548	27-854881	18-0940	439	30-63326T	18-1153	424, 450, 863
27-880729	18-0791	440	27-854882	18-0940	439	30-63742	18-1154	424, 450
27-824853	18-0835	441	27-46110	18-0942	439	30-63742T	18-1154	450
27-8248531	18-0835	441	27-72486	18-0942	439	30-17927	18-1155	450, 863
25-54029	18-0858	467, 876	27-85491	18-0942	439	30-35914	18-1155	450, 863
25-62700	18-0860	467, 876	27-854911	18-0942	439	30-88957	18-1155	449, 450, 863
26-90925	18-0864	253	27-85491-2	18-0942	439	30-88957A1	18-1155	450, 863
27-67389	18-0864	818	27-854913	18-0942	439	30-88957T	18-1155	450, 863
27-17145	18-0868	824	27-64204	18-0944	439	31-30894A1	18-1156	450, 862
27-72637	18-0868	824	27-72508	18-0944	439	31-30895	18-1157	450, 862
F1101296	18-0868	824	27-85496	18-0944	439	31-30895T	18-1157	450, 862
F15000232	18-0868	824	27-854961	18-0944	439	31-30956	18-1158	450, 863
F15000263	18-0868	824	27-85653	18-0946	439	31-30956T	18-1158	450, 863
27-27936	18-0870	439	27-85653-1	18-0946	439	31-F523058	18-1158	450, 863
27-279361	18-0870	439	27-856730	18-0946	439	31-35928A1	18-1159	450
27-34486	18-0874	826	27-87707	18-0948	828	31-35928T1	18-1159	450
27-344861	18-0874	826	27-88046	18-0950	830	31-35988A12	18-1160	863
27-344863	18-0874	826	27-88907	18-0952	441	31-35988A2	18-1160	863
27-34891	18-0874	826	27-92720	18-0954	827	31-35990A1	18-1161	862
27-52184	18-0874	826	27-68715	18-0956-1	828	31-38356A1	18-1162	451, 862
F3932344	18-0874	826	27-98769	18-0970	438	31-F84901	18-1162	451, 862
F15000162	18-0874	826	27-987691	18-0970	438	F84903	18-1162	451, 862
27-34898	18-0876	825	27-14250	18-0976	828	F84901	18-1162	451, 862
F15005756	18-0876	825	27-34895	18-0976	828	31-48941A1	18-1163	451, 862
27-37724	18-0879	440	F1101297	18-0976	828	31-61100A1	18-1165	862
27-38501	18-0879	440	110990	18-0980	828	31-78172A1	18-1166	453
27-385011	18-0879	440	110990	18-0980	828	31-812767A1	18-1170	453
27-18272	18-0881-1	800	27-49109	18-0980	828	31-828437A2	18-1173	862
27-97863	18-0881-1	800	27-54529	18-0980	828	31-32575A1	18-1179	862
27-48042	18-0885-1	800	27-48713	18-0982-1	441	31-32575T1	18-1179	862
27-34216	18-0887	828	27-56304	18-0982-1	441	31-54042T	18-1180	862
27-49953	18-0887	828	27-37976	18-0988	441	31-30894A5	18-1182	862
F15000201	18-0887	828	27-62860	18-0988	441	12-88263	18-1186	Obsolete
27-34213	18-0889	825	27-628601	18-0988	441	29-88258	18-1186	Obsolete
27-56883	18-0889	825	27-70143	18-0994	826	30-20839	18-1190	450
F15000074	18-0889	825	27-701431	18-0994	826	30-20839T	18-1190	450
27-34896	18-0891	829	27-70143B1	18-0994	826	30-62699	18-1190	450
27-34897	18-0891	829	27-807982	18-0994	826	F1000034	18-1190	450
F15000077	18-0891	829	27-8079821	18-0994	826	12-12577	18-1191	450
F15000078	18-0891	829	27-807982B	18-0994	826	31-33138A1	18-1193	862
27-35380	18-0893	829	31-62799A1	18-1111	450	879366	18-1194	424
27-55810	18-0894	829	31-12576	18-1112	450	31-17514	18-1194	424
27-558101	18-0894	829	31-12578	18-1113	450	31-17514A1	18-1194	424
27-41813	18-0897	800, 827	31-12578T	18-1113	450	31-17514A2	18-1194	424
27-860233	18-0897	800	31-29982	18-1115	450	31-67526	18-1194	424
27-863724	18-0897	800	31-32898	18-1115	450	31-67526A1	18-1194	424
27-56859	18-0898	830	31-32898T	18-1115	450	31-67526A2	18-1194	424
27-49110	18-0903	829	31-42647	18-1117	450	31-814337A1	18-1194	424
F11010100	18-0903	829	31-42647A1	18-1117	450, 861	31-821146A1	18-1194	424
27-60317	18-0904	440	31-F694057	18-1117	450	31-8M0045428	18-1194	424
27-34502	18-0905	831	31-42677A1	18-1118	450	31-M8004528	18-1194	424
27-49955	18-0905	831	31-35246	18-1120	861	31-43012A1	18-1195	Obsolete
27-60721	18-0905	831	31-73363	18-1122	450	31-74248	18-1196	424
27-8M0077608	18-0905	831	31-73363T	18-1122	450	31-74248T	18-1196	424
27-60945	18-0912	441	31-54036A1	18-1126	451	31-828439A2	18-1197	450, 862
27-66102	18-0912	441	31-8M0103474	18-1126	862	27-96429	18-1204-1	791, 800, 828
27-661021	18-0912	441	31-54038A1	18-1127	862	27-96429	18-1204-1-9	791, 800, 828
27-66847	18-0914	Obsolete	31-86748A1	18-1129	862	27-39923	18-1210-1	800, 827
27-72779	18-0916	829	31-8M0103473	18-1129	862	26-49947	18-1211	818
27-805215	18-0916	829	31-F506818	18-1129	862	26-58203	18-1211	818
27-8052151	18-0916	829	F508814	18-1129	862	26-814622	18-1211	818
27-94915	18-0916	829	74313A4	18-1131	813	F1110026	18-1211	818
27-69524	18-0918	438	15103A3	18-1137	813	F1110027	18-1211	818
27-695241	18-0918	438	31-32573A1	18-1142	861	F1110041	18-1211	818
27-695242	18-0918	438	31-36387A1	18-1143	450, 861	26-56866	18-1230	818
27-70335	18-0922	439	31-48939A2	18-1144	Obsolete	27-818188	18-1231	823
27-703351	18-0922	439	23-853853	18-1148	813	27-8181881	18-1231	823
27-73645	18-0926	439	23-853853002	18-1148	813	27-845628	18-1232	823
27-73814	18-0928-1	827	23-853853A1	18-1148	813	27-811566	18-1232	823

Mercury Marine (Cont.)			Mercury Marine (Cont.)			Mercury Marine (Cont.)		
O.E. #	SIERRA #	PAGE #	O.E. #	SIERRA #	PAGE #	O.E. #	SIERRA #	PAGE #
26-49154	18-1233	818	30-43011T	18-1346	425	835392Q	18-15147	429
26-821947	18-1233	818	31-88269T	18-1347	450	8M0065179	18-15148	429
26-8219471	18-1233	818	31-54928	18-1356	861	57-895120	18-15149	429
FI1100986	18-1233	818	30-20861	18-1398	425	57-895120002	18-15150	429
24-17057A1	18-1234	818	30-72961	18-1398	425	57-13457	18-15290	774
24-801879	18-1234	818	17340	18-1400	Obsolete	57-13457Q	18-15290	774
24-801879T	18-1234	818	17340T	18-1400	809	57-13457T	18-15290	774
24-811554	18-1234	818	56153	18-1401	809	57-53215	18-15290	774
27-13865	18-1237	823	F724102	18-1401	809	57-53215T	18-15290	774
27-138651	18-1237	823	34282	18-1402	809	57-49756	18-15300	774
FI1101281	18-1237	823	35583	18-1402	809	57-77274A1	18-15325	774
27-824326	18-1238	823	46472	18-1402	809	57-74271	18-15345	774
27-810846	18-1239	823	46744	18-1402	809	57-74271Q	18-15345	774
27-810846T	18-1239	823	49117	18-1402	809	57-74271T	18-15345	774
12708	18-1240	829	72638	18-1402	809	57-77274	18-15345	774
23-15960	18-1300	Obsolete	F2769931	18-1402	809	57-65607	18-15370	774
23-52211	18-1300	Obsolete	F5232670	18-1402	809	57-65607Q	18-15370	774
23-818465	18-1300	Obsolete	FI1100349	18-1402	809	57-65607T	18-15370	774
23-85698	18-1300	Obsolete	FI1100399	18-1402	809	57-52692	18-15390	776
F724073	18-1300	Obsolete	FI1100862	18-1402	809	57-32850	18-15400	776
23-85684	18-1305	813	FI1100954	18-1402	809	57-69143Q	18-15400	774
23-15961	18-1308	813	FI1101222	18-1402	809	57-69143T	18-15400	774
23-52221	18-1308	813	25-8071341	18-1508	759	57-76269	18-15405	774
23-52270	18-1308	813	57-862087A1	18-15100	780	57-76269Q	18-15405	774
23-85701	18-1308	813	57-862807	18-15100	780	57-32850	18-15410	774
F3910555	18-1308	813	57-8638763	18-15100	780	57-49043	18-15410	774
F3916351	18-1308	813	57-865615003	18-15100	780	57-49043A1	18-15410	774
FI1100305	18-1308	813	57-865615Q03	18-15100	780	57-64032	18-15410	774
FI1100570	18-1308	813	57-862086	18-15101	780	57-64032A1	18-15410	774
23-1596110	18-1309	813	57-8620861	18-15101	780	57-64032Q1	18-15410	774
23-52224	18-1309	813	57-862086A1	18-15101	780	57-816544	18-15410	774
23-52273	18-1309	813	57-8638764	18-15101	780	57-36356	18-15415	774
23-85704	18-1309	813	57-865615004	18-15101	780	57-49211	18-15430	774
FI1100381	18-1309	813	57-865615Q04	18-15101	780	57-64416	18-15430	774
FI1100573	18-1309	813	57-8610491	18-15102	780	57-49211	18-15435	774
23-801793	18-1311	813	57-8638766	18-15102	780	57-64416	18-15435	774
23-52264	18-1316	Obsolete	57-865615006	18-15102	780	57-45856	18-15440	774
23-818471	18-1316	Obsolete	57-865615Q06	18-15102	780	57-49213A1	18-15440	774
23-818471001	18-1316	Obsolete	57-861050	18-15103	780	57-48120	18-15460	774
23-85718	18-1316	Obsolete	57-8638767	18-15103	780	57-48120A1	18-15460	774
F3829064	18-1316	Obsolete	57-865615007	18-15103	780	57-48120Q1	18-15460	774
FI1100853	18-1316	Obsolete	57-865615Q07	18-15103	780	57-78200	18-15470	774
23-34464	18-1317	813	57-862089	18-15104	780	57-78200A1	18-15470	774
23-52261	18-1317	813	57-862089A1	18-15104	780	57-78200Q1	18-15470	774
23-818469	18-1317	813	57-8638768	18-15104	780	57-48122	18-15480	774
23-818469001	18-1317	813	57-865615008	18-15104	780	57-48122Q	18-15480	774
23-85669	18-1317	813	57-865615Q08	18-15104	780	57-816295Q	18-15490	774
23-85715	18-1317	813	57-862088	18-15105	Obsolete	57-816295T	18-15490	774
23-801803	18-1320	813	57-862088A1	18-15105	Obsolete	57-91035	18-15495	774
23-11992	18-1327	813	57-8638769	18-15105	Obsolete	57-91035A1	18-15495	774
23-11992001	18-1327	813	57-865615009	18-15105	Obsolete	57-91035Q1	18-15495	774
23-48351	18-1329	813	57-865615Q09	18-15105	Obsolete	43-881260A3	18-1550	454
23-52242	18-1329	813	57-8077554	18-15112	780	57-96834Q	18-15500	774
23-85677	18-1329	813	57-807755Q04	18-15112	780	57-96834T	18-15500	774
23-49171	18-1333	813	57-8077555	18-15113	780	43-803615T2	18-1551	454, 454
23-69887	18-1333	813	57-861049	18-15114	780	57-33170	18-15520	774
23-85691	18-1333	813	57-861049Q	18-15114	780	57-33170Q	18-15520	774
23-49168	18-1334	813	57-861757	18-15115	780	57-37619T	18-15520	774
23-69884	18-1334	813	57-861757Q	18-15115	780	57-13458	18-15550	774
23-85726	18-1334	813	57-861758	18-15116	780	57-13458Q	18-15550	774
23-85726001	18-1334	813	57-861758Q	18-15116	780	57-13458T	18-15550	774
FI1100980	18-1334	813	57-861759	18-15117	Obsolete	57-96834	18-15550	774
23-811858	18-1337	813	57-8623523	18-15119	780	43-850036	18-1560	454
23-811858001	18-1337	813	57-8638761	18-15119	780	43-850036T	18-1560	454, 454
23-43293	18-1339	Obsolete	57-865615001	18-15119	780	52-850048T	18-1562	Obsolete
23-43293T	18-1339	Obsolete	57-865615Q01	18-15119	780	53-850048	18-1562	Obsolete
F3750884	18-1339	Obsolete	57-8638765	18-15121	780	43-803615T1	18-1564	454
FI1101007	18-1339	Obsolete	57-865423005	18-15121	780	43-803615T2	18-1564	454, 454
23-67484	18-1340	813	57-865615005	18-15121	780	52-859340T	18-1565	454, 455
23-1596120	18-1341	813	57-865615Q05	18-15121	780	43-828175A1	18-1566	454, 455
23-52225	18-1341	813	57-86387610	18-15122	Obsolete	43567A1	18-1567	Obsolete
23-52274	18-1341	813	57-865615010	18-15122	Obsolete	43567T1	18-1567	Obsolete
23-85705	18-1341	813	57-864639	18-15123	780	96184A1	18-1567	Obsolete
FI1100382	18-1341	813	57-881754	18-15124	Obsolete	65547	18-1705	849
30-41421	18-1345	424	57-817113	18-15125	Obsolete	77123	18-1705	849
30-67923	18-1345	424	57-880566014	18-15128	390	77123A1	18-1705	849
30-67923T	18-1345	424	17-828507 1	18-15129	390	10-86801	18-1706	849
30-43011	18-1346	425	8M0072670	18-15146	429	86814	18-1710	852

Mercury Marine (Cont.)			Mercury Marine (Cont.)			Mercury Marine (Cont.)		
O.E. #	SIERRA #	PAGE #	O.E. #	SIERRA #	PAGE #	O.E. #	SIERRA #	PAGE #
862209	18-1710	852	95864A2	18-1975-1	797	28-69189	18-2052	875
862132	18-1711	848	44354A10	18-1976-2	797	26-70081	18-2053	464, 875
862132T	18-1711	848	44354A13	18-1976-2	797	26-76384	18-2054	875
816607	18-1728	852	44354A3	18-1976-2	797	26-8164641	18-2054	875
43585	18-1730	411	44354A9	18-1976-2	797	26-21642	18-2055	875
45-43031A1	18-1736	454	807914A1	18-1976-2	797	26-79831	18-2055	875
45-440001	18-1737	454	807988A03	18-1976-2	797	26-79831	18-2055	875
12886A6	18-1800	429	807988A2	18-1976-2	797	26-37259	18-2056	875
57-892318	18-18000	390	47441	18-1977-1	759	26-89237	18-2056	875
57-828507Q4	18-18100	390	47441A1	18-1977-1	759	26-96503	18-2056	875
90880	18-1905	797	60427A2	18-1978	759	26-965031	18-2056	875
61851	18-1906	797	53779A2	18-1978	759	26-12224	18-2076	875
93320	18-1908	797	53779A1	18-1978	759	26-F697118	18-2076	876
807476A6	18-1908K	797	76771A2	18-1978	759	26-14077	18-2077	877
93320A13	18-1908K	797	76771A3	18-1978	759	26-F697555	18-2077	878
93320A2	18-1908K	797	93322	18-1985	797	26-36143	18-2094	830
93320A3	18-1908K	797	861006A1	18-1989	666, 759	26-88416	18-2094	830
93320A5	18-1908K	797	8M0061381	18-1989	666, 759	8055361	18-2097	848
93320A6	18-1908K	797	48045	18-1990	798	805536A1	18-2097	848
47587	18-1910	759	54870	18-1990	798	805536A2	18-2097	848
47588	18-1910	759	73813	18-1990	798	30-60794A2	18-2100	848
47587A2	18-1910	759	73813A1	18-1990	798	30-60794A4	18-2100	848
60372A1	18-1910	759	73813F1	18-1990	798	30-879194A02	18-2100	848
60372A2	18-1910	759	59861A1	18-1993	Obsolete	30-60794A2	18-21001	848
63908A2	18-1910	759	59861A4	18-1993	Obsolete	30-60794A4	18-21001	848
861493A07	18-1910	759	78459A1	18-1993	Obsolete	30-879194A02	18-21001	848
861493A3	18-1910	759	78984A08	18-1993	Obsolete	30-562540A3	18-21005	848
98562A6	18-1937	797	78984A1	18-1993	Obsolete	30-862540A04	18-21005	848
77234A2	18-1950-1	794	87290A4	18-1994	759	30-862540T1	18-21005	848
77234A7	18-1950-1	794	47638	18-1995	798	30-879194A01	18-21005	848
77235A2	18-1951-1	794	47638A1	18-1995	798	30-862540A04	18-21005K	848
77235A8	18-1951-1	794	26-30550	18-2002	464	30-862540A3	18-21005K	848
99746A17	18-1952-1	794	26-70019	18-2002	875	30-862540T1	18-21005K	848
99746A8	18-1952-1	794	26-78868	18-2002	464, 875	30-879194A01	18-21005K	848
860246Q11	18-1953-2	794	26-32080	18-2003	872	30-862540A04	18-21006	848
MC 1 95862	18-1954-1	794	26-36054	18-2003	872	30-862540A3	18-21006	848
95862A5	18-1954-1	794	26-823894	18-2003	875	30-862540T1	18-21006	848
52390A1	18-1955-1	795	26-20070	18-2004	464, 875	30-879194A01	18-21006	848
96705A1	18-1955-1	795	26-897154	18-2006	464, 875	30-60794A2	18-2100K	848
806867A 8	18-1956-3	795	26-30727	18-2007	875	30-60794A4	18-2100K	848
860235A04	18-1956-3	795	26-31489	18-2007	875	30-879194A02	18-2100K	848
99798A16	18-1956-3	795	26-94038	18-2007	875	36147	18-2101	848
99798A18	18-1956-3	795	26-56788	18-2008	464, 872	30-36056	18-2101	849
99798A3	18-1956-3	795	26-25776	18-2009	875	30-36418	18-2101	849
99798A9	18-1956-3	795	26-31249	18-2009	875	32-47373	18-2103	865
807078T08	18-1957-2	795	26-46021	18-2009	875	32-66073	18-2103	865
807078Q07	18-1957-2	795	26-892361	18-2009	875	32-68676	18-2103	865
54100A1	18-1958-1	795	26-897153	18-2010	464, 875	32-73004	18-2103	865
54100A5	18-1958-1	795	26-23300	18-2011	875	32-79431	18-2103	865
65604A12	18-1958-1	795	26-29595	18-2011	875	32-86036	18-2103	865
65604A4	18-1958-1	795	26-90562	18-2011	875	32-86036A1	18-2103	865
58759A13	18-1960-1	795	802276	18-2013	875	32-86036Q	18-2103	865
58759A1	18-1960-1	795	26-16977	18-2013	449	36312	18-2104	849
52969A1	18-1960-1	795	26-20465	18-2013	875	41431	18-2104	849
52073A1	18-1960-1	795	26-31507	18-2013	875	58749	18-2104	849
58759A10	18-1960-1	795	26-79884	18-2013	875	75832	18-2104	849
58759A14	18-1960-1	795	26-33144	18-2014	875	758321	18-2104	849
54099A5	18-1962-1	795	26-77634	18-2014	875	75832A1	18-2104	849
54099A1	18-1962-1	795	26-89238	18-2014	875	75832A2	18-2104	849
65603A12	18-1962-1	795	26-F694305	18-2014	875	75832A3	18-2104	849
65603A4	18-1962-1	795	20250	18-2015	875	75832T	18-2104	849
95755A2	18-1970-2	796	26-23517	18-2015	875	75832T1	18-2104	849
98503A2	18-1970-2	796	26-20079	18-2016	875	32-45973	18-2105	866
98504A3	18-1970-2	796	26-25837	18-2016	875	32-45974	18-2106	866
49964A1	18-1971	796	26-29476	18-2016	875	32-55816	18-2107	866
49964A2	18-1971	796	26-41953	18-2016	875	32-59841	18-2108	866
60426A1	18-1971	796	26-32121	18-2017	875	32-59841A1	18-2108	866
76351A04	18-1971	796	26-35025	18-2017	875	32-73123	18-2108	866
76351A1	18-1971	796	26-27163	18-2019	875	32-59842	18-2109	866
76351A2	18-1971	796	802276	18-2026	875	32-73005	18-2109	866
12076A2	18-1972	796	26-16977	18-2026	875	32-45327	18-2110	457
76325A2	18-1972	796	26-20465	18-2026	875	32-88005	18-2110	457
39920	18-1973	796	26-31507	18-2026	875	32-97153A1	18-2110	457
39920A1	18-1973	796	26-79884	18-2026	875	32-45969	18-2111	457
55538A2	18-1973	796	26-24590	18-2048	875	32-88006	18-2111	457
98502A2	18-1974-1	797	26-32511	18-2049	875	32-97154A1	18-2111	457
12076A1	18-1975-1	797	26-55682	18-2050	875	32-87234	18-2112	866
12076A2	18-1975-1	797	26-69188	18-2051	875	32-87235	18-2113	866

Mercury Marine (Cont.)			Mercury Marine (Cont.)			Mercury Marine (Cont.)		
O.E. #	SIERRA #	PAGE #	O.E. #	SIERRA #	PAGE #	O.E. #	SIERRA #	PAGE #
32-864960	18-2114	866	19543A2	18-2159	853	73020A14	18-2191	860
32-99902-1	18-2114	866	19543A4	18-2159	853	33149	18-2193	831
32-864959	18-2115	866	19543A8	18-2159	853	99297A1	18-2193	831
32-99903-1	18-2115	866	41951A1	18-2159	853	99297A2	18-2193	831
32-99904	18-2116	867	66065A1	18-2159	853	12632A3	18-2195	855
32-99904Q	18-2116	867	66069A2	18-2159	853	12632A7	18-2195	855
39384	18-2125	848	73679A2	18-2159	853	37967	18-2196	860
46020	18-2125	848	865436A02	18-2159	853	61073	18-2196	860
460201	18-2125	848	32-38377	18-2160	853	19755A08	18-2196	860
4602002	18-2125	848	45518A1	18-2161	850	19755A4	18-2196	860
46020002	18-2125	848	45518A2	18-2161	850	43-61027	18-2200	858
46020T	18-2125	848	45518A3	18-2161	850	43-96084A4	18-2200	858
32-48418	18-2126	867	33981	18-2162	850	43-18410A2	18-2201	847
32-52951A1	18-2126	867	8507521	18-2162	850	43-18411A2	18-2201	847
39383	18-2128	848	8507522	18-2162	850	43-59832A2	18-2201	847
393831	18-2128	848	33981T	18-2162	850	43-59832A4	18-2201	847
39383T	18-2128	848	33981T1	18-2162	850	52-66063	18-2202	860
66062	18-2130	861	33981	18-2162E	Obsolete	52-824112	18-2202	860
76665	18-2130	861	8507521	18-2162E	Obsolete	52-85359A	18-2202	859
8M2009865	18-2130	861	8507522	18-2162E	Obsolete	52-85359AT	18-2202	859
32-864589	18-2136	866	33981T1	18-2162E	Obsolete	43-45814A5	18-2203	847
32-99902	18-2136	866	10-31700	18-2163	851	43-55765A2	18-2203	847
32-864588	18-2137	866	10-31700	18-2163E-9	851	43-55765A3	18-2203	847
32-99903	18-2137	866	44-55857	18-2166	859	43-75325A2	18-2204	847
10-97934A1	18-2141	831	44-66060	18-2166	859	43-75325A3	18-2204	847
45706A1	18-2142	868	44-660602	18-2166	859	43-55766A2	18-2205	847
45706A12	18-2142	868	44-660603	18-2166	859	43-55766A3	18-2205	847
45706A14	18-2142	868	44-824110	18-2166	859	43-55778A3	18-2205	847
45706A3	18-2142	868	45589A1	18-2169	850	43-828072A2	18-2206-1	858
45706A6	18-2142	868	45589A3	18-2169	850	43-828073A1	18-2206-1	858
45706A8	18-2142	868	10-45590	18-2170	850	43-878087A2	18-2206-1	858
67210	18-2143	Obsolete	10-8M0084649	18-2170	850	52-12777	18-2236	454
78249	18-2143	Obsolete	32492A2	18-2171	855	52-34239	18-2236	454
67209	18-2144	429	32492A3	18-2171	855	52-814756	18-2236	454
77326	18-2144	429	32492A5	18-2171	855	52-822539	18-2236	454
78687	18-2144	429	38965A1	18-2171	855	52-822539T	18-2236	454
78687T	18-2144	429	38965A2	18-2171	855	44-94148	18-2239	454
19297A3	18-2145	853	76850A2	18-2171	855	10-20259	18-2244	453, 864
43432A2	18-2145	853	14505A2	18-2172	855	10-28634	18-2244	453, 864
815471A3	18-2145	853	59826A1	18-2173	855	10-28634A1	18-2244	453, 864
815471A6	18-2145	853	59826A3	18-2173	855	10-79953	18-2244	453, 865
85147A5	18-2145	853	36312	18-2174	849	10-79953A2	18-2244	453, 866
865437A02	18-2145	853	41431	18-2174	849	10-79953Q04	18-2244	453, 867
815471	18-2145E	854	58749	18-2174	849	10-79953Q2	18-2244	453
815471A3	18-2145E	854	75832	18-2174	849	10-F50109	18-2244	453, 864
815471A6	18-2145E	853	758321	18-2174	849	816610A1	18-2244	453, 864
20175	18-2146	848	75832A1	18-2174	849	816610A2	18-2244	453, 864
59830A1	18-2146	848	75832A2	18-2174	849	F40109	18-2244	453, 864
59830A7	18-2146	848	75832A3	18-2174	849	35187A1	18-2248	853
45523	18-2148	868	75832T	18-2174	849	35187A2	18-2248	853
77443	18-2148	868	75832T1	18-2174	849	35187A4	18-2248	853
45706A4	18-2148	868	12632A4	18-2175	855	49518A1	18-2248	853
77442A1	18-2148	868	45-55796	18-2179	Obsolete	73723A01	18-2248	853
22879	18-2149	854	45-42634	18-2180	839, 860	73723A1	18-2248	853, 854
29880	18-2149	854	32992A1	18-2189	853	44-850308	18-2254	454, 859
43433	18-2149	854	34086A1	18-2189	853	43-803116T1	18-2256	835, 847
37973	18-2150	861	37611A1	18-2189	853	43-803112T1	18-2257	835, 848
85028	18-2150	861	38399A2	18-2189	853	43-803114T1	18-2258	835, 848
66066	18-2150	861	19543A10	18-2190	853	43-803101T1	18-2259	835, 848
77481	18-2150	861	19543A2	18-2190	853	44-17915	18-2260	454
774811	18-2150	861	19543A4	18-2190	853	44-98418	18-2260	454
17-45738	18-2151	8870	19543A8	18-2190	853	45-816919	18-2261	843, 860
17-45735	18-2152	870	41951A1	18-2190	853	15-32563A1	18-2282	844
23-30617A1	18-2154	861	66065A1	18-2190	853	15-45691A1	18-2283	844
23-30617A2	18-2154	861	66069A2	18-2190	853	15-31535A1	18-2284	Obsolete
23-37428A1	18-2155	453	73679A2	18-2190	853	15-35931A1	18-2285	844
23-55419A1	18-2155	453	865436A02	18-2190	853	15-47397A1	18-2285	
23-77631A2	18-2155	453	19543A10	18-2190E	853	66067	18-2286	8860
19543A10	18-2157	853	19543A2	18-2190E	853	19755A2	18-2286	860
19543A2	18-2157	853	19543A2	18-2190E	853	66067T	18-2286	860
19543A4	18-2157	853	19543A8	18-2190E	853	818349A1	18-2286	860
19543A8	18-2157	853	41951A1	18-2190E	853	818349T1	18-2286	860
41951A1	18-2157	853	66065A1	18-2190E	853	25-60342A1	18-2291	869
66065A1	18-2157	853	66069A2	18-2190E	853	25-60342A2	18-2291	869
66069A2	18-2157	853	73679A2	18-2190E	853	15-35980A1	18-2292	844
73679A2	18-2157	853	865436A02	18-2190E	853	15-23097A1	18-2293	844
865436A02	18-2157	853	56211A1	18-2191	860	15-36178A02	18-2293	844
19543A10	18-2159	853	73020A1	18-2191	860	15-36178A1	18-2293	844

Mercury Marine (Cont.)			Mercury Marine (Cont.)			Mercury Marine (Cont.)		
O.E. #	SIERRA #	PAGE #	O.E. #	SIERRA #	PAGE #	O.E. #	SIERRA #	PAGE #
15-39899A1	18-2293	844	22-67892	18-2375	453, 864	98703A12	18-2424	869
15-42637A1	18-2294	844	22-67892A05	18-2375	453, 864	98703A17	18-2424	869
15-8M0063267	18-2294	844	22-67892A06	18-2375	453, 864	98703A26	18-2424	869
15-33143A1	18-2295	844	22-67892A1	18-2375	453, 864	8M0708280	18-2425	869
15-57007A1	18-2295	844	28-8M0058389	18-2375	453	98704A11	18-2425	869
15-45811	18-2296	844	10-14834A1	18-23751-9	453, 864	98704A12	18-2425	869
15-71013	18-2296	844	22-67892A1	18-23751-9	453, 864	98704A17	18-2425	869
14-17460	18-2298	456, 861	73020A20	18-2376	861	98704A26	18-2425	869
14-18323	18-2298	456, 861	818763A10	18-2376	861	98703A3	18-2426	869
14-52833	18-2299	456, 861	818763A4	18-2376	861	98704A3	18-2427	869
14-79447	18-2299	456, 861	94998A1	18-2381	850	87399A1	18-2428	869
10-20518	18-2303	854	94998A2	18-2381	835, 850	87399A2	18-2428	869
12-77674	18-2316	833	94998A3	18-2381	850	87399A3	18-2429	869
815919A1	18-2320	861	94998A4	18-2381	850	26-830749	18-2430	443, 461
12632A6	18-2321	855	18312A3	18-2382	850	26-830749	18-24301-9	443, 461
62104	18-2322	850	828692A1	18-2382	837, 850	814309A1	18-2434	576, 717
621041	18-2322	850	17-14872	18-2393	870	32-861127	18-2435	866
18643A5	18-2323	855	17-14873	18-2394	870	32-95858	18-2435	866
45-557961	18-2324	850	17-815953	18-2395	870	32-861128	18-2436	867
45-853647	18-2331	860	17-815953A1	18-2395	870	32-95859	18-2436	867
45-853648	18-2331	860	17-44166	18-2396	870	1623-4110A13	18-2443	845
23-47392	18-2336	871	17-44167	18-2397	870	1623-4110A4	18-2443	845
23-61291	18-2336	871	17-44167A1	18-2397	870	1623-4110A6	18-2443	845
23-90203	18-2336	871	1623-81582243	18-2400	844	1623-5356A18	18-2443	845
12-31266	18-2340	831	1623-815822A32	18-2400	844	1623-5356A19	18-2443	845
23-815950	18-2341-1	871	1623-815822A5	18-2400	844	1623-5356A20	18-2443	845
23-8159501	18-2341-1	871	1623-815822A53	18-2400	844	1623-5356A3	18-2443	845
23-815950Q01	18-2341-1	871	1623-8951A15	18-2401	845	1623-8951A14	18-2443	845
68100	18-2342	860	1623-8951A27	18-2401	845	1623-8951A19	18-2443	845
681001	18-2342	860	1623-8951A37	18-2401	845	1623-8951A2	18-2443	845
12-92721	18-2343	933	1623-8951A5	18-2401	845	1623-8951A23	18-2443	845
53-815949	18-2345	871	1623-5356A4	18-2402	845	1623-8951A43	18-2443	845
824519	18-2346	860	43-803079T1	18-2404	859	1547-3917A13	18-2450	845
88245191	18-2346	860	43-803091T1	18-2405	859	1547-3917A21	18-2450	845
11-42633	18-2346	860	43-878072A3	18-2406	858	1547-3917A32	18-2450	845
F694961	18-2346	860	43-878087A2	18-2406	858	1547-3917A37	18-2450	845
F694961-1	18-2346	860	43-17064A3	18-2407	839	1547-5523A12	18-2450	845
24-30893	18-2348	859	43-42933A2	18-2407	859	1547-5523A2	18-2450	845
23-67370	18-2349	864	43-42933A3	18-2407	859	1547-5523A68	18-2450	845
23-815921A10	18-2353	861	43-823072A2	18-2407	859	1547-5523A9	18-2450	845
23-815921A17	18-2353	861	43-878087A4	18-2407	859	1547-8265A15	18-2450	845
23-815921A21	18-2353	843, 861	43-828073A1	18-2408	858	1547-9412A20	18-2450	845
23-815921A6	18-2353	861	43-92320	18-2409	858	1547-9412A30	18-2450	845
23-815921A8	18-2353	861	43-92320T	18-2409	858	1547-9412A35	18-2450	845
815921A2	18-2353	861	43-96084A5	18-2410	858	1547-3917A16	18-2451	845
807929A1	18-2354	861	43-96084A7	18-2410	858	1547-3917A30	18-2451	845
807929A2	18-2354	861	1547-861063A4	18-2411	844	1547-3917A38	18-2451	845
815922A1	18-2354	861	18309A2	18-2412-1	855	1547-3917A4	18-2451	845
815922A5	18-2354	861	18311A17	18-2412-1	855	1547-3917A8	18-2451	845
821759A1	18-2354	861	18311A2	18-2412-1	855	1547-5523A11	18-2451	845
821759A2	18-2354	843, 861	812964A2	18-2412-1	855	1547-5523A8	18-2451	845
821759A3	18-2354	861	861523A9	18-2412-1	855	1547-8265A16	18-2451	845
821759A4	18-2354	861	8M0098795	18-2412-1	855	1547-9412A21	18-2451	845
17-30632	18-2357	859	69354A1	18-2413	855	1547-5523A67	18-2452	845
17-8M0020941	18-2357	859	69354A2	18-2413	855	1547-8265A17	18-2452	845
17-8M0084681	18-2357	859	97432A2	18-2414	855	1547-9412A22	18-2452	845
17-8M0100263	18-2357	859	1623-815822A36	18-2415	845	1547-9412A36	18-2452	845
43-803102T1	18-2358	846	1547-815930A16	18-2416	845	1547-5523A49	18-2453	845
	18-2359	454, 860	1547-815930A6	18-2416	845	1547-5523A67	18-2453	845
43-828072A3	18-2360	858	1547-861063A12	18-2416	845	1547-8265A17	18-2453	845
43-878087A2	18-2360	858	1547-815930A13	18-2419	845	1547-9412A23	18-2453	845
10-30206	18-2361	831	1547-815930A3	18-2419	845	17-44166T1	18-2461	868
10-805763	18-2361	831	1547-861063A6	18-2419	845	17-14873A1	18-2462	868
10-853163	18-2361	831	14034A3	18-2420	Obsolete	17-85056	18-2462	868
43-803118T1	18-2363	846	14034A5	18-2420	Obsolete	17-14872A1	18-2463	868
43-803119T1	18-2364	846	14034F1	18-2420	Obsolete	17-99207	18-2463	868
43-803120T1	18-2365	846	14034T	18-2420	Obsolete	17-815953T1	18-2464	868
43-803071T1	18-2368	846	14034T10	18-2420	Obsolete	56-18541A75	18-2464	868
43-803069T1	18-2369	846	14035A3	18-2421	Obsolete	56-864641A24	18-2464	868
19291A3	18-2370	254, 451	14035A5	18-2421	Obsolete	19-14842	18-2465-9	868
88035	18-2372	868	14035F1	18-2421	Obsolete	19-148421	18-2465-9	868
14698	18-2373	Obsolete	14035T	18-2421	Obsolete	19-815951	18-2466-9	868
14698T	18-2373	Obsolete	14035T10	18-2421	Obsolete	27-52893	18-2500	439
14698T10	18-2373	Obsolete	815935A3	18-2422	Obsolete	27-72505	18-2500	439
806191T	18-2373	Obsolete	815935A7	18-2422	Obsolete	27-85493	18-2500	432, 439
8M0110717	18-2373	Obsolete	815954A3	18-2423	Obsolete	27-14765	18-25001	828
10-14834	18-2375	453, 864	815954A7	18-2423	Obsolete	F3860315	18-25001	828
10-14834A1	18-2375	453, 864	98703A11	18-2424	869	F11110294	18-25001	828

Mercury Marine (Cont.)			Mercury Marine (Cont.)			Mercury Marine (Cont.)		
O.E. #	SIERRA #	PAGE #	O.E. #	SIERRA #	PAGE #	O.E. #	SIERRA #	PAGE #
F1110958	18-25001	828	27-60475	18-2573	439	26-33144A2	18-2652	873
27-811588	18-25002	828	27-72142	18-2573	439	26-89238A1	18-2652	873
27-67738	18-2501	438	27-721421	18-2573	439	26-55682A1	18-2653	461
27-93536	18-2501	438	27-60476	18-2574	439	26-79831A1	18-2654	461
27-935361	18-2501	438	27-72507	18-2574	439	26-89238A2	18-2655	461
27-87396	18-2502	439	27-85495	18-2574	439	26-41365A3	18-2697-1	462
27-90484	18-2502	439	27-854951	18-2574	439	896173A01	18-2700	Obsolete
27-904841	18-2502	439	27-854952	18-2574	439	8M0045604	18-2700	Obsolete
27-78068	18-2503	441	1399-99	18-2575	438	23-45736	18-2701	871
27-99177	18-2503	441	99356A2	18-2587	576	23-61290	18-2701	871
27-991771	18-2503	441	27-194541	18-2593	442	23-89574	18-2701	871
27-991772	18-2503	441	26-816575A2	18-2599	459, 850	23-45736	18-2701-04	871
27-60310	18-2504	439	30-803097T1	18-2601-1	851	23-61290	18-2701-04	871
27-74511	18-2504	439	19543T1	18-2603	854	23-89574	18-2701-04	871
27-76401	18-2504	439	19543T2	18-2603	854	23-99291	18-2702-04	871
27-88449	18-2504	439	865436A03	18-2603	854	23-99291T	18-2702-04	871
27-96171	18-2505	439	19543T1	18-2603E	854	23-99291	18-2702-1	871
27-961711	18-2505	439	19543T2	18-2603E	854	23-99291T	18-2702-1	871
27-99176	18-2506-1	441	865436A03	18-2603E	854	973513	18-2707	Obsolete
27-991762	18-2506-1	441	815471T1	18-2604	854	27-41417	18-2710	438
27-991763	18-2506-1	441	815471T1	18-2604E	854	27-414171	18-2710	438
27-991764	18-2506-1	441	27-812755	18-2610	440	27-414172	18-2710	438
27-37816	18-2507	439	27-812775A	18-2610	440	27-85978	18-2710	438
27-72487	18-2507	439	27-8127551	18-2611	440	27-41418	18-2712	438
27-78026	18-2507	439	27-812755A01	18-2611	440	27-414181	18-2712	438
27-85487	18-2507	433, 439	27-8127755	18-2611	440	27-85979	18-2712	438
27-96440	18-2508-1	441	27-64818	18-2614		27-43337	18-2713	440
27-99776	18-2508-1	441	27-45821	18-2614	832	27-433371	18-2713	440
27-997761	18-2508-1	441	27-64818A1	18-2614	832	27-433372	18-2713	440
27-67751	18-2509	437	27-64818A20	18-2614	832	27-433373	18-2713	Obsolete
27-96781	18-2510	438	27-64818A4	18-2614	832	27-433374	18-2713	440
27-967811	18-2510	438	27-64818Q4	18-2614	832	27-43337A1	18-2713	440
27-99173-2	18-2511	441	27-64818T1	18-2614	832	27-96286	18-2713	440
27-60286	18-2512	434	16755	18-2615	832	27-414992	18-2714	440
27-11338	18-2513	438	16755A1	18-2615	832	27-414993	18-2714	440
27-67208	18-2513	438	16755Q1	18-2615	832	27-414994	18-2714	440
27-53650	18-2514	438	16755T1	18-2615	832	27-414995	18-2714	440
16755	18-2516	829	27-35996	18-2617	832	27-892157	18-2714	440
16755A1	18-2516	829	27-35996A1	18-2617	832	24-17997A1	18-2715	851
16755Q1	18-2516	829	27-64818A2	18-2619-1	832	27-41499	18-2716	440
27-331791	18-2552	826	27-64818A3	18-2619-1	832	27-414991	18-2716	440
27-331792	18-2552	826	27-64818A3	18-2619-1	832	27-92332	18-2716	440
27-47510	18-2553	826	27-94996	18-2619-1	832	27-41475	18-2717	440
27-47510Q	18-2553	826	27-94996A1	18-2619-1	832	27-414751	18-2717	440
27-41812	18-2554	826	27-94996A2	18-2619-1	832	27-414752	18-2717	440
27-41812Q	18-2554	826	27-94996A20	18-2619-1	832	27-414753	18-2717	440
27-90556	18-2554	826	27-94996Q2	18-2619-1	832	27-414754	18-2717	440
27-89656	18-2555	826	27-94996T2	18-2619-1	832	27-414755	18-2717	440
27-896561	18-2555	826	27-54014	18-2620	832	27-414756	18-2717	440
27-35996	18-2556	832	27-54014A1	18-2620	832	27-414757	18-2717	440
27-35996A1	18-2556	832	27-54014Q1	18-2620	832	27-414758	18-2717	440
27-19204-2	18-2558	441	27-54014T1	18-2620	832	27-892158	18-2717	440
27-19202	18-2559	441	27-139581	18-2621	438	27-92331	18-2717	440
27-42206	18-2559	441	23-79373A1	18-2622	850	27-82728A	18-2721	440
12-86645	18-2560	443	23-805041A2	18-2622	850	43713	18-2724	851
12-866451	18-2560	443	27-45588	18-2622	850	26-830749A01	18-2725	462
8M0027721	18-2560	443	27-79373	18-2622	850	60930	18-2727	759
27-85087	18-2561	441	26-85090A2	18-2624	254	26-42102	18-2728	443
27-99326	18-2562	442	26-43034A1	18-2626	459	26-421021	18-2728	443
27-993261	18-2562	442	26-43034A2	18-2626	459	27-8128672	18-2729	438
27-43034	18-2563	442	26-43034A3	18-2626	459	26-80239M	18-2730-9	Obsolete
27-430341	18-2563	442	26-43035A4	18-2626	459	26-81607M	18-2731	443
27-43033	18-2564	S/S to 18-2564-1	26-66303A1	18-2627	459	807166A3	18-2732	753
27-430331	18-2564-1	442	26-77066A1	18-2628	460	92802	18-2733	753
27-43047	18-2565	S/S to 18-2564-1	26-85090A1	18-2629	460	99370A2	18-2733	753
27-430471	18-2565	442, 829	26-814669A2	18-2635	460	27-190506	18-2735	430, 440
27-430472	18-2565	442	26-816575A5	18-2642	460	27-863891	18-2736	435
27-817277	18-2566	442	26-16709A1	18-2643	872	27-863893	18-2736	435
27-8172771	18-2566	442	26-16709A2	18-2643	872	27-863895	18-2736	435
27-25848	18-2568	437	26-88397A1	18-2644	872	27-850283	18-2737	438
27-25849	18-2569	438	26-76868A04	18-2645	873	27-832933006	18-2739	440
27-25851	18-2570	438	26-76868A1	18-2645	873	27-8329331	18-2739	440
27-34614	18-2570	438	26-76868A2	18-2645	873	27-8329332	18-2739	440
27-31402	18-2571	433, 437	26-816575A1	18-2646-1	461	27-8329333	18-2739	440
27-22023	18-2572	437	26-816575A3	18-2646-1	461	27-8329334	18-2739	440
27-63309	18-2572	437	26-32511A1	18-2648	873	27-8329335	18-2739	440
			25-87400A2	18-2649	869	27-430051	18-2740	439
			26-33144A1	18-2652	873	27-430052	18-2740	439

Mercury Marine (Cont.)			Mercury Marine (Cont.)			Mercury Marine (Cont.)		
O.E. #	SIERRA #	PAGE #	O.E. #	SIERRA #	PAGE #	O.E. #	SIERRA #	PAGE #
27-430053	18-2740	439	27-96485	18-2809	434, 441	18-524571	18-2848	826
27-430055	18-2740	439	27-43777	18-2810	440	27-524572	18-2848	826
27-430056	18-2740	439	27-437771	18-2810	440	27-818832	18-2849-1	827
27-430057	18-2740	439	27-437772	18-2810	440	27-871051	18-2849-1	827
27-43004009	18-2741	440	27-96483	18-2810	440	27-32816	18-2896-1	800, 828
27-430041	18-2741	440	27-814703	18-2815	829	27-52546	18-2896-1	800, 801, 828
27-430042	18-2741	440	FI5000119	18-2815	999	27-99757	18-2909	828
27-430043	18-2741	440	FI5000199	18-2815	928	27-53354	18-2912-1	800, 828
27-430045	18-2741	440	27-39915	18-2819-1	800	27-30603	18-2914	443, 830
27-430047	18-2741	440	27-45821	18-2820	892	27-32433	18-2914	443, 830
85552	18-2742	459	27-64818	18-2820	892	27-85608	18-2914	443, 830
27-64818A2	18-2743	829	27-64818A1	18-2820	892	27-856081	18-2914	443, 830
27-94996	18-2743	8829	27-64818A20	18-2820	892	27-8M0090319	18-2914	443, 830
27-949962	18-2743	829	27-64818A4	18-2820	892	27-30604	18-2915	443, 830
27-94996A1	18-2743	829	27-64818Q4	18-2820	832	27-32434	18-2915	443, 830
27-94996A2	18-2743	829	27-19553	18-2823	449, 830	27-85609	18-2915	443, 830
27-94996A20	18-2743	829	27-32769	18-2823	449, 830	27-856091	18-2915	443, 830
27-94996A3	18-2743	829	27-19551	18-2824	449, 830	27-858524	18-2915	443, 830
27-94996Q2	18-2743	829	27-32770	18-2824	449, 830	27-858524	18-2915	443, 830
31-14358001	18-2746	852	27-32771	18-2825	449, 830	27-33179	18-2917	826
32-14358	18-2746	852	27-85610	18-2826	449, 830	27-53045	18-2917	826
32-14358T	18-2746	852	27-856101	18-2826	449, 830	27-530451	18-2917	826
816431A1	18-2747	851, 852	27-856704	18-2826	449, 830	F10077105	18-2917	826
31-44348001	18-2748	852	27-39623	18-2827	449	FI1101276	18-2917	826
32-44348	18-2748	852	27-39625	18-2828	449	FI1101291	18-2917	826
32-44348T	18-2748	791, 852	879036	18-2830-1	827	FI5000096	18-2917	826
27-812867	18-2749	439	27-33121	18-2830-1	827	27-42631	18-2919	443, 830
27-8128671	18-2749	439	27-46401	18-2830-1	827	27-426311	18-2919	443, 830
32734	18-2750	852	27-52584	18-2830-1	827	27-443281	18-2943	439
18654A1	18-2750	852	27-47590	18-2831	827	27-443282	18-2943	439
32734A3	18-2750	852	27-475901	18-2831	827	27-443283	18-2943	439
60932A1	18-2751	852	27-48043	18-2832-1	820, 827	27-443284	18-2943	439
60932A4	18-2751	852	27-480431	18-2832-1	800, 827	26-45577	18-2944	830
36223	18-2752	852	27-48043	18-2832-1-9	820, 827	26-455771	18-2944	830
36223A1	18-2752	852	27-480431	18-2832-1-9	800, 827	12-19183	18-2945	443, 830
36223A2	18-2752	852	27-52076	18-2833	827	12-191832	18-2945	443, 830
31659	18-2753-2	852	27-99777	18-2833	827	12-191833	18-2945	443, 830
74639	18-2753-2	852	27-997771	18-2833	827	12-20260	18-2945	443, 830
74639A2	18-2753-2	852	27-997772	18-2833	800, 827	F50556	18-2945	443, 830
86840A05	18-2756	8852	27-60208	18-2834	826	F8077	18-2945	443, 830
86840A3	18-2756	852	27-60479	18-2835	441	F8186	18-2945	443, 830
8M0062406	18-2756	852	27-64173	18-2835	441	27-52364	18-2946	825
53114	18-2759	852	27-66101	18-2835	441	27-81084	18-2946	825
53114A1	18-2759	852	27-69238	18-2835	432, 441	FI5000204	18-2946	825
78458	18-2760	852	27-692381	18-2835	441	12-23245	18-2948	443, 830
78458A1	18-2760	852	27-31439	18-2836	439	12-49221	18-2948	443, 830
32-90949	18-2761	852	27-46233	18-2836	439	12-492211	18-2948	443, 445, 830
32-90949T	18-2761	852	27-72919	18-2836	439	27-33395	18-2949	800, 828
70981	18-2762	852	27-78035	18-2836	439	47-89983	18-3007	409, 752
70981A3	18-2762	852	27-31436	18-2837	440	47-89983T	18-3007	409
32-807458T	18-2770	852	27-41382	18-2837	440	47-20813	18-3008	410
27-41899M	18-2785	462	27-66358	18-2837	440	47-25287	18-3008	410
27-92648M	18-2787	462	27-72918	18-2837	440	47-22748	18-3012	410
27-26891	18-2800	437	27-78087	18-2837	440	26-821309	18-3013	411
27-69659	18-2800	437	27-55279	18-2838	439	26-821310	18-3014	411
27-75791	18-2800	437	27-552791	18-2838	439	47-862232A2	18-3016-1	752
27-757911	18-2800	437	27-60477	18-2839	439	8M0104229	18-3016-1	752
27-32438	18-2801	442	27-72509	18-2839	439	47-30221	18-3017	410, 752
27-48164	18-2802	437	27-85497	18-2839	439	47-65960	18-3017	410, 752
27-481641	18-2802	437	27-854971	18-2839	439	47-85460	18-3017	410, 752
27-90430	18-2803	437	27-854972	18-2839	439	47-89984	18-3017	410, 752
27-904301	18-2803	437	27-35982	18-2840	829	47-899842	18-3017	410, 752
27-73377	18-2804	437	27-19552	18-2841	442	47-899844	18-3017	410, 752
27-733771	18-2804	437	27-77417	18-2841	4442	47-89984T3	18-3017	410, 752
27-85490-2	18-2805	433, 439	27-74830	18-2843	826	47-89984T4	18-3017	410, 752
27-65788	18-2806	439	27-48818	18-2844	826	47-39074	18-3039	410
27-53863	18-2807	439	27-488181	18-2844	826	47-65957	18-3039	410
27-64940	18-2807	439	27-48818Q1	18-2844	826	47-89981	18-3039	410
27-72506	18-2807	439	27-11999	18-2845	828	47-56780	18-3052	410
27-85494	18-2807	439	27-34043	18-2845	828	47-65958	18-3052	410
27-98185	18-2807	433, 439	27-52202	18-2845	828	47-89982	18-3052	410
27-981851	18-2807	439	FI1101236	18-2845	828	47-68988	18-3054	410
27-9818512	18-2807	439	FI5000161	18-2845	828	47-89980	18-3054	4410
27-981853	18-2807	439	27-54014	18-2847	829	47-430261	18-3056	410
27-96278	18-2808	439	27-54014A1	18-2847	829	47-430262	18-3056	410
27-43779	18-2809	434, 441	27-54014Q1	18-2847	829	47-430264	18-3056	410
27-437791	18-2809	434, 441	27-54014T1	18-2847	829	47-43026T2	18-3056	410
27-437792	18-2809	434, 441	18-52457	18-2848	826	47-85089-3	18-3057	410

Mercury Marine (Cont.)			Mercury Marine (Cont.)			Mercury Marine (Cont.)		
O.E. #	SIERRA #	PAGE #	O.E. #	SIERRA #	PAGE #	O.E. #	SIERRA #	PAGE #
47-420381	18-3062	410	47-85089T7	18-3215	412	46-44292A4	18-3517	414
47-420382	18-3062	410	47-59362A4	18-3216	754	46-48747A3	18-3517	414
47-42038Q02	18-3062	410	32489	18-3219	850	46-57234A3	18-3517	414
47-81242M	18-3063	410	32489A2	18-3219	850	46-58618A4	18-3517	414
47-95611M	18-3063	410	42724A3	18-3219	850	46-60367A4	18-3517	414
47-11590M	18-3066	410	32-54236	18-3220	753	46-64141A11	18-3517	414
47-81604M	18-3067	410	32-81438A	18-3221	753	46-69222A3	18-3517	414
47-84797M	18-3067	410	32-860220	18-3221	753	46-73802A3	18-3517	414
47-81423M	18-3069	513	23-816583	18-3222	753	46-73804A3	18-3517	414
47-82824M	18-3069	410	10-30720	18-3226	753	46-78400A2	18-3517	414
47-97108M	18-3069	410	17-35973	18-3227-9	411, 753	46-96148A5	18-3517	414, 755
47-80395M	18-3072	410	10-28668	18-3229	753	46-96148A8	18-3517	414, 755
47-96305M	18-3073	410	10-816601	18-3230	831	860256A2	18-3530-1	Obsolete
47-84027M	18-3074	410	10-98794	18-3231	835	860256A4	18-3530-1	Obsolete
47-84027T	18-3074	410	19-47579	18-3232	871	807074A1	18-3531	759
47-96619M	18-3074	410	19-475791	18-3232	871	808064A1	18-3531	759
47-59362	18-3087	752	23-32632	18-3236	871	861188A1	18-3531	759
47-59362T	18-3087	752	47-89982T1	18-3252	413	885599004	18-3535	408
47-16154	18-3098	410	47-43026Q06	18-3265	413	833072003	18-3536	408
47-161543	18-3098	410	47-43026T11	18-3265	413	833072002	18-3537	408
32768	18-3107	411	47-8M0100526	18-3265	413	833072004	18-3537	408
54705	18-3107	411	26-864319	18-3289	830	861156A1	18-35433	743
23-29804	18-3109	411, 752	28-43037	18-3293	411, 753	14586	18-3549	408
23-29804T	18-3109	411, 752	28-81603M	18-3294	Obsolete	59078	18-3550	758
23-52928	18-3109	411, 752	28-83444M	18-3300	411	59078A1	18-3550	758
26-29677	18-3110	411, 752	28-81912M	18-3305	411	32728	18-3551	758
26-36557A1	18-3110	411, 752	28-83701M	18-3305	411	35884	18-3551	758
26-38970	18-3110	411, 752	46-32437A3	18-3316	414	59137	18-3551	758
70977	18-3113	411	46-78400A2	18-3316	414	8072521	18-3551	758
48752	18-3114	411, 752	46-96148A8	18-3316	414	8072531	18-3551	758
48752T	18-3114	411, 752		18-3317	755	59137A1	18-3551	758
48753	18-3115	411	47-59362Q08	18-3318	754	807252T1	18-3551	758
46-48743A1	18-3116	411, 752	46-42579A4	18-3319	414	8M0089715	18-3551	758
46-64141A1	18-3116	411, 752	46-77516A3	18-3322	414	76270	18-3552	758
46-96148	18-3116	411, 752	46-73640A2	18-3323	415	76270T	18-3552	758
46-96148A1	18-3116	411, 752	46-77177A3	18-3324	415	62981	18-3553	409
46-96148T1	18-3116	411, 752	72778	18-3350	753	66850	18-3553	409
30605	18-3117	411, 752	94576	18-3350	753	75692	18-3553	409
32435	18-3117	411, 752	72777	18-3351	753	99155A1	18-3555	758
324351	18-3117	411, 752	94916	18-3351	753	99155T2	18-3555	758
46-48746A1	18-3118	411	817275A08	18-3406	413	895338	18-3556	409
46-48746A3	18-3118	411	817275A09	18-3407	413	47594	18-3557	758
46-77822A1	18-3118	411	46-73804A1	18-3414	412	99155T1	18-3568	758
817276	18-3122	411, 752	46-96146A5	18-3414	412, 414	803061T1	18-3569	408
8172761	18-3122	411, 752	46-73802A2	18-3416	412	817275A1	18-3571	415
8172763	18-3122	411, 752	46-78400A1	18-3416	412	46-43024A3	18-3572	415
46895	18-3139	411	46-96146A2	18-3416	412	817275A2	18-3572	415
817275K05	18-3147	754	46-96146A6	18-3416	412	883514	18-3573	752
817275T4	18-3147	754	46-57234A1	18-3417	753	883925	18-3573	752
46-84277M	18-3148	415	46-42579A3	18-3419	412	17670	18-3577-2	752
46-84277T	18-3148	415	46-44292A3	18-3420	753	49139	18-3577-2	752
46-42040A1	18-3149-2	412	46-44292Q03	18-3420	753	54534	18-3577-2	752
46-42040A3	18-3149-2	412	46-44292T1	18-3420	753	59972	18-3577-2	752
46-42040A5	18-3149-2	412	46-48748A1	18-3421	753	67859	18-3577-2	752
46-807151A14	18-3150	754	46-48745A1	18-3422	412	811573	18-3577-2	752
46-807151A7	18-3150	754	46-65496A1	18-3422	412	850454	18-3577-2	752
816597	18-3151	411, 753	46-68390A1	18-3422	412	878342	18-3577-2	752
826763A	18-3154	411	46-73842A2	18-3422	412	8504541	18-3577-2	752
47-72774A89	18-3155	754	46-77516A1	18-3422	412	8504541	18-3577-2	752
46-862914A13	18-3160-1	754, 755	46-73640A1	18-3423	412	850454002	18-3577-2	752
10-67373	18-3197	753, 831	46-77177A1	18-3424	412	F8269358	18-3577-2	752
10-76156	18-3197	753, 831	84188M	18-3425	416	F11100997	18-3577-2	752
93424	18-3198	861	84188T	18-3425	416	F11101053	18-3577-2	752
934241	18-3198	861	42431M	18-3426	416	56879	18-3584-1	752
934243	18-3198	861	84829M	18-3426	416	58086	18-3584	752
93423	18-3199	839, 861	97793M	18-3426	416	71683	18-3584-1	752
934231	18-3199	839, 861	97793T	18-3426	416	883885	18-3584-1	752
934233	18-3199	839, 861	81242M	18-3427	416	71683A1	18-3584-1	752
14-31210	18-3200	457	95661M	18-3427	416	35957	18-3593	752
14-816629	18-3200	457	46-812966A7	18-3445	412	37369	18-3593	752
14-816629Q	18-3200	457	46-812996A3	18-3445	412	52353	18-3593	752
14-F697140	18-3200	457	46-812996A9	18-3445	412	65142	18-3593	752
14-76281	18-3204	457	46-70941A3	18-3446	415	65142A1	18-3593	752
47-89983Q1	18-3207	412	46-48744A3	18-3448	416	814755	18-3593	752
47-89983T2	18-3207	412	46-879194401	18-3506	752	880817	18-3593	752
47-43026T11	18-3214	412	46-60366A1	18-3507	414	884727	18-3593	752
47-43026T6	18-3214	412, 754	46-32437A1	18-3517	414	F2774666	18-3593	752
47-43026T8	18-3214	412	46-42579A4	18-3517	414	F11001079	18-3593	752

Mercury Marine (Cont.)			Mercury Marine (Cont.)			Mercury Marine (Cont.)		
O.E. #	SIERRA #	PAGE #	O.E. #	SIERRA #	PAGE #	O.E. #	SIERRA #	PAGE #
F1100785	18-3593	752	11-45592	18-3723	449, 867	27-811547	18-3887	825
17437	18-3599-2	752	11-863332	18-3728	831	27-850470	18-3887	825
35341	18-3599-2	752	11-99298	18-3728	831	27-879150141	18-3887	825
37951	18-3599-2	752	10-36289	18-3729	831	39-45155A12	18-3902	421
52226	18-3599-2	752	10-97934	18-3729	831	39-78816A12	18-3902	421
54793	18-3599-2	752	816685	18-3749	850	39-45204A12	18-3918	421
60658	18-3599-2	752	79448	18-3751	456, 861	39-78811A12	18-3916	421
811841	18-3599-2	752	35992	18-3752	850	39-88392	18-3917	421
850399	18-3599-2	752	66071	18-3752	850	39-88392A12	18-3917	421
878341	18-3599-2	752	8168111	18-3752	850	39-817096A6	18-3918	421
8503991	18-3599-2	752	8168112	18-3752	850	39-817096A16	18-3919	421
850399002	18-3599-2	752	43436	18-3754	854	39-817096A26	18-3920	421
F1100742	18-3599-2	752	35915	18-3759	860	39-93481A12	18-3921	423
F1101208	18-3599-2	752	23-806036A1	18-3760	850	39-78918A4	18-3922	423
F1101292	18-3599-2	752	11-805092	18-3783	865	39-85636A4	18-3923	423
46-59112A2	18-3600	754	11-805092T	18-3783	865	39-18487A12	18-3924	423
46-63450A2	18-3600	754	11-859131	18-3783	865	39-815267A4	18-3925	423
46-72774A11	18-3600	754	805100	18-3784	864	39-813011A12	18-3927	423
46-72774A32	18-3600	754	11-39823	18-3785	865	39-74381A1	18-3928	809
46-73823A7	18-3600	754	11-39907	18-3785	865	39-75422	18-3928	809
32-32461	18-3601	771	11-54034	18-3785	865	39-17464	18-3937	809
32-32461A1	18-3601	771	11-82671127	18-3785	865	39-34988	18-3937	809
32-4172533	18-3602	772	11-805093	18-3786	865	39-65153	18-3937	809
32-8M0062309	18-3602	772	11-862907	18-3786	865	39-67123	18-3937	809
32-43437	18-3603	772	805101T	18-3787	865	F328506	18-3937	809
32-8M0090859	18-3603	772	14-34817	18-3788-9	865	F3892364	18-3937	809
893409	18-3607	458	27-19138	18-3804	435	F11100386	18-3937	809
807252Q3	18-3646	758	27-19138M	18-3804	435	F11100692	18-3937	809
807252T6	18-3646	758	27-84733M	18-3804	435	F11101321	18-3937	809
807252Q5	18-3647	758	27-825482	18-3827	435	39-17465	18-3938	809
807252T8	18-3647	758	27-825482T	18-3827	435	39-48345	18-3938	809
8052732	18-3649	758	27-18937	18-3828	435	39-67126	18-3938	809
8072522	18-3649	758	27-18937M	18-3828	435	F328516	18-3938	809
807252T2	18-3649	758	27-83899M	18-3828	435	F11100694	18-3938	809
8M0091470	18-3649	758	27-98990M	18-3828	435	F11101322	18-3938	809
59078T3	18-3650	758	27-803508	18-3844	435	39-48344	18-3939	809
27-850318	18-3675	439	27-825032	18-3845	435	39-66217	18-3939	809
27-8503181	18-3675	439	27-187851	18-3861	435	39-97125	18-3939	809
11-52707	18-3700	457	27-187853	18-3861	435	F11100387	18-3939	809
11-827614	18-3700	457	27-18785T	18-3861	435	F11100783	18-3939	809
F7040	18-3700	457	27-41246-1	18-3862	435	F11101134	18-3939	809
11-52707A1	18-3701	457, 865	27-96542-1	18-3863	435	39-67127	18-3940	Obsolete
11-52707A2	18-3701	457, 865	27-822844-1	18-3864	435	39-34479	18-3942	809
11-52707Q1	18-3701	457, 865	27-18786-1	18-3871	435	39-58096	18-3942	809
11-69578A1	18-3702	457	27-41245-1	18-3872	435	39-67119	18-3942	809
11-69578Q1	18-3702	457	27-811546	18-3874	825	39-67132	18-3942	809
11-69578T1	18-3702	457	27-879150139	18-3874	825	39-75609	18-3944	809
11-88228	18-3703	457	27-34278	18-3876	825	F11101057	18-3944	809
11-69578	18-3704	457	27-48330	18-3876	825	39-18653A12	18-3966	421
12-45810	18-3712	850	27-75611	18-3876	825	39-18653A1	18-3967	421
11-22339	18-3713	850	27-75611001	18-3876	825	39-18653A2	18-3968	421
11-36084	18-3713	850	27-13218	18-3877	825	39-15320M	18-3976	421
11-97522	18-3713	850	27-13687	18-3877	825	39-15320T	18-3976	421
F1348	18-3713	850	27-19315	18-3877	825	39-18939M	18-3977	421
F1881	18-3713	850	27-49104	18-3877	825	39-15322M	18-3978	421
12-31211	18-3714	457, 865	27-61224	18-3877	825	39-96170A12	18-3979	421
12-31211A2	18-3714	457, 865	27-8M0049045	18-3877	825	39-96170A4	18-3981	421
12-31211A3	18-3714	457, 865	27-97529	18-3877	825	39-822321A12	18-3982	421
12-31211Q03	18-3714	457, 865	27-13709	18-3878	825	39-824905A12	18-3982	421
11-35921	18-3719	454, 860	27-13709T	18-3878	825	39-822321A2	18-3984	421
11-47411	18-3719	454, 860	27-74264	18-3878	825	39-81096M	18-3986	421
11-826375	18-3719	454, 860	27-79986	18-3878	825	39-83196M	18-3992	421
11-F694188	18-3719	454, 860	27-92166	18-3878	825	60207	18-4008	798
11-34932	18-3720	456, 867	27-921661	18-3878	825	52999	18-4009	798
11-13439-1	18-3721	831	27-11986	18-3879	825	60252	18-4009	798
11-21298	18-3721	456, 867	27-42744	18-3879	825	60252A2	18-4009	798
11-22178	18-3721	456, 867	27-816460	18-3879	825	765-7443A11	18-4013	423
11-24648	18-3721	456, 867	27-879150140	18-3879	825	765-7446A11	18-4014	423
11-29241	18-3721	456, 867	27-34273	18-3880	825	783-9613A2	18-4017	421
11-33962	18-3721	456, 867	27-342731	18-3880	825	783-9613T2	18-4017	421
11-34933	18-3721	456, 867	27-34274	18-3881	825	783-9613A3	18-4018	421
11-46355	18-3721	456, 867	27-39164	18-3881	825	783-9613T3	18-4018	421
11-82671015	18-3721	456, 867	27-47453	18-3881	825	39-19721A6	18-4019	421
11-859116	18-3721	831	27-72622	18-3881	825	39-19721A1	18-4020	421
11-95702	18-3721	456, 867	27-56110	18-3883	825	39-19721A2	18-4021	421
11-20361	18-3722	456, 867	27-64763	18-3883	825	26-49131	18-4022	818
11-35888	18-3722	456, 867	27-75646	18-3883	825	26-67863	18-4022	818
11-8267089	18-3722	456, 867	27-75647	18-3883	825	26-75982	18-4022	818

Mercury Marine (Cont.)			Mercury Marine (Cont.)			Mercury Marine (Cont.)		
O.E. #	SIERRA #	PAGE #	O.E. #	SIERRA #	PAGE #	O.E. #	SIERRA #	PAGE #
26-75988	18-4022	818	F11101318	18-4173	809	27-90484A32	18-4317	431
F3866612	18-4022	818	F11101334	18-4173	809	27-90484A86	18-4317	431
F11100968	18-4022	818	735-9715	18-4178	809	27-90484A88	18-4317	431
F11101117	18-4022	818	735-97151	18-4178	809	27-11338A85	18-4319	432
26-58094	18-4023	818	735-9715T1	18-4178	809	27-11338A88	18-4319	432
26-72564	18-4023	818	F11101317	18-4178	809	27-89221A32	18-4319	432
26-75413	18-4023	818	733-2278	18-4180	809	27-89221A84	18-4319	432
26-75624	18-4023	818	733-66217	18-4180	809	27-89221A85	18-4319	432
26-8M0050563	18-4024	818	736-2343	18-4180	809	27-89221A88	18-4319	432
26-97864	18-4024	818	735-6538	18-4181	809	25-85491A87	18-4325	432
26-976641	18-4024	818	737-6523	18-4189	809	27-85491A90	18-4325	432
F11101200	18-4024	818	737-879194035	18-4189	809	27-43779A87	18-4326	430
29-47270	18-4036	424	F11101101	18-4189	809	27-41499A87	18-4334	430
29-71422	18-4037	424	733-3819	18-4191	809	27-43004A86	18-4336	430
31-47245A1	18-4038	424	733-38191	18-4191	809	27-43004A90	18-4336	430
31-55332A1	18-4038	424	733-4028	18-4191	809	27-43004A99	18-4336	430
31-58859A1	18-4038	424	733-803850T	18-4191	809	27-812867A91	18-4337	430
31-61424A2	18-4038	424	F11100779	18-4191	809	27-812867A96	18-4337	430
31-62596A1	18-4038	424	F11100780	18-4191	809	27-812867A97	18-4337	430
31-63075A1	18-4038	424	22-16951A1	18-4218	801	27-814754A00	18-4338	430
31-17514A2	18-4039	424	22-16951Q1	18-4218	801	27-14697A87	18-4339	431
31-8M0045430	18-4039	424	22-16951T1	18-4218	801	27-13461A88	18-4340	431
39-827179A12	18-4050	423	22-64426	18-4218	801	27-13461A89	18-4340	431
39-826293A12	18-4051	423	22-87238	18-4218	801	27-13461A90	18-4340	431
39-826297A12	18-4052	423	12-13171	18-4220	458	27-13461A99	18-4340	431
759-592010	18-4109	809	12-77987	18-4220	458	27-64203A73	18-4351	432
759-661010	18-4109	809	12-77987A1	18-4220	458	27-64203A74	18-4351	432
759-80661A3	18-4109	809	12-835467	18-4220	458	27-64203A75	18-4351	432
759-80661A7	18-4109	809	12-8354671	18-4220	458	27-46110A1	18-4353	433
759-831210	18-4109	809	12-835467Q01	18-4220	458	27-46110A2	18-4353	433
759-8312A2	18-4109	809	13191A1	18-4221	458	27-46110A72	18-4353	433
778-9015A2	18-4109	809	75282A1	18-4221	458	27-72486A32	18-4353	433
778-9441A3	18-4109	809	22-806928A1	18-4224	801	27-72486A76	18-4353	433
759-592012	18-4134	809	22-862210A01	18-4224	801	27-72486A78	18-4353	433
759-661012	18-4134	809	22-806608A02	18-4226	801	27-72486A79	18-4353	433
759-80661A8	18-4134	809	22-806608A1	18-4226	801	27-73645A32	18-4354	Obsolete
759-806661A5	18-4134	809	22-806928	18-4227	801	27-73645A76	18-4354	Obsolete
759-831212	18-4134	809	22-862210	18-4227	801	27-73645A87	18-4354	Obsolete
759-8312A6	18-4134	809	73345	18-4233	458	27-55306A72	18-4355	433
759-9015A4	18-4134	809	12-92647M	18-4233	458	27-55306A73	18-4355	433
778-9441A5	18-4134	809	73345A1	18-4233	458	27-55306A74	18-4355	433
761-7131M	18-4135	421	24-46312	18-4252	870	27-55306A75	18-4355	433
761-7133M	18-4135	421	22-33198	18-4258	661	27-78028A78	18-4355	433
761-7134M	18-4135	421	22-33198A1	18-4258	661, 798	27-60476A72	18-4356	433
761-7982M	18-4135	421	22-41622	18-4258	661, 798	27-80476A73	18-4356	433
761-7982T	18-4135	421	22-41622	18-4258	661, 798	27-60476A74	18-4356	433
761-7196M	18-4138	421	22-46754	18-4258	661	27-60476A75	18-4356	433
761-7197M	18-4138	421	19643	18-4261	443	27-85653A32	18-4356	433
761-7198M	18-4138	421	22-30139	18-4263	798	27-85653A79	18-4356	433
761-8484M	18-4138	421	22-32802	18-4263	798	27-85653A87	18-4356	433
776-9096A1	18-4156	421	22-328021	18-4263	798	27-73440A76	18-4357	434
733-3818	18-4160	809	22-328022	18-4263	798	27-76589A77	18-4357	434
733-38181	18-4160	809	22-841908	18-4263	798	27-76589A78	18-4357	434
F11100781	18-4160	809	F700633	18-4263	798	27-76589A79	18-4357	434
24-38191	18-4161	809	F15810151	18-4263	798	27-88449A32	18-4357	434
733-3819	18-4161	809	22-32803	18-4264	798	27-88449A80	18-4357	434
733-4028	18-4161	809	22-87543	18-4264	798	27-815791A92	18-4359	434
733-803850T	18-4161	809	F15880010	18-4264	798	27-815792A90	18-4359	434
F11100779	18-4161	809	22-42861	18-4265	798	27-815809A90	18-4359	434
F11100780	18-4161	809	22-428611	18-4265	798, 835	27-815810A90	18-4359	434
735-6371	18-4164	809	22-861187	18-4265	798	27-801855	18-4365	822
735-850098	18-4164	809	12-29395	18-4267	831	27-72479	18-4366	824
735-9431	18-4164	809	12-8M0042641	18-4267	831	27-72479A5	18-4366	823, 823, 824
735-9687	18-4164	809	12-36001	18-4270	831	27-72479T	18-4366	824
735-9704	18-4164	809	19-32652	18-4272	831	27-99777A1	18-4367	820
F11101185	18-4164	809	19-42682	18-4273	831	27-34213A1	18-4375	824
F11101320	18-4164	809	12-22388	18-4275	443	27-34213A2	18-4375	824
F11101336	18-4164	809	12-25945	18-4275	443	27-42457A1	18-4377	Obsolete
735-6370	18-4173	809	12-29245	18-4275	443	27-54529A1	18-4378	Obsolete
735-6370	18-4173	809	12-32733	18-4275	443	27-68714	18-4380	824
735-808661	18-4173	809	12-38753	18-4275	443	27-68714A6	18-4380	824
735-808674	18-4173	809	12-824793	18-4275	443	27-68714A7	18-4380	824
735-808674A1	18-4173	809	23-44165	18-4288	871	27-72098	18-4380	824
735-850097	18-4173	809	23-807073	18-4288	871	27-41636A1	18-4381	823
735-9688	18-4173	809	53-805272	18-4289	871	27-43186A1	18-4381	823
735-9703	18-4173	809	40-52035	18-4294	421	27-89656A1	18-4381	823
833232E	18-4173	809	53-29641	18-4295	861	27-74264A1	18-4382	823
F11101184	18-4173	809	35983	18-4296	850	27-74830A1	18-4382	823

Mercury Marine (Cont.)			Mercury Marine (Cont.)			Mercury Marine (Cont.)		
O.E. #	SIERRA #	PAGE #	O.E. #	SIERRA #	PAGE #	O.E. #	SIERRA #	PAGE #
27-74830A3	18-4382	823	785-9738T9	18-4636	424	34235T1	18-5250	694
27-801853	18-4387	822	785-9737A10	18-4637	424	805759Q3	18-5273	695
27-11977A88	18-4388	822	785-9738T10	18-4638	424	805759T3	18-5273	695
27-11977A92	18-4388	822	700-858294T1	18-4639	424	850484T3	18-5278	695
27-47453A1	18-4389	822	700-858295T1	18-4640	424	811635Q2	18-5280	695
27-64763A2	18-4391	Obsolete	700-878571A2	18-4641	424	808483Q2	18-5281	695
27-75611A1	18-4392	822	700-878572A2	18-4642	424	808483K2	18-5291	694
27-75611A2	18-4392	822	700-878573A2	18-4643	424	33707	18-5300	696
27-33395A1	18-4394	820	700-878574A2	18-4644	424	392-6325	18-5303	695
27-33395A2	18-4394	820	27-81987	18-4698	443	392-898253005	18-5303	695
27-35898A2	18-4395	821	27-81987M	18-4698	443	8M6001219	18-5303	695
27-35898A3	18-4395	821	27-81987M	18-46981-9	443, 462, 462	F16900031	18-5303	695
27-35898A4	18-4395	821	1667-9011G59	18-4830	455	33700	18-5310	695
27-46401A1	18-4396	821	1647-9148T93	18-4832	455	34235	18-5311	698
27-46820A1	18-4397	Obsolete	1667-9011R6	18-4850	Osbolete	34235T	18-5311	698
27-53354A1	18-4398	821	12-45176	18-4858-9	443	13447A1	18-5313-1	702
27-54566A1	18-4399	821	50-12066A1	18-4915	394	17177A1	18-5313-1	702
27-11977	18-4408	820	50-12066A9	18-4915	394	68521A3	18-5313-1	702
27-11987	18-4408	820	50-12066Q9	18-4915	394	68521A4	18-5313-1	702
91-37384	18-4442	229, 858	50-22791A1	18-4915	394	74905A3	18-5313-1	702
91-48347	18-4442	229, 858	50-28985A2	18-4915	394	816148A1	18-5313-1	702
91-57797A1	18-4442	229, 858	50-45093	18-4915	394	91823A3	18-5313-1	702
91-57797A2	18-4442	229, 858	805629	18-5021	798	391-5090	18-5314	695
91-57797A3	18-4442	229, 858	802464	18-5107-1	698	391-898253004	18-5314	695
91-8M0067546	18-4442	229, 858	804412	18-5107-1	698	8M6001250	18-5314	695
91-38277A1	18-4444	457, 865	811637	18-5107-1	698	33266	18-5315-1	702
91-95830	18-4444	457, 865	850487	18-5107-1	698	52352	18-5315-1	702
91-95830A1	18-4444	457, 865	811637001	18-5107-1	698	58231	18-5315-1	702
34765A1	18-4456	122, 874	811637002	18-5107-1	698	62424	18-5315-1	702
34765A2	18-4456	874	811637T	18-5107-1	698	87581	18-5315-1	702
12644A1	18-4457	122, 874	811639	18-5108	698	195141	18-5315-1	702
12644Q01	18-4457	874	811639T	18-5108	698	87581T	18-5315-1	702
91-821887A1	18-4459	457, 865	87-861780A2	18-5116-1	698	64850	18-5317	695
91-859046Q4	18-4459	457, 865	87-861780Q4	18-5116-1	698	87-71831	18-5317	695
91-859046T4	18-4459	457, 865	87-892150A02	18-5116-1	698	58033	18-5318	695
22-807155	18-4461	661, 801	336-3948A2	18-5139	374	898253007	18-5318	695
938-883490	18-4485	S/S to 18-4485HP	336-3948A3	18-5139	374	391-5092	18-5338	696
938-883490R1	18-4485	S/S to 18-4485HP	336-4318A2	18-5139	374	391-5092	18-5338	696
938-883490R50	18-4485	S/S to 18-4485HP	336-4318A3	18-5139	374	391-5093	18-5338	696
938-884741R	18-4485	S/S to 18-4485HP	336-4318A4	18-5139	374	391-898253001	18-5338	696
938-884741R50	18-4485	S/S to 18-4485HP	398-2202	18-5140	375	8M6001217	18-5338	696
938-803860T	18-4486	S/S to 18-4486HP	394-1100A2	18-5148	375	F16900040	18-5338	696
938-883297 1	18-4486	S/S to 18-4486HP	394-1100A3	18-5148	375	33706	18-5344	696
936-810840	18-4489	Obsolete	394-352A1	18-5148	375	6325	18-5345	696
936-986767	18-4489	Obsolete	398-174	18-5153	375	33662	18-5345	696
938-827178	18-4491	Obsolete	339-880615T01	18-5154	376	898253003	18-5345	696
35329	18-4492	666, 809	394-1130	18-5169	375	898253005	18-5345	696
F3746241	18-4492	666, 809	394-1130A1	18-5169	375	33662Q	18-5345	696
F1100014	18-4492	666, 809	397-359	18-5169	375	8M6001218	18-5345	696
F11000495	18-4492	666, 809	397-741	18-5169	375	F16900031	18-5345	696
774-9137A10	18-4515	421	802371A1	18-5181	376	58034	18-5346	696
774-9137A14	18-4535	Obsolete	823033	18-5182	Osbolete	81-64851	18-5346	696
776-8898A2	18-4535	Obsolete	339-7370A13	18-5186	239	392-6324	18-5347	696
765-7443A12	18-4560	424	339-832757A4	18-5186	376	392-898253002	18-5347	696
765-7443A2	18-4560	424	339-850227	18-5187	376	8M6001249	18-5347	696
766-8667A36	18-4565	424	339-856991A1	18-5187	376	F16900023	18-5347	696
766-8667A43	18-4565	424	398-693	18-5206	375	F16900032	18-5347	696
743-3193A2	18-4620	421	398-713	18-5207	375	F16900083	18-5347	696
743-3193A4	18-4620	421	20121	18-5224	381, 714	F16900189	18-5347	696
743-5172A6	18-4620	421	8M0084600	18-5224	381, 714	888751A02	18-5350	701
780-9229A7	18-4620	421	84-813706A26	18-5225	381, 714	888751A03	18-5350	701
743-3366A1	18-4621	421	84-90816A26	18-5225	381, 714	888751A1	18-5350	701
743-3366A2	18-4621	421	84-93212A1	18-5225	381, 714	884794A02	18-5351	701
780-9229A10	18-4621	421	84-93475A26	18-5225	381, 714	884794A1	18-5351	701
743-7716A2	18-4622	421	84-99215A26	18-5225	381, 714	392-9766	18-5352	696
780-9229A11	18-4622	421	84-813715A1	18-5227-1	380	392-9766Q1	18-5352	696
777-815965A4	18-4623	421	84-813715A1	18-5228-1	380	392-9766T	18-5352	696
777-815965T4	18-4623	421	888731	18-5243	696	F16900185	18-5352	696
777-815965A5	18-4624	421	898253T23	18-5243	696	392-9086	18-5353	696
777-815965A6	18-4625	421	884792	18-5244	696	392-9086T	18-5353	696
2704-812896A2	18-4626	421	898253T22	18-5244	696	804418	18-5354	696
2704-821896A6	18-4626	421	884790	18-5245	696	808483	18-5354	696
2704-826191A4	18-4626	421	898253013	18-5245	696	804483T	18-5354	696
2704-826191A6	18-4626	421	898253T28	18-5246	694	808483T3	18-5354	696
2704-826191T4	18-4626	421	898253T29	18-5247	694	811635	18-5361	696
2704-821896A3	18-4627	421	8M0060495	18-5247	694	811635T3	18-5361	696
2704-821896A4	18-4628	421	8M0061335	18-5247	694	850484	18-5362	695
785-9737T9	18-4635	424	34235Q1	18-5250	694	850484T	18-5362	695

Mercury Marine (Cont.)			Mercury Marine (Cont.)			Mercury Marine (Cont.)		
O.E. #	SIERRA #	PAGE #	O.E. #	SIERRA #	PAGE #	O.E. #	SIERRA #	PAGE #
850484T2	18-5362	695	817378	18-5443	678	883072T	18-5743	386
392-6318	18-5369	697	817378T	18-5443	698	332-5524A1	18-5775	376
392-6318T	18-5369	697	898253T27	18-5443	698	332-7778A1	18-5775	376
FI6900184	18-5369	697	805185A37	18-5470	701	332-7778A12	18-5775	376
391-5075	18-5376	697	805185A36	18-5471	701	332-7778A3	18-5775	376
391-5075Q1	18-5376	697	817377	18-5475	701	332-7778A6	18-5775	376
FI6900148	18-5376	697	817377T	18-5475	701	332-7778A7	18-5775	376
33708	18-5384	697	807964A1	18-5476	701	332-7778A9	18-5775	376
33667	18-5385	697	907964A1	18-5476	701	F749301	18-5775	376
393-9459	18-5385	697	805222A1	18-5484-1	701	F7778A9	18-5775	376
393-9459Q1	18-5385	697	YLM579AV	18-5497-2	182, 702	339-7452A1	18-5776	376
393-9459T	18-5385	697	50-38890A1	18-5601	391, 393	339-7452A2	18-5776	376
FI6900052	18-5385	697	50-55601	18-5601	391, 393	339-7452A3	18-5776	376
33765	18-5386	697	50-55601A2	18-5601	391, 393	339-7452A15	18-5777	376
33765T	18-5386	697	50-44369A1	18-5602	391, 393	339-7452A19	18-5777	376
393-3230	18-5389	697	50-58788A3	18-5602	391, 393	339-7452A7	18-5777	376
393-4988	18-5389	697	50-67341	18-5602	391, 393	339-7452A9	18-5777	376
393-4988T	18-5389	697	50-893891T	18-5602	391, 393	339-7452A11	18-5778	376
393-4988T2	18-5389	697	573001	18-5603	S/S to 18-5603-1	339-7452A14	18-5778	376
43557	18-5395	697	50-808011A4	18-5603-1	S/S to 18-5603-1	339-7452A21	18-5778	376
16457A4	18-5395	697	RA122009	18-5603-1	643	339-7452A8	18-5778	376
43557A1	18-5395	697	50-73521	18-5605	391	332-4911A5	18-5787	376
805759A1	18-5395	697	50-73521T	18-5605	391	332-4911A8	18-5787	376
805759A2	18-5395	697	50-898263005	18-5605	391	339-6222A8	18-5788	Obsolete
805759A5	18-5395	697	50-44369	18-5606	391	18495A12	18-5790	377
805759T	18-5395	697	50-44369A1	18-5606	391	18495A19	18-5790	377
805759T1	18-5395	697	50-60315	18-5606	391	18495A26	18-5790	377
90746A1	18-5395	697	50-44414	18-5608	391	19052A3	18-5791	377
13753A2	18-5396	697	50-44414	18-5608	391	19052A5	18-5791	377
815407A2	18-5396	697	50-44415	18-5608	391	19052A8	18-5791	377
392-6329	18-5399	697	50-44415	18-5608	391	16061T	18-5792	377
898253009	18-5402	696	50-77141	18-5608	391	823034	18-5793	377
392-9089	18-5403	696	50-77141	18-5608	391	823034T	18-5793	377
392-9089Q	18-5403	696	50-79472	18-5608	391	96455A15	18-5796	Obsolete
392-9089T	18-5403	696	50-79472	18-5608	391	68162A3	18-5797	384
392-9767	18-5403	696	50-79472 1	18-5608	391	68162A6	18-5797	384
FI6900186	18-5403	696	50-79472 1	18-5608	391	96455A1	18-5797	384
FI6900190	18-5403	696	50-660151	18-5610	391	96455A8	18-5797	384
391-5088	18-5404-1	696	50-660153	18-5610	391	68162A1	18-5798	384
391-7057	18-5404-1	696	50-66015T	18-5610	391	68162A5	18-5798	384
391-7057T	18-5404-1	696	50-893892T	18-5610	391	68162A8	18-5798	384
391-898253029	18-5404-1	696	50-8M0033984	18-5611	391	96455A6	18-5798	384
8M6001224	18-5404-1	696	50-90983A1	18-5611	391	96455A9	18-5798	384
FI6901224	18-5404-1	696	50-90983T1	18-5611	391	89-76416A1	18-5801	718
808484	18-5405	696	50-818445-2	18-5620	391	54981	18-5802	386, 718
898253010	18-5405	696	50-818445-3	18-5620	391	65057	18-5802	386, 718
808484 1	18-5405	696	50-8184455	18-5620	391	65057A1	18-5802	386, 718
811636	18-5406	696	50-822462	18-5621	391	65057T1	18-5802	386, 718
898253011	18-5406	696	50-822462T1	18-5621	391	13037	18-5804	718
811636 1	18-5406	696	50-893890T	18-5621	391	47886	18-5808	386
392-6326	18-5407	696	50-57465A1	18-5636	392	47886T	18-5808	386
392-6326T	18-5407	696	50-57867	18-5636	392	809462	18-5811	386, 719
FI6900044	18-5407	696	50-58788A3	18-5636	392	809463	18-5811	386, 719
804424	18-5408	696	50-64975	18-5636	392	8094621	18-5811	386, 719
850485	18-5408	696	50-72467	18-5636	392	8094631	18-5811	386, 719
8504851	18-5408	696	50-44369A1	18-5642	391	809463A1	18-5811	386, 719
898253012	18-5408	696	50-66015	18-5642	391	89-15857	18-5815	386, 719
8M0062084	18-5408	696	50-66015T1	18-5642	391	89-61053	18-5815	386, 719
58217	18-5418	696	50-893891T	18-5642	391	89-65258	18-5815	386, 719
898253008	18-5418	696	57380	18-5650	393	89-68258A4	18-5815	386, 719
58217Q	18-5418	696	68575	18-5656	393	89-76545	18-5815	386, 719
65864	18-5420	696	86177	18-5658	393	89-76545T	18-5815	386, 719
78016	18-5420	696	86177 1	18-5658	393	89-85365A1	18-5815	386, 719
13524A5	18-5431	696	75661	18-5674	393	89-91975	18-5816	386, 719
13524T1	18-5431	696	13310T1	18-5674	393	89-96054	18-5816	386, 719
13524A4	18-5432	696	75384	18-5697	393	89-96054T	18-5816	386
13524A6	18-5432	696	816770	18-5707	386	94318	18-5817	386, 719
13524Q06	18-5432	696	62351A1	18-5707	386	846070	18-5817	386, 719
19405A4	18-5432	696	62351A2	18-5707	386	89-96158	18-5817	386, 719
90576A4	18-5432	696	816770T	18-5707	386	89-96158T	18-5817	386, 719
38547	18-5433	376, 698	33270	18-5717	718	89-81886A	18-5818	386
32193A2	18-5433	376, 698	87-18211	18-5729	387	89-818864T	18-5818	386
392-806529A1	18-5433	376, 698	87-19761	18-5737	387	89-818997A1	18-5819	386
898253T24	18-5433	376, 698	42785	18-5740	722	89-818997A2	18-5819	386
392-7803A4	18-5438	698	815279-1	18-5741	386	89-818997T1	18-5819	386
392-805570A2	18-5438	698	815279A2	18-5741	386	89-818999A2	18-5820	386, 719
806673T	18-5442	698	815279-3	18-5743	386	89-825842A1	18-5820	386, 719
806673T1	18-5442	698	815279-5	18-5743	386	89-850188T1	18-5820	386, 719

Mercury Marine (Cont.)			Mercury Marine (Cont.)			Mercury Marine (Cont.)		
O.E. #	SIERRA #	PAGE #	O.E. #	SIERRA #	PAGE #	O.E. #	SIERRA #	PAGE #
825096T01	18-5821	386	50-97499R4	18-5907	715	31640	18-6011A	458
89-825096T	18-5821	386	50-17251A2	18-5908	716	31640A1	18-6011A	458
54293A10	18-5822	386	50-17251A3	18-5908	716	31640Q4	18-6011A	458
54293A13	18-5822	386	50-47455	18-5908	716	31640T6	18-6011A	871
54293A4	18-5822	386	50-65784A1	18-5908	716	34127	18-6012	871
89-817109A2	18-5834	387	50-76965A3	18-5908	716	34127A1	18-6012	871
25661	18-5836	387, 719	50-76967A1	18-5908	716	34127A2	18-6012	871
256611	18-5836	387, 719	50-76967A4	18-5908	716	34127T1	18-6012	871
25661T1	18-5836	387, 719	50-808011A05	18-5908	716	34127T2	18-6012	871
89-18080	18-5837	718	50-808011A1	18-5908	716	32170	18-6013	871
33261	18-5838	718	50-808011A3	18-5908	716	32170A1	18-6013	871
33316	18-5838	718	50-808011A4	18-5908	716	34762A1	18-6013	871
80687	18-5838	718	50-99419A3	18-5908	716	97-34672C	18-6013	871
89902	18-5838	718	50-12177A2	18-5910	716	822777	18-6014	458, 871
89-99253	18-5838	718	50-99418A2	18-5910	716	8227772	18-6014	458, 871
828151	18-5849	387	50-17251A3	18-5911	715	463999A2	18-6014	458, 871
828151A1	18-5849	387	50-76965A4	18-5911	715	46399A1	18-6014	458, 871
882751A1	18-5849	387	50-77328A3	18-5911	715	822777A1	18-6014	458, 871
882751A2	18-5849	387	50-99417A2	18-5911	715	822777A3	18-6014	458, 871
882751A04	18-5850	387	50-99419A3	18-5911	715	822777A4	18-6014	458, 871
821509	18-5852	387	50-812428A3	18-5913-1	715	822777Q1	18-6014	458, 871
853292	18-5852	387	50-812804A2	18-5913-1	715	46399A1	18-6014A	458, 871
821509T1	18-5852	387	50-822330A2	18-5913-1	715	822777A1	18-6014A	458, 871
398-5454A17	18-5854	384	50-864340A2	18-5913-1	715	822777Q1	18-6014A	458, 871
336-3996A7	18-5855	384	50-806963A4	18-5919-1	716	55989	18-60151-9	871
398-5255	18-5856	384	50-806965A2	18-5919-1	716	55989A3	18-60151-9	871
398-5454A7	18-5857	384	50-806965A4	18-5919-1	716	55989A4	18-60151-9	871
398-5454A22	18-5859	384	892940T	18-5929	390	55989A9	18-60151-9	871
398-5919A3	18-5859	384	56045	18-5956	721	55989Q9	18-60151-9	871
398-5919A7	18-5859	384	59755	18-5956	721	55989T9	18-60151-9	871
398-5454A35	18-5860	384	69729	18-5956	721	55989A3	18-6015-9	871
86617A20	18-5864	383	78477	18-5956	721	55989Q9	18-6015-9	871
398-5704A7	18-5865	383	90794	18-5956	721	55989T9	18-6015-9	871
398-5919A4	18-5866	Obsolete	78403A1	18-5956	721	55989A3	18-6015A-9	871
398-9873A4	18-5867	Obsolete	78403A2	18-5956	721	55989Q9	18-6015A-9	871
398-832075A-21	18-5870	383	12449	18-5957	721	55989T9	18-6015A-9	871
398-832075A4	18-5870	239	56045	18-5957	721	76214	18-6016	458, 871
398-5454A32	18-5871	383	59755	18-5957	721	762142	18-6016	458, 871
398-832075A6	18-5873	383	69729	18-5957	721	762142A1	18-6016	458, 871
398-5454A21	18-5874	383	78477	18-5957	721	76214A5	18-6016	458, 871
398-5454A25	18-5874	383	90794	18-5957	721	786214A2	18-6016	458, 871
398-5454A63	18-5874	383	92497	18-5957	721	97-762145	18-6016	458, 871
398-5919A2	18-5874	383	12449A1	18-5957	721	97-76214Q5	18-6016	458, 871
398-5919A6	18-5874	383	78403A1	18-5957	721	76214	18-60161	458, 871
398-5919A8	18-5874	383	78403A2	18-5957	721	76214Q5	18-60161	458, 871
398-818535A15	18-5874	383	817119A1	18-5957	721	76214T3	18-60161	458, 871
398-832075A14	18-5874	383	817119A4	18-5957	721	76214	18-6016A	458, 871
398-832075A20	18-5874	383	92497A3	18-5957	721	76214Q5	18-6016A	458, 871
398-9610A19	18-5876	383	98555A1	18-5957	721	76214T3	18-6016A	458, 871
332-5772A1	18-5881	377	807653T	18-5960	721	43994A2	18-6066	871
332-5772A2	18-5881	377	12449	18-5965	721	821631A1	18-6066	871
332-5772A3	18-5881	377	92497	18-5965	721	821631B1	18-6066	871
332-5772A5	18-5881	239, 377	12449A1	18-5965	721	821631C	18-6066	871
F720301	18-5881	377	805884T	18-5965	721	821631Q1	18-6066	871
12415	18-5896	409	817119A1	18-5965	721	43994A2	18-6066A	871
36525	18-5897	769	817119A4	18-5965	721	821631Q1	18-6066A	871
97257	18-5897	769	92497A3	18-5965	721	806189A1	18-6067	872
806490	18-5897	769	98555A1	18-5965	721	97-806189	18-6067	872
811091	18-5897	769	12449	18-5966	721	97-806189Q1	18-6067	872
806490T	18-5897	769	92497	18-5966	721	806189A1	18-6067A	872
97257A1	18-5897	769	12449A1	18-5966	721	97-806189	18-6067A	872
34625	18-5898	769	12449A1	18-5966	721	97-806189Q1	18-6067A	872
97258	18-5898	769	817119A1	18-5966	721	826134	18-6068	458, 872
97258A1	18-5898	769	817119A4	18-5966	721	826134A1	18-6068	458, 872
F16900152	18-5898	769	98555A1	18-5966	721	97-826134Q	18-6068	458, 872
F16900198	18-5898	769	807652T	18-5967	721	806105	18-6079	872
34623	18-5899	769	47487T	18-5978	Obsolete	806105A1	18-6079	872
90806	18-5899	769	862030T	18-5983	721	806105Q1	18-6079	872
815425	18-5899	769	31640	18-6011	458	806105T1	18-6079	872
815425T	18-5899	769	316403	18-6011	458	815933A1	18-6080	872
8M0068784	18-5899	769	316404	18-6011	458	821629A1	18-6080	837, 872
90806A1	18-5899	769	31640A1	18-6011	458	97-821629Q1	18-6080	872
50-12872	18-5903	717	31640A2	18-6011	458	821629	18-6080A	872
50-56886	18-5903	717	31640A4	18-6011	458	821629A1	18-6080A	872
50-69865A1	18-5903	717	31640T6	18-6011	458	821629Q1	18-6080A	872
50-72550A2	18-5907	715	72436A1	18-6011	458	806190A1	18-6089	872
50-7960A43	18-5907	715	97-31640B4	18-6011	458	806190T1	18-6089	872
50-97499A2	18-5907	715	97-31640Q4	18-6011	458	97-806190	18-6089	872

Mercury Marine (Cont.)			Mercury Marine (Cont.)			Mercury Marine (Cont.)		
O.E. #	SIERRA #	PAGE #	O.E. #	SIERRA #	PAGE #	O.E. #	SIERRA #	PAGE #
97-806190B4	18-6089	872	821631Q1	18-6243	871	875286A1	18-6455	390
97-806190Q1	18-6089	872	76214	18-6244	458, 871	875286T	18-6455	390
806190	18-6092	872	76214Q5	18-6244	458, 871	881247A1	18-6455	390
806190A1	18-6092	872	76214T3	18-6244	458, 871	807757T	18-6457	752
806190Q1	18-6092	872	10-32470	18-6245	459	84-881262A2	18-6500	390
806190T1	18-6092	872	43396A2	18-6249	459	24-29340A1	18-6506	394
806190	18-6092A	872	818298A1	18-6249	459	24-29340T1	18-6506	394
806190A1	18-6092A	872	818298Q1	18-6249	459	14336A20	18-6746	720
806190Q1	18-6092A	872	43396A2	18-6249A	459	14336A20	18-6746	720
806190T1	18-6092A	872	818298A1	18-6249A	459	14336A25	18-6746	720
806105	18-6093	843, 872	818298Q1	18-6249A	459	14336A31	18-6746	720
806105A1	18-6093	843, 872	392-2940	18-6254	Obsolete	14336A8	18-6746	720
806105Q1	18-6093	872	392-8989	18-6255	720	865380A03	18-6746	720
806105T1	18-6093	872	392-2529	18-6256	Obsolete	865380A13	18-6746	720
806105	18-6093A	872	99186	18-6273-1	382	88183A5	18-6746	720
806105A1	18-6093A	872	99186-1	18-6273-1	382	42419A1	18-6749	719
806105Q1	18-6093A	872	99186T	18-6273-1	382	42419A1	18-6749	719
806105T1	18-6093A	872	14336A20	18-6274	383	58397A2	18-6749	719
817373A1	18-6094	872	814472	18-6275	S/S to 18-6275-1	58397A3	18-6749	719
821630A1	18-6094	872	50-12121A2	18-6275	S/S to 18-6275-1	862548A1	18-6749	719
821630C2	18-6094	872	50-12177A2	18-6275	S/S to 18-6275-1	86553A1	18-6749	719
97-821630Q1	18-6094	872	50-77328A1	18-6275	S/S to 18-6275-1	88893A4	18-6749	719
821630	18-6094A	872	50-77328A3	18-6275	S/S to 18-6275-1	42419A1	18-6750	719
821630A1	18-6094A	872	50-80696A2	18-6275	S/S to 18-6275-1	862548A1	18-6750	719
821630Q1	18-6094A	872	50-80696A3	18-6275	S/S to 18-6275-1	811618	18-6751	381
821630T1	18-6094A	872	50-80696A4A	18-6275	S/S to 18-6275-1	811618A1	18-6751	381
815933A1	18-6099	872	50-80790A1	18-6275	S/S to 18-6275-1	812843A1	18-6751	381
821629A1	18-6099	872	50-812428A3	18-6275	S/S to 18-6275-1	813442A1	18-6751	381
97-821629Q1	18-6099	872	50-812604A2	18-6275	S/S to 18-6275-1	813442A2	18-6751	381
806189	18-6114	872	50-822330A2	18-6275	S/S to 18-6275-1	893929A01	18-6751	381
806189A1	18-6114	872	50-863007A1	18-6275	S/S to 18-6275-1	99660A1	18-6751	381
806189Q1	18-6114	872	50-864340A2	18-6275	S/S to 18-6275-1	14336A15	18-6752	719
806189T1	18-6114	872	50-99418A2	18-6275	S/S to 18-6275-1	14336A17	18-6752	719
97-806188A1	18-6117A	871	50-8329972	18-6282	391	14336A22	18-6752	719
97-806188Q01	18-6117A	871	50-8331535	18-6283	391	14336A28	18-6752	719
97-806188A1	18-6117M	871	862031T	18-6293	721	14336A6	18-6752	719
97-806188Q01	18-6117M	871	862031T1	18-6293	721	14336A9	18-6752	719
97-806188A1	18-6117Z	871	863077T	18-6298	721	88183A11	18-6752	719
97-806188Q01	18-6117Z	871	43-821823A1	18-6350	Obsolete	88183A12	18-6752	719
888756A2	18-6150A	872	43-853640A2	18-6350	Obsolete	88183A6	18-6752	719
888756Q02	18-6150A	872	43-803104T1	18-6350K	Obsolete	96477A3	18-6752	719
888756Q4	18-6150A	872	43-853641A2	18-6351	847	14336A9	18-6753	719
888756A2	18-6150M	872	43-803103T1	18-6351K	846	88183A12	18-6753	719
888756Q02	18-6150M	872	43-853642A2	18-6352	847	67914A2	18-6763	720
888756Q4	18-6150M	872	43-803106T1	18-6352K	846	79271A4	18-6763	720
888756A2	18-6150Z	872	43-853643A2	18-6353	847	92975A28	18-6763	720
888756Q02	18-6150Z	872	43-803105T1	18-6353K	846	92975A32	18-6763	382
888756Q4	18-6150Z	872	12784	18-6400	848	92975A6	18-6763	720
8M0058677	18-6157A	458	12784T	18-6400	848	823653A5	18-6765	382
888756Q01	18-6158A	871	12784A10	18-6401	848	823653A9	18-6765	382
97-888756Q03	18-6158A	871	12784A4	18-6401	848	92459A4	18-6765	382
888755A1	18-6158M	871	865503T	18-6404	848	392-8261A1	18-6768	720
888755Q01	18-6158M	871	865493A01	18-6406	849	392-8263	18-6768	720
97-888755Q03	18-6158M	871	865496A01	18-6406	849	74436A9	18-6768	720
888758A1	18-6159A	871	865496A01	18-6406	849	79271A4	18-6768	720
888758Q01	18-6159A	871	865510T	18-6406	849	88475A4	18-6768	720
97-888758Q03	18-6159A	871	865511T	18-6406	849	93247A7	18-6768	720
888757Q01	18-6159M	871	50-804312T1	18-6425	390	993247A4	18-6768	720
888759A1	18-6159M	871	50-859377T	18-6435	390	14336A8	18-6769-1	720
97-888759Q03	18-6159M	871	50-884044T	18-6435	390	88183A5	18-6769-1	720
888761A1	18-6160A	871	50-888161T	18-6435	390	17646	18-6771	381, 720
888761Q01	18-6160A	871	50-834749	18-6436	390	18525	18-6771	381, 720
97-888761Q03	18-6160A	871	50-859171T	18-6436	390	18525A1	18-6771	381, 720
888760A1	18-6160M	871	50-830308T	18-6437	390	17649	18-6772	720
888760Q01	18-6160M	871	50-859169T	18-6437	390	17649T	18-6772	720
97-888760Q03	18-6160M	871	50-888151T	18-6437	390	891736T	18-6772	720
821630	18-6240	872	50-854636T	18-6438	390	828708	18-6773	382
821630A1	18-6240	872	50-859170T	18-6438	390	878265A4	18-6773	382
821630Q1	18-6240	872	50-884045T	18-6438	390	811628	18-6774	382
821630T1	18-6240	872	50-888160T	18-6438	390	828708A1	18-6774	382
31640	18-6241	458, 871	50-853329T	18-6440	391	878265A6	18-6774	382
31640A1	18-6241	458, 871	50-892339T	18-6440	391	811673 1	18-6775	382
31640Q4	18-6241	458, 871	834832	18-6454	390	19217A1	18-6777	382
31640T6	18-6241	458, 871	857006T	18-6454	390	19217A5	18-6777	382
55989A3	18-6242-9	871	875285T1	18-6454	390	818903A1	18-6777	382
55989Q9	18-6242-9	871	881248T	18-6454	390	819479A1	18-6777	382
55989T9	18-6242-9	871	889955A03	18-6454	390	819480A1	18-6777	382
43994A2	18-6243	871	8M0064021	18-6454	390	819762A4-A7	18-6777	382

Mercury Marine (Cont.)			Mercury Marine (Cont.)			Mercury Marine (Cont.)		
O.E. #	SIERRA #	PAGE #	O.E. #	SIERRA #	PAGE #	O.E. #	SIERRA #	PAGE #
81977A8-A9	18-6777	382	32-96879	18-70931	772	25-20365	18-7135	467, 876
822870A1	18-6777	382	32-87117	18-70932	772	25-35276	18-7135	467, 876
830250A3	18-6777	382	32-871171	18-70932	772	25-65936	18-7143	467, 876
830250T3	18-6777	382	32-897181	18-70934	771	27-58025	18-7143	467, 876
832021A1	18-6777	382	32-806856	18-70935	771	391-5081	18-7143	467, 876
832021A2	18-6777	382	32-8066351	18-70938	771	25-64068	18-7145	467, 876
832021T2	18-6777	382	32-8066361	18-70939	771	25-47632	18-7146	467, 876
832021T4	18-6777	382	32-860144	18-70940	771	25-20081	18-7151	467, 876
854472A2	18-6777	382	32-897491	18-70943	771	25-39572	18-7151	467, 876
854472A3	18-6777	382	32-862139	18-70945	770	25-20863	18-7152	467, 876
854472A4	18-6777	382	32-8066362	18-70946	771	25-20679	18-7153	467, 876
855654A1	18-6777	382	32-862124	18-70947	770	25-25439	18-7153	467, 876
855654T2	18-6777	382	32-808033	18-70948	770	25-F53795-1	18-7153	467, 876
883166A1	18-6778	720	32-807407	18-70949	770	F53795	18-7153	467, 876
883166A2	18-6778	720	1397-7539	18-7095	738	25-26855	18-7155	467, 876
392-8261A1	18-6799	720	1397-7540	18-7095	738	25-29439	18-7156	467, 876
392-8263	18-6799	720	1397-7544	18-7095	738	25-29976	18-7157	467, 876
74436A9	18-6799	720	1397-8535	18-7095	738	25-30613	18-7158	467, 876
79271A4	18-6799	720	1397-9723	18-7095	738	25-846357	18-7158	467, 876
88475A4	18-6799	720	32-8078961	18-70951	770	25-31534	18-7159	467, 876
93247A4	18-6799	720	32-8078962	18-70951	770	25-48451	18-7159	467, 876
93247A7	18-6799	720	32-860205	18-70951	770	25-31986	18-7160	467, 876
1395-6200	18-7004	395	32-887952	18-70952	770	25-32546	18-7161	467, 876
1395-6452	18-7005	395	32-8080441	18-70953	770	25-32424	18-7162	467, 876
879194024	18-7006-1	395	32-860089	18-70954	770	25-33145	18-7162	467, 876
1395-4808	18-7006-1	395	32-8600891	18-70954	770	25-33465	18-7163	467, 876
1395-879194024	18-7006-1	395	32-16011	18-70955	770	25-807149	18-7163	467, 876
1399-1717	18-7006-1	395	32-16012	18-70956	770	25-853220	18-7163	467, 876
1399-2015	18-7006-1	395	32-96246	18-70958	771	25-33466	18-7164	467, 876
1399-3523	18-7006-1	395	32-96246A1	18-70958	771	25-33466	18-7164	467, 876
1399-5135	18-7007	395	32-96246A4	18-70958	771	25-67675	18-7164	467, 876
1399-5198	18-7007	395	1356-4066	18-7096	738	25-846356	18-7164	467, 876
1395-9258	18-7057	396	1356-4092	18-7096	738	25-32509	18-7165	467, 876
1395-9258 1	18-7057	396	1356-5155	18-7096	738	25-806609	18-7165	467, 876
1399-1138	18-7057	396	1356-5169	18-7096	738	25-F461342	18-7165	467, 876
1399-1473	18-7057	396	1396-5222	18-7096	738	25-45254	18-7166	467, 876
1395-8318	18-7061	396	1396-5238	18-7096	738	25-861844	18-7167	467, 876
1395-83181	18-7061	396	3302-804845	18-7097	738	25-20587	18-7168	467, 876
1395-95951	18-7062	396	3302-9437	18-7097	738	25-21720	18-7168	467, 876
1397-2072	18-7070	737	3302-804844	18-7098-1	738	25-26834	18-7168	467, 876
1397-2637	18-7070	737	3302-804844001	18-7098-1	738	25-48171	18-7168	467, 876
1397-3464	18-7070	737	3302-804844002	18-7098-1	738	25-801334436	18-7168	467, 876
1397-7542	18-7070	737	25-85594	18-7100	467	25-35984	18-7169	467, 876
1397-7543	18-7070	737	25-62706	18-7102	467	25-70937	18-7169	467, 876
1397-8872	18-7070	737	25-29845	18-7103	467, 872, 876	25-33504	18-7170	467, 876
32-89653	18-70704	737	54-32533	18-71048-2	855	25-30529	18-7171	467, 876
1397-3458	18-7071	737	54-815504348	18-71048-2	855	25-31305	18-7172	467, 876
1397-3306	18-7072	738	25-62705	18-7105	467, 876	25-27018	18-7173	467, 876
1397-4329	18-7072	738	25-F7848342	18-7105	467, 876	25-30224	18-7173	467, 876
1397-5635	18-7072	738	25-67202	18-7107	467, 876	25-45711	18-7174	467, 876
1397-6638	18-7072	738	54-31765	18-7107-2	855	25-F455342	18-7174	876
823426A1	18-7072	738	25-897536	18-7113-9	408	25-62817	18-7175	467, 876
1397-5830	18-7075	737	25-98277	18-7113-9	408	25-896523	18-7176	467, 876
1397-5931	18-7075	737	25-23145	18-7114	467, 876	25-F74305	18-7176	467, 876
1397-7099	18-7075	737	25-843315	18-7114	467, 876	F694555	18-7176	467, 876
1397-8760	18-7075	737	25-F702736	18-7114	467, 876	F74305	18-7176	467, 876
1397-6367	18-7076	738	25-26722	18-7115	467, 876	F74305-1	18-7176	467, 876
1397-6367A1	18-7076	738	802206	18-7116	467, 876	25-53421	18-7177	467, 877
1397-8952	18-7077	738	25-20633	18-7116	467, 876	25-59712	18-7177	467, 877
823426A1	18-7077	738	25-22174	18-7116	467, 876	12-31060	18-7180	467, 877
1337-2103	18-7078	738	25-62704	18-7116	467, 876	25-26802	18-7180	467, 877
1337-2604	18-7078	738	25-85148	18-7116	467, 876	25-8M2000926	18-7180	467, 877
1397-2133	18-7078	738	25-F24342	18-7116	467, 876	25-805726	18-7188	467, 877
1397-2605	18-7078	738	25-35027	18-7117	467, 876	25-8M0027717	18-7195	467, 877
1397-3462	18-7078	738	25-38933	18-7120	467, 876	25-45710	18-7198	467, 877
1346-2770	18-7080	738	802231	18-7121	467, 876	1397-2060	18-7200	739
1398-3089	18-7080	738	25-35029	18-7121	467, 876	1395-9594	18-72000	396
1396-4656	18-7081	738	25-882613	18-7121	467, 876	1397-3327	18-7201	739
32-16021	18-70925	772	32-48131	18-71218	773	1397-8546	18-7201	739
32-160211	18-70925	772	32-48132	18-71218	773	1397-8959	18-7201	739
32-87116	18-70925	772	25-32507	18-7127	876	1397-5837	18-7202	739
32-73796	18-70926	772	25-F84305	18-7127	876	3302-9031	18-7202	739
32-73795	18-70927	772	32-806825	18-71337	773	1395-8673	18-7208	396
32-71613	18-70928	772	32-861590A05	18-71337	773	1395-8983	18-7208	396
32-73794	18-70929	772	32-861590A1	18-71337	773	1395-9293	18-7209	396
32-52481	18-70930	772	32-861590A2	18-71337	773	1395-8112231	18-7211-1	395
32-47640	18-70931	772	25-20195	18-7134	876	1395-811357	18-7212	395
32-8M0071007	18-70931	772	25-201951	18-7134	876	1395-9179	18-7212	395

Mercury Marine (Cont.)			Mercury Marine (Cont.)			Mercury Marine (Cont.)		
O.E. #	SIERRA #	PAGE #	O.E. #	SIERRA #	PAGE #	O.E. #	SIERRA #	PAGE #
1395-9377	18-7212	395	25-35480	18-7411	467, 877	96863A15	18-7633	868
1395-9645	18-7212	395	25-47386	18-7411	467, 877	3310-864943A01	18-7639	171, 732
1395-9725	18-7212	395	25-8M2000816	18-7411	467, 877	861245A1	18-7639	171, 732
1395-9761	18-7212	395	22-22175	18-7413	467, 877	892615	18-7646	728
1395-97611	18-7212	395	25-62702	18-7413	467, 877	892615001	18-7646	728
1395-9803	18-7212	395	25-F50342-1	18-7413	467, 877	892615002	18-7646	728
8107492	18-7213	395	F17510	18-7413	467, 877	392-881732	18-7648	698
8107493	18-7214	395	F50342	18-7413	467, 877	881731	18-7660	727
1395-9024	18-7215	395	25-62384	18-7414	467, 877	8M0054726	18-7660	727
1395-9650	18-7226	395	25-823683	18-7414	467, 877	802630	18-7663	727
1396-4148	18-7227	739	25-64966	18-7415	Obsolete	802630001	18-7663	727
85784A1	18-7228	742	25-69202	18-7419	467, 877	802630T	18-7663	727
85785-2	18-7229	742	25-21836	18-7420	467, 877	802630T01	18-7663	727
85785T	18-7229	742	25-16524	18-7421	467, 877	8M0069803	18-7663	727
41639	18-7230	742	25-30271	18-7426	467, 877	809066	18-7664	739
41639A1	18-7230	742	25-36318	18-7440-1	467, 877	70125	18-7665	739
85785A2	18-7231	742	25-55801	18-7445	Obsolete	70125A02	18-7665	739
57882	18-7232	664, 742	25-97387	18-7449	467, 877	70125A1	18-7665	739
57882T	18-7232	664, 742	20311	18-7459	467, 877	1397-8582	18-7666	739
1395-7824	18-7233	396	25-20826	18-7459	467, 877	71464	18-7667	739
805016A1	18-7234	742	25-39695	18-7464	467, 877	72625	18-7667	739
19273	18-7249	396	25-846361	18-7464	467, 877	71464A01	18-7667	739
32722	18-7256	167, 743	25-54030	18-7467	467, 877	854445	18-7668	728
54552	18-7267	167, 743	25-F523555	18-7467	467, 877	806612T	18-7677	728
62092	18-7267	167, 743	F532555	18-7467	467, 877	849934	18-7682	727
62092	18-7267	167, 743	25-94288	18-7474	467, 877	879150150	18-7682	727
62092T	18-7267	167, 743	392889925	18-7493	678	849899	18-7683	727
71646	18-7274	167, 743	16792A33	18-7508	809	805217A1	18-7684	727
78485	18-7274	167, 743	16792A39	18-7508	809	864856A1	18-7684	727
86246	18-7274	167, 743	32-8M0062614	18-75100	773	852956A1	18-7685	728
86246A1	18-7274	167, 743	32-5346170	18-75125	773	885176	18-7688	738
86246T	18-7274	167	32-865672070	18-75125	773	27-852957	18-7690	729
46860	18-7275	167, 743	32-8M0062665	18-75125	773	806807A1	18-7691	Obsolete
63196	18-7275	167, 743	805218T	18-7600	727	861260	18-7692	729
78820	18-7275	167, 743	1347-818622	18-7603-1	171, 732	861260T	18-7692	729
86247	18-7275	167, 743	1347-818622 1	18-7603-1	171, 732	803149	18-7697	727
86247A2	18-7275	167, 743	1347-818622R02	18-7603-1	171, 732	881693002	18-7698	Obsolete
86247T	18-7275	167, 743	1376-5659A1	18-7603-1	171, 732	853678T	18-7700	727
47585	18-7278	167, 743	1347-804623R02	18-7604-1	171, 732	862998	18-7701	727
71327	18-7278	167, 743	1347-804623R1	18-7604-1	732	805223T	18-7702	769
77594	18-7278	167, 743	3304-9354A2	18-7604-1	171, 732	805544T	18-7703	728
86234	18-7278	167, 743	1347-804623A1	18-7605-1	171, 732	35-16248	18-7712	407
86234A05	18-7278	167, 743	1347-804623R02	18-7605-1	171, 732	35-80365M	18-7713	407
86234A3	18-7278	167, 743	1347-9661A3	18-7605-1	171, 732	35-877565T	18-7714	407
86234A4	18-7278	167, 743	1347-818620	18-7608-1	171, 732	35-877565T1	18-7714	407
42725A3	18-7282	167, 743	1347-818620 1	18-7608-1	171, 732	35-892665	18-7715	751
861676T09	18-7282	167, 743	1347-818620R02	18-7608-1	171, 732	35-93568	18-7717	751
97401	18-7283	167, 743	1347-818619	18-7609-1	171, 732	35-879885T	18-7718	407
861678A1	18-7283	167, 743	1347-818619 1	18-7609-1	171, 732	35-864572	18-7721	751
861678A1	18-7283	167, 743	1347-818619 1R02	18-7609-1	171, 732	802706A1	18-7738	395
8M0059164	18-7283	167, 743	1347-818621	18-7610-1	171, 732	804346T1	18-7743	395
97401A2	18-7283	167, 743	1347-818621 1	18-7610-1	171, 732	1397-2067	18-7746	738
97401A8	18-7283	167, 743	1347-818621 1R02	18-7610-1	171, 732	1397-2631	18-7746	738
41141A2	18-7284	167, 743	3310-807312R02	18-7611-2	171, 732	1397-2634	18-7746	738
862077A1	18-7284	167, 743	3310-807312A1	18-7611-2	171, 732	1397-2637	18-7746	738
97399	18-7288-1	168, 743	3310-806969 R01	18-7613-1	171, 732	1397-3459	18-7746	738
812454A1	18-7288-1	168, 743	3310-806969A1	18-7613-1	171, 732	1397-3464	18-7746	738
812454A3	18-7288-1	168, 743	1347-804624 R02	18-7615-1	171, 732	1397-7542	18-7746	738
862048A1	18-7288-1	168, 743	1347-804624R1	18-7615-1	171, 732	1397-7543	18-7746	738
97399A2	18-7288-1	168, 743	1347-816373A4	18-7615-1	171, 732	1397-7547	18-7746	738
84419M	18-7290	395	1347-804626 R02	18-7616-1	171, 733	1397-8872	18-7746	738
84475M	18-7291	395	1347-8288A1	18-7616-1	171, 733	1397-8873	18-7746	738
92520M	18-7293	395	1347-804625R02	18-7617-1	171, 733	823427A1	18-7746	738
1395-9022	18-7295	396	1347-804625R1	18-7617-1	171, 733	809064	18-7748	738
54-38863	18-7321	853	1347-9863A3	18-7617-1	171, 733	809065	18-7749	738
54-866507	18-7321	853	1347-804624 R1	18-7618-1	171, 733	823728	18-7749	738
54-8M0090424	18-7321	853	1347-804624R02	18-7618-1	171, 733	835076	18-7749	738
805025A2	18-7326	168, 743	1347-8289A1	18-7618-1	171, 733	1395-811222	18-7750-1	396
805656A2	18-7326	168, 743	1347-8460A3	18-7619-1	176, 733	1395-823635	18-7750-1	396
805656A5	18-7326	168, 743	1347-9142A2	18-7619-1	176, 733	1395-8236351	18-7750-1	396
805656A6	18-7326	168, 743	805226A1	18-7630	727	1395-8236352	18-7750-1	396
861155A5	18-7326	168, 743	805224A1	18-7632-1	727	1395-8236353	18-7750-1	396
861155A6	18-7326	168, 743	17693A2	18-7633	868	1395-8236354	18-7750-1	396
1395-8506	18-7354	395	63115A12	18-7633	868	1395-9599	18-7750-1	396
1395-811691 2	18-7355	395	805320A03	18-7633	868	803148	18-7757	738
1395-811691 3	18-7356	395	805320A1	18-7633	868	35-877761K01	18-7758	201, 429
25-818573	18-7400	435	86678A4	18-7633	868	35-877761Q01	18-7758	201, 429
25-36390	18-7410	467, 877	88678A5	18-7633	868	11502M	18-7765	396

Mercury Marine (Cont.)			Mercury Marine (Cont.)			Mercury Marine (Cont.)		
O.E. #	SIERRA #	PAGE #	O.E. #	SIERRA #	PAGE #	O.E. #	SIERRA #	PAGE #
814481M	18-7769	396	35-55501A1	18-7848-1	153, 405, 749	35-57250	18-7945	153, 407, 750
84456M	18-7770	396	35-57250A1	18-7848-1	153, 405, 749	35-60494	18-7945	153, 407, 750
35-11004A1	18-7784	751	35-60494A1	18-7848-1	153, 405, 749	35-604941	18-7945	153, 407, 750
35-803897Q1	18-7784	751	35-60494A4	18-7848-1	153, 405, 749	35-802893Q	18-7945	153, 407, 750
35-87946A3	18-7802	407	35-802893Q4	18-7848-1	153, 405, 749	35-805369	18-7945	153, 407, 750
35-87946Q3	18-7802	407	35-805369A4	18-7848-1	153, 405, 749	35-8053691	18-7945	153, 407, 750
35-87946Q4	18-7802	407	35-807172A4	18-7848-1	153, 405, 749	35-806771	18-7945	153, 407, 750
23014A1	18-7804	400	55481	18-7853-1	153, 405, 748	35-807172	18-7945	153, 407, 750
55278A1	18-7807	400	89876	18-7853-1	153, 405, 748	35-886638	18-7948	157, 407, 750
55278A5	18-7808	400	89876A3	18-7853-1	153, 405, 748	25-85549	18-7956	257
55278A3	18-7809	400	1397-2150	18-7855	751	25-47254	18-7961	467, 877
55278A4	18-7809	400	3302-9033	18-7859	751	25-861844	18-7961	467, 877
90363A1	18-7810	400	35-53336	18-7859	751	785-97386	18-7961	877
66599A1	18-7811	400	35-53336Q	18-7859	751	879194241	18-7964-1	751
89031A1	18-7811	400	35-49088	18-7860	751	35-813405	18-7964-1	751
66599A2	18-7812	400	35-49088A2	18-7860	751	35-813405A1	18-7964-1	751
89031A2	18-7812	400	35-49088Q2	18-7860	751	35-815419	18-7964-1	751
66599A3	18-7813	400	F18390006	18-7860	751	FFF001138	18-7964-1	751
89031A3	18-7813	400	1397-8545	18-7869	751	F19608751	18-7964-1	751
89031A4	18-7814	400	1397-8767	18-7869	751	35-14571A1	18-7967	153, 407
1399-5137	18-7815	396	35-805809	18-7871	200, 690, 808	35-17808A1	18-7967	153, 407
21-42990A10	18-7817	400	35-805809T	18-7871	808	35-18458A2	18-7967	153, 407
21-42990A7	18-7817	400	35-808275	18-7873	157, 688, 751	35-18458A3	18-7967	153, 407
21-42990A8	18-7817	400	60565	18-7875	201, 808	35-18458Q3	18-7967	153, 407
21-42990A9	18-7817	400	35-802886Q	18-7875	201, 808	35-184585	18-7968	153, 407
21-857005A1	18-7817	400	14957	18-7876-1	201, 808	35-18458Q4	18-7968	153, 407
42909A1	18-7818-1	400	32716	18-7876-1	201, 808	35-866171A01	18-7977	751
42909A2	18-7818-1	400	32717	18-7876-1	201, 808	881540	18-7979	407
42909A3	18-7818-1	400	52022	18-7876-1	201, 808	35-884380T	18-7981	407
42909A4	18-7818-1	400	52731	18-7876-1	201, 808	35-8M0020349	18-7981	407
14957	18-7824-2	201, 708	54111	18-7876-1	201, 808	35-52456A1	18-7983-1	153, 153, 405, 749
32716	18-7824-2	201, 792	32-802885Q	18-7876-1	201, 808	35-55501A1	18-7983-1	153, 153, 405, 749
32717	18-7824-2	201, 792	35-866340Q02	18-7876-1	201, 808	35-57250A1	18-7983-1	153, 153, 405, 749
52022	18-7824-2	201, 792	35-866340Q03	18-7876-1	201, 808	35-60494A1	18-7983-1	153, 153, 405, 749
52731	18-7824-2	201, 792	52731A1	18-7876-1	201, 808	35-60494A4	18-7983-1	153, 153, 405, 749
54111	18-7824-2	201, 792	38463	18-7878-1	201, 808	35-802893A4	18-7983-1	153, 153, 405, 749
35-802885Q	18-7824-2	201, 792	46692	18-7878-1	201, 808	35-802893Q4	18-7983-1	153, 153, 405, 749
35-866340K01	18-7824-2	201, 792	803470	18-7878-1	201, 808	35-807172A4	18-7983-1	153, 153, 405, 749
35-866340Q	18-7824-2	201, 792	803470Q	18-7878-1	201, 808	35-853333	18-7997	408
35-866340Q02	18-7824-2	201, 792	41815	18-7879-1	201, 808	35-853333T	18-7997	408
35-866340Q02	18-7824-2	201, 792	32-883702K	18-7879-1	201, 808	35-896247	18-7999	408
35-866340Q03	18-7824-2	201, 792	32-883702Q	18-7879-1	201, 808	89396A38	18-8004EP-1	158, 164, 403
52731A1	18-7824-2	201, 792	35-802884Q	18-7879-1	201, 808	89396Q38	18-8004EP-1	158, 164, 403
35-16494	18-7829	158, 408	825467A1	18-7901	201, 429	89396A38	18-8004S	158, 164, 403
35-816296	18-7829	158, 408	825467T1	18-7901	201	89396Q38	18-8004S	158, 164, 403
35-816296K03	18-7829	158, 408	35-8226267	18-7906-1	202, 429	13330A3	18-8005EP-1	158, 164, 403
35-816296Q	18-7829	158, 408	35-822626Q15	18-7906-1	202, 429	13330A3	18-8005S	158, 164, 403
35-816296T	18-7829	408	35-822626T7	18-7906-1	202, 429	13330Q	18-8005S	158, 164, 403
35-134301	18-7830	158, 408	35-822626Q03	18-7913	202, 429	32-858114K08	18-8012EP-2	160, 402
35-164941	18-7830	X	35-822626Q1	18-7913	202, 429	32-858114Q08	18-8012EP-2	160, 402
35-8162961	18-7830	158, 408	35-822626K04	18-7914	202, 429	32-858109K12	18-8016EP-2	161, 403
35-816296-1	18-7830	408	35-822626Q04	18-7914	202, 429	32-858109Q12	18-8016EP-2	161, 403
35-816296B1	18-7830	158, 408	35-822626Q2	18-7914	202, 429	32-858109K12	18-8016S-1	165
35-816296B2	18-7830	158, 408	35-822626T2	18-7914	202, 429	54-41582-7	18-8020	163
35-816296Q2	18-7830	158, 408	35-877768K01	18-7914	202, 429	32-858104K08	18-8024EP-2	161, 402
35-816296T1	18-7830	158, 408	35-8M0008397	18-7914	202, 429	32-858104Q08	18-8024EP-2	161, 402
35-816396Q1	18-7830	158, 408	35-8M0064104	18-7914	202, 429	32-858105K08	18-8025EP-2	161, 403
802128A1	18-7831	158, 408	35-877769K01	18-7918	202, 429	32-858105Q08	18-8025EP-2	161, 403
1399-1136	18-7832	407	35-883701K01	18-7918	202, 429	22-13563T3	18-80410-1	404
1399-1754	18-7832	407	35-809097	18-7919	154, 407, 750, 751	22-816856T2	18-80412	404
1399-3938	18-7832	407	35-8M0103095	18-7919	154, 407, 750, 751	22-63186	18-8054	163, 403
11497M	18-7833	400	35-809099	18-7920	155, 407, 750	22-63187	18-8055	163, 403
91748M	18-7834	400	35-877767K01	18-7921	202, 429	22831A1	18-8069	404
84262M	18-7837	400	35-896546T	18-7921	202, 429	22831A3	18-8069	404
84265M	18-7838	400	35-809100	18-7929	154	22831A4	18-8069	404
80606M	18-7839	400	35-888289T2	18-7936	407	22831B3	18-8069	404
84141M	18-7840	400	35-52456	18-7944	153, 407, 750	22831Q3	18-8069	404
35-802893Q	18-7844	153, 407, 750	35-55501	18-7944	153, 407, 750	29196	18-8070	404
35-807172	18-7844	153, 407, 750	35-57250	18-7944	153, 407, 750	16610M	18-8070	404
35-55501	18-7845	153, 407, 750	35-60494	18-7944	153, 407, 750	30185A1	18-8070	404
35-57250	18-7845	153, 407, 750	35-604941	18-7944	153, 407, 750	30185A3	18-8070	404
35-604941	18-7845	153, 407, 750	35-802893Q	18-7944	153, 407, 750	30185B3	18-8070	404
35-60494A4	18-7845	153, 407, 750	35-805369	18-7944	153, 407, 750	30185Q3	18-8070	404
35-8053691	18-7845	153, 407, 750	35-8053691	18-7944	153, 407, 750	22-14213M	18-8075	404
35-806771	18-7845	153, 407, 750	35-806771	18-7944	153, 407, 750	22-14213Q	18-8075	404
35-807172	18-7845	153, 407, 750	35-807172	18-7944	153, 407, 750	22-81042M	18-8075	404
52444	18-7848-1	153, 405, 749	35-52456	18-7945	153, 407, 750	22-13563A3	18-8076	404
35-52456A1	18-7848-1	153, 405, 749	35-55501	18-7945	153, 407, 750	22-13563Q3	18-8076	404

Mercury Marine (Cont.)			Mercury Marine (Cont.)			Mercury Marine (Cont.)		
O.E. #	SIERRA #	PAGE #	O.E. #	SIERRA #	PAGE #	O.E. #	SIERRA #	PAGE #
29196	18-8084	404	84-816761Q4	18-8821-1	190-199,711	92-802836A1	18-9420-7	206
22-16610M	18-8084	404	84-816608A81	18-8822-1	190-199,711	92-8M0078625	18-9420CAT-2	209
30185A1	18-8084	404	84-816608Q81	18-8822-1	190-199,711	92-8M0078625	18-9420CAT-2P	209
30185A3	18-8084	404	84-816608Q78	18-8824-1	191, 192-194,	92-8M0078626	18-9420CAT-3	209
30185B3	18-8084	404			197, 580, 962, 965, 966	92-8M0078626	18-9420CAT-3P	209
30185Q3	18-8084	404	84-863656A1	18-8828-1	190-199,711	92-8M0078618	18-9420CAT-7	209
22-13563A6	18-8091	404	84-863656A2	18-8829-1	190-199,711	92-8M0078618	18-9420CAT-7P	209
22-13563A7	18-8091	404	84-816608Q80	18-8830-1	190-199,711	92-883724K01	18-9440-2	206
22-13563Q7	18-8091	404	84-816608A68	18-8832-1	190-199,711	92-883724K01	18-9440-2P	206
22-13563T7	18-8091	404	84-816608K68	18-8832-1	190-199,711	92-883723K01	18-9440-3	207
22-36392	18-8111	798	84-816608Q68	18-8832-1	190-199,711	92-883725K01	18-9440-4	206
30-803098T1	18-8205	851	84-816608A14	18-8833-1	190-199,711	92-883725K01	18-9440-4P	206
30-803099T1	18-8206-1	851	84-816608Q14	18-8833-1	190-199,711	92-858057K01	18-9440-7	206
31-803090T1	18-8208	873	84-816761K14	18-8833-1	190-199,711	92-883722K01	18-9440-8	207
30-803100T1	18-8212-1	851	84-816608A83	18-8834-1	190-199,711	92-8M0078629	18-9440CAT-2	210
8M0095485	18-8212-1	851	84-816608Q83	18-8834-1	190-199,711	92-8M0078629	18-9440CAT-2P	210
22-36305	18-8216	793	84-816608Q22	18-8835-1	190-199,711	92-8M0078624	18-9440CAT-7	210
22-36305T	18-8216	801	84-816608A71	18-8836-1	190-199,711	92-8M0078624	18-9440CAT-7P	210
88-79023A91	18-8220	722	84-816608Q71	18-8836-1	190-199,711	92-858037K01	18-9530-3	204
73873	18-8227	809	84-847701A7	18-8837-1	190-199,711	92-858039K01	18-9530-7	204
73873A1	18-8227	809	84-847701Q7	18-8837-1	190-199,711	92-858084K01	18-9552-3	205
861578	18-8297	809	84-881698	18-8838-1	190-199,711	92-858042K01	18-9553-3	205
42838	18-8305	431	861677T	18-8860	743	92-858042Q01	18-9553-3	205
69668	18-8305	431	861156A02	18-8861	Obsolete	92-802844Q02	18-9600-0	214
88726	18-8305	431	861156A03	18-8862	Obsolete	92-858058Q01	18-9600-2	214
428381	18-8305	431	866169A01	18-8864	742	92-858058Q01	18-9600-2P	214
26-814754	18-8305	431	866169T01	18-8864	742	92-858007Q01	18-9600-5	214
26-30696	18-8308	460, 464	866170A01	18-8865	742	92-858007Q01	18-9600-5P	214
18717	18-8309	443	892874T01	18-8866	400	92-858061Q01	18-9600-6	214
26-30900	18-8310	460, 464	899106T01	18-8866	400	92-858062Q01	18-9600-7	214
26-76384	18-8347	464	805025A2	18-8867	Obsolete	92-858062Q01	18-9600-7P	214
26-816464	18-8347	464	805656A2	18-8867	Obsolete	92-858064Q01	18-9650-2	214
26-8164641	18-8347	464	805656A5	18-8867	Obsolete	92-858064Q01	18-9650-2P	214
26-816575A4	18-8382	462	805656A6	18-8867	Obsolete	91-8M0101435	18-9650-2QP	214, 218
10-8053432	18-8402	718	861155A5	18-8867	Obsolete	92-858008Q01	18-9650-5	214
10-8053432	18-8402-1	718	861155A6	18-8867	Obsolete	92-858008Q01	18-9650-5P	214
10-8083434	18-8404-1	718	861155A2	18-8868	Obsolete	92-858067Q01	18-9650-6	214
10-43749	18-8410	798	861155A3	18-8868	Obsolete	92-858067Q01	18-9650-6P	214
10-44387	18-8411	798	47-19453	18-8900	248, 411	92-858068Q01	18-9650-7	214
84-43376A7	18-8800-1	190-199,711	92-78383A12	18-9013	216	92-858068Q01	18-9650-7P	214
84-813720A5	18-8800-1	190-199,711	92-817529A12	18-9013	216	91-850730Q01	18-9781	218
84-816761A7	18-8800-1	190-199,711	92-78383A12	18-9024	216	91-8M0072133	18-9781	218
84-816761Q5	18-8800-1	190-199,711	92-817529A12	18-9024	216	91-74057Q6	18-9782	218
84-813720A7	18-8801-1	190-199,711	92-78383A12	18-9065	216	91-74057Q6	18-9783	218
84-816761Q7	18-8801-1	190-199,711	92-817529A12	18-9065	216	91-30500	18-9785	219
84-43376A12	18-8802-1	190-199,711	23-888690	18-9075	458	91-883704Q03	18-9794	218
84-813720A12	18-8802-1	190-199,711	23-888690-1	18-9076	458	91-99750A1	18-9801	227, 383
84-816761A12	18-8802-1	190-199,711	13-888363-2	18-9077	458	91-99750A1	18-9801	227, 383
84-816761Q12	18-8802-1	190-199,711	12-855682-2	18-9078	458	91-99379	18-9802	383
84-43376A9	18-8803-2	190-199,711	92-78383A12	18-9080	216	91-17256	18-9803	224, 858
84-813720A10	18-8803-2	190-199,711	92-817529A12	18-9080	216	91-36235	18-9803	858
84-813720A9	18-8803-2	190-199,711	86459	18-9099	868	12-34961	18-9805	225
84-816761A9	18-8803-2	190-199,711	879078	18-9099	868	91-12037	18-9806E	223
84-816761Q10	18-8803-2	190-199,711	32657A3	18-9099	868	91-12427	18-9807	224
84-816761Q9	18-8803-2	190-199,711	32657A4	18-9099	868	91-12427T	18-9807	224
84-813720A2	18-8804-1	190-199,711	41155A1	18-9099	868	91-15755	18-9808	224
84-813720A3	18-8804-1	190-199,711	41155A2	18-9099	868	91-15755T	18-9808	224
84-813720A4	18-8804-1	190-199,711	817019A1	18-9099	868	91-31109	18-9808	224
84-816608Q61	18-8804-1	190-199,711	817019A2	18-9099	868	91-37263	18-9808	224
84-816761A4	18-8804-1	190-199,711	817019Q2	18-9099	868	91-17257	18-9809	224
84-816761Q3	18-8804-1	190-199,711	86459A1	18-9099	868	91-17262A1	18-9810	224
84-816761Q4	18-8804-1	190-199,711	86459A2	18-9099	868	91-17275A1	18-9812	224
84-813720A6	18-8808-2	190-199,711	92-8M0071838	18-9200-0	215	91-29310	18-9814	224
84-816761Q6	18-8808-2	190-199,711	92-8M0071841	18-9200-1	215	91-37324	18-9815	230
84-43376A8	18-8809-1	190-199,711	92-8M0071837	18-9200-2	215	91-30366T1	18-9816	230
84-813720A8	18-8809-1	190-199,711	92-8M0071837	18-9200-4	215	91-23033	18-9817	224
84-816761A8	18-8809-1	190-199,711	59829A1	18-9218	848	91-23033T	18-9817	224
84-816761Q8	18-8809-1	190-199,711	59830A5	18-9218	848	91-24150	18-9817	224
84-813720A11	18-8810-1	190-199,711	814819A2	18-9218	848	91-31107	18-9817	224
84-816761Q16	18-8810-1	190-199,711	92-802837Q1	18-9400-2	206	91-31107T	18-9817	224
84-813720A13	18-8811-1	190-199,711	92-857389A1	18-9400-4	206	91-31229	18-9819	230
84-816761Q13	18-8811-1	190-199,711	92-802841A1	18-9400-7	206	91-31229A7	18-9820-1	225
84-813720A3	18-8821-1	190-199,711	92-8M0078627	18-9400CAT-2	209	91-32325	18-9821	224
84-813720A4	18-8821-1	190-199,711	92-8M0078627	18-9400CAT-2P	209	91-32325T	18-9821	224
84-816761A17	18-8821-1	190-199,711	92-8M0078621	18-9400CAT-7	209	91-32336	18-9822	225
84-816761A4	18-8821-1	190-199,711	92-8M0078621	18-9400CAT-7P	209	91-33489	18-9823	224
84-816761Q17	18-8821-1	190-199,711	92-802833Q1	18-9420-2	206	91-33491	18-9824	224
84-816761Q3	18-8821-1	190-199,711	92-802835Q1	18-9420-3	206	91-33492	18-9825	224

Mercury Marine (Cont.)			Motorola (Cont.)			Oetiker (Cont.)		
O.E. #	SIERRA #	PAGE #	O.E. #	SIERRA #	PAGE #	O.E. #	SIERRA #	PAGE #
91-33492T	18-9825	224	9AR3959G	18-5975	679	16700010	18-9129-9	220, 294
91-33493	18-9826	224	9AR3743G	18-5976	971	16700011	18-9130-9	220, 294
91-33493T	18-9826	224	510-821	18-5976	971	16700012	18-9131-9	220, 294
91-34379T	18-9827	224	510-802	18-5976	971	16700013	18-9132-9	220, 294
91-36379	18-9828	230	510-835	18-5976	971	16700016	18-9133-9	220, 294, 513
91-36569	18-9829	225	510-836	18-5976	971	16700017	18-9134-9	220, 294
91-36569T	18-9829	225	510-856	18-5976	971	16700024	18-9135-9	220, 294
91-36571	18-9830	225	510-861	18-5976	971	16700031	18-9136-9	220, 294
91-36571T	18-9830	225	510-862	18-5976	971	16700037	18-9137-9	220, 294
91-36577	18-9831	225	NISSAN			16700040	18-9138-9	220, 294
91-36577T	18-9831	225	NISSAN-TOHATSU			16700053	18-9139-9	220, 294
91-37292	18-9832	230	3G3060211M	18-5165	473	16700020	18-9140-9	220, 294
91-37311	18-9833	230	NISSAN-TOHATSU			14100082	18-9141	220, 294, 513
91-37312	18-9834	230	OMC					
91-37323	18-9835	225	3V1060400M	18-23207	Obsolete	390905	22355	219
91-37350	18-9836	225	3C8010055M	18-3850	477	500421	37477	Obsolete
91-38628T	18-9837	225	3T9010050M	18-3886	477	388517	37478	Obsolete
91-38756	18-9838	225	3F3010051M	18-4299	477	500422	37478	Obsolete
91-38918T	18-9839	225	3R3010300M	18-43175	476	500423	37479	219
91-38919	18-9840	Obsolete	3B2650160M	18-43212	476	384884	37509	Obsolete
91-42840T	18-9841	225	3C8-87121-4	18-4434	476	384848	38653	Obsolete
91-43506T	18-9842	225	3F3871210M	18-4435	476	910048	56507	Obsolete
91-43559	18-9843	Obsolete	3B7871218M	18-4438	476	390928	79040	219
91-43579	18-9844	225	353650210M	18-45404	476	317201	1525607	Obsolete
91-43591T	18-9845	225	3B2873222M	18-48317	416, 476	508235	1525607	Obsolete
91-44110	18-9846	Obsolete	3A4050040M	18-51000	477	323469	18-0102	320, 320, 329
91-45497A1	18-9847	225	3G2-06040-2	18-5166	473	907764	18-0104	926
91-52393	18-9848	225	3M3060482M	18-5166	473	324323	18-0106	321, 329
91-52394	18-9849	225	3F0-06153-0	18-5182	Obsolete	324449	18-0108	302, 332, 361
91-53459	18-9850	225	3F0060491M	18-5182	Obsolete	324670	18-0110	332
91-55916	18-9851	225	3F0061530M	18-5182	Obsolete	324717	18-0112	321, 330
91-55918	18-9852	226	3C8750140M	18-56002	Obsolete	907761	18-0114-1	917, 926
91-56048001	18-9853	226	332600060M	18-60103	477	317955	18-0117	329
91-56048T	18-9853	226	3V1010050M	18-60916	477	325092	18-0118	327
91-56775T	18-9854	226	3V1010240M	18-60917	477	325211	18-0120	329
91-60523	18-9855	226	3V1013030M	18-60918	441, 477	325260	18-0122	328
91-60526T	18-9856	226	3V1023050M	18-60919	441, 477	325537	18-0124	332
91-61067A3	18-9857	226	346-01032-0	18-60920	477	326264	18-0126	329
91-61069T	18-9858	226	353760104M	18-6418	474	326468	18-0128	330
91-63616	18-9859	226	3V1871210M	18-64221	Obsolete	332266	18-0130	328
91-63638T	18-9860	226	B29A-90500A	18-6430	474	327707	18-0134	327
91-78310	18-9861	226	346760100M	18-6431	474	328283	18-0136	330
91-87119	18-9862	229	3C8760101M	18-6432	474	328590	18-0138	330
91-89865	18-9863	227	332600052M	18-72656	477	328604	18-0140	328
91-90774	18-9865	227	332600060M	18-72656	477	328622	18-0142	328
91-89897	18-9866	227	345871224M	18-7290	475	328626	18-0144	328
91-61077	18-9868	226	346871220M	18-7291	475	3652824	18-0147	1004
91-817570T	18-9869	226	398873213M	18-74610	476	329718	18-0148	328
91-818162	18-9870	226	346873217M	18-74611	476	357159	18-0153	923
91-818169T	18-9871	226	3R0074220M	18-76695	477	393159	18-0153	923
91-821571A1	18-9872	226	369022300M	18-7712	475	458625	18-0153	923
91-813653	18-9873	229	369871221M	18-7765	475	330412	18-0155	322
91-14311A04	18-9874	224	3R0-07615-0	18-7911-1	202, 476	330698	18-0157	328
91-14311A1	18-9874	224	3GR702500M	18-80410-1	404, 475	330909	18-0159	328
91-14311A2	18-9874	224	3B2702810M	18-8079	475	331532	18-0161	328
91-44307A1	18-9874	224	65750-95500	18-8079	475	311069	18-0164	1002
91-90244A1	18-9875	Obsolete	3B2702501M	18-8088	475	911705	18-0166	928
87-88107	MP41000	381	3B2-70260-0	18-8089	475	313283	18-0173	365
87-17009A2	MP41070-2	381	3B2650211M	18-8920	476	326716	18-0174	365
87-17009A5	MP51090	25, 381	334650210M	18-8921	476	310058	18-0182	331
87-17009A5	MP51092	25, 381	3C8650212M	18-8922	476	908717	18-0183-1	661, 799
87-88107A5	MP52000	25, 381, 381	345650210M	18-8923	476	916262	18-0183-1	661, 799
MERCURY/MERCURISER			3B7650212M	18-8924	476	3852455	18-0183-1	661, 799
			3C7650211M	18-8924	476	3853742	18-0183-1	661, 799
			OBERDORFER			909748	18-0188	929
879984A1	18-5158	376	6603	18-3021	576	912157	18-0190	928
879984T00	18-5158	376	132-0317	18-3060	982, 1012	314731	18-0195	349, 939
879984T01	18-5158	376	8922	18-3061	575	333725	18-0197	339, 349
8M0077471	18-5158	376	B6620	18-3075	575	324766	18-0198	339, 349
339-883778A01	18-5159	376	C7441	18-3077	575	327656	18-0200	349
339-883778A02	18-5159	376	7054	18-3078	575	333771	18-0201	349
339-8M0077473	18-5159	376	OETIKER			911680	18-02060	931, 932
MOTOROLA			787133	18-9125	220, 294	911681	18-02061	931, 932
510-845	18-5975	679	16700004	18-9126-9	220, 294	911662	18-02062	931, 932
510-860	18-5975	679	16700006	18-9127-9	220, 294	911663	18-02063	931, 932
510-864	18-5975	679	16700007	18-9128-9	220, 294	911665	18-02065	931, 932
9AR3855G	18-5975	679				911666	18-02066	931, 932
9AR6000G	18-5975	679						

OMC (Cont.)			OMC (Cont.)			OMC (Cont.)		
O.E. #	SIERRA #	PAGE #	O.E. #	SIERRA #	PAGE #	O.E. #	SIERRA #	PAGE #
911667	18-02067	931, 932	321895	18-0543	365, 949	437228	18-0993	286
911668	18-0207	931, 932	909515	18-0548	927	323222	18-0995	330
911669	18-0209	931, 932	909829	18-0549	929	323459	18-0999-9	329
911670	18-0209	931, 932	909830	18-0550	929	3850426	18-1074	936
911671	18-0209	931, 932	332585	18-0559	365, 949	982422	18-1099	942
911672	18-0209	931, 932	341501	18-0628	327	387817	18-1117	938
911673	18-0209	931, 932	986658	18-0647	170, 942	377139	18-1154	938
911674	18-0209	931, 932	914723	18-0652	942	387247	18-1158	350, 938
911675	18-0209	931, 932	308825	18-0653	942	983891	18-1161	350, 938
911676	18-0209	931, 932	914743	18-0654	942	983892	18-1170	938
911677	18-0209	931, 932	914736	18-0655	942	983878	18-1171	938
911669	18-0211	931, 932	913270	18-0664	927	983877	18-1172	938
911670	18-0211	931, 932	3852687	18-0664	927	329830	18-1202	331
911671	18-0211	931, 932	910113	18-0673	926	912164	18-1204-1	927
911672	18-0211	931, 932	321932	18-0675	306, 331	912164	18-1204-1-9	927
911673	18-0211	931, 932	311145	18-0679	332	329826	18-1205	330
911674	18-0211	931, 932	3853256	18-0680	927	329833	18-1207	329
911675	18-0211	931, 932	303615	18-0850	327	343863	18-1207	329
911676	18-0211	931, 932	329826	18-0851	332	473424	18-1211	922
911678	18-0211	931, 932	985630	18-0868	923	326926	18-1212	329
911678	18-0227	931, 932	3854269	18-0868	923	912989	18-1213	922
911679	18-0229	931, 932	175158	18-0871	S/S to 18-0871-1	914817	18-1213	922
3854942	18-0311	927	312780	18-0874	925	3853341	18-1213	922
352165	18-0313	332	3852109	18-0874	925	315868	18-1218	329
3852656	18-0322	928	312800	18-0876	925	320880	18-1219	333
3853342	18-0327	927	3852113	18-0876	925	330273	18-1221	333
3930912	18-0346	927	911878	18-0880	928	394408	18-1222	307
912981	18-0347	927	304764	18-0882	332	315869	18-1224	329
913277	18-0347	927	912988	18-0887	928	3853827	18-1230	922
3852693	18-0347	927	913275	18-0887	928	3854095	18-1231	923
508871	18-0348	823	3852691	18-0887	928	3853510	18-1232	923
3931593	18-0348	823	909835	18-0891	928	3860095	18-1233	922
913758	18-0352	927	3852477	18-0891	928	3853528	18-1234	922
318917	18-0397	331	322411	18-0892	331, 927	309243	18-1236	346, 929
312797	18-0398	926	3850595	18-0893	928	3856138	18-1237	923
3852111	18-0398	926	3853361	18-0903	927	912979	18-1238	923
913393	18-0401	926	911698	18-0911	927	3850379	18-1238	923
912955	18-0405	923	311508	18-0917	333	914820	18-1239	923
3852655	18-0405	923	313244	18-0923	929	317245	18-1243	306
508872	18-0407	923	393561	18-0927	329	317624	18-1279	932
986103	18-0410	923	313416	18-0929	331, 925	398602	18-1282	32, 277
986104	18-0410	923	314115	18-0933	328	335818	18-1283	330
988162	18-0410	923	314322	18-0935	328	335819	18-1284	330
3853912	18-0410	923	315055	18-0937	925	335403	18-1285	330
3853913	18-0410	923	315189	18-0939	928	336232	18-1286	318
3854406	18-0410	923	315538	18-0941	331	392475	18-1287	354
357159	18-0411	923	909786	18-0943-2	917	328313	18-1288	354
458625	18-0411	923	913783	18-0943-2	917	327655	18-1289	355
508876	18-0411	923	3850496	18-0943-2	917	337020	18-1290	356
337068	18-0412	331	913783	18-0943-2-9	926	433503	18-1299	350
909613	18-0418	927	323217	18-0945	329	333957	18-1343	355, 942
912477	18-0430	926	336430	18-0945	329	379504	18-1350	350, 938
912471	18-0431	926	909529	18-0947	927	382407	18-1351	350, 938
909758	18-0434	925	316499	18-0949	333	387041	18-1353	313
908765	18-0435	925	317305	18-0951	Obsolete	386764	18-1354	350
334353	18-0437	327	317951	18-0953	3332	386765	18-1355	350
915719	18-0440	927	318156	18-0955	329	382343	18-1356	350
329076	18-0441	331	912405	18-0956-1	926	384195	18-1357	350
323312	18-0445	332	318373	18-0957	330	389039	18-1358	938
323311	18-0446	Obsolete	318924	18-0959	328	396041	18-1360	313
912768	18-0464	927	318932	18-0961	327	387787	18-1361	313
352670	18-0465	923	335633	18-0963	328	397537	18-1363	350
393061	18-0466	923	333879	18-0965	330	397538	18-1364	350
3921473	18-0466	923	319332	18-0967	331	387656	18-1365	350, 938
3923440	18-0466	923	319586	18-0969	332	382408	18-1366	350, 938
912954	18-0468	928	319661	18-0971	321, 331	385068	18-1367	350
915326	18-0468	928	315052	18-0973	329	398901	18-1368	350
3852654	18-0468	928	333008	18-0975	328	432264	18-1369	350
3853512	18-0468	928	332369	18-0977	331	389042	18-1370	350, 938
914323	18-0518	929	331598	18-0978	328	385043	18-1371	350, 938
3853132	18-0518	929	321183	18-0979	328	395627	18-1374	313
3854956	18-0518	929	3935449	18-0980	928	434844	18-1376	313
3852657	18-0519	922	321479	18-0981	329	320499	18-1377	313
913745	18-0528	922	321497	18-0983	328	388344	18-1378	313
320936	18-0540	333	321722	18-0985	328	330854	18-1391	314
315288	18-0542	365, 949	332319	18-0987	329	393896	18-1393	Obsolete
321831	18-0542	365, 949	321794	18-0989	328	385503	18-1395	314
313507	18-0543	365, 949	321907	18-0991	329	390641	18-1396	Obsolete

OMC (Cont.)			OMC (Cont.)			OMC (Cont.)		
O.E. #	SIERRA #	PAGE #	O.E. #	SIERRA #	PAGE #	O.E. #	SIERRA #	PAGE #
3856127	18-1400	921	313282	18-2023	365, 949	334516	18-2216	354
985316	18-1401	921	314167	18-2024	365, 949	336562	18-2216	354
3853847	18-1401	921	318972	18-2025	365, 949	337772	18-2216	354
502036	18-1402	921	317843	18-2026	347	337774	18-2216	354
3854033	18-1402	921	305306	18-2027	365, 949	910995	18-2216	354
337778	18-1500	355, 942	321459	18-2027	365, 949	434063	18-2218	354, 940
160084	18-1501	939	318973	18-2028	365	436746	18-2218	354, 940
318940	18-1505	334	319256	18-2029	365	985050	18-2218	354, 940
394411	18-1506	307	321481	18-2029	365	989966	18-2218	354
335981	18-1507	307	321786	18-2030	365, 949	317838	18-2219	354, 940
910414	18-15380	911	321787	18-2031	365, 949	333077	18-2219	354, 940
311606	18-15400	911	321788	18-2032	365	340490	18-2219	354, 940
910343	18-15415	911	321928	18-2033	365, 949	320630	18-2220	354, 940
912509	18-15435	911	324639	18-2034	365, 949	323664	18-2220	354, 940
311046	18-15440	911	300599	18-2035	365	320166	18-2224	359
914787	18-15450	911	327031	18-2035	365	320167	18-2225	359
908929	18-15455	911	313353	18-2058	365, 949	320168	18-2226	359
310953	18-15460	911	318223	18-2059	365, 949	320169	18-2227	359
909971	18-15460	911	303804	18-2060	365	320170	18-2228	359
909818	18-15500	911	321467	18-2060	365, 949	323362	18-2229	359, 932
912418	18-15500	911	329922	18-2061	365, 949	323361	18-2230	359, 932
912714	18-15520	911	329923	18-2062	365, 949	314745	18-2231	359, 932
341013	18-1598	931, 932	330327	18-2063	365, 949	323889	18-2232	359
123018	18-1599	931, 932	332205	18-2064	365, 949	323890	18-2233	359
983825	18-1600	931, 931, 940	332261	18-2065	365, 949	317232	18-2234	359
983826	18-1601	931, 931, 940	911019	18-2066	365, 949	316506	18-2243	355, 939
984012	18-1602	Obsolete	911685	18-2067	365, 949	987661	18-2245-1	937
911693	18-1701	939	911701	18-2068	365, 949	987678	18-2246	937
438039	18-1702	941	915702	18-2068	365, 949	387879	18-2250	353
5000074	18-1702	941	916058	18-2068	365, 949	433017	18-2251	353, 940
434400	18-1703	941	3853655	18-2068	365, 949	435022	18-2251	353, 940
435096	18-1703	941	908065	18-2071	949	436740	18-2251	353, 940
438040	18-1703	941	908852	18-2071	949	387818	18-2252	353, 940
5000363	18-1703	941	981195	18-2071	949	436888	18-2252	353, 940
5004257	18-1703	941	908070	18-2072	949	335722	18-2277	353
331980	18-1704	334, 929	908894	18-2072	949	335679	18-2279	353
980014	18-1712	355	981196	18-2072	365, 949	319895	18-2287	354
3852563	18-1713	931, 932	907967	18-2073	949	397541	18-2288	353
313448	18-1714	942	981268	18-2073	365, 949	439138	18-2288	353
433067	18-1721	339, 352	339620	18-2074	949	332491	18-2308	354
438399	18-1722	352	326751	18-2075	949	332489	18-2309	355
346004	18-1723	352	353076	18-2075	949	397627	18-2310	355
436834	18-1725	353, 356	319664	18-2093	352, 366	435760	18-2325	352
434588	18-1729	Obsolete	333096	18-2093	352, 366	436232	18-2326	352
334742	18-1734	307	398051	18-2093	352, 366	436234	18-2327	352
394462	18-1752	313	983937	18-2100	932	435761	18-2328	352
395861	18-1753	313	912214	18-2104	933	436235	18-2330	352
3852338	18-1848	916	915716	18-2104	933	3850814	18-2337	933
3857656	18-1848	916	912213	18-2128	937	983880	18-2338	933
914899	18-1848	916	3850813	18-2128	937	3852384	18-2339	933
980617	18-1876	988	911787	18-2138	945	386659	18-2355	353
984054	18-1901	915	912212	18-2146	933	316583	18-2377	346
912441	18-1902	915	3850815	18-2146	933	318544	18-2378	929
912442	18-1903	915	980183	18-2156	943	318544	18-2378-9	346, 929
980959	18-1904	915	915717	18-2174	933	320041	18-2379	341, 346
913784	18-1909-1	916	3850812	18-2174	933	914716	18-2383	940
3850456	18-1909-1	916	983902	18-21751	937	915272	18-2383	940
3855270	18-1909-1	916	986338	18-21751	937	307551	18-2387	929
3857944	18-1909-1	916	3853962	18-21751	937	307551	18-2387-9	346, 929
3856444	18-1909-1	916	984290	18-21752-1	937	314832	18-2389	333
909863	18-1921	916	986120	18-21752-1	937	321692	18-2391	307, 333
987784	18-1922	916	3853917	18-21752-1	937	327035	18-2392	333
916096	18-1922	916	3858437	18-21752-1	937	320311	18-2398	339, 355
740120	18-1922	916	3853862	18-21753	937	324369	18-2399	355, 939
3850799	18-1922	916	984537	18-21754	937	3854539	18-2454	945, 1008
910380	18-1922	916	986232	18-21754	937	305762	18-2532	333, 362
3852374	18-1986-1	915	984629	18-21755	937	911797	18-2533	937, 948
3857723	18-1986-1	915	908063	18-2176	938	309044	18-2534	333
309989	18-2000	365, 949	908069	18-2177	938	321120	18-2536	332
330137	18-2001	365, 949	909121	18-2183	939	324937	18-2537	333
320862	18-2002	365, 875	908087	18-2184	940	328753	18-2539	332
313284	18-2005	365, 875	909753	18-2185	940	911704	18-2541	926
310599	18-2012	365, 875	982424	18-2186	940	318609	18-2543	331
313992	18-2016	365	391472	18-2187	353	321028	18-2544	331
305987	18-2018	365	395209	18-2187	353, 940	321182	18-2545	320
310649	18-2020	365, 949	379628	18-2192	898	321184	18-2546	332
313258	18-2021	347	318304	18-2208	354	322858	18-2547	332
303345	18-2022	365, 949	318303	18-2209	354	332108	18-2548	332

OMC (Cont.)			OMC (Cont.)			OMC (Cont.)		
O.E. #	SIERRA #	PAGE #	O.E. #	SIERRA #	PAGE #	O.E. #	SIERRA #	PAGE #
321435	18-2549	320	307257	18-2872	331	330818	18-2963	324
323214	18-2550	330	318334	18-2872	331	320745	18-2964	325
324701	18-2557	332	318335	18-2873	331	335360	18-2964	325
338484	18-2557	332	314876	18-2874	332	766779	18-2964	325
338882	18-2579	327	908013	18-2875-1	928, 936	911823	18-2996	929
338813	18-2582	327	3850495	18-2875-1	928, 936	3852560	18-2996	929
982132	18-2595	365	908013	18-2875-1-9	918	277181	18-3001	294
508105	18-2613	924	3850495	18-2875-1-9	918	434424	18-3001	294
439141	18-2623	361	307133	18-2876	321	375638	18-3002	294
396350	18-2656	364	314421	18-2877	320	775518	18-3002	294
396352	18-2657	364	319710	18-2878	320	377178	18-3003	Obsolete
396351	18-2658	362	312634	18-2879	328	775519	18-3003	Obsolete
396355	18-2659	362	331363	18-2879	328	378891	18-3006	294
396349	18-2660	362	338876	18-2879	328	775521	18-3006	294
981797	18-2663	946	304023	18-2880	332	396852	18-3015	294
982947	18-2664	946	125530	18-2881	334	433935	18-3015	294
982946	18-2665	946	332403	18-2881	334	797407	18-3015	294
981799	18-2666	946	907775	18-2883-1	926	389642	18-3043	294
982949	18-2667	947	313782	18-2884	324, 326	385072	18-3044	294
981801	18-2669	947	303438	18-2885	324, 326	386084	18-3050	294
985612	18-2671	947	203171	18-2886	330	395289	18-3051	294
439967	18-2672	947	302557	18-2887	334	396725	18-3053-1	295
984458	18-2672	947	326953	18-2888	324, 326	389589	18-3055	295
985613	18-2672	947	332010	18-2888	324, 326	983895	18-3058	906
984459	18-2673	948	302675	18-2889	328	3854072	18-30585	906
986364	18-2673	948	302994	18-2890	327	381538	18-3059	295
987603	18-2673	948	331203	18-2890	327	389289	18-3059	295
985518	18-2674	948	338886	18-2890	327	394534	18-3059	295
986423	18-2674	948	303339	18-2891	333	395864	18-3059	295
433550	18-2694	363	303355	18-2892	328	397131	18-3059	295
314008	18-2703	333	303750	18-2893	327	435748	18-3059	295
320943	18-2704	333	304314	18-2894	330	435821	18-3059	295
315748	18-2705	333	311068	18-2896-1	928, 936	439948	18-3059	295
321008	18-2706	333	309956	18-2898	330	5001593	18-3059	295
333758	18-2708	333	312679	18-2900	328	3854286	18-3060	982, 1012
336530	18-2709	334	332694	18-2900	328	382547	18-3082	259
912374	18-2745	937	338879	18-2900	328	377230	18-3083	259
911826	18-2763	937	306205	18-2901	331	777213	18-3083	259
914036	18-2764	937	313065	18-2901	331	379475	18-3086	906
983973	18-2765	937	909314	18-2902-1	928	777130	18-3086	906
987467	18-2765	937	909314	18-2902-1-9	918	387361	18-3090	259
3854127	18-2765	937	332696	18-2903	327	763735	18-3090	259
313080	18-2767	937	338880	18-2903	327	389576	18-3091	259
909527	18-2768	937	319348	18-2904	331	5033112	18-3099	295
332000	18-2769	333	329920	18-2905	321, 331	305303	18-3102	295
3852696	18-2779	917, 981	333418	18-2906	327	303069	18-3103	295
3852741	18-2780-1	981	338884	18-2906	327	432941	18-3104-1	295
3852742	18-2781	917, 981	325721	18-2907	321, 331	437059	18-3104-1	295
986629	18-2783	948	331499	18-2908	327	765350	18-3104-1	295
987251	18-2791	948	338878	18-2908	327	308928	18-3108	908
3850597	18-2791	948	915025	18-2909	927	907774	18-3111	908
913276	18-2815	928	910236	18-2911	928, 946	983298	18-3119	908
3852692	18-2815	926	908079	18-2912-1	926	911703	18-3121	9098
907932	18-2830-1	827	319097	18-2913	330	321940	18-3126	296
912965	18-2845	927	331916	18-2913	330	319275	18-3127	296
908935	18-2850-1	928	911702	18-2916	928	432955	18-3129	297
313368	18-2851	928	312797	18-2917	925	435673	18-3129	297
330621	18-2852	320	911836	18-2918	929	436954	18-3129	297
318925	18-2853	329	915840	18-2918	929	438591	18-3129	297
314082	18-2855	332	331917	18-2938	330	331979	18-3133	327
319665	18-2856	331	307552	18-2945	346, 929	306643	18-3135	3247
319771	18-2857	326	908611	18-2946	925	323626	18-3136	327
386573	18-2857	328	3853336	18-2946	925	334897	18-3138	296
314809	18-2858	925	310913	18-2947	926	313176	18-3141	908
311131	18-2859	926	309612	18-2950	324	911844	18-3145	909
311130	18-2860	926	766870	18-2950	324	908158	18-3153	303, 326
311121	18-2861-1	926	304720	18-2951	324	318995	18-3178	296
321573	18-2862	329	203034	18-2952	324	324097	18-3179	296
326260	18-2862	329	319633	18-2954	324	435390	18-3180	297
308799	18-2863	928	318358	18-2956	324	317841	18-3182	296
321727	18-2864	330	307069	18-2957	324	379763	18-3201	297
313763	18-2865	330	315539	18-2958	324	379766	18-3203	297
317914	18-2866	329	306048	18-2959	324	984744	18-3206	908
319174	18-2867	3239	313413	18-2960	324	984461	18-3212-1	909
310137	18-2868	330	329103	18-2961	324	388891	18-3238	Obsolete
305312	18-2869	333	322332	18-2962	324	321886	18-3290	293
305176	18-2870	Obsolete	318914	18-2963	324	330619	18-3295	296
304762	18-2871	329	320533	18-2963	324	344470	18-3295	296

OMC (Cont.)			OMC (Cont.)			OMC (Cont.)		
O.E. #	SIERRA #	PAGE #	O.E. #	SIERRA #	PAGE #	O.E. #	SIERRA #	PAGE #
331107	18-3299	296	394409	18-3500	307	331211	18-3838	325
435929	18-3315-2	302	434137	18-3500	307	333670	18-3839	325
5001595	18-3315-2	302	435957	18-3501	296	334726	18-3839	325
387326	18-3325	298	912614	18-3502	908	203130	18-3841-2	325
300611	18-3326	296	378065	18-3543	307	340115	18-3866	325
386697	18-3327	298	393659	18-3543	307	3853511	18-3874	925
387610	18-3327	298	434841	18-3543	307	914971	18-3876	925
389112	18-3327	298	508626	18-3543	307	3853380	18-3876	925
391698	18-3327	298	5005440	18-3543	307	914849	18-3877	925
394711	18-3327	298	435491	18-3544	307	912766	18-3878	925
302497	18-3329	333	437090	18-3545	307	912227	18-3879	925
304026	18-3332	333	5001036	18-3546	307	914930	18-3879	925
384087	18-3336	297	383307	18-3554	910	3854299	18-3879	925
315837	18-3337	333	382385	18-3557	307	311210	18-3880	925
320981	18-3343	296	396987	18-3557	307	908237	18-3881	925
435027	18-3346	296	982554	18-3558	909	3853732	18-3883	925
984461	18-3348	909	3853799	18-3558	909	915325	18-3887	925
325398	18-3352	299	384719	18-3560	307	332816	18-3895	325
328751	18-3358	296	436195	18-3561	307	332817	18-3896	325
328755	18-3359	Obsolote	321222	18-3562	308	332819	18-3898	325
329390	18-3360	331	321027	18-3563	308	327674	18-3899	331
330560	18-3363	297	318395	18-3564	308	436254	18-3901	310
909533	18-3365	303, 327	321220	18-3565	307	394930	18-3904	310
390286	18-3366	295	321221	18-3567	307	396504	18-3905	310
393632	18-3367	297	983296	18-3577-2	905	385662	18-3906	310
396809	18-3368	295	986074	18-3577-2	905	396503	18-3906	310
302325	18-3369	327	987447	18-3577-2	905	390509	18-3907	310
319126	18-3369	303	3854118	18-3577-2	905	390510	18-3908	310
384956	18-3376	298	984876	18-3578	905	396377	18-3910	310
382468	18-3377	298	982515	18-3584-1	905	396378	18-3911	310
391635	18-3378	299	982517	18-3584-1	905	396379	18-3912	310
439077	18-3378	299	3853796	18-3584-1	905	391170	18-3913	310
390381	18-3379	299	984360	18-3593	905	434107	18-3913	310
390770	18-3380	299	986779	18-3593	905	391416	18-3915	310
393509	18-3381	299	380640	18-3593	905	434109	18-3915	310
393630	18-3382	299	3854017	18-3593	905	386280	18-3933	310
395270	18-3383	299	3858340	18-3593	905	328506	18-3937	921
386124	18-3384	300	382218	18-3599-2	905	914555	18-3937	921
396932	18-3385	300	980477	18-3599-2	905	985083	18-3937	921
983218	18-3386	909	985429	18-3599-2	905	986336	18-3937	921
432956	18-3387	300	3853850	18-3599-2	905	3853268	18-3937	921
386533	18-3388	300	911752	18-3610	942	3853960	18-3937	921
389143	18-3388	300	433379	18-3643	307	328516	18-3938	921
436957	18-3389	300	314503	18-3705	347, 943	914557	18-3938	921
438591	18-3389	300	318971	18-3706	347	914556	18-3939	921
432955	18-3389	300	319891	18-3707	347	3854252	18-3939	921
395060	18-3390	300	398042	18-3708-1	347	328536	18-3940	Obsolote
435447	18-3390	300	175266	18-3715	347, 943	370409	18-3944	921
434421	18-3390	300	175267	18-3716	347, 943	439538	18-3947	310
5001594	18-3390	300	175268	18-3717	347	390082	18-3972	311
395072	18-3391	301	314730	18-3719	938	431844	18-3974	310
434421	18-3392	301	121731	18-3722	945	431870	18-3975	310
5001594	18-3392	301	908064	18-3725	938	910384	18-4009	916
388644	18-3393	301	3852648	18-3730	943	914445	18-4024	929
395073	18-3393	301	907866	18-3731	938	3853226	18-4024	929
433548	18-3394	301	5030087	18-3735	347	387139	18-4040	314
433549	18-3394	301	302804	18-3740	347	387142	18-4040	314
438592	18-3394	301	309955	18-3741	347	387661	18-4062	310
396933	18-3399	301	314502	18-3742	347	394461	18-4063	310
439077	18-3399	301	320785	18-3743	347	437409	18-4063	310
391698	18-3400	301	552906	18-3744	347	398483	18-4064	310
394711	18-3400	301	322941	18-3763	343, 345, 932	432072	18-4065	310
394394	18-3401	301	331880	18-3765	355	432969	18-4065	310
395271	18-3401	301	334163	18-3766	355, 942	432073	18-4066	310
395270	18-3401	301	911751	18-3768	347, 942	432970	18-4066	310
382296	18-3402	301	911753	18-3769	938	432077	18-4067	310
388644	18-3403	302	911937	18-3770	933	433003	18-4067	310
435959	18-3405	267	325273	18-3800	325	432078	18-4068	310
5006511	18-3453	298	325647	18-3801	325	433004	18-4068	310
438592	18-3454	298	335361	18-3801	325	432803	18-4069	311
340619	18-3455	296	320658	18-3802	325	308186	18-4075	313
3854661	18-3469	909	327795	18-3802	325	330081	18-4076	313
5007972	18-3472	302	335359	18-3802	325	436859	18-4079	310
5007556	18-3476	303	324324	18-3803	325	439516	18-4086	310
437907	18-3491	303	329419	18-3803	325	439517	18-4087	310
5033372	18-3497	289	765012	18-3803	325	436353	18-4088	312
5036216	18-3498	289	329836	18-3836	325	436354	18-4090	312
5030699	18-3499	289	328623	18-3837	325	396585	18-4100	310

OMC (Cont.)			OMC (Cont.)			OMC (Cont.)		
O.E. #	SIERRA #	PAGE #	O.E. #	SIERRA #	PAGE #	O.E. #	SIERRA #	PAGE #
396588	18-4100	310	984765	18-4806	932	987895	18-5347	881
391653	18-4101	310	986380	18-4806	932	984401	18-5352	882
393612	18-4102	310	439476	18-4807	350, 355	984398	18-5353	882
396587	18-4103	310	331999	18-4826	346	3854548	18-5354	882
396583	18-4104	310	911750	18-4828	931, 942	986643	18-5361	882
392621	18-4107	310	915720	18-4833	908	3854331	18-5362	882
387285	18-4114	310	912029	18-4835	931, 938	982336	18-5369	882
393271	18-4120	310	911734	18-4837	908, 931	382133	18-5375	882
393924	18-4120	310	435277	18-4840	346	982209	18-5376	882
393566	18-4122	310	435276	18-4841	346	383587	18-5384	882
392455	18-4123	310	435279	18-4843	346	380541	18-5385	882
387284	18-4124	310	322236	18-4911	230, 334	980152	18-5386	882
394488	18-4148-1	313	772577	18-4911	230, 334	985218	18-5397	882
5004705	18-4148-1	313	316705	18-4913	230, 334	910169	18-5399	925
915236	18-4160	921	772578	18-4913	230, 334	982880	18-5403	881
3853477	18-4160	921	316706	18-4914	230, 334	982211	18-5404-1	881
914816	18-4161	921	772579	18-4914	230, 334	3854549	18-5405	881
3853340	18-4161	921	172525	18-5001	270, 888	986651	18-5406	881
3911023	18-4164	921	172523	18-5002	270	980892	18-5407	881
439515	18-4165	310	172806	18-5003	270	3854311	18-5408	881
3911020	18-4173	921	172522	18-5006	270	982342	18-5411	882
436860	18-4190	310, 312	172521	18-5011	270	987986	18-5413	882
3852350	18-4194	943	3854003	18-5107-1	882	384735	18-5418	882
439015	18-4195	310	986642	18-5108	882	380542	18-5419	882
334665	18-4197	313	3854001	18-5108	882	915735	18-5433	883
379957	18-4218	916	581207	18-5141	270	378231	18-5437	883
127084	18-4222	347	580148	18-5156	270	383444	18-5437	883
318841	18-4222	943	580290	18-5157	270	3854002	18-5443	883
333592	18-4223	347, 943	581130	18-5163	271	432925	18-5612	283
315810	18-4228	347, 943	583298	18-5170	271	586286	18-5612	283
319890	18-4229	337	583740	18-5170	271	586287	18-5612	283
320305	18-4230	337	502881	18-5172	271	586274	18-5617	283
320570	18-4231	347, 943	581786	18-5172	271	778995	18-5617	283
323943	18-4232	337	582366	18-5176	271	391511	18-5619	283
311598	18-4248	346, 929	583737	18-5176	271	396235	18-5619	283
311598	18-4248-9	346, 929	584561	18-5176	271	397023	18-5619	283
318544	18-4249	337	582508	18-5179	271	584799	18-5619	283
911820	18-4250	929	582995	18-5181	271	586731	18-5619	283
908062	18-4251	938	584477	18-5181	271	583482	18-5624	283
336982	18-42531-9	346, 929	502888	18-5192	271	585056	18-5624	283
336982	18-4253-9	346, 929	581610	18-5192	271	586279	18-5624	283
307551	18-4255	346	582091	18-5192	271	583473	18-5627	283
324334	18-4276	303, 327	580740	18-5193	Obsolete	585059	18-5627	283
324430	18-4277	303, 327	582382	18-5193	Obsolete	585459	18-5627	283
327861	18-4280	310	502890	18-5194	271	393570	18-5628	283
317831	18-4290	310	581032	18-5194	271	585060	18-5628	283
326765	18-4292	310	582160	18-5194	271	586285	18-5628	283
385416	18-4300	319	584632	18-5194	271	778994	18-5628	283
388602	18-4301	319	502880	18-5196	271	386591	18-5629	283
390078	18-4302	320	581407	18-5196	271	392133	18-5629	283
389556	18-4303-1	320	580321	18-5199	270	585061	18-5629	283
391300	18-4303-1	320	580256	18-5200	270, 880	384163	18-5630	283
391988	18-4304-1	320	581419	18-5205		384163	18-5630	283
393433	18-4305	320	510364	18-5224	277, 889	387684	18-5630	283
394546	18-4306	321	510883	18-5226	277	387684	18-5630	283
389206	18-4307	321	772584	18-5226	277	389275	18-5630	283
392567	18-4307	321	582365	18-5231-1	189, 276	389275	18-5630	283
392615	18-4307	321	3854217	18-5248	882	585063	18-5630	283
433941	18-4307	321	172527	18-5250	888	584818	18-5631	283
394885	18-4309	321	173619	18-5251	888	586277	18-5631	283
434381	18-4309	321	172531	18-5256	880	778996	18-5631	283
396750	18-4310	321	173690	18-5258	880	584980	18-5632	283
390076	18-4318	322	987925	18-5258	880	586284	18-5632	283
398047	18-4321	322	173829	18-5260	880	385529	18-5634	283
432570	18-4322	322	987926	18-5260	880	389954	18-5634	283
436891	18-4323	323	980893	18-5303	881	585051	18-5634	283
912978	18-4408	924	987136	18-5303	881	585057	18-5634	283
396644	18-4529	303, 304	987894	18-5303	881	387094	18-5640	282
382221	18-45221	295	980902	18-5309-1	887	395207	18-5640	282
114812	18-45312	295	380543	18-5310	881	585062	18-5640	282
5008972	18-4537	302	380538	18-5311	881	586288	18-5640	282
3852568	18-4749-9	931, 932	981080	18-5312-1	887	778992	18-5640	282
983967	18-4750	931, 942	985560	18-5313-1	887	384777	18-5648	283
5000356	18-4801	932	382135	18-5314	881	386657	18-5648	283
986381	18-4804	932	382136	18-5338	881	391735	18-5648	283
984770	18-4804	932	382125	18-5344	881	585050	18-5648	283
984771	18-4805	932	380537	18-5345	881	585058	18-5648	283
986382	18-4805	932	980894	18-5347	881	586281	18-5648	283

OMC (Cont.)			OMC (Cont.)			OMC (Cont.)		
O.E. #	SIERRA #	PAGE #	O.E. #	SIERRA #	PAGE #	O.E. #	SIERRA #	PAGE #
321648	18-5655	284	584580	18-5823	279	984513	18-6028A	945
384781	18-5671	284	395204	18-5825	281	3853818	18-6028A	945
387683	18-5674	282	584890	18-5826	281	3855412	18-6028A	945
585269	18-5678	282	584476	18-5827	281	397768	18-6029	945
585267	18-5679	282	585001	18-5827	281	431708	18-6095	361, 945
385952	18-5697	282	439561	18-5828	281	431708	18-6095A	361, 945
582472	18-5705	279, 896	585219	18-5828	281	123009	18-6100	361
584416	18-5705	279, 896	586048	18-5829	281	173029	18-6100	361
586224	18-5705	279, 896	586075	18-5830	281	983494	18-6101	945
582399	18-5708	281	584641	18-5831	281	984513	18-6102	945
583408	18-5708	281	585995	18-5831	281	3853818	18-6102	945
581778	18-5709	281	586271	18-5831	281	3855412	18-6102	945
383440	18-5711	895	583266	18-5832	281	984547	18-6103	945
1984462	18-5717	893	583689	18-5832	281	984547	18-6103A	945
580339	18-5750	277, 493, 580	584424	18-5832	281	433580	18-6115	361
581027	18-5750	277, 493, 580, 594	586000	18-5832	281	983195	18-6257	896
385391	18-5753	Obsolete	586774	18-5833	279	987774	18-6261	895
581311	18-5753	Obsolete	584643	18-5877	278	3854182	18-6261	895
581731	18-5753	Obsolete	584981	18-5878	278	3854809	18-6261	895
581726	18-5754	Obsolete	584488	18-5883	278	3856600	18-6261	895
581397	18-5755	275	586343	18-5884	274	3857561	18-6261	895
764708	18-5755	275	583865	18-5885	274	3860171	18-6261	895
582056	18-5756	Obsolete	436367	18-5886	274	984536	18-6270	891
581713	18-5757	Obsolete	584122	18-5886	274	988013	18-6270	891
582057	18-5757	Obsolete	584985	18-5887	274	984536	18-6276	891
582452	18-5758	275	987738	18-5888	883	988013	18-6276	891
582453	18-5758	275	987739	18-5889	883	435548	18-6277	278
583380	18-5758	275	987740	18-5890	883	437801	18-6280	278
581805	18-5759	275	985902	18-5890	883	438786	18-6281	278
582125	18-5759	275	583605	18-5891	274	439937	18-6281	278
582138	18-5760	275	583476	18-5893	274	5005254	18-6281	278
582400	18-5760	275	584037	18-5893	274	433226	18-6285	278
582556	18-5760	275	586217	18-5893	274	3854194	18-6291	893
582642	18-5760	275	586667	18-5893	274	984264	18-6399	933
583114	18-5761	275	3852215	18-5894	20, 905, 980	386430	18-6434	282
582285	18-5763	275	980613	18-5897	909	307573	18-6501	334
583170	18-5763	275	171960	18-5898	909	395460	18-6501	334
582261	18-5764	275	982650	18-5899	909	318944	18-6503	334
586696	18-5764	275	980803	18-5903	892	328877	18-6509	334
583748	18-5766	275	981821	18-5903	892	312932	18-6511	334
584783	18-5767	276	981289	18-5907	891	330525	18-6512	334
584908	18-5768	276	982202	18-5907	891	203698	18-6513	334
5001344	18-5768	276	981288	18-5908	892	323653	18-6522	334
584028	18-5770-1	276	982195	18-5908	892	338534	18-6522	334
584032	18-5771	273	984982	18-5908	892	397003	18-6525	Obsolete
584041	18-5772-1	273	986007	18-5908	892	397004	18-6526	359
584642	18-5773	273	984456	18-5910	892	395911	18-6527	Obsolete
585145	18-5774-1	273	986505	18-5910	892	396161	18-6528	Obsolete
763803	18-5774-1	273	981078	18-5911	891	5000581	18-6528	Obsolete
585189	18-5780	S/S to 18-5774-1	982121	18-5911	891	5006319	18-6744	278
584636	18-5781-1	274	983444	18-5911	891	382138	18-6754	896
585114	18-5781-1	274	983790	18-5911	891	982058	18-6755	896
586212	18-5781-1	274	985966	18-5911	891	982706	18-6755	896
586661	18-5781-1	274	3854751	18-5913-1	892	391264	18-6759	278
582705	18-5782	274	984628	18-5917	892	393988	18-6759	278
763793	18-5782	274	988217	18-5919-1	716	394176	18-6759	278
582811	18-5783	S/S to 18-5784-1	987811	18-5920	891	985237	18-6759	278
763794	18-5783	S/S to 18-5784-1	3854190	18-5920	891	387277	18-6761	278
582811	18-5784-1	274	982364	18-5957	895	582048	18-6761	278
763794	18-5784-1	274	123009	18-6017	361	582155	18-6761	278
583110	18-5784-1	274	173029	18-6017	361	584107	18-6761	278
585261	18-5785	274	123009	18-6017A	361	172543	18-6762	278
583896	18-5794	S/S to 18-5794-1	173029	18-6017A	361	982069	18-6764	896
584329	18-5794	S/S to 18-5794-1	327606	18-6018	361	982073	18-6764	896
584331	18-5794	S/S to 18-5794-1	982277	18-6019	944	983318	18-6764	896
584489	18-5794	S/S to 18-5794-1	982438	18-6019	944	172850	18-6767-1	278
586730	18-5801	279, 893	976669	18-6020	361, 944	173564	18-6767-1	278
586842	18-5801	279, 893	393023	18-6024	361, 944	173596	18-6767-1	278
985064	18-5801	279, 893	436745	18-6024	361, 944	986280	18-6779	896
979774	18-5803	893	393023	18-6024A	361, 944	3853945	18-6779	974
378444	18-5807	279, 893	436745	18-6024A	361, 944	434496	18-6780	278
395419	18-5808	279, 893	398331	18-6025	361, 945	438529	18-6780	278
582708	18-5808	279, 893	433458	18-6025	361, 945	438531	18-6780	278
3850216	18-5811	893	392462	18-6026	361	5005114	18-6801	279
985063	18-5812	893	392123	18-6027	361, 945	5005113	18-6802	279
584128	18-5813	279	984513	18-6028	945	5005115	18-6803	279
172869	18-5814	279, 893	3853818	18-6028	945	5007662	18-6803	279
581528	18-5814	279, 893	3855412	18-6028	945	984356	18-6814	896

OMC (Cont.)			OMC (Cont.)			OMC (Cont.)		
O.E. #	SIERRA #	PAGE #	O.E. #	SIERRA #	PAGE #	O.E. #	SIERRA #	PAGE #
172588	18-6816	278	303067	18-7116	368, 951	987317	18-7244	899
173944	18-6816	278	303360	18-7117	368, 951	987319	18-7245	899
172543	18-6822	973	305242	18-7118	368, 951	987438	18-7246	899
382715	18-6822	973	307853	18-7120	368, 951	987440	18-7246	899
983424	18-6841	895	332598	18-7120	951	987485	18-7246	899
983836	18-6841	895	308621	18-7121	368, 951	435442	18-7247	285
988247	18-6841	895	308876	18-7123	368, 951	438996	18-7247	285
983247	18-6842	664	313340	18-7126	368, 951	435676	18-7248	286
983424	18-6842	664	313446	18-7127	368, 951	435677	18-7248	286
983836	18-6842	664	313754	18-7128	368, 951	435678	18-7248	286
584605, 586275	18-6863	284	314491	18-7129	368, 951	435752	18-7248	286
982019	18-6950	896	314728	18-7130	368, 951	437327	18-7248	286
382050	18-7010	285	305123	18-7133	368, 951	439078	18-7248	286
382051	18-7010	285	322119	18-7133	368, 951	439079	18-7248	286
382054	18-7010	285	312781	18-71337	911	380986	18-7258	168
985052	18-7017	898	303059	18-7134	368, 951	982063	18-7267	167, 901
982352	18-7018	Obsolete	310584	18-7135	368, 951	981650	18-7268	167, 901
382052	18-7024	285	318372	18-7137	368, 951	509409	18-7274	167
382053	18-7024	285	318717	18-7138	368, 951	509410	18-7275	167
385356	18-7024	285	319085	18-7139	368, 951	509395	18-7278	167
382057	18-7026	Obsolete	320303	18-7140	368, 951	982240	18-7278	167, 901
379312	18-7093	286	321117	18-7141	368, 951	985602	18-7278	167, 901
387282	18-7093	286	322119	18-7142	368, 951	985603	18-7278	167, 901
396520	18-7093	286	322501	18-7143	368, 951	509407	18-7282	167
392061	18-7042	285	331188	18-7143	368, 951	509404	18-7283	167
396701	18-7042	285	326849	18-7144	368, 951	509408	18-7284	167
398729	18-7042	285	333572	18-7145	368, 951	982997	18-7289	168, 901
382045	18-7043	285	554545	18-7146	368, 951	315232	18-7296	286
382046	18-7043	285	303598	18-7150	368, 951	3850809	18-7326	168, 902
382047	18-7043	285	331380	18-7150	368, 951	3854620	18-7326	168, 902
382049	18-7043	285	334913	18-7150	368, 951	3857986	18-7326	168, 902
383052	18-7043	285	307082	18-7152	368, 951	3858261	18-7326	168, 902
383067	18-7043	285	911851	18-7153	368, 951	988037	18-7330	168, 902
398532	18-7043	285	3852565	18-7153	368, 951	3854280	18-7330	168, 902
439071	18-7043	285	305270	18-7155	368, 951	3855958	18-7330	168, 902
390055	18-7046	285	309731	18-7156	368, 951	3857650	18-7330	168, 902
392550	18-7046	285	310585	18-7158	368, 951	3850810	18-7331	168, 902
398526	18-7046	285	310967	18-7158	368, 951	3857985	18-7331	168, 902
434888	18-7046	285	302337	18-7162	467, 876	3858714	18-7331	168, 902
435443	18-7046	285	302537	18-7164	368, 951	391638	18-7350	288
439076	18-7046	285	304174	18-7165	368, 951	395091	18-7350	288
383615	18-7070	898	310414	18-7167	368, 951	397274	18-7350	288
982384	18-7070	898	202893	18-7168	368, 951	397839	18-7350	288
380186	18-7071	898	911686	18-7169	368, 951	438562	18-7351	288
384743	18-7072	898	307239	18-7170	368, 951	382354	18-7352	288
979659	18-7072	898	553126	18-7172	368, 951	385781	18-7352	288
979719	18-7080	898	310327	18-7173	368, 951	388268	18-7352	288
982537	18-7081	898	326649	18-7174	368, 951	394543	18-7352	288
983538	18-7081	645	910582	18-7174	368, 951	395713	18-7352	288
984487	18-7086	898	320140	18-7178	368, 951	398338	18-7352	288
378895	18-7093	286	303347	18-7180	368, 951	398387	18-7352	288
396521	18-7093	286	308626	18-7198	368, 951	432451	18-7352	288
678882	18-7093	286	381389	18-7200	900	433387	18-7352	288
321724	18-70936	319	383087	18-7201	900	438556	18-7352	288
340975	18-70936	319	983871	18-7201	900	433386	18-7353	288
340976	18-70937	319	382363	18-7210	286	438555	18-7353	288
379313	18-7094	286	431897	18-7219	285	908194	18-7400	368, 951
396522	18-7094	286	439073	18-7219	285	908383	18-7401	368, 951
383918	18-7095	898	435442	18-7221	285	909316	18-7403	368, 951
983864	18-7095	898	392061	18-7222	285	909747	18-7404	368, 951
982539	18-7096	899	396701	18-7222	285	911311	18-7406	368, 951
85R-4541	18-7096	899	398729	18-7222	285	911700	18-7407	368, 951
301877	18-7100	368, 951	391305	18-7223	286	3852531	18-7407	368, 951
305739	18-7101	368, 951	391937	18-7223	286	911718	18-7408	368, 951
307450	18-7102	368, 951	398452	18-7223	286	911871	18-7409	368, 951
308624	18-7103	368, 951	398453	18-7223	286	5030973	18-74108	364
308627	18-7104	368, 951	439072	18-7223	286	321921	18-7411	368
311338	18-7105	368, 951	981566	18-7229	902	303191	18-7413	368, 951
307583	18-7106	286	966865	18-7229	902	329380	18-7416	368, 951
313175	18-7107	368, 951	986783	18-7235	899	329381	18-7417	368, 951
313893	18-7108	368, 951	986782	18-7236	899	326741	18-7418	368, 951
338518	18-7108	368, 951	986784	18-7237	899	307103	18-7428	332, 363
317178	18-7109	368, 951	986799	18-7237	899	301967	18-7440-1	368, 951
335523	18-7110	325	986796	18-7238	899	319662	18-7457	368, 951
301824	18-7111	368, 951	986800	18-7239	899	308458	18-7461	368, 951
302493	18-7112	368, 951	986804	18-7241	899	332584	18-7475	368, 951
302540	18-7114	368, 951	987313	18-7242	899	909048	18-7477	368, 951
302588	18-7115	368, 951	987315	18-7243	899	324981	18-7481	332

PERKINS			Pleasurecraft (Cont.)			Rochester (Cont.)		
O.E. #	SIERRA #	PAGE #	O.E. #	SIERRA #	PAGE #	O.E. #	SIERRA #	PAGE #
185086600	18-6944	680	9-37824	18-7976	Obsolete	17080564	18-7605-1	171
2654403	18-7886	200, 690	RP080026	18-8127	646	17080565	18-7605-1	171
2871A651	18-5975	679				17082403	18-7607-1	171
PLEASURECRAFT			POLARIS			7040080	18-7608-1	171
RM0007	18-0183-1	649	3240120	18-15080	570	7040083	18-7608-1	171
RM0099	18-0676-1	649	VES	72-5103-2	211	7040089	18-7608-1	171
RM0002	18-0677-1	649	VES	72-5103-3	211	7042183	18-7608-1	171
RM0003	18-0878	649	VES	72-5103-4	211	7043183	18-7608-1	171
3705042	18-0889	649	VES	72-5103-5	211	7043184	18-7608-1	171
RM0017	18-0898	649	VES	72-5103-7	211	17059052	18-7608-1	171
R130012	18-15214	644	PS-4	72-5104-2	212	17059057	18-7608-1	171
RO29001	18-1899	648	PS-4	72-5104-3	212	7036543	18-7609-1	171
RO28001	18-1996	648	PS-4	72-5104-7	212	7040082	18-7609-1	171
RO85035	18-2103	650	POWER POLE			7041369	18-7609-1	171
R142006	18-2434	576, 650	PUMP SPN-F	18-6818	74	7043182	18-7609-1	171
RO94020A	18-2702-1	650	PUMP PRO-F	18-6819	74	7044182	18-7609-1	171
RP061015	18-3060	646	PRESTOLITE			17059054	18-7609-1	171
RP061017	18-3061	646	VSH-6201JY	18-5710	583, 594, 616	17081060	18-7610-1	171
RO96117	18-3200	650	VSH-6201 AFY	18-5711	895	17057298	18-7615-1	171
RO28002E	18-3551	646	SAW4206	18-5807	279, 893	17059280	18-7615-1	171
RA057019	18-3577-2	646	15-79	18-5840	583, 594, 615, 718	17080561	18-7615-1	171
RA057004	18-3584-1	646	SAW4201	18-5840	583, 594, 615, 718	17085013	18-7615-1	171
RA057023	18-3586-1	646	SAW4207	18-5840	583, 594, 615, 718	1708563	18-7616-1	171
RA057024	18-3587-1	646	SAW4210	18-5840	583, 594, 615, 718	17057287	18-7616-1	171
RA057018	18-3599-2	646				17059287	18-7616-1	171
RP026002E	18-3671	646				17059290	18-7616-1	171
RO17066	18-3700	650	HYK4001	18-6274	974	17080560	18-7616-1	171
RM0032	18-3883	650	ETK 4001	18-6754	896	17059280	18-7617-1	171
RO96081	18-4214	650, 1008	ETK 4101	18-6754	896	7044291	18-7618-1	171
RO96116	18-4220	449, 458, 650, 839	ETK 4102	18-6754	896	17059289	18-7618-1	171
RA057036	18-42608	646	EVD 4001	18-6755	896	17080561	18-7618-1	171
RA108009	18-5244	696	EVD 4002	18-6755	896	17080562	18-7618-1	171
R103011	18-5245	638	873051	18-6881	973	17059283	18-7619-1	171
R114002	18-5303	638	110-258	18-6955	679, 971	17059298	18-7619-1	171
RA107001	18-5309-1	640	110-258A	18-6955	679, 971	17081299	18-7619-1	171
R114001	18-5314	638	RACOR			17083522	18-7619-1	171
R114004	18-5314	638	RK22244	18-0179	154	17078904	18-7854	904
R115001	18-5338	638	RK10012	18-7394	154	17068453	18-7855	904
R115002	18-5345	638	S3213	18-7919	154, 292, 407,	SEA-DOO		
RA108003	18-5352	639			508, 750, 751, 904, 979	278-002-199	18-1294	32
RA108002	18-5369	639	S3214	18-7920	154, 292, 407,	278-001-376	18-6859	569
R108001	18-5376	639			508, 750, 751, 904, 979	278-001-802	18-6859	569
R103004	18-5403	638	B32013	18-7928-1	154	278-000-576	18-6866	569
R103001	18-5404-1	638	B32020MAM	18-7929	154	278-000-577	18-6866	569
R103003	18-5407	638	S3240	18-7947	157, 260, 481,	278-001-038	18-6866	569
R117001	18-5433	643			508, 750, 904, 979	278-001-301	18-6866	569
R119001	18-5450	643	S3227	18-7948	157, 260, 481,	278-000-484	18-6867	569
RA122009	18-5603-1	S/S to 18-5603-1			508, 750, 904, 979	278-000-485	18-6867	569
R130001	18-5801	644	S3232	18-7949	157, 260, 481,	278-001-300	18-6867	569
RO20001	18-5899	646			508, 750, 904, 979	278-001-935	18-6867	569
RA122001	18-5903	644	RK10222	18-7987	157	278-000-186	18-6868	569
RA122008	18-5907	643	RK22628	18-9884	154, 157, 158, 217	278-000-311	18-6868	569
RA122009	18-5908	643	6H3-WV0001-02	18-99176	538	278-000-316	18-6868	569
RA122001	18-5920	644	2010SM-OR	18-99186	156	278-001-497	18-6869	569
RK122014	18-5920	644	2010TM-OR	18-99182	156	278-001-936	18-6869	569
RA097002	18-5957	644	2010PM-OR	18-99183	156	278-001-292	18-6871	570
RA097003	18-5957	644	2040N-30	18-99184	156	278-001-581	18-6874	570
RA097006	18-5957	644	2040N-10	18-99185	156	278-001-554	18-6876	570
RA097007B	18-5984	644	2040N-02	18-99191	156	278-000-123	18-6878	570
RA097007B	18-6288	644	2020N-30	18-99180	156	278-001-239	18-6879	570
RA122019	18-6443	643	2020N-10	18-99181	156	290-888-993	18-6905	569
RA097009	18-6452	644	2020N-02	18-99187	156	290-888-999	18-6905	569
RA097007C	18-6453	644	R12T	18-99193	156	420-888-9933	18-6905	569
RN0118-1	18-7017	645	R12S	18-99194	156	420-888-994	18-6905	569
RN0120-1	18-7017	645	R20S	18-99196	156	420-888-996	18-6905	569
RN0116	18-7081	645	R12P	18-99199	156	SHERWOOD PUMP		
RN0116-2	18-7081	645	R20P	18-99200	156	9959K	18-3046	575
RN0118	18-7096	645	RK10215	18-99201	156	10615K	18-3047	575
RN0120	18-7096	645	RK22368	18-99203	156	9959	18-3060	575, 597, 646, 982, 1012
RN0067	18-7227	644	ROCHESTER			10615	18-3061	575, 597, 646
RO47111	18-7480	646	7044185	18-7603-1	171	18200	18-3077	575
RO20035A	18-7646	645	17057283	18-7605-1	171	9979K	18-3079	883
R117012	18-7648	643	17057285	18-7605-1	171	10931	18-3140	618
RO20027	18-7677	645	17059291	18-7605-1	171	10927	18-3168	Obsolete
RO84003	18-7697	645	17059292	18-7605-1	171	12322	18-3169	Obsolete
RO77002	18-7824-2	201, 920						
RO77001	18-7875	201, 650						

Sherwood Pump (Cont.)			Suzuki (Cont.)			Suzuki (Cont.)		
O.E. #	SIERRA #	PAGE #	O.E. #	SIERRA #	PAGE #	O.E. #	SIERRA #	PAGE #
12859	18-3169	Obsolete	17461-985M0	18-3097	483	11141-94702	18-3820	487
SKI-DOO			17461-93901	18-3099	483	11141-94720	18-3820	487
XPS 779126	72-5103-2	211	17461-93902	18-3099	483	11141-87E10	18-3822	487
XPS 779127	72-5103-3	211	17461-93903	18-3099	483	11141-87E90	18-3822	487
SUZUKI			17471-98503	18-3188	483	11141-94506	18-3823	487
17472-95200	18-0459	485	17471-87D01	18-3189	483	11141-94620	18-3823	487
17472-95310	18-0460	485	17471-93902	18-3190	483	11141-94600	18-3824	487
17472-96301	18-0461	485	17471-94501	18-3191	483	11141-94620	18-3824	487
17472-98503	18-0477-9	485	17471-87E01	18-3192	483	11141-87D06	18-3825	487
17472-93911	18-0478	485	17471-92J00	18-3192	483	11141-87D90	18-3825	487
17472-92D10	18-0479	485	17471-92D10	18-3193	483	12140-96312	18-39480	486
17472-98611	18-0480	485	18213-98J00	18-32154	481	12410-96351-050	18-39530	486
09282-24004	18-0544	489, 490	17400-96350	18-3242	484	12140-94400	18-39540	486
09289-10002	18-0545	490	17400-96351	18-3242	484	12110-94400	18-40110	486
09282-30007	18-0546	Obsolete	17400-96353	18-3242	484	12110-93120	18-40140	486
09283-10011	18-0551	490	17400-94700	18-3243	484	12151-94400	18-42850	486
09284-08003	18-0569	488	17400-94701	18-3243	484	12151-93100	18-42860	486
56132-95J00	18-0650	490	17400-95350	18-3244	484	12151-92502	18-42870	486
17472-98J00	18-0651	485, 488	17400-95351	18-3244	484	09381-14001	18-42940-9	486
17472-91J00	18-0761	485	17400-95550	18-3244	484	09381-18002	18-42950-9	486
17472-93J00	18-0778	485	17400-87D11	18-3253	484	09381-20003	18-42960-9	486
13119-91J00	18-0792	485	17400-87E03	18-3254	484	32900-83911	18-5144	478
17582-93J00	18-0793	485	17400-87E04	18-3254	484	33410-92L10	18-5151	478
17685-97J00	18-0794	485	17400-92D01	18-3255	484	33410-94400	18-5151	478
17685-98J00	18-0795	485	17400-93951	18-3256	484	32140-83900	18-5152	478
17685-99E00	18-0796	485	17400-94611	18-3257	484	31173-95310	18-56008	479
17685-87D10	18-0797	485	17400-90J11	18-3258	484	31173-99E00	18-56009	479
09263-20051	18-1412	486	17400-90J20	18-3258	484	38860-76F01	18-5731	480
09263-14022	18-1414	486	17400-98551	18-3259	484	55320-95310	18-6032	488
09263-18016	18-1415	486	17400-98652	18-3260	484	55125-87D00	18-6033	488
09263-27005	18-1416	486	17400-93J00	18-3264	484	55125-96310	18-6098	488
09263-20072	18-1417	486	17400-93J02	18-3264	484	31100-95600	18-6414	479
12161-93902	18-1757	486	17400-98661	18-3266	484	31100-94610	18-6416	479
12161-93902	18-1757K	486	17400-98J00	18-3267	484	31100-92E00	18-6417	479
12161-93902	18-1758	486	17400-98J01	18-3267	484	31100-89J00	18-6419	479
12161-91L00	18-1758	486	09420-05006	18-3291	483	31100-95313	18-6428	479
12161-96300	18-1758	486	09420-05009	18-3291	483	31100-94702	18-6429	479
12161-92L00	18-1759	486	09420-03005	18-3292	483	38100-87000-01T	18-6785	480
12161-94400	18-1759	486	17462-93990	18-3292	483	38100-87E10-0ED	18-6785	480
12161-94400	18-1759K	486	09420-05005	18-3296	483	38100-87E20-0ED	18-6785	480
38100-92J02	18-18303	480	09420-04009	18-3404	483	38100-87D10-0ED	18-6786-1	480
38100-92J10	18-18303	480	17411-93901	18-3480	485	38100-87D10-01T	18-6786-1	480
38100-93J01	18-18303	480	17411-94421	18-3481	485	38100-87D10-35J	18-6786-1	480
38100-93J02	18-18303	480	15170-93911	18-3495	480	38100-92E00-0ED	18-6786-1	480
38100-96J00	18-18303	480	15170-94320	18-3496	480	38100-87J11	18-6793	480
37100-87J00-0EP	18-18304	480	15170-91J00	18-3497	480	38100-87J20	18-6793	480
38100-87J0EP	18-18304	480	15170-94J00	18-3498	480	31100-94600	18-6827	479
17461-92D02	18-3000	482	15170-94J0V	18-3498	480	31100-94601	18-6827	479
17461-90J00	18-3023	482	15170-99E00	18-3499	480	31100-94610	18-6827	479
17461-90J01	18-3023	482	09141-14008	18-3710	488	31100-90J00	18-6831	479
17461-94500	18-3023	482	09141-18005	18-3726	488	31100-83J00	18-6941	479
17461-94501	18-3023	482	09204-03003	18-3735	488	31100-96J00	18-6941	479
17461-94502	18-3023	482	09204-03004	18-3735	488	31100-96J01	18-6941	479
17461-94503	18-3023	482	09204-02004	18-3737	488	31100-95J00	18-6945	479
17461-94504	18-3023	482	57630-94500	18-3774	488	31100-95J01	18-6945	479
17461-94505	18-3023	482	57630-92E00	18-3775	488	09280-08008	18-7118	490
17461-94506	18-3023	482	57630-94300	18-3777	488	09280-75002	18-7140	480
17461-94510	18-3023	482	57630-96300	18-3778	488	15200-96J00	18-7348	480
17461-94511	18-3023	482	11141-98401	18-3806	486	15410-96J00	18-7711	481
17461-94520	18-3023	482	11141-98411	18-3806	486	15410-87J10	18-7716	292, 481
17461-93J00	18-3035	482	11141-98101	18-3807	486	15410-98500	18-7719	292, 481
17461-87E11	18-3049	482	11141-98130	18-3807	486	15410-94400	18-7735	481
17461-87E12	18-3049	482	11141-93901	18-3808	486	13910-87D00	18-7752	481
17461-93001	18-3092	482	11141-93960	18-3808	486	13910-94400	18-7753	481
17461-93003	18-3092	482	11141-96303	18-3809	486	13910-94701	18-7754	481
17461-93004	18-3092	482	11141-96344	18-3809	486	13910-95D00	18-7755	481
17461-94700	18-3094	483, 484	11141-94401	18-3810	486	13910-89J01	18-7773	480
17461-94701	18-3094	483	11141-94401	18-3810	486	16510-93J00	18-7895	201, 487
17461-95300	18-3095	483, 484	11141-94450	18-3810	486	16510-61A20-MHL	18-7896	201, 487
17461-95301	18-3095	483	11141-95305	18-3813	486	16510-82703	18-7897	201, 487
17461-95302	18-3095	483	11141-95320	18-3813	486	16510-05240	18-7903	202, 487
17461-96301	18-3096	483	11141-95350	18-3814	487	16510-96J00	18-7905-1	202, 487
17461-96311	18-3096	483	11141-95512	18-3814	487	16510-87J00	18-7915-1	202, 487
17461-96312	18-3096	483, 484	11141-98504	18-3816	487	99105-20004-BWL	18-7922-1	154, 481
17461-98501	18-3097	483	11141-98510	18-3816	487	15412-93J00	18-7936	481
17461-98502	18-3097	483	11141-98522	18-3816	487	99105-20006	18-7947	157, 481
17461-98503	18-3097	483	11141-95D10	18-3819	487	99105-20005	18-7948	157, 481
			11141-95D90	18-3819	487	15410-87J30	18-7953	481
			11141-94701	18-3820	487			

Suzuki (Cont.)			Volvo (Cont.)			Volvo (Cont.)		
O.E. #	SIERRA #	PAGE #	O.E. #	SIERRA #	PAGE #	O.E. #	SIERRA #	PAGE #
99105-20006-BWL	18-7987	157, 481	835417	18-0398	1002	3857723	18-1986-1	987
65720-94401	18-80409	482	3852655	18-0405	1003	3852374-2	18-1986-1	987
65750-94404	18-80418	482	3853912	18-0410	1000	804695	18-2039	1011
65750-87J10	18-80419	482	3853913	18-0410	1000	853670	18-2040	1011
65750-87J11	18-80419	482	3854406	18-0410	1000	897426	18-2041	1011
65720-986B0	18-80425	482	3852472	18-0418	990	958838	18-2043	1011
65750-98505	18-8062	482	3852654	18-0468	1004	833996	18-2044	23
99105-00192	18-8071	482	3853512	18-0468	1004	827247	18-2045	32
65740-95500	18-8078	482	876384	18-0489	999	946242	18-2046	1011
99105-00193	18-8078	482	3580309	18-0498	1000	958860	18-2047	1011
65750-95500	18-8079	482	914323	18-0518	998	181620	18-2057	1011
65750-95510	18-8079	482	3853132	18-0518	998	3853807	18-2100	1007
65720-94411	18-8087	482	3854956	18-0518	998	853255	18-2104	1007
09168-10022	18-8331	488	912957	18-0519	998	897707	18-2104	1007
25223-94400	18-8334	488	3852657	18-0519	998	912213	18-2128	1007
25700-87D00	18-8335	489	3852805	18-0528	998	3850813	18-2128	1007
25700-94400	18-8337	489	3852476	18-0549	929	3852544	18-2138	1008
25700-94500	18-8338	489	851407	18-0558	1011	3850815	18-2146	1007
25700-94700	18-8339	489	3852687	18-0664	1003	814301	18-2153	1008
25700-95500	18-8340	489	3854269	18-0868	923	3850812	18-2174	1007
25700-95D00	18-8341	489	3852109	18-0874	1005	3853962-3	18-21751	1005
09289-22D07	18-8345	489	3852113	18-0876	1002	3858437-1	18-21752-1	1005
25700-90J01	18-8373	489	3852691	18-0887	1004	985727	18-21753	937
25700-92J00	18-8374	489	3852095	18-0889	1002	3853862-5	18-21753	1005
25700-93J00	18-8380	488	3852477	18-0891	1003	832675	18-2199	1005
25700-99E00	18-8381	488	3850595	18-0893	1004	3850814	18-2337	1007
25700-95J00	18-8385	490	3853361	18-0903	1003	3852384	18-2339	1007
25700-98J00	18-8386	490	3852120	18-0929	992	876279	18-2366	1007
18510-45H10	18-8870	487	3850496	18-0943-2	917	943414	18-2367	995
990C0-10W40-1QT	18-9551-2	205	3850496	18-0943-2-9	988	873228	18-2432	1005
990C0-10W40-1GL	18-9551-3	205	3850426	18-1074	1006	873229	18-2433	1005
37110-99-E00	MP51010	25, 478	3888916	18-1076	1010	3857846-4	18-2434	578
37110-99-E00	MP51012	25, 478	3853341	18-1213	998	3854539	18-2454	945, 1008
3A0060401M	18-5133	473	3853827	18-1230	998	430017	18-2518	1003
3A0060481M	18-5133	473	3854095	18-1231	1002	831622	18-2519	1004
3G2060602M	18-5134	473	3853510	18-1232	1003	430018	18-2525	1004
368060210M	18-5143	473	3853528	18-1234	998	3863085	18-25250	1004
UNIVERSAL			3856138	18-1237	1003	853868	18-25251	1004
301068	18-6140	577	912979	18-1238	1000	430172	18-2526	1004
301069	18-6141	577	3850379	18-1238	1000	831617	18-2527	1004
288182	18-6263	652	3853343	18-1239	1003	831891	18-2528	1004
288759	18-6263	652	3856127	18-1400	997	831892	18-2529	1004
299381	18-7884	200, 690	985316	18-1401	997	1336255	18-2530	1004
88-831	18-8613	227	3853847	18-1401	997	3547991	18-2530	1004
VALEO			502036	18-1402	997	834476	18-2531	1004
2541451	18-5939	971	3854033	18-1402	997	3888821	18-2583	1011
A13N234	18-5939	971	1218674	18-1478	994	3888822	18-2584	1011
541663	18-5943	971	461511	18-1479	994	3850594	18-2586	1010
A13N259	18-5943	971	3852023	18-1501	1008	875422	18-2596	999
A13N147M	18-5959	970	958303	18-15325	984	3855275	18-2598	1010
A13N148M	18-5959	970	958310	18-15390	984	875192	18-2625	1011
A13N1M	18-5959	970	958311	18-15405	984	3888917	18-2726	1010
A13N2M	18-5959	970	950813	18-15410	984	875826	18-2744	1006
2939590	18-5975	679	958357	18-15415	984	876294	18-2744	1006
2937430	18-5976	971	841821	18-15430	984	875827	18-2755	1006
A0002655299	18-6848	97	958314	18-15435	984	875828	18-2757	1006
VOLVO			966382	18-15435	984	876633	18-2757	1006
847741	18-0032	200, 690, 996	3858462	18-15450	984	875848	18-2758	1006
21707133	18-0033	200, 690, 996	3852464	18-15455	984	876631	18-2758	1006
477556	18-0034	200, 690, 996	829207	18-15460	984	3854127	18-2765	1006
3582732	18-0035	200, 690, 995	950818	18-15460	984	834751	18-2766	1006
3582733	18-0036	200, 690, 995	958320	18-15495	984	875847	18-2774	991
3852824	18-0147	1004	952141	18-15500	984	875822	18-2775	991
3852096	18-0164	925	803762	18-1727	995	832831	18-2776	991
3852455	18-0183-1	661, 1002	3857856	18-1848	987	854031	18-2777	991
3853742	18-0183-1	661, 1002	3863061	18-1909-1	988	832846	18-2778	991
804190	18-0184	1007	3863061	18-1909-1	988	3852696	18-2779	917, 981
876314	18-0252	999	3855270-9	18-1909-1	916, 988	3852741	18-2780-1	981
861250	18-0307	1003	3855270-9	18-1909-1	916, 988	3863450	18-2780-1	981
861251	18-0310	1003	855387	18-1930-2	987	3863450	18-2780-1	981
3854942	18-0311	1003	834438-4	18-1930-2	987	3852742	18-2781	917, 981
3852656	18-0322	1005	835804	18-1931-1	987	3850597	18-2791	1011
3853342	18-0327	1003	856883	18-1931-1	987	875550	18-2793	995
3852693	18-0347	927	856894	18-1932	987	845363	18-28050	190, 196, 197, 962, 964, 966
3852818	18-0352	1003	856891	18-1935-1	988			
			855384-4	18-1935-1	988	876302	18-2813	999
			857037	18-1936	987, 989	876306	18-2814	999
			3847501	18-1986-1	987	3852692	18-2815	1002

Volvo (Cont.)			Volvo (Cont.)			Volvo (Cont.)		
O.E. #	SIERRA #	PAGE #	O.E. #	SIERRA #	PAGE #	O.E. #	SIERRA #	PAGE #
878359	18-2817	1001	875680	18-3078	982	914930	18-3879	1001
876433	18-2818	1001	875736	18-3078	982	3854299	18-3879	1001
3852127	18-2858	1002	2430184	18-3078	982	3853732	18-3883	1001
3850495	18-2875-1	989	3586498	18-3079	963	3853511	18-3887	1001
3850495	18-2875-1-9	918	875807-0	18-3079	983	3853268	18-3937	997
3852468	18-2902-1	990	875808	18-3080	983	3853960	18-3937	997
3852468	18-2902-1-9	990	3858256	18-3081	983	328516	18-3938	997
856116	18-2909	988	3862281	18-3081	983	914557	18-3938	997
3853412	18-2909	988	875811-2	18-3081	983	914556	18-3939	997
418870	18-2922	Obsolete	806256	18-3106	981	3854252	18-3939	997
419678	18-2923	1003	831009	18-3106	981	370409	18-3944	997
430039	18-2924	1003	858467	18-3175	978	833950	18-4005	995
461092	18-2925	1002	875574	18-3205	983	914445	18-4024	998
1378913	18-2925	1002	875584	18-3208	983	3853226	18-4024	998
463587	18-2926	1003	875383	18-3209	983	463377	18-4029	994
1378864	18-2926	1003	875769	18-3261	983	1306630	18-4031	998
463999	18-2927	1003	875759	18-3262	983	834548	18-4044	994
1378909	18-2927	1003	875698	18-3263	983	966694-2	18-4044	994
824633	18-2928	1002	808007	18-3274	982	958498	18-4046	994
856044	18-2928	1002	877066	18-3275	982	966857	18-4046	994
856028	18-2929	1005	3862567	18-3276-1	982	812994	18-4150	991
1266796	18-2930	1002	21213660	18-3276-1	982	915236	18-4160	997
1378879	18-2930	1002	3862281	18-3277	982	3853477	18-4160	997
3854215	18-29322	958	876120	18-3287	982	914816	18-4161	997
3854217	18-29322	958	3852315	18-32882	1011	3853340	18-4161	997
416033	18-2933	1002	3856884	18-33800	980	3911023	18-4164	997
1317466	18-2933	1002	3588475	18-3504	982	3911020	18-4173	997
829714	18-2934	1004	21124846	18-3506	981	3852350	18-4194	1008
418411	18-2935	1004	3831424	18-3538	992	477024	18-4200	995
418445	18-2936	1004	3831426	18-3539	992	192212	18-4201	995
418412	18-2937	1004	859428	18-35442	976	826341	18-4204	1007
814356	18-2939	1005	3582310	18-35443	688	876278	18-4204	1007
908611	18-2946	1000	858459	18-35444	688	832820	18-4205	1007
3853338	18-2946	1000	21148403	18-3557	991	832570	18-4206	1007
835966	18-2949	1002	3853799	18-3558	991	839423	18-4208	1007
856034	18-2949	1002	856609	18-3577-2	981	839534	18-4209	1007
419310	18-2965	1000	3855991	18-3577-2	981	850785	18-4210	1007
419763-8	18-2965	1000	3853796	18-3584-1	981	854045	18-4210	1007
462623	18-2966	1000	841640	18-3586-1	981	850888	18-4211	1007
1378645	18-2968	1000	3854017	18-3593	978	850889	18-4212	1008
1378646	18-2970	1000	3858340	18-3593	978	851261	18-4213	1008
835908-5	18-2971-1	990	835390	18-3599-2	981	854047	18-4213	1008
856039-3	18-2971-1	990	856364	18-3599-2	981	897367	18-4214	650, 1008
1378870	18-2972	1003	3853850	18-3599-2	981	941816	18-4215	1008
418265	18-2974	1002	3587597	18-3615	993	807036	18-4216	990
875401	18-2980	1000	875779	18-3654	992	82745	18-4218	990
876356	18-2980	1000	875781	18-3656	992	829592	18-4219	Obsolete
875569	18-2982	1000	876097	18-3656	992	832965	18-4234	1007
876358	18-2982	1000	875784	18-3658	992	941907	18-4236	991
875400	18-2983	1000	877349	18-3658	992	943218	18-4238	943, 1008
876342	18-2983	1000	875785	18-3659	992	897873	18-4239	1008
824677	18-2989	1002	875787	18-3660	992	951924	18-4241	1008
832669	18-2990	1005	3831425	18-3660	992	463902	18-4245	995
855383	18-2991-1	1002	875794	18-3662	992	463903-5	18-4246	995
855967	18-2991-1	990, 1002	876305	18-3662	992	804261	18-4259	1004
855383	18-2991-1-9	990, 1002	875791	18-3663	992	876380	18-4341	999
855967	18-2991-1-9	990, 1002	875795	18-3664	992	876376	18-4342	999
430020	18-2994	Obsolete	875796	18-3665	992	3850379	18-4408	989
856037	18-2995	1002	875580	18-3666	992	833188	18-4463	994
3852560	18-2996	1005	3853983	18-3676	992	829620	18-4464	994
876300	18-2998	1000	3856961	18-3677	992	3582609	18-4465	994
875808-8	18-3036	983	3854018	18-36905	975	838637	18-4466	994
875660	18-3037	982	3850984	18-3708-1	1008	1542472	18-4467	994
875736	18-3037	982	3852005	18-3722	1008	419734	18-4468	994
2430184	18-3037	982	3852648-9	18-3730	1007	1542389	18-4469	994
3841697	18-3038	982	3852255	18-3744	1008	419735	18-4470	994
877061-2	18-3038	982	17253-6	18-3745	1008	838638	18-4471	994
3854286	18-3046	982	833453	18-3834	1001	1218630	18-4472	994
835874	18-3047	982	833274	18-3842	1001	419653	18-4473	994
835512	18-3060	982	859155	18-3843	Obsolete	3582561	18-4473	994
3854286	18-3060	982	859647	18-3867	1001	419652	18-4474	994
835874	18-3061	982	3583786	18-3868	1001	3582606	18-4474	994
875575	18-3075	982	3854202	18-3869	1001	3854003	18-5107-1	959
833995	18-3076	982	876303	18-3870	999	3854001	18-5108	659
875583	18-3076	982	3853587	18-3873	Obsolete	3854217	18-5248	968
3841697	18-3077	982	841207	18-3876	1001	835705	18-5303	957
877061-2	18-3077	982	856474	18-3876	1001	855846-2	18-5303	957
21213664	18-30778	982	912227	18-3879	1001	243460	18-5305	957

Volvo (Cont.)			Volvo (Cont.)			Volvo (Cont.)		
O.E. #	SIERRA #	PAGE #	O.E. #	SIERRA #	PAGE #	O.E. #	SIERRA #	PAGE #
243799	18-5305	957	841766	18-5959	970	3861575	18-6804	973
1306189	18-5305	957	841380	18-59700	970	3587079	18-6806	973
240149	18-5306	957	841762	18-59700	971	3857489	18-6806	973
818701-5	18-5310	957	841763	18-59700	972	3860879	18-6806	973
835304	18-5314	957	841765	18-59700	973	3858071	18-6817	973
243801	18-5319	957	841766	18-59700	974	852928	18-6838	973
835308	18-5338	957	3803227	18-59700	975	872449	18-6838	973
243653	18-5342	Obsolete	3803227-2	18-59700	976	873051	18-6838	973
835704	18-5345	957	834625-6	18-59700	977	3586765	18-6838	973
834560	18-5348	957	841378-3	18-59700	978	1357199	18-6839	970
841262	18-5349	957	820652	18-59710	979	3523301	18-6839	970
841070	18-5352	958	822454	18-59710	970	5003564	18-6839	970
3853815	18-5352	958	827303	18-59710	971	1357199-7	18-6839	970
841926	18-5353	958	847651	18-59710	972	3523301-4	18-6839	970
3854548	18-5354	958	849561	18-59710	973	5003564-1	18-6839	970
243797	18-5356	958	849602	18-59710	974	3862613	18-6845	971
243632	18-5357	958	3860082	18-5979	970	3862665	18-6845	971
870690	18-5357	958	832598	18-6000	1009	3884950	18-6845	971
1243632	18-5357	958	873179	18-6000	1009	2655301	18-6847	971
841263	18-5358	958	832598	18-6000A	1009	3862613	18-6847	971
3854331	18-5362	958	873179	18-6000A	1009	2656299	18-6848	971
835702	18-5369	958	838929	18-6001	1009	3862612	18-6848	971
841244	18-5375	958	852835	18-6004	1009	233991	18-6872	680, 970
241669	18-5393	958	873178	18-6004	1009	240501	18-6872	680, 970
243658	18-5394	958	852835	18-6004A	1009	837924	18-6872	680, 970
841907	18-5403	957	873178	18-6004A	1009	842775	18-6872	680, 970
855845	18-5403	957	875805	18-6005	1009	843511	18-6872	680, 970
3853801	18-5403	957	875815	18-6009	1009	881681	18-6872	680, 970
3854549	18-5405	958	875815	18-6009A	1009	847306-8	18-6872	680, 970
3862014	18-5405	958	875821	18-6010	1009	852928	18-6881	973
3854261	18-5406	958	875821	18-6010A	1009	872449	18-6881	973
3854311	18-5408	958	838928	18-6021	1010	3583555	18-6944	680
841243	18-5411	958	984513	18-6028	945	21323043	18-6944	680
3854218	18-5413	958	3855411	18-6028	945	851120	18-6951	973
818525	18-5419	958	3863193	18-6028A	1009	3803645	18-6953	679
834975	18-5425	958	3855412	18-6102	945	8602629	18-6953	679
243903	18-5428	958	832598	18-6104	1009	8602710	18-6953	679
835998	18-5433	959	873179	18-6104	1009	8602714	18-6953	679
35254	18-5436	959	852835	18-6105	1009	8676496	18-6953	679
3854002	18-5443	959	873178	18-6105	1009	8676498	18-6953	679
21436799	18-5467	959	875821	18-6106	1009	8676499	18-6953	679
855798	18-5657	964	873395	18-6123Z	1009	849748-9	18-6955	679, 971
3858081	18-5700	973	872793	18-6124Z	1009	3854164	18-69550	972
3858809	18-5700	973	3586461	18-6125A	1009	6209190	18-6956	970
876037	18-5704	973	3855610	18-6125M	1009	870998	18-6958	680, 970
876039	18-5705	973	3854130	18-6125Z	1009	881682	18-6958	680, 970
3287677	18-5745	959	3888816	18-6126A	1009	847308-4	18-6958	680, 970
876069	18-57702	201, 995	3888818	18-6126M	1009	841292	18-7000	974
834520	18-5806	972	3888817	18-6126Z	1009	856471	18-7000	974
3850216	18-5811	972	3888813	18-6127A	1009	856472	18-7000	974
3859054	18-5811	972	3888815	18-6127M	1009	841836-0	18-7000	974
3884950	18-5882	970	3888814	18-6127Z	1009	841293-4	18-7001	974
3853787	18-5897	980	3857561	18-6261	970	838513	18-70704	984
3857532	18-5899	980	3856600-6	18-6261	970	856306	18-70704	984
841066-4	18-5903	969	3857813	18-6265	970	855889	18-7072	974
840808	18-5906	969	872300	18-6266	973	875407	18-7085	974
872241	18-5906	969	876040	18-6266	973	841994	18-7086	975
834893	18-5911	891	841177	18-6268	973	834985-4	18-7095	975
855326	18-5911	969	872272	18-6268	973	824803	18-7099	975
3587625	18-5913-1	969	241812	18-6271	973	856470	18-7099	975
3853982	18-5913-1	969	870670	18-6271	973	3852073	18-7102	1011
3854751	18-5913-1	969	876038	18-6271	973	3852604	18-71048-2	1006
3856004	18-5913-1	969	6643474	18-6271	973	853012	18-71064-2	1006
3860764	18-5913-1	969	852928	18-6274	974	3852045	18-7116	951
3885317	18-5913-1	969	3857265	18-6274	974	925095	18-7122	1011
3856003	18-5919-1	891	3857747	18-6275	S/S to 18-6275-1	3852089	18-7135	1011
3854190	18-5920	969	3860566	18-6275	S/S to 18-6275-1	3852165	18-7141	1011
872235	18-5939	971	3854194-2	18-6291	893	3852169	18-7143	368, 951
873770	18-5939	971	855507	18-6456	Obsolete	955989	18-7149	255, 1011
3803260	18-5939	971	850834	18-6758	974	949656	18-7154	1011
872926	18-5943	971	854346	18-6770	973	3852044	18-7162	1011
3803227	18-5943	971	986280	18-6779	974	3852033	18-7168	1011
3860769	18-5957	970	3853945	18-6779	974	125017	18-7178	1011
826495	18-5959	970	839430	18-6790	974	925054	18-7179	1011
834609	18-5959	970	850046	18-6791	974	925055	18-7180	1011
834963	18-5959	970	852520	18-6791	974	925091	18-7181	993, 1011
841762	18-5959	970	854329	18-6792	974	975672	18-7181	993, 1011
841765	18-5959	970	897722	18-6792	974	925092	18-7182	489, 1011

Volvo (Cont.)			Volvo (Cont.)			YAMAHA		
O.E. #	SIERRA #	PAGE #	O.E. #	SIERRA #	PAGE #	O.E. #	SIERRA #	PAGE #
925093	18-7183	489, 1011	862293	18-7888	981	67C-W0001-21-00	18-0020	Obsolete
925256	18-7184	1011	463505	18-7890	995	688-W0001-22-00	18-0021	564
925259	18-7186	1011	876185	18-7890	995	689-W0001-23-00	18-0022	564
925261	18-7187	1011	3825038	18-79007	980	689-W0001-C2-00	18-0023	564
955983	18-7188	1011	858488	18-7907	995	698-W0001-21-00	18-0024	564
925065	18-7190	1011	3582358	18-7908	995	69G-W0001-20-00	18-0025	564
955995	18-7192	1011	423135	18-7926	200, 691	6A1-W0001-22-00	18-0026	565
955974	18-7193	1011	4785974	18-7926	200, 691	6A1-W0001-23-00	18-0027	565
956000	18-7194	1011	466987	18-7942	157, 688, 979	6E0-W0001-C1-00	18-0028	565
841634-9	18-7200	975	3825133	18-7942	157, 688, 979	6G1-W0001-C1-00	18-0029	565
3854026	18-7229	975	3827069	18-7974	202, 996	6L2-W0001-C3-00	18-0030	565
3854020	18-7238	976	3852413	18-7989	155, 292, 904, 978	6N0-W0001-C0-00	18-0031	565
3855017	18-7241	975	3862228	18-7989	155, 292, 904, 978	YSC-13080-00-0C	18-0164	1013
3854105	18-7242	975	3851218-2	18-7989	155, 292, 904, 978	92990-06800-00	18-0191	522
3854106	18-7244	975	R80316	18-79998	974	92990-10600-00	18-0192	534
3854107	18-7245	975	R7044289	18-80008	974	92900-10600-00	18-0192	534
3854116	18-7246	975	8692305	18-8003-1	202, 996	92901-10600-00	18-0192	534
3855276	18-7268	167, 978	3852170	18-8020	981	92902-10600-00	18-0192	534
826493	18-7281	167, 976	3852529	18-8021	981	92903-10600-00	18-0192	534
841161	18-7286	168, 976	829913	18-8124	157, 688, 979	92995-10600-00	18-0192	534
853548	18-7306	1006	3583443	18-8125	157, 688, 979	855-12414-A1-00	18-0232	548
3850809	18-7326	168, 978	861477	18-8126	157, 688, 979	688-44315-A0-00	18-0239	548
3854620	18-7326	168, 978	3847644	18-8149	155, 979	688-44316-A0-00	18-0240	549
3857986	18-7326	168, 978	3852171	18-8200	981	663-13622-00-00	18-0242	543
3858261	18-7326	168, 978	3852172	18-8202	981	663-13622-A0-00	18-0242	543
988037	18-7330	168, 978	329653	18-8203	981	6E5-44315-A0-00	18-0244	549
3854280	18-7330	168, 978	324825	18-8204	981	664-41114-A0-00	18-0250	538, 548
3855958	18-7330	168, 978	875741	18-8357	1011	97080-08045-00	18-0256	515
3857650	18-7330	168, 978	876267	18-8358	1011	97095-08045-00	18-0256	515
3850810	18-7331	168, 978	876268	18-8359	1011	90119-08M33	18-0260	523
3857985	18-7331	168, 978	576266-8	18-8361	1011	97080-06045	18-0261	522
3858714	18-7331	168, 978	813967	18-8368	1007	93101-28M16-00	18-0265	568
3852523	18-7406	951	878532-3	18-8801-1	190-199, 962	93101-30M17-00	18-0266	568
3852531	18-7407	951	8757166	18-8802-1	190-199, 962	93106-09014-00	18-0267	568
3854161	18-7492	958	875571	18-8813-1	190-199, 962	93210-97M55-00	18-0275	568
3859078	18-7493	958	8757166	18-8823-1	190-199, 962	663-44315-A0-00	18-0292	549
826423	18-75125	984	3853804	18-8964	995	663-44324-A0-00	18-0294	549
845792	18-75125	984	3847547	18-9086	1006	93101-22067-00	18-0296	568
3862500	18-7513	20, 980	174448	18-9098	1006	93101-23070-00	18-0297	568
3854158	18-7601	980	3842343	18-9410-2	207	93210-41042-00	18-0298	568
3856393	18-7641	974	3842344	18-9410-4	207	93210-66M98-00	18-0299	568
841047-4	18-7641	974	3858061	18-9410-7	207	60X-43315-A0-00	18-0406	541
841313-0	18-7641	974	40005011	18-9553-2	205	65N-44323-00	18-0408	523
3863130	18-7642	959	40005012	18-9553-3	205	89M-G4323-00	18-0409	523
3859082	18-7643	959	40005013	18-9553-5	205	6AW-44323-00	18-0421	522
872066	18-7647	980	40005014	18-9553-7	205	6CJ-44315-00	18-0448	523
3861267	18-7648	959	1141679	18-9680-2	214	6CJ-44316-00	18-0449	523
3850357	18-7677	896	1141681	18-9680-5	214	6CJ-44324-00	18-0450	523
3854905	18-7679	896	1141682	18-9680-7	214	6CB-44315-00-00	18-0451	522
3850396	18-7684	980	949658-9	18-7147-9	1011	6AW-44315-00	18-0452	522
3858941	18-7685	980				65N-44315-A0	18-0453	523
3855182	18-7689	980				63D-44316-00-00	18-0483	548
3857487	18-7700	980	22844837	18-3513	981	93101-20M07-00	18-0554	568
3854527	18-7702	980	3852215	18-5894	20, 905, 980	93102-23096-00	18-0570	538, 568
3854512	18-7703	980	854525-3	18-6817	973	93101-25M03-00	18-0587	568
3855194	18-7704	980	820545	18-6822	973	93102-25M28-00	18-0588	568
3843751	18-7705	980	852928	18-6822	973	67F-41138-00-00	18-0605	541
3858979	18-7706	959	72021	18-6846	679, 971	67F-45127-00-00	18-0617	541
3808516	18-7708	Obsolete	845940	18-6846	679, 971	68V-45123-00-00	18-0618	541
3840335	18-7709	979	872022	18-6846	679, 971	69J-41138-00-00	18-0619	541
3855296	18-7757	959	872757	18-6846	679, 971	69J-45123-00-00	18-0656	541
3850861	18-7776	155, 978	873635	18-6846	679, 971	6CB-13016-00	18-0707	504
273663	18-7783	Obsolete	873757	18-6846	679, 971	68V-14984-00	18-0710	503
3852413	18-7789	155, 978	1502272	18-6846	679, 971	66K-14984-00	18-0711	503
3851218-2	18-7789	155, 978	5001677	18-6846	679, 971	63P-14984-00	18-0712	503
3855104	18-7792	979	3803270-2	18-6846	679, 971	6P2-14984-00	18-0713	503
835440	18-7824-2	201, 959	873757-9	18-6846	679, 971	6AW-14984-00	18-0714	503
858201	18-7858	153, 688, 979	873771	18-6846	679, 971	65L-14984-00	18-0715	504
835576	18-7859	979	22797780	18-7514	995	6CB-14984-00	18-0716	504
841162	18-7862	979	3840525	18-7962	996	6C5-14984-00	18-0717	504
3850559	18-7876-1	201	861476	18-8701	996	689-45113-A1-00	18-0739	548
430143	18-7878-1	201, 995	30788490	18-8702	996	6L2-41112-A1-00	18-0743	548
1266286	18-7878-1	201, 995				6L2-41114-A1-00	18-0744	548
3517857	18-7878-1	201, 995				6G1-44315-A0-00	18-0753	548
841750	18-7879-1	201, 995	30220	18-7910-1	200, 691	68D-E2414-A0-00	18-0754	548
466634	18-7880	201, 995	21235	18-7925	200, 691	90430-14228-00	18-0755	541
834337	18-7884	201, 995				904-30142-28-00	18-0755	541
826648	18-7888	981				90430-14M09-00	18-0755	541

Yamaha (Cont.)			Yamaha (Cont.)			Yamaha (Cont.)		
O.E. #	SIERRA #	PAGE #	O.E. #	SIERRA #	PAGE #	O.E. #	SIERRA #	PAGE #
6H3-44315-A0-00	18-0756-1	549	6L2-44367-00	18-1836	515, 522	6F5-44352-00-00	18-3088	513
6H3-44324-A0-00	18-0757	549	6L2-44367-10	18-1837	515, 523	68T-44323-00-00	18-3142	519
6L2-14384-00-00	18-0765	550	6EE-G4366-00	18-1840	515, 522, 523	67F-44323-00-00	18-3143	520
688-11193-01-00	18-0767	548	93101-22M15-00	18-2079	537, 568	682-W0078-A1-00	18-3148	516
682-44315-A0-00	18-0768	550	64E-43822-00-00	18-2081	500	67F-44322-00-00	18-3162	520, 524
648-14198-A0-00	18-0775	538	64E-4384J-00-00	18-2082	500	6L5-44323-00-00	18-3163	525
6G5-11193-A0-00	18-0779	548	68V-13766-00-00	18-2083	500, 511	6L5-44322-00-00	18-3164	523, 525
6E5-11193-A0-00	18-0781	548	93102-35M13-00	18-2085	537, 568	6E0-44366-00-00	18-3166	516
6E5-11381-A1-00	18-0782	548	93102-40M36-00	18-2087	568	6E5-44311-00-00	18-3170	514
6E5-14198-A1-00	18-0785	547	93104-22M07-00	18-2091	568	688-44311-01-00	18-3171	514
6E5-14384-02-00	18-0786	547	65W-85570-01-00	18-23205	Obsolete	61A-44311-00-00	18-3173-1	514
6H4-41114-A0-00	18-0798	548	68M-85570-00-00	18-23601	Obsolete	61A-44311-01-00	18-3173-1	514
6E5-41112-A1-00	18-0799	548	63V-85570-00-00	18-23602	Obsolete	68T-44366-00-00	18-3176	516
6K7-13845-A1-00	18-0807-1	547	90340-08002-00	18-2371	550, 559, 559	61N-44311-00-00	18-3185	514
6G5-11382-A1-00	18-0808	547	90340-08M04-00	18-2371	550, 559, 559	61N-44311-01-00	18-3185	514
6G5-13645-A1-00	18-0809	547	90340-08002-00	18-23711-9	550	63D-44323-00-00	18-3186	519
6G5-41112-A1-00	18-0812	548	90340-08M04-00	18-23711-9	550	61N-44323-00	18-3194	522
6G5-45113-A0-00	18-0813	548	688-45341-00-00	18-2374	550	63V-44323-00-00	18-3195	518
6H4-11193-A1-00	18-0815	548	688-45341-10-00	18-2374	550	66T-44323-00-00	18-3196	519
6E5-13645-A1-00	18-0823	548	688-45341-00-00	18-23741-9	Obsolete	90280-03M03-00	18-3297	515
90430-14115-00	18-0826	550	688-45341-10-00	18-23741-9	Obsolete	90280-04M00-00	18-3300	411
61A-12414-A0-00	18-0829	548	91401-30028-00	18-2380	551	90280-04M04-00	18-3301	411
6J8-12414-A0-00	18-0829	548	91401-30030-00	18-2380	551	90280-04M05-00	18-3302	411
62Y-12414-00-00	18-0835	548	91402-30022-00	18-2380	551	90280-03003-00	18-3305	515
682-12414-A1-00	18-0836	548	91402-30022-09	18-2380	551	90280-03024-00	18-3305	515
676-14984-00-00	18-0840-1	547	91402-30028-00	18-2380	551	6G5-W0078-01-00	18-3310	516
688-12414-A1-00	18-0844	548	91402-30028-09	18-2380	551	6G5-W0078-A1-00	18-3311	516
688-41112-A0-00	18-0847	548	91490-30030-00	18-2380	551	6N6-W0078-00-00	18-3312	517
650-24431-00	18-0849	541	6E5-45611-01-00	18-2385	550, 561	6N6-W0078-01-00	18-3313-1	517
650-24431-A0-00	18-0849	541	688-45611-00-00	18-2388	550	646-44322-00-00	18-3328	521
64D-14384-01-00	18-0856-1	541	90340-14M06-00	18-2456	535	61A-44322-00-00	18-3333	516, 517
YSG-10108-44-5G	18-0874	1013	66M-85540-01-00	18-25300	492	6E5-44323-00-00	18-3344	517
YSG-10108-43-8G	18-0876	1013	66M-85520-00-00	18-25600	Obsolete	6G5-44323-00-00	18-3345	516
YSG-14096-15-6G	18-0887	1013	63V-85533-00-00	18-25604	492	63V-44301-00-00	18-3356	514
YSG-10114-14-1G	18-0889	1013	66M-85580-00-00	18-25650	492	646-44323-00-00	18-3357	521
YSG-37545-87-G0	18-0891	1013	63V-85580-01-00	18-25652	492	692-W0078-00-00	18-3370	517
YSG-38600-39-G0	18-0903	1013	6E5-14384-03-00	18-2592	547	692-W0078-01-00	18-3370	517
YSG-14090-90-8G	18-0905	1013	90119-08M87-00	18-2605	515	692-W0078-A0-00	18-3370	517
6GD-G4325-00-00	18-1079	Obsolete	90119-08M13-00	18-2606	515	692-W0078-A0-00	18-3371	517
93310-32337-00	18-1410	534	97095-06040-00	18-2607	515	6E5-W0078-01-00	18-3372	517
93310-620V5-00	18-1411	534	663-45331-00-94	18-2773	550	6E5-W0078-A1-00	18-3373	517
6M6-8183E00-00	18-15080	570	688-45331-00-94	18-2782	550, 559	61A-W0078-01-00	18-3395	517
YSC-13260-60-0C	18-15106	Obsolete	689-W0001-21-00	18-2785	565	61A-W0078-A2-00	18-3396-1	517
YSC-22260-00-0C	18-15109	1013	689-W0001-C1-00	18-2785	565	61A-W0078-A3-00	18-3396-1	517
YSC-10260-10-0C	18-15110	obsolete	698-W0001-20-00	18-2787	565	679-W0078-00-00	18-3397	518
YSC-10260-00-0C	18-15111	1013	698-W0001-C0-00	18-2787	565	679-W0078-A0-00	18-3397	518
6C5-46241-00-00	18-15130	536	6H3-W0001-21-00	18-2788	566	6F5-W0078-00-00	18-3398	518
67F-46241-00-00	18-15131	536	6H3-W0001-C1-00	18-2788	566	6F5-W0078-A0-00	18-3398	518
6P2-46241-02-00	18-15132	536	6J8-W0001-21-00	18-2789	566	663-44311-02	18-3408	518
6G8-46241-00-00	18-15133	536	6J8-W0001-C2-00	18-2789	566	6H4-W0078-00	18-3408	518
6CB-W4624-00-00	18-15134	536	6H4-W0001-20-00	18-2792	566	6H4-W0078-A0	18-3408	518
65W-46241-00-00	18-15135	536	6H4-W0001-21-00	18-2792	566	67F-44311-01	18-3409	520
6AH-46241-00-00	18-15136	536	6E5-W0001-51-00	18-2794-1	566	67F-W0078-00	18-3409	520
66M-46241-00-00	18-15137	536	6E5-W0001-F1-00	18-2794-1	566	68T-W0078-00-00	18-3410	519
68T-46241-00-00	18-15138	536	6F3-W0001-21-00	18-2794-1	566	682-W0078-A1-00	18-3411	516
6AW-W4624-00-00	18-15139	536	6F3-W0001-C1-00	18-2794-1	566	63V-44301-00	18-3412	518
63P-46241-00-00	18-15140	536	6G5-W0001-21-00	18-2794-1	566	63V-W0078-01	18-3412	518
69J-46241-00-00	18-15141	536	6G5-W0001-C1-00	18-2794-1	566	66T-44311-00	18-3413	519
6DA-W4624-00-00	18-15142	536	688-W0001-20-00	18-2798	566	66T-W0078-00	18-3413	519
60V-46241-00-00	18-15143	536	688-W0001-C0-00	18-2798	566	63D-W0078-01-00	18-3415	519
62Y-46241-00-00	18-15144	536	61A-W0001-21-00	18-2799	566	663-W0078-00-00	18-3425	521
68F-46241-10-00	18-15145	536	61A-W0001-C1-00	18-2799	566	663-W0078-A0-00	18-3425	521
63P-81950-00	18-1522	500	YSC-12190-00-AC	18-2909	1013	689-W0078-04-00	18-3426	521
61A-81950-01	18-1523	500	6AW-44336-00	18-3028	522	689-W0078-A4-00	18-3426	521
6H1-81950-01-00	18-1524	500	63V-44352-01-00	18-3040	513	689-W0078-A6-00	18-3427	522
60E-81950-00-00	18-1525	500	67F-44352-00-00	18-3042	513	6H3-W0078-00-00	18-3428-1	518
6J8-81960-00-00	18-17301	Obsolete	662-44352-01-00	18-3063	513	6H3-W0078-A0-00	18-3428-1	518
650-11651-04-00	18-1755	534	6L2-44352-00-00	18-3065	513, 521	6H4-W0078-00-00	18-3429	518
650-11651-04-00	18-1755K	534	6G1-44352-00-00	18-3066	513, 521	6H4-W0078-A0-00	18-3429	518
688-11650-03-00	18-1756	534	689-44352-02-00	18-3067	513	6J8-W0078-A1-00	18-3430	521
663-44366-00	18-1828	515	6H4-44352-02-00	18-3068	513	6L2-W0078-00-00	18-3431	521
6AW-44365-00-00	18-1829	515	697-44352-00-00	18-3069	528-531	61N-W0078-11-00	18-3432	522
663-44366-00	18-1830	516	6H3-44352-00-00	18-3069	528-531	63V-W0078-01-00	18-3433	518
682-44366-00	18-1831	516	688-44352-03-00	18-3070	513	63D-W0078-01-00	18-3434	519
682-44367-00	18-1832	516	6E5-44352-01-00	18-3071	513	663-44322-00-00	18-3435	518, 520, 521, 557
647-44366-00	18-1833	516	646-44352-01-00	18-3072	513	663-44323-00-00	18-3436	518, 521
682-44365-00-00	18-1834	516	6E0-44352-00-00	18-3073	528-531	66T-W0078-00-00	18-3440	519
6E5-44365-00-00	18-1835	516	682-44352-01-00	18-3074	513	68V-W0078-00-00	18-3442	519

Yamaha (Cont.)			Yamaha (Cont.)			Yamaha (Cont.)		
O.E. #	SIERRA #	PAGE #	O.E. #	SIERRA #	PAGE #	O.E. #	SIERRA #	PAGE #
61N-44322-01-00	18-3443	522	689-11181-02-00	18-3804	539	6H4-W0001-03-00	18-4409	Obsolete
63V-44322-00-00	18-3444	518, 519	689-W0001-A1-00	18-3804	539	6H4-W0001-04-00	18-4409	Obsolete
63D-44322-00-00	18-3449	519	688-11181-02-00	18-3805	539	6N6-W0001-03-00	18-4411	537
68T-W0078-00-00	18-3450	519	688-11181-A1-00	18-3805	539	6N6-W0001-A3-00	18-4411	537
67F-W0078-00-00	18-3451	520	6G8-11181-00-00	18-3827	539	6R3-W0001-03-00	18-4412	Obsolete
6G1-44322-00-00	18-3456	521	6G8-11181-A1-00	18-3827	539	6R3-W0001-A3-00	18-4412	Obsolete
6AW-44322-00-00	18-3457	520	6E7-11181-00-00	18-3828	539	6R6-W0001-01-00	18-4413	538
6CE-44315-00-00	18-3458	520	6E7-11181-A1-00	18-3828	539	688-W0001-00-00	18-4415	538
6CE-44323-01-00	18-3459	520	6J8-11181-00-00	18-3829	539	688-W0001-A0-00	18-4415	538
6G1-W0078-01-00	18-3460	521	6J8-11181-A1-00	18-3829	539	695-W0001-01-00	18-4417	538
6G1-W0078-A1-00	18-3460	521	6H4-11181-00-00	18-3830	539	695-W0001-02-00	18-4417	538
6N0-W0078-A0-00	18-3460	521	6H4-11181-A1-00	18-3830	539	695-W0001-A2-00	18-4417	538
66M-14301-00-00	18-34600	502	6H3-11181-01-00	18-3831	539	6H4-W0001-02-00	18-4419	538
66M-14301-12-00	18-34600	502	6H3-11181-A1-00	18-3831	539	6H4-W0001-A2-00	18-4419	538
67D-14301-13-00	18-34601	502	6E5-11181-02-00	18-3832	539	6L2-W0001-01-00	18-4422	Obsolete
63V-14301-00-00	18-34603	502	6E5-11181-A1-00	18-3832	539	6L2-W0001-02-00	18-4422	Obsolete
69M-14301-11-00	18-34604	502	6L2-11181-A1-00	18-3847	539	6L2-W0001-A2-00	18-4422	Obsolete
66T-14301-00-00	18-34605	502	6L2-11181-A2-00	18-3847	539	6H3-W0001-A0-00	18-4427	538
6H3-W0078-00-00	18-3461	518	697-11181-A0-00	18-3848	539	6FM-W0078-00-00	18-4527	523
6H3-W0078-A0-00	18-3461	518	697-11181-A1-00	18-3848	539	6EG-W0078-00-00	18-4532	523
6A1-W0078-02-00	18-3462	521	695-11181-A0-00	18-3849	539	65N-W0078-A0-00	18-4533	523
6A1-W0078-01-00	18-3463	521	695-11181-A1-00	18-3849	539	69M-WG078-00-00	18-4534	523
6H3-W0078-01-00	18-3465	520	61A-11181-A0-00	18-3891	539	6EE-G4322-00	18-4546	522
6H3-W0078-02-00	18-3465	520	61A-11181-A1-00	18-3891	539	6EG-G4322-00	18-4547	523
6H3-44311-00	18-3466	520	676-11181-A0-00	18-3892	539	6L2-44322-00	18-4548	523
6H3-W0078-01	18-3466	520	676-11181-A1-00	18-3892	539	6EE-G4311-00	18-4567	522
6H3-W0078-02-00	18-3466	520	6G5-11181-00-00	18-3894	539	6CE-44352-00-00	18-45617-1	514
6CE-W0078-01	18-3470	520	6G5-11181-A0-00	18-3894	539	6CB-44323-00-00	18-4572	522
6CE-W0078-01 +			6R5-11603-00	18-39320	533	6EE-G4323-00	18-4573	522
6CE-44311-01	18-3471	520	6E5-11610-03-00	18-3934	533	6EG-G4323-00	18-4574	523
6EE-W0078-00-00	18-3473	522	6E5-11610-23-00	18-3936	534	6FM-44323-01	18-4576	523
6CB-W0078-00-00	18-3474	522	61N-11603-00-00	18-3957	533	90430-08020-00	18-4698	880, 1003
69G-W0078-00	18-3475	522	6H4-11610-00-00	18-3960	533	90430-08020-00	18-46981-9	880, 1003
6AW-W0078-00-00	18-3477	522	6H4-11610-10-00	18-3961	533	68D-WG078-00-00	18-48619	522
6AH-W0078-00	18-3479	522	6H4-11610-20-00	18-3962	533	689-15755-01-00	18-50000	499
6CE-44311-01-00	18-3482	514	6K5-11601-02-00	18-3963	533	6G1-15779-00-00	18-50000	499
6AW-44311-01-00	18-3483	514	688-11603-A0-00	18-3969	533	6G1-15755-00-00	18-50001	499
6AH-44311-00-00	18-3484	514	682-11610-01-00	18-3976	533	6G1-15779-00-00	18-50001	499
6CJ-44311-00-00	18-3485	514	682-11610-11-00	18-3977	533	63V-15713-00-00	18-51001	550
6L2-44311-01-00	18-3486	514	93310-730V8-00	18-4077	534	67D-15713-00-00	18-51002	550
6BG-W0078-00-00	18-3490	523	93310-836V2-00	18-4078	534	66T-15713-00-00	18-51003	550
6CJ-W0078-00-00	18-3494	523	6R5-11642-11-93	18-4080	533	6E5-85570-11-00	18-5110	491
63V-44365-10-00	18-3505	516	6R5-11631-11-93	18-4081	533	697-85570-11-00	18-5111	491
6P2-W0078-00-00	18-3515	521	6R5-11645-11-00	18-4082	533	680-85570-09-00	18-5112	491
60X-W0078-00-00	18-3516	520	6R5-11635-11-00	18-4083	533	695-85570-10-00	18-5112	491
6P2-44323-00-00	18-3518	521	6R5-11646-11-00	18-4084	533	6E7-85570-10-00	18-5112	491
61A-44322-02-00	18-3519	519	6R5-11636-11-00	18-4085	533	6E7-85570-19-00	18-5112	491
60X-44323-00-00	18-3520	520	6H3-11631-01-96	18-4091	533	61N-85570-00-00	18-5113	491
68V-44323-00-00	18-3521	519	6H3-11636-01-00	18-4093	533	61N-85570-10-00	18-5113	491
60X-W0078-00	18-3522-1	520	6K5-11636-03-00	18-4096	533	65E-85570-00-00	18-5119	Obsolete
61A-44311-01	18-3522-1	520	6H1-11631-03-95	18-4097	533	6R3-85570-01-00	18-5128	491
61A-44311-01	18-3523-1	519	6H1-11636-03-00	18-4099	533	62L-85570-00-00	18-5129	570
68V-W0078-00	18-3523-1	519	6G5-11642-00-93	18-4128	533	688-85540-16-00	18-5130	491
6CE-12411-00-00	18-3524	528	6G5-11631-00-93	18-4129	533	695-85540-12-00	18-5131	491
60V-12411-00	18-3525	528	6G5-11636-00-00	18-4133	533	63V-85540-00-00	18-5132	491
66M-24410-10-00	18-35302	505	6E7-11631-00-97	18-4135	533	63V-85540-01-00	18-5132	491
67D-24410-03-00	18-35304	Obsolete	689-11631-00-95	18-4138	533	63V-85540-02-00	18-5132	491
6E5-12411-30-00	18-3540	528	6H4-11631-00-96	18-4141	533	6E5-85540-10-00	18-5135	492
68M-12411-01-00	18-3541	528	6H4-11635-01-00	18-4142	533	6E5-85540-11-00	18-5135	492
6H3-12411-11-00	18-3622	528	6H4-11636-00-00	18-4143	Obsolete	6E5-85540-12-00	18-5135	492
6E5-12411-02-00	18-3623	528	61N-11635-00-00	18-4145	533	6F5-85540-21-00	18-5136	492
69M-12411-01-00	18-3624	528	61N-11636-00-00	18-4146	533	6F5-85540-22-00	18-5136	492
6F5-12411-03-00	18-3625	528	6R5-11650-10-00	18-4157	534	680-85570-00-00	18-5138	491
67F-12411-01-00	18-3632	528	688-45997-01-00	18-4274	550	680-85570-02-00	18-5138	491
6AW-12411-00-00	18-3634	528	68D-G4311-01-00	18-43263	514	62T-85533-00-00	18-5146	570
6DA-12411-01-00	18-3636	528	93604-18080-00	18-43716	515, 522	62T-85520-00-00	18-5147	570
6CB-12411-10-00	18-3637	528	93604-10M03-00	18-43717	559	62T-85520-01-00	18-5147	570
6EK-12411-00-00	18-3639	528	61A-W0001-01-00	18-4400	537	63V-85520-00	18-5183	491
6FP-12411-00-00	18-3641	528	61A-W0001-A1-00	18-4400	537	63V-85520-01	18-5183	491
647-45616-02	18-3709	552	6F3-W0001-04-00	18-4403	537	689-81311-40-00	18-5195	491
90171-16011-00	18-3732	552	6F3-W0001-A4-00	18-4403	537	67F-82341-00-00	18-5217-1	492
95307-16900-00	18-3732	552	6G5-W0001-03-00	18-4404	Obsolete	67F-82342-00-00	18-5218-1	492
91490-40030-00	18-3735	551	6G5-W0001-A3-00	18-4404	Obsolete	67F-82343-00-00	18-5219-1	492
91490-30045-00	18-3748	551	6H1-W0001-00-00	18-4405	537	67F-82344-00-00	18-5220-1	492
90171-10M01	18-3773	552	6H1-W0001-01-00	18-4405	537	689-81840-11-00	18-56002	Obsolete
6H1-W4599-00-00	18-3781	552	6H1-W0001-A0-00	18-4405	537	663-81840-11-00	18-56004	Obsolete
6G5-W4599-00-00	18-3782	552	6H4-W0001-01-00	18-4407	Obsolete	6E5-81840-10-00	18-56005	479
90171-14056-00	18-3792	552	6H4-W0001-A1-00	18-4407	Obsolete	6N7-81840-00-00	18-56006	Obsolete

Yamaha (Cont.)			Yamaha (Cont.)			Yamaha (Cont.)		
O.E. #	SIERRA #	PAGE #	O.E. #	SIERRA #	PAGE #	O.E. #	SIERRA #	PAGE #
61A-81840-00-00	18-56007	479	61A-43880-02-00	18-6782	499	6A0-24410-05-00	18-7334	505
6H3-85510-A1	18-5746	495	64E-43880-00-00	18-6783	499	69J-13907-04-00	18-7339	505
65W-81941-00-00	18-5819	495	64E-43880-01-00	18-6783	499	68V-13907-00-00	18-7340	505
6G1-81941-10-00	18-5821	495	67F-43880-00-00	18-6787	499	68V-13907-01-00	18-7340	505
61A-81941-00-00	18-5853	495	6H5-43880-02-00	18-6788	499	68V-13907-02-00	18-7340	505
6E5-81941-10-00	18-5853	495	62X-43880-09-00	18-6789	499	68V-13907-03-00	18-7340	505
6E5-81941-11-00	18-5853	495	60V-43880-00-00	18-6798	499	66K-13907-00-00	18-7341	505
688-81941-00-00	18-5879	495	69J-43880-00-00	18-6798	499	68F-13907-00-00	18-7342	505
688-81950-10-00	18-5879	495	62X-43880-00-00	18-6811	499	68F-13907-01-00	18-7342	505
6K1-45371-00-00	18-6034	551	62X-43880-01-00	18-6811	499	60V-13907-00-00	18-7343	505
6J9-45371-01-00	18-6035	551	62Y-43800-11-00	18-6811	499	6AW-13907-00-00	18-7344	505
60V-12414-A0-00	18-60508	545	62Y-43880-00-00	18-6811	499	69J-13907-04-00	18-7345	505
68D-E1169-A0-00	18-60512	549	69W-43880-00-00	18-6811	499	6E5-24410-00-00	18-7349	505
66M-11357-00-00	18-60513	550	62X-43880-00-00	18-6812	500	6E5-24410-01-00	18-7349	505
68D-11351-A0-00	18-60518	549	62X-43880-01-00	18-6812	500	6E5-24410-02-00	18-7349	505
68D-E1193-A0-00	18-60519	549	62X-43880-09-00	18-6812	500	6E5-24410-03-00	18-7349	505
66T-11193-A0-00	18-60520	549	688-43880-11-00	18-6821	500	6E5-24410-04-00	18-7349	505
69M-11196-A0-00	18-60521	549	6E5-43880-01-00	18-6821	500	6E5-24410-10-00	18-7349	505
66T-11181-A0-00	18-60522	549	6E5-43880-02-00	18-6821	500	6G1-24411-00-00	18-7388	505
69M-11181-00-00	18-60523	549	60V-81800-00-00	18-6832	496	6E0-24411-00-00	18-7389	505
67D-45113-A0-00	18-60527	549	60X-81800-00-00	18-6832	496	68D-G5987-00-00	18-73891	551
66T-45113-A0-00	18-60528	549	69J-81800-00-00	18-6833	496	6L5-45616-00-00	18-73892	552
66T-41133-A0-00	18-60529	549	6C5-43880-00-00	18-6836	500	91490-25030-00	18-73893	551
66M-41114-01-00	18-60530	549	6C5-43880-01-00	18-6836	500	63V-24411-00-00	18-7390	505
65W-41114-01-00	18-60531	549	19-1400-10	18-6843	1012	90171-14056-00	18-73907	552
66T-41114-A0-00	18-60532	549	61A-81800-01-00	18-6861	496	692-24411-00-00	18-7391	505
66M-13645-00-00	18-60534	549	69L-81800-00-00	18-6861	496	670-45997-02-00	18-73914	551
65W-13645-00-00	18-60535	549	69W-81800-00	18-6861	496	63P-45987-00-00	18-73918	551
676-12414-A0-00	18-60540	549	64X-81800-00-00	18-6862	569	676-14985-01-00	18-7392	503
6BX-G4315-01-00	18-60541	549	6M6-81800-10-00	18-6862	569	6E7-14385-00-00	18-7393	503
688-45371-02-00	18-6070	551	69W-81800-00-00	18-6942	496	90201-08M54-00	18-73978	551
6G5-45251-01-00	18-6090	551	66M-81800-01-00	18-6943	496	6L2-45987-01-00	18-73979	551
6H1-45251-02-00	18-6091	551	66M-81800-02-00	18-6943	496	6H4-W4599-00-00	18-73990	551
664-45371-01-00	18-6096	551	6CB-81800-00-00	18-6961	496	66T-W4599-00-00	18-73995	552
6E5-45371-01-00	18-6097	551	6E5-W0093-06-00	18-7002	501	67F-W4599-00-00	18-73996	552
688-45371-02-00	18-6111	551	61N-14392-00-00	18-7049	502	93210-32738-00	18-7432	568
6J9-45371-01-00	18-6112	551	62Y-14392-00-00	18-7049	502	93210-46044-00	18-7436	568
66V-11325-01-00	18-6118A	551	6L2-14392-00-00	18-7049	502	93210-54M54-00	18-74399	568
61A-45371-00-00	18-6119A	551	6G1-14546-00-00	18-7054	502	93210-74M35-00	18-7442	568
61A-45371-00-00	18-6119Z	551	6G1-14546-01-00	18-7054	502	93211-04384-00	18-7444	568
61N-45251-01-00	18-6120A	551	6E5-14546-00-00	18-7055	502	683-W0001-C1-00	18-74501	567
61N-45251-01-00	18-6120Z	551	6J8-14546-00-00	18-7055	502	6H3-W0001-22-00	18-74504	567
6K1-45371-02-00	18-6121A	551	67F-1439A-00-00	18-7056	502	63V-W0001-21-00	18-74507	567
6K1-45371-02-00	18-6121Z	551	6H2-14591-00-00	18-7056	502	65L-W0001-C0-00	18-74510	567
69L-45371-00-00	18-6122A	551	6H3-14590-00-00	18-7056	502	66K-W0001-20-00	18-74512	567
69L-45371-00-00	18-6122Z	551	6H3-14590-01-00	18-7056	502	68V-W0001-20-00	18-74515	567
90105-10M00-00	18-6246	551	63V-W0093-00-00	18-7058	500	6G9-W0001-C6-00	18-74527	567
6H1-43880-00-00	18-6259	499	677-W0093-00-00	18-7059	500	67F-W0001-20-00	18-74535	567
66M-11181-10-00	18-63966	549	677-W0093-04-00	18-7059	500	62Y-W0001-20-00	18-74540	567
65W-11181-30-00	18-63968	549	692-14590-00-00	18-7060	503	68T-W0001-20-00	18-74544	567
689-81800-11	18-6410	495	692-14590-01-00	18-7060	503	93210-19123-00	18-7463	568
689-81800-12	18-6410	495	6L2-14385-00-00	18-7063	503	6G5-43864-00-00	18-7468	568
689-81800-13-00	18-6410	495	63V-14985-00	18-7064	503	64E-43869-00-00	18-7469	568
6H3-81800-10	18-6411	495	647-14385-00-00	18-7065	503	65W-43865-00-00	18-7470	568
6H3-81800-11-00	18-6411	495	648-14385-00-00	18-7066	503	93210-94003-00	18-7471	568
697-81800-12	18-6412	495	6G1-14985-00-00	18-7067	503	93210-37M67-00	18-7483	568
99999-03249-00	18-6412	495	6E5-14385-00-00	18-7068	503	65W-43871-00-00	18-7484	500
6E5-81800-11-00	18-6413	496	6E5-14385-01-00	18-7068	503	93210-86M38-00	18-7485	568
6E5-81800-12-00	18-6413	496	6E5-14385-02-00	18-7069	503	61A-24564-00-00	18-7486	509
6N7-81800-10-00	18-6415	496	6E7-14390-12-00	18-7073	503	65L-24564-00-00	18-7487	509
6L2-81800-20-00	18-6420	496	6E8-14380-12-00	18-7073	503	6P3-24564-00-00	18-7488	509
6F5-81800-11	18-6421	496	626-14390-90	18-7079	503	93210-16716-00	18-7511-9	568
6J4-81800-01-00	18-6421	496	93210-33M85-00	18-7119	503	67F-24251-02-00	18-7516	509
6H4-81800-12-00	18-6422	496	93210-05001	18-71330	523	65L-24563-00-00	18-7517	509
688-81800-12-00	18-6423	496	93210-44704	18-71331	522	6P2-WS245-00-00	18-7518	509
67F-81800-02-00	18-6425	496	93210-45161	18-71332	523	MAR-10171-30-00	18-7606	512
68F-81800-01-00	18-6426	496	93210-49046	18-71333	522	67H-8592A-00-00	18-7655	512
68V-81800-01-00	18-6427	496	93210-59MG7	18-71334	523	67H-8592A-01-00	18-7655	512
68F-W1135-00-00	18-64415	547	696-W0093-02-00	18-7290	501	68F-8592A-00-00	18-7656	512
6E9-82575-02-00	18-65450	32, 493	6H1-W0093-01-00	18-7291	501	65W-14198-00-00	18-76689	568
6M6-81960-A0-00	18-6650	570	6A1-W0093-01-00	18-7293	501	93210-46M16-00	18-76690	568
66V-81960-00-00	18-6651	570	663-24410-00-00	18-7334	505	93210-27ME3-00	18-76691	568
6K8-81960-A0-00	18-6652	570	692-24410-00-00	18-7334	505	93210-75M51-00	18-76692	568
67C-43880-00-00	18-6748	499	6A0-24410-00-00	18-7334	505	93210-31MJ5-00	18-76693	568
67C-43880-01-00	18-6748	499	6A0-24410-01-00	18-7334	505	93210-24M79	18-76694	568
6G5-43880-02-00	18-6760	499	6A0-24410-02-00	18-7334	505	68T-24251-00-00	18-7710-1	509
6H1-43880-02-00	18-6781	499	6A0-24410-03-00	18-7334	505	646-24251-02-00	18-7713	509
61A-43880-01-00	18-6782	499	6A0-24410-04-00	18-7334	505	67D-W0093-00-00	18-7736	501

Yamaha (Cont.)			Yamaha (Cont.)			Yamaha (Cont.)		
O.E. #	SIERRA #	PAGE #	O.E. #	SIERRA #	PAGE #	O.E. #	SIERRA #	PAGE #
61N-W0093-00-00	18-7737	501	61A-13411-00	18-79976	534	67C-41133-00	18-99016	542
66M-W0093-00-00	18-7738	501	6LS-24251-00	18-79977	510	67C-45123-00	18-99017	542
66M-W0093-01-00	18-7738	501	6CB-13915-00	18-79978	511	67F-41133-A1	18-99018	542
6L2-W0093-00-00	18-7739	501	6CB-24501-00	18-79979	510	67F-41134-A0	18-99019	542
6E9-W0093-02-00	18-7740	501	68F-24563-00	18-79980	510	67F-45123-00	18-99020	542
6E9-W0093-03-00	18-7741	501	69J-24501-00	18-79981	510	682-41133-A0	18-99021	542
6HO-W0093-00-00	18-7742	501	69J-24502-00	18-79982	510	682-45113-A1	18-99022	542
67F-W0093-00-00	18-7743	501	6CS-24251-00	18-79983	510	688-41133-00	18-99023	542
6N6-W0093-02-00	18-7744	501	6AW-24502-00-00	18-79984	510	688-41134-A0	18-99024	542
6G5-W0093-08-00	18-7747	501	6AW-24502-10	18-79984	510	688-45114-A1	18-99025	542
64D-W0093-00-00	18-7756	501	68V-24502-20-00	18-79985	510	688-45123-00	18-99026	542
6K7-W0093-09-00	18-7759	501	68V-24502-30	18-79985	510	68T-13475-00	18-99027	542
6G1-W0093-00-00	18-7765	501	68V-24502-00-00	18-79986	510	68V-15312-00	18-99028	542
6H3-W0093-02-00	18-7766	502	68V-24502-01-00	18-79986	510	697-45114-A0	18-99030	543
6H4-W0093-01-00	18-7767	502	68V-24502-02	18-79986	510	69J-41134-A0	18-99032	543
6H4-W0093-03-00	18-7768	502	6YL-24306-60-00	18-8017EP-2	162, 165, 512	69J-41135-A0	18-99033	543
6E7-W0093-04-00	18-7769	502	6YL-24306-60-00	18-8017S-1	166, 512	69J-41136-A0	18-99034	543
689-W0093-02-00	18-7770	502	ABA-FBARB-90-DG	18-8040	512	6E5-41134-A0	18-99037	543
61A-W0093-00-00	18-7772	502	6Y1-24305-04	18-80413	513	6E5-41135-A0	18-99038	543
61A-W0093-01-00	18-7772	502	6G1-24305-04	18-80414	513	6G5-41134-A1	18-99039	543
MAR-FLTHD-SS-12	18-7777	153, 507	6G1-24305-05-00	18-80414	513	6G5-45114-A1	18-99040	543
ABB-SPRTR-HD-SS	18-7777-1	153, 507	6E5-24305-05	18-80415	513	6G8-45113-A1	18-99045	543
6F5-24563-00-00	18-7780	509	6Y2-24305-05	18-80415	513	6H3-45114-A1	18-99046	543
61N-24563-00-00	18-7781	509	ABA-FLINE-BA-RB	18-8055	512	6H3-45123-00	18-99047	543
61A-24563-00-00	18-7782	509	90119-08M15-00	18-8400-9	519	60V-11181-00	18-99048	539
YSC-10231-20-0C	18-7824-2	201, 665	97595-06535	18-8406	523	60V-13621-A0	18-99049	543
YSC-13231-20-0C	18-7824-2	1013	97595-06540	18-8407	523	60V-13645-00	18-99050	543
65W-24251-10-00	18-7830	509	1WD-E3440-00-00	18-8700	202, 535	61A-11193-A1	18-99051	543
6G1-24471-00-00	18-7833	506	2MB-E3440-00-00	18-8700	202, 535	61A-11381-A0	18-99052	543
6E0-24471-00-00	18-7834	506	5GH-13440-20	18-8700	202, 535	61A-13621-A0	18-99053	543
677-24411-02-00	18-7837	506	5GH-13440-50-00	18-8700	202, 535	61A-13645-00	18-99054	543
677-24471-01-00	18-7838	506	5JW-13400-00-00	18-8700	202, 535	61A-13646-00	18-99055	543
648-24411-00-00	18-7839	505, 506	67F-82341-00-00 +	18-8847-1	492	61A-45113-A0	18-99056	543
663-24411-00-00	18-7840	505, 506	67F-82342-00-00 +	18-8847-1	492	61T-11193-A1	18-99057	543
6J8-24471-00-00	18-7841	506	67F-82343-00-00 +	18-8847-1	492	63D-11193-A0	18-99059	539
6E5-24471-00-00	18-7842	505, 506	67F-82344-00-00	18-8847-1	492	63D-11181-A1	18-99060	539
6E5-24411-00-00	18-7843	505, 506	68T-44352-00-00	18-8910	514, 519	63D-W0001-00	18-99061	536
ABB-FUELF-IL-TR	18-7845	153, 508	6L5-44352-00-00	18-8911	514	68F-11181-00	18-99062	539
MAR-SEPAR-AT-OR	18-7852-1	153, 507	6AW-44352-00-00	18-8925	514	63V-45315-A0	18-99063	544
MAR-FLTHD-AL-12	18-7853-1	153, 507	61A-45538-00-00	18-9075	515	64E-13645-A0	18-99064	544
MAR-MINIF-IL-TR	18-7865	155, 508	61A-45527-00-00	18-9076	515	65L-13645-00	18-99066	544
MAR-FUELF-IL-TR	18-7866	153, 508, 665	90206-22M19	18-9077	515	65L-13646-00	18-99067	544
YSC-16231-20-0C	18-7875	201, 1013	90201-22M01	18-9078	515	65W-11169-00	18-99068	544
YSC-14231-20-0C	18-7876-1	201	61A-45538-00-00 +	18-9079	515	65W-11351-00	18-99069	544
6G8-13440-00-00	18-7901	201, 535	61A-45527-00-00 +	18-9079	515	65W-11356-00	18-99070	544
3FV-13440-00-00	18-7902	201, 535	90206-22M19 +	18-9079	515	65W-14457-10	18-99071	544
3FV-13440-20-00	18-7902	201, 535	90201-22M01	18-9079	515	65W-41114-00	18-99072	544
69J-13440-00-00	18-7906-1	202, 319	6E5-44312-00-00	18-9081	515	65W-W0001-20	18-99073	536
69J-13440-01-00	18-7906-1	202, 319	6AW-44312-00-00	18-9082	515	66M-11351-10	18-99074	544
5GH-13440-00-00	18-7911-1	202, 534	63D-44312-00	18-9083	515	66M-11356-00	18-99075	544
MAR-24563-00-00	18-7919	154, 508	6EG-G4328-00	18-9089	523	66M-13229-10	18-99076	544
MAR-10171-00-10	18-7924	154, 292, 508	63V-44328-01	18-9090	522	66M-41138-00	18-99078	544
ABB-FUELF-IL-TR	18-7945	153, 508, 665	69M-G4328-00	18-9091	523	66M-45115-00	18-99079	544
N26-13440-00-00	18-7954	202, 534, 535	6L2-44328-00	18-9092	523	676-13646-A0	18-99080	544
N26-13440-02-00	18-7954	202, 534, 535	YB-6AW04-1	18-9133-9	220, 513	676-41112-A0	18-99081	Obsolete
68F-24563-10-00	18-7955	509	YB-6AW04-A	18-9145	220, 513	676-44315-A1	18-99082	544
MAR-MINIF-LT-AS	18-7965-1	155, 508	YB-6AW04-3	18-9146-9	220, 513	676-44324-A0	18-99083	544
MAR-SEPAR-AT-OR	18-7966-1	155, 507	LUB-MRNSM-KT-10	18-9390	215, 535	676-45127-00	18-99084	544
68V-24563-00-00	18-7979	509	LUB-MRNMD-KT-10	18-9391	215, 535	676-45128-00	18-99085	544
6D8-WS24A-00-00	18-79799	509	LUB-MRNMR-KT-10	18-9392	216, 535	679-44316-A0	18-99086	544
6P3-WS24A-00-00	18-79809	509	LUB-MRNLG-KT-10	18-9393	216, 535	679-45315-A0	18-99087	544
YB-ACC04	18-79815	223	LUB-20W40-FC-12	18-9450-2	204	67C-11356-00	18-99088	544
MAR-SPRTR-HD-SS	18-7984-1	153, 507	LUB-2STRK-M1-4	18-9530-3	204	67C-41114-00	18-99089	545
66K-13915-00-00	18-79900	510, 511	LUB-2STRK-M1-55	18-9530-7	204	67C-45113-00	18-99091	545
65L-13915-00-00	18-79901	510, 751	61A-41134-A0	18-99000	541	67C-W0001-00	18-99092	536
63P-13915-00-00	18-79902	511	61A-45114-A0	18-99001	541	67C-W0001-20	18-99093	536
68V-13915-00-00	18-79903	511	62Y-41133-00	18-99002	541	67F-11181-02	18-99094	539
68F-13915-00-00	18-79904	511	62Y-41134-01	18-99003	541	682-11351-A0	18-99095	545
69J-24501-10-00	18-79905	509, 511	63D-45114-A0	18-99004	541	682-41112-A1	18-99096	545
60V-24251-01-00	18-79907	510	63D-45123-00	18-99005	541	682-W0001-06	18-99097	537
61N-24560-10	18-79910	511	63V-41133-A1	18-99006	541	688-13621-A1	18-99098	545
6H1-13411-00	18-79961	534	64J-41133-10	18-99008	542	68F-11193-01	18-99099	545
6BG-13915-00	18-79970	509	663-45123-00	18-99009	542	68F-11381-00	18-99100	545
68F-13440-00	18-79971	534	664-41134-A0	18-99010	542, 564, 564	68F-41114-00	18-99101	545
67F-14371-01	18-79972	509	66M-41133-00	18-99012	542	68F-45113-00	18-99102	545
6CS-13915-00	18-79973	508, 511	66M-45113-00	18-99013	542	68F-W0001-01	18-99103	537
6J8-13411-00	18-79974	534	676-41133-A0	18-99014	542	6A0-W0001-21	18-99104	537
6E5-13411-00	18-79975	534	676-45114-A0	18-99015	542	6E5-13621-A1	18-99105	545

Yamaha (Cont.)			Yamaha (Cont.)			Yanmar (Cont.)		
O.E. #	SIERRA #	PAGE #	O.E. #	SIERRA #	PAGE #	O.E. #	SIERRA #	PAGE #
6E9-11193-A0	18-99106	545	61B-82510-01-00	MP51030	25, 492	128170-77202	18-6928	679
6E9-41114-A0	18-99107	545	61B-82510-01-00	MP51032	25, 492	119573-77200	18-6929	679
6G1-11193-A1	18-99108	545	703-82510-43-00	MP51040	25, 493	119573-77201	18-6929	679
6G1-13621-A1	18-99109	545	703-82510-43-00	MP51042	25, 493	104211-77010	18-6930	680
6G1-13645-A1	18-99110	545	6K1-82510-06-00	MP51050	25, 493	104211-77011	18-6930	680
6G1-14198-A1	18-99111	545	6K1-82510-06-00	MP51052	25, 493	119209-77010	18-6931	680
6G1-41112-A1	18-99112	545	YAMAHA PWC			121120-77010	18-6931	680
6G1-41114-A0	18-99113	545	63M-81960-00-00	18-6857	570	121120-77011	18-6931	680
6G1-41133-A0	18-99114	545	6H2-81960-00-00	18-6858	570	121120-77012	18-6931	680
6G1-45113-A1	18-99115	545	64X-81800-00-00	18-6906	569	124520-77010	18-6931	680
6G1-45315-A0	18-99116	545	6D3-81800-00-00	18-6907	569	124520-77011	18-6931	680
6G1-W0001-A2	18-99117	537	63M-81800-00-00	18-6908	570	121370-77010	18-6932	680
6G5-14483-A1	18-99118	545	63M-81800-00-00	18-6908	570	129242-77010	18-6932	680
6G8-11351-A0	18-99119	545	6S5-81800-00-00	18-6909	570	129698-77010	18-6932	680
6G8-12414-A0	18-99120	545	60E-81800-00-00	18-6921	570	123500-77010	18-6934	680
6G8-13646-A0	18-99121	546	YANMAR			124610-77010	18-6934	680
6G8-14198-A0	18-99122	546	127610-42200	18-3077	574	124610-77019	18-6934	680
6G8-15374-00	18-99123	546	104211-42070	18-3079	574	424610-77010	18-6934	680
6H3-12414-A1	18-99124	546	192470-42530	18-3277	982	119225-77010	18-6935	680
6H3-13622-00	18-99125	546	192470-42532	18-3277	982	119225-77011	18-6935	680
6H3-14198-01	18-99126	546	119773-42600-00	18-3306	573	119226-77010	18-6935	680
63P-12414-00-00	18-99127	548	119574-42550	18-45714	689	114361-77011	18-6936	680
6H3-41112-A0	18-99128	546	119574-42552	18-45714	689	114362-77010	18-6936	680
6H3-41114-A0	18-99129	546	728170-92600	18-55500	689	114362-77011	18-6936	680
6H3-45113-A0	18-99130	546	728171-92601	18-55501	689	114399-77010	18-6936	680
6H4-13621-A1	18-99132	546	728271-92605	18-55502	689	128170-77010	18-6937	680
6H4-14198-01	18-99133	546	8M0095471	18-55510	392	128170-77010D	18-6937	680
6H4-15369-A1	18-99134	546	128170-01331	18-55600	689	119773-77010	18-6938	680
6H4-41112-A0	18-99135	546	128171-01911	18-55601	689	121254-77010	18-6939	680
6K7-13686-A1	18-99136	546	128271-01911	18-55602	689	121254-77011	18-6939	680
6L2-41133-A2	18-99137	546	128374-01911	18-55603	690	121254-77012	18-6939	680
6L2-45315-A0	18-99138	546	128170-11310	18-56000	689	121254-77019	18-6939	680
6OV-13646-00	18-99139	546	104211-49160	18-56601	689	129429-77010	18-6939	680
63V-11181-A2	18-99140	546	128170-42090	18-56602	689	129429-77011	18-6939	680
6H3-11193-A1	18-99141	546	128270-12540	18-57703	688	129470-77200	18-6970	679
6E9-12414-A1	18-99142	546	128171-12540	18-57704	688	119350-35150	18-7910-1	200, 691
6H3-13621-A1	18-99143	546	27210-200200	18-6200	690	119350-35151	18-7910-1	200, 691
6E7-14227-00	18-99144	546	27210-200300	18-6201	690	124450-35100	18-7910-1	200, 691
677-14198-A1	18-99145	546	119773-77200	18-6849	679	124085-35113	18-7917	200, 691
677-14384-01	18-99146	504	129573-77010	18-6880	680	124450-35110	18-7917	200, 691
6G1-24431-01	18-99147	546	171008-77010	18-6880	680	124550-35110	18-7917	200, 691
688-41114-A0	18-99148	546	128270-77200	18-6925	679	171056-35110	18-7917	200, 691
663-44316-A0	18-99149	547	119836-77200	18-6926	679	171056-35111	18-7917	200, 691
63V-45113-A1	18-99150	547	119836-77200-2	18-6926	679	104500-55710	18-79960	157, 688
688-45113-A0	18-99151	547	119836-77200-3	18-6926	679	124223-42092	18-8950	689
683-45315-A0	18-99152	547	129612-77230	18-6926	679	128176-42071	18-8951	689
6EG-G4315-00	18-99157	523	119573-77200	18-6927	679	104211-42071	18-8952	689
63V-W0001-01	18-99175	538	119573-77201	18-6927	679	ZENITH		
682-82556-00-00	MP28860	32, 493	119573-77201	18-6927	679	K-2035	18-7732	584
703-82510-12-00	MP51020	25, 492	129470-77200	18-6927	679	K-2036	18-7732	584
703-82510-12-00	MP51022	25, 492	128170-77200	18-6928	679			
61B-82510-00-00	MP51030	25, 492	128170-77201	18-6928	679			



Sierra
Marine Engine and Drive Parts

SIERRA #	PAGE #	SIERRA #	PAGE #	SIERRA #	PAGE #	SIERRA #	PAGE #
GAUGES							
10860	23	62543P	2, 7	65692P	2, 10	69381P	21
1502778	23	62546P	2, 7	65693P	2, 10	69703P	12
1507678P	22	62546PH	7	66956P	3, 12	69704P	12
1508370P	23	62547P	2, 7	67019P	3, 14	69708P	15
1827871P	23	62548P	2, 7	67020P	3, 14	69709P	15
18-5896	20, 769	62549P	2, 7	67021P	3, 14	69710P	16
18-5897	20, 409	62550P	2, 7	67022P	3, 14	69711P	16
18-5898	20, 619, 769, 909	62551P	2, 7	67023P	3, 14	69712P	17
18-5899	619, 646, 769	62555P	2, 7	67285P	3, 14	69713P	17
18-7513	20, 980	62561P	2, 7	67363P	3, 14	69716P	12
20000P	19	62565P	2, 7	67364P	3, 14	69717P	12
20010P	19	62714P	Obsolete	67365P	3, 14	69721P	15
21000P	19	62715P	6	67382P	3, 14	69722P	15
21010P	19	62718P	2, 6	67437P	22	69723P	16
22000P	19	62719P	2, 6	67457P	22	69724P	16
22010P	19	62720P	2, 6	67653P	9	69725P	17
22020P	19	62721P	2, 6	67654P	7	69726P	17
26000P	19	62722P	2, 6	67657P	2, 7	69743P	3, 12
56353P	22	62723PH	6	67669P	9	69870P	3, 12
56966P	21, 135	62724P	2, 6	67855P	3, 14	69992D	4
56967P	21, 135	62725P	2, 6	68356P	3, 15	69993D	4
56968P	21	62726P	2, 6	68357P	3, 15	69994D	4
56969P	21	62727P	2, 6	68358P	3, 15	69995K	4
56973P	22	62728P	2, 6	68359P	3, 15	69996K	4
57897P	15	62729P	2, 6	68361P	3, 15	69997K	4
57898P	3, 15	62730P	2, 6	68362P	15	69998K	4
57898PH	15	62748P	2, 6	68363P	15	69999K	4
57899P	3, 15	62952P	2, 11	68364P	3, 16	70000D	4
57899PH	15	62960P	2, 11	68365P	3, 16	70001D	4
57900P	3, 15	63076P	3, 12	68366P	3, 16	70002D	4
57900PH	15	63076PH	12	68367P	3, 16	70003D	4
57901P	3, 15	63473P	3, 13	68369P	3, 16	70004D	4
57902P	3, 15	63474P	3, 13	68370P	3, 16	70005D	4
57903P	3, 15	63475P	3, 13	68371P	3, 16	70006D	4
57904P	3, 15	63475PH	13	68372P	3, 16	781-294-060P	2, 5, 8
57905P	3, 15	63476P	3, 13	68373P	3, 16	781-310-035P	2, 5, 9
57929P	3, 15	63476PH	13	68374P	3, 16	781-310-060P	2, 5, 9
58255P	3, 15	63477P	3, 13	68375P	3, 16	781-579-035P	3, 5, 15
58342P	3, 15	63478P	3, 13	68376P	3, 16	781-579-060P	3, 5, 15
58342PH	15	63479P	3, 13	68377P	3, 16	781-579-080P	3, 5, 15
58431P	3, 15	63480P	3, 13	68378P	3, 16	781-625-035P	2, 5, 7
58862P	3, 15	63481P	3, 13	68379P	3, 16	781-625-080P	2, 5, 7
58935P	3, 15	63482P	3, 13	68380P	3, 16	781-625-120P	2, 5, 7
59416P	2, 9	63483P	3, 13	68381P	3, 16	781-627-035P	2, 5, 6
59653P	2, 9	63523P	2, 9	68383P	3, 16	781-627-060P	2, 5, 6
59654P	2, 9	63585P	3, 13	68384P	3, 16	781-627-080P	2, 5, 6
59655P	2, 9	64475P	3, 13	68385P	3, 16	781-627-120P	2, 5, 6
59656P	2, 9	64477FP	2, 10	68387P	16	781-683-035P	3, 5, 16
59657P	2, 9	65129P	2, 10	68388P	16	781-683-060P	3, 5, 16
59677P	22	65205P	3, 15	68389P	3, 17	781-683-080P	3, 5, 16
59703P	3, 12	65206SSP	2, 10	68390P	3, 17	781-684-035P	3, 5, 17
59704P	3, 12	65481P	12	68391P	3, 17	781-684-060P	3, 5, 17
59704PH	12	65485P	12	68392P	3, 17	781-684-080P	3, 5, 17
59705P	3, 12	65495P	2, 10	68393P	3, 17	80131P	3, 18
59706P	3, 12	65496P	2, 10	68394P	3, 17	80134P	3, 18
59707P	3, 12	65497P	2, 10	68395P	3, 17	80150P	3, 18
59708P	3, 12	65498P	2, 10	68396P	3, 17	80180P	3, 18
59709P	3, 12	65501P	2, 10	68397P	3, 17	80181P	3, 18
59713P	2, 9	65502P	2, 10	68398P	3, 17	80514P	3, 18
59737P	2, 9	65503P	2, 10	68399P	3, 17	80514PH	18
61163P	3, 12	65504P	2, 10	68400P	3, 17	80590P	3, 18
61238P	3, 15	65505P	2, 10	68401P	3, 17	80593P	18
61546P	2, 11	65506P	2, 10	68402P	3, 17	80596P	18
61547P	2, 11	65507P	2, 10	68403P	3, 17	80710P	3, 18
61548P	2, 11	65508P	2, 10	68404P	3, 17	80712P	18
61549P	2, 11	65509P	2, 10	68405P	3, 17	80730P	3, 18
61550P	2, 11	65510P	2, 10	68406P	3, 17	82288P	3, 18
61551P	2, 11	65524P	2, 8	68408P	3, 17	82301P	18
61552P	2, 11	65525P	2, 8	68409P	3, 17	82302P	3, 18
61748P	3, 15	65526P	2, 8	68410P	3, 17	82303P	3, 18
61751P	2, 10	65529P	2, 8	68412P	17	82760P	3, 18
61751PH	10	65530P	2, 8	68413P	17	84760P	3, 15
61752FP	2, 9	65531P	2, 8	68443P	3, 15	FS45430	23, 63
61752P	2, 10	65535P	2, 8	68755P	5	IA55009	23
61752PH	10	65536P	2, 8	68960P	3, 14	IA62995	23
61826P	3, 12	65537P	2, 8	68960PH	14	IA65476	21
61826PH	12	65545P	2, 8	68982P	5	IA65477	21
61886P	23	65547P	2, 8	69044P	15	IH14767	22
61901P	3, 12	65548P	2, 8	69053P	5	IH15105	22
61908P	3, 12	65550P	2, 8	69073FP	14	OP22891	20
62369P	3, 12	65551P	2, 8	69074FP	14	OP22900	20
62375P	2, 11	65553P	2, 8	69268P	21	OP24301	20
62538P	2, 7	65670P	2, 10	69269P	21	OP24891	20
62540P	2, 7	65670PH	10	69270P	21	OP72533	20
62542P	2, 7	65671P	2, 10	69380P	21	TS25101	20

SIERRA #	PAGE #	SIERRA #	PAGE #	SIERRA #	PAGE #	SIERRA #	PAGE #
GAUGES							
TS26611	20	TS26641	20				
TS26621	20	TS26651	20				
TS26631	20						
SIERRA SWITCH & ELECTRICAL							
95001	74	BS11000	69	CB60002-1	63	EC04230-100	72
95002	74	BS11010	69	CB60012	Obsolote	EC04240	71
95004	74	BS11020	69	CL49300	74	EC04240-100	71
95005	74	BS11030	69	CL49310	74	EC04250	71
95006	74	BS11040	76	CL49320	74	EC04250-100	71
95011	74	BS11050	76	CL49330	74	EC04260	71
95013	74	BT44430	76	CL49330KA	74	EC04260-100	71
95016	74	CB40190	63	CL49332	74	EC04280	72
95026	74	CB40200	63	CL52422	74	EC04280-100	72
18-1100	70	CB40220	63	EA01000	75	EC04300	71
18-1105	70	CB40230	63	EA01010	75	EC04300-100	71
18-1106	70	CB40240	63	EA01020	75	EC04490	72
18-1107	70, 451	CB40250	63	EA01040	75	EC04490-100	72
18-1109	70	CB40260	63	EA01050	75	EC04500	72
18-1110	70	CB40270	63	EA01070	75	EC04500-100	72
18-1175	70	CB40280	63	EA01080	75	EC04710-100	71
18-1176	70	CB41100	63	EA01090	75	EC04720-100	71
18-1177	70	CB41200	63	EA01100	75	EC06230	72
18-1178	70	CB41210	63	EC01310	73	EC09040	73, 229
18-1199	70	CB41210B	63	EC01350	73	EC09090	73, 228
18-1282	32, 277	CB41220	63	EC01360	S/S to EC1380	EC10250	72
18-1294	32	CB41230	63	EC01370	72	EC63120	71
18-3746	70	CB41240	63	EC01380	72	EC63130	71
18-3747	70	CB42240	63	EC01440	72	EC63140	71
18-3748	70, 551, 552	CB41250	64	EC01450	72	EC63190	71
18-5840	69, 583, 584, 594, 615, 616 652, 718	CB41260	64	EC01460	72	EC63200	71
		CB41270	64	EC01570	72	EC63720	71
18-5894	20, 905, 980	CB42250-1	63	EC01620	72	EC63240	71
18-79987	70, 220	CB43240	63	EC01630	72	EC63250	71
18-79988	70, 220	CB43250	63	EC01750	72	EC63260	71
AP10010	76	CB45240	63	EC04000	72	EC63300	71
AP10020	76	CB45250	63	EC04000-100	72	EC63720	71
AV10030	50	CB50300	65	EC04010	71	EC64000	71
AV10030B	50	CB50310	65	EC04010-100	72	EC64110	71
AV10030G	50	CB50320	65	EC04020	71	EC64110-100	71
AV10030R	50	CB50330	65	EC04020-100	71	EC64230	71
AV10030W	50	CB50340	65	EC04030-100	71	EC64230-100	71
AV10040	50	CB50350	65	EC04040-100	71	FS22080	62
AV10040B	50	CB50360	65	EC04050	72	FS22082	62
AV10040G	50	CB50370	65	EC04050-100	72	FS35870	62
AV10040R	50	CB50380	65	EC04070-100	72	FS35872	62
AV10040W	50	CB50390	65	EC04080	72	FS40410	55
AV10050R	50	CB50400	64	EC04080-100	72	FS40412	55
AV10060R	50	CB50410	64	EC04090	72	FS40420	55
AV10060B	50	CB50420	64	EC04090-100	72	FS40422	55
AV10060G	50	CB50430	64	EC04100	72	FS40430	55
AV10060W	50	CB50440	64	EC04100-100	72	FS40432	55
AV10100R	50	CB50450	64	EC04110	72	FS40440	55
AV10100B	50	CB50460	64	EC04110-100	72	FS40442	55
AV10120B	50	CB50470	64	EC04120	71	FS40450	55
AV10130B	50	CB50480	65	EC04120-100	71	FS40452	55
BA58003	69	CB50490	65	EC04130	71	FS40500-1	55
BA58010	69	CB50500	65	EC04130-100	71	FS40502-1	55
BA58020	69	CB50510	65	EC04140	71	FS40510-1	55
BA58050	69	CB50520	64	EC04140-100	71	FS40512-1	55
BC88523	76, 241, 279, 383, 583, 594, 613, 642, 714, 893, 963	CB50530	64	EC04150	72	FS40520-1	55
		CB50540	64	EC04150-100	72	FS40522-1	55
BC88533	76, 241, 279, 383, 583, 594, 613, 642, 714, 893, 963	CB50550	64	EC04160-100	72	FS40530-1	55
		CB50560	64	EC04170	72	FS40540-1	56
BC88543	76, 241, 279, 383, 583, 594, 613, 642, 714, 893, 963	CB50570	64	EC04170-100	72	FS40542-1	56
		CB50580	64	EC04180	72	FS40550-1	56
BC88553	76, 241, 279, 383, 583, 594, 613, 642, 714, 893, 963	CB50590	64	EC04180-100	72	FS40552-1	56
		CB50600	64	EC04190	71	FS40560-1	56
BC88563	76, 241, 279, 383, 583, 594, 613, 642, 714, 893, 963	CB50610	64	EC04190-100	71	FS40562-1	56
		CB50620	64	EC04200	71	FS40570-1	56
BC88573	76, 241, 279, 383, 583, 594, 613, 642, 714, 893, 963	CB50630	64	EC04200-100	71	FS40572-1	56
		CB50640	64	EC04210	72	FS40590-1	55
BC88583	76, 241, 279, 383, 583, 594, 613, 642, 714, 893, 963	CB50650	64	EC04210-100	72	FS40592-1	55
		CB50660	64	EC04220	72	FS40600-1	55
BC88593	76, 241, 279, 383, 583, 594, 613, 642, 714, 893, 963	CB50670	64	EC04220-100	72	FS40602-1	55
		CB60000-1	63	EC04230	72	FS40610-1	55

SIERRA #	PAGE #	SIERRA #	PAGE #	SIERRA #	PAGE #	SIERRA #	PAGE #
SIERRA SWITCH & ELECTRICAL							
FS40612-1	55	FS46561	60	FS81040	54	MP39350	53
FS40630-1	55	FS46562	60	FS81050	54	MP39352	53
FS40632-1	55	FS46570	61	FS81060	54	MP39360	52
FS40640-1	55	FS46580	61	FS81080	54	MP39362	52
FS40642-1	55	FS46590	61	FS81082	54	MP39380	49
FS40650-1	55	FS46600	58	FS82000	61	MP39382	49
FS40652-1	55	FS46610	58	FS82010	61	MP39390	49
FS40660	59	FS46620	58	FS82020	61	MP39390B	49
FS40662	59	FS46630	58	FS82030	61	MP39392	49
FS40670	59	FS46660	58	FS82040	61	MP39392B	49
FS40672	59	FS46670	58	FS82050	61	MP39410	52
FS40680	59	FS46680	58	FS82060	61	MP39412	52
FS40682	59	FS46690	58	FS82070	61	MP39420	52
FS40690	59	FS46700	58	FSC46100	57	MP39422	52
FS40692	59	FS46710	58	FSC46200	57	MP39510	51
FS40720	57	FS56152	59	FSC46300	57	MP39512	51
FS40722	57	FS56232	55	FSC46400	57	MP39520	51
FS40730	55	FS56242	55	FSC46550	57	MP39522	51
FS40732	55	FS56252	55	FSC46560	57	MP39530	51
FS40740	55	FS69100	62	MC33502	66	MP39532	51
FS40742	55	FS69110	62	MP21480	50	MP39540	51
FS40750	57	FS69120	62	MP21462	50	MP39542	51
FS40752	57	FS69130	62	MP28850	32	MP39570	51
FS40830	56	FS69140	62	MP28860	32	MP39572	51
FS40840	56	FS69150	62	MP28870	32	MP39580	49
FS40800	56	FS69160	62	MP28872-1	32	MP39582	49
FS40820	56	FS69170	62	MP28880	32	MP39590	49
FS40810	56	FS69180	62	MP28890	32	MP39592	49
FS40900	57	FS79060	53	MP28900	32	MP39600	49
FS40910	57	FS79070	53	MP28902-1	32	MP39602	49
FS40920	57	FS79090	53	MP38910	28	MP39610	51
FS45350	62	FS79100	53	MP39010	28	MP39612	51
FS45352	62	FS79110	53	MP39012	28	MP39620	49
FS45360	62	FS79120	53	MP39020	28	MP39622	49
FS45362	62	FS79130	53	MP39022	28	MP39640	49
FS45380	62	FS79140	53	MP39030	48	MP39642	49
FS45382	62	FS79150	53	MP39032	48	MP39670	52
FS45390	62	FS79160	53	MP39040	31	MP39672	52
FS45392	62	FS79170	53	MP39042	31	MP39680	52
FS45400	62	FS79180	53	MP39060-1	27	MP39682	52
FS45402	62	FS79190	53	MP39062-1	27	MP39690	52
FS45410	62	FS79200	53	MP39070	26	MP39692	52
FS45412	62	FS79210	53	MP39072	26	MP39700-1	26
FS45430	23, 63	FS79220	53	MP39080-1	27	MP39702-1	26
FS45432	63	FS79270	53	MP39082-1	27	MP39710-1	29
FS45440	62	FS79280	53	MP39090	31	MP39712-1	29
FS45442	62	FS79470	53	MP39092	31	MP39720-1	29
FS45460	62	FS79480	54	MP39100	31	MP39722-1	29
FS45462	62	FS79490	54	MP39102	31	MP39730	29
FS45470	62	FS79500	54	MP39120	27	MP39732	29
FS45472	62	FS79510	54	MP39122	27	MP39740-1	30
FS45620	60	FS79520	54	MP39140	53	MP39742-1	30
FS45622	60	FS79530	54	MP39142	53	MP39760	30
FS45630	60	FS79540	54	MP39160	50, 492	MP39762	30
FS45632	60	FS79550	54	MP39162	50	MP39770	28
FS45640	60	FS79560	54	MP39180	50	MP39772	28
FS45642	60	FS79570	54	MP39182	50	MP39780	27
FS45650	60	FS79580	54	MP39190	32	MP39782	27
FS45652	60	FS79590	54	MP39200	28	MP39800	26
FS46100	59	FS79600	53	MP39202	28	MP39802	26
FS46102	59	FS79630	53	MP39210	66	MP39820-1	28
FS46150	59	FS79680	54	MP39220	48	MP39822-1	28
FS46152	59	FS79690	54	MP39222	48	MP39830	31
FS46200	59	FS79820	53	MP39240-1	48	MP39832	31
FS46202	59	FS79870	53	MP39242	48	MP40950	32
FS46250	59	FS80000	54	MP39260	53	MP40960	32
FS46252	59	FS80010	54	MP39262	53	MP40962	32
FS46300	60	FS80030	54	MP39270	32	MP40970-1	32
FS46302	60	FS80040	54	MP39280	48	MP40972-1	32
FS46350	60	FS80050	54	MP39282	48	MP40980	32
FS46352	60	FS80060	54	MP39300	52	MP40982	32
FS46400	59	FS80070	54	MP39302	52	MP40990	32
FS46402	59	FS80080	54	MP39310	51	MP40992	32
FS46450	59	FS80090	54	MP39312	51	MP41000	30, 381
FS46452	59	FS81000	54	MP39320	51	MP41002	30
FS46551	60	FS81010	54	MP39322	51	MP41010	29
FS46552	60	FS81020	54	MP39340	51	MP41012	29
FS46540	61	FS81030	54	MP39342	51	MP41020	27

SIERRA #	PAGE #	SIERRA #	PAGE #	SIERRA #	PAGE #	SIERRA #	PAGE #
SIERRA SWITCH & ELECTRICAL							
MP41022	27	PC51090	65	RK19910	40	RK40860	36
MP41030	28	PC51100	65	RK19920-1	41	RK40870	36
MP41032	28	PC51110	65	RK19930-1	41	RS20000	37
MP41040	26	PC51120	65	RK19940-1	41	RS20010	37
MP41042	26	PC51130	65	RS20180	36	RS20020	37
MP41070-2	30	PC51140	65	RS20190	36	RS20030	37
MP41072-2	30	PC51150	65	RS20200	36	RS20040	37
MP41080	29	PC51160	65	RK21420	44	RS20050	37
MP41082	29	PC51170	65	RK21430	44	RS20060	37
MP41090-1	30	RK19000	34	RK21880	44	RS20180	36
MP41092-1	30	RK19010	34	RK22100	39	RS20190	36
MP41400	66	RK19020	34	RK22110	39	RS20200	36
MP49410-1	73	RK19030	34	RK22120	40	SP21000	36
MP49412	73	RK19040	34	RK22130	40	SP21002	36
MP49430	73	RK19050	34	RK22140	40	SP21010	36
MP49432	73	RK19060	34	RK22150	40	SP21012	36
MP49500	74	RK19070	34	RK22160	41	SP21020	36
MP50560	73	RK19080	34	Rk22170	41	SP21022	36
MP50562	73	RK19090	34	RK22180	38	SP21030	36
MP51010	25, 478	RK19100	34	RK22190	38	SP21032	36
MP51012	25, 478	RK19110	34	RK22200	38	TC42834	67
MP51020	25, 492	RK19120	34	RK22290	38	TC42884	66
MP51022	25, 492	RK19130	34	RK40100	42	TC42894	67
MP51030	25, 492	RK19140	34	RK40102	42	TC42904	67
MP51032	25, 492	RK19150	34	RK40110	42	TC42914	67
MP51040	25, 492	RK19160	34	RK40112	42	TC43504	67
MP51042	25, 492	RK19170	34	RK40120	42	TC43604	67
MP51050	25, 492	RK19210	38	RK40122	42	TC43614	67
MP51052	25, 492	RK19220	38	RK40130	42	TC43624	67
MP51090	25, 31, 381	RK19230	38	RK40132	42	TC43634	67
MP51092	25, 31, 381	RK19240	38	RK40140	42	TC43654	66
MP52000	25, 31, 381	RK19310	38	RK40142	42	TC43744	66
MP52002	25, 31, 381	RK19320	38	RK40150	42	TC43754	66
MP59012	33	RK19400-1	41	RK40152	42	TC43904	66
MP59032	33	RK19410-1	41	RK40170	42	TC43924	66
MP59042	33	RK19410-RED	41	RK40172	42	TC43944	67
MP59102	33	RK19420-1	41	RK40350	42	TC44054	66
MP59122	33	RK19430-1	41	RK40352	42	TC44094	66
MP59132	33	RK19440-1	41	RK40360	42	TC44224	66
MP59162	33	RK19450-1	41	RK40362	42	TC44254	66
MP78372	33	RK19460-1	41	RK40370	42	TC44384	67
MP78710	33	RK19480-1	41	RK40372	42	TC50000	67
MP78712	33	RK19490-1	41	RK40380	42	TC51000	66
MP78720	33	RK19500K	43	RK40382	42	TC51100	66
MP78722	33	RK19510K	43	RK40390	43	TC51200	66
MP78730	33	RK19520K	43	RK40392	43	TC51300	67
MP78740	33	RK19530K	43	RK40400	43	TC52000	66
MP78800	33	RK19540-1	41	RK40402	43	TG19520	45
MP78802	33	RK19550-1	41	RK40470	43	TG19522	45
MP78820	33	RK19570	42	RK40472	43	TG19530	45
MP78822	33	RK19572	42	RK40480	43	TG19532	45
MP78830	33	RK19630	44	RK40482	43	TG19540-1	47
MP78860	33	RK19632	44	RK40610B	37	TG19542-1	47
MP78870	33	RK19640	44	RK40610G	37	TG19560-1	47
MP78872	33	RK19642	44	RK40620B	37	TG19562-1	47
MP78910	33	RK19680	39	RK40620G	37	TG21020-2	47
MP78912	33	RK19680TP	39	RK40630B	37	TG21022-1	47
MP78942	33	RK19690	39	RK40630G	37	TG21040	47
MP78950	33	RK19690TP	39	RK40640B	37	TG21042	47
MP78952	33	RK19700	40	RK40640G	37	TG21050-1	47
MP78960	33	RK19700TP	40	RK40650B	37	TG21052-1	47
MP78962	33	RK19710TP	39	RK40650G	37	TG21070	47
MP79740	33	RK19720	39	RK40660B	37	TG21072	47
MP79742	33	RK19730TP	40	RK40660G	37	TG21080	47
MP79760	33	RK19740	40	RK40670B	37	TG21082	47
MP79762	33	RK19750TP	39	RK40670G	37	TG21130	48
N-186913	62	RK19760	39	RK40680B	37	TG21132	48
OP22891	20, 66	RK19770TP	40	RK40680G	37	TG21140	48
OP22900	20, 66	RK19780	40	RK40690B	37	TG21142	48
PC51000	65	RK19810TP	40	RK40690G	37	TG21360	48
PC51010	65	RK19820	40	RK40700B	37	TG21362	48
PC51020	65	RK19830TP	40	RK40700G	37	TG21390	48
PC51030	65	RK19840	40	RK40800	36	TG21392	48
PC51040	65	RK19850TP	39	RK40810	36	TG21500	47
PC51050	65	RK19860	39	RK40820	36	TG21502	47
PC51060	65	RK19870TP	39	RK40830	36	TG21590	47
PC51070	65	RK19880	39	RK40840	36	TG21592	47
PC51080	65	RK19890TP	40	RK40850	36	TG21600	47

Obsolete

SIERRA #	PAGE #	SIERRA #	PAGE #	SIERRA #	PAGE #	SIERRA #	PAGE #
SIERRA SWITCH & ELECTRICAL							
TG21602	47	TG40030-1	45	TG4046252	45	UN42002	53
TG22000	46	TG4003252	45	TG40490	45	UN77310	69
TG22002	46	TG40040-1	45	TG40492	45	WH10003	66
TG22010	46	TG4004252	45	TS25101	66	WH10040	68
TG22012	46	TG40050-1	45	UN12140	27	WH10220	69
TG22020	46	TG4005252	45	UN12142	27	WH10230	68
TG22022	46	TG40060	45	UN19700	44	WH10240	69
TG22030	46	TG40062	45	UN19710	44	WH10300	67
TG22032	46	TG40070	45	UN19720	44	WH10310	67
TG22040	46	TG40072	45	UN19730	44	WH10320	69
TG22042	46	TG40080	45	UN19740	44	WH10350	66
TG23000	46	TG40082	45	UN19750	44	WH10470-1	68
TG23002	46	TG40090	45	UN21280	52	WH10480-1	68
TG23010	46	TG40092	45	UN21282	52	WH10490-1	68
TG23012	46	TG40160-1	45	UN21290	52	WH10500-1	68
TG23020	46	TG4016252	45	UN21292	52	WH10520-1	68
TG23022	46	TG40300	45	UN21320	52	WH10530-1	68
TG23030	46	TG40302	45	UN21322	52	WH10540-1	68
TG23032	46	TG40310	45	UN22100	52	WH10550-1	68
TG23040	46	TG40312	45	UN22102	52	WH10560	68
TG23042	46	TG40320	45	UN22110	52	WH10570	68
TG23050	46	TG40322	45	UN22112	52	WH10600-1	68
TG23052	46	TG40330	45	UN22120	52	WH10602-1	68
TG40000	47	TG40332	45	UN22122	52	WH10610-1	68
TG40002	47	TG40340	45	UN22150	52	WH10612-1	68
TG40010	46	TG40342	45	UN22152	52	WH10640	68
TG40012	46	TG40450-1	45	UN22160	52	WH10650	68
TG40020-1	45	TG4045252	45	UN22162	52		
TG4002252	45	TG40460-1	45	UN42000	53		

SHIELDS

16-14X1X10	125	N14NEO60	125	SERIES 151	125	SERIES 321	103
16-14X2X10	125	N-184456	122	SERIES 157	82	SERIES 337	99
16-18X1X10	125	N-184457	122	SERIES 160	87	SERIES 350	100
16-18X2X10	125	N-184458	122	SERIES 162	96	SERIES 351	100
16-38X1X10	125	N18NEO60	125	SERIES 163	98	SERIES 355	101
16-38X2X10	125	N316NEO60	125	SERIES 164	97	SERIES 365	101
18-4456	122	N38NEO60	125	SERIES 168	97	SERIES 357	82
18-4457	122	SERIES 101	106	SERIES 200	88, 112	SERIES 368	102
18-4458	122	SERIES 105	106	SERIES 202	89, 113	SERIES 369	102
18-800-1120	106	SERIES 120	83	SERIES 220	120	SERIES 375	82
18-801-1120	106	SERIES 123	83	SERIES 220S	118	SERIES 400	110
18-802-1120	106	SERIES 126	124	SERIES 221	120	SERIES 402	110
18-803-1120	106	SERIES 128	123	SERIES 245	120	SERIES 420	110
18-806-1120	106	SERIES 129	123	SERIES 245S	119	SERIES 450	111
18-9093	108	SERIES 130	87	SERIES 250	90, 109, 114	SERIES 460	111
18-9095	108	SERIES 135	87	SERIES 252	91, 115	SERIES 500	104
18-9761B	124	SERIES 140	84	SERIES 254	81	SERIES 502	104
18-9761G	124	SERIES 141	85, 94	SERIES 262	91, 116	SERIES 600	104
18-9761W	124	SERIES 142	84	SERIES 272	118	SERIES 601	104
18-9883B	124	SERIES 144	107	SERIES 274	118	SERIES 700	104
18-9883G	124	SERIES 146	85, 107	SERIES 290	121	SERIES 710	122
18-9883W	124	SERIES 147	84	SERIES 290S	119	SERIES 720	122
18-J662-XXX	104	SERIES 148	86, 94, 108	SERIES 291	121		
18-J664-XXX	104	SERIES 149	86, 95	SERIES 309	98		
18-J-WISE	Obsolete	SERIES 150	95	SERIES 315	98		

SIERRA #	O.E.M.	O.E. #	PAGE #	SIERRA #	O.E.M.	O.E. #	PAGE #
GENERATOR PARTS							
18-9400-2			135, 206, 210	23-3609	Kohler	252896	130, 142, 144
18-9410-2			135, 207, 210	23-3610	Kohler	267717	Obsolete
18-9420-2			135, 206, 210	23-3650	Westerbeke	24688 & 24323	132, 139
18-9553-2			135, 205, 210	23-3651	Westerbeke	35736 & 34196	132, 139, 141
23-0400	Northern Lights		129	23-3652	Westerbeke	35736 & 33417	132, 141
23-0800	Westerbeke	42260	131, 141	23-3653	Westerbeke	24688 & 34196	132, 139
23-0801	Westerbeke	46124	131, 141	23-3654	Westerbeke	39378 & 42260	132, 141
23-0802	Westerbeke	34196	131, 139, 141	23-3655	Westerbeke	39378 & 46124	132, 141
23-0803	Westerbeke	33417	131, 141	23-3656	Westerbeke	46097 & 33417	132, 141
23-0804	Westerbeke	33373	131, 139	23-3657	Westerbeke	24690 & 33417	132, 141
23-0805	Westerbeke	40434	131, 141	23-3658	Westerbeke	24688 & 33966	133, 139
23-0806	Westerbeke	24323	131, 139	23-3659	Westerbeke	37387 & 37922	133, 139, 141
23-0807	Westerbeke	33966	131, 139	23-3660	Westerbeke	24690 & 33373	133, 139
23-0808	Westerbeke	37922	131, 139, 141	23-3661	Westerbeke	35736 & 40434	133, 141
23-0809	Kohler	267718	131, 147	23-3662	Westerbeke	24688 & 40434	133, 141
23-0810	Kohler	229432	131, 143, 145	23-3663	Kohler	267717 & 267718	133, 147
23-0811	Kohler	249865	131, 143, 145	23-3664	Kohler	249930 & 29963	133, 147
23-0812	Kohler	229433	132, 145	23-3665	Kohler	252896 & 229432	133, 143, 145
23-0813	Kohler	229963	132, 143, 145, 147	23-3666	Kohler	352018 & 352031	133, 145
23-0814	Kohler	352031	132, 145	23-4000	Westerbeke	39181	136
23-0830	Northern Lights	11-10015	132	23-4001	Westerbeke	11672	136
23-1000	Westerbeke	24353	127, 139	23-4002	Westerbeke	30592	136
23-1100	Kohler	267709	126	23-4003	Westerbeke	45232	136
23-1101	Westerbeke	39705	126, 139, 143, 147	23-4004	Westerbeke	30475	136
23-1102	Northern Lights	24-22009	126, 151	23-4005	Westerbeke	13810	129
23-1103	Northern Lights	24-28003	126, 149	23-4006	Westerbeke	31152	130
23-1104	Fischer Panda	IC78.460.000B	126, 14	23-4007	Westerbeke	30376	130
23-1105	Fischer Panda	IC78.460.000A	126, 149	23-4500	Westerbeke	43060	134, 190
23-1130	Kohler	278857	126, 143, 145	23-4501	Westerbeke	46596	134, 190
23-2000	Sherwood	10077K	128, 138, 140, 148	23-5600	Westerbeke	30593	136, 138
23-2001	Johnson Pump	09-808B-1	128, 138, 140, 148	23-5800	Westerbeke	24639	136, 139
23-2002	Kohler	229826	128, 142, 144, 146	23-5840	Westerbeke	35109	127
23-2002	Sherwood	09000K	128, 142, 144, 146	23-5880	Westerbeke	24132	127, 139, 141
23-2003	Jabsco	22799-0001	128, 142	23-5900	Westerbeke	30594	Obsolete
23-2003	Kohler	250872	128, 142	23-6400	Kohler	260085	136
23-2004	Kohler	359978	128, 146	23-6400	Westerbeke	11885	136
23-2005	Northern Lights	25-12009	128, 148	23-6401	Onan	130-4434	136
23-2700	Westerbeke	40859	133	23-6402	Onan	130-6228	136
23-2701		34113	133	23-7200	Westerbeke	36450	126, 141
23-2702	Westerbeke	35608	133	23-7201	Westerbeke	38100	126, 139, 141
23-2703	Westerbeke	46592	133	23-7202	Kohler	GM24510	126, 147
23-2800		34093	134	23-7720	Onan	149-1445	127, 138, 140
23-2801		35610	134	23-7720	Westerbeke	35920	127, 138, 140
23-2802	Westerbeke	40860	134	23-7740	Kohler	252898	126, 142, 144
23-2803	Westerbeke	43050	134	23-7750	Onan	149-0428	127, 148
23-2804		42201	134	23-7751	Kohler	229715	126, 142, 144, 150
23-3300	Onan	132-0349	128, 146	23-7760	Onan	149-2106	127, 146, 148
23-3301	Westerbeke	11907	128, 138, 140	23-7760	Onan	A026K278	127, 146, 148
23-3302	Westerbeke	33112	128, 138, 140	23-7761	Kohler	GM32359	127, 144
23-3303	Kohler	229826	128, 142, 144, 146	23-7762	Kohler	26987	127, 146
23-3304	Kohler	229955	128, 144	23-7764	Westerbeke	24363	127, 138
23-3305	Westerbeke	32620	128, 138, 140, 148	23-7770	Westerbeke	30200	127, 138, 140, 142
23-3306	Westerbeke	46622	129, 140	23-7770	Westerbeke	47060	127, 138, 140, 142
23-3307	Westerbeke	34440	129, 138	23-7771	Kohler	249433	127, 146
23-3308	Kohler	352122	129, 144	23-7780	Kohler	GM34570	127, 146
23-3309	Onan	132-0436	129, 148	23-7800	Westerbeke	36918	134
23-3310	Onan	541-1519	129, 148	23-7801	Westerbeke	35595	134, 139, 141, 149, 151
23-3311	Fischer Panda	J009-46840	129, 148, 150	23-7802	Westerbeke	48076	134, 139
23-3312	Fischer Panda	J009-1027B-1	129, 148, 150	23-7803	Kohler	326817	134, 147
23-3313	Westerbeke	33104	129, 138	23-7804	Onan	185-7444	134, 149
23-3314	Kohler / Sherwood	359978	129, 146	23-7820	Kohler	279449	134, 147
23-3315	Northern Lights	25-12009	129, 148	23-7821	Kohler	359771	135, 147
23-3600	Westerbeke	26488	130, 138, 140	23-7822	Kohler	229678	135, 143
23-3601	Westerbeke	35736	130, 138, 140	23-7823	Kohler	267714	135, 147
23-3602	Westerbeke	37387	130, 138, 140	23-7824	Kohler	GM47465	135, 143, 145
23-3603	Westerbeke	39378	130, 140	23-7825	Westerbeke	35828	135, 139
23-3604	Westerbeke	46097	130	23-7826	Westerbeke	40154	135, 139
23-3605	Westerbeke	24690	130, 138, 140	23-7840	Onan	122-0810	135, 147, 149
23-3606	Onan	309-0130	130, 148	23-7841	Onan	122-0185	135, 149
23-3607	Kohler	352018	130, 144	23-7842	Onan	185-5835	135, 147, 149
23-3608	Kohler	249930	130, 146	56966P			21, 135
				56967P			21, 135

1 This product is priced per piece. To order, priced per package, please add -9 to the part number

2 Items ending in "D" are display packaged - regular number is non-display

3 For discount shop pack of 10, please add -10 to the part number

SIERRA #	O.E.M.	O.E. #	PAGE #	SIERRA #	O.E.M.	O.E. #	PAGE #
SIERRA							
4701			577	1 18-0115	Chrysler Force	27-F307279-2	253
4702			577	18-0116			219
4703			577	18-0117	OMC	317955	329
4705			577	1 18-0118	OMC	325092	327
4711			577	1 18-0119	Chrysler Force	27-F85154-1	253
4712			577	18-0120	OMC	325211	329
4713			577	18-01200			231
4714			577	18-01202			231
4715			577	1 18-0122	OMC	325260	328
4720			577	1 18-0124	OMC	325537	332
4721			577	1 18-0126	OMC	326264	329
4722			577	18-0128	OMC	326468	330
4723			577	18-0129	Mercury Marine	27-65744	438
4724			577	18-0129	Mercury Marine	27-657441	438
4725			577	18-0129	Mercury Marine	27-657442	438
4730			577	18-0129	Mercury Marine	27-657443	438
4731			577	1 18-0130	OMC	332266	328
4732			577	18-01301			231
4733			577	18-01302			231
4734			577	18-01308			231
4735			577	18-0131	Mercury Marine	27-64857	438
22355	OMC	390905	219	18-0131	Mercury Marine	27-69525	438
37467			219	18-0131	Mercury Marine	27-695251	438
37477	OMC	500421	Obsolete	18-0131	Mercury Marine	27-695252	438
37478	Mercury Marine	92-809819	Obsolete	18-01311			231
37478	OMC	388517	Obsolete	18-01312			231
37478	OMC	500422	Obsolete	18-01313			231
37479	Mercury Marine	92-809820	219	18-01314			231
37479	OMC	500423	219	18-0133	Mercury Marine	27-52892	438
37509	Mercury Marine	92-59327-1	Obsolete	18-0133	Mercury Marine	27-73665	438
37509	Mercury Marine	92-809824	Obsolete	1 18-0134	OMC	327707	327
37509	Mercury Marine	FT8935	Obsolete	18-0135	Mercury Marine	27-78246	440
37509	OMC	384884	Obsolete	18-0135	Mercury Marine	27-782461	440
37534	Mercury Marine	92-41669-1	Obsolete	18-0136	OMC	328283	330
37534	Mercury Marine	92-802882A1	Obsolete	18-0137	Mercury Marine	27-85492-2	438
37534	Mercury Marine	92-823506 1	Obsolete	18-0138	OMC	328590	330
37566			219	18-0139	Mercury Marine	27-76589	440
37643			Obsolete	18-0139	Mercury Marine	27-78623	440
37701			219	18-0139	Mercury Marine	27-88451	440
38653	OMC	384848	Obsolete	18-0139	Mercury Marine	27-884511	440
56507	OMC	910048	Obsolete	18-0140	OMC	328604	328
79040	OMC	390928	219	18-01402			231
1525607	Mercury Marine	92-34227	Obsolete	18-01404			231
1525607	Mercury Marine	92-342271	Obsolete	18-01406			231
1525607	Mercury Marine	92-34227Q02	Obsolete	18-01408			231
1525607	Mercury Marine	92-802881A1	Obsolete	1 18-0141	Chrysler Force	27-F85762	253
1525607	OMC	317201	Obsolete	18-01416			231
1525607	OMC	508235	Obsolete	18-01418			231
2096059			Obsolete	18-0142	OMC	328622	328
18-0020	Yamaha	67C-W0001-21-00	Obsolete	18-01422			231
18-0021	Yamaha	688-W0001-22-00	564	1 18-0144	OMC	328626	328
18-0022	Yamaha	689-W0001-23-00	564	18-0146			989
18-0023	Yamaha	689-W0001-C2-00	564	18-0147	Mercury Marine	27-56880	829
18-0024	Yamaha	698-W0001-21-00	564	18-0147	OMC	3852824	1004
18-0025	Yamaha	69G-W0001-20-00	564	18-0147	Volvo	3852824	1004
18-0026	Yamaha	6A1-W0001-22-00	565	18-0148	OMC	329718	328
18-0027	Yamaha	6A1-W0001-23-00	565	18-01500			231
18-0028	Yamaha	6E0-W0001-C1-00	565	18-0151	Mercury Marine	27-75952	439
18-0029	Yamaha	6G1-W0001-C1-00	565	18-0151	Mercury Marine	27-76636	439
18-0030	Yamaha	6L2-W0001-C3-00	565	1 18-0152	Chrysler Force	27-F481836	Obsolete
18-0031	Yamaha	6N0-W0001-C0-00	565	18-0153	Mercury Marine	27-72627	823
18-0032	Volvo	847741	200, 690, 996	18-0153	Mercury Marine	27-85817A1	823
18-0033	Volvo	21707133	200, 690, 996	18-0153	Mercury Marine	F15110032	823
18-0034	Volvo	477556	200, 690, 996	18-0153	Mercury Marine	F15110037	823
18-0035	Volvo	3582732	200, 690, 995	18-0153	OMC	357159	923
18-0036	Volvo	3582733	200, 690, 895	18-0153	OMC	393159	923
18-00534			233	18-0153	OMC	458625	923
18-00535			232	18-0154	Chrysler Force	27-F40279-1	254
18-0101	Mercury Marine	27-73397	Obsolete	1 18-0155	OMC	330412	322
18-0101	Mercury Marine	27-76952	Obsolete	18-0157	OMC	330698	328
18-0102	OMC	323469	320, 320, 329	18-0158	Mercury Marine	27-70905	827
18-0103	Mercury Marine	27-37725	432, 433, 440	18-0159	OMC	330909	328
18-0103	Mercury Marine	27-72496	432, 433, 440	18-01600			231
18-0103	Mercury Marine	27-79650	432, 433, 440	18-01602			231
18-0103	Mercury Marine	27-796501	432, 433, 440	18-0161	OMC	331532	328
1 18-0104	OMC	907764	826	18-0163			991
18-0105	Mercury Marine	27-85489-2	Obsolete	1 18-0164	OMC	311069	1002
1 18-0106	OMC	324323	321, 329	1 18-0164	Volvo	3852096	925
18-0107	Mercury Marine	27-64203	432, 438	1 18-0164	Yamaha	YSC-13080-00-OC	1013
18-0107	Mercury Marine	27-72510	432, 438	1 18-0166	OMC	911705	928
18-0107	Mercury Marine	27-85498	432, 438	18-01701			231
18-0107	Mercury Marine	27-85498-1	432, 438	18-01703			231
1 18-0108	OMC	324449	302, 332, 361	18-01705			231
1 18-0110	OMC	324670	332	18-01707			232
18-01101			231	18-0172	Mercury Marine	26-97530	464, 875
18-0111	Mercury Marine	27-89657	823, 8827	18-0173	OMC	313283	365
18-0112	OMC	324717	321, 330	18-0174	OMC	326716	365
18-0113-1	Mercury Marine	27-856705	827	1 18-0175	Mercury Marine	25-26543	823
18-0113-1	Mercury Marine	27-97542	823, 823, 827	18-0176	Honda	19242-ZV5-000	265
18-0114-1	OMC	907761	917, 926	18-0179	Racor	RK22244	154

1 This product is priced per piece. To order, priced per package, please add -9 to the part number

2 Items ending in "D" are display packaged - regular number is non-display

3 For discount shop pack of 10, please add -10 to the part number

SIERRA #	O.E.M.	O.E. #	PAGE #	SIERRA #	O.E.M.	O.E. #	PAGE #	
SIERRA								
1	18-0182	Mercury Marine	27-62386	441	18-0294	Yamaha	663-44324-A0-00	549
1	18-0182	OMC	310058	331	18-0296	Mercury Marine	26-854017M	464
	18-0183-1	Mercury Marine	27-54566	661, 799, 827	18-0296	Yamaha	93101-22067-00	568
	18-0183-1	Mercury Marine	27-73866	661, 799, 827	18-0297	Mercury Marine	26-82234M	564
	18-0183-1	OMC	908717	661, 799	18-0297	Yamaha	93101-23070-00	568
	18-0183-1	OMC	916262	661, 799	18-0298	Mercury Marine	25-82275M	467
	18-0183-1	OMC	3852455	661, 799	18-0298	Yamaha	93210-41042-00	568
	18-0183-1	OMC	3853742	661, 799	18-0299	Mercury Marine	25-82289M	467
	18-0183-1	Pleasurecraft	RM0007	649	18-0299	Yamaha	93210-66M98-00	568
	18-0183-1	Volvo	3852455	661, 1002	18-0300	Honda	17105-ZY6-000	266
	18-0183-1	Volvo	3853742	661, 1002	18-0305-1	Crusader	96108	629
	18-0184	Volvo	804190	1007	18-0306-1	Crusader	96216	629
1	18-0185	Mercury Marine	27-91892	823, 829	18-0307	Volvo	861250	1003
1	18-0188	OMC	909748	929	18-0309-1	Crusader	96562	629
	18-0190	OMC	912157	928	18-0310	Volvo	861251	1003
	18-0191	Yamaha	92990-06600-00	522	18-0311	Crusader	97686	630
	18-0192	Yamaha	92990-10600-00	534	18-0311	Mercury Marine	27-11988	828
	18-0192	Yamaha	92900-10600-00	534	18-0311	OMC	3854942	927
	18-0192	Yamaha	92901-10600-00	534	18-0311	Volvo	3854942	1003
	18-0192	Yamaha	92902-10600-00	534	18-0313	OMC	352165	332
	18-0192	Yamaha	92903-10600-00	534	18-0314	Chrysler Force	27-828316	253
	18-0192	Yamaha	92995-10600-00	534	18-0314	Chrysler Force	27-F178168	253
	18-0195	OMC	314731	349, 939	18-0314	Chrysler Force	27-F178168-1	253
	18-0197	OMC	333725	339, 349	18-0314	Chrysler Force	F178168	253
	18-0198	OMC	324766	339, 349	18-0315	Chrysler Force	27-F440906	251, 253
	18-0200	OMC	327656	349	18-0318	Mercury Marine	12-815472	831
	18-0201	OMC	333771	349	18-0319	Mercury Marine	27-828553	430, 440
	18-0202-9	Mercury Marine	8227731	456	18-0320	Mercury Marine	27-13937-6	438
1	18-0203	Mercury Marine	12-25410	831	18-03200			232
1	18-0203	Mercury Marine	12-35935	831	18-03206			232
	18-02060	OMC	911680	931, 932	18-03208			232
	18-02061	OMC	911681	931, 932	18-0322	Mercury Marine	27-14241	830
	18-02062	OMC	911662	931, 932	18-0322	Mercury Marine	27-861715	830
	18-02063	OMC	911663	931, 932	18-0322	Mercury Marine	F1101656	830
	18-02065	OMC	911665	931, 932	18-0322	OMC	3852656	928
	18-02066	OMC	911666	931, 932	18-0322	Volvo	3852656	1005
	18-02067	OMC	911667	931, 932	18-0323	Mercury Marine	27-14318 3	441
	18-0207	OMC	911668	931, 932	18-0323	Mercury Marine	27-14318-2	441
	18-0208	Mercury Marine	23-1761515	844	18-0324	Mercury Marine	27-15172	437
	18-0209	OMC	911669	931, 932	18-0324	Mercury Marine	27-15172-3	430
	18-0209	OMC	911670	931, 932	18-0324	Mercury Marine	27-151724	437
	18-0209	OMC	911671	931, 932	18-0324	Mercury Marine	27-93214	437
	18-0209	OMC	911672	931, 932	18-0327	Mercury Marine	27-33956	829
	18-0209	OMC	911673	931, 932	18-0327	Mercury Marine	F15000200	829
	18-0209	OMC	911674	931, 932	18-0327	Mercury Marine	F15000219	829
	18-0209	OMC	911675	931, 932	18-0327	OMC	3853342	927
	18-0209	OMC	911676	931, 932	18-0327	Volvo	3853342	1003
	18-0209	OMC	911677	931, 932	18-0328	Mercury Marine	27-34208	829
	18-0210	Mercury Marine	23-1761516	844	18-0329	Mercury Marine	27-34209	829
	18-0211	OMC	911669	931, 932	18-0329			928
	18-0211	OMC	911670	931, 932	18-0333	Mercury Marine	27-39401	440
	18-0211	OMC	911671	931, 932	18-0334	Mercury Marine	27-39402	440
	18-0211	OMC	911672	931, 932	18-0336	Mercury Marine	27-41670-3	440
	18-0211	OMC	911673	931, 932	18-0336	Mercury Marine	27-41670-5	440
	18-0211	OMC	911674	931, 932	18-0337			989
	18-0211	OMC	911675	931, 932	18-0339	Mercury Marine	27-43006-2	441
	18-0211	OMC	911676	931, 932	18-0339	Mercury Marine	27-430066	441
	18-0211	OMC	911678	931, 932	18-03400			232
	18-0212	Mercury Marine	23-1761517	844	18-03404			232
	18-0214	Mercury Marine	23-1761518	844	18-0341	Mercury Marine	27-43008	440
	18-0216	Mercury Marine	23-1761519	844	18-0341	Mercury Marine	27-430082	440
	18-0218	Mercury Marine	23-1761520	844	18-0341	Mercury Marine	27-430083	440
	18-0222	Mercury Marine	23-1761522	844	18-0341	Mercury Marine	27-430085	440
	18-0224	Mercury Marine	23-1761523	844	18-0341	Mercury Marine	27-430086	440
	18-0226	Mercury Marine	23-1761524	844	18-0342	Mercury Marine	27-47644	830
	18-0227	OMC	911678	931, 932	18-0342	Mercury Marine	27-47644	830
	18-0229	OMC	911679	931, 932	18-0342	Mercury Marine	27-476441	830
	18-0230	Mercury Marine	23-1761526	844	18-0345	Mercury Marine	27-822189	442
	18-0232	Mercury Marine	27-81031M	439	18-0346	Mercury Marine	27-34042	828
	18-0232	Yamaha	655-12414-A1-00	548	18-0346	Mercury Marine	27-49936	828
	18-0239	Yamaha	688-44315-A0-00	548	18-0346	OMC	3930912	927
	18-0240	Yamaha	688-44316-A0-00	549	18-0347	Mercury Marine	27-34041	828
	18-0242	Yamaha	663-13622-00-00	543	18-0347	Mercury Marine	27-52145	828
	18-0242	Yamaha	663-13622-A0-00	543	18-0347	Mercury Marine	27-806452	828
	18-0244	Yamaha	6E5-44315-A0-00	549	18-0347	OMC	912981	927
	18-0248	Honda	17151-ZW5-00	266	18-0347	OMC	913277	927
	18-0250	Yamaha	664-41114-A0-00	538, 548	18-0347	OMC	3852693	927
	18-0252	Volvo	878314	999	18-0347	Volvo	3852693	927
	18-0256	Yamaha	97080-08045-00	515	18-0348	Mercury Marine	27-49107	823
	18-0256	Yamaha	97095-08045-00	515	18-0348	Mercury Marine	27-52550	823
	18-0260	Yamaha	90119-08M33	523	18-0348	Mercury Marine	F1100229	823
	18-0261	Yamaha	97080-06045	522	18-0348	Mercury Marine	F15000229	823
	18-0265	Yamaha	93101-28M16-00	568	18-0348	Mercury Marine	F15000245	823
	18-0266	Yamaha	93101-30M17-00	568	18-0348	OMC	508871	823
	18-0267	Mercury Marine	26-82257M	464	18-0348	OMC	3931593	823
	18-0267	Yamaha	93106-09014-00	568	18-0352	Mercury Marine	27-56173	828
	18-0275	Yamaha	93210-97M55-00	568	18-0352	OMC	913758	927
	18-0292	Mercury Marine	27-81417M	441	18-0352	Volvo	3852618	1003
	18-0292	Yamaha	663-44315-A0-00	549	18-0353	Mercury Marine	27-58764	799
1	18-0294	Mercury Marine	27-81421M	441	18-0354	Mercury Marine	27-60715	825

1 This product is priced per piece. To order, priced per package, please add -9 to the part number

2 Items ending in "D" are display packaged - regular number is non-display

3 For discount shop pack of 10, please add -10 to the part number

SIERRA #	O.E.M.	O.E. #	PAGE #	SIERRA #	O.E.M.	O.E. #	PAGE #
SIERRA							
18-0356	Mercury Marine	27-32910	825	18-0418	Mercury Marine	27-46820	661
18-0356	Mercury Marine	27-64692	825	18-0418	Volvo	3852472	990
18-0357	Mercury Marine	27-56884	825	18-0418	OMC	909613	927
18-0357	Mercury Marine	27-65577	825	18-0421	Yamaha	6AW-44323-00	522
18-0359	Mercury Marine	27-67275	438	18-0422	Mercury Marine	391-5076	826
18-0359	Mercury Marine	27-672751	438	18-0430	OMC	912477	926
18-0360	Mercury Marine	27-70142	826	18-0431	OMC	912471	926
18-03600			232	18-0434	OMC	909758	925
18-03602			232	18-0435	OMC	908765	925
18-03606			232	18-0437	OMC	334353	327
18-03608			232	18-0440	OMC	915719	927
18-0365	Mercury Marine	27-75450	827	18-0441	OMC	329076	331
18-0368			981	18-0445	OMC	323312	332
18-0369	Mercury Marine	27-75909	440	18-0446	OMC	323311	Obsolete
18-0371	Mercury Marine	27-39316	438	18-0448	Yamaha	6CJ-44315-00	523
18-0371	Mercury Marine	27-72915	438	18-0449	Yamaha	6CJ-44316-00	523
18-0371	Mercury Marine	27-78409	438	18-0450	Yamaha	6CJ-44324-00	523
18-0372	Mercury Marine	27-52579	439	18-0451	Yamaha	6CB-44315-00-00	522
18-0372	Mercury Marine	27-72916	439	18-0452	Yamaha	6AW-44315-00	522
18-0372	Mercury Marine	27-78410	439	18-0453	Yamaha	65N-44315-A0	523
18-0373	Mercury Marine	27-45088	438	18-0459	Suzuki	17472-95200	485
18-0373	Mercury Marine	27-72917	438	18-0460	Suzuki	17472-95310	485
18-0373	Mercury Marine	27-78411	438	18-0461	Suzuki	17472-96301	485
18-0376			991	18-0462	Mercury Marine	27-48399	826
18-0377			991	18-0463	Mercury Marine	27-814210	826
18-0378	Mercury Marine	27-823142	440	18-0464	Mercury Marine	27-49121	828
18-0378	Mercury Marine	27-823142 2	440	18-0464	Mercury Marine	27-91831	828
18-0380	Mercury Marine	27-83940M	438	18-0464	OMC	912768	927
18-0382	Honda	17109-XY6-000	266	18-0465	Mercury Marine	27-65184	822
18-0384	Mercury Marine	27-817533	437	18-0465	Mercury Marine	27-8M0050224	822
18-0384	Mercury Marine	27-89221	437	18-0465	OMC	352670	923
18-0384	Mercury Marine	27-892211	437	18-0466	Mercury Marine	27-14901	823
18-0384	Mercury Marine	27-8M0027781	437	18-0466	Mercury Marine	27-14901A1	823
18-0385	Mercury Marine	27-30803	440	18-0466	Mercury Marine	27-52144	823
18-0385	Mercury Marine	27-31557	440	18-0466	OMC	393061	923
18-0385	Mercury Marine	27-45748	440	18-0466	OMC	3921473	923
18-0385	Mercury Marine	27-89937	440	18-0466	OMC	3923440	923
18-0386	Mercury Marine	27-72780	829	18-0467	Mercury Marine	27-41610	826
18-0386	Mercury Marine	27-94914	829	18-0467	Mercury Marine	27-49814	826
18-0388	Mercury Marine	27-98823	830	18-0468	Mercury Marine	27-811572	928
18-0388	Mercury Marine	27-988231	830	18-0468	OMC	912954	928
18-0389	Mercury Marine	27-99960	827	18-0468	OMC	915326	928
18-0390	Honda	17105-ZY3-004	266	18-0468	OMC	3852654	928
18-0396	Honda	17109-ZY3-004	266	18-0468	OMC	3853512	928
18-0397	OMC	318917	331	18-0468	Volvo	3852654	1004
18-0398	Mercury Marine	27-33918	827	18-0468	Volvo	3853512	1004
18-0398	Mercury Marine	27-8M2021920	827	18-0471			605
18-0398	OMC	312797	926	18-0472-1			605
18-0398	OMC	3852111	926	18-0474-1			605
18-0398	Volvo	835417	1002	18-0475-1			629
18-0401	OMC	913393	926	18-0476-1	Barr	01-0105	655, 657, 661, 917, 989
18-0403	Mercury Marine	27-52571	820	18-0476-1			589, 629, 634, 636, 800
18-0403	Mercury Marine	27-61782	820	18-0477-9	Suzuki	17472-98503	485
18-0403	Mercury Marine	27-805722A1	820	18-0478	Suzuki	17472-93911	485
18-0403	Mercury Marine	27-812712	820	18-0479	Suzuki	17472-92D10	485
18-0404	Mercury Marine	27-805403A1	820	18-0480	Suzuki	17472-98611	Obsolete
18-0405	Mercury Marine	27-14247	823	18-0481	Honda	19234-ZW1-800	263
18-0405	Mercury Marine	27-883964	823	18-0482	Honda	19242-ZW1-800	263
18-0405	Mercury Marine	27-883964T	823	18-0483	Yamaha	63D-44316-00-00	548
18-0405	OMC	912955	923	18-0487	Mercury Marine	27-824326002	824
18-0405	OMC	3852655	923	18-0487	Mercury Marine	27-8243261	824
18-0405	Volvo	3852655	1003	18-0488	Mercury Marine	27-807473A1	824
18-0406	Yamaha	60X-43315-A0-00	541	18-0489	Volvo	876384	999
18-0407	Mercury Marine	27-56870A1	824	18-0491	OMC/Bombardier	348007	325
18-0407	Mercury Marine	27-64798	824	18-0492	OMC/Bombardier	340919	325
18-0407	OMC	508872	923	18-0498	Volvo	3580309	1000
18-0408	Yamaha	65N-44323-00	523	18-0499	Chrysler Inboard	10612	597
18-0409	Yamaha	69M-G4323-00	523	18-0500	Chrysler Force	26-817472	255, 257, 460
18-0410	Mercury Marine	27-75648	824	18-05002			233
18-0410	OMC	986103	923	18-05004			233
18-0410	OMC	986104	923	18-0502	Chrysler Force	26-819396	255, 257
18-0410	OMC	988162	923	18-0503	Chrysler Force	26-F40307-2	255, 257
18-0410	OMC	3853912	923	18-0512	Chrysler Force	26-F84307-1	255, 257
18-0410	OMC	3853913	923	18-0514	Mercury Marine	26-25329	443
18-0410	OMC	3854406	923	18-0515	Mercury Marine	26-30530	464, 875
18-0410	Volvo	3853912	1000	18-0516	Mercury Marine	26-30913	464, 875
18-0410	Volvo	3853913	1000	18-0517	Mercury Marine	26-32911	464, 875
18-0410	Volvo	3854406	1000	18-0518	Mercury Marine	26-34217	464, 818
18-0411	Mercury Marine	27-90458	824	18-0518	Mercury Marine	26-58094	818
18-0411	Mercury Marine	27-90458A1	824	18-0518	Mercury Marine	26-72564	818
18-0411	Mercury Marine	F15000178	824	18-0518	Mercury Marine	26-75413	818
18-0411	Mercury Marine	F15000183	824	18-0518	Mercury Marine	26-75624	818
18-0411	OMC	357159	923	18-0518	OMC	914323	929
18-0411	OMC	458625	923	18-0518	OMC	3853132	929
18-0411	OMC	508876	923	18-0518	OMC	3854956	929
18-0412	OMC	337068	331	18-0518	Volvo	914323	998
18-0415	Chrysler Force	27-F523031	524	18-0518	Volvo	3853132	998
18-0416	Chrysler Force	27-F694830	248, 254	18-0518	Volvo	3854956	998
18-0417	Chrysler Force	27-F84031	Obsolete	18-0519	Mercury Marine	26-14240	464, 818, 875
18-0418	Crusader	96653	629	18-0519	Mercury Marine	F11101300	818

1 This product is priced per piece. To order, priced per package, please add -9 to the part number

2 Items ending in "D" are display packaged - regular number is non-display

3 For discount shop pack of 10, please add -10 to the part number

SIERRA #	O.E.M.	O.E. #	PAGE #	SIERRA #	O.E.M.	O.E. #	PAGE #
SIERRA							
18-0519	OMC	3852657	922	18-0616	Mercury Marine	14244T	808
18-0519	Volvo	912957	998	18-0617	Yamaha	67F-45127-00-00	541
18-0519	Volvo	3852657	998	18-0618	Yamaha	68V-45123-00-00	541
18-0521	Mercury Marine	26-36557	443	18-0619	Yamaha	69J-41138-00-00	541
18-0522	Honda	91254-ZW1-003	268	18-0622	Chrysler Force	27-19701	254
18-0522	Mercury Marine	26-43036	464, 875	18-0622	Mercury Marine	27-19701	442
18-0523	Mercury Marine	26-43993	464, 875	18-0624	Mercury Marine	27-188891	438
18-0525	Mercury Marine	26-45587	464, 875	18-0628	OMC	341501	327
18-0526	Mercury Marine	26-48443	464, 875	18-0633	Mercury Marine	27-19206	437
18-0527	Mercury Marine	26-56397	464, 875	18-0633	Mercury Marine	27-192061	437
18-0528	Mercury Marine	26-56868	818	18-0633	Mercury Marine	27-41449	437
18-0528	OMC	913745	922	18-0633	Mercury Marine	27-414491	437
18-0528	Volvo	3852805	998	18-0633	Mercury Marine	27-42178	437
18-0529	Mercury Marine	26-62818	464, 875	18-0641	Mercury Marine	27-828292	437
18-0531	Mercury Marine	26-72785	464, 875	18-0642	Mercury Marine	27-19050	439
18-0537	Mercury Marine	26-85107	464, 875	18-0642	Mercury Marine	27-190502	439
18-0539	Mercury Marine	37721	443	18-0642	Mercury Marine	27-190503	439
18-0540	OMC	320936	333	18-0642	Mercury Marine	27-190505	439
18-0542	OMC	315288	365, 949	18-0643	Mercury Marine	27-18307-1	434, 440
18-0542	OMC	321831	365, 949	18-0643	Mercury Marine	27-183076	440
18-0543	OMC	313507	365, 949	18-0644	Mercury Marine	27-146972	438
18-0543	OMC	321895	365, 949	18-0645	Mercury Marine	27-167371	438
18-0544	Suzuki	09282-24004	489, 940	18-0646	Mercury Marine	27-813859	434, 438
18-0545	Suzuki	09289-10002	490	18-0647	OMC	986658	170, 942
18-0546	Suzuki	09282-30007	Obsolete	18-0648			991
18-0548	OMC	909515	927	18-0649	Mercury Marine	27-858935	440
18-0549	OMC	909829	929	18-0650	Suzuki	56132-95J00	488
18-0549	Volvo	3852476	929	18-0651	Suzuki	17472-98J00	485, 488
18-0550	OMC	909830	929	18-0652	OMC	914723	942
18-05500			233	18-0653	OMC	308825	942
18-05504			Obsolete	18-0654	OMC	914743	942
18-0551	Suzuki	09283-10011	490	18-0655	OMC	914736	942
18-0554	Mercury Marine	26-84813M	464	18-0656	Yamaha	69J-45123-00-00	541
18-0554	Yamaha	93101-20M07-00	568	18-0663			430, 539
18-0557	Mercury Marine	888909A1	451	18-0664	Mercury Marine	27-17467	828
18-0558	Volvo	851407	1011	18-0664	Mercury Marine	F1101287	828
18-0559	OMC	332585	365, 949	18-0664	OMC	913270	927
18-0560	Mercury Marine	26-896800	464	18-0664	OMC	3852687	927
18-0563	Mercury Marine	26-36556	443, 873	18-0664	Volvo	3852687	1003
18-0564	Mercury Marine	26-888483	464	18-0665			634
18-0568-9	Mercury Marine	23-43045	443	18-0667	Mercury Marine	27-99506	826
18-0569	Suzuki	09284-08003	490	18-0667	Mercury Marine	27-995061	826
18-0570	Yamaha	93102-23096-00	538, 568	18-0670	Mercury Marine	27-43007	440
18-0577	Mercury Marine	35993A1	850	18-0670	Mercury Marine	27-430073	440
18-0577	Mercury Marine	66081A1	850	18-0670	Mercury Marine	27-430075	440
18-0577	Mercury Marine	66081A2	850	18-0672	Mercury Marine	27-41811	800
18-0577	Mercury Marine	66081A4	850	18-0672	Mercury Marine	27-860231	800
18-0578	Mercury Marine	26-67388	818, 875	18-0672	Mercury Marine	27-863725	800
18-0579	Chrysler Force	26-41131	257	18-0672	Mercury Marine	27-8637251	800
18-0579	Mercury Marine	26-41131	464	18-0673	OMC	910113	926
18-0580	Chrysler Force	26-41132	257	18-0675	OMC	321932	308, 331
18-0580	Mercury Marine	26-41132	464	18-0676-1	Pleasurecraft	RM0099	649
18-0581	Mercury Marine	26-41365	464	18-0677-1	Pleasurecraft	RM0002	649
18-0583	Chrysler Force	26-43035	257	18-0679	OMC	311145	332
18-0583	Honda	91251-ZW1-003	268	18-0680	Mercury Marine	27-815528	928
18-0583	Mercury Marine	26-43035	464	18-0680	OMC	3853256	827
18-0584	Chrysler Force	26-66022	257	18-0681	Mercury Marine	12-32834	831
18-0584	Chrysler Force	26-F346118	257	18-0681	Mercury Marine	12-8M2001219	831
18-0584	Mercury Marine	26-66022	464	18-0681	Mercury Marine	12-93416	831
18-0585	Mercury Marine	26-821928	464	18-0681	Mercury Marine	12-934161	831
18-0586	Chrysler Force	26-99325	257	18-0685	Mercury Marine	27-73666	825
18-0586	Mercury Marine	26-99325	464	18-0690	OMC/Bombardier	347205	330
18-0587	Yamaha	93101-25M03-00	568	18-0691	OMC/Bombardier		330
18-0588	Yamaha	93102-25M28-00	568	18-0692	OMC/Bombardier	339601	330
18-0590			991	18-0693	OMC/Bombardier	336227	330
18-0592	Chrysler Force	26-F318307	257	18-0694	OMC/Bombardier	336226	330
18-0593	Chrysler Force	26-F901307-2	257	18-0695	OMC/Bombardier	336389	330
18-0595	Mercury Marine	26-66303	464	18-0696	OMC/Bombardier	336388	330
18-0601			628	18-0707	Yamaha	6CB-19016-00	504
18-0602			S/S to 18-0602-1	18-0710	Yamaha	68V-14984-00	503
18-0602-1			628	18-0711	Yamaha	66K-14984-00	503
18-0603		588, 629, 634, 649, 661, 800, 820, 918		18-0712	Yamaha	63P-14984-00	503
18-0604		588, 629, 634, 649, 661, 800, 820, 919		18-0713	Yamaha	6P2-14984-00	503
18-0605	Yamaha	67F-41138-00-00	541	18-0714	Yamaha	6AW-14984-00	503
18-0606			991	18-0715	Mercury Marine	25-809086	396
18-0607	Chrysler Inboard	3745217	605	18-0715	Yamaha	65L-14984-00	504
18-0609	Chrysler Inboard	4273129	597	18-0716	Yamaha	6CB-14984-00	504
18-0611	Mercury Marine	27-75483	824	18-0717	Yamaha	6CS-14984-00	504
18-0612	Mercury Marine	14259	808	18-0720	Mer cruiser	27-864549A02	801
18-0612	Mercury Marine	809910	808	18-0720	Mer cruiser	27-864549A1	801
18-0612	Mercury Marine	F1101295	808	18-0721	Mer cruiser	27-864547A02	801
18-0613	Mercury Marine	93476	808	18-0721	Mer cruiser	27-864547A1	801
18-0614	Mercury Marine	811549	808	18-0722	Mer cruiser	27-864547A1	801
18-0614	Mercury Marine	805048	808	18-0722	Mer cruiser	27-864850A02	801
18-0614	Mercury Marine	845668T	808	18-0737	Honda	16176-POA-004	266
18-0615	Mercury Marine	14760	808	18-0739	Yamaha	689-45113-A1-00	548
18-0615	Mercury Marine	75639	808	18-0740-1	Mercury Marine	27-805396	548
18-0615	Mercury Marine	93477	808	18-0743	Yamaha	6L2-41112-A1-00	548
18-0615	Mercury Marine	93477T	808	18-0744	Yamaha	6L2-41114-A1-00	548
18-0616	Mercury Marine	14244	808	18-0753	Yamaha	6G1-44315-A0-00	548

1 This product is priced per piece. To order, priced per package, please add -9 to the part number

2 Items ending in "D" are display packaged - regular number is non-display

3 For discount shop pack of 10, please add -10 to the part number

SIERRA #	O.E.M.	O.E. #	PAGE #	SIERRA #	O.E.M.	O.E. #	PAGE #
SIERRA							
18-0754	Yamaha	68D-E2414-A0-00	548	1 18-0876	Yamaha	YSG-10108-43-8G	1013
18-0755	Yamaha	90430-14228-00	541	1 18-0878	Pleasurecraft	RM0003	649
18-0755	Yamaha	904-30142-28-00	541	1 18-0879	Mercury Marine	27-37724	440
18-0755	Yamaha	90430-14M09-00	541	1 18-0879	Mercury Marine	27-38501	440
18-0756-1	Yamaha	6H3-44315-A0-00	549	1 18-0879	Mercury Marine	27-385011	440
18-0757	Yamaha	6H3-44324-A0-00	550	1 18-0880	OMC	911878	928
18-0761	Suzuki	17472-91J00	485	1 18-0881-1	Mercury Marine	27-18272	800
18-0765	Yamaha	6L2-14384-00-00	547	1 18-0881-1	Mercury Marine	27-97863	800
18-0767	Yamaha	688-11193-01-00	548	1 18-0882	OMC	304764	332
18-0768	Yamaha	682-44315-A0-00	550	1 18-0885-1	Mercury Marine	27-48042	800
18-0775	Yamaha	648-14198-A0-00	538	1 18-0887	Mercury Marine	27-34216	828
18-0778	Suzuki	17472-93J00	485	1 18-0887	Mercury Marine	27-49953	828
18-0779	Yamaha	6G5-11193-A0-00	548	1 18-0887	Mercury Marine	F15000201	828
18-0781	Yamaha	6E5-11193-A0-00	548	1 18-0887	OMC	912988	928
18-0782	Yamaha	6E5-11381-A1-00	548	1 18-0887	OMC	913275	928
18-0785	Yamaha	6E5-14198-A1-00	547	1 18-0887	OMC	3852691	928
18-0786	Yamaha	6E5-14384-02-00	547	1 18-0887	Volvo	3852691	1004
18-0791	Mercury Marine	27-880729	440	1 18-0887	Yamaha	YSG-14096-15-8G	1013
18-0792	Suzuki	13119-91J00	485	1 18-0889	Chris-Craft	16.50-00074	589
18-0793	Suzuki	17582-93J00	485	1 18-0889	Mercury Marine	27-34213	825
18-0794	Suzuki	17685-97J00	485	1 18-0889	Mercury Marine	27-56883	825
18-0795	Suzuki	17685-98J00	485	1 18-0889	Mercury Marine	F15000074	825
18-0796	Suzuki	17685-99E00	485	1 18-0889	Pleasurecraft	3705042	649
18-0797	Suzuki	17685-87D10	485	1 18-0889	Volvo	3852095	1002
18-0798	Yamaha	6H4-41114-A0-00	548	1 18-0889	Yamaha	YSG-10114-14-1G	1013
18-0799	Yamaha	6E5-41112-A1-00	548	1 18-0891	Chris-Craft	16.50-00078	589
18-0807-1	Yamaha	6K7-13645-A1-00	547	1 18-0891	Mercury Marine	27-34896	829
18-0808	Yamaha	6G5-11382-A1-00	547	1 18-0891	Mercury Marine	27-34897	829
18-0809	Yamaha	6G5-13645-A1-00	547	1 18-0891	Mercury Marine	F15000077	829
18-0812	Yamaha	6G5-41112-A1-00	548	1 18-0891	Mercury Marine	F15000078	829
18-0813	Yamaha	6G5-45113-A0-00	548	1 18-0891	OMC	909835	928
18-0815	Yamaha	6H4-11193-A1-00	548	1 18-0891	OMC	3852477	928
18-0823	Yamaha	6E5-13645-A1-00	548	1 18-0891	Volvo	3852477	1003
18-0826	Yamaha	90430-14115-00	550	1 18-0891	Yamaha	YSG-37545-87-G0	1013
18-0829	Yamaha	61A-12414-A0-00	548	1 18-0892	OMC	322411	331, 927
18-0829	Yamaha	6JB-12414-A0-00	548	1 18-0893	Mercury Marine	27-35380	829
18-0835	Mercury Marine	27-824853	441	1 18-0893	OMC	3850595	928
18-0835	Mercury Marine	27-8248531	441	1 18-0893	Volvo	3850595	1004
18-0835	Yamaha	62Y-12414-00-00	548	1 18-0894	Mercury Marine	27-55810	829
18-0836	Yamaha	682-12414-A1-00	548	1 18-0894	Mercury Marine	27-558101	829
18-0840-1	Yamaha	676-14984-00-00	547	1 18-0897	Mercury Marine	27-41813	800, 827
18-0844	Yamaha	688-12414-A1-00	548	1 18-0897	Mercury Marine	27-860233	800
18-0847	Yamaha	688-41112-A0-00	548	1 18-0897	Mercury Marine	27-863724	800
18-0849	Yamaha	650-24431-00	541	1 18-0898	Mercury Marine	27-56859	830
18-0849	Yamaha	650-24431-A0-00	541	1 18-0898	Pleasurecraft	RM0017	649
1 18-0850	OMC	303615	327	1 18-09002			Obsolete
1 18-0851	OMC	329826	332	1 18-09006			232
1 18-0854	Chrysler Force	27-F476067	254	1 18-0903	Mercury Marine	27-49110	829
1 18-0855	Chrysler Force	27-F85168-2	253	1 18-0903	Mercury Marine	F11101000	829
1 18-0856-1	Yamaha	64D-14384-01-00	541	1 18-0903	OMC	3853361	927
1 18-0858	Mercury Marine	25-54029	467, 876	1 18-0903	Volvo	3853361	1003
1 18-0860	Mercury Marine	25-62700	467, 876	1 18-0903	Yamaha	YSG-38600-39-G0	1013
1 18-0861	Chrysler Force	27-F85748-2	253	1 18-0904	Mercury Marine	27-60317	440
1 18-0864	Mercury Marine	26-90925	253	1 18-0905	Mercury Marine	27-34502	831
1 18-0864	Mercury Marine	27-67389	818	1 18-0905	Mercury Marine	27-49955	831
1 18-0868	Chris-Craft	16.50-00232	589	1 18-0905	Mercury Marine	27-60721	831
1 18-0868	Mercury Marine	27-17145	824	1 18-0905	Mercury Marine	27-8M0077608	831
1 18-0868	Mercury Marine	27-72637	824	1 18-0905	Yamaha	YSG-14090-90-8G	1013
1 18-0868	Mercury Marine	F11101296	824	1 18-0907			991
1 18-0868	Mercury Marine	F15000232	824	1 18-0911	OMC	911698	927
1 18-0868	Mercury Marine	F15000263	824	1 18-0912	Mercury Marine	27-60945	441
1 18-0868	OMC	985630	923	1 18-0912	Mercury Marine	27-66102	441
1 18-0868	OMC	3854269	923	1 18-0912	Mercury Marine	27-661021	441
1 18-0868	Volvo	3854269	923	1 18-0914	Mercury Marine	27-66847	441
1 18-0869	Chrysler Force	27-820500A3	253	1 18-0915	Chrysler Force	27-F406A06	Obsolete
1 18-0869	Chrysler Force	27-F40223	253	1 18-0916	Mercury Marine	27-72779	829
1 18-0870	Mercury Marine	27-27936	439	1 18-0916	Mercury Marine	27-805215	829
1 18-0870	Mercury Marine	27-279361	439	1 18-0916	Mercury Marine	27-8052151	829
1 18-0871	OMC	175158	S/S to 18-0871-1	1 18-0916	Mercury Marine	27-94915	829
1 18-0873	Chrysler Force	27-819377	254	1 18-0917	OMC	311508	333
1 18-0873	Chrysler Force	27-F97067	254	1 18-0918	Mercury Marine	27-69524	438
1 18-0874	Chris-Craft	16.50-00162	589	1 18-0918	Mercury Marine	27-695241	438
1 18-0874	Mercury Marine	27-34486	826	1 18-0918	Mercury Marine	27-695242	438
1 18-0874	Mercury Marine	27-344861	826	1 18-09200			232
1 18-0874	Mercury Marine	27-344863	826	1 18-09202			232
1 18-0874	Mercury Marine	27-34891	826	1 18-0922	Mercury Marine	27-70335	439
1 18-0874	Mercury Marine	27-52184	826	1 18-0922	Mercury Marine	27-703351	439
1 18-0874	Mercury Marine	F3932344	826	1 18-0923	OMC	313244	929
1 18-0874	Mercury Marine	F15000162	826	1 18-0926	Mercury Marine	27-73645	439
1 18-0874	OMC	312780	925	1 18-0927	OMC	393561	329
1 18-0874	OMC	3852109	925	1 18-0928-1	Mercury Marine	27-73814	827
1 18-0874	Volvo	3852109	1005	1 18-0928-1	Mercury Marine	27-738141	827
1 18-0874	Yamaha	YSG-10108-44-5G	1013	1 18-0928-1	Mercury Marine	27-807218	827
1 18-0875			630, 646, 649	1 18-0929	OMC	313416	331, 925
1 18-0876	Chris-Craft	16.50-05756	589	1 18-0929	Volvo	3852120	992
1 18-0876	Mercury Marine	27-34898	825	1 18-0932	Mercury Marine	27-76862	439
1 18-0876	Mercury Marine	F15005756	825	1 18-0932	Mercury Marine	27-768621	439
1 18-0876	OMC	312800	925	1 18-0933	OMC	314115	328
1 18-0876	OMC	3852113	925	1 18-0934-1	Mercury Marine	27-78069	441
1 18-0876	Volvo	3852113	1002	1 18-0935	OMC	314322	328

1 This product is priced per piece. To order, priced per package, please add -9 to the part number

2 Items ending in "D" are display packaged - regular number is non-display

3 For discount shop pack of 10, please add -10 to the part number

SIERRA #	O.E.M.	O.E. #	PAGE #	SIERRA #	O.E.M.	O.E. #	PAGE #	
SIERRA								
1	18-0936	Mercury Marine	27-78690	441	18-0999-9	OMC	323459	329
1	18-0937	OMC	315055	925	18-1074	OMC	3850426	936
1	18-0939	OMC	315189	928	18-1074	Volvo	3850426	1006
	18-0940	Mercury Marine	27-55308	439	18-1076	Volvo	3888916	1010
	18-0940	Mercury Marine	27-78027	439	18-1079	Yamaha	6GD-G4325-00-00	Obsolete
	18-0940	Mercury Marine	27-85488	439	18-1099	OMC	982422	942
	18-0940	Mercury Marine	27-854881	439	18-1100			70
	18-0940	Mercury Marine	27-854882	439	18-1105			70
	18-09400			232	18-1106			70
	18-0941	OMC	315538	331	18-1107			70
	18-0942	Mercury Marine	27-46110	439	18-1109			70
	18-0942	Mercury Marine	27-72486	439	18-1110			70
	18-0942	Mercury Marine	27-85491	439	18-1111	Mercury Marine	31-62799A1	450
	18-0942	Mercury Marine	27-854911	439	18-1112	Chrysler/Force	31-F523901	257
	18-0942	Mercury Marine	27-85491-2	439	18-1112	Mercury Marine	31-12576	450
	18-0942	Mercury Marine	27-854913	439	18-1113	Chrysler/Force	31-F523143	257
	18-0943-2	OMC	909786	917	18-1113	Mercury Marine	31-12578	450
1	18-0943-2	OMC	913783	917	18-1113	Mercury Marine	31-12578T	450
1	18-0943-2	OMC	3850496	917	18-1115	Mercury Marine	31-29982	450
	18-0943-2	Volvo	3850496	917	18-1115	Mercury Marine	31-32898	450
	18-0943-2-9	OMC	913783	926	18-1115	Mercury Marine	31-32898T	450
	18-0943-2-9	Volvo	3850496	988	18-1117	Mercury Marine	31-42647	450
	18-0944	Mercury Marine	27-64204	439	18-1117	Mercury Marine	31-42647A1	450, 861
	18-0944	Mercury Marine	27-72508	439	18-1117	Mercury Marine	31-F694057	450
	18-0944	Mercury Marine	27-85496	439	18-1117	OMC	387817	938
	18-0944	Mercury Marine	27-854961	439	18-1118	Mercury Marine	31-42677A1	450
	18-0945	OMC	323217	329	18-1120	Mercury Marine	31-35246	861
	18-0945	OMC	336430	329	18-1122	Mercury Marine	31-73363	450
	18-0946	Mercury Marine	27-85653	439	18-1122	Mercury Marine	31-73363T	450
	18-0946	Mercury Marine	27-85653-1	439	18-1126	Mercury Marine	31-54036A1	451
	18-0946	Mercury Marine	27-856730	439	18-1126	Mercury Marine	31-8M0103474	862
1	18-0947	OMC	909529	927	18-1127	Mercury Marine	31-54038A1	862
1	18-0948	Mercury Marine	27-87707	828	18-1129	Mercury Marine	31-86748A1	862
1	18-0949	OMC	316499	333	18-1129	Mercury Marine	31-8M0103473	862
	18-0950	Mercury Marine	27-88046	830	18-1129	Mercury Marine	31-F506818	862
	18-0951	OMC	317305	Obsolete	18-1129	Mercury Marine	F508814	862
1	18-0952	Mercury Marine	27-88907	441	18-1131	Mercury Marine	74313A4	813
1	18-0953	OMC	317951	3332	18-1137	Mercury Marine	15103A3	813
	18-0954	Mercury Marine	27-92720	827	18-1142	Mercury Marine	31-32573A1	861
	18-0955	OMC	318156	329	18-1143	Mercury Marine	31-36387A1	450, 861
	18-0956-1	Chrysler Inboard	118-614	605	18-1144	Mercury Marine	31-48939A2	Obsolete
	18-0956-1	Mercury Marine	27-68715	828	18-1148	Mercury Marine	23-853853	813
	18-0956-1	OMC	912405	926	18-1148	Mercury Marine	23-853853002	813
	18-0957	OMC	318373	330	18-1148	Mercury Marine	23-853853A1	813
	18-0958	Chrysler Force	27-F372154-1	253	18-1148	Mercury Marine	68704A1	813
1	18-0959	OMC	318924	328	18-1150	Mercury Marine	31-92366	Obsolete
1	18-0960	Chrysler Force	27-F85906	253	18-1150	Mercury Marine	31-92366A1	Obsolete
	18-09602			232	18-1151	Mercury Marine	30-20066	377
	18-09606			232	18-1152	Mercury Marine	30-23679	377
1	18-0961	OMC	318932	327	18-1153	Mercury Marine	30-20464	424, 450, 863
1	18-0963	OMC	335633	328	18-1153	Mercury Marine	30-49313	424, 450, 863
1	18-0965	OMC	333879	330	18-1153	Mercury Marine	30-54215	424, 450, 863
1	18-0967	OMC	319332	331	18-1153	Mercury Marine	30-63326	424, 450, 863
1	18-0969	OMC	319586	332	18-1153	Mercury Marine	30-63326T	424, 450, 863
1	18-0970	Mercury Marine	27-98769	438	18-1154	Mercury Marine	30-63742	424, 450
1	18-0970	Mercury Marine	27-987691	438	18-1154	Mercury Marine	30-63742T	450
	18-0971	OMC	319661	321, 331	18-1154	OMC	377139	938
1	18-0973	OMC	315052	329	18-1155	Mercury Marine	30-17927	450, 863
1	18-0975	OMC	333008	328	18-1155	Mercury Marine	30-35914	450, 863
1	18-0976	Crusader	20129	630	18-1155	Mercury Marine	30-88957	449, 450, 863
1	18-0976	Mercury Marine	27-14250	828	18-1155	Mercury Marine	30-88957A1	450, 863
1	18-0976	Mercury Marine	27-34895	828	18-1155	Mercury Marine	30-88957T	450, 863
1	18-0976	Mercury Marine	F1101297	828	18-1156	Honda	91051-ZW1-003	267
1	18-0977	OMC	332369	331	18-1156	Mercury Marine	31-30894A1	450, 862
1	18-0978	OMC	331598	328	18-1157	Honda	91057-ZW1-003	267
1	18-0979	OMC	321183	328	18-1157	Mercury Marine	31-30895	450, 862
	18-0980	Mercury Marine	110990	828	18-1157	Mercury Marine	31-30895T	450, 862
	18-0980	Mercury Marine	1100990	828	18-1158	Honda	91053-ZW1-003	267
	18-0980	Mercury Marine	27-49109	828	18-1158	Mercury Marine	31-30956	450, 863
	18-0980	Mercury Marine	27-54529	828	18-1158	Mercury Marine	31-30956T	450, 863
	18-0980	OMC	3935449	928	18-1158	Mercury Marine	31-F523058	450, 863
1	18-0981	OMC	321479	329	18-1158	OMC	387247	350, 938
	18-0982-1	Mercury Marine	27-48713	441	18-1159	Mercury Marine	31-35928A1	450
	18-0982-1	Mercury Marine	27-56304	441	18-1159	Mercury Marine	31-35928T1	450
1	18-0983	OMC	321497	328	18-1160	Mercury Marine	31-35988A12	863
	18-0985	OMC	321722	328	18-1160	Mercury Marine	31-35988A2	863
1	18-0987	OMC	332319	329	18-1161	Mercury Marine	31-35990A1	862
	18-0988	Mercury Marine	27-37976	441	18-1161	OMC	983891	350, 938
	18-0988	Mercury Marine	27-62860	441	18-1162	Mercury Marine	31-38356A1	451, 862
	18-0988	Mercury Marine	27-628601	441	18-1162	Mercury Marine	31-FB4901	451, 862
	18-0989	OMC	321794	328	18-1162	Mercury Marine	F84903	451, 862
1	18-0991	OMC	321907	329	18-1162	Mercury Marine	FAB4901	451, 862
	18-0993	OMC	437228	286	18-1163	Mercury Marine	31-48941A1	451, 862
1	18-0994	Mercury Marine	27-70143	826	18-1165	Mercury Marine	31-61100A1	862
1	18-0994	Mercury Marine	27-701431	826	18-1166	Mercury Marine	31-78172A1	453
1	18-0994	Mercury Marine	27-70143B1	826	18-1170	Mercury Marine	31-812767A1	453
1	18-0994	Mercury Marine	27-807982	826	18-1170	OMC	983892	938
1	18-0994	Mercury Marine	27-8079821	826	18-1171	OMC	983878	938
1	18-0994	Mercury Marine	27-807982B	826	18-1172	OMC	983877	938
1	18-0995	OMC	323222	330	18-1173	Mercury Marine	31-828437A2	862

1 This product is priced per piece. To order, priced per package, please add -9 to the part number

2 Items ending in "D" are display packaged - regular number is non-display

3 For discount shop pack of 10, please add -10 to the part number

SIERRA #	O.E.M.	O.E. #	PAGE #	SIERRA #	O.E.M.	O.E. #	PAGE #
SIERRA							
18-1175			70	18-1237	Mercury Marine	F11101281	823
18-1176			70	18-1237	OMC	3856138	923
18-1177			70	18-1237	Volvo	3856138	1003
18-1178			70	18-1238	Mercury Marine	27-824326	823
18-1179	Mercury Marine	31-32575A1	862	18-1238	OMC	912979	923
18-1179	Mercury Marine	31-32575T1	862	18-1238	OMC	3850379	923
18-1180	Mercury Marine	31-54042T	862	18-1238	Volvo	912979	1000
18-1182	Mercury Marine	31-30894A5	862	18-1238	Volvo	3850379	1000
18-1186	Mercury Marine	12-88263	Obsolete	18-1239	Mercury Marine	27-810846	823
18-1186	Mercury Marine	29-88258	Obsolete	18-1239	Mercury Marine	27-810846T	823
18-1190	Mercury Marine	30-20839	450	18-1239	OMC	914820	923
18-1190	Mercury Marine	30-20839T	450	18-1239	Volvo	3853343	1003
18-1190	Mercury Marine	30-62699	450	18-1240	Mercury Marine	12708	829
18-1190	Mercury Marine	F1000034	450	18-1241			327
18-1191	Mercury Marine	12-12577	450	18-1243	OMC	317245	306
18-1193	Mercury Marine	31-33136A1	862	18-1254	Mercuriser	27-75611A03	822
18-1194	Mercury Marine	879366	424	18-1255			672
18-1194	Mercury Marine	31-17514	424	18-1256			675
18-1194	Mercury Marine	31-17514A1	424	18-1257			675
18-1194	Mercury Marine	31-17514A2	424	18-1258			676
18-1194	Mercury Marine	31-67526	424	18-1259			676
18-1194	Mercury Marine	31-67526A1	424	18-1261			676
18-1194	Mercury Marine	31-67526A2	424	18-1263			674, 675
18-1194	Mercury Marine	31-814337A1	424	18-1264			672
18-1194	Mercury Marine	31-821146A1	424	18-1265			673
18-1194	Mercury Marine	31-8M0045428	424	18-1266			673, 674
18-1194	Mercury Marine	31-M8004528	424	18-1267			673, 674, 675
18-1195	Mercury Marine	31-43012A1	Obsolete	18-1268			Obsolete
18-1196	Mercury Marine	31-74248	424	18-1270			672
18-1196	Mercury Marine	31-74248T	424	18-1271			671
18-1197	Mercury Marine	31-828439A2	450, 862	18-1273			677
18-1199			70	18-1274			671
18-1199			70	18-1275			672
18-1202	OMC	329830	331	18-1276			671
18-1204-1	Mercury Marine	27-96429	791, 800, 828	18-1277			671
18-1204-1	OMC	912164	927	18-1278			672
18-1204-1-9	Mercury Marine	27-96429	791, 800, 828	18-1279	OMC	317624	932
18-1204-1-9	OMC	912164	927	18-1282	OMC	398602	32, 277
18-1205	OMC	329828	330	18-1283	OMC	335818	330
18-1206			671	18-1284	OMC	335819	330
18-1207	OMC	329833	329	18-1285	OMC	335403	330
18-1207	OMC	343863	329	18-1286	OMC	336232	318
18-1210-1	Mercury Marine	27-39923	800, 827	18-1287	OMC	392475	354
18-1211	Mercury Marine	26-49947	818	18-1288	OMC	328313	354
18-1211	Mercury Marine	26-58203	818	18-1289	OMC	327655	355
18-1211	Mercury Marine	26-814622	818	18-1290	OMC	337020	356
18-1211	Mercury Marine	F1110026	818	18-1291			356
18-1211	Mercury Marine	F1110027	818	18-1292			356
18-1211	Mercury Marine	F1110041	818	18-1293			356
18-1211	OMC	473424	922	18-1294	Sea-Doo	278-002-199	32
18-1211			998	18-1299	OMC	433503	350
18-1212	OMC	326926	329	18-1300	Mercury Marine	23-15960	Obsolete
18-1213	Mercuriser	26-11973	818	18-1300	Mercury Marine	23-52211	Obsolete
18-1213	Mercuriser	26-42750	818	18-1300	Mercury Marine	23-818465	Obsolete
18-1213	Mercuriser	26-54799	818	18-1300	Mercury Marine	23-85698	Obsolete
18-1213	Mercuriser	26-97335	818	18-1300	Mercury Marine	F724073	Obsolete
18-1213	OMC	912989	922	18-1300			Obsolete
18-1213	OMC	914817	922	18-1305	Mercury Marine	23-85684	813
18-1213	OMC	3853341	922	18-1308	Mercury Marine	23-15961	813
18-1213	Volvo	3853341	998	18-1308	Mercury Marine	23-52221	813
18-1218	OMC	315868	329	18-1308	Mercury Marine	23-52270	813
18-1219	OMC	320880	333	18-1308	Mercury Marine	23-85701	813
18-1221	OMC	330273	333	18-1308	Mercury Marine	F3910555	813
18-1222	OMC	394408	307	18-1308	Mercury Marine	F3916351	813
18-1224	OMC	315869	329	18-1308	Mercury Marine	F11100305	813
18-1230	Mercury Marine	26-56866	818	18-1308	Mercury Marine	F11100570	813
18-1230	OMC	3853827	922	18-1308			912, 998
18-1230	Volvo	3853827	998	18-1309	Mercury Marine	23-1596110	813
18-1231	Mercury Marine	27-818188	823	18-1309	Mercury Marine	23-52224	813
18-1231	Mercury Marine	27-8181881	823	18-1309	Mercury Marine	23-52273	813
18-1231	OMC	3854095	923	18-1309	Mercury Marine	23-85704	813
18-1231	Volvo	3854095	1002	18-1309	Mercury Marine	F11100381	813
18-1232	Mercury Marine	27-845628	823	18-1309	Mercury Marine	F11100573	813
18-1232	Mercury Marine	27-811566	823	18-1309			922, 998
18-1232	OMC	3853510	923	18-1311	Mercury Marine	23-801793	813
18-1232	Volvo	3853510	1003	18-1311			922, 998
18-1233	Mercury Marine	26-49154	818	18-1316	Mercury Marine	23-52264	Obsolete
18-1233	Mercury Marine	26-821947	818	18-1316	Mercury Marine	23-818471	Obsolete
18-1233	Mercury Marine	26-8219471	818	18-1316	Mercury Marine	23-818471001	Obsolete
18-1233	Mercury Marine	F11100986	818	18-1316	Mercury Marine	23-85718	Obsolete
18-1233	OMC	3860095	922	18-1316	Mercury Marine	F3829064	Obsolete
18-1234	Mercury Marine	24-17057A1	818	18-1316	Mercury Marine	F11100853	Obsolete
18-1234	Mercury Marine	24-801879	818	18-1317	Mercury Marine	23-34464	813
18-1234	Mercury Marine	24-801879T	818	18-1317	Mercury Marine	23-52261	813
18-1234	Mercury Marine	24-811554	818	18-1317	Mercury Marine	23-818469	813
18-1234	OMC	3853528	922	18-1317	Mercury Marine	23-818469001	813
18-1234	Volvo	3853528	998	18-1317	Mercury Marine	23-85669	813
18-1236	OMC	309243	346, 929	18-1317	Mercury Marine	23-85715	813
18-1237	Mercury Marine	27-13865	823	18-1317			922, 998
18-1237	Mercury Marine	27-138651	823	18-1320	Mercury Marine	23-801803	813

1 This product is priced per piece. To order, priced per package, please add -9 to the part number

2 Items ending in "D" are display packaged - regular number is non-display

3 For discount shop pack of 10, please add -10 to the part number

SIERRA #	O.E.M.	O.E. #	PAGE #	SIERRA #	O.E.M.	O.E. #	PAGE #
SIERRA							
18-1327	Mercury Marine	23-11992	813	18-1402	Mercury Marine	F1100399	809
18-1327	Mercury Marine	23-11992001	813	18-1402	Mercury Marine	F1100862	809
18-1327			922, 998	18-1402	Mercury Marine	F1100954	809
18-1329	Mercury Marine	23-48351	813	18-1402	Mercury Marine	F1101222	809
18-1329	Mercury Marine	23-52242	813	18-1402	OMC	502036	921
18-1329	Mercury Marine	23-85677	813	18-1402	OMC	3854033	921
18-1333	Mercury Marine	23-49171	813	18-1402	Volvo	502036	997
18-1333	Mercury Marine	23-69887	813	18-1402	Volvo	3854033	997
18-1333	Mercury Marine	23-85691	813	18-1410	Yamaha	93310-32337-00	534
18-1333			922, 998	18-1411	Yamaha	93310-620V5-00	534
18-1334	Mercury Marine	23-49168	813	18-1412	Suzuki	09263-20051	486
18-1334	Mercury Marine	23-69884	813	18-1414	Suzuki	09263-14022	486
18-1334	Mercury Marine	23-85726	813	18-1415	Suzuki	09263-18016	486
18-1334	Mercury Marine	23-85726001	813	18-1416	Suzuki	09263-27005	486
18-1334	Mercury Marine	F1100980	813	18-1417	Suzuki	09263-20072	486
18-1334			922, 998	18-1476			994
18-1337	Mercury Marine	23-811858	813	18-1477			994
18-1337	Mercury Marine	23-811858001	813	18-1478	Volvo	1218674	994
18-1337			922, 998	18-1479	Volvo	461511	994
18-1339	Mercury Marine	23-43293	Obsolete	18-1500	OMC	337778	355, 942
18-1339	Mercury Marine	23-43293T	Obsolete	18-1501	OMC	160084	939
18-1339	Mercury Marine	F3750884	Obsolete	18-1501	Volvo	3852023	1008
18-1339	Mercury Marine	F1101007	Obsolete	18-1505	OMC	318940	334
18-1339			Obsolete	18-1506	OMC	394411	307
18-1340	Mercury Marine	23-67484	813	18-15061	Honda	31200-ZW1-004	259
18-1341	Mercury Marine	23-1596120	813	18-1507	OMC	335981	307
18-1341	Mercury Marine	23-52225	813	18-1508	Mercury Marine	25-8071341	759
18-1341	Mercury Marine	23-52274	813	18-15080	Polaris	3240120	570
18-1341	Mercury Marine	23-85705	813	18-15080	Yamaha	6M6-8183E00-00	570
18-1341	Mercury Marine	F1100382	813	18-15100	Mercury Marine	57-862087A1	780
18-1341			922, 998	18-15100	Mercury Marine	57-862907	780
18-1343	OMC	333957	355, 942	18-15100	Mercury Marine	57-8638763	780
18-1344			350, 355	18-15100	Mercury Marine	57-865615003	780
18-1345	Mercury Marine	30-41421	424	18-15100	Mercury Marine	57-865615Q03	780
18-1345	Mercury Marine	30-67923	424	18-15101	Mercury Marine	57-862086	780
18-1345	Mercury Marine	30-67923T	424	18-15101	Mercury Marine	57-8620861	780
18-1346	Mercury Marine	30-43011	425	18-15101	Mercury Marine	57-862086A1	780
18-1346	Mercury Marine	30-43011T	425	18-15101	Mercury Marine	57-8638764	780
18-1347	Mercury Marine	31-88269T	450	18-15101	Mercury Marine	57-865615004	780
18-1350	OMC	379504	350, 938	18-15101	Mercury Marine	57-865615Q04	780
18-1351	OMC	382407	350, 938	18-15102	Mercury Marine	57-8610491	780
18-1353	OMC	387041	313	18-15102	Mercury Marine	57-8638766	780
18-1354	OMC	386764	350	18-15102	Mercury Marine	57-865615006	780
18-1355	OMC	386765	350	18-15102	Mercury Marine	57-865615Q06	780
18-1356	Mercury Marine	31-54928	861	18-15103	Mercury Marine	57-861050	780
18-1356	OMC	382343	350	18-15103	Mercury Marine	57-8638767	780
18-1357	OMC	384195	350	18-15103	Mercury Marine	57-865615Q07	780
18-1358	OMC	389039	938	18-15103	Mercury Marine	57-865615Q07	780
18-1360	OMC	396041	313	18-15104	Mercury Marine	57-862089	780
18-1361	OMC	387787	313	18-15104	Mercury Marine	57-862089A1	780
18-1363	OMC	397537	350	18-15104	Mercury Marine	57-8638768	780
18-1364	OMC	397538	350	18-15104	Mercury Marine	57-865615008	780
18-1365	OMC	387656	350, 938	18-15104	Mercury Marine	57-865615Q08	780
18-1366	OMC	382408	350, 938	18-15105	Mercury Marine	57-862088	Obsolete
18-1367	OMC	385068	350	18-15105	Mercury Marine	57-862088A1	Obsolete
18-1368	OMC	398901	350	18-15105	Mercury Marine	57-8638769	Obsolete
18-1369	OMC	432264	350	18-15105	Mercury Marine	57-865615009	Obsolete
18-1370	OMC	389042	350, 938	18-15105	Mercury Marine	57-865615Q09	Obsolete
18-1371	OMC	385043	350, 938	18-15106	Yamaha	YSC-13260-60-0C	Obsolete
18-1374	OMC	395627	313	18-15109	Yamaha	YSC-22260-00-0C	1013
18-1376	OMC	434844	313	18-15110	Yamaha	YSC-10260-10-0C	Obsolete
18-1377	OMC	320499	313	18-15111	Yamaha	YSC-10260-00-0C	1013
18-1378	OMC	388344	313	18-15112	Mercury Marine	57-8077554	780
18-1386			314	18-15112	Mercury Marine	57-807755Q04	780
18-1389			314	18-15113	Mercury Marine	57-8077555	780
18-1391	OMC	330854	314	18-15114	Mercury Marine	57-861049	780
18-1393	OMC	393896	Obsolete	18-15114	Mercury Marine	57-861049Q	780
18-1395	OMC	385503	314	18-15115	Mercury Marine	57-861757	780
18-1396	OMC	390641	Obsolete	18-15115	Mercury Marine	57-861757Q	780
18-1398	Mercury Marine	30-20861	425	18-15116	Mercury Marine	57-861758	780
18-1398	Mercury Marine	30-72961	425	18-15116	Mercury Marine	57-861758Q	780
18-1400	Mercury Marine	17340	Obsolete	18-15117	Mercury Marine	57-861759	Obsolete
18-1400	Mercury Marine	17340T	809	18-15119	Mercury Marine	57-8623523	780
18-1400	OMC	3856127	921	18-15119	Mercury Marine	57-8638761	780
18-1400	Volvo	3856127	997	18-15119	Mercury Marine	57-865615001	780
18-1401	Mercury Marine	56153	809	18-15119	Mercury Marine	57-865615Q01	780
18-1401	Mercury Marine	F724102	809	18-15121	Mercury Marine	57-8638765	780
18-1401	OMC	985316	921	18-15121	Mercury Marine	57-865423005	780
18-1401	OMC	3853847	921	18-15121	Mercury Marine	57-865615005	780
18-1401	Volvo	985316	997	18-15121	Mercury Marine	57-865615Q05	780
18-1401	Volvo	3853847	997	18-15122	Mercury Marine	57-86387610	Obsolete
18-1402	Mercury Marine	34282	809	18-15122	Mercury Marine	57-865615010	Obsolete
18-1402	Mercury Marine	35583	809	18-15123	Mercury Marine	57-864639	780
18-1402	Mercury Marine	46472	809	18-15124	Mercury Marine	57-881754	Obsolete
18-1402	Mercury Marine	46744	809	18-15125	Mercury Marine	57-817113	Obsolete
18-1402	Mercury Marine	49117	809	18-15128	Mercury Marine	57-880568014	390
18-1402	Mercury Marine	72638	809	18-15129	Mercury Marine	17-828507 1	390
18-1402	Mercury Marine	F2769931	809	18-15130	Yamaha	6C5-46241-00-00	536
18-1402	Mercury Marine	F5232670	809	18-15131	Yamaha	67F-46241-00-00	536
18-1402	Mercury Marine	F1100349	809	18-15132	Yamaha	6P2-46241-02-00	536

1 This product is priced per piece. To order, priced per package, please add -9 to the part number

2 Items ending in "D" are display packaged - regular number is non-display

3 For discount shop pack of 10, please add -10 to the part number

SIERRA #	O.E.M.	O.E. #	PAGE #	SIERRA #	O.E.M.	O.E. #	PAGE #
SIERRA							
18-15133	Yamaha	6G8-46241-00-00	536	18-15460	Mercury Marine	57-48120A1	774
18-15134	Yamaha	6CB-W4624-00-00	536	18-15460	Mercury Marine	57-48120Q1	774
18-15135	Yamaha	65W-46241-00-00	536	18-15460	OMC	310953	911
18-15136	Yamaha	6AH-46241-00-00	536	18-15460	OMC	909971	911
18-15137	Yamaha	66M-46241-00-00	536	18-15460	Volvo	829207	984
18-15138	Yamaha	68T-46241-00-00	536	18-15460	Volvo	950818	984
18-15139	Yamaha	6AW-W4624-00-00	536	18-15470	Mercury Marine	57-78200	774
18-15140	Yamaha	63P-46241-00-00	536	18-15470	Mercury Marine	57-78200A1	774
18-15141	Yamaha	69J-46241-00-00	536	18-15470	Mercury Marine	57-78200Q1	774
18-15142	Yamaha	6DA-W4624-00-00	536	18-15470			911, 984
18-15143	Yamaha	60V-46241-00-00	536	18-15480	Mercury Marine	57-48122	774
18-15144	Yamaha	62Y-46241-00-00	536	18-15480	Mercury Marine	57-48122Q	774
18-15145	Yamaha	68F-46241-10-00	536	18-15480			911, 984
18-15146	Mercury Marine	8M0072670	429	18-15490	Mercury Marine	57-816295Q	774
18-15147	Mercury Marine	835392Q	429	18-15490	Mercury Marine	57-816295T	774
18-15148	Mercury Marine	8M0065179	429	18-15495	Mercury Marine	57-91035	774
18-15149	Mercury Marine	57-895120	429	18-15495	Mercury Marine	57-91035A1	774
18-15150	Mercury Marine	57-895120002	429	18-15495	Mercury Marine	57-91035Q1	774
18-1522	Yamaha	63P-81950-00	500	18-15495	Volvo	958320	984
18-1523	Yamaha	61A-81950-01	500	18-15495			911
18-1524	Yamaha	6H1-81950-01-00	500	18-1550	Mercury Marine	43-881260A3	454
18-1525	Yamaha	60E-81950-00-00	500	18-15500	Mercury Marine	57-96834Q	774
18-15214	Crusader	R130012	615	18-15500	Mercury Marine	57-96834T	774
18-15214	Pleasurecraft	R130012	644	18-15500	OMC	909818	911
18-15290	Mercury Marine	57-13457	774	18-15500	OMC	912418	911
18-15290	Mercury Marine	57-13457Q	774	18-15500	Volvo	952141	984
18-15290	Mercury Marine	57-13457T	774	18-15501	Mercury	88-93582	720
18-15290	Mercury Marine	57-53215	774	18-1551	Mercury Marine	43-803615T2	454, 454
18-15290	Mercury Marine	57-53215T	774	18-15520	Mercury Marine	57-33170	774
18-15300	Mercury Marine	57-49756	774	18-15520	Mercury Marine	57-33170Q	774
18-15300	Mercury Marine		911, 984	18-15520	Mercury Marine	57-37619T	774
18-15325	Mercury Marine	57-77274A1	774	18-15520	OMC	912714	911
18-15325	Volvo	958303	984	18-15520			984
18-15325			911	18-15550	Mercury Marine	57-13458	774
18-15345	Mercury Marine	57-74271	774	18-15550	Mercury Marine	57-13458Q	774
18-15345	Mercury Marine	57-74271Q	774	18-15550	Mercury Marine	57-13458T	774
18-15345	Mercury Marine	57-74271T	774	18-15550	Mercury Marine	57-96834	774
18-15345	Mercury Marine	57-77274	774	18-15550			911
18-15345	Mercury Marine		911, 984	18-1560	Mercury Marine	43-850036	454
18-15370	Mercury Marine	57-65607	774	18-1560	Mercury Marine	43-850036T	454, 454
18-15370	Mercury Marine	57-65607Q	774	18-1562	Mercury Marine	52-850048T	Obsolete
18-15370	Mercury Marine	57-65607T	774	18-1562	Mercury Marine	53-850048	Obsolete
18-15370	Mercury Marine		911, 984	18-1564	Mercury Marine	43-803615T1	454
18-15380	OMC	910414	911	18-1564	Mercury Marine	43-803615T2	454, 454
18-15380			774, 911, 984	18-1565	Mercury Marine	52-859340T	454, 455
18-15390	Mercury Marine	57-52692	776	18-1566	Mercury Marine	43-828175A1	454, 455
18-15390	Volvo	958310	984	18-1567	Mercury Marine	43567A1	Obsolete
18-15390			776	18-1567	Mercury Marine	43567T1	Obsolete
18-15400	Mercury Marine	57-32850	776	18-1567	Mercury Marine	96184A1	Obsolete
18-15400	Mercury Marine	57-69143Q	774	18-1596	Johnson/Evinrude	328725	303
18-15400	Mercury Marine	57-69143T	774	18-1597	Johnson/Evinrude	302325	302, 303
18-15400	OMC	311606	911	18-1598	OMC	341013	931, 932
18-15400			984	18-1599	OMC	123018	931, 932
18-15405	Mercury Marine	57-76269	774	18-1600	OMC	983825	931, 931, 940
18-15405	Mercury Marine	57-76269Q	774	18-1601	OMC	983826	931, 931, 940
18-15405	Volvo	958311	984	18-1602	OMC	984012	Obsolete
18-15405			911	18-1650	Universal		163
18-15410	Mercury Marine	57-32850	774	18-1651	Universal		163
18-15410	Mercury Marine	57-49043	774	18-1652	Universal		163
18-15410	Mercury Marine	57-49043A1	774	18-1653	Universal		163
18-15410	Mercury Marine	57-64032	774	18-1654	Universal		163
18-15410	Mercury Marine	57-64032A1	774	18-1655	Universal		163
18-15410	Mercury Marine	57-64032Q1	774	18-1656	Universal		163
18-15410	Mercury Marine	57-816544	774	18-1701	OMC	911693	939
18-15410	Volvo	950813	984	18-1702	OMC	438039	941
18-15410			911	18-1702	OMC	5000074	941
18-15415	Mercury Marine	57-36356	774	18-1703	OMC	434400	941
18-15415	OMC	910343	911	18-1703	OMC	435096	941
18-15415	Volvo	958357	984	18-1703	OMC	438040	941
18-15430	Mercury Marine	57-49211	774	18-1703	OMC	5000363	941
18-15430	Mercury Marine	57-64416	774	18-1703	OMC	5004257	941
18-15430	Volvo	841821	984	18-1704	OMC	331980	334, 929
18-15430			911	18-1705	Mercury Marine	65547	849
18-15435	Mercury Marine	57-49211	774	18-1705	Mercury Marine	77123	849
18-15435	Mercury Marine	57-64416	774	18-1705	Mercury Marine	77123A1	849
18-15435	OMC	912509	911	18-1706	Mercury Marine	10-86801	849
18-15435	Volvo	958314	984	18-1710	Mercury Marine	86814	852
18-15435	Volvo	966382	984	18-1710	Mercury Marine	862209	852
18-15440	Mercury Marine	57-45856	774	18-1711	Mercury Marine	862132	848
18-15440	Mercury Marine	57-49213A1	774	18-1711	Mercury Marine	862132T	848
18-15440	OMC	311046	911	18-1712	OMC	980014	355
18-15440			984	18-1713	OMC	3852563	931, 932
18-15450	OMC	914787	911	18-1714	OMC	313448	942
18-15450	Volvo	3858462	984	18-1718			Obsolete
18-15450			774	18-1721	OMC	433067	339, 352
18-15455	OMC	908929	911	18-1722	OMC	438399	352
18-15455	Volvo	3852464	984	18-1723	OMC	346004	352
18-15455			774	18-1725	OMC	436834	353, 356
18-15460	Mercury Marine	57-48120	774	18-1727	Volvo	803762	995
				18-1728	Mercury Marine	816607	852

1 This product is priced per piece. To order, priced per package, please add -9 to the part number
 2 Items ending in "D" are display packaged - regular number is non-display
 3 For discount shop pack of 10, please add -10 to the part number

SIERRA #	O.E.M.	O.E. #	PAGE #	SIERRA #	O.E.M.	O.E. #	PAGE #
SIERRA							
18-1729	OMC	434588	Obsolete	18-1909-1	Volvo	3863061	988
18-1730	Mercury Marine	43585	411	18-1909-1	Volvo	3863061	988
18-17301	Yamaha	6J8-81960-00-00	Obsolete	18-1909-1	Volvo	3855270-9	916, 988
18-1734	OMC	334742	307	18-1909-1	Volvo	3855270-9	916, 988
18-1736	Mercury Marine	45-43031A1	454	18-1910	Mercury Marine	47587	759
18-1737	Mercury Marine	45-440001	454	18-1910	Mercury Marine	47588	759
18-1750			350, 938	18-1910	Mercury Marine	47587A2	759
18-1752	OMC	394462	313	18-1910	Mercury Marine	60372A1	759
18-1753	OMC	395861	313	18-1910	Mercury Marine	60372A2	759
18-1755	Yamaha	650-11651-04-00	534	18-1910	Mercury Marine	63908A2	759
18-1755K	Yamaha	650-11651-04-00	534	18-1910	Mercury Marine	861493A07	759
18-1756	Yamaha	688-11650-03-00	534	18-1910	Mercury Marine	861493A3	759
18-1757	Suzuki	12161-93902	486	18-1911			605
18-17570			984	18-1913	Chrysler Inboard	2469556	605
18-1757K	Suzuki	12161-93902	486	18-1913	Chrysler Inboard	2469639	605
18-1758	Suzuki	12161-91L00	486	18-1913	Chrysler Inboard	2847405	605
18-1758	Suzuki	12161-96300	486	18-1916	Crusader	97169	626
18-1759	Suzuki	12161-92L00	486	18-1917	Crusader	97296	629
18-1759	Suzuki	12161-94400	486	18-1918	Crusader	97366	626
18-1759K	Suzuki	12161-94400	486	18-1919	Crusader	97387	626
18-1800	Mercury Marine	12886A6	429	18-1921	OMC	909863	916
18-18000	Mercury Marine	57-892318	390	18-1922	OMC	98778A	916
18-18100	Mercury Marine	57-828507Q4	390	18-1922	OMC	916096	916
18-1820	Honda	91251-ZW1-B04	263	18-1922	OMC	740120	916
18-1821	Johnson/Evinrude	353690	303	18-1922	OMC	3850799	916
18-1822	Johnson/Evinrude	354580	302	18-1922	OMC	910380	916
18-1823	Johnson/Evinrude	5007770	302	18-1924	Crusader	97624	626
18-1824	Johnson/Evinrude	349354	302	18-1925	Crusader	96120	625
18-1825	Johnson/Evinrude	340811	303	18-1925	Crusader	97752	625
18-1826	Johnson/Evinrude	338601	302	18-1926	Crusader	96121	625
18-1827	Johnson/Evinrude	321129	303	18-1926	Crusader	97753	625
18-1828	Yamaha	663-44366-00	515	18-1927	Crusader	97772	626
18-1829	Yamaha	6AW-44365-00-00	515	18-1928	Crusader	97924	626
18-1830	Yamaha	663-44366-00	516	18-1929	Crusader	97114	625
18-18303	Suzuki	38100-92J02	480	18-1929	Crusader	97992	625
18-18303	Suzuki	38100-92J10	480	18-1930-2	Volvo	855387	987
18-18303	Suzuki	38100-93J01	480	18-1930-2	Volvo	834438-4	987
18-18303	Suzuki	38100-93J02	480	18-1931-1	Volvo	835804	987
18-18303	Suzuki	38100-96J00	480	18-1931-1	Volvo	856883	987
18-18304	Suzuki	37100-87J00-OEP	480	18-1932	Volvo	856894	987
18-18304	Suzuki	38100-87J0EP	480	18-1933	Crusader	97115	625
18-1831	Yamaha	682-44366-00	516	18-1933	Crusader	97993	625
18-1832	Yamaha	682-44367-00	516	18-1934	Crusader	98068	626
18-1833	Yamaha	647-44366-00	516	18-1935-1	Volvo	856891	988
18-1834	Yamaha	682-44365-00	516	18-1935-1	Volvo	855384-4	988
18-1835	Yamaha	6E5-44365-00-00	516	18-1936	Volvo	857037	987, 989
18-1836	Yamaha	6L2-44367-00	515, 522	18-19360			989
18-1837	Yamaha	6L2-44367-10	515, 523	18-1937	Mercury Marine	98562A6	797
18-1838	Mercury	43023	411, 416	18-1938	Crusader	98126	624
18-1839	Mercury	8235471	411, 416	18-1938	Crusader	RO29015	624
18-1840	Yamaha	6EE-G4366-00	515, 522, 523	18-1939	Barr	20-0100	587, 604, 627, 660, 797, 916, 988
18-1842	Mercury	864612T01	796				
18-1843	Mercuriser	864308T01	796	18-1939	Marine Power	0992-593	587, 604, 627, 660, 797, 916, 988
18-1843	Mercuriser	865049T01	796				
18-1843	Mercuriser	865735A02	796	18-1940	Barr	CM-1-6677A	604
18-1845	Mercuriser	864591T02	797	18-1940	Chrysler Inboard	3675826	604
18-1848	OMC	3852338	916	18-1940	Chrysler Inboard	4142322	604
18-1848	OMC	3857656	916	18-1941	Barr	CM-1-6672-B	605
18-1848	OMC	914899	916	18-1941	Chrysler Inboard	2846106	605
18-1848	Volvo	3857656	987	18-1942	Barr	CM-1-6672-H	605
18-1876	OMC	980617	988	18-1942	Chrysler Inboard	3675826	605
18-1898	Barr	CHVA-1-84	587, 604, 625, 660, 794, 915, 987, 988	18-1942	Chrysler Inboard	24695566	605
18-1898	Marine Power	0991-110	587, 604, 625, 660, 794, 915, 987, 988	18-1944	Barr	CM-20-414211	604
18-1899	Pleasurecraft	RO29001	648	18-1944	Chrysler Inboard	2847404	604
18-1901	OMC	984054	915	18-1944	Chrysler Inboard	2847623	604
18-1902	OMC	912441	915	18-1944	Chrysler Inboard	3745639	604
18-1903	OMC	912442	915	18-1944	Chrysler Inboard	E9923M	604
18-1904	OMC	980959	915	18-1945	Barr	CM-20-6674	604
18-1905	Mercury Marine	90880	797	18-1945	Chrysler Inboard	2846689	604
18-1906	Mercury Marine	61851	797	18-1946	Barr	CM-20-6672	604
18-1907	Barr	20-0100	660	18-1946	Chrysler Inboard	3527794	604
18-1907	Barr	20-0102	587, 604, 627, 916, 988, 988	18-1948	Barr	CM-20-9234	605
18-1907	Indmar	53-2009	587, 604, 627, 660, 797, 988, 988	18-1948	Chrysler Inboard	E9234M	605
18-1907	Indmar	53-2018	587, 604, 627, 660, 797, 988, 988	18-1949	Barr	CM-20-0097	587, 627, 660, 797, 988
18-1908	Mercury Marine	93320	797	18-1950-1	Barr	MC-1-77234	794
18-1908K	Mercury Marine	807476A6	797	18-1950-1	Mercury Marine	77234A2	794
18-1908K	Mercury Marine	93320A13	797	18-1950-1	Mercury Marine	77234A7	794
18-1908K	Mercury Marine	93320A2	797	18-1951-1	Barr	MC-1-77235	794
18-1908K	Mercury Marine	93320A3	797	18-1951-1	Mercury Marine	77235A2	794
18-1908K	Mercury Marine	93320A5	797	18-1951-1	Mercury Marine	77235A8	794
18-1908K	Mercury Marine	93320A6	797	18-1952-1	Barr	MC-1-99746	794
18-1909-1	OMC	913784	916	18-1952-1	Mercury Marine	99746A17	794
18-1909-1	OMC	3850456	916	18-1952-1	Mercury Marine	99746A8	794
18-1909-1	OMC	3855270	916	18-1952-2	Mercury Marine	860246Q11	794
18-1909-1	OMC	3857944	916	18-1954-1	Mercury Marine	MC 1 95862	794
18-1909-1	OMC	3856444	916	18-1954-1	Mercury Marine	95862A5	794
				18-1955-1	Barr	MC 1 96705	795
				18-1955-1	Mercury Marine	52390A1	795
				18-1955-1	Mercury Marine	96705A1	795

1 This product is priced per piece. To order, priced per package, please add -9 to the part number

2 Items ending in "D" are display packaged - regular number is non-display

3 For discount shop pack of 10, please add -10 to the part number

SIERRA #	O.E.M.	O.E. #	PAGE #	SIERRA #	O.E.M.	O.E. #	PAGE #
SIERRA							
18-1956-3	Barr	MC 1 99798	795	18-1990	Mercury Marine	54870	798
18-1956-3	Mercury Marine	806867A 8	795	18-1990	Mercury Marine	73813	798
18-1956-3	Mercury Marine	860235A04	795	18-1990	Mercury Marine	73813A1	798
18-1956-3	Mercury Marine	99798A16	795	18-1990	Mercury Marine	73813F1	798
18-1956-3	Mercury Marine	99798A18	795	18-1991	Barr	200089P	587, 626, 648, 796, 916, 988
18-1956-3	Mercury Marine	99798A3	795	18-1992-1	Barr	200087P	587, 626, 648, 796, 916, 988
18-1956-3	Mercury Marine	99798A9	795	18-1993	Mercury Marine	59861A1	Obsolete
18-1957-2	Mercury Marine	807078T08	795	18-1993	Mercury Marine	59861A4	Obsolete
18-1957-2	Mercury Marine	807078Q07	795	18-1993	Mercury Marine	78459A1	Obsolete
18-1958-1	Mercury Marine	54100A1	795	18-1993	Mercury Marine	78984A08	Obsolete
18-1958-1	Mercury Marine	54100A5	795	18-1993	Mercury Marine	78984A1	Obsolete
18-1958-1	Barr	MC-1-65604	795	18-1994	Mercury Marine	87290A4	759
18-1958-1	Mercury Marine	65604A12	795	18-1995	Mercury Marine	47638	798
18-1958-1	Mercury Marine	65604A4	795	18-1995	Mercury Marine	47638A1	798
18-1960-1	Mercury Marine	58759A13	795	18-1996	Barr	FM-1-83	648
18-1960-1	Mercury Marine	58759A1	795	18-1996	Pleasurecraft	RO28001	648
18-1960-1	Mercury Marine	52969A1	795	18-1997-1	Barr	CHV-1-83	587, 604, 625, 648, 660, 794, 915, 987
18-1960-1	Mercury Marine	52073A1	795	18-1998-1	Barr	FM-1-83	587, 625, 648, 660, 794, 915
18-1960-1	Barr	MC 1 58759	795	18-1999	Barr	20-0082	587, 625, 648, 660, 796, 916, 988
18-1960-1	Mercury Marine	58759A10	795	18-2000	OMC	309889	365, 949
18-1960-1	Mercury Marine	58759A14	795	18-2001	OMC	330137	365, 949
18-1962-1	Barr	MC-1-65603	795	18-2002	Honda	91252-ZW1-003	268
18-1962-1	Mercury Marine	54099A5	795	18-2002	Mercury Marine	26-30550	464
18-1962-1	Mercury Marine	54099A1	795	18-2002	Mercury Marine	26-70019	875
18-1962-1	Mercury Marine	65603A12	795	18-2002	Mercury Marine	26-76868	464, 875
18-1962-1	Mercury Marine	65603A4	795	18-2002	OMC	320862	365, 875
18-1962-1	Barr	CHV-1-83	657	18-2003	Mercury Marine	26-32080	872
18-1966-1	Mercury	806867A12	796	18-2003	Mercury Marine	26-36054	872
18-1966-1	Mercury	806867A2	796	18-2003	Mercury Marine	26-823894	875
18-1966-1	Mercury	806867A3	796	18-2004	Mercury Marine	26-20070	464, 875
18-1966-1	Mercury	806867A8	796	18-2005	Jabco	92700-0060	574
18-1966-1	Mercury	806867A9	796	18-2005	OMC	313284	365, 875
18-1966-1	Mercury	816329A3	796	18-2006	Mercury Marine	26-897154	464, 875
18-1966-1	Mercury	860235A03	796	18-2007	Mercury Marine	26-30727	875
18-1966-1	Mercury	99798A18	796	18-2007	Mercury Marine	26-31489	875
18-1970-2	Mercury Marine	95755A2	796	18-2007	Mercury Marine	26-94038	875
18-1970-2	Mercury Marine	98503A2	796	18-2008	Mercury Marine	26-56788	464, 872
18-1970-2	Mercury Marine	98504A3	796	18-2009	Mercury Marine	26-25776	875
18-1970-2	Barr	MC-20-98504	796	18-2009	Mercury Marine	26-31249	875
18-1971	Mercury Marine	49964A1	796	18-2009	Mercury Marine	26-46021	875
18-1971	Mercury Marine	49964A2	796	18-2009	Mercury Marine	26-892361	875
18-1971	Mercury Marine	60426A1	796	18-2010	Mercury Marine	26-897153	464, 875
18-1971	Mercury Marine	76351A04	796	18-2011	Mercury Marine	26-23300	875
18-1971	Mercury Marine	76351A1	796	18-2011	Mercury Marine	26-29595	875
18-1971	Mercury Marine	76351A2	796	18-2011	Mercury Marine	26-90562	875
18-1972	Barr	MC-20-76325	796	18-2012	OMC	310599	365, 875
18-1972	Mercury Marine	12076A2	796	18-2013	Mercury Marine	802276	875
18-1972	Mercury Marine	76325A2	796	18-2013	Mercury Marine	26-16977	875
18-1973	Barr	MC-20-55538	796	18-2013	Mercury Marine	26-20465	875
18-1973	Mercury Marine	39920	796	18-2013	Mercury Marine	26-31507	875
18-1973	Mercury Marine	39920A1	796	18-2013	Mercury Marine	26-79884	875
18-1973	Mercury Marine	55538A2	796	18-2014	Mercury Marine	26-33144	875
18-1974-1	Barr	MC-20-98502	797	18-2014	Mercury Marine	26-77634	875
18-1974-1	Mercury Marine	98502A2	797	18-2014	Mercury Marine	26-89238	875
18-1975-1	Mercury Marine	12076A1	797	18-2014	Mercury Marine	26-F694305	875
18-1975-1	Mercury Marine	12076A2	797	18-2015	Mercury Marine	20250	875
18-1975-1	Mercury Marine	95864A2	797	18-2015	Mercury Marine	26-23517	875
18-1976-2	Barr	MC-20-44354	797	18-2016	Mercury Marine	26-20079	875
18-1976-2	Mercury Marine	44354A10	797	18-2016	Mercury Marine	26-25837	875
18-1976-2	Mercury Marine	44354A13	797	18-2016	Mercury Marine	26-29476	875
18-1976-2	Mercury Marine	44354A3	797	18-2016	Mercury Marine	26-41953	875
18-1976-2	Mercury Marine	44354A9	797	18-2016	OMC	313992	365
18-1976-2	Mercury Marine	807914A1	797	18-2017	Mercury Marine	26-32121	875
18-1976-2	Mercury Marine	807988A03	797	18-2017	Mercury Marine	26-35025	875
18-1976-2	Mercury Marine	807988A2	797	18-2018	OMC	305987	365
18-1977-1	Mercury Marine	47441	759	18-2019	Mercury Marine	26-27163	875
18-1977-1	Mercury Marine	47441A1	759	18-2020	OMC	310649	365, 949
18-1978	Mercury Marine	60427A2	759	18-2021	OMC	313258	347
18-1978	Mercury Marine	53779A2	759	18-2022	OMC	303345	365, 949
18-1978	Mercury Marine	53779A1	759	18-2023	OMC	313282	365, 949
18-1978	Barr	MC-20-76771	759	18-2024	OMC	314167	365, 949
18-1978	Mercury Marine	76771A2	759	18-2025	OMC	318972	365, 949
18-1978	Mercury Marine	76771A3	759	18-2026	Mercury Marine	802276	875
18-1982	Crusader	98125	625	18-2026	Mercury Marine	26-16977	875
18-1984	Crusader	98128	627	18-2026	Mercury Marine	26-20465	875
18-1985	Barr	MC-20-93322A3	797	18-2026	Mercury Marine	26-31507	875
18-1985	Marine Power	612011	797	18-2026	Mercury Marine	26-79884	875
18-1985	Mercury Marine	93322	797	18-2026	OMC	317843	347
18-1986-1	OMC	3852374	915	18-2027	OMC	305306	365, 949
18-1986-1	OMC	3857723	915	18-2027	OMC	321459	365, 949
18-1986-1	Barr	OMC-1-914035	987	18-2028	OMC	318973	365
18-1986-1	Volvo	3847501	987	18-2029	OMC	319256	365
18-1986-1	Volvo	3857723	987	18-2029	OMC	321481	365
18-1986-1	Volvo	3852374-2	987	18-2030	OMC	321786	365, 949
18-1987-1			Obsolete	18-2031	OMC	321787	365, 949
18-1989	Mercury Marine	861006A1	666, 759				
18-1989	Mercury Marine	8M0061381	666, 759				
18-1989K			666, 759				
18-1990	Barr	1-73813	798				
18-1990	Mercury Marine	48045	798				

1 This product is priced per piece. To order, priced per package, please add -9 to the part number

2 Items ending in "D" are display packaged - regular number is non-display

3 For discount shop pack of 10, please add -10 to the part number

SIERRA #	O.E.M.	O.E. #	PAGE #	SIERRA #	O.E.M.	O.E. #	PAGE #
SIERRA							
18-2032	OMC	321788	365	18-21005K	Mercury Marine	30-862540T1	848
18-2033	OMC	321928	365, 949	18-21005K	Mercury Marine	30-879194A01	848
18-2034	OMC	324639	365, 949	18-21006	Mercury Marine	30-862540A04	848
18-2035	OMC	300599	365	18-21006	Mercury Marine	30-862540A3	848
18-2035	OMC	327031	365	18-21006	Mercury Marine	30-862540T1	848
18-2039	Volvo	804695	1011	18-21006	Mercury Marine	30-879194A01	848
18-2040	Volvo	853670	1011	18-2100K	Mercury Marine	30-60794A2	848
18-2041	Volvo	897426	1011	18-2100K	Mercury Marine	30-60794A4	848
18-2043	Volvo	958838	1011	18-2100K	Mercury Marine	30-879194A02	848
18-2044	Volvo	833996	23	18-2101	Mercury Marine	36147	848
18-2045	Volvo	827247	32	18-2101	Mercury Marine	30-36056	849
18-2046	Volvo	946242	1011	18-2101	Mercury Marine	30-36418	849
18-2047	Volvo	958860	1011	18-2103	Mercury Marine	32-47373	865
18-2048	Mercury Marine	26-24590	875	18-2103	Mercury Marine	32-66073	865
18-2049	Mercury Marine	26-32511	875	18-2103	Mercury Marine	32-68676	865
18-2050	Mercury Marine	26-55682	875	18-2103	Mercury Marine	32-73004	865
18-2051	Mercury Marine	26-69188	875	18-2103	Mercury Marine	32-79431	865
18-2052	Mercury Marine	26-69189	875	18-2103	Mercury Marine	32-86036	865
18-2053	Honda	91255-ZW1-003	268	18-2103	Mercury Marine	32-86036A1	865
18-2053	Mercury Marine	26-70081	464, 875	18-2103	Mercury Marine	32-86036Q	865
18-2054	Honda	91253-ZW1-003	268	18-2103	Pleasurecraft	FO85035	650
18-2054	Mercury Marine	26-76384	875	18-2104	Mercury Marine	36312	849
18-2054	Mercury Marine	26-8164641	875	18-2104	Mercury Marine	41431	849
18-2055	Mercury Marine	26-21642	875	18-2104	Mercury Marine	58749	849
18-2055	Mercury Marine	26-79831	875	18-2104	Mercury Marine	75B32	849
18-2055	Mercury Marine	26-79831	875	18-2104	Mercury Marine	75B321	849
18-2056	Mercury Marine	26-37259	875	18-2104	Mercury Marine	75B32A1	849
18-2056	Mercury Marine	26-89237	875	18-2104	Mercury Marine	75B32A2	849
18-2056	Mercury Marine	26-96503	875	18-2104	Mercury Marine	75B32A3	849
18-2056	Mercury Marine	26-965031	875	18-2104	Mercury Marine	75B32T	849
18-2057	Volvo	181620	1011	18-2104	Mercury Marine	75B32T1	849
18-2058	OMC	313353	365, 949	18-2104	OMC	912214	933
18-2059	OMC	318223	365, 949	18-2104	OMC	915716	933
18-2060	OMC	303804	365	18-2104	Volvo	853255	1007
18-2060	OMC	321467	365, 949	18-2104	Volvo	897707	1007
18-2061	OMC	329922	365, 949	18-2105	Mercury Marine	32-45973	866
18-2062	OMC	329923	365, 949	18-2106	Mercury Marine	32-45974	866
18-2063	OMC	330327	365, 949	18-2107	Mercury Marine	32-55816	866
18-2064	OMC	332205	365, 949	18-2108	Mercury Marine	32-59841	866
18-2065	OMC	332261	365, 949	18-2108	Mercury Marine	32-59841A1	866
18-2066	OMC	911019	365, 949	18-2108	Mercury Marine	32-73123	866
18-2067	OMC	911685	365, 949	18-2109	Mercury Marine	32-59842	866
18-2068	OMC	911701	365, 949	18-2109	Mercury Marine	32-73005	866
18-2068	OMC	915702	365, 949	18-2110	Mercury Marine	32-45327	457
18-2068	OMC	916058	365, 949	18-2110	Mercury Marine	32-88005	457
18-2068	OMC	3853655	365, 949	18-2110	Mercury Marine	32-97153A1	457
18-2071	OMC	908065	949	18-2111	Mercury Marine	32-45959	457
18-2071	OMC	908852	949	18-2111	Mercury Marine	32-88006	457
18-2071	OMC	981195	949	18-2111	Mercury Marine	32-97154A1	457
18-2072	OMC	908070	949	18-2112	Mercury Marine	32-87234	866
18-2072	OMC	908894	949	18-2113	Mercury Marine	32-87235	866
18-2072	OMC	981196	365, 949	18-2114	Mercury Marine	32-864960	866
18-2073	OMC	907967	949	18-2114	Mercury Marine	32-99902-1	866
18-2073	OMC	981268	365, 949	18-2115	Mercury Marine	32-864959	866
18-2074	OMC	339620	949	18-2115	Mercury Marine	32-99903-1	866
18-2075	OMC	326751	949	18-2116	Mercury Marine	32-99904	867
18-2075	OMC	353076	949	18-2116	Mercury Marine	32-99904Q	867
18-2076	Mercury Marine	26-12224	875	18-2125	Mercury Marine	39384	848
18-2076	Mercury Marine	26-F697118	876	18-2125	Mercury Marine	46020	848
18-2077	Mercury Marine	26-14077	877	18-2125	Mercury Marine	460201	848
18-2077	Mercury Marine	26-F697555	878	18-2125	Mercury Marine	4602002	848
18-2079	Yamaha	93101-22M15-00	537, 568	18-2125	Mercury Marine	46020022	848
18-2081	Yamaha	64E-43822-00-00	500	18-2125	Mercury Marine	46020T	848
18-2082	Yamaha	64E-4384J-00-00	500	18-2126	Mercury Marine	32-48418	867
18-2083	Yamaha	68V-13766-00-00	500, 511	18-2126	Mercury Marine	32-52951A1	867
18-2085	Yamaha	93102-35M13-00	537, 568	18-2128	Mercury Marine	39383	848
18-2087	Yamaha	93102-40M36-00	568	18-2128	Mercury Marine	393831	848
18-2091	Yamaha	93104-22M07-00	568	18-2128	Mercury Marine	39383T	848
18-2093	OMC	319664	352, 366	18-2128	OMC	912213	937
18-2093	OMC	333096	352, 366	18-2128	OMC	3850813	937
18-2093	OMC	398051	352, 366	18-2128	Volvo	912213	1007
18-2094	Mercury Marine	26-36143	830	18-2128	Volvo	3850813	1007
18-2094	Mercury Marine	26-88416	830	18-2130	Mercury Marine	66062	861
18-2097	Mercury Marine	8055361	848	18-2130	Mercury Marine	76865	861
18-2097	Mercury Marine	805536A1	848	18-2130	Mercury Marine	8M2009865	861
18-2097	Mercury Marine	805536A2	848	18-2136	Mercury Marine	32-864589	866
18-2100	Mercury Marine	30-60794A2	848	18-2136	Mercury Marine	32-99902	866
18-2100	Mercury Marine	30-60794A4	848	18-2137	Mercury Marine	32-864588	866
18-2100	Mercury Marine	30-879194A02	848	18-2137	Mercury Marine	32-99903	866
18-2100	OMC	983937	932	18-2138	OMC	911787	945
18-2100	Volvo	3853807	1007	18-2138	Volvo	3852544	1008
18-21001	Mercury Marine	30-60794A2	848	18-2140			831
18-21001	Mercury Marine	30-60794A4	848	18-2141	Mercury Marine	10-97934A1	831
18-21001	Mercury Marine	30-879194A02	848	18-2142	Mercury Marine	45706A1	868
18-21005	Mercury Marine	30-562540A3	848	18-2142	Mercury Marine	45706A12	868
18-21005	Mercury Marine	30-862540A04	848	18-2142	Mercury Marine	45706A14	868
18-21005	Mercury Marine	30-862540T1	848	18-2142	Mercury Marine	45706A3	868
18-21005	Mercury Marine	30-879194A01	848	18-2142	Mercury Marine	45706A6	868
18-21005K	Mercury Marine	30-862540A04	848	18-2142	Mercury Marine	45706A8	868
18-21005K	Mercury Marine	30-862540A3	848	18-2143	Mercury Marine	67210	Obsolete

1 This product is priced per piece. To order, priced per package, please add -9 to the part number

2 Items ending in "D" are display packaged - regular number is non-display

3 For discount shop pack of 10, please add -10 to the part number

SIERRA #	O.E.M.	O.E. #	PAGE #	SIERRA #	O.E.M.	O.E. #	PAGE #
SIERRA							
18-2143	Mercury Marine	78249	Obsolete	18-2171	Mercury Marine	38965A1	855
18-2144	Mercury Marine	67209	429	18-2171	Mercury Marine	38965A2	855
18-2144	Mercury Marine	77326	429	18-2171	Mercury Marine	76850A2	855
18-2144	Mercury Marine	78687	429	18-2172	Mercury Marine	14505A2	855
18-2144	Mercury Marine	78687T	429	18-2173	Mercury Marine	59826A1	855
18-2145	Mercury Marine	19297A3	853	18-2173	Mercury Marine	59826A3	855
18-2145	Mercury Marine	43432A2	853	18-2174	Mercury Marine	36312	849
18-2145	Mercury Marine	815471A3	853	18-2174	Mercury Marine	41431	849
18-2145	Mercury Marine	815471A6	853	18-2174	Mercury Marine	58749	849
18-2145	Mercury Marine	85147A5	853	18-2174	Mercury Marine	75832	849
18-2145	Mercury Marine	865437A02	853	18-2174	Mercury Marine	758321	849
18-2145E	Mercury Marine	815471	854	18-2174	Mercury Marine	75832A1	849
18-2145E	Mercury Marine	815471A3	854	18-2174	Mercury Marine	75832A2	849
18-2145E	Mercury Marine	815471A6	853	18-2174	Mercury Marine	75832A3	849
18-2146	Mercury Marine	20175	848	18-2174	Mercury Marine	75832T	849
18-2146	Mercury Marine	59830A1	848	18-2174	Mercury Marine	75832T1	849
18-2146	Mercury Marine	59830A7	848	18-2174	OMC	915717	933
18-2146	OMC	912212	933	18-2174	OMC	3850812	933
18-2146	OMC	3850815	933	18-2174	Volvo	3850812	1007
18-2146	Volvo	3850815	1007	18-2175	Mercury Marine	12632A4	937
18-2147	Johnson/Evinrude	328754	302, 303	18-21751	OMC	983902	855
18-2148	Mercury Marine	45523	868	18-21751	OMC	986338	937
18-2148	Mercury Marine	77443	868	18-21751	OMC	3853962	937
18-2148	Mercury Marine	45706A4	868	18-21751	Volvo	3853962-3	1005
18-2148	Mercury Marine	77442A1	868	18-21752-1	OMC	984290	937
18-2149	Mercury Marine	22879	854	18-21752-1	OMC	986120	937
18-2149	Mercury Marine	29880	854	18-21752-1	OMC	3853917	937
18-2149	Mercury Marine	43433	854	18-21752-1	OMC	3858437	937
18-2150	Mercury Marine	37973	861	18-21752-1	Volvo	3858437-1	1005
18-2150	Mercury Marine	65028	861	18-21753	OMC	3853862	937
18-2150	Mercury Marine	66066	861	18-21753	Volvo	985727	937
18-2150	Mercury Marine	77481	861	18-21753	Volvo	3853862-5	1005
18-2150	Mercury Marine	774811	861	18-21754	OMC	984537	937
18-2151	Mercury Marine	17-45738	8870	18-21754	OMC	986232	937
18-2152	Mercury Marine	17-45735	870	18-21755	OMC	984629	937
18-2153	Volvo	814301	1008	18-2176	OMC	908063	938
18-2154	Mercury Marine	23-30617A1	861	18-2177	OMC	908069	938
18-2154	Mercury Marine	23-30617A2	861	18-2179	Mercury Marine	45-55796	Obsolete
18-2155	Mercury Marine	23-37428A1	453	18-2180	Mercury Marine	45-42634	839, 860
18-2155	Mercury Marine	23-55419A1	453	18-2183	OMC	909121	939
18-2155	Mercury Marine	23-77631A2	453	18-2184	OMC	908087	940
18-2156	OMC	980183	943	18-2185	OMC	909753	940
18-2157	Mercury Marine	19543A10	853	18-2186	OMC	982424	940
18-2157	Mercury Marine	19543A2	853	18-2187	OMC	391472	353
18-2157	Mercury Marine	19543A4	853	18-2187	OMC	395209	353, 940
18-2157	Mercury Marine	19543A8	853	18-2189	Mercury Marine	32992A1	853
18-2157	Mercury Marine	41951A1	853	18-2189	Mercury Marine	34086A1	853
18-2157	Mercury Marine	66065A1	853	18-2189	Mercury Marine	37611A1	853
18-2157	Mercury Marine	66069A2	853	18-2189	Mercury Marine	38399A2	853
18-2157	Mercury Marine	73679A2	853	18-2190	Mercury Marine	19543A10	853
18-2157	Mercury Marine	865436A02	853	18-2190	Mercury Marine	19543A2	853
18-2158				18-2190	Mercury Marine	19543A4	853
18-2159	Mercury Marine	19543A10	853	18-2190	Mercury Marine	19543A8	853
18-2159	Mercury Marine	19543A2	853	18-2190	Mercury Marine	41951A1	853
18-2159	Mercury Marine	19543A4	853	18-2190	Mercury Marine	66065A1	853
18-2159	Mercury Marine	19543A8	853	18-2190	Mercury Marine	66069A2	853
18-2159	Mercury Marine	41951A1	853	18-2190	Mercury Marine	73679A2	853
18-2159	Mercury Marine	66065A1	853	18-2190	Mercury Marine	865436A02	853
18-2159	Mercury Marine	66069A2	853	18-2190E	Mercury Marine	19543A10	853
18-2159	Mercury Marine	73679A2	853	18-2190E	Mercury Marine	19543A2	853
18-2159	Mercury Marine	865436A02	853	18-2190E	Mercury Marine	19543A2	853
18-2160	Mercury Marine	32-38377	853	18-2190E	Mercury Marine	19543A8	853
18-2161	Mercury Marine	45518A1	850	18-2190E	Mercury Marine	41951A1	853
18-2161	Mercury Marine	45518A2	850	18-2190E	Mercury Marine	66065A1	853
18-2161	Mercury Marine	45518A3	850	18-2190E	Mercury Marine	66069A2	853
18-2162	Mercury Marine	33981	850	18-2190E	Mercury Marine	73679A2	853
18-2162	Mercury Marine	8507521	850	18-2190E	Mercury Marine	865436A02	853
18-2162	Mercury Marine	8507522	850	18-2191	Mercury Marine	56211A1	860
18-2162	Mercury Marine	33981T	850	18-2191	Mercury Marine	73020A14	860
18-2162	Mercury Marine	33981T1	850	18-2191	Mercury Marine	73020A14	860
18-2162E	Mercury Marine	33981	Obsolete	18-2192	OMC	379628	898
18-2162E	Mercury Marine	8507521	Obsolete	18-2193	Mercury Marine	33149	831
18-2162E	Mercury Marine	8507522	Obsolete	18-2193	Mercury Marine	99297A1	831
18-2162E	Mercury Marine	33981T1	Obsolete	18-2193	Mercury Marine	99297A2	831
18-2163	Mercury Marine	10-31700	851	18-2195	Mercury Marine	12632A3	855
18-2163E-9	GLM	21090	851	18-2195	Mercury Marine	12632A7	855
18-2163E-9	Mallory	9-72152	851	18-2196	Mercury Marine	37967	860
18-2163E-9	Mercury Marine	10-31700	851	18-2196	Mercury Marine	61073	860
18-2166	Mercury Marine	44-55857	859	18-2196	Mercury Marine	19755A08	860
18-2166	Mercury Marine	44-86060	859	18-2196	Mercury Marine	19755A4	860
18-2166	Mercury Marine	44-860602	859	18-2199	Volvo	832675	1005
18-2166	Mercury Marine	44-860603	859	18-2200	Mercury Marine	43-61027	858
18-2166	Mercury Marine	44-824110	859	18-2200	Mercury Marine	43-96084A4	858
18-2169	Mercury Marine	45589A1	850	18-2201	Mercury Marine	43-18410A2	847
18-2169	Mercury Marine	45589A3	850	18-2201	Mercury Marine	43-18411A2	847
18-2170	Mercury Marine	10-45590	850	18-2201	Mercury Marine	43-59832A2	847
18-2170	Mercury Marine	10-8M0084649	850	18-2201	Mercury Marine	43-59832A4	847
18-2171	Mercury Marine	32492A2	855	18-2202	Mercury Marine	52-66063	860
18-2171	Mercury Marine	32492A3	855	18-2202	Mercury Marine	52-824112	860
18-2171	Mercury Marine	32492A5	855	18-2202	Mercury Marine	52-853594	859

1 This product is priced per piece. To order, priced per package, please add -9 to the part number

2 Items ending in "D" are display packaged - regular number is non-display

3 For discount shop pack of 10, please add -10 to the part number

SIERRA #	O.E.M.	O.E. #	PAGE #	SIERRA #	O.E.M.	O.E. #	PAGE #
SIERRA							
18-2202	Mercury Marine	52-853594T	859	18-2286	Mercury Marine	66067	8860
18-2203	Mercury Marine	43-45814A5	847	18-2286	Mercury Marine	19755A2	860
18-2203	Mercury Marine	43-55765A2	847	18-2286	Mercury Marine	66067T	860
18-2203	Mercury Marine	43-55765A3	847	18-2286	Mercury Marine	818349A1	860
18-2204	Mercury Marine	43-75325A2	847	18-2286	Mercury Marine	818349T1	860
18-2204	Mercury Marine	43-75325A3	847	18-2287	OMC	319895	354
18-2205	Mercury Marine	43-55766A2	847	18-2288	OMC	397541	353
18-2205	Mercury Marine	43-55766A3	847	18-2288	OMC	439138	353
18-2205	Mercury Marine	43-55778A3	847	18-2290			355
18-2206-1	Mercury Marine	43-828072A2	858	18-2291	Mercury Marine	25-60342A1	869
18-2206-1	Mercury Marine	43-828073A1	858	18-2291	Mercury Marine	25-60342A2	869
18-2206-1	Mercury Marine	43-878087A2	858	18-2292	Mercury Marine	15-35980A1	844
18-2208	OMC	318304	354	18-2293	Mercury Marine	15-23097A1	844
18-2209	OMC	318303	354	18-2293	Mercury Marine	15-36178A02	844
18-2216	OMC	334516	354	18-2293	Mercury Marine	15-36178A1	844
18-2216	OMC	336562	354	18-2293	Mercury Marine	15-39899A1	844
18-2216	OMC	337772	354	18-2294	Mercury Marine	15-42637A1	844
18-2216	OMC	337774	354	18-2294	Mercury Marine	15-8M0063267	844
18-2216	OMC	910985	354	18-2295	Mercury Marine	15-33143A1	844
18-2217			354	18-2295	Mercury Marine	15-57007A1	844
18-2218	OMC	434063	354, 940	18-2296	Mercury Marine	15-45811	844
18-2218	OMC	436746	354, 940	18-2296	Mercury Marine	15-71013	844
18-2218	OMC	985050	354, 940	18-2298	Mercury Marine	14-17460	456, 861
18-2218	OMC	989966	354	18-2298	Mercury Marine	14-18323	456, 861
18-2219	OMC	317838	354, 940	18-2299	Mercury Marine	14-52833	456, 861
18-2219	OMC	333077	354, 940	18-2299	Mercury Marine	14-79447	456, 861
18-2219	OMC	304090	354, 940	18-2303	Mercury Marine	10-20518	854
18-2220	OMC	320630	354, 940	18-2308	OMC	332491	354
18-2220	OMC	323664	354, 940	18-2309	OMC	332489	355
18-2221			354, 940	18-2310	OMC	397627	355
18-2224	OMC	320186	359	18-2315			355
18-2225	OMC	320167	359	18-2316	Mercury Marine	12-77674	833
18-2226	OMC	320168	359	18-2320	Mercury Marine	815919A1	861
18-2227	OMC	320169	359	18-23205	Mercury	339-859738T1	Obsolete
18-2228	OMC	320170	359	18-23205	Yamaha	65W-85570-01-00	Obsolete
18-2229	OMC	323362	359, 932	18-23207	Nissan/Tohatsu	3V1060400M	Obsolete
18-2230	OMC	323361	359, 932	18-2321	Mercury Marine	12632A6	855
18-2231	OMC	314745	359, 932	18-2322	Mercury Marine	62104	850
18-2232	OMC	323889	359	18-2322	Mercury Marine	621041	850
18-2233	OMC	323890	359	18-2323	Mercury Marine	18643A5	855
18-2234	OMC	317232	359	18-2324	Mercury Marine	45-557961	850
18-2236	Mercury Marine	52-12777	454	18-2325	OMC	435760	352
18-2236	Mercury Marine	52-34239	454	18-23251	Honda	30520-PWC-003	258
18-2236	Mercury Marine	52-814756	454	18-2326	OMC	436232	352
18-2236	Mercury Marine	52-822539	454	18-2327	OMC	436234	352
18-2236	Mercury Marine	52-822539T	454	18-2328	OMC	435761	352
18-2239	Mercury Marine	44-94148	454	18-2330	OMC	436235	352
18-2243	OMC	316506	355, 939	18-2331	Mercury Marine	45-853647	860
18-2244	Mercury Marine	10-20259	453, 864	18-2331	Mercury Marine	45-853648	860
18-2244	Mercury Marine	10-28634	453, 864	18-2334			577
18-2244	Mercury Marine	10-28634A1	453, 864	18-2336	Mercury Marine	23-47392	871
18-2244	Mercury Marine	10-79953	453, 865	18-2336	Mercury Marine	23-61291	871
18-2244	Mercury Marine	10-79953A2	453, 866	18-2336	Mercury Marine	23-90203	871
18-2244	Mercury Marine	10-79953Q04	453, 867	18-2337	OMC	3850814	933
18-2244	Mercury Marine	10-79953Q2	453	18-2337	Volvo	3850814	1007
18-2244	Mercury Marine	10-F50109	453, 864	18-2338	OMC	983880	933
18-2244	Mercury Marine	816610A1	453, 864	18-2339	OMC	3852384	933
18-2244	Mercury Marine	816610A2	453, 864	18-2339	Volvo	3852384	1007
18-2244	Mercury Marine	F40109	453, 864	18-2340	Mercury Marine	12-31266	831
18-2244-9			453, 864	18-2341-1	Mercury Marine	23-815950	871
18-2245-1	OMC	987661	937	18-2341-1	Mercury Marine	23-8159501	871
18-2246	OMC	987678	937	18-2341-1	Mercury Marine	23-815950Q01	871
18-2248	Mercury Marine	35187A1	853	18-2342	Mercury Marine	68100	860
18-2248	Mercury Marine	35187A2	853	18-2342	Mercury Marine	681001	860
18-2248	Mercury Marine	35187A4	853	18-2343	Mercury Marine	12-92721	933
18-2248	Mercury Marine	49518A1	853	18-2345	Mercury Marine	53-815949	871
18-2248	Mercury Marine	73723A01	853	18-2346	Mercury Marine	824519	860
18-2248	Mercury Marine	73723A1	853, 854	18-2346	Mercury Marine	88245191	860
18-2250	OMC	387879	353	18-2346	Mercury Marine	11-42633	860
18-2251	OMC	433017	353, 940	18-2346	Mercury Marine	F694961	860
18-2251	OMC	435022	353, 940	18-2346	Mercury Marine	F694961-1	860
18-2251	OMC	436740	353, 940	18-2348	Mercury Marine	24-30893	859
18-2252	OMC	387818	353, 940	18-2349	Mercury Marine	23-67370	864
18-2252	OMC	436888	353, 940	18-2353	Mercury Marine	23-815921A10	861
18-2254	Chrysler/Force	44-850308	256	18-2353	Mercury Marine	23-815921A17	861
18-2254	Mercury Marine	44-850308	454, 859	18-2353	Mercury Marine	23-815921A21	843, 861
18-2256	Mercury Marine	43-803116T1	835, 847	18-2353	Mercury Marine	23-815921A6	861
18-2257	Mercury Marine	43-803112T1	835, 848	18-2353	Mercury Marine	23-815921A8	861
18-2258	Mercury Marine	43-803114T1	835, 848	18-2353	Mercury Marine	815921A2	861
18-2259	Mercury Marine	43-803101T1	835, 848	18-2354	Mercury Marine	807929A1	861
18-2260	Mercury Marine	44-17915	454	18-2354	Mercury Marine	807929A2	861
18-2260	Mercury Marine	44-98418	454	18-2354	Mercury Marine	815922A1	861
18-2261	Mercury Marine	45-816919	843, 860	18-2354	Mercury Marine	815922A5	861
18-2277	OMC	335722	353	18-2354	Mercury Marine	821759A1	861
18-2279	OMC	335679	353	18-2354	Mercury Marine	821759A2	843, 861
18-2282	Mercury Marine	15-32563A1	844	18-2354	Mercury Marine	821759A3	861
18-2283	Mercury Marine	15-45691A1	844	18-2354	Mercury Marine	821759A4	861
18-2284	Mercury Marine	15-31535A1	Obsolete	18-2355	OMC	386659	353
18-2285	Mercury Marine	15-35931A1	844	18-2357	Mercury Marine	17-30632	859
18-2285	Mercury Marine	15-47397A1		18-2357	Mercury Marine	17-8M0020941	859

1 This product is priced per piece. To order, priced per package, please add -9 to the part number

2 Items ending in "D" are display packaged - regular number is non-display

3 For discount shop pack of 10, please add -10 to the part number

SIERRA #	O.E.M.	O.E. #	PAGE #	SIERRA #	O.E.M.	O.E. #	PAGE #
SIERRA							
18-2357	Mercury Marine	17-8M0084681	859	18-2401	Mercury Marine	1623-8951A5	845
18-2357	Mercury Marine	17-8M0100263	859	18-2402	Mercury Marine	1623-5356A4	845
18-2358	Mercury Marine	43-803102T1	846	18-2404	Mercury Marine	43-803079T1	859
18-2359	Mercury Marine		454, 860	18-2405	Mercury Marine	43-803091T1	859
18-2360	Mercury Marine	43-828072A3	858	18-2406	Mercury Marine	43-878072A3	858
18-2360	Mercury Marine	43-878087A2	858	18-2406	Mercury Marine	43-878087A2	858
18-23601	Yamaha	66M-85570-00-00	Obsolete	18-2407	Mercury Marine	43-17064A3	839
18-23602	Yamaha	63V-85570-00-00	Obsolete	18-2407	Mercury Marine	43-42933A2	859
18-2361	Mercury Marine	10-30206	831	18-2407	Mercury Marine	43-42933A3	859
18-2361	Mercury Marine	10-805763	831	18-2407	Mercury Marine	43-823072A2	859
18-2361	Mercury Marine	10-853163	831	18-2407	Mercury Marine	43-878087A4	859
18-2363	Mercury Marine	43-803118T1	846	18-2408	Mercury Marine	43-828073A1	858
18-2364	Mercury Marine	43-803119T1	846	18-2409	Mercury Marine	43-92320	858
18-2365	Mercury Marine	43-803120T1	846	18-2409	Mercury Marine	43-92320T	858
18-2366	Volvo	876279	1007	18-2410	Mercury Marine	43-96084A5	858
18-2367	Volvo	943414	995	18-2410	Mercury Marine	43-96084A7	858
18-2368	Mercury Marine	43-803071T1	846	18-2411	Mercury Marine	1547-861063A4	844
18-2369	Mercury Marine	43-803069T1	846	18-2412-1	Mercury Marine	18309A2	855
18-2370	Chrysler Force	19291A3	254, 451	18-2412-1	Mercury Marine	18311A17	855
18-2370	Mercury Marine	19291A3	254, 451	18-2412-1	Mercury Marine	18311A2	855
18-2371	Yamaha	90340-08002-00	550, 559, 559	18-2412-1	Mercury Marine	812964A2	855
18-2371	Yamaha	90340-08M04-00	550, 559, 559	18-2412-1	Mercury Marine	861523A9	855
18-23711-9	Yamaha	90340-08002-00	550	18-2412-1	Mercury Marine	80M0098795	855
18-23711-9	Yamaha	90340-08M04-00	550	18-2413	Mercury Marine	69354A1	855
18-2372	Mercury Marine	88035	868	18-2413	Mercury Marine	69354A2	855
18-2373	Mercury Marine	14698	Obsolete	18-2414	Mercury Marine	97432A2	855
18-2373	Mercury Marine	14698T	Obsolete	18-2415	Mercury Marine	1623-815822A36	845
18-2373	Mercury Marine	14698T10	Obsolete	18-2416	Mercury Marine	1547-815930A16	845
18-2373	Mercury Marine	806191T	Obsolete	18-2416	Mercury Marine	1547-815930A6	845
18-2373	Mercury Marine	8M0110717	Obsolete	18-2416	Mercury Marine	1547-861063A12	845
18-2374	Yamaha	688-45341-00-00	550	18-2419	Mercury Marine	1547-815930A13	845
18-2374	Yamaha	688-45341-10-00	550	18-2419	Mercury Marine	1547-815930A3	845
18-23741-9	Yamaha	688-45341-00-00	Obsolete	18-2419	Mercury Marine	1547-861063A6	845
18-23741-9	Yamaha	688-45341-10-00	Obsolete	18-2420	Mercury Marine	14034A3	Obsolete
18-2375	Mercury Marine	10-14834	453, 864	18-2420	Mercury Marine	14034A5	Obsolete
18-2375	Mercury Marine	10-14834A1	453, 864	18-2420	Mercury Marine	14034F1	Obsolete
18-2375	Mercury Marine	22-67892	453, 864	18-2420	Mercury Marine	14034T	Obsolete
18-2375	Mercury Marine	22-67892A05	453, 864	18-2420	Mercury Marine	14034T10	Obsolete
18-2375	Mercury Marine	22-67892A06	453, 864	18-2421	Mercury Marine	14035A3	Obsolete
18-2375	Mercury Marine	22-67892A1	453, 864	18-2421	Mercury Marine	14035A5	Obsolete
18-2375	Mercury Marine	28-8M0058389	453	18-2421	Mercury Marine	14035F1	Obsolete
18-2375			254	18-2421	Mercury Marine	14035T	Obsolete
18-23751-9	Mercury Marine	10-14834A1	453, 864	18-2421	Mercury Marine	14035T10	Obsolete
18-23751-9	Mercury Marine	22-67892A1	453, 864	18-2422	Mercury Marine	815935A3	Obsolete
18-23751-9			254	18-2422	Mercury Marine	815935A7	Obsolete
18-2376	Mercury Marine	73020A20	861	18-2423	Mercury Marine	815954A3	Obsolete
18-2376	Mercury Marine	818763A10	861	18-2423	Mercury Marine	815954A7	Obsolete
18-2376	Mercury Marine	818763A4	861	18-2424	Mercury Marine	98703A11	869
18-2377	OMC	316563	346	18-2424	Mercury Marine	98703A12	869
18-2378	OMC	318544	929	18-2424	Mercury Marine	98703A17	869
18-23781-9	OMC	318544	346, 929	18-2424	Mercury Marine	98703A26	869
18-2379	OMC	320041	341, 346	18-2425	Mercury Marine	8M0708280	869
18-2380	Yamaha	91401-30028-00	551	18-2425	Mercury Marine	98704A11	869
18-2380	Yamaha	91401-30030-00	551	18-2425	Mercury Marine	98704A12	869
18-2380	Yamaha	91402-30022-00	551	18-2425	Mercury Marine	98704A17	869
18-2380	Yamaha	91402-30022-09	551	18-2425	Mercury Marine	98704A26	869
18-2380	Yamaha	91402-30028-00	551	18-2426	Mercury Marine	98703A3	869
18-2380	Yamaha	91402-30028-09	551	18-2427	Mercury Marine	98704A3	869
18-2380	Yamaha	91490-30030-00	551	18-2428	Mercury Marine	87399A1	869
18-2381	Mercury Marine	94998A1	850	18-2428	Mercury Marine	87399A2	869
18-2381	Mercury Marine	94998A2	835, 850	18-2429	Mercury Marine	87399A3	869
18-2381	Mercury Marine	94998A3	850	18-2430	Mercury Marine	26-830749	443, 461
18-2381	Mercury Marine	94998A4	850	18-24301-9	Mercury Marine	26-830749	443, 461
18-2382	Mercury Marine	18312A3	850	18-2432	Volvo	873228	1005
18-2382	Mercury Marine	828692A1	837, 850	18-2433	Volvo	873229	1005
18-2383	OMC	914716	940	18-2434	Crusader	96938	576, 615
18-2383	OMC	915272	940	18-2434	Marine Power	0100-000	576
18-2385	Yamaha	6E5-45611-01-00	550, 561	18-2434	Mercury Marine	814309A1	576, 717
18-2387	OMC	307551	929	18-2434	Pleasurecraft	R142006	576, 650
18-23871-9	OMC	307551	346, 929	18-2434	Volvo	3857846-4	578
18-2388	Yamaha	688-45611-00-00	550	18-2435	Mercury Marine	32-861127	866
18-2389	OMC	314832	333	18-2435	Mercury Marine	32-95858	866
18-2391	OMC	321692	307, 333	18-2436	Mercury Marine	32-861128	867
18-2392	OMC	327035	333	18-2436	Mercury Marine	32-95859	867
18-2393	Mercury Marine	17-14872	870	18-2443	Mercury Marine	1623-4110A13	845
18-2394	Mercury Marine	17-14873	870	18-2443	Mercury Marine	1623-4110A4	845
18-2395	Mercury Marine	17-815953	870	18-2443	Mercury Marine	1623-4110A6	845
18-2395	Mercury Marine	17-815953A1	870	18-2443	Mercury Marine	1623-5356A18	845
18-2396	Mercury Marine	17-44166	870	18-2443	Mercury Marine	1623-5356A19	845
18-2397	Mercury Marine	17-44167	870	18-2443	Mercury Marine	1623-5356A20	845
18-2397	Mercury Marine	17-44167A1	870	18-2443	Mercury Marine	1623-5356A3	845
18-2398	OMC	320311	339, 355	18-2443	Mercury Marine	1623-8951A14	845
18-2399	OMC	324369	355, 939	18-2443	Mercury Marine	1623-8951A19	845
18-2400	Mercury Marine	1623-81582243	844	18-2443	Mercury Marine	1623-8951A2	845
18-2400	Mercury Marine	1623-815822A32	844	18-2443	Mercury Marine	1623-8951A23	845
18-2400	Mercury Marine	1623-815822A5	844	18-2443	Mercury Marine	1623-8951A43	845
18-2400	Mercury Marine	1623-815822A53	844	18-2448	Mercury / BRP		215, 267, 477, 550
18-2401	Mercury Marine	1623-8951A15	845	18-2448			845
18-2401	Mercury Marine	1623-8951A27	845	18-2450	Mercury Marine	1547-3917A13	845
18-2401	Mercury Marine	1623-8951A37	845				

1 This product is priced per piece. To order, priced per package, please add -9 to the part number

2 Items ending in "D" are display packaged - regular number is non-display

3 For discount shop pack of 10, please add -10 to the part number

SIERRA #	O.E.M.	O.E. #	PAGE #	SIERRA #	O.E.M.	O.E. #	PAGE #
SIERRA							
18-2450	Mercury Marine	1547-3917A21	845	1 18-2509	Mercury Marine	27-67751	437
18-2450	Mercury Marine	1547-3917A32	845	1 18-2510	Mercury Marine	27-96761	438
18-2450	Mercury Marine	1547-3917A37	845	1 18-2510	Mercury Marine	27-967611	438
18-2450	Mercury Marine	1547-5523A12	845	1 18-2511	Mercury Marine	27-99173-2	441
18-2450	Mercury Marine	1547-5523A2	845	1 18-2512	Mercury Marine	27-60286	434
18-2450	Mercury Marine	1547-5523A68	845	1 18-2513	Mercury Marine	27-11338	438
18-2450	Mercury Marine	1547-5523A9	845	1 18-2513	Mercury Marine	27-67208	438
18-2450	Mercury Marine	1547-8265A15	845	1 18-2514	Mercury Marine	27-53650	438
18-2450	Mercury Marine	1547-9412A20	845	1 18-2516	Mercury Marine	16755	829
18-2450	Mercury Marine	1547-9412A30	845	1 18-2516	Mercury Marine	16755A1	829
18-2451	Mercury Marine	1547-3917A16	845	1 18-2516	Mercury Marine	16755Q1	829
18-2451	Mercury Marine	1547-3917A30	845	1 18-2518	Volvo	430017	1003
18-2451	Mercury Marine	1547-3917A38	845	1 18-2519	Volvo	831622	1004
18-2451	Mercury Marine	1547-3917A4	845	1 18-25200	Honda	37500-PNB-003	261
18-2451	Mercury Marine	1547-3917A8	845	1 18-25201	Honda	37510-PNB-003	261
18-2451	Mercury Marine	1547-5523A11	845	1 18-2524	Honda	19232-ZV1-A10	265
18-2451	Mercury Marine	1547-5523A8	845	1 18-2525	Volvo	430018	1004
18-2451	Mercury Marine	1547-8265A16	845	1 18-25250	Volvo	3863085	1004
18-2451	Mercury Marine	1547-9412A21	845	1 18-25251	Volvo	853868	1004
18-2452	Mercury Marine	1547-5523A67	845	1 18-2526	Volvo	430172	1004
18-2452	Mercury Marine	1547-8265A17	845	1 18-2527	Volvo	831617	1004
18-2452	Mercury Marine	1547-9412A22	845	1 18-2528	Volvo	831891	1004
18-2452	Mercury Marine	1547-9412A36	845	1 18-2529	Volvo	831892	1004
18-2453	Mercury Marine	1547-5523A49	845	1 18-2530	Volvo	1336255	1004
18-2453	Mercury Marine	1547-5523A67	845	1 18-2530	Volvo	3547991	1004
18-2453	Mercury Marine	1547-8265A17	845	1 18-25300	Yamaha	66M-85540-01-00	492
18-2453	Mercury Marine	1547-9412A23	845	1 18-2531	Volvo	834476	1004
18-2454	OMC	3854539	945, 1008	1 18-2532	OMC	305762	333, 362
18-2454	Volvo	3854539	945, 1008	1 18-2533	OMC	811797	937, 248
18-2455			220	1 18-2534	Chrysler Force	F184122-1	954
18-2456	Yamaha	90340-14M06-00	535	1 18-2534	OMC	309044	333
18-2460	Mercuriser	11-88462	864	1 18-2536	OMC	321120	332
18-2460	Mercuriser	22-88847A1	864	1 18-2537	OMC	324937	333
18-2461	Mercury Marine	17-44166T1	868	1 18-2539	OMC	328753	332
18-2462	Mercury Marine	17-14873A1	868	1 18-25400	Mercury	16068004	376
18-2462	Mercury Marine	17-85056	868	1 18-2541	OMC	911704	926
18-2463	Mercury Marine	17-14872A1	868	1 18-2543	OMC	318609	331
18-2463	Mercury Marine	17-99207	868	1 18-2544	OMC	321028	331
18-2464	Mercury Marine	17-815953T1	868	1 18-2545	OMC	321182	320
18-2464	Mercury Marine	56-18541A75	868	1 18-2546	OMC	321184	332
18-2464	Mercury Marine	56-864641A24	868	1 18-2547	OMC	322858	332
18-2465-9	Mercury Marine	19-14842	868	1 18-2548	OMC	332108	332
18-2465-9	Mercury Marine	19-148421	868	1 18-2549	OMC	321435	320
18-2466-9	Mercury Marine	19-815951	868	1 18-2550	OMC	323214	330
18-2470	Honda	16221-ZV4-610	266	1 18-25513	Mercury	803844T01	Obsolete
18-2471	Honda	16221-ZW9-000	266	1 18-2552	Mercury Marine	27-331791	826
18-2472	Honda	16221-ZW1-000	266	1 18-2552	Mercury Marine	27-331792	826
18-2473	Honda	16201-8B1-850	266	1 18-2553	Mercury Marine	27-47510	826
18-2480	Honda	16010-ZV4-005	265	1 18-2553	Mercury Marine	27-47510Q	826
18-2481	Honda	16010-ZW9-003	265	1 18-2554	Mercury Marine	27-41812	826
18-2482	Honda	16010-8B1-003	266	1 18-2554	Mercury Marine	27-41812Q	826
18-2495	Honda	19232-ZV4-610	263, 265	1 18-2554	Mercury Marine	27-90556	826
18-2496	Honda	19233-ZV5-000	265	1 18-2555	Mercury Marine	27-89656	826
18-2499	Honda	19234-ZY3-000	265	1 18-2555	Mercury Marine	27-896561	826
1 18-2500	Mercury Marine	27-52893	439	1 18-2556	Mercury Marine	27-35996	832
1 18-2500	Mercury Marine	27-72505	439	1 18-2556	Mercury Marine	27-35996A1	832
1 18-2500	Mercury Marine	27-85493	432, 439	1 18-2557	OMC	324701	332
1 18-25001	Mercury Marine	27-14765	828	1 18-2557	OMC	338484	332
1 18-25001	Mercury Marine	F3860315	828	1 18-2558	Mercury Marine	27-19204-2	441
1 18-25001	Mercury Marine	F11110294	828	1 18-2559	Mercury Marine	27-19202	441
1 18-25001	Mercury Marine	F11110958	828	1 18-2559	Mercury Marine	27-42206	441
1 18-25002	Mercury Marine	27-811588	828	1 18-2560	Mercury Marine	12-86645	443
1 18-2501	Mercury Marine	27-67738	438	1 18-2560	Mercury Marine	12-866451	443
1 18-2501	Mercury Marine	27-93536	438	1 18-2560	Mercury Marine	8M0027721	443
1 18-2501	Mercury Marine	27-935361	438	1 18-25600	Yamaha	66M-85520-00-00	Obsolete
1 18-2502	Mercury Marine	27-87396	439	1 18-25604	Yamaha	63V-85533-00-00	492
1 18-2502	Mercury Marine	27-90484	439	1 18-2561	Mercury Marine	27-85087	441
1 18-2502	Mercury Marine	27-904841	439	1 18-2562	Mercury Marine	27-99326	442
1 18-2503	Mercury Marine	27-78068	441	1 18-2562	Mercury Marine	27-993261	442
1 18-2503	Mercury Marine	27-99177	441	1 18-2563	Honda	19232-ZW1-003	265
1 18-2503	Mercury Marine	27-991771	441	1 18-2563	Mercury Marine	27-43034	442
1 18-2503	Mercury Marine	27-991772	441	1 18-2563	Mercury Marine	27-430341	442
1 18-2504	Mercury Marine	27-60310	439	1 18-2564	Honda	19234-ZW1-003	S/S to 18-2564-1
1 18-2504	Mercury Marine	27-74511	439	1 18-2564-1	Honda	19234-ZW1-003	265
1 18-2504	Mercury Marine	27-76401	439	1 18-2564	Mercury Marine	27-43033	S/S to 18-2564-1
1 18-2504	Mercury Marine	27-88449	434, 439	1 18-2564-1	Mercury Marine	27-43033	442
1 18-2505	Mercury Marine	27-96171	439	1 18-2564	Mercury Marine	27-430331	S/S to 18-2564-1
1 18-2505	Mercury Marine	27-961711	439	1 18-2564-1	Mercury Marine	27-430331	442, 829
1 18-2506-1	Mercury Marine	27-99176	441	1 18-2565	Honda	19242-ZW1-003	265
1 18-2506-1	Mercury Marine	27-991762	441	1 18-2565	Mercury Marine	27-43047	442
1 18-2506-1	Mercury Marine	27-991763	441	1 18-2565	Mercury Marine	27-430471	442
1 18-2506-1	Mercury Marine	27-991764	441	1 18-2565	Mercury Marine	27-430472	442
1 18-2507	Mercury Marine	27-37816	439	1 18-25650	Yamaha	66M-85580-00-00	492
1 18-2507	Mercury Marine	27-72487	439	1 18-25652	Yamaha	63V-85580-01-00	492
1 18-2507	Mercury Marine	27-78026	439	1 18-2566	Mercury Marine	27-817277	442
1 18-2507	Mercury Marine	27-85487	433, 439	1 18-2566	Mercury Marine	27-8172771	442
1 18-2508-1	Mercury Marine	27-96440	441	1 18-2568	Mercury Marine	27-25848	437
1 18-2508-1	Mercury Marine	27-99776	441	1 18-2569	Mercury Marine	27-25849	438
1 18-2508-1	Mercury Marine	27-997761	441	1 18-2570	Mercury Marine	27-25851	438
1 18-2508-1	Mercury Marine	27-997761	441	1 18-2570	Mercury Marine	27-34614	438

1 This product is priced per piece. To order, priced per package, please add -9 to the part number

2 Items ending in "D" are display packaged - regular number is non-display

3 For discount shop pack of 10, please add -10 to the part number

SIERRA #	O.E.M.	O.E. #	PAGE #	SIERRA #	O.E.M.	O.E. #	PAGE #	
SIERRA								
1	18-2571	Mercury Marine	27-31402	433, 437	18-2626	Chrysler Force	26-43035A4	254
1	18-2572	Mercury Marine	27-22023	437	18-2626	Mercury Marine	26-43034A1	459
1	18-2572	Mercury Marine	27-63309	437	18-2626	Mercury Marine	26-43034A2	459
1	18-2573	Mercury Marine	27-60475	439	18-2626	Mercury Marine	26-43034A3	459
1	18-2573	Mercury Marine	27-72142	439	18-2626	Mercury Marine	26-43035A4	459
1	18-2573	Mercury Marine	27-721421	439	18-2627	Mercury Marine	26-66303A1	459
1	18-2574	Mercury Marine	27-60476	439	18-2628	Mercury Marine	26-77066A1	460
1	18-2574	Mercury Marine	27-72507	439	18-2629	Chrysler Force	26-85090A1	460
1	18-2574	Mercury Marine	27-85495	439	18-2629	Mercury Marine	26-85090A1	460
1	18-2574	Mercury Marine	27-854951	439	18-2630	Chrysler Force	FK1060	255
1	18-2574	Mercury Marine	27-854952	439	18-2631	Chrysler Force	FK1061	255
1	18-2575	Mercury Marine	1399-99	438	18-26310-2	Mallory	YLM700AV	182
1	18-2579	OMC	338882	327	18-26311-2	Mallory	YLM566AV	182
1	18-2582	OMC	338813	327	18-2632	Chrysler Force	FK1063-1	255
1	18-2583	Volvo	3888821	1011	18-2632	Chrysler Force	FK1063-2	255
1	18-2584	Volvo	3888822	1011	18-2633	Chrysler Force	FK1127	255
1	18-2586	Volvo	3850594	1010	18-2635	Chrysler Force	26-814669A1	255
1	18-2587	Mercury Marine	99356A2	576	18-2635	Chrysler Force	26-814669A2	255
1	18-2588			576	18-2635	Chrysler Force	FK1234	255
1	18-2589			576	18-2635	Mercury Marine	26-814669A2	460
1	18-2590	Borg-Warner	A4876HA	577	18-2636	Chrysler Force	26-820645A	255
1	18-2591			577	18-2636	Chrysler Force	FK1074	255
1	18-2592	Yamaha	6E5-14384-03-00	547	18-2637-1	Chrysler Force	FK1064	255
1	18-2593	Mercury Marine	27-194541	442	18-2638	Chrysler Force	FK1065	255
1	18-2595	OMC	982132	365	18-2639	Chrysler Force	FK1068	255
1	18-2596	Volvo	875422	999	18-2640	Chrysler Force	FK1203	255
1	18-2597			1011	18-2640	Chrysler Force	FK1203-1	255
1	18-2598	Volvo	3855275	1010	18-2642	Mercury Marine	26-816575A5	460
1	18-2599	Mercury Marine	26-816575A2	459, 850	18-2643	Mercury Marine	26-16709A1	872
1	18-2600			854	18-2643	Mercury Marine	26-16709A2	872
1	18-26002-1			701	18-2644	Mercury Marine	26-88397A1	872
1	18-2601-1	Mercury Marine	30-803097T1	851	18-2645	Mercury Marine	26-76868A04	873
1	18-2603	Mercury Marine	19543T1	854	18-2645	Mercury Marine	26-76868A1	873
1	18-2603	Mercury Marine	19543T2	854	18-2645	Mercury Marine	26-76868A2	873
1	18-2603	Mercury Marine	865436A03	854	18-2646-1	Mercury Marine	26-816575A1	461
1	18-2603E	Mercury Marine	19543T1	854	18-2646-1	Mercury Marine	26-816575A3	461
1	18-2603E	Mercury Marine	19543T2	854	18-2648	Mercury Marine	26-32511A1	873
1	18-2603E	Mercury Marine	865436A03	854	18-2649	Mercury Marine	25-87400A2	869
1	18-2604	Mercury Marine	815471T1	854	18-2652	Mercury Marine	26-33144A1	873
1	18-2604E	Mercury Marine	815471T1	854	18-2652	Mercury Marine	26-33144A2	873
1	18-2605	Yamaha	90119-08M87-00	515	18-2652	Mercury Marine	26-89238A1	873
1	18-2606	Yamaha	90119-08M13-00	515	18-2653	Mercury Marine	26-55682A1	461
1	18-2607	Yamaha	97095-06040-00	515	18-2654	Mercury Marine	26-79831A1	461
1	18-2608	Honda	19232-881-850	265	18-2655	Mercury Marine	26-89238A2	461
1	18-2609	Honda	19234-881-850	265	18-2656	OMC	396350	364
1	18-2610	Mercury Marine	27-812755	440	18-2657	OMC	396352	364
1	18-2610	Mercury Marine	27-8127754	440	18-2658	OMC	396351	362
1	18-26104-1	Mallory	YL567EV	183, 703, 887	18-2659	OMC	396355	362
1	18-26107-1	Mallory	YL700AV	183	18-2660	OMC	396349	362
1	18-2611	Mercury Marine	27-8127551	440	18-2663	OMC	981797	946
1	18-2611	Mercury Marine	27-812755A01	440	18-2664	OMC	982947	946
1	18-2611	Mercury Marine	27-8127755	440	18-2665	OMC	982946	946
1	18-26110-1	Mallory	YL579AV	183, 703	18-2666	OMC	981799	946
1	18-26111-1	Mallory	YL648AV	183, 701	18-2667	OMC	982949	947
1	18-2613	OMC	508105	924	18-2669	OMC	981801	947
2	18-2614	Mercury Marine	27-64818	832	18-2671	OMC	985612	947
2	18-2614	Mercury Marine	27-45821	832	18-2672	OMC	439967	947
2	18-2614	Mercury Marine	27-64818A1	832	18-2672	OMC	984458	947
2	18-2614	Mercury Marine	27-64818A20	832	18-2672	OMC	985613	947
2	18-2614	Mercury Marine	27-64818A4	832	18-2673	OMC	984459	948
2	18-2614	Mercury Marine	27-64818Q4	832	18-2673	OMC	986364	948
2	18-2614	Mercury Marine	27-64818T1	832	18-2673	OMC	987603	948
2	18-2615	Mercury Marine	16755	832	18-2674	OMC	985518	948
2	18-2615	Mercury Marine	16755A1	832	18-2674	OMC	986423	948
2	18-2615	Mercury Marine	16755Q1	832	18-2679			362
2	18-2615	Mercury Marine	16755T1	832	18-2680			362
2	18-2617	Mercury Marine	27-35996	832	18-26800			183
2	18-2617	Mercury Marine	27-35996A1	832	18-2681	Mallory	670	362
2	18-2619-1	Mercury Marine	27-64818A2	832	18-26810			183, 614, 643, 698, 883, 964
2	18-2619-1	Mercury Marine	27-64818A3	832	18-26811			183, 614, 643, 698, 883, 964
2	18-2619-1	Mercury Marine	27-64818A3	832	18-26812			183, 614, 643, 698, 883, 964
2	18-2619-1	Mercury Marine	27-94996	832	18-26813			183, 614, 643, 698, 883, 964
2	18-2619-1	Mercury Marine	27-94996A1	832	18-26815	Mallory	29349	183
2	18-2619-1	Mercury Marine	27-94996A2	832	18-2682			362
2	18-2619-1	Mercury Marine	27-94996A20	832	18-26820			184
2	18-2619-1	Mercury Marine	27-94996Q2	832	18-26821			184
2	18-2619-1	Mercury Marine	27-94996T2	832	18-2683			362
2	18-2620	Mercury Marine	27-54014	832	18-2684			362
2	18-2620	Mercury Marine	27-54014A1	832	18-2685			362
2	18-2620	Mercury Marine	27-54014Q1	832	18-2686			363
2	18-2620	Mercury Marine	27-54014T1	832	18-2687			363
2	18-2621	Mercury Marine	27-139581	438	18-2688			363
2	18-2622	Mercury Marine	23-79373A1	850	18-2689			363
2	18-2622	Mercury Marine	23-805041A2	850	18-2690			363
2	18-2622	Mercury Marine	27-45588	850	18-2691			363
2	18-2622	Mercury Marine	27-79373	850	18-2692			363
2	18-2623	OMC	439141	361	18-2694	OMC	433550	363
2	18-2624	Chrysler Force	26-85090A2	254	18-2697-1	Chrysler Force	26-41365A3	255
2	18-2624	Mercury Marine	26-85090A2	254	18-2697-1	Mercury Marine	26-41365A3	462
2	18-2625	Volvo	875192	1011	18-2698			944

1 This product is priced per piece. To order, priced per package, please add -9 to the part number

2 Items ending in "D" are display packaged - regular number is non-display

3 For discount shop pack of 10, please add -10 to the part number

SIERRA #	O.E.M.	O.E. #	PAGE #	SIERRA #	O.E.M.	O.E. #	PAGE #		
				SIERRA					
			924, 999	18-2741	Mercury Marine	27-430047	440		
			Obsolete	18-2742	Mercury Marine	85552	459		
			Obsolete	18-2743	Mercury Marine	27-64818A2	829		
1	18-2701	Mercury Marine	23-45736	871	18-2743	Mercury Marine	27-94996	8829	
1	18-2701	Mercury Marine	23-61290	871	18-2743	Mercury Marine	27-949962	829	
1	18-2701	Mercury Marine	23-89574	871	18-2743	Mercury Marine	27-94996A1	829	
2	18-2701-04	Mercury Marine	23-45736	871	18-2743	Mercury Marine	27-94996A2	829	
2	18-2701-04	Mercury Marine	23-61290	871	18-2743	Mercury Marine	27-94996A20	829	
2	18-2701-04	Mercury Marine	23-89574	871	18-2743	Mercury Marine	27-94996A3	829	
2	18-2702-04	Mercury Marine	23-99291	871	18-2743	Mercury Marine	27-94996Q2	829	
2	18-2702-04	Mercury Marine	23-99291T	871	18-2744	Volvo	875826	1006	
1	18-2702-1	Mercury Marine	23-99291	871	18-2744	Volvo	876294	1006	
1	18-2702-1	Mercury Marine	23-99291T	871	18-2745	OMC	912374	937	
1	18-2702-1	Pleasurecraft	R094020A	650	18-2746	Mercury Marine	31-14358001	852	
1	18-2703	OMC	314008	333	18-2746	Mercury Marine	32-14358	852	
1	18-2704	OMC	320943	333	18-2746	Mercury Marine	32-14358T	852	
1	18-2705	OMC	315748	333	18-2747	Mercury Marine	816431A1	851, 852	
1	18-2706	OMC	321008	333	18-2748	Mercury Marine	31-44348001	852	
1	18-2707	Mercury Marine	973513	333	18-2748	Mercury Marine	32-44348	852	
1	18-2708	OMC	333758	333	18-2748	Mercury Marine	32-44348T	791, 852	
1	18-2709	OMC	336530	334	18-2749	Mercury Marine	27-812867	439	
	18-2710	Mercury Marine	27-41417	438	18-2749	Mercury Marine	27-8128671	439	
	18-2710	Mercury Marine	27-414171	438	18-2750	Mercury Marine	32734	852	
	18-2710	Mercury Marine	27-414172	438	18-2750	Mercury Marine	18654A1	852	
	18-2710	Mercury Marine	27-85978	438	18-2750	Mercury Marine	32734A3	852	
	18-2712	Mercury Marine	27-41418	438	18-2751	Mercury Marine	60932A1	852	
	18-2712	Mercury Marine	27-414181	438	18-2751	Mercury Marine	60932A4	852	
	18-2712	Mercury Marine	27-85979	438	18-2752	Mercury Marine	36223	852	
	18-2713	Mercury Marine	27-43337	440	18-2752	Mercury Marine	36223A1	852	
	18-2713	Mercury Marine	27-433371	440	18-2752	Mercury Marine	36223A2	852	
	18-2713	Mercury Marine	27-433372	440	2	18-2753-2	Mercury Marine	31659	852
	18-2713	Mercury Marine	27-433373	440	2	18-2753-2	Mercury Marine	74639	852
	18-2713	Mercury Marine	27-433374	440	2	18-2753-2	Mercury Marine	74639A2	852
	18-2713	Mercury Marine	27-43337A1	440	18-2755	Volvo	875827	1006	
	18-2713	Mercury Marine	27-96286	440	18-2756	Mercury Marine	86840A05	8852	
	18-2714	Mercury Marine	27-414992	440	18-2756	Mercury Marine	86840A3	852	
	18-2714	Mercury Marine	27-414993	440	18-2756	Mercury Marine	8M0062406	852	
	18-2714	Mercury Marine	27-414994	440	18-2757	Volvo	875828	1006	
	18-2714	Mercury Marine	27-414995	440	18-2757	Volvo	876633	1006	
	18-2714	Mercury Marine	27-892157	440	18-2758	Volvo	875848	1006	
	18-2715	Mercury Marine	24-17997A1	851	18-2758	Volvo	876631	1006	
	18-2716	Mercury Marine	27-41499	440	18-2759	Mercury Marine	53114	852	
	18-2716	Mercury Marine	27-414991	440	18-2759	Mercury Marine	53114A1	852	
	18-2716	Mercury Marine	27-92332	440	18-2760	Mercury Marine	78458	852	
	18-2717	Mercury Marine	27-41475	440	18-2760	Mercury Marine	78458A1	852	
	18-2717	Mercury Marine	27-414751	440	18-2761	Mercury Marine	32-90949	852	
	18-2717	Mercury Marine	27-414752	440	18-2761	Mercury Marine	32-90949T	852	
	18-2717	Mercury Marine	27-414753	440	18-2762	Mercury Marine	70981	852	
	18-2717	Mercury Marine	27-414754	440	18-2762	Mercury Marine	70981A3	852	
	18-2717	Mercury Marine	27-414755	440	2	18-2763	OMC	911826	937
	18-2717	Mercury Marine	27-414756	440	18-2764	OMC	914036	937	
	18-2717	Mercury Marine	27-414757	440	18-2765	OMC	983973	937	
	18-2717	Mercury Marine	27-414758	440	18-2765	OMC	987467	937	
	18-2717	Mercury Marine	27-892158	440	18-2765	OMC	3854127	937	
	18-2717	Mercury Marine	27-92331	440	18-2765	Volvo	3854127	1006	
	18-2721	Mercury Marine	27-827284	440	18-2766	Volvo	834751	1006	
	18-2724	Mercury Marine	43713	851	18-2767	OMC	313080	937	
	18-2725	Mercury Marine	26-830749A01	462	18-2768	OMC	909527	937	
	18-2726	Volvo	3888917	1010	1	18-2769	OMC	332000	333
	18-2727	Mercury Marine	60930	753	18-2770	Mercury Marine	32-807458T	852	
	18-2728	Mercury Marine	26-42102	443	18-2771			936	
	18-2728	Mercury Marine	26-421021	443	18-2772-1			936, 1006	
	18-2729	Mercury Marine	27-8128672	438	18-2773	Yamaha	663-45331-00-94	550	
	18-2730-9	Mercury Marine	26-80239M	443	18-2774	Volvo	875847	991	
	18-2731	Mercury Marine	26-81607M	443	18-2775	Volvo	875822	991	
1	18-2732	Mercury Marine	807166A3	753	18-2776	Volvo	832831	991	
	18-2733	Mercury Marine	92802	753	18-2777	Volvo	854031	991	
	18-2733	Mercury Marine	98370A2	753	18-2778	Volvo	832846	991	
	18-2735	Mercury Marine	27-190506	430, 440	18-2779	OMC	3852696	917, 981	
	18-2736	Mercury Marine	27-863891	435	18-2779	Volvo	3852696	917, 981	
	18-2736	Mercury Marine	27-863893	435	18-2780-1	OMC	3852741	981	
	18-2736	Mercury Marine	27-863895	435	18-2780-1	Volvo	3852741	981	
	18-2737	Mercury Marine	27-850283	438	18-2780-1	Volvo	3863450	981	
	18-2739	Mercury Marine	27-832933006	440	18-2780-1	Volvo	3863450	981	
	18-2739	Mercury Marine	27-8329331	440	18-2781	OMC	3852742	917, 981	
	18-2739	Mercury Marine	27-8329332	440	18-2781	Volvo	3852742	917, 981	
	18-2739	Mercury Marine	27-8329333	440	18-2782	Yamaha	688-45331-00-94	550, 559	
	18-2739	Mercury Marine	27-8329334	440	18-2783	OMC	986629	948	
	18-2739	Mercury Marine	27-8329335	440	18-2785	Mercury Marine	27-41899M	462	
	18-2740	Mercury Marine	27-430051	439	18-2785	Yamaha	689-W0001-21-00	565	
	18-2740	Mercury Marine	27-430052	439	18-2785	Yamaha	689-W0001-C1-00	565	
	18-2740	Mercury Marine	27-430053	439	18-2787	Mercury Marine	27-92648M	462	
	18-2740	Mercury Marine	27-430055	439	18-2787	Yamaha	698-W0001-20-00	565	
	18-2740	Mercury Marine	27-430056	439	18-2787	Yamaha	698-W0001-C0-00	565	
	18-2740	Mercury Marine	27-430057	439	18-2788	Yamaha	6H3-W0001-21-00	566	
	18-2741	Mercury Marine	27-43004009	440	18-2788	Yamaha	6H3-W0001-C1-00	566	
	18-2741	Mercury Marine	27-430041	440	18-2789	Yamaha	6J8-W0001-21-00	566	
	18-2741	Mercury Marine	27-430042	440	18-2789	Yamaha	6J8-W0001-C2-00	566	
	18-2741	Mercury Marine	27-430043	440	18-2791	OMC	987251	948	
	18-2741	Mercury Marine	27-430045	440	18-2791	OMC	3850597	948	

1 This product is priced per piece. To order, priced per package, please add -9 to the part number

2 Items ending in "D" are display packaged - regular number is non-display

3 For discount shop pack of 10, please add -10 to the part number

SIERRA #	O.E.M.	O.E. #	PAGE #	SIERRA #	O.E.M.	O.E. #	PAGE #
SIERRA							
18-2791	Volvo	3850597	1011	18-2825	Mercury Marine	27-32771	449, 830
18-2792	Yamaha	6H4-W0001-20-00	566	18-2826	Mercury Marine	27-85610	449, 830
18-2792	Yamaha	6H4-W0001-21-00	566	18-2826	Mercury Marine	27-856101	449, 830
18-2793	Volvo	875550	995	18-2826	Mercury Marine	27-856704	449, 830
18-2794-1	Yamaha	6E5-W0001-51-00	566	18-2827	Mercury Marine	27-39623	449
18-2794-1	Yamaha	6E5-W0001-F1-00	566	18-2828	Mercury Marine	27-39625	449
18-2794-1	Yamaha	6F3-W0001-21-00	566	18-2830-1	Mercury Marine	879036	827
18-2794-1	Yamaha	6F3-W0001-C1-00	566	18-2830-1	Mercury Marine	27-33121	827
18-2794-1	Yamaha	6G5-W0001-21-00	566	18-2830-1	Mercury Marine	27-46401	827
18-2794-1	Yamaha	6G5-W0001-C1-00	566	18-2830-1	Mercury Marine	27-52584	827
18-2798	Yamaha	688-W0001-20-00	566	18-2830-1	OMC	907932	827
18-2798	Yamaha	688-W0001-C0-00	566	18-2831	Mercury Marine	27-47590	827
18-2799	Yamaha	61A-W0001-21-00	566	18-2831	Mercury Marine	27-475901	827
18-2799	Yamaha	61A-W0001-C1-00	566	18-2832-1	Mercury Marine	27-48043	820, 827
18-2800	Mercury Marine	27-26891	437	18-2832-1	Mercury Marine	27-480431	800, 827
18-2800	Mercury Marine	27-69659	437	18-2832-1-9	Mercury Marine	27-48043	820, 827
18-2800	Mercury Marine	27-75791	437	18-2832-1-9	Mercury Marine	27-480431	800, 827
18-2800	Mercury Marine	27-757911	437	18-2833	Mercury Marine	27-52076	827
18-2801	Mercury Marine	27-32438	442	18-2833	Mercury Marine	27-99777	827
18-28019	Chrysler Inboard	3745215	190	18-2833	Mercury Marine	27-997771	827
18-2802	Mercury Marine	27-48164	437	18-2833	Mercury Marine	27-997772	800, 827
18-2802	Mercury Marine	27-481641	437	18-2834	Mercury Marine	27-60208	826
18-2803	Mercury Marine	27-90430	437	18-2835	Mercury Marine	27-60479	441
18-2803	Mercury Marine	27-904301	437	18-2835	Mercury Marine	27-64173	441
18-28033	Mercruiser		190	18-2835	Mercury Marine	27-66101	441
18-2804	Mercury Marine	27-73377	437	18-2835	Mercury Marine	27-69238	432, 441
18-2804	Mercury Marine	27-733771	437	18-2835	Mercury Marine	27-692381	441
18-28042	Universal		190	18-2836	Mercury Marine	27-31439	439
18-28043	Pleasurecraft		190	18-2836	Mercury Marine	27-46233	439
18-28044	Pleasurecraft		190, 191, 580	18-2836	Mercury Marine	27-72919	439
18-28044	Volvo Penta		190, 191, 580	18-2836	Mercury Marine	27-78035	439
18-28046	OMC		190	18-2837	Mercury Marine	27-31436	440
18-28046	Pleasurecraft		190	18-2837	Mercury Marine	27-41382	440
18-2805	Mercury Marine	27-85490-2	433, 439	18-2837	Mercury Marine	27-66358	440
18-28050	Volvo	845363	190, 196, 197, 962, 964, 966	18-2837	Mercury Marine	27-72918	440
18-2806	Mercury Marine	27-65788	439	18-2837	Mercury Marine	27-78087	440
18-2807	Mercury Marine	27-53863	439	18-2838	Mercury Marine	27-55279	439
18-2807	Mercury Marine	27-64940	439	18-2838	Mercury Marine	27-552791	439
18-2807	Mercury Marine	27-72506	439	18-2839	Mercury Marine	27-60477	439
18-2807	Mercury Marine	27-85494	439	18-2839	Mercury Marine	27-72509	439
18-2807	Mercury Marine	27-98185	433, 439	18-2839	Mercury Marine	27-85497	439
18-2807	Mercury Marine	27-981851	439	18-2839	Mercury Marine	27-854972	439
18-2807	Mercury Marine	27-9818512	439	18-2840	Mercury Marine	27-35982	829
18-2807	Mercury Marine	27-981853	439	18-2841	Mercury Marine	27-19552	442
18-2808	Mercury Marine	27-96278	439	18-2841	Mercury Marine	27-77417	4442
18-28080	Mercury	84-821945A56	381	18-2841	Mercury Marine	27-74830	826
18-28081	Mercury	84-813706A56	381	18-2844	Mercury Marine	27-48818	826
18-28082	Mercury	84-813715A8	381	18-2844	Mercury Marine	27-488181	826
18-28083	Mercury	84-881908T	189, 381	18-2844	Mercury Marine	27-48818Q1	826
18-28084	Mercury	84-881908T	189, 381	18-2845	Chris-Craft	16.11-01236	589
18-28085	Mercury	84-881908T	189, 381	18-2845	Crusader	91351	530
18-28086	Mercury	84-881908T	189, 381	18-2845	Mercury Marine	27-11999	828
18-2809	Mercury Marine	27-43779	434, 441	18-2845	Mercury Marine	27-34043	828
18-2809	Mercury Marine	27-437791	434, 441	18-2845	Mercury Marine	27-52202	828
18-2809	Mercury Marine	27-437792	434, 441	18-2845	Mercury Marine	F11101236	828
18-2809	Mercury Marine	27-96485	434, 441	18-2845	Mercury Marine	F15000161	828
18-28090	Johnson/Evinrude		189, 276	18-2845	OMC	912965	827
18-28092	Johnson/Evinrude		276	18-2847	Mercury Marine	27-54014	929
18-2810	Mercury Marine	27-43777	440	18-2847	Mercury Marine	27-54014A1	829
18-2810	Mercury Marine	27-437771	440	18-2847	Mercury Marine	27-54014Q1	829
18-2810	Mercury Marine	27-437772	440	18-2847	Mercury Marine	27-54014T1	829
18-2810	Mercury Marine	27-96483	440	18-2848	Mercury Marine	18-52457	826
18-28100			190, 652	18-2848	Mercury Marine	18-524571	826
18-28101			190, 652	18-2848	Mercury Marine	27-524572	826
18-28102			190, 652	18-2849-1	Mercury	27-860232	827
18-2813	Volvo	876302	999	18-2849-1	Mercury	27-863726	827
18-2814	Volvo	876306	999	18-2849-1	Mercury	27-87105	827
18-2815	Mercury Marine	27-814703	829	18-2849-1	Mercury Marine	27-818832	827
18-2815	Mercury Marine	F15000119	999	18-2849-1	Mercury Marine	27-871051	827
18-2815	Mercury Marine	F15000199	928	18-2850-1	OMC	908935	928
18-2815	OMC	913276	928	18-2851	OMC	313368	928
18-2815	OMC	3852692	928	18-2852	OMC	330621	320
18-2815	Volvo	3852692	1002	18-2853	OMC	318925	329
18-28150			184, 662	18-2854-1	Barr	01-0107	589, 629, 649, 800, 918
18-28151			184, 662	18-2855	OMC	314082	332
18-2817	Volvo	876359	1001	18-2856	OMC	319665	331
18-28175			184, 663	18-2857	OMC	319771	328
18-2818	Volvo	876433	1001	18-2857	OMC	386573	328
18-2819-1	Mercury Marine	27-39915	800	18-2858	OMC	314809	925
18-2820	Mercury Marine	27-45821	892	18-2858	Volvo	3852127	1002
18-2820	Mercury Marine	27-64818	892	18-2859	OMC	311131	926
18-2820	Mercury Marine	27-64818A1	892	18-2860	OMC	311130	926
18-2820	Mercury Marine	27-64818A20	892	18-2861-1	OMC	311121	926
18-2820	Mercury Marine	27-64818A4	892	18-2862	OMC	321573	329
18-2820	Mercury Marine	27-64818Q4	832	18-2862	OMC	326260	329
18-2823	Mercury Marine	27-19553	449, 830	18-2863	OMC	308799	928
18-2823	Mercury Marine	27-32769	449, 830	18-2864	OMC	321727	330
18-2824	Mercury Marine	27-19551	449, 830	18-2865	OMC	313763	330
18-2824	Mercury Marine	27-32770	449, 830	18-2866	OMC	317914	329

1 This product is priced per piece. To order, priced per package, please add -9 to the part number

2 Items ending in "D" are display packaged - regular number is non-display

3 For discount shop pack of 10, please add -10 to the part number

SIERRA #	O.E.M.	O.E. #	PAGE #	SIERRA #	O.E.M.	O.E. #	PAGE #
SIERRA							
1	18-2867	OMC	319174	3239	18-2917	Mercury Marine	F1101276 826
1	18-2868	OMC	310137	330	18-2917	Mercury Marine	F11010291 826
1	18-2869	OMC	305312	333	18-2917	Mercury Marine	F15000096 826
1	18-2870	OMC	305176	Obsolete	18-2917	OMC	312797 925
1	18-2871	OMC	304762	329	18-2918	OMC	911836 929
1	18-2872	OMC	307257	331	18-2918	OMC	915840 929
1	18-2872	OMC	318334	331	18-2919	Mercury Marine	27-42631 443, 830
1	18-2873	OMC	318335	331	18-2919	Mercury Marine	27-426311 443, 830
1	18-2874	OMC	314876	332	18-2922	Volvo	418870 Obsolete
1	18-2875-1	OMC	908013	928, 936	18-2923	Volvo	419678 1003
1	18-2875-1	OMC	3850495	928, 936	18-2924	Volvo	430039 1003
1	18-2875-1	Volvo	3850495	989	18-2925	Volvo	461092 1002
1	18-2875-1-9	OMC	908013	918	18-2925	Volvo	1378913 1002
1	18-2875-1-9	OMC	3850495	918	18-2926	Volvo	463587 1003
1	18-2875-1-9	Volvo	3850495	918	18-2926	Volvo	1378864 1003
1	18-2876	OMC	307133	321	18-2927	Volvo	463999 1003
1	18-2877	OMC	314421	320	18-2927	Volvo	1378909 1003
1	18-2878	OMC	319710	320	18-2928	Volvo	824633 1002
1	18-2879	OMC	312634	328	18-2928	Volvo	856044 1002
1	18-2879	OMC	331363	328	18-2929	Volvo	856028 1005
1	18-2879	OMC	338876	328	18-2930	Volvo	1266796 1002
1	18-2880	OMC	304023	332	18-2930	Volvo	1378879 1002
1	18-2881	OMC	125530	334	18-29322	Volvo	3854215 958
1	18-2881	OMC	332403	334	18-29322	Volvo	3854217 958
1	18-2883-1	OMC	907775	926	18-29322	Volvo	3854217 958
1	18-2884	OMC	313782	324, 326	18-2933	Volvo	416033 638, 883, 1002
1	18-2885	OMC	303438	324, 326	18-2933	Volvo	1317466 1002
1	18-2886	OMC	203171	330	18-2934	Volvo	829714 1004
1	18-2887	OMC	302557	334	18-2935	Volvo	418411 1004
1	18-2888	OMC	326953	324, 326	18-2936	Volvo	418445 1004
1	18-2888	OMC	332010	324, 326	18-2937	Volvo	418412 1004
1	18-2889	OMC	302675	328	18-2938	OMC	331917 330
1	18-2890	OMC	302994	327	18-2939	Volvo	814356 1005
1	18-2890	OMC	331203	327	18-2941	Chrysler Inboard	2469559 606
1	18-2890	OMC	338886	327	18-2941	Chrysler Inboard	2847480 606
1	18-2891	OMC	303339	333	18-2943	Mercury Marine	27-443281 439
1	18-2892	OMC	303355	328	18-2943	Mercury Marine	27-443282 439
1	18-2893	OMC	303750	327	18-2943	Mercury Marine	27-443283 439
1	18-2894	OMC	304314	330	18-2943	Mercury Marine	27-443284 439
1	18-2896-1	Mercury Marine	27-32816	800, 828	18-2944	Mercury Marine	26-45577 830
1	18-2896-1	Mercury Marine	27-52546	800, 801, 828	18-2944	Mercury Marine	26-455771 830
1	18-2896-1	OMC	311068	928, 936	18-2945	Mercury Marine	12-19183 443, 830
1	18-2898	OMC	309956	330	18-2945	Mercury Marine	12-191832 443, 830
1	18-2900	OMC	312679	328	18-2945	Mercury Marine	12-191833 443, 830
1	18-2900	OMC	332694	328	18-2945	Mercury Marine	12-20260 443, 830
1	18-2900	OMC	338879	328	18-2945	Mercury Marine	F50556 443, 830
1	18-2901	OMC	306205	331	18-2945	Mercury Marine	F8077 443, 830
1	18-2901	OMC	313065	331	18-2945	Mercury Marine	F8186 443, 830
1	18-2902-1	OMC	909314	928	18-2945	OMC	307552 346, 929
1	18-2902-1	Volvo	3852468	990	18-2945	OMC	307552 266, 1005
1	18-2902-1-9	OMC	909314	918	18-2945-9		266, 346, 830, 1005
1	18-2902-1-9	Volvo	3852468	990	18-2946	Chris-Craft	16.50-00204 589
1	18-2903	OMC	332696	327	18-2946	Mercury Marine	27-52364 825
1	18-2903	OMC	338880	327	18-2946	Mercury Marine	27-81084 825
1	18-2904	OMC	319348	331	18-2946	Mercury Marine	F15000204 825
1	18-2905	OMC	329920	321, 331	18-2946	OMC	908611 925
1	18-2906	OMC	333418	327	18-2946	OMC	3853336 925
1	18-2906	OMC	338884	327	18-2946	Volvo	908611 1000
1	18-2907	OMC	325721	321, 331	18-2946	Volvo	3853336 1000
1	18-2908	OMC	331499	327	18-2947	OMC	310913 926
1	18-2908	OMC	338878	327	18-2948	Mercury Marine	12-23245 443, 830
1	18-2909	Crusader	97498	629	18-2948	Mercury Marine	12-49221 443, 830
1	18-2909	Mercury Marine	27-99757	828	18-2948	Mercury Marine	12-492211 443, 445, 830
1	18-2909	OMC	915025	927	18-2949	Barr	CHV-47-000 918
1	18-2909	Volvo	856116	988	18-2949	Crusader	96306 629
1	18-2909	Volvo	3853412	988	18-2949	Mercury Marine	27-33395 800, 828
1	18-2909	Yamaha	YSC-12190-00-AC	1013	18-2949	Volvo	835966 1002
1	18-2909			636	18-2949	Volvo	856034 1002
1	18-2911	OMC	910236	928, 946	18-2950	OMC	309612 324
1	18-2912-1	Mercury Marine	27-53354	800, 828	18-2950	OMC	766870 324
1	18-2912-1	OMC	908079	926	18-2951	OMC	304720 324
1	18-2913	OMC	319097	330	18-2952	OMC	203034 324
1	18-2913	OMC	331916	330	18-2954	OMC	319633 324
1	18-2914	Mercury Marine	27-30603	443, 830	18-2956	OMC	318358 324
1	18-2914	Mercury Marine	27-32433	443, 830	18-2957	OMC	307069 324
1	18-2914	Mercury Marine	27-85608	443, 830	18-2958	OMC	315539 324
1	18-2914	Mercury Marine	27-856081	443, 830	18-2959	OMC	306048 324
1	18-2914	Mercury Marine	27-8M0090319	443, 830	18-2960	OMC	313413 324
1	18-2915	Mercury Marine	27-30604	443, 830	18-2961	OMC	329103 324
1	18-2915	Mercury Marine	27-32434	443, 830	18-2962	OMC	322332 324
1	18-2915	Mercury Marine	27-85609	443, 830	18-2963	OMC	318914 324
1	18-2915	Mercury Marine	27-856091	443, 830	18-2963	OMC	320533 324
1	18-2915	Mercury Marine	27-858524	443, 830	18-2963	OMC	330818 324
1	18-2915	Mercury Marine	27-858524	443, 830	18-2964	OMC	320745 325
1	18-2916	OMC	911702	928	18-2964	OMC	335360 325
1	18-2917	GM	3701777	925	18-2964	OMC	766779 325
1	18-2917	Mercury Marine	27-33179	826	18-2965	Volvo	418310 1000
1	18-2917	Mercury Marine	27-53045	826	18-2965	Volvo	419763-8 1000
1	18-2917	Mercury Marine	27-530451	826	18-2966	Volvo	462623 1000
1	18-2917	Mercury Marine	F10077105	826	18-2968	Volvo	1378645 1000

1 This product is priced per piece. To order, priced per package, please add -9 to the part number

2 Items ending in "D" are display packaged - regular number is non-display

3 For discount shop pack of 10, please add -10 to the part number

SIERRA #	O.E.M.	O.E. #	PAGE #	SIERRA #	O.E.M.	O.E. #	PAGE #
SIERRA							
18-2970	Volvo	1378646	1000	18-3037	Volvo	875736	982
18-2971-1	Volvo	835908-5	990	18-3037	Volvo	2430184	982
18-2971-1	Volvo	856039-3	990	18-3038	Jabsco	17937-0003	573
18-29716	Mallory	29716	662	18-3038	Jabsco	920-0003	573
18-29717	Mallory	29217	662	18-3038	Johnson Pump	09-1028B-9	575
18-2972	Volvo	1378870	1003	18-3038	Volvo	3841697	982
18-29720	Volvo	1378870	1003	18-3038	Volvo	877061-2	982
18-29720	Mallory	29440M	662	18-3038	Volvo	47-39074	410
18-29723			662	18-3039	Mercury Marine	47-65957	410
18-2974	Volvo	418265	1002	18-3039	Mercury Marine	47-89981	410
18-2980	Volvo	875401	1000	18-3040	Yamaha	63V-44352-01-00	513
18-2980	Volvo	876356	1000	18-3042	Yamaha	67F-44352-00-00	513
18-2982	Volvo	875569	1000	18-3043	OMC	389642	294
18-2982	Volvo	876358	1000	18-3044	OMC	385072	294
18-2983	Volvo	875400	1000	2	18-3046	Crusader	1003062
18-2983	Volvo	876342	1000	2	18-3046	Jabsco	18838-0001
18-2989	Volvo	824677	1002	2	18-3046	Sherwood Pump	9959K
18-2990	Volvo	832669	1005	2	18-3046	Volvo	3854286
18-2991-1	Volvo	855383	1002	2	18-3047	Jabsco	18948-0001
18-2991-1	Volvo	855967	990, 1002	2	18-3047	Sherwood Pump	10615K
18-2991-1-9	Volvo	855383	990, 1002	2	18-3047	Volvo	835874
18-2991-1-9	Volvo	855967	990, 1002				982
18-2994	Volvo	430020	Obsolete				597, 629
18-2995	Volvo	856037	1002	18-3049	Suzuki	17461-87E11	482
18-2996	OMC	911823	929	18-3049	Suzuki	17461-87E12	482
18-2996	OMC	3852560	929	3	18-3050	OMC	386084
18-2996	Volvo	3852560	1005	3	18-3051	OMC	395289
18-2998	Volvo	876300	1000	3	18-3052	Mercury Marine	47-56780
18-3000	Suzuki	17461-92D02	482	3	18-3052	Mercury Marine	47-65958
18-3001	OMC	277181	294	3	18-3052	Mercury Marine	47-89982
18-3001	OMC	434424	294	3	18-3053-1	OMC	396725
18-3002	OMC	375638	294	3	18-3054	Mercury Marine	47-68988
18-3002	OMC	775518	294	3	18-3054	Mercury Marine	47-89980
18-3003	OMC	377178	Obsolete	3	18-3055	OMC	389589
18-3003	OMC	775519	Obsolete	3	18-3056	Chrysler Force	47-430262
18-3006	OMC	378891	294	3	18-3056	Honda	19210-ZW1-003
18-3006	OMC	775521	294	3	18-3056	Mercury Marine	47-430261
3	18-3007	Mercury Marine	47-89983	3	18-3056	Mercury Marine	47-430262
3	18-3007	Mercury Marine	47-89983T	3	18-3056	Mercury Marine	47-430264
18-3008	Mercury Marine	47-20813	410	3	18-3056	Mercury Marine	47-430262T
18-3008	Mercury Marine	47-25287	410	3	18-3057	Chrysler Force	47-85089-3
18-3012	Mercury Marine	47-22748	410	3	18-3057	Mercury Marine	47-85089-3
18-3013	Mercury Marine	26-821309	411	3	18-3058	OMC	983895
18-3014	Mercury Marine	26-821310	411		18-30585	OMC	3854072
18-3015	OMC	396852	294	3	18-3059	OMC	381538
18-3015	OMC	433935	294	3	18-3059	OMC	389289
18-3015	OMC	797407	294	3	18-3059	OMC	394534
18-3016-1	Mercury Marine	47-862232A2	752	3	18-3059	OMC	395864
18-3016-1	Mercury Marine	8M0104229	752	3	18-3059	OMC	397131
3	18-3017	Chrysler Force	47-803631T	3	18-3059	OMC	435748
3	18-3017	Chrysler Force	47-89984T4	3	18-3059	OMC	435821
3	18-3017	Chrysler Force	47-F694065	3	18-3059	OMC	439948
3	18-3017	Mercury Marine	47-30221	3	18-3059	OMC	5001593
3	18-3017	Mercury Marine	47-65960	3	18-3060	Crusader	22212
3	18-3017	Mercury Marine	47-85460	3	18-3060	Crusader	1003026
3	18-3017	Mercury Marine	47-89984	3	18-3060	Jabsco	18838-0001
3	18-3017	Mercury Marine	47-899842	3	18-3060	Oberdorfer	132-0317
3	18-3017	Mercury Marine	47-899844	3	18-3060	OMC	3854286
3	18-3017	Mercury Marine	47-89984T3	3	18-3060	Pleasurecraft	RP061015
3	18-3017	Mercury Marine	47-89984T4	3	18-3060	Sherwood Pump	9959
18-3020	Jabsco	1210-0003	574	18-3060	Volvo	835512	982
18-3020	Johnson Pump	09-1027B-9	575	18-3060	Volvo	3854286	982
18-3021	Jabsco	4598-0001	574	18-3061	Crusader	20300	628
18-3021	Oberdorfer	6603	576	18-3061	Jabsco	18948-0001	982
18-3022	Honda	90752-ZW9-A30	263	18-3061	Oberdorfer	8922	676
18-3023	Suzuki	17461-90J00	482	18-3061	Pleasurecraft	RP061017	545
18-3023	Suzuki	17461-90J01	482	18-3061	Sherwood Pump	10615	575, 597, 646
18-3023	Suzuki	17461-94500	482	18-3061	Volvo	835874	982
18-3023	Suzuki	17461-94501	482	18-3062	Chrysler Force	47-42038-2	248
18-3023	Suzuki	17461-94502	482	18-3062	Mercury Marine	47-420381	410
18-3023	Suzuki	17461-94503	482	18-3062	Mercury Marine	47-420382	410
18-3023	Suzuki	17461-94504	482	18-3062	Mercury Marine	47-42038Q02	410
18-3023	Suzuki	17461-94505	482	18-3063	Mercury Marine	47-81242M	410
18-3023	Suzuki	17461-94506	482	18-3063	Mercury Marine	47-95611M	410
18-3023	Suzuki	17461-94510	482	18-3063	Yamaha	662-44352-01-00	513
18-3023	Suzuki	17461-94511	482	18-3065	Yamaha	6L2-44352-00-00	513, 521
18-3023	Suzuki	17461-94520	482	18-3066	Mercury Marine	47-11590M	410
18-3025	Honda	90752-ZW9-A30	263	18-3066	Yamaha	6G1-44352-00-00	513, 521
18-3026	Johnson/Evinrude	331130	303	18-3067	Mercury Marine	47-81604M	410
18-3028	Yamaha	6AW-44336-00	522	18-3067	Mercury Marine	47-84797M	410
18-3030	Chrysler Force	47-803630T	247	18-3067	Yamaha	689-44352-02-00	513
18-3030	Chrysler Force	F523065	247	18-3068	Yamaha	6H4-44352-02-00	513
18-3030	Chrysler Force	F523065-1	247	18-3069	Mercury Marine	47-81423M	513
18-3031	Honda	19210-ZY3-003	262	18-3069	Mercury Marine	47-82824M	410
18-3035	Suzuki	17461-93J00	482	18-3069	Mercury Marine	47-97108M	410
18-3036	Jabsco	673-0003	573	18-3069	Yamaha	697-44352-00-00	528-531
18-3036	Johnson Pump	09-1026B-9	574	18-3069	Yamaha	6H3-44352-00-00	528-531
18-3036	Volvo	875808-8	983	18-3070	Yamaha	688-44352-03-00	513
18-3037	Jabsco	836-0003	573	18-3071	Yamaha	6E5-44352-01-00	513
18-3037	Johnson Pump	09-1029B-9	574	18-3072	Mercury Marine	47-80395M	410
18-3037	Volvo	875660	982	18-3072	Yamaha	646-44352-01-00	513

1 This product is priced per piece. To order, priced per package, please add -9 to the part number

2 Items ending in "D" are display packaged - regular number is non-display

3 For discount shop pack of 10, please add -10 to the part number

SIERRA #	O.E.M.	O.E. #	PAGE #	SIERRA #	O.E.M.	O.E. #	PAGE #	
SIERRA								
	18-3073	Mercury Marine	47-96305M	410	18-3099	Suzuki	17461-93903	483
	18-3073	Yamaha	6E0-44352-00-00	528-531	18-3100	Honda	19210-ZW9-003	262
	18-3074	Mercury Marine	47-84027M	410	18-3100	Honda	19210-ZW9-013	262, 283
	18-3074	Mercury Marine	47-84027T	410	18-3102	OMC	305303	295
	18-3074	Mercury Marine	47-96619M	410	18-3103	OMC	303069	295
	18-3074	Yamaha	682-44352-01-00	513	18-3104-1	OMC	432941	295
2	18-3075	Jabsco	124310-46090	573	18-3104-1	OMC	4370759	295
2	18-3075	Jabsco	14510-46090	573	18-3104-1	OMC	765350	295
2	18-3075	Jabsco	2877-0001	573	18-3106	Volvo	806256	981
2	18-3075	Jabsco	4568-0001	573	18-3106	Volvo	831009	981
2	18-3075	Johnson Pump	09-801B	574	18-3107	Mercury Marine	32768	411
2	18-3075	Oberdorfer	B6620	575	18-3107	Mercury Marine	54705	411
2	18-3075	Volvo	875575	982	18-3108	OMC	308928	908
	18-3076	Jabsco	22405-0001	573	18-3109	Mercury Marine	23-29804	411, 752
	18-3076	Johnson Pump	09-45589	575	18-3109	Mercury Marine	23-29804T	411, 752
	18-3076	Johnson Pump	09-808B	575	18-3109	Mercury Marine	23-52928	411, 752
	18-3076	Volvo	833995	982	18-3110	Mercury Marine	26-29677	411, 752
	18-3076	Volvo	875583	982	18-3110	Mercury Marine	26-36557A1	411, 752
	18-3077	Cummins	650607	574	18-3110	Mercury Marine	26-38970	411, 752
	18-3077	Jabsco	920-0001	573	18-31104	Indmar	S525009	Obsolete
	18-3077	Johnson Pump	09-1028B	574	18-3111	OMC	907774	908
	18-3077	Oberdorfer	C7441	575	18-3113	Mercury Marine	70977	411
	18-3077	Sherwood Pump	18200	575	18-3114	Mercury Marine	48752	411, 752
	18-3077	Volvo	3841697	982	18-3114	Mercury Marine	48752T	411, 752
	18-3077	Volvo	877061-2	982	18-3115	Mercury Marine	48753	411
	18-3077	Yanmar	127610-42200	574	18-3116	Mercury Marine	46-48743A1	411, 752
	18-30778	Volvo	21213664	982	18-3116	Mercury Marine	46-64141A1	411, 752
	18-3078	Cummins	160596	573	18-3116	Mercury Marine	46-96148	411, 752
	18-3078	Cummins	166758	573	18-3116	Mercury Marine	46-96148A1	411, 752
	18-3078	Cummins	556540	573	18-3116	Mercury Marine	46-96148T1	411, 752
	18-3078	Cummins	556850	573	18-3117	Mercury Marine	30605	411, 752
	18-3078	Cummins	21601R	573	18-3117	Mercury Marine	32435	411, 752
	18-3078	Jabsco	836-0001	573	18-3117	Mercury Marine	324351	411, 752
	18-3078	Johnson Pump	09-1029B	574	18-3118	Mercury Marine	46-48746A1	411
	18-3078	Oberdorfer	7054	575	18-3118	Mercury Marine	46-48746A3	411
	18-3078	Volvo	875660	982	18-3118	Mercury Marine	46-77822A1	411
	18-3078	Volvo	875736	982	18-3119	OMC	983298	908
	18-3078	Volvo	2430184	982	18-3121	OMC	911703	9098
	18-3079	Jabsco	4528-0001	573	18-3122	Honda	19231-ZW1-003	262
	18-3079	Johnson Pump	09-806B	574	18-3122	Mercury Marine	817276	411, 752
	18-3079	Sherwood Pump	9979K	983	18-3122	Mercury Marine	8172761	411, 752
	18-3079	Volvo	3586498	983	18-3122	Mercury Marine	8172763	411, 752
	18-3079	Volvo	875807-0	983	18-3125	Jabsco	3101-0000	574
	18-3079	Yanmar	104211-42070	574	18-3125	Johnson Pump	3298-0000	575
	18-3080	Jabsco	673-0001	573	18-3126	OMC	321940	296
	18-3080	Johnson Pump	09-1026B	574	18-3127	OMC	319275	296
	18-3080	Johnson Pump	09-1026B-1	983	18-3129	OMC	432965	297
	18-3080	Johnson Pump	09-1026B-9	574	18-3129	OMC	435673	297
	18-3080	Volvo	875808	983	18-3129	OMC	436954	297
	18-3081	Jabsco	1210-0001	573	18-3129	OMC	438591	297
2	18-3081	Johnson Pump	09-1027B	574	18-3133	OMC	331979	327
2	18-3081	Volvo	3858256	983	18-3135	OMC	306643	3247
2	18-3081	Volvo	3862281	983	18-3136	OMC	323626	327
2	18-3081	Volvo	875811-2	983	18-3138	OMC	334897	296
2	18-3081			646	18-3139	Mercury Marine	46895	411
2	18-3082	OMC	382547	259	18-3140	Crusader	20502	618
	18-3083	OMC	377230	259	18-3140	Sherwood Pump	10931	618
	18-3083	OMC	777213	259	18-3141	OMC	313176	908
	18-3084	Chrysler Force	47-F40065-2	248	18-3142	Yamaha	68T-44323-00-00	519
	18-3085	Chrysler Force	47-F84065	248	18-3143	Yamaha	67F-44323-00-00	520
	18-3086	OMC	379475	906	18-3145	OMC	911844	909
	18-3086	OMC	777130	906	18-3147	Mercury Marine	817275K05	754
	18-3087	Mercury Marine	47-59362	752	18-3147	Mercury Marine	817275T4	754
	18-3087	Mercury Marine	47-59362T	752	18-3148	Mercury Marine	46-84277M	415
	18-3088	Yamaha	6F5-44352-00-00	513	18-3148	Mercury Marine	46-84277T	415
	18-3089	Johnson Pump	09-45825	575, 983	18-3148	Yamaha	682-W0078-A1-00	516
	18-3090	OMC	387361	259	18-3149-2	Mercury Marine	46-42040A1	412
	18-3090	OMC	763735	259	18-3149-2	Mercury Marine	46-42040A3	412
	18-3091	OMC	389576	259	18-3149-2	Mercury Marine	46-42040A5	412
	18-3092	Suzuki	17461-93001	482	18-3150	Mercury Marine	46-807151A14	754
	18-3092	Suzuki	17461-93003	482	18-3150	Mercury Marine	46-807151A7	754
	18-3092	Suzuki	17461-93004	482	18-3151	Mercury Marine	816597	411, 753
	18-3094	Suzuki	17461-94700	483, 484	18-3153	OMC	908158	303, 326
	18-3094	Suzuki	17461-94701	483	18-3154	Mercury Marine	826763A	411
	18-3095	Suzuki	17461-95300	483, 484	18-3155	Mercury Marine	47-72774A89	754
	18-3095	Suzuki	17461-95301	483	18-3160-1	Mercury Marine	46-862914A13	754, 755
	18-3095	Suzuki	17461-95302	483	18-3162	Yamaha	67F-44322-00-00	520, 524
	18-3096	Suzuki	17461-96301	483	18-3163	Yamaha	6L5-44323-00-00	525
	18-3096	Suzuki	17461-96311	483, 484	18-3164	Yamaha	6L5-44322-00-00	523, 525
	18-3096	Suzuki	17461-96312	483	18-3166	Yamaha	6E0-44366-00-00	516
	18-3096	OMC	5031417	295	18-3168	Chrysler Inboard	10927	Obsolete
	18-3097	Suzuki	17461-98501	483	18-3168	Crusader	20309	Obsolete
	18-3097	Suzuki	17461-98502	483	18-3168	Sherwood Pump	10927	Obsolete
	18-3097	Suzuki	17461-98503	483	18-3169	Crusader	40057	Obsolete
	18-3097	Suzuki	17461-985M0	483	18-3169	Sherwood Pump	12322	Obsolete
	18-3098	Mercury Marine	47-16154	410	18-3169	Sherwood Pump	12859	Obsolete
	18-3098	Mercury Marine	47-161543	410	18-3170	Yamaha	6E5-44311-00-00	514
	18-3099	OMC	5033112	295	18-3171	Yamaha	688-44311-01-00	514
	18-3099	Suzuki	17461-93901	483	18-3173-1	Yamaha	61A-44311-00-00	514
	18-3099	Suzuki	17461-93902	483	18-3173-1	Yamaha	61A-44311-01-00	514

1 This product is priced per piece. To order, priced per package, please add -9 to the part number

2 Items ending in "D" are display packaged - regular number is non-display

3 For discount shop pack of 10, please add -10 to the part number

SIERRA #	O.E.M.	O.E. #	PAGE #	SIERRA #	O.E.M.	O.E. #	PAGE #	
SIERRA								
18-3175	Volvo	858467	978	18-3243	Suzuki	17400-94701	484	
18-3176	Yamaha	68T-44366-00-00	516	18-3244	Suzuki	17400-95350	484	
18-3178	OMC	318995	296	18-3244	Suzuki	17400-95351	484	
18-3179	OMC	324097	296	18-3244	Suzuki	17400-95550	484	
18-3180	OMC	435390	297	18-3245	Honda	19210-881-A01	262	
18-3182	OMC	317841	296	18-3245	Honda	19210-881-A02	262	
18-3185	Yamaha	61N-44311-00-00	514	18-3245	Honda	19210-ZW9-A02	262	
18-3185	Yamaha	61N-44311-01-00	514	18-32455	Honda	19210-ZW9-A31	262	
18-3186	Yamaha	63D-44323-00-00	519	18-32455	Honda	19210-ZW9-A32	262	
18-3187	Honda	06192-ZW1-305	262	18-3246	Honda	19210-ZV4-013	262	
18-3188	Suzuki	17471-98503	483	18-3246	Honda	19210-ZV4-651	262	
18-3189	Suzuki	17471-87D01	483	18-3247	Honda	19210-ZV4-651	262, 263	
18-3190	Suzuki	17471-93902	483	18-3248	Honda	19210-ZV5-003	262	
18-3191	Suzuki	17471-94501	483	18-3249	Honda	19210-ZV7-003	262	
18-3192	Suzuki	17471-87E01	483	18-3250	Honda	19210-ZW1-B04	262, 263	
18-3192	Suzuki	17471-92J00	483	2	18-3251		248	
18-3193	Suzuki	17471-92D10	483	18-3252	Mercury Marine	47-89982T1	413	
18-3194	Yamaha	61N-44323-00	522	18-3253	Suzuki	17400-87D11	484	
18-3195	Yamaha	63V-44323-00-00	518	18-3254	Suzuki	17400-87E03	484	
18-3196	Yamaha	66T-44323-00-00	519	18-3254	Suzuki	17400-87E04	484	
18-3197	Mercury Marine	10-67373	753, 831	18-3255	Suzuki	17400-92D01	484	
18-3197	Mercury Marine	10-76156	753, 831	18-3256	Suzuki	17400-93951	484	
18-3198	Mercury Marine	93424	861	18-3257	Suzuki	17400-94611	484	
18-3198	Mercury Marine	934241	861	18-3258	Suzuki	17400-90J11	484	
18-3198	Mercury Marine	934243	861	18-3258	Suzuki	17400-90J20	484	
18-3199	Mercury Marine	93423	839, 861	18-3259	Suzuki	17400-98551	484	
18-3199	Mercury Marine	934231	839, 861	18-3260	Suzuki	17400-98652	484	
18-3199	Mercury Marine	934233	839, 861	18-3261	Volvo	875769	983	
1	18-3200	Chrysler Force	F697140	457	18-3262	Volvo	875759	983
1	18-3200	Honda	90508-ZW1-003	268	18-3263	Volvo	875698	983
1	18-3200	Mercury Marine	14-31210	457	18-3264	Suzuki	17400-93J00	484
1	18-3200	Mercury Marine	14-816629	457	18-3264	Suzuki	17400-93J02	484
1	18-3200	Mercury Marine	14-816629Q	457	18-3265	Mercury Marine	47-43026Q06	413
1	18-3200	Mercury Marine	14-F697140	457	18-3265	Mercury Marine	47-43026T11	413
1	18-3200	Pleasurecraft	R096117	650	18-3265	Mercury Marine	47-8M0100526	413
1	18-3201	OMC	379763	297	18-3266	Suzuki	17400-98661	484
1	18-3202			297	18-3267	Suzuki	17400-98J00	484
1	18-3203	OMC	379766	297	18-3267	Suzuki	17400-98J01	484
1	18-3204	Mercury Marine	14-76281	457	18-3268	Honda	90752-ZV4-650	262
1	18-3205	Volvo	875574	983	18-3269	Honda	90752-ZV7-000	262
1	18-3206	OMC	984744	908	18-3270	Honda	90752-ZV5-003	262
2	18-3207	Mercury Marine	47-89983Q1	412	18-3271	Honda	90752-ZW1-B02	262
2	18-3207	Mercury Marine	47-89983T2	412	18-3273	Honda	90752-ZY3-003	263
1	18-3208	Volvo	875584	983	18-3274	Volvo	808007	982
1	18-3209	Volvo	875383	983	18-3275	Jabsco	17935-0001	573
1	18-3210			297	18-3275	Johnson Pump	09-819B	574
2	18-3211			298	18-3275	Volvo	877066	982
2	18-3212-1	OMC	984461	909	18-3276-1	Volvo	3862567	982
2	18-3214	Chrysler Force	46-43024A7	248	18-3276-1	Volvo	21213660	982
2	18-3214	Honda	19021-ZW1-003	262	18-3277	Johnson Pump	09-102BB	982
2	18-3214	Mercury Marine	47-43026T11	412	18-3277	Volvo	3862281	982
2	18-3214	Mercury Marine	47-43026T6	412, 754	18-3277	Yanmar	192470-42530	982
2	18-3214	Mercury Marine	47-43026T8	412	18-3277	Yanmar	192470-42532	982
2	18-3215	Mercury Marine	47-85089T7	412	18-3278	Honda	06192-ZV1-C00	263
2	18-3215			248	18-3279	Honda	06192-881-C00	263
1	18-32150			633, 645	18-3280	Honda	06192-ZV4-000	263
1	18-32151			633, 645	18-3281	Honda	06192-ZV7-000	263
1	18-32152	Ilmor	S556162	633	18-3282	Honda	06192-ZV5-003	263
1	18-32152	Indmar	S556162	633	18-3283	Honda	06192-ZW1-000	263
1	18-32152	Malibu	S556162	633	18-3284	Honda	06192-ZY6-000	263
1	18-32153	Honda	35655-ZY3-C01	261	18-3285	Honda	06192-ZY3-000	263
1	18-32153	Honda	35655-ZZ5-004	261	18-3286			909
1	18-32154	Suzuki	18213-98J00	481	18-3287	Volvo	876120	982
1	18-3216	Mercury Marine	47-59362A4	754	18-3288	Honda	91252-ZV1-003	266
2	18-3217			413, 754	18-3288	Volvo	3852315	1011
1	18-3219	Mercury Marine	32489	850	18-3289	Mercury Marine	26-864319	830
1	18-3219	Mercury Marine	32489A2	850	18-3290	OMC	321886	293
1	18-3219	Mercury Marine	42724A3	850	18-3291	Suzuki	09420-05006	483
1	18-3220	Mercury Marine	32-54236	753	18-3291	Suzuki	09420-05009	483
1	18-3221	Mercury Marine	32-814384	753	18-3292	Suzuki	09420-03005	483
1	18-3221	Mercury Marine	32-860220	753	18-3292	Suzuki	17462-93990	483
1	18-3222	Mercury Marine	23-816583	753	18-3293	Mercury Marine	28-43037	411, 753
1	18-3223-9			588, 606, 628, 649, 801, 916, 990	18-3294	Mercury Marine	28-81603M	Obsolete
1	18-3226	Mercury Marine	10-30720	753	18-3295	OMC	330619	296
1	18-3227-9	Mercury Marine	17-35973	411, 753	18-3295	OMC	344470	296
1	18-3229	Mercury Marine	10-28668	753	18-3296	Suzuki	09420-05005	483
1	18-3230	Mercury Marine	10-816601	831	18-3297	Yamaha	90280-03M03-00	515
12	18-3231	Mercury Marine	10-98794	835	18-3299	OMC	331107	296
12	18-3232	Mercury Marine	19-47579	871	18-3300	Mercury Marine	28-83444M	411
12	18-3232	Mercury Marine	19-475791	871	18-3300	Yamaha	90280-04M00-00	411
12	18-3236	Mercury Marine	23-32632	871	18-3301	Yamaha	90280-04M04-00	411
1	18-3237			754	18-3302	Yamaha	90280-04M05-00	411
1	18-3238	OMC	388891	Obsolete	18-3303	Johnson Pump	01-42401	575
2	18-3239			413	18-3304	Jabsco	6760-0001	573
1	18-3240			248	18-3304	Johnson Pump	09-802-B	634
1	18-3242	Suzuki	17400-96350	484	18-3305	Mercury Marine	28-81912M	411
1	18-3242	Suzuki	17400-96351	484	18-3305	Mercury Marine	28-83701M	411
1	18-3242	Suzuki	17400-96353	484	18-3305	Yamaha	90280-03003-00	515
1	18-3243	Suzuki	17400-94700	484	18-3305	Yamaha	90280-03024-00	515
1	18-3243	Suzuki		484	18-3306	Jabsco	13554-0001	573

1 This product is priced per piece. To order, priced per package, please add -9 to the part number

2 Items ending in "D" are display packaged - regular number is non-display

3 For discount shop pack of 10, please add -10 to the part number

SIERRA #	O.E.M.	O.E. #	PAGE #	SIERRA #	O.E.M.	O.E. #	PAGE #	
SIERRA								
2	18-3306	Johnson Pump	09-812B	574	18-3390	OMC	5001594	300
2	18-3306	Yanmar	119773-42600-00	573	18-3391	OMC	395072	301
2	18-3309			754	18-3392	OMC	434421	301
	18-3310	Yamaha	6G5-W0078-01-00	516	18-3392	OMC	5001594	301
	18-33104	Mercury	802632	728	18-3393	OMC	388644	301
	18-33104	Mercury	802632T	728	18-3393	OMC	395073	301
	18-3311	Yamaha	6G5-W0078-A1-00	516	18-3394	OMC	433548	301
	18-3312	Yamaha	6N6-W0078-00-00	517	18-3394	OMC	433549	301
	18-3313-1	Yamaha	6N6-W0078-01-00	517	18-3394	OMC	438592	301
	18-3314			414	18-3395	Yamaha	61A-W0078-01-00	517
	18-3315-2	OMC	435929	302	18-3396-1	Yamaha	61A-W0078-A2-00	517
	18-3315-2	OMC	5001595	302	18-3396-1	Yamaha	61A-W0078-A3-00	517
	18-3316	Mercury Marine	46-32437A3	414	18-3397	Yamaha	679-W0078-00-00	518
	18-3316	Mercury Marine	46-78400A2	414	18-3397	Yamaha	679-W0078-A0-00	518
	18-3316	Mercury Marine	46-96148AB	414	18-3398	Yamaha	6F5-W0078-00-00	518
	18-3317	Mercury Marine		755	18-3398	Yamaha	6F5-W0078-A0-00	518
	18-3318	Mercury Marine	47-59362Q08	754	18-3399	OMC	396933	301
	18-3319	Mercury Marine	46-42579A4	414	18-3399	OMC	439077	301
	18-3320			755	18-3400	OMC	391698	301
	18-33207	Mercury	860349A1	727	18-3400	OMC	394711	301
	18-3321			755	18-3401	OMC	394394	301
	18-33211	Mercury	892681	727	18-3401	OMC	395271	301
	18-3322	Mercury Marine	46-77516A3	414	18-3401	OMC	395270	301
	18-3323	Mercury Marine	46-73640A2	415	18-3402	OMC	382296	301
	18-3324	Mercury Marine	46-77177A3	415	18-3403	OMC	388644	302
	18-3325	OMC	387326	298	18-3404	Suzuki	09420-04009	483
	18-3326	OMC	300611	296	18-3405	OMC	435959	267
	18-3327	OMC	386697	298	18-3406	Mercury Marine	817275A08	413
	18-3327	OMC	387610	298	18-3407	Mercury Marine	817275A09	413
	18-3327	OMC	389112	298	18-3408	Yamaha	663-44311-02	518
	18-3327	OMC	391698	298	18-3408	Yamaha	6H4-W0078-00	518
	18-3327	OMC	394711	298	18-3408	Yamaha	6H4-W0078-A0	518
	18-3328	Yamaha	646-44322-00-00	521	18-34080	Universal		670
	18-3329	OMC	302497	333	18-34081	Universal		670
	18-3332	OMC	304026	333	18-34082	GM		670
	18-3333	Yamaha	61A-44322-00-00	516, 517	18-34083	GM		670
	18-3336	OMC	384087	297	18-34084	GM		670
	18-3337	OMC	315837	333	18-3409	Yamaha	67F-44311-01	520
	18-3343	OMC	320981	296	18-3409	Yamaha	67F-W0078-00	520
	18-3344	Yamaha	6E5-44323-00-00	517	18-3410	Yamaha	68T-W0078-00-00	519
	18-3345	Yamaha	6G5-44323-00-00	516	18-3411	Yamaha	682-W0078-A1-00	516
	18-3346	OMC	435027	296	18-34110	Mallory	4110M	665
	18-3348	OMC	984461	909	18-3412	Yamaha	63V-44301-00	518
	18-3349			909	18-3412	Yamaha	63V-W0078-01	518
	18-3350	Mercury Marine	72778	753	18-34120	Mallory	5110MFI	665
	18-3350	Mercury Marine	94576	753	18-3413	Yamaha	66T-44311-00	519
	18-3351	Mercury Marine	72777	753	18-3413	Yamaha	66T-W0078-00	519
	18-3351	Mercury Marine	94916	753	18-3414	Mercury Marine	46-7380A1	412
	18-3352	OMC	325398	299	18-3414	Mercury Marine	46-96146A5	412, 414
	18-3356	Yamaha	63V-44301-00-00	514	18-34140	Mallory	4140M	665
	18-3357	Yamaha	646-44323-00-00	521	18-3415	Yamaha	63D-W0078-01-00	519
	18-3358	OMC	328751	296	18-3416	Mercury Marine	46-73802A2	412
	18-3359	OMC	328755	296	18-3416	Mercury Marine	46-78400A1	412
	18-3360	OMC	329390	331	18-3416	Mercury Marine	46-96146A2	412
	18-3363	OMC	330560	297	18-3416	Mercury Marine	46-96146A6	412
	18-3365	OMC	909533	303, 327	18-3417	Mercury Marine	46-5723A1	753
	18-3366	OMC	390286	295	18-3419	Mercury Marine	46-42579A3	412
	18-3367	OMC	393632	297	18-3420	Mercury Marine	46-44292A3	753
	18-3368	OMC	396809	295	18-3420	Mercury Marine	46-44292Q03	753
	18-3369	OMC	302325	327	18-3420	Mercury Marine	46-44292T1	753
	18-3369	OMC	319126	303	18-3421	Mercury Marine	46-48748A1	753
	18-3370	Yamaha	692-W0078-00-00	517	18-3422	Mercury Marine	46-48745A1	412
	18-3370	Yamaha	692-W0078-01-00	517	18-3422	Mercury Marine	46-65498A1	412
	18-3370	Yamaha	692-W0078-A0-00	517	18-3422	Mercury Marine	46-68390A1	412
	18-3371	Yamaha	692-W0078-A0-00	517	18-3422	Mercury Marine	46-73842A2	412
	18-3372	Yamaha	6E5-W0078-01-00	517	18-3422	Mercury Marine	46-77516A1	412
	18-3373	Yamaha	6E5-W0078-A1-00	517	18-3423	Mercury Marine	46-73640A1	412
	18-3376	OMC	384956	298	18-3424	Mercury Marine	46-77177A1	412
	18-3377	OMC	382468	298	18-3425	Mercury Marine	84188M	416
	18-3378	OMC	391635	299	18-3425	Mercury Marine	84188T	416
	18-3378	OMC	439077	299	18-3425	Yamaha	663-W0078-00-00	521
	18-3379	OMC	390381	299	18-3425	Yamaha	663-W0078-A0-00	521
	18-3380	OMC	390770	299	18-3426	Mercury Marine	42431M	416
	18-33800	Mercury	21-806118	727	18-3426	Mercury Marine	84829M	416
	18-33800	Volvo	385688A	980	18-3426	Mercury Marine	97793M	416
	18-3381	OMC	393509	299	18-3426	Mercury Marine	97793T	416
	18-3382	OMC	393630	299	18-3426	Yamaha	689-W0078-04-00	521
	18-3383	OMC	395270	299	18-3426	Yamaha	689-W0078-A4-00	521
	18-3384	OMC	386124	300	18-3427	Mercury Marine	81242M	416
	18-3385	OMC	396932	300	18-3427	Mercury Marine	95661M	416
	18-3386	OMC	983218	909	18-3427	Yamaha	689-W0078-A6-00	522
	18-3387	OMC	432956	300	18-3428-1	Yamaha	6H3-W0078-00-00	518
	18-3388	OMC	386533	300	18-3428-1	Yamaha	6H3-W0078-A0-00	518
	18-3388	OMC	389143	300	18-3429	Yamaha	6H4-W0078-00-00	518
	18-3389	OMC	436957	300	18-3429	Yamaha	6H4-W0078-A0-00	518
	18-3389	OMC	438591	300	18-3430	Yamaha	6J8-W0078-A1-00	521
	18-3389	OMC	432955	300	18-3431	Yamaha	6L2-W0078-00-00	521
	18-3390	OMC	395060	300	18-3432	Yamaha	61N-W0078-11-00	522
	18-3390	OMC	435447	300	18-3433	Yamaha	63V-W0078-01-00	518
	18-3390	OMC	434421	300	18-3434	Yamaha	63D-W0078-01-00	519

1 This product is priced per piece. To order, priced per package, please add -9 to the part number

2 Items ending in "D" are display packaged - regular number is non-display

3 For discount shop pack of 10, please add -10 to the part number

SIERRA #	O.E.M.	O.E. #	PAGE #	SIERRA #	O.E.M.	O.E. #	PAGE #
SIERRA							
18-3435	Yamaha	663-44322-00-00	518, 520, 521, 557	18-3517	Mercury Marine	46-42579A4	414
18-3435			411	18-3517	Mercury Marine	46-44292A4	414
18-3436	Yamaha	663-44323-00-00	518, 521	18-3517	Mercury Marine	46-48747A3	414
18-3436			411	18-3517	Mercury Marine	46-57234A3	414
18-3440	Yamaha	66T-W0078-00-00	519	18-3517	Mercury Marine	46-58618A4	414
18-3442	Yamaha	68V-W0078-00-00	519	18-3517	Mercury Marine	46-60367A4	414
18-3443	Yamaha	61N-44322-01-00	522	18-3517	Mercury Marine	46-64141A11	414
18-3444	Yamaha	63V-44322-00-00	518, 519	18-3517	Mercury Marine	46-69222A3	414
18-3445	Mercury Marine	46-812966A7	412	18-3517	Mercury Marine	46-73802A3	414
18-3445	Mercury Marine	46-812966A3	412	18-3517	Mercury Marine	46-73804A3	414
18-3445	Mercury Marine	46-812966A9	412	18-3517	Mercury Marine	46-78400A2	414
18-3446	Mercury Marine	46-70941A3	415	18-3517	Mercury Marine	46-96148A5	414, 755
18-3448	Mercury Marine	46-48744A3	416	18-3517	Mercury Marine	46-96148A8	414, 755
18-3449	Yamaha	63D-44322-00-00	519	18-3518	Yamaha	6P2-44323-00-00	521
18-3450	Yamaha	68T-W0078-00-00	519	18-3519	Yamaha	61A-44322-02-00	519
18-3451	Yamaha	67F-W0078-00-00	520	18-3520	Yamaha	60X-44323-00-00	520
18-3453	OMC	5006511	298	18-3521	Yamaha	68V-44323-00-00	519
18-3454	OMC	438592	298	18-3522-1	Yamaha	60X-W0078-00	520
18-3455	OMC	340619	296	18-3522-1	Yamaha	61A-44311-01	520
18-3456	Yamaha	6G1-44322-00-00	521	18-3523-1	Yamaha	61A-44311-01	519
18-3457	Yamaha	6AW-44322-00-00	520	18-3523-1	Yamaha	68V-W0078-00	519
18-3458	Yamaha	6CE-44315-00-00	520	18-3524	Yamaha	6CE-12411-00-00	528
18-3459	Yamaha	6CE-44323-01-00	520	18-3525	Yamaha	60V-12411-00	528
18-3460	Yamaha	6G1-W0078-01-00	521	18-3530-1	Mercury Marine	860256A2	Obsolete
18-3460	Yamaha	6G1-W0078-A1-00	521	18-3530-1	Mercury Marine	860256A4	Obsolete
18-3460	Yamaha	6N0-W0078-A0-00	521	18-35302	Yamaha	66M-24410-10-00	505
18-3460	Yamaha	66M-14301-00-00	502	18-35304	Yamaha	67D-24410-03-00	Obsolete
18-3460	Yamaha	66M-14301-12-00	502	18-3531	Mercury Marine	807074A1	759
18-3460	Yamaha	67D-14301-13-00	502	18-3531	Mercury Marine	808064A1	759
18-3460	Yamaha	63V-14301-00-00	502	18-3531	Mercury Marine	861188A1	759
18-3460	Yamaha	69M-14301-11-00	502	18-3535	Mercury Marine	88559900A	408
18-3460	Yamaha	66T-14301-00-00	502	18-3536	Mercury Marine	833072003	408
18-3461	Yamaha	6H3-W0078-00-00	518	18-3537	Mercury Marine	833072002	408
18-3461	Yamaha	6H3-W0078-A0-00	518	18-3537	Mercury Marine	833072004	408
18-3462	Yamaha	6A1-W0078-02-00	521	18-3538	Volvo	383142A	992
18-3463	Yamaha	6A1-W0078-01-00	521	18-3539	Volvo	383142B	992
18-3465	Yamaha	6H3-W0078-01-00	520	18-3540	Yamaha	6E5-12411-30-00	528
18-3465	Yamaha	6H3-W0078-02-00	520	18-3541	Yamaha	66M-12411-01-00	528
18-3466	Yamaha	6H3-44311-00	520	18-3543	OMC	378065	307
18-3466	Yamaha	6H3-W0078-01	520	18-3543	OMC	393659	307
18-3466	Yamaha	6H3-W0078-02-00	520	18-3543	OMC	434841	307
18-3469	OMC	3854661	909	18-3543	OMC	508626	307
18-3470	Yamaha	6CE-W0078-01	520	18-3543	OMC	5005440	307
18-3471	Yamaha	6CE-W0078-01 + 6CE-44311-01	520	18-35433	Mercury Marine	861156A1	743
18-3472	OMC	5007972	302	18-35435			666
18-3473	Yamaha	6EE-W0078-00-00	522	18-35436			666
18-3474	Yamaha	6CB-W0078-00-00	522	18-35437	Mercury	42725A3	743
18-3475	Yamaha	69G-W0078-00	522	18-35437	Mercury	861676A1	743
18-3476	OMC	5007556	303	18-35437	Mercury	861676T09	743
18-3477	Yamaha	6AW-W0078-00-00	522	18-35437	Mercury	8M0073435	743
18-3478	Honda	06192-ZW9-A30	263	18-3544	OMC	435491	307
18-3479	Yamaha	6AH-W0078-00	522	18-35442	Volvo	859428	976
18-3480	Suzuki	17411-93901	485	18-35443	Volvo	3582310	688
18-3481	Suzuki	17411-94421	485	18-35444	Volvo	858459	688
18-3482	Yamaha	6CE-44311-01-00	514	18-3545	OMC	437090	307
18-3483	Yamaha	6AW-44311-01-00	514	18-3546	OMC	501036	307
18-3484	Yamaha	6AH-44311-00-00	514	18-3549	Mercury Marine	14586	408
18-3485	Yamaha	6CJ-44311-00-00	514	18-3550	Chrysler Force	F84068-2	247
18-3486	Yamaha	6L2-44311-01-00	514	18-3550	Chrysler Force	F85068	247
18-3489	Honda	06192-ZX2-C00	263	18-3550	Chrysler Force	F85068-1	247
18-3490	Yamaha	6BG-W0078-00-00	523	18-3550	Chrysler Force	F85068-2	247
18-3491	OMC	437907	303	18-3550	Mercury Marine	59078	758
18-3492	Honda	06192-ZW1-B04	263	18-3550	Mercury Marine	59078A1	758
18-3493	Honda	06192-ZW9-000	263	18-3551	Chrysler Inboard	4142885	596
18-3494	Yamaha	6CJ-W0078-00-00	523	18-3551	Crusader	96319	619
18-3495	Suzuki	15170-93911	480	18-3551	Mercury Marine	32728	758
18-3496	Suzuki	15170-94320	480	18-3551	Mercury Marine	35884	758
18-3497	OMC	5033372	289	18-3551	Mercury Marine	59137	758
18-3497	Suzuki	15170-91J00	480	18-3551	Mercury Marine	8072521	758
18-3498	OMC	5036216	289	18-3551	Mercury Marine	8072531	758
18-3498	Suzuki	15170-94J00	480	18-3551	Mercury Marine	59137A1	758
18-3498	Suzuki	15170-94J0V	480	18-3551	Mercury Marine	807252T1	758
18-3499	OMC	5030699	289	18-3551	Mercury Marine	8M0089715	648
18-3499	Suzuki	15170-99E00	480	18-3551	Pleasurecraft	R026002E	758
18-3500	OMC	394409	307	18-3552	Crusader	96358	619
18-3500	OMC	434137	307	18-3552	Mercury Marine	76270	758
18-3501	OMC	435957	296	18-3552	Mercury Marine	76270T	758
18-3502	OMC	912614	908	18-3553	Mercury Marine	62981	409
18-3504	Volvo	3588475	982	18-3553	Mercury Marine	66850	409
18-3505	Yamaha	63V-44365-10-00	516	18-3553	Mercury Marine	75892	409
18-3506	Mercury Marine	46-879194401	752	18-3554	OMC	383307	910
18-3506	Volvo	21124846	981	18-3555	Mercury Marine	99155A1	758
18-3507	Mercury Marine	46-60366A1	414	18-3555	Mercury Marine	99155T2	758
18-3510	Johnson Pump	09-45589	575	18-3556	Chrysler Force	F97068-2	247
18-3510	Mallory	5421	Obsolete	18-3556	Mercury Marine	895338	409
18-3510	Mallory	54212	665	18-3557	Chrysler Force	F335068	247
18-3513	Volvo Penta	22844837	981	18-3557	Mercury Marine	47594	758
18-3515	Yamaha	6P2-W0078-00-00	521	18-3557	OMC	382385	307
18-3516	Yamaha	60X-W0078-00-00	520	18-3557	OMC	396987	307
18-3517	Mercury Marine	46-32437A1	414	18-3557	Volvo	21148403	991

1 This product is priced per piece. To order, priced per package, please add -9 to the part number

2 Items ending in "D" are display packaged - regular number is non-display

3 For discount shop pack of 10, please add -10 to the part number

SIERRA #	O.E.M.	O.E. #	PAGE #	SIERRA #	O.E.M.	O.E. #	PAGE #
SIERRA							
18-3558	OMC	982554	909	18-3599-2	Mercury Marine	52226	752
18-3558	OMC	3853799	909	18-3599-2	Mercury Marine	54793	752
18-3558	Volvo	3853799	991	18-3599-2	Mercury Marine	60658	752
18-3559	Chrysler Force	F528068	247	18-3599-2	Mercury Marine	811841	752
18-3560	OMC	384719	307	18-3599-2	Mercury Marine	850399	752
18-3561	OMC	436195	307	18-3599-2	Mercury Marine	878341	752
18-3562	OMC	321222	308	18-3599-2	Mercury Marine	8503991	752
18-3563	OMC	321027	308	18-3599-2	Mercury Marine	850399002	752
18-3564	OMC	318395	308	18-3599-2	Mercury Marine	F11100742	752
18-3565	OMC	321220	307	18-3599-2	Mercury Marine	F11101208	752
18-3566	Johnson/Evinrude	331894	307	18-3599-2	Mercury Marine	F11101292	752
18-3567	OMC	321221	307	18-3599-2	OMC	382218	905
18-3568	Mercury Marine	99155T1	758	18-3599-2	OMC	980477	905
18-3569	Mercury Marine	803061T1	408	18-3599-2	OMC	985429	905
18-3570			416	18-3599-2	OMC	3853850	905
18-3571	Mercury Marine	817275A1	415	18-3599-2	Pleasurecraft	RA057018	646
18-3572	Mercury Marine	46-43024A3	415	18-3599-2	Volvo	835390	981
18-3572	Mercury Marine	817275A2	415	18-3599-2	Volvo	856364	981
18-3573	Mercury Marine	883514	752	18-3599-2	Volvo	3853850	981
18-3573	Mercury Marine	883925	752	18-3600	Mercury Marine	46-59112A2	754
18-3577-2	Mercury Marine	30103	619	18-3600	Mercury Marine	46-63450A2	754
18-3577-2	Crusader	30103	619	18-3600	Mercury Marine	46-72774A11	754
18-3577-2	GM	6269358	905	18-3600	Mercury Marine	46-72774A32	754
18-3577-2	Mercury Marine	17670	752	18-3600	Mercury Marine	46-73823A7	754
18-3577-2	Mercury Marine	49139	752	18-3600	Mercury Marine	46-807151A12	754
18-3577-2	Mercury Marine	54534	752	18-36001	Mercuriser	32-32461	771
18-3577-2	Mercury Marine	59972	752	18-3601	Mercury Marine	32-32461A1	771
18-3577-2	Mercury Marine	67859	752	18-3601	Mercury Marine	32-4172533	772
18-3577-2	Mercury Marine	811573	752	18-3602	Mercury Marine	32-8M0062309	772
18-3577-2	Mercury Marine	850544	752	18-3602	Mercury Marine	32-43437	772
18-3577-2	Mercury Marine	878342	752	18-3603	Mercury Marine	32-8M0090859	772
18-3577-2	Mercury Marine	8504541	752	18-3603	Mercury Marine		
18-3577-2	Mercury Marine	8504541	752	18-3605			408
18-3577-2	Mercury Marine	850454002	752	18-3606			408
18-3577-2	Mercury Marine	F6269358	752	18-3607	Mercury Marine	893409	458
18-3577-2	Mercury Marine	F11100997	752	2 18-3608			529
18-3577-2	Mercury Marine	F11101053	752	2 18-3609			529
18-3577-2	OMC	983296	905	18-3610	OMC	911752	942
18-3577-2	OMC	986074	905	18-3611			529
18-3577-2	OMC	987447	905	18-3615	Volvo	3587597	993
18-3577-2	OMC	3854118	905	18-3617			993
18-3577-2	Pleasurecraft	RA057019	646	18-3618			993
18-3577-2	Volvo	856609	981	18-3619			993
18-3577-2	Volvo	3855991	981	18-3620			993
18-3578	OMC	984876	905	18-3621			993
18-3581	Chrysler Inboard	3004886	597	18-3622	Yamaha	6H3-12411-11-00	528
18-3581	Chrysler Inboard	3619542	597	18-3623	Yamaha	6E5-12411-02-00	528
18-3581	Chrysler Inboard	3745985	597	18-3624	Yamaha	69M-12411-01-00	528
18-3581	Chrysler Inboard	4417905	597	18-3625	Yamaha	6F5-12411-03-00	528
18-3582	Chrysler Inboard	3619859	597	18-3626			992
18-3584-1	Mercury Marine	56879	752	18-3627	Honda	19300-881-761	262
18-3584	Mercury Marine	58086	752	18-3628-1	Honda	19300-ZW9-003	262
18-3584-1	Mercury Marine	71683	752	18-3629	Honda	19300-881-741	Obsolete
18-3584-1	Mercury Marine	883885	752	18-3630	Honda	19300-ZV5-043	262
18-3584-1	Mercury Marine	71683A1	752	18-3631	Mercury	892864T04	409
18-3584-1	OMC	982515	905	18-3632	Yamaha	67F-12411-01-00	528
18-3584-1	OMC	982517	905	18-3633	Mercury	8M0090819	409
18-3584-1	OMC	3853796	905	18-3634	Yamaha	6AW-12411-00-00	528
18-3584-1	Pleasurecraft	RA057004	646	18-3635	Mercury	892864T06	409
18-3584-1	Volvo	3853796	981	18-3636	Yamaha	6DA-12411-01-00	528
18-3584-1			619	18-3637	Yamaha	6CB-12411-10-00	528
18-3586-1	Indmar	685011	634	18-3638	Mercury	804540	409
18-3586-1	Johnson Pump	10-24228-1	575	18-3639	Yamaha	6EK-12411-00-00	528
18-3586-1	Pleasurecraft	RA057023	646	18-3640	Mercury	8M0117413	409
18-3586-1	Volvo	841840	981	18-3641	Yamaha	6FP-12411-00-00	528
18-3587-1	Indmar	685001	634	18-3642	Mercury	855676A1	409
18-3587-1	Johnson Pump	10-24232-1	575	18-3643	OMC	433379	307
18-3587-1	Pleasurecraft	RA057024	646	18-3644			758
18-3593	Mercury Marine	35957	752	18-3645	Chrysler Inboard	2463441	596
18-3593	Mercury Marine	37369	752	2 18-3646	Mercury Marine	807252Q3	758
18-3593	Mercury Marine	52353	752	2 18-3646	Mercury Marine	807252T6	758
18-3593	Mercury Marine	65142	752	2 18-3647	Mercury Marine	807252Q5	758
18-3593	Mercury Marine	65142A1	752	2 18-3647	Mercury Marine	807252T8	758
18-3593	Mercury Marine	814755	752	2 18-3648			758
18-3593	Mercury Marine	880817	752	18-3649	Crusader	97895	619
18-3593	Mercury Marine	884727	752	18-3649	Mercury Marine	8052732	758
18-3593	Mercury Marine	F2774666	752	18-3649	Mercury Marine	8072522	758
18-3593	Mercury Marine	F11001079	752	18-3649	Mercury Marine	807252T2	758
18-3593	Mercury Marine	F11100785	752	18-3649	Mercury Marine	8M0091470	758
18-3593	OMC	984360	905	2 18-3650	Mercury Marine	59078T3	758
18-3593	OMC	986779	905	2 18-3651			758
18-3593	OMC	380640	905	18-3652			758
18-3593	OMC	3854017	905	2 18-3653			909
18-3593	OMC	3858340	905	18-3654	Volvo	875779	992
18-3593	Volvo	3854017	978	18-3656	Volvo	875781	992
18-3593	Volvo	3858340	978	18-3656	Volvo	876097	992
18-3599-2	Crusader	20318	619	18-3658	Volvo	875784	992
18-3599-2	Crusader	7142520	619	18-3658	Volvo	877349	992
18-3599-2	Mercury Marine	17437	752	18-3659	Volvo	875785	992
18-3599-2	Mercury Marine	35341	752	18-3660	Volvo	875787	992
18-3599-2	Mercury Marine	37951	752	18-3660	Volvo	3831425	992

1 This product is priced per piece. To order, priced per package, please add -9 to the part number

2 Items ending in "D" are display packaged - regular number is non-display

3 For discount shop pack of 10, please add -10 to the part number

SIERRA #	O.E.M.	O.E. #	PAGE #	SIERRA #	O.E.M.	O.E. #	PAGE #
SIERRA							
18-3662	Volvo	875794	992	18-3728	Mercury Marine	11-99298	831
18-3662	Volvo	876305	992	18-3729	Mercury Marine	10-36289	831
18-3663	Volvo	875791	992	18-3729	Mercury Marine	10-97934	831
18-3664	Volvo	875795	992	18-3730	OMC	3852648	943
18-3665	Volvo	875796	992	18-3730	Volvo	3852648-9	1007
2 18-3666	Volvo	875580	992	1 18-3731	OMC	907866	938
18-3667			759	18-3732	Yamaha	90171-16011-00	552
2 18-3668	Mer cruiser	807252Q4	759	18-3732	Yamaha	95307-16900-00	552
2 18-3668	Mer cruiser	807252T4	759	2 18-3733			943, 1008
2 18-3669			307	1 18-3735	OMC	5030087	347
2 18-3670			910, 992	1 18-3735	Suzuki	08204-03003	488
2 18-3671	Crusader	97361	619	1 18-3735	Suzuki	08204-03004	488
2 18-3671	Pleasurecraft	RP026002E	646	1 18-3735	Yamaha	91490-40030-00	551
2 18-3672			307	1 18-3737	Suzuki	08204-02004	488
2 18-3673			307	1 18-3740	OMC	302804	347
2 18-3674			307	1 18-3741	OMC	309955	347
18-3675	Mercury Marine	27-850318	439	1 18-3742	OMC	314502	347
18-3675	Mercury Marine	27-8503181	439	1 18-3743	OMC	320785	347
2 18-3676	Volvo	3853983	992	1 18-3744	OMC	552906	347
2 18-3676			910	1 18-3744	Volvo	3852255	1008
2 18-3677			992	1 18-3745	Volvo	17253-6	1008
2 18-3677			910	1 18-3746			70
18-36850			396	1 18-3747			70
18-36905	Volvo	3854018	975	1 18-3748	Yamaha	91490-30045-00	551
18-36906	Mercury	811536	739	1 18-3748			70
18-36908	Mercury	811536T	739	18-3749	Mercury Marine	816685	850
18-36956	Mercury	1395-9267	396	18-3751	Mercury Marine	79448	456, 861
18-3700	Mercury Marine	11-52707	457	18-3752	Mercury Marine	35982	850
18-3700	Mercury Marine	11-827614	457	18-3752	Mercury Marine	86071	850
18-3700	Mercury Marine	F7040	457	18-3752	Mercury Marine	8168111	850
18-3700	Pleasurecraft	R017066	650	18-3752	Mercury Marine	8168112	850
2 18-3701	Mercury Marine	11-52707A1	457, 865	18-3752	Johnson/Evinrude	5005034	347
2 18-3701	Mercury Marine	11-52707A2	457, 865	18-3754	Mercury Marine	43436	854
2 18-3701	Mercury Marine	11-52707Q1	457, 865	18-3755			860
2 18-3701			256, 268, 650	18-3756			860
2 18-3702	Mercury Marine	11-69578A1	457	18-3759	Mercury Marine	35915	860
2 18-3702	Mercury Marine	11-69578Q1	457	18-3760	Mercury Marine	23-806036A1	850
2 18-3702	Mercury Marine	11-69578T1	457	18-3763	OMC	322941	343, 345, 932
18-3703	Mercury Marine	11-88228	457	18-3765	OMC	331880	355
18-3704	Mercury Marine	11-69578	457	18-3766	OMC	334163	355, 942
1 18-3705	OMC	314503	347, 943	18-3768	OMC	911751	347, 942
1 18-3706	OMC	318971	347	18-3769	OMC	911753	938
1 18-3707	OMC	319891	347	18-3770	OMC	911937	938
1 18-3708-1	OMC	398042	347	18-3771			552
1 18-3708-1	Volvo	3850984	1008	18-3773	Yamaha	90171-10M01	552
18-3709	Yamaha	647-45616-02	552	18-3774	Suzuki	57630-94500	488
18-3710	Suzuki	09141-14008	488	18-3775	Suzuki	57630-92E00	488
18-3712	Mercury Marine	12-45810	850	18-3777	Suzuki	57630-84300	488
18-3713	Mercury Marine	11-22339	850	18-3778	Suzuki	57630-96300	488
18-3713	Mercury Marine	11-36084	850	2 18-3781	Yamaha	6H1-W4599-00-00	552
18-3713	Mercury Marine	11-97522	850	2 18-3782	Yamaha	6G5-W4599-00-00	552
18-3713	Mercury Marine	F1348	850	18-3783	Mercury Marine	11-805092	865
18-3713	Mercury Marine	F1881	850	18-3783	Mercury Marine	11-805092T	865
18-3714	Mercury Marine	12-31211	457, 865	18-3783	Mercury Marine	11-859131	865
18-3714	Mercury Marine	12-31211A2	457, 865	18-3784	Mercury Marine	805100	864
18-3714	Mercury Marine	12-31211A3	457, 865	18-3785	Mercury Marine	11-39823	865
18-3714	Mercury Marine	12-31211Q03	457, 865	18-3785	Mercury Marine	11-39907	865
2 18-3715	OMC	175266	347, 943	18-3785	Mercury Marine	11-54034	865
2 18-3716	OMC	175267	347, 943	18-3785	Mercury Marine	11-82671127	865
2 18-3717	OMC	175268	347	18-3786	Mercury Marine	11-805093	865
18-3719	Chrysler Force	11-35921	256	18-3786	Mercury Marine	11-862907	865
18-3719	Chrysler Force	11-47411	256	18-3787	Mercury Marine	805101T	865
18-3719	Chrysler Force	11-826375	256	18-3788-9	Mercury Marine	14-34817	865
18-3719	Chrysler Force	11-F694188	256	18-3791			552
18-3719	Mercury Marine	11-35921	454, 860	18-3792	Yamaha	90171-14056-00	552
18-3719	Mercury Marine	11-47411	454, 860	18-3792			552
18-3719	Mercury Marine	11-826375	454, 860	18-3800	OMC	325273	325
18-3719	Mercury Marine	11-F694188	454, 860	18-3800B	Honda	17660-ZV5-902	260
18-3719	OMC	314730	938	18-3801	OMC	325647	325
1 18-3720	Mercury Marine	11-34932	456, 867	18-3801	OMC	335361	325
1 18-3721	Mercury Marine	11-13439-1	831	18-3802	OMC	320658	325
1 18-3721	Mercury Marine	11-21298	456, 867	18-3802	OMC	327795	325
1 18-3721	Mercury Marine	11-22178	456, 867	18-3802	OMC	335359	325
1 18-3721	Mercury Marine	11-24648	456, 867	18-3803	OMC	324324	325
1 18-3721	Mercury Marine	11-29241	456, 867	18-3803	OMC	329419	325
1 18-3721	Mercury Marine	11-33962	456, 867	18-3803	OMC	765012	325
1 18-3721	Mercury Marine	11-34933	456, 867	18-3804	Mercury Marine	27-19138	435
1 18-3721	Mercury Marine	11-46355	456, 867	18-3804	Mercury Marine	27-19138M	435
1 18-3721	Mercury Marine	11-82671015	456, 867	18-3804	Mercury Marine	27-84733M	435
1 18-3721	Mercury Marine	11-859116	831	18-3804	Yamaha	689-11181-02-00	539
1 18-3721	Mercury Marine	11-95702	456, 867	18-3804	Yamaha	689-W0001-A1-00	539
1 18-3722	Mercury Marine	11-20361	456, 867	18-3805	Yamaha	688-11181-02-00	539
1 18-3722	Mercury Marine	11-35888	456, 867	18-3805	Yamaha	688-11181-A1-00	539
1 18-3722	Mercury Marine	11-8267089	456, 867	18-3806	Suzuki	11141-98401	486
1 18-3722	OMC	121731	945	18-3806	Suzuki	11141-98411	486
1 18-3722	Volvo	3852005	1008	18-3807	Suzuki	11141-98101	486
1 18-3723	Mercury Marine	11-45592	449, 867	18-3807	Suzuki	11141-98130	486
1 18-3725	OMC	908064	838	18-3808	Suzuki	11141-93901	486
1 18-3726	Suzuki	09141-18005	488	18-3808	Suzuki	11141-93960	486
18-3728	Mercury Marine	11-863332	831	18-3809	Suzuki	11141-96303	486

1 This product is priced per piece. To order, priced per package, please add -9 to the part number

2 Items ending in "D" are display packaged - regular number is non-display

3 For discount shop pack of 10, please add -10 to the part number

SIERRA #	O.E.M.	O.E. #	PAGE #	SIERRA #	O.E.M.	O.E. #	PAGE #
SIERRA							
18-3809	Suzuki	11141-96344	486	18-3874	OMC	3853511	925
18-3810	Suzuki	11141-94401	486	18-3876	Chris-Craft	16.50-00250	589
18-3810	Suzuki	11141-94450	486	18-3876	Crusader	7057500	630
18-3813	Suzuki	11141-95305	486	18-3876	GM	6269577	650
18-3813	Suzuki	11141-95320	486	18-3876	Mercury Marine	27-34278	825
18-3814	Suzuki	11141-95505	487	18-3876	Mercury Marine	27-48330	825
18-3814	Suzuki	11141-95512	487	18-3876	Mercury Marine	27-75611	825
18-3816	Suzuki	11141-98504	487	18-3876	Mercury Marine	27-75611001	825
18-3816	Suzuki	11141-98510	487	18-3876	OMC	914971	925
18-3816	Suzuki	11141-98522	487	18-3876	OMC	3853380	925
18-3819	Suzuki	11141-95D10	487	18-3876	Volvo	841207	1001
18-3819	Suzuki	11141-95D90	487	18-3876	Volvo	856474	1001
18-3820	Suzuki	11141-94701	487	18-3877	Chris-Craft	16.50-00259	589
18-3820	Suzuki	11141-94702	487	18-3877	Crusader	30266	630
18-3820	Suzuki	11141-94720	487	18-3877	Mercury Marine	27-13218	825
18-3822	Suzuki	11141-87E10	487	18-3877	Mercury Marine	27-13687	825
18-3822	Suzuki	11141-87E90	487	18-3877	Mercury Marine	27-19315	825
18-3823	Suzuki	11141-94506	487	18-3877	Mercury Marine	27-49104	825
18-3823	Suzuki	11141-94620	487	18-3877	Mercury Marine	27-61224	825
18-3824	Suzuki	11141-94600	487	18-3877	Mercury Marine	27-8M0049045	825
18-3824	Suzuki	11141-94620	487	18-3877	Mercury Marine	27-97529	825
18-3825	Suzuki	11141-87D60	487	18-3877	OMC	914849	925
18-3825	Suzuki	11141-87D90	487	18-3878	Chrysler Inboard	4417375	597
18-3827	Mercury Marine	27-825482	435	18-3878	Mercury Marine	27-13709	825
18-3827	Mercury Marine	27-8254821	435	18-3878	Mercury Marine	27-13709T	825
18-3827	Yamaha	6G8-11181-00-00	539	18-3878	Mercury Marine	27-74264	825
18-3827	Yamaha	6G8-11181-A1-00	539	18-3878	Mercury Marine	27-79986	825
18-3828	Mercury Marine	27-18937	435	18-3878	Mercury Marine	27-92166	825
18-3828	Mercury Marine	27-18937M	435	18-3878	Mercury Marine	27-921661	825
18-3828	Mercury Marine	27-83899M	435	18-3878	OMC	912766	925
18-3828	Mercury Marine	27-98990M	435	18-3879	Crusader	33408	630
18-3828	Yamaha	6E7-11181-00-00	539	18-3879	Mercury Marine	27-11986	825
18-3828	Yamaha	6E7-11181-A1-00	539	18-3879	Mercury Marine	27-42744	825
18-3829	Yamaha	6J8-11181-00-00	539	18-3879	Mercury Marine	27-816460	825
18-3829	Yamaha	6J8-11181-A1-00	539	18-3879	Mercury Marine	27-879150140	825
18-3830	Yamaha	6H4-11181-00-00	539	18-3879	OMC	912227	925
18-3830	Yamaha	6H4-11181-A1-00	539	18-3879	OMC	914930	925
18-3831	Yamaha	6H3-11181-01-00	539	18-3879	OMC	3854299	925
18-3831	Yamaha	6H3-11181-A1-00	539	18-3879	Volvo	912227	1001
18-3832	Yamaha	6E5-11181-02-00	539	18-3879	Volvo	914930	1001
18-3832	Yamaha	6E5-11181-A1-00	539	18-3879	Volvo	3854299	1001
18-3834	Volvo	833453	1001	18-3880	Mercury Marine	27-34273	825
18-3836	OMC	329836	325	18-3880	Mercury Marine	27-342731	825
18-3837	OMC	328623	325	18-3880	OMC	311210	925
18-3838	OMC	331211	325	18-3881	Mercury Marine	27-34274	825
18-3839	OMC	333670	325	18-3881	Mercury Marine	27-39164	825
18-3839	OMC	334726	325	18-3881	Mercury Marine	27-47453	825
18-3841-2	OMC	203130	325	18-3881	Mercury Marine	27-72622	825
18-3842	Volvo	833274	1001	18-3881	OMC	908237	925
18-3843	Volvo	859155	Obsolete	18-3883	Mercury Marine	27-56110	825
18-3844	Mercury Marine	27-803508	435	18-3883	Mercury Marine	27-64763	825
18-3845	Mercury Marine	27-825032	435	18-3883	Mercury Marine	27-75646	825
18-3847	Yamaha	6L2-11181-A1-00	539	18-3883	Mercury Marine	27-75647	825
18-3847	Yamaha	6L2-11181-A2-00	539	18-3883	OMC	3853732	925
18-3848	Yamaha	697-11181-A0-00	539	18-3883	Pleasurecraft	RM0032	650
18-3848	Yamaha	697-11181-A1-00	539	18-3883	Volvo	3853732	1001
18-3849	Yamaha	695-11181-A0-00	539	18-3886	Nissan/Tohatsu	3T9010050M	477
18-3849	Yamaha	695-11181-A1-00	539	18-3887	Crusader	31136	630
18-3850	Nissan/Tohatsu	3C8010055M	477	18-3887	Mercury Marine	27-811547	825
18-3851	Chrysler Force	27-F286529-3	252	18-3887	Mercury Marine	27-850470	825
18-3852	Chrysler Force	27-F513529	252	18-3887	Mercury Marine	27-879150141	825
18-3853	Chrysler Force	27-F691529-1	252	18-3887	OMC	915325	925
18-3854	Chrysler Force	27-F658529	252	18-3887	Volvo	3853511	1001
18-3855	Chrysler Force	27-820438	252	18-3888			1011
18-3856	Chrysler Force	27-F201529-1	252	18-3889			991
18-3857	Chrysler Force	27-824615	253	18-3890			991
18-3857	Chrysler Force	27-824615-2	253	18-3891	Yamaha	61A-11181-A0-00	539
18-3857	Chrysler Force	27-F476529-4	253	18-3891	Yamaha	61A-11181-A1-00	539
18-3857	Chrysler Force	F476529	253	18-3892	Yamaha	676-11181-A0-00	539
18-3857	Chrysler Force	F476529-1	253	18-3892	Yamaha	676-11181-A1-00	539
18-3857	Chrysler Force	F476529-2	253	18-3893			1010
18-3859	Chrysler Force	27-819138-2	253	18-3894	Yamaha	6G5-11181-00-00	539
18-3860	Chrysler Inboard	4142880	597	18-3894	Yamaha	6G5-11181-A0-00	539
18-3861	Mercury Marine	27-187851	435	18-3895	OMC	332816	325
18-3861	Mercury Marine	27-187853	435	18-3896	OMC	332817	325
18-3861	Mercury Marine	27-18785T	435	18-3898	OMC	332819	325
18-3862	Mercury Marine	27-41246-1	435	18-3899	OMC	327674	331
18-3863	Mercury Marine	27-96542-1	435	18-3901	OMC	436254	310
18-3864	Mercury Marine	27-822844-1	435	18-39010	Chrysler Force	39-817869A1	251
18-3866	OMC	340115	325	18-39010	Chrysler Force	FA663260	251
18-3867	Volvo	859647	1001	18-3902	Mercury Marine	39-45155A12	421
18-3868	Volvo	3583786	1001	18-3902	Mercury Marine	39-78816A12	421
18-3869	Volvo	3854202	1001	18-3904	OMC	394930	310
18-3870	Volvo	876303	999	18-3905	OMC	396504	310
18-3871	Mercury Marine	27-18786-1	435	18-3906	OMC	385662	310
18-3872	Mercury Marine	27-41245-1	435	18-3906	OMC	396503	310
18-3873	Volvo	3853587	Obsolete	18-3907	OMC	390509	310
18-3874	Crusader	31137	630	18-3908	OMC	390510	310
18-3874	Mercury Marine	27-811546	825	18-3910	OMC	396377	310
18-3874	Mercury Marine	27-879150139	825	18-3911	OMC	396378	310

1 This product is priced per piece. To order, priced per package, please add -9 to the part number
 2 Items ending in "D" are display packaged - regular number is non-display
 3 For discount shop pack of 10, please add -10 to the part number

SIERRA #	O.E.M.	O.E. #	PAGE #	SIERRA #	O.E.M.	O.E. #	PAGE #
SIERRA							
18-3912	OMC	396379	310	18-3976	Mercury Marine	39-15320M	421
18-3913	OMC	391170	310	18-3976	Mercury Marine	39-15320T	533
18-3913	OMC	434107	310	18-3976	Yamaha	682-11610-01-00	421
18-3914			310	18-3977	Mercury Marine	39-18939M	421
18-3915	OMC	391416	310	18-3977	Yamaha	682-11610-11-00	533
18-3915	OMC	434109	310	18-3978	Mercury Marine	39-15322M	421
18-3916	Mercury Marine	39-45204A12	421	18-3979	Mercury Marine	39-96170A12	421
18-3916	Mercury Marine	39-78811A12	421	18-3981	Mercury Marine	39-96170A4	421
18-3917	Mercury Marine	39-88392	421	18-3982	Mercury Marine	39-822321A12	421
18-3917	Mercury Marine	39-88392A12	421	18-3982	Mercury Marine	39-824905A12	421
18-3918	Mercury Marine	39-817096A6	421	18-3984	Mercury Marine	39-822321A2	421
18-3919	Mercury Marine	39-817096A16	421	18-3986	Mercury Marine	39-81096M	421
18-3920	Mercury Marine	39-817096A26	421	18-3992	Mercury Marine	39-83196M	421
18-3921	Mercury Marine	39-93481A12	423	18-3998	Chrysler Force	39-820457A2	251
18-3922	Mercury Marine	39-78918A4	423	18-3999	Chrysler Force	39-820641A1	251
18-3923	Mercury Marine	39-85636A4	423	18-4005	Volvo	833950	995
18-3924	Mercury Marine	39-18487A12	423	18-4008	Barr	MC-20-60207	798
18-3925	Mercury Marine	39-815267A4	423	18-4008	Mercury Marine	60207	798
18-3927	Mercury Marine	39-813011A12	423	18-4009	Barr	160252	798
18-3928	Mercury Marine	39-74381A1	809	18-4009	Mercury Marine	52999	798
18-3928	Mercury Marine	39-75422	809	18-4009	Mercury Marine	60252	798
18-39320	Yamaha	6R5-11603-00	533	18-4009	Mercury Marine	60252A2	798
18-3933	OMC	386280	310	18-4009	OMC	910384	916
18-3934	Yamaha	6E5-11610-03-00	533	18-40110	Suzuki	12110-94400	486
18-3936	Yamaha	6E5-11610-23-00	534	18-4013	Mercury Marine	765-7443A11	423
18-3937	GM	14089025	921, 997	18-4014	Mercury Marine	765-7446A11	423
18-3937	Mercury Marine	39-17464	809	18-40140	Suzuki	12110-93120	486
18-3937	Mercury Marine	39-34988	809	18-4017	Mercury Marine	783-9613A2	421
18-3937	Mercury Marine	39-65153	809	18-4017	Mercury Marine	783-9613T2	421
18-3937	Mercury Marine	39-67123	809	18-4018	Mercury Marine	783-9613A3	421
18-3937	Mercury Marine	F328506	809	18-4018	Mercury Marine	783-9613T3	421
18-3937	Mercury Marine	F3892364	809	18-4019	Mercury Marine	39-19721A6	421
18-3937	Mercury Marine	F11100386	809	18-4020	Mercury Marine	39-19721A1	421
18-3937	Mercury Marine	F11100692	809	18-4021	Mercury Marine	39-19721A2	421
18-3937	Mercury Marine	F11101321	809	18-4022	Mercury Marine	26-49131	818
18-3937	OMC	328506	921	18-4022	Mercury Marine	26-67863	818
18-3937	OMC	914555	921	18-4022	Mercury Marine	26-75982	818
18-3937	OMC	985083	921	18-4022	Mercury Marine	26-75988	818
18-3937	OMC	986336	921	18-4022	Mercury Marine	26-75988	818
18-3937	OMC	3853268	921	18-4022	Mercury Marine	F3866612	818
18-3937	OMC	3853960	921	18-4022	Mercury Marine	F11100968	818
18-3937	Volvo	3853268	997	18-4022	Mercury Marine	F11101117	818
18-3937	Volvo	3853960	997	18-4023	Mercury Marine	26-58094	818
18-3938	GM	14089026	997	18-4023	Mercury Marine	26-72564	818
18-3938	Mercury Marine	39-17465	809	18-4023	Mercury Marine	26-75413	818
18-3938	Mercury Marine	39-48345	809	18-4023	Mercury Marine	26-75624	818
18-3938	Mercury Marine	39-67126	809	18-4024	Mercury Marine	26-8M0050563	818
18-3938	Mercury Marine	F328516	809	18-4024	Mercury Marine	26-97664	818
18-3938	Mercury Marine	F11100694	809	18-4024	Mercury Marine	26-976641	818
18-3938	Mercury Marine	F11101322	809	18-4024	Mercury Marine	F11101200	818
18-3938	OMC	328516	921	18-4024	OMC	914445	929
18-3938	OMC	914557	921	18-4024	OMC	3853226	929
18-3938	Volvo	328516	997	18-4024	Volvo	914445	998
18-3938	Volvo	914557	997	18-4024	Volvo	3853226	998
18-3939	Mercury Marine	39-48344	809	18-4029	Volvo	463377	994
18-3939	Mercury Marine	39-66217	809	18-4031	Volvo	1306630	998
18-3939	Mercury Marine	39-97125	809	18-4036	Mercury Marine	29-47270	424
18-3939	Mercury Marine	F11100387	809	18-4037	Mercury Marine	29-71422	424
18-3939	Mercury Marine	F11100783	809	18-4038	Mercury Marine	31-47245A1	424
18-3939	Mercury Marine	F11101134	809	18-4038	Mercury Marine	31-55332A1	424
18-3939	OMC	914556	921	18-4038	Mercury Marine	31-58859A1	424
18-3939	OMC	3854252	921	18-4038	Mercury Marine	31-61424A2	424
18-3939	Volvo	914556	997	18-4038	Mercury Marine	31-62596A1	424
18-3939	Volvo	3854252	997	18-4038	Mercury Marine	31-63075A1	424
18-3940	Mercury Marine	39-67127	Obsolète	18-4039	Mercury Marine	31-17514A2	424
18-3940	OMC	328536	Obsolète	18-4039	Mercury Marine	31-8M0045430	424
18-3942	Mercury Marine	39-34479	809	18-4040	OMC	387139	314
18-3942	Mercury Marine	39-58096	809	18-4040	OMC	387142	314
18-3942	Mercury Marine	39-67119	809	18-4044	Volvo	834548	994
18-3942	Mercury Marine	39-67132	809	18-4044	Volvo	966894-2	994
18-3944	Mercury Marine	39-75809	809	18-4046	Volvo	958498	994
18-3944	Mercury Marine	F11101057	809	18-4046	Volvo	966857	994
18-3944	OMC	370409	921	18-4050	Mercury Marine	39-827179A12	423
18-3944	Volvo	370409	997	18-4051	Mercury Marine	39-826293A12	423
18-3947	OMC	439538	310	18-4052	Mercury Marine	39-826297A12	423
18-39480	Suzuki	12140-93121	486	18-4058			312
18-39530	Suzuki	12410-96351-050	486	18-4062	OMC	387661	310
18-39540	Suzuki	12140-94400	486	18-4063	OMC	394461	310
18-3957	Yamaha	61N-11603-00-00	533	18-4063	OMC	437409	310
18-3960	Yamaha	6H4-11610-00-00	533	18-4064	OMC	398483	310
18-3961	Yamaha	6H4-11610-10-00	533	18-4065	OMC	432072	310
18-3962	Yamaha	6H4-11610-20-00	533	18-4065	OMC	432969	310
18-3963	Yamaha	6K5-11601-02-00	533	18-4066	OMC	432073	310
18-3966	Mercury Marine	39-18653A12	421	18-4066	OMC	432970	310
18-3967	Mercury Marine	39-18653A1	421	18-4067	OMC	432077	310
18-3968	Mercury Marine	39-18653A2	421	18-4067	OMC	433003	310
18-3969	Yamaha	688-11603-A0-00	533	18-4068	OMC	432078	310
18-3972	OMC	390082	311	18-4068	OMC	433004	310
18-3974	OMC	431844	310	18-4069	OMC	432803	311
18-3975	OMC	431870	310	18-4075	OMC	308186	313
				18-4076	OMC	330081	313

1 This product is priced per piece. To order, priced per package, please add -9 to the part number

2 Items ending in "D" are display packaged - regular number is non-display

3 For discount shop pack of 10, please add -10 to the part number

SIERRA #	O.E.M.	O.E. #	PAGE #	SIERRA #	O.E.M.	O.E. #	PAGE #
SIERRA							
18-4077	Yamaha	93310-730V8-00	534	18-4161	OMC	914816	921
18-4078	Yamaha	93310-836V2-00	534	18-4161	OMC	3853340	921
18-4079	OMC	436859	310	18-4161	Volvo	914816	997
18-4080	Yamaha	6R5-11642-11-93	533	18-4161	Volvo	3853340	997
18-4081	Yamaha	6R5-11631-11-93	533	18-4164	GM	14077949	921
18-4082	Yamaha	6R5-11645-11-00	533	18-4164	Mercury Marine	735-6371	809
18-4083	Yamaha	6R5-11635-11-00	533	18-4164	Mercury Marine	735-850098	809
18-4084	Yamaha	6R5-11646-11-00	533	18-4164	Mercury Marine	735-9431	809
18-4085	Yamaha	6R5-11636-11-00	533	18-4164	Mercury Marine	735-9687	809
18-4086	OMC	439516	310	18-4164	Mercury Marine	735-9704	809
18-4087	OMC	439517	310	18-4164	Mercury Marine	F1101185	809
18-4088	OMC	436353	312	18-4164	Mercury Marine	F1101320	809
18-4089			312	18-4164	Mercury Marine	F1101336	809
18-4090	OMC	436354	312	18-4164	OMC	3911023	921
18-4091	Yamaha	6H3-11631-01-96	533	18-4164	Volvo	3911023	917
18-4093	Yamaha	6H3-11636-01-00	Obsolete	18-4165	OMC	439515	310
18-4096	Yamaha	6K5-11636-03-00	533	18-4173	GM	14077948	921, 997
18-4097	Yamaha	6H1-11631-03-95	533	18-4173	Mercury Marine	735-6370	809
18-4099	Yamaha	6H1-11636-03-00	533	18-4173	Mercury Marine	735-6370	809
18-4100	OMC	396585	310	18-4173	Mercury Marine	735-808661	809
18-4100	OMC	396588	310	18-4173	Mercury Marine	735-808674	809
18-4101	OMC	391653	310	18-4173	Mercury Marine	735-808674A1	809
18-4102	OMC	393612	310	18-4173	Mercury Marine	735-850097	809
18-4103	OMC	396587	310	18-4173	Mercury Marine	735-9686	809
18-4104	OMC	396583	310	18-4173	Mercury Marine	735-9703	809
18-4107	OMC	392621	310	18-4173	Mercury Marine	833232E	809
18-4109	Mercury Marine	759-592010	809	18-4173	Mercury Marine	F1101184	809
18-4109	Mercury Marine	759-661010	809	18-4173	Mercury Marine	F1101318	809
18-4109	Mercury Marine	759-80661A3	809	18-4173	Mercury Marine	F1101334	809
18-4109	Mercury Marine	759-80661A7	809	18-4173	OMC	3911020	921
18-4109	Mercury Marine	759-831210	809	18-4173	Volvo	3911020	997
18-4109	Mercury Marine	759-8312A2	809	18-4178	Mercury Marine	735-9715	809
18-4109	Mercury Marine	778-9015A2	809	18-4178	Mercury Marine	735-97151	809
18-4109	Mercury Marine	778-9441A3	809	18-4178	Mercury Marine	735-9715T1	809
18-4110			310	18-4178	Mercury Marine	F1101317	809
18-4111			310	18-4180	Mercury Marine	733-2278	809
18-4113			310	18-4180	Mercury Marine	733-66217	809
18-4114	OMC	387285	310	18-4180	Mercury Marine	736-2343	809
18-4118			810, 812	18-4181	Mercury Marine	735-6538	Obsolete
18-4120	OMC	393271	310	18-4183			921, 997
18-4120	OMC	393924	310	18-4188			921, 997
18-4122	OMC	393566	310	18-4189	Mercury Marine	737-6523	809
18-4123	OMC	392455	310	18-4189	Mercury Marine	737-879194035	809
18-4124	OMC	387284	310	18-4189	Mercury Marine	F1101101	809
18-4128	Yamaha	6G5-11642-00-93	533	18-4189			921, 997
18-4129	Yamaha	6G5-11631-00-93	533	18-4190	OMC	436860	310, 312
18-4130			533	18-4191	Mercury Marine	733-3819	809
18-4133	Yamaha	6G5-11636-00-00	533	18-4191	Mercury Marine	733-38191	809
18-4134	Mercury Marine	759-592012	809	18-4191	Mercury Marine	733-4028	809
18-4134	Mercury Marine	759-661012	809	18-4191	Mercury Marine	733-803850T	809
18-4134	Mercury Marine	759-80661A8	809	18-4191	Mercury Marine	F1100779	809
18-4134	Mercury Marine	759-806661A5	809	18-4191	Mercury Marine	F1100780	809
18-4134	Mercury Marine	759-831212	809	18-4191			921, 997
18-4134	Mercury Marine	759-8312A6	809	18-4194	OMC	3852350	943
18-4134	Mercury Marine	759-9015A4	809	18-4194	Volvo	3852350	1008
18-4134	Mercury Marine	778-9441A5	809	18-4195	OMC	439015	310
18-4135	Mercury Marine	761-7131M	421	18-4197	OMC	334665	313
18-4135	Mercury Marine	761-7133M	421	18-4200	Volvo	477024	995
18-4135	Mercury Marine	761-7134M	421	18-4201	Volvo	192212	995
18-4135	Mercury Marine	761-7982M	421	18-4204	Volvo	826341	1007
18-4135	Mercury Marine	761-7982T	421	18-4204	Volvo	876278	1007
18-4135	Yamaha	6E7-11631-00-97	533	18-4205	Volvo	832820	1007
18-4138	Mercury Marine	761-7196M	421	18-4206	Volvo	832570	1007
18-4138	Mercury Marine	761-7197M	421	18-4208	Volvo	839423	1007
18-4138	Mercury Marine	761-7198M	421	18-4209	Volvo	839534	1007
18-4138	Mercury Marine	761-8484M	421	18-4210	Volvo	850785	1007
18-4138	Yamaha	689-11631-00-95	533	18-4210	Volvo	854045	1007
18-4141	Yamaha	6H4-11631-00-96	533	18-4211	Volvo	850888	1007
18-4142	Yamaha	6H4-11635-01-00	533	18-4212	Volvo	850889	1008
18-4143	Yamaha	6H4-11636-00-00	Obsolete	18-4213	Volvo	851261	1008
18-4145	Yamaha	61N-11635-00-00	533	18-4213	Volvo	854047	1008
18-4146	Yamaha	61N-11636-00-00	533	18-4214	Pleasurecraft	RO96081	650, 1008
18-4148-1	OMC	394488	313	18-4214	Volvo	897367	650, 1008
18-4148-1	OMC	5004705	313	18-4215	Volvo	941816	1008
18-4150	Volvo	812994	991	18-4216	Volvo	807036	990
18-4156	Mercury Marine	776-9096A1	421	2 18-4218	Mercury Marine	22-16951A1	801
18-4157	Yamaha	6R5-11650-10-00	534	2 18-4218	Mercury Marine	22-16951Q1	801
18-4160	Mercury Marine	733-3818	809	2 18-4218	Mercury Marine	22-16951T1	801
18-4160	Mercury Marine	733-38181	809	2 18-4218	Mercury Marine	22-64426	801
18-4160	Mercury Marine	F1100781	809	2 18-4218	Mercury Marine	22-87238	801
18-4160	OMC	915236	921	2 18-4218	OMC	379957	916
18-4160	OMC	3853477	921	2 18-4218	Volvo	82745	990
18-4160	Volvo	915236	997	2 18-4218			588, 606, 628, 649, 801, 916, 990
18-4160	Volvo	3853477	997				Obsolete
18-4161	Mercury Marine	24-38191	809	18-4219	Volvo	829592	458
18-4161	Mercury Marine	733-3819	809	2 18-4220	Mercury Marine	12-13171	458
18-4161	Mercury Marine	733-4028	809	2 18-4220	Mercury Marine	12-77987	458
18-4161	Mercury Marine	733-803850T	809	2 18-4220	Mercury Marine	12-77987A1	458
18-4161	Mercury Marine	F1100779	809	2 18-4220	Mercury Marine	12-835467	458
18-4161	Mercury Marine	F1100780	809	2 18-4220	Mercury Marine	12-8354671	458

1 This product is priced per piece. To order, priced per package, please add -9 to the part number

2 Items ending in "D" are display packaged - regular number is non-display

3 For discount shop pack of 10, please add -10 to the part number

SIERRA #	O.E.M.	O.E. #	PAGE #	SIERRA #	O.E.M.	O.E. #	PAGE #		
SIERRA									
2	18-4220	Mercury Marine	12-835467Q01	458	1	18-4288	Mercury Marine	23-807073	871
2	18-4220	Pleasurecraft	R096116	449, 458, 650, 839	1	18-4289	Mercury Marine	53-805272	871
	18-4221	Mercury Marine	13191A1	458	1	18-4290	OMC	317831	310
	18-4221	Mercury Marine	75282A1	458	1	18-4292	OMC	326765	310
	18-4222	OMC	127084	347	1	18-4294	Mercury Marine	40-52035	421
	18-4222	OMC	318841	943	1	18-4294-9	Suzuki	09381-14001	486
	18-4223	OMC	333592	347, 943	1	18-4295	Mercury Marine	53-29641	861
2	18-4224	Mercury Marine	22-806926A1	801	1	18-4295-9	Suzuki	09381-18002	486
2	18-4224	Mercury Marine	22-862210A01	801	1	18-4296	Mercury Marine	35983	850
	18-4226	Mercury Marine	22-806608A02	801	1	18-4296-9	Suzuki	09381-20003	486
	18-4226	Mercury Marine	22-806608A1	801	1	18-4299	Nissan/Tohatsu	3F3010051M	477
	18-4227	Mercury Marine	22-806926	801	1	18-4300	OMC	385416	319
	18-4227	Mercury Marine	22-862210	801	1	18-4301	OMC	388602	319
	18-4228	OMC	315810	347, 943	1	18-43015	Mercury	864493	758
	18-4229	OMC	319890	337	1	18-43017	Indmar	9S85009	634
	18-4230	OMC	320305	337	1	18-43017	Mercury	863358T	758
	18-4231	OMC	320570	347, 943	1	18-43017	Mercury	8M0074922	758
	18-4232	OMC	323943	337	1	18-43017	Mercury	8M0076464	758
	18-4233	Mercury Marine	73345	458	1	18-4302	OMC	390078	320
	18-4233	Mercury Marine	12-92647M	458	1	18-4303-1	OMC	389556	320
	18-4233	Mercury Marine	73345A1	458	1	18-4303-1	OMC	391300	320
	18-4234	Volvo	832965	1007	1	18-4304-1	OMC	391988	320
	18-4236	Volvo	941907	991	1	18-4305	OMC	393433	320
1	18-4238	Volvo	943218	943, 1008	1	18-43051			409
	18-4239	Volvo	897873	1008	1	18-43052	Mercury	14586A3	408
1	18-4241	Volvo	951924	1008	1	18-43052	Mercury	75962A10	408
1	18-4245	Volvo	463902	995	1	18-43052	Mercury	75962A11	408
1	18-4246	Volvo	463903-5	995	1	18-43052	Mercury	75962A9	408
1	18-4248	OMC	311598	346, 929	1	18-4306	OMC	394546	321
1	18-42481-9	OMC	311598	346, 929	1	18-4307	OMC	389206	321
	18-4249	OMC	318544	337	1	18-4307	OMC	392567	321
1	18-4250	OMC	911820	929	1	18-4307	OMC	392615	321
1	18-4251	OMC	908062	938	1	18-4307	OMC	433941	321
1	18-4252	Mercury Marine	24-46312	870	1	18-4309	OMC	394885	321
	18-42531-9	OMC	336982	346, 929	1	18-4309	OMC	434381	321
	18-4253-9	OMC	336982	346, 929	1	18-4310	OMC	396750	321
	18-4255	OMC	307551	346	1	18-4312			251
	18-4256			105, 163, 588, 606, 628, 649	1	18-4313			252
	18-4257			588, 606, 628, 649, 798, 916, 990	1	18-4317	Mercury Marine	27-90484A32	431
	18-4258	Mercury Marine	22-33198	661	1	18-4317	Mercury Marine	27-90484A86	431
	18-4258	Mercury Marine	22-33198A1	661, 798	1	18-4317	Mercury Marine	27-90484A88	431
	18-4258	Mercury Marine	22-41622	661, 798	1	18-43175	Mercury	855676002	408
	18-4258	Mercury Marine	22-41622	661, 798	1	18-43175	Nissan/Tohatsu	3R3010300M	476
	18-4258	Mercury Marine	22-46754	661	1	18-4318	OMC	390076	322
	18-4258			588, 606, 622, 628, 649, 655, 657, 659, 661, 797, 798, 916, 990	1	18-4318	Mercury Marine	27-11338A85	432
	18-4259	Volvo	804261	1004	1	18-4319	Mercury Marine	27-11338A88	432
	18-42608	Indmar	S556050	634	1	18-4319	Mercury Marine	27-89221A32	432
	18-42608	Pleasurecraft	RA057036	646	1	18-4319	Mercury Marine	27-89221A84	432
	18-4261	Mercury Marine	19643	443	1	18-4319	Mercury Marine	27-89221A85	432
	18-4263	Mercury Marine	22-30139	798	1	18-4319	Mercury Marine	27-89221A88	432
	18-4263	Mercury Marine	22-32802	798	1	18-4321	OMC	398047	322
	18-4263	Mercury Marine	22-328021	798	1	18-4321	Mercury	46-8037502	412
	18-4263	Mercury Marine	22-328022	798	1	18-4321	Mercury	46-803750A02	412
	18-4263	Mercury Marine	22-841908	798	1	18-4321	Nissan/Tohatsu	3B2650160M	476
	18-4263	Mercury Marine	F700633	798	1	18-4322	OMC	432570	322
	18-4263	Mercury Marine	F15810151	798	1	18-4323	OMC	436891	323
	18-4263			588, 606, 628, 649, 797, 798, 916, 990	1	18-4325	Mercury Marine	25-85491A87	432
	18-4264	Mercury Marine	22-32803	798	1	18-4325	Mercury Marine	27-85491A90	432
	18-4264	Mercury Marine	22-87543	798	1	18-4326	Mercury Marine	27-43779A87	430
	18-4264	Mercury Marine	F15880010	798	1	18-43263	Yamaha	68D-G4311-01-00	514
	18-4264			105, 163, 588, 606, 628, 649, 916, 990	1	18-4329			318
	18-4265	Mercury Marine	22-42861	798	1	18-4330			318
	18-4265	Mercury Marine	22-428611	798, 835	1	18-4331			318
	18-4265	Mercury Marine	22-861187	798	1	18-4332			318
1	18-4267	Mercury Marine	12-29395	831	1	18-4334	Mercury Marine	27-41499A87	430
1	18-4267	Mercury Marine	12-8M0042641	831	1	18-4336	Mercury Marine	27-43004A86	430
1	18-4270	Mercury Marine	12-36001	831	1	18-4336	Mercury Marine	27-43004A90	430
	18-4272	Mercury Marine	19-32652	831	1	18-4336	Mercury Marine	27-43004A99	430
	18-4273	Mercury Marine	19-42682	831	1	18-4337	Mercury Marine	27-812867A91	430
	18-4274	Yamaha	688-45997-01-00	550	1	18-4337	Mercury Marine	27-812867A96	430
	18-4275	Mercury Marine	12-22388	443	1	18-4337	Mercury Marine	27-812867A97	430
	18-4275	Mercury Marine	12-25945	443	1	18-4338	Mercury Marine	27-814754A00	430
	18-4275	Mercury Marine	12-29245	443	1	18-4339	Mercury Marine	27-14697A87	431
	18-4275	Mercury Marine	12-32733	443	1	18-4340	Mercury Marine	27-13461A88	431
	18-4275	Mercury Marine	12-38753	443	1	18-4340	Mercury Marine	27-13461A89	431
	18-4275	Mercury Marine	12-824793	443	1	18-4340	Mercury Marine	27-13461A90	431
	18-4276	OMC	324334	303, 327	1	18-4341	Volvo	27-13461A99	431
	18-4277	OMC	324430	303, 327	1	18-4342	Volvo	876380	999
	18-4280	OMC	327861	310	1	18-4342	Volvo	876376	999
	18-42850	Suzuki	12151-94400	486	1	18-4346	Chrysler Inboard	3745220	599
	18-42860	Suzuki	12151-93100	486	1	18-4347-1			820
	18-4287	Suzuki	12151-92502	423	1	18-4348			820
	18-42870	Suzuki	23-44165	871	1	18-4349			820
1	18-4288	Mercury Marine		871	1	18-4351	Mercury Marine	27-64203A73	432

1 This product is priced per piece. To order, priced per package, please add -9 to the part number

2 Items ending in "D" are display packaged - regular number is non-display

3 For discount shop pack of 10, please add -10 to the part number

SIERRA #	O.E.M.	O.E. #	PAGE #	SIERRA #	O.E.M.	O.E. #	PAGE #
SIERRA							
18-4353	Mercury Marine	27-72486A76	433	18-4406	OMC/Bombardier	437155	323
18-4353	Mercury Marine	27-72486A78	433	18-4407	Yamaha	6H4-W0001-01-00	Obsolete
18-4353	Mercury Marine	27-72486A79	433	18-4407	Yamaha	6H4-W0001-A1-00	Obsolete
18-4354	Mercury Marine	27-73645A32	Obsolete	18-4408	Crusader	33393	629
18-4354	Mercury Marine	27-73645A76	Obsolete	18-4408	Mercury Marine	27-11977	820
18-4354	Mercury Marine	27-73645A87	Obsolete	18-4408	Mercury Marine	27-11987	820
18-4355	Mercury Marine	27-55306A72	433	18-4408	OMC	912978	924
18-4355	Mercury Marine	27-55306A73	433	18-4408	Volvo	3850379	989
18-4355	Mercury Marine	27-55306A75	433	18-4409	Yamaha	6H4-W0001-03-00	Obsolete
18-4355	Mercury Marine	27-55306A75	433	18-4409	Yamaha	6H4-W0001-04-00	Obsolete
18-4355	Mercury Marine	27-78028A78	433	18-44092	Mercury	32-861635	771
18-4356	Mercury Marine	27-60476A72	433	18-4411	Yamaha	6N6-W0001-03-00	537
18-4356	Mercury Marine	27-60476A73	433	18-4411	Yamaha	6N6-W0001-A3-00	537
18-4356	Mercury Marine	27-60476A74	433	18-4412	Yamaha	6R3-W0001-03-00	Obsolete
18-4356	Mercury Marine	27-60476A75	433	18-4412	Yamaha	6R3-W0001-A3-00	Obsolete
18-4356	Mercury Marine	27-85653A32	433	18-4413	Yamaha	6R6-W0001-01-00	538
18-4356	Mercury Marine	27-85653A79	433	18-4415	Yamaha	688-W0001-00-00	538
18-4356	Mercury Marine	27-85653A87	433	18-4415	Yamaha	688-W0001-A0-00	538
18-4357	Mercury Marine	27-73440A76	434	18-4417	Yamaha	695-W0001-01-00	538
18-4357	Mercury Marine	27-76589A77	434	18-4417	Yamaha	695-W0001-02-00	538
18-4357	Mercury Marine	27-76589A78	434	18-4417	Yamaha	695-W0001-A2-00	538
18-4357	Mercury Marine	27-76589A79	434	18-4419	Yamaha	6H4-W0001-02-00	538
18-4357	Mercury Marine	27-88449A32	434	18-4419	Yamaha	6H4-W0001-A2-00	538
18-4357	Mercury Marine	27-88449A80	434	18-4420	OMC/Bombardier	439202	323
18-4359	Mercury Marine	27-815791A92	434	18-4421	OMC/Bombardier	5000400	323
18-4359	Mercury Marine	27-815792A90	434	18-4422	Yamaha	6L2-W0001-01-00	Obsolete
18-4359	Mercury Marine	27-815809A90	434	18-4422	Yamaha	6L2-W0001-02-00	Obsolete
18-4359	Mercury Marine	27-815810A90	434	18-4422	Yamaha	6L2-W0001-A2-00	Obsolete
18-4360	Barr	CM206672JP	605	18-4427	Yamaha	6H3-W0001-A0-00	538
18-4361	Barr	CM-20-6674P	605	18-4428	OMC/Bombardier	437725	323
18-4362	Barr	MC20-60426P	796, 798	18-4429	OMC/Bombardier		323
18-4363	Barr	FM-1-83-P	588, 627, 648, 659, 660, 798, 917	18-4434	Nissan/Tohatsu	3C8-87121-4	476
18-4364	Barr	20-0082-P	648	18-4435	Nissan/Tohatsu	3F3871210M	476
18-4365	Mercury Marine	27-801855	822	18-4436	Nissan/Tohatsu	3B7871218M	476
18-4366	Mercury Marine	27-72479	824	18-4442	Mercury Marine	91-37384	229, 858
18-4366	Mercury Marine	27-72479A5	823, 823, 824	18-4442	Mercury Marine	91-48347	229, 858
18-4366	Mercury Marine	27-72479T	824	18-4442	Mercury Marine	91-57797A1	229, 858
18-4367	Mercury Marine	27-99777A1	820	18-4442	Mercury Marine	91-57797A2	229, 858
18-4369			924	18-4442	Mercury Marine	91-57797A3	229, 858
18-4370			Obsolete	18-4442	Mercury Marine	91-8M0067546	229, 858
18-4371			924	18-4444	Mercury Marine	91-38277A1	457, 865
18-43716	Yamaha	93604-18080-00	515, 522	18-4444	Mercury Marine	91-95830	457, 865
18-43717	Yamaha	93604-10M03-00	559	18-4444	Mercury Marine	91-95830A1	457, 865
18-4373			924	18-4444			650, 943
18-4374			924	18-4446			256, 457, 650, 865
18-4375	Mercury Marine	27-34213A1	824	18-4454			230
18-4375	Mercury Marine	27-34213A2	824	18-4455			230
18-4377	Mercury Marine	27-42457A1	Obsolete	2 18-4456	Mercury Marine	34765A1	122, 874
18-4378	Mercury Marine	27-54529A1	Obsolete	2 18-4456	Mercury Marine	34765A2	874
18-4380	Mercury Marine	27-68714	824	2 18-4457	Mercury Marine	12644A1	586, 597, 619, 650
18-4380	Mercury Marine	27-68714A6	824	2 18-4457	Mercury Marine	12644Q01	122, 874
18-4380	Mercury Marine	27-68714A7	824	2 18-4457			586, 597, 619, 650
18-4380	Mercury Marine	27-72098	824	2 18-4458			122, 586, 597, 619, 650, 874
18-4381	Mercury Marine	27-41836A1	823				850, 874
18-4381	Mercury Marine	27-43186A1	823	18-4459	Mercury Marine	91-821887A1	457, 865
18-4381	Mercury Marine	27-89656A1	823	18-4459	Mercury Marine	91-859046Q4	457, 865
18-4382	Mercury Marine	27-74264A1	823	18-4459	Mercury Marine	91-859046T4	457, 865
18-4382	Mercury Marine	27-74830A1	823	18-4461	Mercury Marine	22-807155	661, 801
18-4382	Mercury Marine	27-74830A3	823	18-4461		588, 606, 628, 650, 661, 916, 990	
18-4383			821	18-4463	Volvo	833188	994
18-4384			821	18-4464	Volvo	829620	994
18-4385			822	18-4465	Volvo	3582609	994
18-4386			821	18-4466	Volvo	838637	994
18-4387	Mercury Marine	27-801853	822	18-4467	Volvo	1542472	994
18-4388	Mercury Marine	27-11977A88	822	18-4468	Volvo	419734	994
18-4388	Mercury Marine	27-11977A92	822	18-4469	Volvo	1542389	994
18-4389	Mercury Marine	27-47453A1	822	18-4470	Volvo	419735	994
18-4391	Mercury Marine	27-64763A2	Obsolete	18-4471	Volvo	838638	994
18-4392	Mercury Marine	27-75611A1	822	18-4472	Volvo	1218630	994
18-4392	Mercury Marine	27-75611A2	822	18-4473	Volvo	419653	994
18-4394	Mercury Marine	27-33395A1	820	18-4473	Volvo	3582561	994
18-4394	Mercury Marine	27-33395A2	820	18-4474	Volvo	419652	994
18-4395	Mercury Marine	27-35898A2	821	18-4474	Volvo	3582606	994
18-4395	Mercury Marine	27-35898A3	821	18-4484HP	GM		667
18-4395	Mercury Marine	27-35898A4	821	18-4485	Mercury Marine	938-883490	S/S to 18-4485HP
18-4396	Mercury Marine	27-46401A1	821	18-4485	Mercury Marine	938-883490R1	S/S to 18-4485HP
18-4397	Mercury Marine	27-46820A1	Obsolete	18-4485	Mercury Marine	938-883490R50	S/S to 18-4485HP
18-4398	Mercury Marine	27-53354A1	821	18-4485	Mercury Marine	938-884741R	S/S to 18-4485HP
18-4399	Mercury Marine	27-54566A1	821	18-4485	Mercury Marine	938-884741R50	S/S to 18-4485HP
18-4400	Yamaha	61A-W0001-01-00	537	18-4485			S/S to 18-4485HP
18-4400	Yamaha	61A-W0001-A1-00	537	18-4485HP	GM		667
18-4402	OMC/Bombardier	437779	323	18-4486	Mercury Marine	938-803860T	S/S to 18-4486HP
18-4403	Yamaha	6F3-W0001-04-00	537	18-4486	Mercury Marine	938-883297 1	S/S to 18-4486HP
18-4403	Yamaha	6F3-W0001-A4-00	537	18-4486			S/S to 18-4486HP
18-4404	Yamaha	6G5-W0001-03-00	Obsolete	18-4486HP	GM		667, 808, 920, 996
18-4404	Yamaha	6G5-W0001-A3-00	Obsolete	18-4489	Mercury Marine	936-810840	Obsolete
18-4405	Yamaha	6H1-W0001-00-00	537	18-4489	Mercury Marine	936-986767	Obsolete
18-4405	Yamaha	6H1-W0001-01-00	537	18-4489			Obsolete
18-4405	Yamaha	6H1-W0001-A0-00	537	18-4491	Mercury Marine	938-827178	Obsolete

1 This product is priced per piece. To order, priced per package, please add -9 to the part number

2 Items ending in "D" are display packaged - regular number is non-display

3 For discount shop pack of 10, please add -10 to the part number

SIERRA #	O.E.M.	O.E. #	PAGE #	SIERRA #	O.E.M.	O.E. #	PAGE #
SIERRA							
18-4491			Obsolete	18-4631	Chrysler Force	700-834794A5	251
18-4492	Mercury Marine	35329	666, 809	18-4632	Chrysler Force	700-834800A4	251
18-4492	Mercury Marine	F3746241	666, 809	18-4633	Chrysler Force	700-834800A5	251
18-4492	Mercury Marine	F1100014	666, 809	18-4634	Chrysler Force	700-834800A6	251
18-4492	Mercury Marine	F11000495	666, 809	18-4635	Mercury Marine	785-9737T9	424
18-4493HP	GM		667	18-4636	Mercury Marine	785-9738T9	424
18-4497	GM		668	18-4637	Mercury Marine	785-9737A10	424
18-45003	Chrysler Force	47-F433065	248	18-4638	Mercury Marine	785-9738T10	424
18-4501			S/S to 18-4501HP	18-4639	Mercury Marine	700-858294T1	424
18-4501HP	GM		668, 808, 920, 996	18-4640	Mercury Marine	700-858295T1	424
18-4503			668	18-4641	Mercury Marine	700-878571A2	424
18-4506			666	18-4642	Mercury Marine	700-878572A2	424
18-4507			666	18-4643	Mercury Marine	700-878573A2	424
18-4508			Obsolete	18-4644	Mercury Marine	700-878574A2	424
18-4515	Mercury Marine	774-9137A10	421	18-4697			990
18-4516			668	18-4698	Mercury Marine	27-81987	443
18-4517			668	18-4698	Mercury Marine	27-81987M	443
18-4518			668	18-4698	Yamaha	90430-08020-00	880, 1003
18-4519			668	18-46981-9	Mercury Marine	27-81987M	443, 462, 462
18-4521			668	18-46981-9	Yamaha	90430-08020-00	880, 1003
18-4522			668	18-4712			313
18-4529	OMC	396644	303, 304	18-4726			Obsolete
18-45221	OMC	382221	295	18-4727			Obsolete
18-4523			668	18-4729			Obsolete
18-4527	Yamaha	6FM-W0078-00-00	523	18-4730			Obsolete
18-4531	Mercury	821354A2	416	18-4731			Obsolete
18-45312	Mercury	47-95289	411	18-4732			Obsolete
18-45312	Mercury	47-952892	411	18-4733			Obsolete
18-45312	OMC	114812	295	18-4734			Obsolete
18-4532	Yamaha	6EG-W0078-00-00	523	18-4735			668
18-4533	Yamaha	65N-W0078-A0-00	523	18-4736			Obsolete
18-4534	Yamaha	69M-WG078-00-00	523	18-4737			669
18-4535	Mercury Marine	774-9137A14	Obsolete	18-4749-9	OMC	3852568	931, 932
18-4535	Mercury Marine	776-8898A2	Obsolete	18-4750	OMC	983967	931, 942
18-4536	Honda	06192-ZV4-A00	263	18-4801	OMC	5000356	932
18-4537	OMC	5008972	302	18-4804	OMC	986381	932
18-4539	Johnson/Evinrude	5008967	294	18-4804	OMC	984770	932
18-45404	Nissan/Tohatsu	353650210M	476	18-4805	OMC	984771	932
18-4546	Yamaha	6EE-G4322-00	522	18-4805	OMC	986382	932
18-4547	Yamaha	6EG-G4322-00	523	18-4806	OMC	984765	932
18-4548	Yamaha	6L2-44322-00	523	18-4806	OMC	986380	932
18-4549	Johnson/Evinrude	339486	302, 303	18-4807	OMC	439476	350, 355
18-4551	Johnson/Evinrude	324641	303	18-4826	OMC	331999	346
18-4560	Mercury Marine	765-7443A12	424	18-4828	OMC	911750	931, 942
18-4560	Mercury Marine	765-7443A2	424	18-4830	Mercury Marine	1667-9011G59	455
18-4565	Mercury Marine	766-8667A36	424	18-48317	Mercury	46-803750A03	416, 476
18-4565	Mercury Marine	766-8667A43	424	18-48317	Nissan/Tohatsu	382873222M	416, 476
18-4567	Yamaha	6EE-G4311-00	522	18-4832	Mercury Marine	1647-9148T93	455
18-4568	Johnson/Evinrude	5007554	297	18-4833	OMC	915720	908
18-45617-1	Yamaha	6CE-44352-00-00	514	18-4835	OMC	912029	931, 938
18-4569	Johnson/Evinrude	339720	297	18-4837	OMC	911734	908, 931
18-4571	Johnson/Evinrude	360347	297	18-4840	OMC	435277	346
18-45712	Jabco	17636-0001	574	18-4841	OMC	435278	346
18-45712	Jabco	21676-0001	574	18-4843	OMC	435279	346
18-45712	Johnson Pump	09814B	575	18-4850	Mercury Marine	1667-9011R6	Obsolete
18-45713	Jabco	18653-0001	573	18-4858-9	Mercury Marine	12-45176	443
18-45713	Johnson Pump	09-810B	575	18-48619	Yamaha	68D-WG078-00-00	522
18-45714	Yanmar	119574-42550	689	18-4901			230, 334
18-45714	Yanmar	119574-42552	689	18-4904			230, 334
18-4572	Yamaha	6CB-44323-00-00	522	18-4911	OMC	322236	230, 334
18-4573	Yamaha	6EE-G4323-00	522	18-4911	OMC	772577	230, 334
18-4574	Yamaha	6EG-G4323-00	523	18-4913	OMC	316705	230, 334
18-4575			424	18-4913	OMC	772578	230, 334
18-4576	Yamaha	6FM-44323-01	523	18-4914	OMC	316706	230, 334
18-4577	Mercury	8213542	411, 416	18-4914	OMC	772579	230, 334
18-4578	Johnson/Evinrude	324640	303	18-4915	Mercury Marine	50-12066A1	394
18-4579	Johnson/Evinrude	338485	302, 303	18-4915	Mercury Marine	50-12066A9	394
18-4580			424	18-4915	Mercury Marine	50-12066Q9	394
18-4620	Mercury Marine	743-3193A2	421	18-4915	Mercury Marine	50-22791A1	394
18-4620	Mercury Marine	743-3193A4	421	18-4915	Mercury Marine	50-28985A2	394
18-4620	Mercury Marine	743-5172A6	421	18-4915	Mercury Marine	50-45093	394
18-4620	Mercury Marine	780-9229A7	421	18-50000	Yamaha	689-15755-01-00	499
18-4621	Mercury Marine	743-3366A1	421	18-50000	Yamaha	6G1-15779-00-00	499
18-4621	Mercury Marine	743-3366A2	421	18-50001	Yamaha	6G1-15755-00-00	499
18-4621	Mercury Marine	780-9229A10	421	18-50001	Yamaha	6G1-15779-00-00	499
18-4622	Mercury Marine	743-7716A2	421	2	18-5001	OMC	172525
18-4622	Mercury Marine	780-9229A11	421	18-500-1212			104
18-4623	Mercury Marine	777-815965A4	421	18-500-1238			104
18-4623	Mercury Marine	777-815965T4	421	18-500-1414			104
18-4624	Mercury Marine	777-815965A5	421	18-500-1418			104
18-4625	Mercury Marine	777-815965A6	421	2	18-5002	OMC	172523
18-4626	Mercury Marine	2704-812896A2	421	2	18-5003	OMC	172806
18-4626	Mercury Marine	2704-821896A6	421	18-500-3814			104
18-4626	Mercury Marine	2704-826191A4	421	18-500-3818			104
18-4626	Mercury Marine	2704-826191A6	421	18-500-3838			104
18-4626	Mercury Marine	2704-826191T4	421	18-500-5614			104
18-4627	Mercury Marine	2704-821896A3	421	18-500-5618			104
18-4628	Mercury Marine	2704-821896A4	421	18-500-5838			104
18-4629	Chrysler Force	700-834794T3	251	2	18-5006	OMC	172522
18-4630	Chrysler Force	700-834794A4	251	18-5007			270

1 This product is priced per piece. To order, priced per package, please add -9 to the part number

2 Items ending in "D" are display packaged - regular number is non-display

3 For discount shop pack of 10, please add -10 to the part number

SIERRA #	O.E.M.	O.E. #	PAGE #	SIERRA #	O.E.M.	O.E. #	PAGE #
SIERRA							
18-5011	OMC	172521	270	18-5154	Mercury Marine	339-880615T01	376
18-5012			374	18-5156	OMC	580148	270
18-5013			239	18-5157	OMC	580290	270
18-5021	Mercury Marine	805629	798	18-5158	Mercury/Mercruiser	879984A1	376
18-502-1234			104	18-5158	Mercury/Mercruiser	879984T00	376
18-502-1278			104	18-5158	Mercury/Mercruiser	879984T01	376
18-502-1476			104	18-5158	Mercury/Mercruiser	8M0077471	376
18-502-3834			Obsolete	18-5159	Mercury/Mercruiser	339-883778A01	376
18-502-3858			104	18-5159	Mercury/Mercruiser	339-883778A02	376
18-502-5612			104	18-5159	Mercury/Mercruiser	339-8M0077473	376
18-502-5658			104	18-5163	OMC	581130	271
18-51000	Nissan/Tohatsu	3AA050040M	477	18-5165	NISSAN	3G3080211M	473
18-51001	Yamaha	63V-15713-00-00	550	18-5166	Nissan/Tohatsu	3G2-06040-2	473
18-51002	Yamaha	67D-15713-00-00	550	18-5166	Nissan/Tohatsu	3M3060482M	473
18-51003	Yamaha	66T-15713-00-00	550	18-5169	Chrysler Force	F12042-1	239
18-5102	Chrysler Inboard	3656017	592	18-5169	Mercury Marine	394-1130	375
18-5103	Chrysler Inboard	3780600	593	18-5169	Mercury Marine	394-1130A1	375
18-5105	Chrysler Inboard	3874020	593	18-5169	Mercury Marine	397-359	375
18-5107-1	Crusader	7243110	614	18-5169	Mercury Marine	397-741	375
18-5107-1	Mercury Marine	802464	698	18-5170	OMC	583298	271
18-5107-1	Mercury Marine	804412	698	18-5170	OMC	583740	271
18-5107-1	Mercury Marine	811637	698	18-5172	OMC	502881	271
18-5107-1	Mercury Marine	850487	698	18-5172	OMC	581786	271
18-5107-1	Mercury Marine	811637001	698	2	18-5176	OMC	582366
18-5107-1	Mercury Marine	811637002	698	2	18-5176	OMC	583737
18-5107-1	Mercury Marine	811637T	698	2	18-5176	OMC	584561
18-5107-1	OMC	3854003	882	2	18-5179	OMC	582508
18-5107-1	Volvo	3854003	959	2	18-5181	Mercury Marine	802371A1
18-5108	Mercury Marine	811639	698	2	18-5181	OMC	582995
18-5108	Mercury Marine	811639T	698	2	18-5181	OMC	584477
18-5108	OMC	986642	882	18-5182	Mercury Marine	823033	Obsolete
18-5108	OMC	3854001	882	18-5182	Nissan/Tohatsu	3F0-06153-0	Obsolete
18-5108	Volvo	3854001	659	18-5182	Nissan/Tohatsu	3F0060491M	Obsolete
18-5108			614	18-5182	Nissan/Tohatsu	3F0061530M	Obsolete
18-5110	Yamaha	6E5-85570-11-00	491	18-5183	Yamaha	63V-85520-00	491
18-5111	Yamaha	697-85570-11-00	491	18-5183	Yamaha	63V-85520-01	491
18-5112	Yamaha	680-85570-09-00	491	2	18-5186	Chrysler Force	339-7370A13
18-5112	Yamaha	695-85570-10-00	491	2	18-5186	Chrysler Force	339-7370B13
18-5112	Yamaha	6E7-85570-10-00	491	2	18-5186	Chrysler Force	339-832757B4
18-5112	Yamaha	6E7-85570-19-00	491	2	18-5186	Mercury Marine	339-7370A13
18-5113	Yamaha	61N-85570-00-00	491	2	18-5186	Mercury Marine	339-832757A4
18-5113	Yamaha	61N-85570-10-00	491	18-5187	Mercury Marine	339-850227	376
18-5116-1	Mercury Marine	87-861780A2	698	18-5187	Mercury Marine	339-856991A1	376
18-5116-1	Mercury Marine	87-861780Q4	698	18-5192	OMC	502888	271
18-5116-1	Mercury Marine	87-892150A02	698	18-5192	OMC	581610	271
18-5117	GM	10482803	698	18-5192	OMC	582091	271
18-5119	Yamaha	65E-85570-00-00	Obsolete	18-5193	OMC	580740	Obsolete
18-5128	Yamaha	6R3-85570-01-00	491	18-5193	OMC	582382	Obsolete
18-5129	Yamaha	62L-85570-00-00	570	18-5194	OMC	502890	271
18-5130	Yamaha	688-85540-16-00	491	18-5194	OMC	581032	271
18-5131	Yamaha	695-85540-12-00	491	18-5194	OMC	582160	271
18-5132	Yamaha	63V-85540-00-00	491	18-5194	OMC	584632	271
18-5132	Yamaha	63V-85540-01-00	491	18-5195	Yamaha	689-81311-40-00	491
18-5132	Yamaha	63V-85540-02-00	491	18-5196	OMC	502880	271
18-5133	Tohatsu	3A0060401M	473	18-5196	OMC	581407	271
18-5133	Tohatsu	3A0060481M	473	18-5199	OMC	580321	270
18-5134	Tohatsu	3G2060602M	473	18-5200	OMC	580256	270, 880
18-5135	Yamaha	6E5-85540-10-00	492	18-5205	OMC	581419	
18-5135	Yamaha	6E5-85540-11-00	492	18-5206	Chrysler/Force	398-176	241
18-5135	Yamaha	6E5-85540-12-00	492	18-5206	Mercury Marine	398-693	375
18-5136	Yamaha	6F5-85540-21-00	492	18-5207	Mercury Marine	398-713	375
18-5136	Yamaha	6F5-85540-22-00	492	18-52104			218
18-5138	Yamaha	680-85570-00-00	491	18-5217-1	Yamaha	67F-82341-00-00	492
18-5138	Yamaha	680-85570-02-00	491	18-5218-1	Yamaha	67F-82342-00-00	492
18-5139	Mercury Marine	336-3948A2	374	18-5219-1	Yamaha	67F-82343-00-00	492
18-5139	Mercury Marine	336-3948A3	374	18-5220-1	Yamaha	67F-82344-00-00	492
18-5139	Mercury Marine	336-4318A2	374	18-52204			218
18-5139	Mercury Marine	336-4318A3	374	18-52205	Universal		218
18-5139	Mercury Marine	336-4318A4	374	18-52206	Universal		218
18-5140	Mercury Marine	398-2202	375	18-52207	Universal		217
18-5141	OMC	581207	270	18-5222			241, 889
18-5143	Tohatsu	369060210M	473	1	18-5224	Mercury Marine	20121
18-5144	Suzuki	32900-93911	478	1	18-5224	Mercury Marine	8M0084600
18-5146	Yamaha	62T-85533-00-00	570	1	18-5224	OMC	510364
18-5147	Yamaha	62T-85520-00-00	570	1	18-5224		241, 258, 473, 478, 493
18-5147	Yamaha	62T-85520-01-00	570				
18-5148	Mercury Marine	394-1100A2	375	18-5225	Mercury Marine	84-813706A26	381, 714
18-5148	Mercury Marine	394-1100A3	375	18-5225	Mercury Marine	84-90816A26	381, 714
18-5148	Mercury Marine	394-352A1	375	18-5225	Mercury Marine	84-93212A1	381, 714
18-5149	Chrysler Force	F12044	239	18-5225	Mercury Marine	84-93475A26	381, 714
18-5149	Chrysler Force	FP2437A	239	18-5225	Mercury Marine	84-99215A26	381, 714
18-5150	Chrysler Force	817784A2	Obsolete	18-5225			258, 277, 372, 473
18-5150	Chrysler Force	FA305310-2	Obsolete	18-5226	OMC	510883	277
18-5151	Suzuki	33410-92L10	478	18-5226	OMC	772584	277
18-5151	Suzuki	33410-94400	478	18-5226			241, 258, 372, 381, 473
18-5152	Suzuki	32140-93900	478	2	18-5227-1	Mercury Marine	84-813715A1
18-5153	McCulloch	1340135	372	2	18-5228-1	Mercury Marine	84-813715A1
18-5153	McCulloch	36550135	372	2	18-5228-1		189, 241, 380
18-5153	McCulloch	75101A	372	2	18-5229-9-1		189, 241, 276, 380
18-5153	Mercury Marine	398-174	375	2	18-5230-9-1		189, 241, 276, 380

1 This product is priced per piece. To order, priced per package, please add -9 to the part number

2 Items ending in "D" are display packaged - regular number is non-display

3 For discount shop pack of 10, please add -10 to the part number

SIERRA #	O.E.M.	O.E. #	PAGE #	SIERRA #	O.E.M.	O.E. #	PAGE #	
SIERRA								
2	18-5231-1	OMC	582365	189, 276	18-5303	Mercury Marine	392-898253005	695
	18-5239			185, 188, 961	18-5303	Mercury Marine	8M6001219	695
	18-5240			185, 188, 961	18-5303	Mercury Marine	F16900031	695
	18-5241	Chrysler Force	F12181-1	240	18-5303	OMC	980893	881
	18-5241	McCulloch	38850115	240	18-5303	OMC	987136	881
	18-5243	Mercury Marine	688731	696	18-5303	OMC	987894	881
	18-5243	Mercury Marine	898253T23	696	18-5303	Pleasurecraft	R114002	636
	18-5244	Mercury Marine	884792	696	18-5303	Volvo	835705	957
	18-5244	Mercury Marine	898253T22	696	18-5303	Volvo	855846-2	957
	18-5244	Pleasurecraft	RA108009	696	18-5303			578
	18-5245	Mercury Marine	884790	696	18-5305	Volvo	243460	957
	18-5245	Mercury Marine	898253013	696	18-5305	Volvo	243799	957
	18-5245	Pleasurecraft	R103011	638	18-5305	Volvo	1306169	957
	18-5246	Mercury Marine	898253T28	694	18-5306	Volvo	240149	957
	18-5247	Mercury Marine	898253T29	694	18-5307	Chrysler Inboard	1274092	590
	18-5247	Mercury Marine	8M0060495	694	18-5307	Chrysler Inboard	2084074	590
	18-5247	Mercury Marine	8M0061385	694	18-5307	Chrysler Inboard	2421178	590
	18-5248	OMC	3854217	862	18-5307	Crusader	705788	609
	18-5248	Volvo	3854217	968	18-5307			578, 651
2	18-5250	Mercury Marine	34235Q1	694	18-5309-1	Mallory	YL512CV	183, 613, 640
2	18-5250	Mercury Marine	34235T1	694	18-5309-1	OMC	980902	887
2	18-5250	OMC	172527	888	18-5309-1	Pleasurecraft	RA107001	640
2	18-5250			578, 607	18-5310	Crusader	12525	609
2	18-5251	OMC	173619	888	18-5310	Mercury Marine	33700	695
2	18-5251			578, 590, 607, 637, 694	18-5310	OMC	380543	881
	18-5252			578, 607, 694, 880	18-5310	Volvo	818701-5	957
	18-5253			694	18-5310			579, 651
2	18-5254			694	18-5311	Chris-Craft	16.69-00049	579
	18-5255			578, 590, 607, 637	18-5311	Mercury Marine	34235	698
	18-5256	OMC	172531	880	18-5311	Mercury Marine	34235T	698
	18-5256			578, 607, 957	18-5311	OMC	380538	881
2	18-5258	OMC	173690	880	18-5311			609, 651
2	18-5258	OMC	987925	880	18-5312-1	Mallory	YL554CV	183, 640, 702, 887
2	18-5258			578, 590, 608, 694	18-5312-1	OMC	981080	887
2	18-5259			578, 590, 608	18-5313-1	Crusader	37061	613
2	18-5260	OMC	173829	880	18-5313-1	Mallory	YL624AV	183, 702
2	18-5260	OMC	987926	880	18-5313-1	Mallory	YL624MW	582, 613, 640, 887
2	18-5260			578, 590, 608, 637, 694, 957	18-5313-1	Mercury Marine	13447A1	702
	18-5264			957	18-5313-1	Mercury Marine	17177A1	702
	18-5265			957G7618	18-5313-1	Mercury Marine	68521A3	702
	18-5266			Obsolete	18-5313-1	Mercury Marine	68521A4	702
	18-5267			694	18-5313-1	Mercury Marine	74905A3	702
	18-5268			578, 631, 651, 694, 880	18-5313-1	Mercury Marine	816148A1	702
	18-5269			578, 631, 651, 694, 880	18-5313-1	Mercury Marine	91823A3	702
	18-5270			Obsolete	18-5313-1	OMC	985560	887
	18-5271			578, 608, 631, 637, 694, 880	18-5314	Chris-Craft	16.69-00039	579
	18-5272			578, 608, 880	18-5314	Chrysler Inboard	2421620	590
	18-5273	Mercury Marine	805759Q3	695	18-5314	Crusader	20117	609
	18-5273	Mercury Marine	805759T3	695	18-5314	Mercury Marine	391-5090	695
	18-5274			695	18-5314	Mercury Marine	391-898253004	695
	18-5275			578, 608, 631, 637, 695, 880	18-5314	Mercury Marine	8M6001250	695
	18-5276			578, 608, 638, 695, 881	18-5314	OMC	382135	881
	18-5277	Indmar	755021	631	18-5314	Pleasurecraft	R114001	638
	18-5277			578, 609, 638, 695, 881	18-5314	Pleasurecraft	R114004	638
	18-5278	Mercury Marine	850484T3	695	18-5314	Volvo	835304	957
	18-5278			609, 631, 638, 881, 1012	18-5315-1	Mallory	YL673AV	183, 702, 887
	18-5279			609, 631, 881	18-5315-1	Mercury Marine	33266	702
	18-5280	Mercury Marine	811635Q2	695	18-5315-1	Mercury Marine	52352	702
	18-5280			609, 631, 881, 1012	18-5315-1	Mercury Marine	58231	702
	18-5281	Mercury Marine	808483Q2	695	18-5315-1	Mercury Marine	62424	702
	18-5281			609, 631, 638, 881	18-5315-1	Mercury Marine	87581	702
	18-5282			695	18-5315-1	Mercury Marine	195141	702
	18-5283			631, 695, 881	18-5315-1	Mercury Marine	87581T	702
2	18-5284			957	18-5316-1	Mallory	YL624BV	183, 702, 887
	18-5285			663, 698, 884	18-5317	Mercury Marine	64850	695
	18-5286			Obsolete	18-5317	Mercury Marine	87-71831	695
	18-5287-1			184, 884	18-5317			638
	18-5288			581, 611, 639, 663, 698, 884, 961	18-5318	Crusader	3000124	609
	18-5289			581, 611, 639, 663	18-5318	Mercury Marine	58033	695
	18-5290			581, 611, 639, 663, 698, 884, 961	18-5318	Mercury Marine	898253007	695
	18-5291	Mercury Marine	808483K2	694	18-5319	Volvo	243801	957
	18-5292			961	18-5338	Chris-Craft	16.69-00040	579
	18-5293-1			884	18-5338	Crusader	12530	609
	18-5294			581, 611, 639, 663, 698, 884, 961	18-5338	Mercury Marine	391-5092	696
	18-5295			581, 592, 612, 639, 698, 884, 961	18-5338	Mercury Marine	391-5092	696
2	18-5296-2			581, 612, 639, 699, 885	18-5338	Mercury Marine	391-5093	696
2	18-5297			699, 885	18-5338	Mercury Marine	391-898253001	696
2	18-5298			581, 612, 639, 699, 885	18-5338	Mercury Marine	8M6001217	696
2	18-5299			581, 612, 640, 699	18-5338	Mercury Marine	F16900040	696
	18-5300	Mercury Marine	33707	696	18-5338	OMC	382136	881
	18-5300			579, 591, 609, 610, 638, 695	18-5338	Pleasurecraft	R115001	638
	18-5301			882, 958, 1012	18-5338	Volvo	835308	957
	18-5302			579, 591, 609, 610, 638, 695, 882, 958, 1012	18-5338			590
	18-5303	Chrysler Inboard	2421173	590	18-5339-1	Mallory	9-26103	703, 887
	18-5303	Chrysler Inboard	2808870	590	18-5339-1	Mallory	YL566AV	183, 703, 887
	18-5303	Crusader	41058	609	18-5342	Volvo	243653	Obsolete
	18-5303	Indmar	751007	633	18-5344	Crusader	12526	609
	18-5303	Mercury Marine	392-6325	695	18-5344	Mercury Marine	33706	696
					18-5344	OMC	382125	881
								579

1 This product is priced per piece. To order, priced per package, please add -9 to the part number

2 Items ending in "D" are display packaged - regular number is non-display

3 For discount shop pack of 10, please add -10 to the part number

SIERRA #	O.E.M.	O.E. #	PAGE #	SIERRA #	O.E.M.	O.E. #	PAGE #
SIERRA							
18-5345	Chris-Craft	16.69-00050	579	18-5375	Chris-Craft	F16900165	579
18-5345	Chrysler Inboard	2098058	590	18-5375	Crusader	12532	611
18-5345	Chrysler Inboard	2279949	590	18-5375	Crusader	1003317	611
18-5345	Crusader	41057	609	18-5375	OMC	382133	882
18-5345	Crusader	705787	609	18-5375	Volvo	841244	958
18-5345	Indmar	755017	631	18-5376	Chris-Craft	16.69-00148	579
18-5345	Mercury Marine	6325	696	18-5376	Crusader	20222	611
18-5345	Mercury Marine	33662	696	18-5376	Mercury Marine	391-5075	697
18-5345	Mercury Marine	898253003	696	18-5376	Mercury Marine	391-5075Q1	697
18-5345	Mercury Marine	898253005	696	18-5376	Mercury Marine	F16900148	697
18-5345	Mercury Marine	33662Q	696	18-5376	OMC	982209	882
18-5345	Mercury Marine	8M6001218	696	18-5376	Pleasurecraft	R108001	639
18-5345	Mercury Marine	F16900031	696	18-5376			590
18-5345	OMC	380537	881	18-5384	Crusader	12528	611
18-5345	Pleasurecraft	R115002	638	18-5384	Mercury Marine	33708	697
18-5345	Volvo	835704	957	18-5384	OMC	383587	882
18-5345			651	18-5385	Chris-Craft	16.69-00052	579
18-5346	Chris-Craft	1869704	579	18-5385	Mercury Marine	33667	697
18-5346	Mercury Marine	58034	696	18-5385	Mercury Marine	393-9459	697
18-5346	Mercury Marine	81-64851	696	18-5385	Mercury Marine	393-9459Q1	697
18-5346			638	18-5385	Mercury Marine	393-9459T	697
18-5347	Chrysler Inboard	1818757	590	18-5385	Mercury Marine	F16900052	697
18-5347	Chrysler Inboard	3420600	590	18-5385	OMC	380541	882
18-5347	Mercury Marine	392-6324	696	18-5385			651
18-5347	Mercury Marine	392-898253002	696	18-5386	Mercury Marine	33765	697
18-5347	Mercury Marine	8M6001249	696	18-5386	Mercury Marine	33765T	697
18-5347	Mercury Marine	F16900023	696	18-5386	OMC	980152	882
18-5347	Mercury Marine	F16900032	696	18-5386			579, 611
18-5347	Mercury Marine	F16900083	696	18-5389	Crusader	3000121	611
18-5347	Mercury Marine	F16900189	696	18-5389	Mercury Marine	393-3230	697
18-5347	OMC	980894	881	18-5389	Mercury Marine	393-4988	697
18-5347	OMC	987895	881	18-5389	Mercury Marine	393-4988T	697
18-5347			579, 609, 638, 651	18-5389	Mercury Marine	393-4988T2	697
18-5348	Volvo	834560	957	18-5389			639
18-5348	Volvo	841262	957	18-5393	Volvo	241669	958
18-5349	Volvo	888751A02	701	18-5394	Volvo	243658	958
18-5350	Mercury Marine	888751A03	701	18-5395	Mercury Marine	43557	697
18-5350	Mercury Marine	888751A1	701	18-5395	Mercury Marine	16457A4	697
18-5351	Mercury Marine	884794A02	701	18-5395	Mercury Marine	43557A1	697
18-5351	Mercury Marine	884794A1	701	18-5395	Mercury Marine	805759A1	697
18-5352	Chrysler Inboard	4142817	590	18-5395	Mercury Marine	805759A2	697
18-5352	Crusader	41076	610	18-5395	Mercury Marine	805759A5	697
18-5352	Mercury Marine	392-9766	696	18-5395	Mercury Marine	805759T	697
18-5352	Mercury Marine	392-9766Q1	696	18-5395	Mercury Marine	805759T1	697
18-5352	Mercury Marine	392-9766T	696	18-5395	Mercury Marine	90746A1	697
18-5352	Mercury Marine	F16900185	696	18-5396	Mercury Marine	13753A2	697
18-5352	OMC	984401	882	18-5396	Mercury Marine	815407A2	697
18-5352	Pleasurecraft	RA108003	639	18-5397	Mallory	9-29418	697, 882
18-5352	Volvo	841070	958	18-5397	OMC	965218	882
18-5352	Volvo	3853815	958	18-5399	Crusader	41061	592
18-5352			579	18-5399	Mercury Marine	392-6329	697
18-5353	Crusader	41069	610	18-5399	OMC	910169	925
18-5353	Mercury Marine	392-9086	696	18-5402	Mercury Marine	898253009	696
18-5353	Mercury Marine	392-9086T	696	18-5403	Crusader	41074	609
18-5353	OMC	984398	882	18-5403	Crusader	41089	609
18-5353	Volvo	841926	958	18-5403	Mercury Marine	392-9089	696
18-5354	Crusader	38070	610	18-5403	Mercury Marine	392-9089Q	696
18-5354	Mercury Marine	804418	696	18-5403	Mercury Marine	392-9089T	696
18-5354	Mercury Marine	808483	696	18-5403	Mercury Marine	392-9767	696
18-5354	Mercury Marine	804483T	696	18-5403	Mercury Marine	F16900186	696
18-5354	Mercury Marine	808483T3	696	18-5403	Mercury Marine	F16900190	696
18-5354	OMC	3854548	882	18-5403	OMC	982880	881
18-5354	Volvo	3854548	958	18-5403	Pleasurecraft	R103004	638
18-5354			651	18-5403	Volvo	841907	957
18-5356	Volvo	243797	958	18-5403	Volvo	855845	957
18-5357	Volvo	243632	958	18-5403	Volvo	3853801	957
18-5357	Volvo	870690	958	18-5404-1	Chris-Craft	16.69-00149	579
18-5357	Volvo	1243632	958	18-5404-1	Chrysler Inboard	868096	590
18-5358	Volvo	841263	958	18-5404-1	Crusader	20223	610
18-5359			579, 639, 651	18-5404-1	Mercury Marine	391-5088	696
18-5361	Mercury Marine	811635	696	18-5404-1	Mercury Marine	391-7057	696
18-5361	Mercury Marine	811635T3	696	18-5404-1	Mercury Marine	391-7057T	696
18-5361	OMC	986643	882	18-5404-1	Mercury Marine	391-898253029	696
18-5361			610	18-5404-1	Mercury Marine	8M6001224	696
18-5362	Mercury Marine	850484	695	18-5404-1	Mercury Marine	F16901224	696
18-5362	Mercury Marine	850484T	695	18-5404-1	OMC	982211	881
18-5362	Mercury Marine	850484T2	695	18-5404-1	Pleasurecraft	R103001	638
18-5362	OMC	3854331	882	18-5404-1			957
18-5362	Volvo	3854331	958	18-5405	Crusader	38071	610
18-5362			610	18-5405	Mercury Marine	808484	696
18-5369	Chrysler Inboard	4142408	590	18-5405	Mercury Marine	898253010	696
18-5369	Crusader	41052	610	18-5405	Mercury Marine	808484.1	696
18-5369	Mercury Marine	392-6318	697	18-5405	OMC	3854549	881
18-5369	Mercury Marine	392-6318T	697	18-5405	Volvo	3854549	958
18-5369	Mercury Marine	F16900184	697	18-5405	Volvo	3862014	958
18-5369	OMC	982336	882	18-5406	Mercury Marine	811636	696
18-5369	Pleasurecraft	RA108002	639	18-5406	Mercury Marine	898253011	696
18-5369	Volvo	835702	958	18-5406	Mercury Marine	811636.1	696
18-5369			579	18-5406	OMC	986651	881
18-5375	Chris-Craft	16.69-00100	579	18-5406	Volvo	3854261	958

1 This product is priced per piece. To order, priced per package, please add -9 to the part number

2 Items ending in "D" are display packaged - regular number is non-display

3 For discount shop pack of 10, please add -10 to the part number

SIERRA #	O.E.M.	O.E. #	PAGE #	SIERRA #	O.E.M.	O.E. #	PAGE #
SIERRA							
18-5406			610	18-5466			614
18-5407	Chrysler Inboard	1658535	590	18-5467	Volvo	21436799	959
18-5407	Crusader	41059	610	18-5469		582, 592, 614, 642, 662, 697, 883, 959	701
18-5407	Mercury Marine	392-6326	696	18-5470	Mercury Marine	805185A37	701
18-5407	Mercury Marine	392-6326T	696	18-5471	Mercury Marine	805185A36	701
18-5407	Mercury Marine	FI6900044	696	18-5472		582, 592, 614, 642, 662, 697, 883, 959	701
18-5407	OMC	980892	881	18-5473		590, 610, 639, 664, 697, 882, 958	701
18-5407	Pleasurecraft	R103003	638	18-5474		590, 611, 638, 664, 697, 882, 959	701
18-5407			579	18-5475	Mercury Marine	817377	701
18-5408	Mercury Marine	804424	696	18-5475	Mercury Marine	817377T	701
18-5408	Mercury Marine	850485	696	18-5475		181, 701, 887, 960	701
18-5408	Mercury Marine	8504851	696	18-5476	Mercury Marine	807964A1	701
18-5408	Mercury Marine	898253012	696	18-5476	Mercury Marine	907964A1	701
18-5408	Mercury Marine	8M0062084	696	18-5476		181, 701, 705, 886, 960	701
18-5408	OMC	3854311	881	18-5477		180, 640, 663, 700, 885, 960	701
18-5408	Volvo	3854311	958	18-5477		180, 640, 663, 700, 885, 960	701
18-5408			610	18-5478		582, 614, 632, 641, 663, 700, 885, 960	701
18-5411	Chris-Craft	16.69-00042	579	18-5478		180, 578, 608, 637, 640, 663, 694, 697, 700, 880, 883, 885, 957	701
18-5411	Crusader	12531	610	18-5482		180, 578, 608, 637, 640, 663, 694, 697, 700, 880, 883, 885, 957	701
18-5411	Crusader	1003318	610	18-5483		180, 581, 613, 648, 664, 700, 885, 960	701
18-5411	OMC	982342	882	18-5484-1	Mercury Marine	805222A1	701
18-5411	Volvo	841243	958	18-5484-1		181, 614, 641, 701, 887, 960	701
18-5413	OMC	987986	882	18-5486-2	Mallory	YLM673AV	182, 886
18-5413	Volvo	3854218	958	18-5486-2	Mallory	YLM673AV	182, 886
18-5418	Chris-Craft	16.69-00051	579	18-5487-2	Mallory	YLM676AV	182, 702, 704, 886, 678
18-5418	Mercury Marine	58217	696	18-5488		182, 886	641, 702
18-5418	Mercury Marine	898253008	696	18-5489-2	Mallory	YLM554CV	182, 886
18-5418	Mercury Marine	58217Q	696	18-5489-2		182, 886, 960	641, 702
18-5418	OMC	384735	882	18-5493		182, 641, 702, 886, 960	641, 702
18-5418			610, 651	18-5493		182, 641, 702, 886, 960	641, 702
18-5419	OMC	380542	882	18-5494-2		182, 641, 886	613, 702
18-5419	Volvo	818525	958	18-5495-2	Mallory	YLM512CV	182, 702, 886, 641
18-5419			579, 651	18-5495-2	Mallory	YLM567CV	182, 702, 886, 641
18-5420	Crusader	3000122	610	18-5496-2	Mallory	YLM579AV	182, 702, 886, 641
18-5420	Mercury Marine	65864	696	18-5496-2	Mercury Marine	YLM579AV	182, 702, 886, 641
18-5420	Mercury Marine	78016	696	18-5497-2	Mallory	YLM624BV	182, 703, 887, 960, 181, 703
18-5425	Volvo	834975	958	18-5497-2		181, 703	181, 703
18-5427	Chris-Craft	16.69-00022	579	18-5498-2		181, 703	183
18-5427	Crusader	705786	610	18-5512		183	183
18-5427			651	18-5513		182, 703	182, 703
18-5428	Volvo	243903	958	18-5514		182, 703	182, 703
18-5429	Chrysler Inboard	2098611	590	18-5515		182, 703	182, 703
18-5429			579, 610	18-5516		182, 703	182, 703
18-5430	Chrysler Inboard	868095	590	18-5517		182, 703	182, 703
18-5430			652	18-5518		182, 703	182, 703
2 18-5431	Mercury Marine	13524A5	696	18-5519		182, 703	182, 703
2 18-5431	Mercury Marine	13524T1	696	18-5520	Yanmar	728170-92600	689
2 18-5432	Mercury Marine	13524A4	696	18-55500	Yanmar	728171-92601	689
2 18-5432	Mercury Marine	13524A6	696	18-55502	Yanmar	728271-92605	689
2 18-5432	Mercury Marine	13524Q06	696	18-55503	Mercury	728374-92605	689
2 18-5432	Mercury Marine	19405A4	696	18-55505	Mercury	8M0142679	392
2 18-5432	Mercury Marine	90576A4	696	18-55505	Mercury	8M0137769	392
2 18-5433	Chrysler Inboard	201522	592	18-55510	Yanmar	8M00095471	392
2 18-5433	Chrysler Inboard	2495531	592	18-55600	Yanmar	128170-01331	689
2 18-5433	Crusader	37068	614	18-55601	Yanmar	128171-01911	689
2 18-5433	Crusader	51080	614	18-55602	Yanmar	128271-01911	689
2 18-5433	Delco	1115202	678	18-55603	Yanmar	128374-01911	690
2 18-5433	Mercury Marine	38547	376, 698	18-56000	Yanmar	128170-11310	689
2 18-5433	Mercury Marine	32193A2	376, 698	18-56001		474	
2 18-5433	Mercury Marine	392-806529A1	376, 698	18-56002	Nissan/Tohatsu	3C8750140M	Obsolete
2 18-5433	Mercury Marine	898253T24	376, 698	18-56002	Yamaha	689-81840-11-00	Obsolete
2 18-5433	OMC	915735	883	18-56004	Yamaha	663-81840-11-00	Obsolete
2 18-5433	Pleasurecraft	R117001	643	18-56005	Yamaha	6E5-81840-10-00	479
2 18-5433	Volvo	835998	959	18-56006	Yamaha	6N7-81840-00-00	Obsolete
18-5435	Chrysler Inboard	200691	592	18-56007	Yamaha	61A-81840-00-00	479
18-5435	Crusader	41080	614	18-56008	Suzuki	31173-95310	Obsolete
18-5435			643	18-56009	Suzuki	31173-99E00	479
18-5436	Volvo	35254	959	18-5601	Mercury Marine	50-38890A1	391, 393
18-5436			614	18-5601	Mercury Marine	50-55601	391, 393
18-5437	OMC	378231	883	18-5601	Mercury Marine	50-55601A2	391, 393
18-5437	OMC	383444	883	18-5602	Mercury Marine	50-44369A1	391, 393
18-5438	Crusader	37068	614	18-5602	Mercury Marine	50-58788A3	391, 393
18-5438	Mercury Marine	392-7803A4	698	18-5602	Mercury Marine	50-67341	391, 393
18-5438	Mercury Marine	392-805570A2	698	18-5602	Mercury Marine	50-893891T	391, 393
18-5442	Mercury Marine	806673T	698	18-5603	Mercury Marine	573001	S/S to 18-5603-1
18-5442	Mercury Marine	806673T1	698	18-5603-1	Indmar	573001	633
18-5443	Crusader	7243200	614	18-5603	Indmar	0170-000	636
18-5443	Mercury Marine	817378	678	18-5603-1	Marine Power	0170-000	S/S to 18-5603-1
18-5443	Mercury Marine	817378T	698	18-5603	Marine Power	50-808011A4	714, 716
18-5443	Mercury Marine	898253T27	698	18-5603-1	Mercury Marine	50-808011A4	S/S to 18-5603-1
18-5443	OMC	3854002	883				
18-5443	Volvo	3854002	959				
18-5450	Chrysler Inboard	4106140	592				
18-5450	Pleasurecraft	R119001	643				
18-5450			614				
18-5451	Chrysler Inboard	3874767	592				
18-5464			Obsolete				
18-5465	Mercuriser	392-863704T	698				
18-5465	Mercuriser	8M0054588	698				

1 This product is priced per piece. To order, priced per package, please add -9 to the part number

2 Items ending in "D" are display packaged - regular number is non-display

3 For discount shop pack of 10, please add -10 to the part number

SIERRA #	O.E.M.	O.E. #	PAGE #	SIERRA #	O.E.M.	O.E. #	PAGE #
SIERRA							
18-5603	Mercury Marine	RA122009	643	18-5636	Mercury Marine	50-57465A1	392
18-5603-1	Pleasurecraft	RA122009	S/S to 18-5603-1	18-5636	Mercury Marine	50-57867	392
18-5605	Mercury Marine	50-73521	391	18-5636	Mercury Marine	50-58788A3	392
18-5605	Mercury Marine	50-73521T	391	18-5636	Mercury Marine	50-64975	392
18-5605	Mercury Marine	50-898265005	391	18-5636	Mercury Marine	50-72467	392
18-5606	Mercury Marine	50-44369	391	18-5640	OMC	387094	282
18-5606	Mercury Marine	50-44369A1	391	18-5640	OMC	395207	282
18-5606	Mercury Marine	50-60315	391	18-5640	OMC	585062	282
18-5608	Mercury Marine	50-44414	391	18-5640	OMC	586288	282
18-5608	Mercury Marine	50-44414	391	18-5640	OMC	778992	282
18-5608	Mercury Marine	50-44415	391	18-5642	Mercury Marine	50-44369A1	391
18-5608	Mercury Marine	50-44415	391	18-5642	Mercury Marine	50-66015	391
18-5608	Mercury Marine	50-77141	391	18-5642	Mercury Marine	50-66015T1	391
18-5608	Mercury Marine	50-77141	391	18-5642	Mercury Marine	50-893891T	391
18-5608	Mercury Marine	50-79472	391	18-5648	OMC	384777	283
18-5608	Mercury Marine	50-79472	391	18-5648	OMC	386657	283
18-5608	Mercury Marine	50-79472 1	391	18-5648	OMC	391735	283
18-5608	Mercury Marine	50-79472 1	391	18-5648	OMC	585050	283
18-5610	Mercury Marine	50-660151	391	18-5648	OMC	585058	283
18-5610	Mercury Marine	50-660153	391	18-5648	OMC	586281	283
18-5610	Mercury Marine	50-66015T	391	18-56481			669
18-5610	Mercury Marine	50-893892T	391	18-5650	Mercury Marine	57380	393
18-5611	Mercury Marine	50-8M0033984	391	18-5655	Chrysler Force	F15150	243
18-5611	Mercury Marine	50-90983A1	391	18-5655	OMC	321648	284
18-5611	Mercury Marine	50-90983T1	391	18-5656	Mercury Marine	68575	393
18-5612	OMC	432925	283	18-5657	Volvo	855798	964
18-5612	OMC	586286	283	18-5658	Mercury Marine	86177	393
18-5612	OMC	586287	283	18-5658	Mercury Marine	86177 1	393
18-5613	Chrysler Force	F438955-1	242	18-56601	Yanmar	104211-49160	689
18-5613	Chrysler Force	F480955	242	18-56602	Yanmar	128170-42090	689
18-5613	Chrysler Force	F490955	242	18-5671	OMC	384781	284
18-5613	Chrysler Force	F616955	242	18-5673	Chrysler Force	819222	Obsolete
18-5613	Chrysler Force	F85955-1	242	18-5673	Chrysler Force	F15100	Obsolete
18-5613	Chrysler Force	FA85955	242	18-5673	Chrysler Force	F15110	Obsolete
18-5613	Chrysler Force	FK616955	242	18-5674	Mercury Marine	75661	393
18-5613	Chrysler Force	FS438955	242	18-5674	Mercury Marine	13310T1	393
18-5613	Chrysler Force	FS438955	242	18-5674	OMC	387683	282
18-5613	Chrysler Force	FS480955	242	18-5677	Chrysler Force	811902	243
18-5613	Chrysler Force	FS489955	242	18-5678	OMC	585269	282
18-5613	Chrysler Force	FS490955	242	18-5679	OMC	585267	282
18-5617	OMC	586274	283	18-56870	Mercury	59341A1	Obsolete
18-5617	OMC	778995	283	18-5697	Chrysler Force	75384	242
18-5618	Chrysler Force	50-819968	242	18-5697	Chrysler Force	F15164	242
18-5618	Chrysler Force	50-8199681	242	18-5697	Mercury Marine	75384	393
18-5618	Chrysler Force	50-819968-2	242	18-5697	OMC	385952	282
18-5618	Chrysler Force	50-8199683	242	18-5700	Volvo	3858081	973
18-5618	Chrysler Force	50-8199684	242	18-5700	Volvo	3858809	973
18-5618	Chrysler Force	50-898265003	242	18-5701	Johnson/Evinrude	355169	294, 302
18-5619	OMC	391511	283	18-5703	Johnson/Evinrude	355209	294, 302
18-5619	OMC	396235	283	18-5704	Volvo	876037	973
18-5619	OMC	397023	283	2 18-5705	OMC	582472	279, 896
18-5619	OMC	584799	283	2 18-5705	OMC	584416	279, 896
18-5619	OMC	586731	283	2 18-5705	OMC	586224	279, 896
18-5620	Mercury Marine	50-818445-2	391	2 18-5705	Volvo	876039	973
18-5620	Mercury Marine	50-818445-3	391	18-5707	Mercury Marine	816770	386
18-5620	Mercury Marine	50-8184455	391	18-5707	Mercury Marine	62351A1	386
18-5621	Mercury Marine	50-822462	391	18-5707	Mercury Marine	62351A2	386
18-5621	Mercury Marine	50-822462T1	391	18-5707	Mercury Marine	816770T	386
18-5621	Mercury Marine	50-893890T	391	18-5708	OMC	582399	281
18-5622	Chrysler Force	50-820193	242	18-5708	OMC	583408	281
18-5622	Chrysler Force	50-820193T1	242	18-5709	OMC	581778	281
18-5624	OMC	583482	283	18-5710	Chrysler Inboard	2098300	597
18-5624	OMC	585056	283	18-5710	Chrysler Inboard	2847527	597
18-5624	OMC	586279	283	18-5710	Prestolite	VSH-6201JY	583, 594, 616
18-5627	OMC	583473	283	18-5711	OMC	383440	895
18-5627	OMC	585059	283	18-5711	Prestolite	VSH-6201 AFY	895
18-5627	OMC	585459	283	18-5717	Crusader	42001	615
18-5628	OMC	393570	283	18-5717	Crusader	707125	615
18-5628	OMC	585060	283	18-5717	Mercury Marine	33270	718
18-5628	OMC	586285	283	18-5717	OMC	1984462	893
18-5628	OMC	778994	283	18-5717			583
18-5629	OMC	386591	283	18-5723	Chrysler Inboard	2095946	595
18-5629	OMC	392133	283	18-5724	Mercuriser	78385	722
18-5629	OMC	585061	283	18-5729	Mercury Marine	87-18211	387
18-5630	OMC	384163	283	18-5731	Suzuki	38860-76F01	480
18-5630	OMC	384163	283	18-5732	Mercury	893640T01	386
18-5630	OMC	387684	283	18-5737	Mercury Marine	87-19761	387
18-5630	OMC	387684	283	18-5740	Mercury Marine	42785	722
18-5630	OMC	389275	283	18-5741	Mercury Marine	815279-1	386
18-5630	OMC	389275	283	18-5741	Mercury Marine	815279A2	386
18-5630	OMC	585063	283	18-5742	Chrysler Force	817411	242
18-5631	OMC	584818	283	18-5742	Chrysler Force	8152792	242
18-5631	OMC	586277	283	18-5742	Chrysler Force	815279T2	242
18-5631	OMC	778996	283	18-5742	Chrysler Force	815279T3	242
18-5632	OMC	584980	283	18-5742	Chrysler Force	830179A2	242
18-5632	OMC	586284	283	18-5742	Chrysler Force	F718470	242
18-5634	OMC	385529	283	18-5742	Chrysler Force	F746470	242
18-5634	OMC	389954	283	18-5743	Mercury Marine	815279-3	386
18-5634	OMC	585051	283	18-5743	Mercury Marine	815279-5	386
18-5634	OMC	585057	283	18-5743	Mercury Marine	883072T	386

1 This product is priced per piece. To order, priced per package, please add -9 to the part number

2 Items ending in "D" are display packaged - regular number is non-display

3 For discount shop pack of 10, please add -10 to the part number

SIERRA #	O.E.M.	O.E. #	PAGE #	SIERRA #	O.E.M.	O.E. #	PAGE #
SIERRA							
18-5744	Chrysler Force	8152794	242	18-5790	Mercury Marine	18495A19	377
18-5744	Chrysler Force	8174111	242	18-5790	Mercury Marine	18495A26	377
18-5744	Chrysler Force	815279T4	242	18-5791	Mercury Marine	19052A3	377
18-5744	Chrysler Force	815279T5	242	18-5791	Mercury Marine	19052A5	377
18-5744	Chrysler Force	830179A1	242	18-5791	Mercury Marine	19052A8	377
18-5744	Chrysler Force	854514A1	242	18-5792	Mercury Marine	16061T	377
18-5744	Chrysler Force	856747T1	242	18-5793	Mercury Marine	823034	377
18-5744	Chrysler Force	883071A1	242	18-5793	Mercury Marine	823034T	377
18-5745	Volvo	3287677	959	18-5794	OMC	583896	S/S to 18-5794-1
18-5746	Yamaha	6H3-85510-A1	495	18-5794	OMC	584329	S/S to 18-5794-1
18-5750	OMC	580339	277, 493, 580	18-5794	OMC	584331	S/S to 18-5794-1
18-5750	OMC	581027	277, 493, 580, 594	18-5794	OMC	584489	S/S to 18-5794-1
18-5750			251, 258, 381, 473	18-5796	Mercury Marine	96455A15	Obsolete
18-5752			251, 258, 277, 381, 473	18-5797	Mercury Marine	68162A3	384
18-5753	OMC	385391	Obsolete	18-5797	Mercury Marine	68162A6	384
18-5753	OMC	581311	Obsolete	18-5797	Mercury Marine	96455A1	384
18-5753	OMC	581731	Obsolete	18-5797	Mercury Marine	96455A8	384
18-5754	OMC	581726	Obsolete	18-5798	Mercury Marine	68162A1	384
18-5755	OMC	581397	275	18-5798	Mercury Marine	68162A5	384
18-5755	OMC	764708	275	18-5798	Mercury Marine	68162A8	384
18-5756	OMC	582056	Obsolete	18-5798	Mercury Marine	96455A6	384
18-5757	OMC	581713	Obsolete	18-5798	Mercury Marine	96455A9	384
18-5757	OMC	582057	Obsolete	2	18-5801	Mercury Marine	89-76416A1
18-5758	OMC	582452	275	2	18-5801	OMC	586730
18-5758	OMC	582453	275	2	18-5801	OMC	586842
18-5758	OMC	583380	275	2	18-5801	OMC	985064
18-5759	OMC	581805	275	2	18-5801	Pleasurecraft	F130001
18-5759	OMC	582125	275	2	18-5802	Mercury Marine	54981
18-5760	OMC	582138	275	2	18-5802	Mercury Marine	65057
18-5760	OMC	582400	275	2	18-5802	Mercury Marine	65057A1
18-5760	OMC	582556	275	2	18-5802	Mercury Marine	65057T1
18-5760	OMC	582642	275	2	18-5803	Chrysler Force	F177917
18-5761	OMC	583114	275	2	18-5803	OMC	979774
18-5763	OMC	582285	275	18-5804	Mercury Marine	13037	718
18-5763	OMC	583170	275	18-5804			652
18-5764	OMC	582261	275	18-5806	Bosch	0331-302-050	972
18-5764	OMC	586696	275	18-5806	Bosch	0331-302-081	972
18-5766	OMC	583748	275	18-5806	Bosch	0331-302-085	972
18-5767	OMC	584783	276	18-5806	Bosch	0331-302-581	972
18-5768	OMC	584908	276	18-5806	Bosch	0331-302-585	972
18-5768	OMC	5001344	276	18-5806	Volvo	834520	972
18-5770-1	OMC	584028	276	18-5807	OMC	378444	279, 893
18-5770-2	Volvo	876068	201, 995	18-5807	Prestolite	SAW4206	279, 893
18-57703	Yanmar	128270-12540	688	2	18-5808	Mercury Marine	47866
18-57704	Yanmar	128171-12540	688	2	18-5808	Mercury Marine	47866T
18-5771	OMC	584032	273	2	18-5808	OMC	395419
18-5772-1	OMC	584041	273	2	18-5808	OMC	582708
18-5773	OMC	584642	273	2	18-5810		386, 719
18-5774-1	OMC	585145	273	18-5811	Mercury Marine	809462	386, 719
18-5774-1	OMC	763803	273	18-5811	Mercury Marine	809463	386, 719
18-5775	Chrysler Force	332-7778A12	239	18-5811	Mercury Marine	8094621	386, 719
18-5775	Mercury Marine	332-5524A1	376	18-5811	Mercury Marine	8094631	386, 719
18-5775	Mercury Marine	332-7778A1	376	18-5811	Mercury Marine	809463A1	386, 719
18-5775	Mercury Marine	332-7778A12	376	18-5811	OMC	3850216	893
18-5775	Mercury Marine	332-7778A3	376	18-5811	Volvo	3850216	972
18-5775	Mercury Marine	332-7778A6	376	18-5811	Volvo	3859054	972
18-5775	Mercury Marine	332-7778A7	376	2	18-5812	OMC	985063
18-5775	Mercury Marine	332-7778A9	376	18-5813	OMC	584128	279
18-5775	Mercury Marine	F749301	376	2	18-5814	OMC	172869
18-5775	Mercury Marine	F7778A9	376	2	18-5814	OMC	581528
18-5776	Mercury Marine	339-7452A1	376	2	18-5815	Mercury Marine	89-15857
18-5776	Mercury Marine	339-7452A2	376	2	18-5815	Mercury Marine	89-61053
18-5776	Mercury Marine	339-7452A3	376	2	18-5815	Mercury Marine	89-65258
18-5777	Mercury Marine	339-7452A15	376	2	18-5815	Mercury Marine	89-68258A4
18-5777	Mercury Marine	339-7452A19	376	2	18-5815	Mercury Marine	89-76545
18-5777	Mercury Marine	339-7452A7	376	2	18-5815	Mercury Marine	89-76545T
18-5777	Mercury Marine	339-7452A9	376	2	18-5815	Mercury Marine	89-853654A1
18-5778	Mercury Marine	339-7452A11	376	2	18-5816	Mercury Marine	89-91975
18-5778	Mercury Marine	339-7452A14	376	2	18-5816	Mercury Marine	89-96054
18-5778	Mercury Marine	339-7452A21	376	2	18-5816	Mercury Marine	89-96054T
18-5778	Mercury Marine	339-7452A8	376	2	18-5817	Mercury Marine	94318
18-5780	OMC	585189	S/S to 18-5774-1	2	18-5817	Mercury Marine	846070
18-5781-1	OMC	584636	274	2	18-5817	Mercury Marine	89-96158
18-5781-1	OMC	585114	274	2	18-5817	Mercury Marine	89-96158T
18-5781-1	OMC	586212	274	18-5818	Mercury Marine	89-818864	388
18-5781-1	OMC	586661	274	18-5818	Mercury Marine	89-818864T	386
18-5782	OMC	582705	274	18-5819	Mercury Marine	89-818997A1	386
18-5782	OMC	763793	274	18-5819	Mercury Marine	89-818997A2	386
18-57824	Ilmor	MV8V1021	201	18-5819	Mercury Marine	89-818997T1	386
18-5783	OMC	582811	S/S to 18-5784-1	18-5819	Yamaha	65W-81941-00-00	495
18-5783	OMC	763794	S/S to 18-5784-1	18-5820	Mercury Marine	89-818999A2	386, 719
18-5784-1	OMC	582811	274	18-5820	Mercury Marine	89-825842A1	386, 719
18-5784-1	OMC	763794	274	18-5820	Mercury Marine	89-850188T1	386, 719
18-5784-1	OMC	583110	274	18-5821	Mercury Marine	825096T01	386
18-5785	OMC	585261	274	18-5821	Mercury Marine	89-825096T	386
18-5787	Mercury Marine	332-4911A5	376	18-5821	Yamaha	6G1-81941-00-00	495
18-5787	Mercury Marine	332-4911A8	376	2	18-5822	Mercury Marine	54293A10
18-5788	Mercury Marine	339-6222A8	Obsolete	2	18-5822	Mercury Marine	54293A13
18-5790	Chrysler Force	18495A26	239	2	18-5822	Mercury Marine	54293A4
18-5790	Mercury Marine	18495A12	377	2	18-5823	OMC	584580

1 This product is priced per piece. To order, priced per package, please add -9 to the part number

2 Items ending in "D" are display packaged - regular number is non-display

3 For discount shop pack of 10, please add -10 to the part number

SIERRA #	O.E.M.	O.E. #	PAGE #	SIERRA #	O.E.M.	O.E. #	PAGE #
SIERRA							
18-5825	OMC	395204	281	18-5881	Mercury Marine	332-5772A3	377
18-5826	OMC	584890	281	18-5881	Mercury Marine	332-5772A5	239, 377
18-5827	OMC	584476	281	18-5881	Mercury Marine	F720301	377
18-5827	OMC	585001	281	18-5882	Volvo	3884950	970
18-5828	OMC	439561	281	18-5883	OMC	584488	Obsolete
18-5828	OMC	585219	281	18-5884	OMC	586343	274
18-5829	OMC	586048	281	18-5885	OMC	563865	274
18-5830	OMC	586075	281	18-5886	OMC	436367	274
18-5831	OMC	584641	281	18-5886	OMC	584122	274
18-5831	OMC	585995	281	18-5887	OMC	584985	274
18-5831	OMC	586271	281	18-5888	OMC	987738	883
18-5832	OMC	583266	281	18-5889	OMC	987739	883
18-5832	OMC	583689	281	18-5890	OMC	987740	883
18-5832	OMC	584424	281	18-5890	OMC	985902	883
18-5832	OMC	586000	281	18-5891	OMC	583605	274
2 18-5833	OMC	586774	279	18-5893	OMC	583476	274
18-5834	Chrysler Force	89-817109A2	239	18-5893	OMC	584037	274
18-5834	Mercury Marine	89-817109A2	387	18-5893	OMC	586217	274
18-5835	Chrysler Force	89-803822T	239	18-5893	OMC	586667	274
18-5835	Chrysler Force	89-817109A3	239	18-5894	OMC	3852215	20, 905, 980
18-5835	Chrysler Force	89-F460917-1	239	18-5894	Volvo Penta	3852215	20, 905, 980
18-5835	Chrysler Force	F460917-1	239	18-5896	Mercury Marine	12415	409
2 18-5836	Mercury Marine	25661	387, 719	18-5896			20
2 18-5836	Mercury Marine	256611	387, 719	18-5897	Mercury Marine	36525	769
2 18-5836	Mercury Marine	25661T1	387, 719	18-5897	Mercury Marine	97257	769
18-5837	Mercury Marine	89-18080	718	18-5897	Mercury Marine	806490	769
18-5838	Delco	1114356	893	18-5897	Mercury Marine	811091	769
18-5838	Delco	1114458	893	18-5897	Mercury Marine	806490T	769
18-5838	Mercury Marine	33261	718	18-5897	Mercury Marine	97257A1	769
18-5838	Mercury Marine	33316	718	18-5897	OMC	980613	909
18-5838	Mercury Marine	60687	718	18-5897	Volvo	3853787	980
18-5838	Mercury Marine	89902	718	18-5898			20
18-5838	Mercury Marine	89-99253	718	18-5898	Crusader	700427	619
18-5838			583, 615	18-5898	Mercury Marine	34625	769
18-5840	Prestoilite	15-79	583, 594, 615, 718	18-5898	Mercury Marine	97258	769
18-5840	Prestoilite	SAW4201	583, 594, 615, 718	18-5898	Mercury Marine	97258A1	769
18-5840	Prestoilite	SAW4207	583, 594, 615, 718	18-5898	Mercury Marine	F16900152	769
18-5840	Prestoilite	SAW4210	583, 594, 615, 718	18-5898	Mercury Marine	F16900198	769
18-5840			69, 652	18-5898	OMC	171960	909
18-5841	Chrysler Inboard	1692658	594	18-5898			20
18-5849	Mercury Marine	828151	387	18-5899	Crusader	700425	619
18-5849	Mercury Marine	828151A1	387	18-5899	Mercury Marine	34623	769
18-5849	Mercury Marine	882751A1	387	18-5899	Mercury Marine	90806	769
18-5849	Mercury Marine	882751A2	387	18-5899	Mercury Marine	815425	769
18-5850	Mercury Marine	882751A04	387	18-5899	Mercury Marine	815425T	769
18-5851	Mercury	807057	387	18-5899	Mercury Marine	8M0068784	769
18-5851	Mercury	807057T	387	18-5899	Mercury Marine	90806A1	769
18-5851	Mercury	865202T	387	18-5899	OMC	982650	909
18-5852	Mercury Marine	821509	387	18-5899	Pleasurecraft	RO20001	646
18-5852	Mercury Marine	853292	387	18-5899	Volvo	3857532	980
18-5852	Mercury Marine	821509T1	387	18-5899			20
18-5853	Yamaha	61A-81941-00-00	495	18-5903	Mercury Marine	50-12872	717
18-5853	Yamaha	6E5-81941-10-00	495	18-5903	Mercury Marine	50-56886	717
18-5853	Yamaha	6E5-81941-11-00	495	18-5903	Mercury Marine	50-69865A1	717
18-5854	Mercury Marine	398-5454A17	384	18-5903	OMC	980803	892
18-5855	Mercury Marine	336-3996A7	384	18-5903	OMC	981821	892
18-5856	Mercury Marine	398-5255	384	18-5903	Pleasurecraft	RA122001	644
18-5857	Mercury Marine	398-5454A7	384	18-5903	Volvo	841066-4	969
18-5859	Mercury Marine	398-5454A22	384	18-5906	Volvo	840808	969
18-5859	Mercury Marine	398-5919A3	384	18-5906	Volvo	872241	969
18-5859	Mercury Marine	398-5919A7	384	18-5907	Crusader	42090	615
18-5860	Mercury Marine	398-5454A35	384	18-5907	Mercury Marine	50-72550A2	715
18-5864	Mercury Marine	86617A20	383	18-5907	Mercury Marine	50-79604A3	715
18-5865	Mercury Marine	398-5704A7	383	18-5907	Mercury Marine	50-97499A2	715
18-5866	Mercury Marine	398-5919A4	Obsolete	18-5907	Mercury Marine	50-97499R4	715
18-5867	Mercury Marine	398-9873A4	Obsolete	18-5907	OMC	981289	891
18-5870	Chrysler Force	398-832075A4	239	18-5907	OMC	982202	891
18-5870	Mercury Marine	398-832075A-21	383	18-5907	Pleasurecraft	RA122008	643
18-5870	Mercury Marine	398-832075A4	239	18-5908	Crusader	42091	615
18-5871	Mercury Marine	398-5454A32	383	18-5908	Mercury Marine	50-17251A2	716
18-5873	Chrysler Force	398-832075A6	239	18-5908	Mercury Marine	50-17251A3	716
18-5873	Mercury Marine	398-832075A6	383	18-5908	Mercury Marine	50-47455	716
18-5874	Mercury Marine	398-5454A21	383	18-5908	Mercury Marine	50-65784A1	716
18-5874	Mercury Marine	398-5454A25	383	18-5908	Mercury Marine	50-76965A3	716
18-5874	Mercury Marine	398-5454A63	383	18-5908	Mercury Marine	50-76967A1	716
18-5874	Mercury Marine	398-5919A2	383	18-5908	Mercury Marine	50-76967A4	716
18-5874	Mercury Marine	398-5919A6	383	18-5908	Mercury Marine	50-808011A05	716
18-5874	Mercury Marine	398-5919A8	383	18-5908	Mercury Marine	50-808011A1	716
18-5874	Mercury Marine	398-818535A15	383	18-5908	Mercury Marine	50-808011A3	716
18-5874	Mercury Marine	398-832075A14	383	18-5908	Mercury Marine	50-808011A4	716
18-5874	Mercury Marine	398-832075A20	383	18-5908	Mercury Marine	50-99419A3	716
18-5876	Mercury Marine	398-9610A19	383	18-5908	OMC	981288	892
18-5877	OMC	584643	278	18-5908	OMC	982195	892
18-5878	OMC	584981	278	18-5908	OMC	984982	892
18-5879	Yamaha	688-81941-00-00	495	18-5908	OMC	986007	892
18-5879	Yamaha	688-81950-10-00	495	18-5908	Pleasurecraft	RA122009	643
18-5881	Chrysler Force	332-5772A5	239, 377	18-5909	Evinrude	587078	282
18-5881	Chrysler Force	332-5772A7	239, 377	18-5909	Evinrude	587291	282
18-5881	Mercury Marine	332-5772A1	377	18-5910	Mercury Marine	50-12177A2	716
18-5881	Mercury Marine	332-5772A2	377	18-5910	Mercury Marine	50-99418A2	716

1 This product is priced per piece. To order, priced per package, please add -9 to the part number

2 Items ending in "D" are display packaged - regular number is non-display

3 For discount shop pack of 10, please add -10 to the part number

SIERRA #	O.E.M.	O.E. #	PAGE #	SIERRA #	O.E.M.	O.E. #	PAGE #
SIERRA							
18-5910	OMC	984456	892	18-5959	Valeo	A13N2M	970
18-5910	OMC	986505	892	18-5959	Volvo	826495	970
18-5911	Chris-Craft	16.61-00042	583	18-5959	Volvo	834609	970
18-5911	Mercury Marine	50-17251A3	715	18-5959	Volvo	834963	970
18-5911	Mercury Marine	50-76965A4	715	18-5959	Volvo	841762	970
18-5911	Mercury Marine	50-77328A3	715	18-5959	Volvo	841765	970
18-5911	Mercury Marine	50-99417A2	715	18-5959	Volvo	841766	970
18-5911	Mercury Marine	50-99419A3	715	18-5960	Mercury Marine	807653T	721
18-5911	OMC	981078	891	18-5961			568, 588, 598, 628
18-5911	OMC	982121	891	18-5962			568, 588, 598, 628
18-5911	OMC	983444	891	18-59640	Prestolite		1012
18-5911	OMC	983790	891	18-5965	Mercury Marine	12449	721
18-5911	OMC	985966	891	18-5965	Mercury Marine	92497	721
18-5911	Volvo	834893	891	18-5965	Mercury Marine	12449A1	721
18-5911	Volvo	855326	969	18-5965	Mercury Marine	805884T	721
18-5913-1	Mercury Marine	50-812428A3	715	18-5965	Mercury Marine	817119A1	721
18-5913-1	Mercury Marine	50-812604A2	715	18-5965	Mercury Marine	817119A4	721
18-5913-1	Mercury Marine	50-822330A2	715	18-5965	Mercury Marine	92497A3	721
18-5913-1	Mercury Marine	50-864340A2	715	18-5965	Mercury Marine	98555A1	721
18-5913-1	OMC	3854751	892	18-5966	Mercury Marine	12449	721
18-5913-1	Volvo	3587625	969	18-5966	Mercury Marine	92497	721
18-5913-1	Volvo	3853982	969	18-5966	Mercury Marine	12449A1	721
18-5913-1	Volvo	3854751	969	18-5966	Mercury Marine	12449A1	721
18-5913-1	Volvo	3856004	969	18-5966	Mercury Marine	817119A1	721
18-5913-1	Volvo	3860764	969	18-5966	Mercury Marine	817119A4	721
18-5913-1	Volvo	3885317	969	18-5966	Mercury Marine	98555A1	721
18-5917	OMC	984628	892	18-5967	Mercury Marine	807652T	721
18-5919	Mercury Marine	50-806963A4	S/S to 18-5919-1	18-5968			722
18-5919	Mercury Marine	50-806963A4	716	18-59700	Volvo	841380	970
18-5919	Mercury Marine	50-806965A2	S/S to 18-5919-1	18-59700	Volvo	841762	970
18-5919	Mercury Marine	50-806965A2	716	18-59700	Volvo	841763	972
18-5919	Mercury Marine	50-806965A4	S/S to 18-5919-1	18-59700	Volvo	841765	973
18-5919	Mercury Marine	50-806965A4	716	18-59700	Volvo	841766	974
18-5919	OMC	988217	S/S to 18-5919-1	18-59700	Volvo	3803227	975
18-5919	OMC	988217	716	18-59700	Volvo	3803227-2	976
18-5919	Volvo	3856003	S/S to 18-5919-1	18-59700	Volvo	834625-6	977
18-5919	Volvo	3856003	891	18-59700	Volvo	841378-3	978
18-5920	OMC	987611	891	18-59710	Volvo	820652	979
18-5920	OMC	3854190	891	18-59710	Volvo	822454	970
18-5920	Pleasurecraft	RA122001	644	18-59710	Volvo	827303	971
18-5920	Pleasurecraft	RK122014	644	18-59710	Volvo	847651	972
18-5920	Volvo	3854190	969	18-59710	Volvo	849561	973
18-5923			S/S to 18-5920	18-59710	Volvo	849602	974
18-5927			891, 969	18-5975	Motorola	510-845	679
18-5929	Mercury Marine	892940T	390	18-5975	Motorola	510-860	679
18-5939	Valeo	2541451	971	18-5975	Motorola	510-864	679
18-5939	Valeo	A13N234	971	18-5975	Motorola	9AR3855G	679
18-5939	Volvo	872235	971	18-5975	Motorola	9AR6000G	679
18-5939	Volvo	873770	971	18-5975	Motorola	9AR3959G	679
18-5939	Volvo	3803260	971	18-5975	Perkins Marine Engine	2871A651	679
18-5943	Valeo	541663	971	18-5975	Valeo	2939590	679
18-5943	Valeo	A13N259	971	18-5976	Motorola	9AR3743G	971
18-5943	Volvo	872926	971	18-5976	Motorola	510-821	971
18-5943	Volvo	3803227	971	18-5976	Motorola	510-802	971
18-5946			720	18-5976	Motorola	510-835	971
18-5946			720	18-5976	Motorola	510-836	971
18-5949			Obsolete	18-5976	Motorola	510-856	971
18-5953-1			722	18-5976	Motorola	510-861	971
18-5954	Chrysler Inboard	3527501	595	18-5976	Motorola	510-862	971
18-5954	Chrysler Inboard	3527502	595	18-5976	Valeo	2937430	971
18-5954	Chrysler Inboard	3744870	595	18-5978	Mercury Marine	47487T	Obsolete
18-5956	Mercury Marine	56045	721	18-5979	Volvo	3860082	679
18-5956	Mercury Marine	59755	721	18-5982	Cummins	216040	970
18-5956	Mercury Marine	69729	721	18-5982	Cummins	3604234RX	679
18-5956	Mercury Marine	78477	721	18-5983	Mercury Marine	862030T	721
18-5956	Mercury Marine	90794	721	18-5984	Indmar	575011	633
18-5956	Mercury Marine	78403A1	721	18-5984	Pleasurecraft	RA097007B	644
18-5956	Mercury Marine	78403A2	721	18-6000	Volvo	832598	1009
18-5957	Mercury Marine	12449	721	18-6000	Volvo	873179	1009
18-5957	Mercury Marine	56045	721	18-6000A	Volvo	832598	1009
18-5957	Mercury Marine	59755	721	18-6000A	Volvo	873179	1009
18-5957	Mercury Marine	69729	721	18-6001	Volvo	838929	1009
18-5957	Mercury Marine	78477	721	18-600-1212			104
18-5957	Mercury Marine	90794	721	18-600-1414			104
18-5957	Mercury Marine	92497	721	18-600-1418			104
18-5957	Mercury Marine	12449A1	721	18-600-3814			104
18-5957	Mercury Marine	78403A1	721	18-600-3818			104
18-5957	Mercury Marine	78403A2	721	18-600-3838			104
18-5957	Mercury Marine	817119A1	721	18-6004	Volvo	852835	1009
18-5957	Mercury Marine	817119A4	721	18-6004	Volvo	873178	1009
18-5957	Mercury Marine	92497A3	721	18-6004A	Volvo	852835	1009
18-5957	Mercury Marine	98555A1	721	18-6004A	Volvo	873178	1009
18-5957	OMC	982364	895	18-6005	Volvo	875805	1009
18-5957	Pleasurecraft	RA097002	644	18-600-5618			104
18-5957	Pleasurecraft	RA097003	644	18-6009	Volvo	875815	1009
18-5957	Pleasurecraft	RA097006	644	18-6009A	Volvo	875815	1009
18-5957	Volvo	3860769	970	18-6010	Volvo	875821	1009
18-5959	Valeo	A13N147M	970	18-60103	Nissan/Tohatsu	332600060M	477
18-5959	Valeo	A13N148M	970	18-60103-50			477
18-5959	Valeo	A13N11M	970	18-6010A	Volvo	875821	1009

1 This product is priced per piece. To order, priced per package, please add -9 to the part number

2 Items ending in "D" are display packaged - regular number is non-display

3 For discount shop pack of 10, please add -10 to the part number

SIERRA #	O.E.M.	O.E. #	PAGE #	SIERRA #	O.E.M.	O.E. #	PAGE #
SIERRA							
18-6011	Honda	41107-ZW1-003ZA	268	18-6033	Suzuki	55125-87D00	488
18-6011	Mercury Marine	31640	458	18-6034	Yamaha	6K1-45371-00-00	551
18-6011	Mercury Marine	316403	458	18-6035	Yamaha	6J9-45371-01-00	551
18-6011	Mercury Marine	31640A	458	18-6040			577
18-6011	Mercury Marine	31640A1	458	18-6041-1			577
18-6011	Mercury Marine	31640A2	458	18-6043-1			577
18-6011	Mercury Marine	31640A4	458	18-6045			577
18-6011	Mercury Marine	31640T6	458	18-6046			577
18-6011	Mercury Marine	72436A1	458	18-6047			577
18-6011	Mercury Marine	97-31640B4	458	18-6050			577
18-6011	Mercury Marine	97-31640Q4	458	18-60508	Yamaha	60V-12414-A0-00	545
18-6011A	Honda	41107-ZW1-003ZA	268	18-60512	Yamaha	68D-E1169-A0-00	549
18-6011A	Mercury Marine	31640	458	18-60513	Yamaha	68M-11357-00-00	550
18-6011A	Mercury Marine	31640A1	458	18-60518	Yamaha	68D-11351-A0-00	549
18-6011A	Mercury Marine	31640Q4	458	18-60519	Yamaha	68D-E1193-A0-00	549
18-6011A	Mercury Marine	31640T6	871	18-6052			577
18-6012	Mercury Marine	34127	871	18-60520	Yamaha	66T-11193-A0-00	549
18-6012	Mercury Marine	34127A1	871	18-60521	Yamaha	69M-11196-A0-00	549
18-6012	Mercury Marine	34127A2	871	18-60522	Yamaha	66T-11181-A0-00	549
18-6012	Mercury Marine	34127T1	871	18-60523	Yamaha	69M-11181-00-00	549
18-6012	Mercury Marine	34127T2	871	18-60527	Yamaha	67D-45113-A0-00	549
18-6013	Mercury Marine	32170	871	18-60528	Yamaha	66T-45113-A0-00	549
18-6013	Mercury Marine	32170A1	871	18-60529	Yamaha	66T-41133-A0-00	549
18-6013	Mercury Marine	34762A1	871	18-6053			577
18-6013	Mercury Marine	97-34672C	871	18-60530	Yamaha	66M-41114-01-00	549
18-601-3814			104	18-60531	Yamaha	65W-41114-01-00	Obsolote
18-6014	Mercury Marine	822777	458, 871	18-60532	Yamaha	66T-41114-A0-00	549
18-6014	Mercury Marine	8227772	458, 871	18-60534	Yamaha	66M-13645-00-00	549
18-6014	Mercury Marine	463999A2	458, 871	18-60535	Yamaha	65W-13645-00-00	549
18-6014	Mercury Marine	46399A1	458, 871	18-60540	Yamaha	676-12414-A0-00	549
18-6014	Mercury Marine	822777A1	458, 871	18-60541	Yamaha	6BX-G4315-01-00	549
18-6014	Mercury Marine	822777A3	458, 871	18-6059			577
18-6014	Mercury Marine	822777A4	458, 871	18-6060			577
18-6014	Mercury Marine	822777Q1	458, 871	18-6062			577
18-6014A	Mercury Marine	46399A1	458, 871	18-6063			577
18-6014A	Mercury Marine	822777A1	458, 871	18-6066	Mercury Marine	43994A2	871
18-6014A	Mercury Marine	822777Q1	458, 871	18-6066	Mercury Marine	821631A1	871
18-60151-9	Mercury Marine	55989	871	18-6066	Mercury Marine	821631B1	871
18-60151-9	Mercury Marine	55989A3	871	18-6066	Mercury Marine	821631C	871
18-60151-9	Mercury Marine	55989A4	871	18-6066	Mercury Marine	821631Q1	871
18-60151-9	Mercury Marine	55989A9	871	18-6066A	Mercury Marine	43994A2	871
18-60151-9	Mercury Marine	55989Q9	871	18-6066A	Mercury Marine	821631Q1	871
18-60151-9	Mercury Marine	55989T9	871	18-6067	Mercury Marine	806189A1	872
18-6015-9	Mercury Marine	55989A3	871	18-6067	Mercury Marine	97-806189	872
18-6015-9	Mercury Marine	55989Q9	871	18-6067	Mercury Marine	97-806189Q1	872
18-6015A-9	Mercury Marine	55989T9	871	18-6067A	Mercury Marine	806189A1	872
18-6015A-9	Mercury Marine	55989A3	871	18-6067A	Mercury Marine	97-806189	872
18-6015A-9	Mercury Marine	55989Q9	871	18-6067A	Mercury Marine	97-806189Q1	872
18-6015A-9	Mercury Marine	55989T9	871	18-6068	Honda	41109-ZW1-003	267
18-6016	Mercury Marine	76214	458, 871	18-6068	Mercury Marine	826134	458, 872
18-6016	Mercury Marine	762142	458, 871	18-6068	Mercury Marine	826134A1	458, 872
18-6016	Mercury Marine	762142A1	458, 871	18-6068	Mercury Marine	97-826134Q	458, 872
18-6016	Mercury Marine	76214A5	458, 871	18-6070	Yamaha	688-45371-02-00	551
18-6016	Mercury Marine	786214A2	458, 871	18-6079	Mercury Marine	806105	872
18-6016	Mercury Marine	97-762145	458, 871	18-6079	Mercury Marine	806105A1	872
18-6016	Mercury Marine	97-76214Q5	458, 871	18-6079	Mercury Marine	806105Q1	872
18-60161	Mercury Marine	76214	458, 871	18-6079	Mercury Marine	806105T1	872
18-60161	Mercury Marine	76214Q5	458, 871	18-6080	Mercury Marine	815933A1	872
18-60161	Mercury Marine	76214T3	458, 871	18-6080	Mercury Marine	821629A1	837, 872
18-6016A	Mercury Marine	76214	458, 871	18-6080	Mercury Marine	97-821629Q1	872
18-6016A	Mercury Marine	76214Q5	458, 871	18-6080A	Mercury Marine	821629	872
18-6016A	Mercury Marine	76214T3	458, 871	18-6080A	Mercury Marine	821629A1	872
18-6017	OMC	123009	361	18-6080A	Mercury Marine	821629Q1	872
18-6017	OMC	173029	361	18-6089	Mercury Marine	806190A1	872
18-6017A	OMC	123009	361	18-6089	Mercury Marine	806190T1	872
18-6017A	OMC	173029	361	18-6089	Mercury Marine	97-806190	872
18-6018	OMC	327606	361	18-6089	Mercury Marine	97-806190B4	872
18-6019	OMC	982277	944	18-6089	Mercury Marine	97-806190Q1	872
18-6019	OMC	982438	944	18-6090	Yamaha	6G5-45251-01-00	551
18-6020	OMC	976669	361, 944	18-6091	Yamaha	6H1-45251-02-00	551
18-6021	Volvo	838928	1010	18-60916	Mercury	27-850836001	435
18-6024	OMC	393023	361, 944	18-60916	Nissan/Tohatsu	3V1010050M	477
18-6024	OMC	436745	361, 944	18-60917	Mercury	27-803508017	440
18-6024A	OMC	393023	361, 944	18-60917	Nissan/Tohatsu	3V1010240M	477
18-6024A	OMC	436745	361, 944	18-60918	Mercury	27-835427003	441, 477
18-6025	OMC	398331	361, 945	18-60918	Nissan/Tohatsu	3V1013030M	441, 477
18-6025	OMC	433458	361, 945	18-60919	Mercury	27-834952001	441, 477
18-6026	OMC	392462	361	18-60919	Nissan/Tohatsu	3V1023050M	441, 477
18-6027	OMC	392123	361, 945	18-6092	Mercury Marine	806190	872
18-6028	OMC	984513	945	18-6092	Mercury Marine	806190A1	872
18-6028	OMC	3853818	945	18-6092	Mercury Marine	806190Q1	872
18-6028	OMC	3855412	945	18-6092	Mercury Marine	806190T1	872
18-6028	Volvo	984513	945	18-60920	Mercury	27-853702005	441
18-6028	Volvo	3855411	945	18-60920	Nissan/Tohatsu	346-01032-0	477
18-6028A	OMC	984513	945	18-6092A	Mercury Marine	806190	872
18-6028A	OMC	3853818	945	18-6092A	Mercury Marine	806190A1	872
18-6028A	OMC	3855412	945	18-6092A	Mercury Marine	806190Q1	872
18-6028A	Volvo	3863193	1009	18-6092A	Mercury Marine	806190T1	872
18-6029	OMC	397768	945	18-6093	Mercury Marine	806105	843, 872
18-6032	Suzuki	55320-95310	488	18-6093	Mercury Marine	806105A1	843, 872

1 This product is priced per piece. To order, priced per package, please add -9 to the part number

2 Items ending in "D" are display packaged - regular number is non-display

3 For discount shop pack of 10, please add -10 to the part number

SIERRA #	O.E.M.	O.E. #	PAGE #	SIERRA #	O.E.M.	O.E. #	PAGE #
SIERRA							
18-6093	Mercury Marine	806105Q1	872	18-6140	Universal	301068	577
18-6093	Mercury Marine	806105T1	872	18-6141	Universal	301069	577
18-6093A	Mercury Marine	806105	872	18-6150A	Mercury Marine	888756A2	872
18-6093A	Mercury Marine	806105A1	872	18-6150A	Mercury Marine	888756Q02	872
18-6093A	Mercury Marine	806105Q1	872	18-6150A	Mercury Marine	888756Q4	872
18-6093A	Mercury Marine	806105T1	872	18-6150M	Mercury Marine	888756A2	872
18-6094	Mercury Marine	817373A1	872	18-6150M	Mercury Marine	888756Q02	872
18-6094	Mercury Marine	821630A1	872	18-6150M	Mercury Marine	888756Q4	872
18-6094	Mercury Marine	821630C2	872	18-6150Z	Mercury Marine	888756A2	872
18-6094	Mercury Marine	97-821630Q1	872	18-6150Z	Mercury Marine	888756Q02	872
18-6094A	Mercury Marine	821630	872	18-6150Z	Mercury Marine	888756Q4	872
18-6094A	Mercury Marine	821630A1	872	18-61513	Mercury	27-142471	Obsolete
18-6094A	Mercury Marine	821630Q1	872	18-61513	Mercury	27-1424771	Obsolete
18-6094A	Mercury Marine	821630T1	872	18-6154A			871
18-6095	OMC	431708	361, 945	18-6154M			871
18-6095A	OMC	431708	361, 945	18-6154Z			871
18-6096	Yamaha	664-45371-01-00	551	18-6155Z			945
18-6097	Yamaha	6E5-45371-01-00	551	18-6156A			458
18-6098	Suzuki	55125-96310	488	18-6156M			458
18-6099	Mercury Marine	815933A1	872	18-6157A	Mercury Marine	8M0058677	458
18-6099	Mercury Marine	821629A1	872	18-6157M			458
18-6099	Mercury Marine	97-821629Q1	872	18-6158A	Mercury Marine	888756Q01	871
18-6100	OMC	123009	361	18-6158A	Mercury Marine	97-888758Q03	871
18-6100	OMC	173029	361	18-6158M	Mercury Marine	888755A1	871
18-6101	OMC	983494	945	18-6158M	Mercury Marine	888755Q01	871
18-6102	OMC	984513	945	18-6158M	Mercury Marine	97-888755Q03	871
18-6102	OMC	3853818	945	18-6158Z			871
18-6102	OMC	3855412	945	18-6159A	Mercury Marine	888758A1	871
18-6102	Volvo	3855412	945	18-6159A	Mercury Marine	888758Q01	871
18-6103	OMC	984547	945	18-6159A	Mercury Marine	97-888758Q03	871
18-6103A	OMC	984547	945	18-6159M	Mercury Marine	888757Q01	871
18-6104	Volvo	832598	1009	18-6159M	Mercury Marine	888759A1	871
18-6104	Volvo	873179	1009	18-6159M	Mercury Marine	97-888759Q03	871
18-6105	Volvo	852835	1009	18-6159Z			871
18-6105	Volvo	873178	1009	18-6160A	Mercury Marine	888761A1	871
18-61051			184, 698	18-6160A	Mercury Marine	888761Q01	871
18-6106	Volvo	875821	1009	18-6160A	Mercury Marine	97-888761Q03	871
18-6107			577	18-6160M	Mercury Marine	888760A1	871
18-6108			577	18-6160M	Mercury Marine	888760Q01	871
18-6109			577	18-6160M	Mercury Marine	97-888760Q03	871
18-6111	Yamaha	688-45371-02-00	551	18-6160Z			871
18-6112	Yamaha	6J9-45371-01-00	551	18-6161A	Suzuki		488
18-6114	Mercury Marine	806189	872	18-6161M	Suzuki		488
18-6114	Mercury Marine	806189A1	872	18-6162A	Yamaha		551
18-6114	Mercury Marine	806189Q1	872	18-6162M	Yamaha		551
18-6114	Mercury Marine	806189T1	872	18-6163A	Honda		268
18-6115	OMC	433580	361	18-6163M	Honda		268
18-6117A	Mercury Marine	97-806188A1	871	18-6165A	Honda	41107-ZV5-00-00	268
18-6117A	Mercury Marine	97-806188Q01	871	18-6200	Yanmar	27210-200200	690
18-6117M	Mercury Marine	97-806188A1	871	18-6201	Yanmar	27210-200300	690
18-6117M	Mercury Marine	97-806188Q01	871	18-6240	Mercury Marine	821630	872
18-6117Z	Mercury Marine	97-806188A1	871	18-6240	Mercury Marine	821630A1	872
18-6117Z	Mercury Marine	97-806188Q01	871	18-6240	Mercury Marine	821630Q1	872
18-6118A	Yamaha	68V-11325-01-00	551	18-6240	Mercury Marine	821630T1	872
18-6119A	Yamaha	61A-45371-00-00	551	18-6241	Honda	41107-ZW1-003ZA	268
18-6119Z	Yamaha	61A-45371-00-00	551	18-6241	Mercury Marine	31640	458, 871
18-6120A	Yamaha	61N-45251-01-00	551	18-6241	Mercury Marine	31640A1	458, 871
18-6120Z	Yamaha	61N-45251-01-00	551	18-6241	Mercury Marine	31640Q4	458, 871
18-6121A	Yamaha	6K1-45371-02-00	551	18-6241	Mercury Marine	31640T6	458, 871
18-6121Z	Yamaha	6K1-45371-02-00	551	18-6242-9	Mercury Marine	55989A3	871
18-6122A	Yamaha	69L-45371-00-00	551	18-6242-9	Mercury Marine	55989Q9	871
18-6122Z	Yamaha	69L-45371-00-00	551	18-6242-9	Mercury Marine	55989T9	871
18-6123Z	Volvo	873395	1009	18-6243	Mercury Marine	43994A2	871
18-6124Z	Volvo	872793	1009	18-6243	Mercury Marine	821631Q1	871
18-6125A	Volvo	3586461	1009	18-6244	Mercury Marine	76214	458, 871
18-6125M	Volvo	3855610	1009	18-6244	Mercury Marine	76214Q5	458, 871
18-6125Z	Volvo	3854130	1009	18-6244	Mercury Marine	76214T3	458, 871
18-6126A	Volvo	3888816	1009	2 18-6245	Mercury Marine	10-32470	459
18-6126M	Volvo	3888818	1009	18-6246	Yamaha	90105-10M00-00	551
18-6126Z	Volvo	3888817	1009	18-6249	Mercury Marine	43396A2	459
18-6127A	Volvo	3888813	1009	18-6249	Mercury Marine	818298A1	459
18-6127M	Volvo	3888815	1009	18-6249	Mercury Marine	818298Q1	459
18-6127Z	Volvo	3888814	1009	18-6249A	Mercury Marine	43396A2	459
18-6128A	Volvo		1010	18-6249A	Mercury Marine	818298A1	459
18-6128M	Volvo		1010	18-6249A	Mercury Marine	818298Q1	459
18-6128Z	Volvo		1010	18-6250			284, 393
18-6129A	Volvo		1010	18-6251			284, 393
18-6129M	Volvo		1010	18-6252			278, 278
18-6129Z	Volvo		1010	18-6253			720, 720
18-6130	Volvo		1010	18-6254	Mercury Marine	392-2940	Obsolete
18-6131	Volvo		1010	18-6255	Mercury Marine	392-8989	720
18-61319	Mercury	27-827154	Obsolete	18-6256	Mercury Marine	392-2529	Obsolete
18-6132A	Yamaha		551	18-6257	OMC	983195	896
18-6132M	Yamaha		551	18-6258	Honda	36120-ZV5-821	259
18-6133A	Yamaha		551	18-6259	Yamaha	6H1-43880-00-00	499
18-6133M	Yamaha		551	18-6260			895
18-6134			577	18-6261	OMC	987774	895
18-6135			577	18-6261	OMC	3854182	895
18-6136			577	18-6261	OMC	3854809	895
18-6137			577	18-6261	OMC	3856600	895

1 This product is priced per piece. To order, priced per package, please add -9 to the part number

2 Items ending in "D" are display packaged - regular number is non-display

3 For discount shop pack of 10, please add -10 to the part number

SIERRA #	O.E.M.	O.E. #	PAGE #	SIERRA #	O.E.M.	O.E. #	PAGE #
SIERRA							
18-6261	OMC	3857561	895	18-6411	Yamaha	6H3-81800-10	495
18-6261	OMC	3860171	895	18-6411	Yamaha	6H3-81800-11-00	495
18-6261	Volvo	3857561	970	18-6412	Yamaha	697-81800-12	495
18-6261	Volvo	3856600-6	970	18-6412	Yamaha	99999-03249-00	495
18-6263	Universal	288182	652	18-6413	Yamaha	6E5-81800-11-00	496
18-6263	Universal	288759	652	18-6413	Yamaha	6E5-81800-12-00	496
18-6264	Un		652	18-6414	Suzuki	31100-95600	479
18-6265	Volvo	3857813	970	18-6415	Yamaha	6N7-81800-10-00	496
18-6266	Volvo	872300	973	18-6416	Suzuki	31100-94610	479
18-6266	Volvo	876040	973	18-6417	Suzuki	31100-92E00	479
18-6268	Volvo	841177	973	18-6418	Nissan/Tohatsu	353760104M	474
18-6268	Volvo	872272	973	18-6419	Suzuki	31100-89J00	479
18-6270	OMC	984536	891	18-6420	Yamaha	6L2-81800-20-00	496
18-6270	OMC	988013	891	18-6421	Yamaha	6F5-81800-11	496
18-6270			595	18-6421	Yamaha	6J4-81800-01-00	496
18-6271	Volvo	241812	973	18-64217	Mercury	27-815791A00	435
18-6271	Volvo	870670	973	18-6422	Yamaha	6H4-81800-12-00	496
18-6271	Volvo	876038	973	18-64221	Mercury	27-835427A04	Obsolete
18-6271	Volvo	6643474	973	18-64221	Nissan/Tohatsu	3V1871210M	Obsolete
18-6273-1	Mercury Marine	99186	382	18-6423	Yamaha	688-81800-12-00	496
18-6273-1	Mercury Marine	99186-1	382	18-6425	Mercury Marine	50-804312T1	390
18-6273-1	Mercury Marine	99186T	382	18-6425	Yamaha	67F-81800-02-00	496
18-6274	Mercury Marine	14336A20	383	18-6426	Yamaha	68F-81800-01-00	496
18-6274	Prestolite	HYK4001	974	18-6427	Yamaha	68V-81800-01-00	496
18-6274	Volvo	852928	974	18-6428	Suzuki	31100-95313	479
18-6274	Volvo	3857265	974	18-6429	Suzuki	31100-94702	479
18-6275	Mercury Marine	814472	S/S to 18-6275-1	18-6430	Nissan/Tohatsu	B29A-90500A	474
18-6275	Mercury Marine	50-12121A2	S/S to 18-6275-1	18-6431	Nissan/Tohatsu	346760100M	474
18-6275	Mercury Marine	50-12177A2	S/S to 18-6275-1	18-6432	Nissan/Tohatsu	3C8760101M	474
18-6275	Mercury Marine	50-77328A1	S/S to 18-6275-1	18-6433	Honda	31200-ZV5-013	259
18-6275	Mercury Marine	50-77328A3	S/S to 18-6275-1	18-6434	OMC	386430	282
18-6275	Mercury Marine	50-806964A2	S/S to 18-6275-1	18-6435	Mercury Marine	50-859377T	390
18-6275	Mercury Marine	50-806964A3	S/S to 18-6275-1	18-6435	Mercury Marine	50-884044T	390
18-6275	Mercury Marine	50-806964A4	S/S to 18-6275-1	18-6435	Mercury Marine	50-888161T	390
18-6275	Mercury Marine	50-807904A1	S/S to 18-6275-1	18-6436	Mercury Marine	50-834749	390
18-6275	Mercury Marine	50-812428A3	S/S to 18-6275-1	18-6436	Mercury Marine	50-859171T	390
18-6275	Mercury Marine	50-812604A2	S/S to 18-6275-1	18-6437	Mercury Marine	50-830308T	390
18-6275	Mercury Marine	50-822330A2	S/S to 18-6275-1	18-6437	Mercury Marine	50-859169T	390
18-6275	Mercury Marine	50-863007A1	S/S to 18-6275-1	18-6437	Mercury Marine	50-888151T	390
18-6275	Mercury Marine	50-864340A2	S/S to 18-6275-1	18-6438	Mercury Marine	50-854636T	390
18-6275	Mercury Marine	50-99418A2	S/S to 18-6275-1	18-6438	Mercury Marine	50-859170T	390
18-6275	Volvo	3857747	S/S to 18-6275-1	18-6438	Mercury Marine	50-884045T	390
18-6275	Volvo	3860566	S/S to 18-6275-1	18-6438	Mercury Marine	50-888160T	390
18-6276	OMC	984536	891	18-6439	Chrysler Force	50-803903T	242
18-6276	OMC	988013	891	18-6439	Chrysler Force	50-F575955	242
18-6277	OMC	435548	278	18-6440	Mercury Marine	50-853329T	391
18-6279	Chrysler Force	820545	242	18-6440	Mercury Marine	50-892339T	391
18-6279	Chrysler Force	F694541-1	242	18-6441	Chrysler Force	50-803900T	242
18-6280	OMC	437801	278	18-6441	Chrysler Force	50-F514955	242
18-6281	OMC	438786	278	18-64415	Yamaha	68F-W1135-00-00	547
18-6281	OMC	439937	278	18-6443	Pleasurecraft	RA122019	643
18-6281	OMC	5005254	278	18-6445	Honda	31200-ZW9-802	259
18-6282	Mercury Marine	50-8329972	391	18-6448			383, 474
18-6283	Mercury Marine	50-8331535	391	18-6451	Indmar	575014	633
18-6284			652	18-6452	Pleasurecraft	RA097009	644
18-6285	OMC	433226	278	18-6453	Pleasurecraft	RA097007C	644
18-6286	Chrysler Force	827675A1	242	18-6454	Mercury Marine	834832	390
18-6288	Indmar	575010	633	18-6454	Mercury Marine	857006T	390
18-6288	Pleasurecraft	RA097007B	644	18-6454	Mercury Marine	875285T1	390
18-6291	OMC	3854194	893	18-6454	Mercury Marine	881248T	390
18-6291	Volvo	3854194-2	893	18-6454	Mercury Marine	889955A03	390
18-6293	Mercury Marine	862031T	721	18-6454	Mercury Marine	8M0064021	390
18-6293	Mercury Marine	862031T1	721	18-6455	Mercury Marine	875286A1	390
18-6298	Mercury Marine	863077T	721	18-6455	Mercury Marine	875286T	390
18-6299	Marine Power	402001	636	18-6455	Mercury Marine	881247A1	390
18-6350	Mercury Marine	43-821823A1	Obsolete	18-6456	Volvo	855507	Obsolete
18-6350	Mercury Marine	43-853640A2	Obsolete	18-6457	Mercury Marine	807757T	752
18-6350K	Mercury Marine	43-803104T1	Obsolete	18-6475	Honda	31630-ZW5-003	258
18-6351	Mercury Marine	43-853641A2	847	18-6476	Honda	31630-ZY6-003	258
18-6351K	Mercury Marine	43-803103T1	846	18-6500	Mercury Marine	84-881262A2	390
18-6352	Mercury Marine	43-853642A2	847	18-6501	OMC	307573	334
18-6352K	Mercury Marine	43-803106T1	846	18-6501	OMC	395460	334
18-6353	Mercury Marine	43-853643A2	847	18-6503	OMC	318944	334
18-6353K	Mercury Marine	43-803105T1	846	18-6506	Mercury Marine	24-29340A1	394
18-63966	Yamaha	68M-11181-10-00	549	18-6506	Mercury Marine	24-29340T1	394
18-63968	Yamaha	65W-11181-30-00	Obsolete	18-6509	OMC	326877	334
18-6399	OMC	984264	933	18-6511	OMC	312932	334
18-6400	Mercury Marine	12784	848	18-6512	OMC	330525	334
18-6400	Mercury Marine	12784T	848	18-6513	OMC	203698	334
18-6401	Mercury Marine	12784A10	848	18-6522	OMC	323653	334
18-6401	Mercury Marine	12784A4	848	18-6522	OMC	338534	334
18-6404	Mercury Marine	865503T	848	18-6523			1007
18-6406	Mercury Marine	865493A01	849	18-6525	OMC	397003	Obsolete
18-6406	Mercury Marine	865496A01	849	18-6526	OMC	397004	359
18-6406	Mercury Marine	865496A01	849	18-6527	OMC	395911	Obsolete
18-6406	Mercury Marine	865510T	849	18-6528	OMC	396161	Obsolete
18-6406	Mercury Marine	865511T	849	18-6528	OMC	5000581	Obsolete
18-6410	Yamaha	689-81800-11	495	18-65450	Yamaha	6E9-82575-02-00	32, 493
18-6410	Yamaha	689-81800-12	495	18-6650	Yamaha	6M6-81960-A0-00	570
18-6410	Yamaha	689-81800-13-00	495	18-6651	Yamaha	66V-81960-00-00	570

1 This product is priced per piece. To order, priced per package, please add -9 to the part number

2 Items ending in "D" are display packaged - regular number is non-display

3 For discount shop pack of 10, please add -10 to the part number

SIERRA #	O.E.M.	O.E. #	PAGE #	SIERRA #	O.E.M.	O.E. #	PAGE #
SIERRA							
18-6652	Yamaha	6K8-81960-A0-00	570	18-6767-1	OMC	172850	278
18-6742	Honda	36120-ZY3-023	259	18-6767-1	OMC	173564	278
18-6743	Honda	36120-ZY9-003	259	18-6767-1	OMC	173596	278
18-6745	Honda	36120-ZY6-013	259	18-6768	Mercury Marine	392-8261A1	720
18-6744	OMC	5006319	278	18-6768	Mercury Marine	392-8263	720
18-6746	Mercury Marine	14336A20	720	18-6768	Mercury Marine	74436A9	720
18-6746	Mercury Marine	14336A20	720	18-6768	Mercury Marine	79271A4	720
18-6746	Mercury Marine	14336A25	720	18-6768	Mercury Marine	88475A4	720
18-6746	Mercury Marine	14336A31	720	18-6768	Mercury Marine	93247A7	720
18-6746	Mercury Marine	14336A8	720	18-6768	Mercury Marine	993247A4	720
18-6746	Mercury Marine	865380A03	720	18-6769-1	Mercury Marine	14336A8	720
18-6746	Mercury Marine	865380A13	720	18-6769-1	Mercury Marine	88183A5	720
18-6746	Mercury Marine	88183A5	720	18-6770	Volvo	854346	973
18-6747	Mercuriser	14336A15	719	18-6771	Mercury Marine	17646	381, 720
18-6747	Mercuriser	14336A17	719	18-6771	Mercury Marine	18525	381, 720
18-6747	Mercuriser	14336A22	719	18-6771	Mercury Marine	18525A1	381, 720
18-6747	Mercuriser	14336A28	719	18-6772	Mercury Marine	17649	720
18-6747	Mercuriser	14336A6	719	18-6772	Mercury Marine	17649T	720
18-6747	Mercuriser	14336A9	719	18-6772	Mercury Marine	891736T	720
18-6747	Mercuriser	865380A02	719	18-6773	Mercury Marine	828708	382
18-6747	Mercuriser	865380A05	719	18-6773	Mercury Marine	878265A4	382
18-6747	Mercuriser	865380A15	719	18-6774	Mercury Marine	811628	382
18-6747	Mercuriser	865380A25	719	18-6774	Mercury Marine	828708A1	382
18-6747	Mercuriser	88183A12	719	18-6774	Mercury Marine	878265A6	382
18-6747	Mercuriser	88183A3	719	18-6775	Chrysler Force	824051	242
18-6748	Yamaha	67C-43880-00-00	499	18-6775	Mercury Marine	8116731	382
18-6748	Yamaha	67C-43880-01-00	499	18-6777	Chrysler Force	19217A1	242
18-6749	Mercury Marine	42419A1	719	18-6777	Chrysler Force	19217A5	242
18-6749	Mercury Marine	42419A1	719	18-6777	Chrysler Force	818903A1	242
18-6749	Mercury Marine	58397A2	719	18-6777	Chrysler Force	819479A1	242
18-6749	Mercury Marine	58397A3	719	18-6777	Chrysler Force	819480A1	242
18-6749	Mercury Marine	862548A1	719	18-6777	Chrysler Force	819762A4	242
18-6749	Mercury Marine	88553A1	719	18-6777	Chrysler Force	819762A7	242
18-6749	Mercury Marine	88893A4	719	18-6777	Chrysler Force	81977A8	242
18-6750	Mercury Marine	42419A1	719	18-6777	Chrysler Force	81977A9	242
18-6750	Mercury Marine	862548A1	719	18-6777	Chrysler Force	822870A1	242
18-6751	Mercury Marine	811618	381	18-6777	Chrysler Force	830250A3	242
18-6751	Mercury Marine	811618A1	381	18-6777	Chrysler Force	830250T3	242
18-6751	Mercury Marine	812843A1	381	18-6777	Chrysler Force	832021A1	242
18-6751	Mercury Marine	813442A1	381	18-6777	Chrysler Force	832021A2	242
18-6751	Mercury Marine	813442A2	381	18-6777	Chrysler Force	832021T2	242
18-6751	Mercury Marine	893929A01	381	18-6777	Chrysler Force	832021T4	242
18-6751	Mercury Marine	99660A1	381	18-6777	Chrysler Force	85654A1	242
18-6752	Mercury Marine	14336A15	719	18-6777	Chrysler Force	85654T2	242
18-6752	Mercury Marine	14336A17	719	18-6777	Mercury Marine	19217A1	382
18-6752	Mercury Marine	14336A22	719	18-6777	Mercury Marine	19217A5	382
18-6752	Mercury Marine	14336A28	719	18-6777	Mercury Marine	818903A1	382
18-6752	Mercury Marine	14336A6	719	18-6777	Mercury Marine	819479A1	382
18-6752	Mercury Marine	14336A9	719	18-6777	Mercury Marine	819480A1	382
18-6752	Mercury Marine	88183A11	719	18-6777	Mercury Marine	819762A4-A7	382
18-6752	Mercury Marine	88183A12	719	18-6777	Mercury Marine	81977A8-A9	382
18-6752	Mercury Marine	88183A6	719	18-6777	Mercury Marine	822870A1	382
18-6752	Mercury Marine	96477A3	719	18-6777	Mercury Marine	830250A3	382
18-6753	Mercury Marine	14336A9	719	18-6777	Mercury Marine	830250T3	382
18-6753	Mercury Marine	88183A12	719	18-6777	Mercury Marine	832021A1	382
18-6754	OMC	382138	896	18-6777	Mercury Marine	832021A2	382
18-6754	Prestolite	ETK 4001	896	18-6777	Mercury Marine	832021T2	382
18-6754	Prestolite	ETK 4101	896	18-6777	Mercury Marine	832021T4	382
18-6754	Prestolite	ETK 4102	896	18-6777	Mercury Marine	854472A2	382
18-6755	OMC	982058	896	18-6777	Mercury Marine	854472A3	382
18-6755	OMC	982706	896	18-6777	Mercury Marine	854472A4	382
18-6755	Prestolite	EVD 4001	896	18-6777	Mercury Marine	85654A1	382
18-6755	Prestolite	EVD 4002	896	18-6777	Mercury Marine	85654T2	382
18-6756			278	18-6778	Mercury Marine	883166A1	720
18-6757			382	18-6778	Mercury Marine	883166A2	720
18-6758	Electrolux	5024/120	974	18-6779	OMC	986280	896
18-6758	Volvo	850834	974	18-6779	OMC	3853945	974
18-6759	OMC	391264	278	18-6779	Volvo	986280	974
18-6759	OMC	393988	278	18-6779	Volvo	3853945	974
18-6759	OMC	394176	278	18-6780	OMC	434496	278
18-6759	OMC	985237	278	18-6780	OMC	438529	278
18-6760	Yamaha	6G5-43880-02-00	499	18-6780	OMC	438531	278
18-6761	OMC	387277	278	18-6781	Yamaha	6H1-43880-02-00	499
18-6761	OMC	582048	278	18-6782	Yamaha	61A-43880-01-00	499
18-6761	OMC	582155	278	18-6782	Yamaha	61A-43880-02-00	499
18-6761	OMC	584107	278	18-6783	Yamaha	64E-43880-00-00	499
18-6762	Chrysler Force	455541	242	18-6783	Yamaha	64E-43880-01-00	499
18-6762	Chrysler Force	449541-3	242	18-6785	Suzuki	38100-87000-01T	480
18-6762	OMC	172543	278	18-6785	Suzuki	38100-87E10-0ED	480
18-6763	Mercury Marine	67914A2	720	18-6785	Suzuki	38100-87E20-0ED	480
18-6763	Mercury Marine	79271A4	720	18-6786-1	Suzuki	38100-87D10-0ED	480
18-6763	Mercury Marine	92975A28		18-6786-1	Suzuki	38100-87D10-01T	480
18-6763	Mercury Marine	92975A32	382	18-6786-1	Suzuki	38100-87D10-35J	480
18-6763	Mercury Marine	92975A6	720	18-6786-1	Suzuki	38100-92E00-0ED	480
18-6764	OMC	982069	896	18-6787	Yamaha	67F-43880-00-00	499
18-6764	OMC	982073	896	18-6788	Yamaha	6H5-43880-02-00	499
18-6764	OMC	983318	896	18-6789	Yamaha	62X-43880-09-00	499
18-6765	Mercury Marine	823653A5	382	18-6790	Electrolux	KS3448/290	974
18-6765	Mercury Marine	823653A9	382	18-6790	Volvo	839430	974
18-6765	Mercury Marine	92459A4	382	18-6791	Volvo	850046	974

1 This product is priced per piece. To order, priced per package, please add -9 to the part number

2 Items ending in "D" are display packaged - regular number is non-display

3 For discount shop pack of 10, please add -10 to the part number

SIERRA #	O.E.M.	O.E. #	PAGE #	SIERRA #	O.E.M.	O.E. #	PAGE #
SIERRA							
18-6791	Volvo	852520	974	18-6839	Volvo	1357199-7	970
18-6792	Volvo	854329	974	18-6839	Volvo	3523301-4	970
18-6792	Volvo	897720	974	18-6839	Volvo	5003564-1	970
18-6793	Honda	36120-ZV5-822	259	18-6840	Mercury	50-897755T	390
18-6793	Suzuki	38100-87J11	480	18-6840	Mercury	897755T	390
18-6793	Suzuki	38100-87J20	480	18-6841	Mercuriser	56045	721
18-6798	Yamaha	60V-43880-00-00	499	18-6841	Mercuriser	59755	721
18-6798	Yamaha	69J-43880-00-00	499	18-6841	Mercuriser	69729	721
18-6799	Mercury Marine	392-8261A1	720	18-6841	Mercuriser	78477	721
18-6799	Mercury Marine	392-8263	720	18-6841	Mercuriser	90794	721
18-6799	Mercury Marine	74436A9	720	18-6841	Mercuriser	78403A1	721
18-6799	Mercury Marine	79271A4	720	18-6841	Mercuriser	78403A2	721
18-6799	Mercury Marine	88475A4	720	18-6841	OMC	983424	895
18-6799	Mercury Marine	93247A4	720	18-6841	OMC	983836	895
18-6799	Mercury Marine	93247A7	720	18-6841	OMC	988247	895
18-6801	OMC	5005114	279	18-6842	Mercuriser	56045	721
18-6802	OMC	5005113	279	18-6842	Mercuriser	59755	721
18-6803	OMC	5005115	279	18-6842	Mercuriser	69729	721
18-6803	OMC	5007662	279	18-6842	Mercuriser	78477	721
18-6804	Volvo	3861575	973	18-6842	Mercuriser	90794	721
18-6806	Volvo	3587079	973	18-6842	Mercuriser	78403A1	721
18-6806	Volvo	3857489	973	18-6842	Mercuriser	78403A2	721
18-6806	Volvo	3860879	973	18-6842	OMC	983247	664
18-6811	Yamaha	62X-43880-00-00	499	18-6842	OMC	983424	664
18-6811	Yamaha	62X-43880-01-00	499	18-6842	OMC	983836	664
18-6811	Yamaha	62Y-43800-11-00	499	18-6843	Mando	A000B0341	1012
18-6811	Yamaha	62Y-43880-00-00	499	18-6843	Mando	TA000B0341	1012
18-6811	Yamaha	69W-43880-00-00	499	18-6843	Yamaha	19-1400-10	1012
18-6812	Yamaha	62X-43880-00-00	500	18-6844	Denso	101211-3460	721
18-6812	Yamaha	62X-43880-01-00	500	18-6844	Mercuriser	834832	721
18-6812	Yamaha	62X-43880-09-00	500	18-6844	Mercuriser	834832T2	721
18-6813	Mercuriser	14336A15	720	18-6844	Mercuriser	857006A3	721
18-6813	Mercuriser	14336A20	720	18-6845	Volvo	3862613	971
18-6813	Mercuriser	14336A6	720	18-6845	Volvo	3862665	971
18-6813	Mercuriser	14336A8	720	18-6845	Volvo	3884950	971
18-6813	Mercuriser	14336A9	720	18-6846	Volvo Penta	72021	679, 971
18-6813	Mercuriser	865380A13	720	18-6846	Volvo Penta	845940	679, 971
18-6813	Mercuriser	88183A12	720	18-6846	Volvo Penta	872022	679, 971
18-6813	Mercuriser	88183A5	720	18-6846	Volvo Penta	872757	679, 971
18-6813	Mercuriser	88183A8	720	18-6846	Volvo Penta	873635	679, 971
18-6814	OMC	984356	896	18-6846	Volvo Penta	873757	679, 971
18-6815	Johnson/Evinrude	5005831	278	18-6846	Volvo Penta	1502272	679, 971
18-6816	OMC	172588	278	18-6846	Volvo Penta	5001677	679, 971
18-6816	OMC	173944	278	18-6846	Volvo Penta	3803270-2	679, 971
18-6817	Volvo	3858071	973	18-6846	Volvo Penta	873757-9	679, 971
18-6817	Volvo Penta	854525-3	973	18-6846	Volvo Penta	873771	679, 971
18-6818	Power Pole	PUMP SPN-F	74	18-6847	Volvo	2655301	971
18-6819	Power Pole	PUMP PRO-F	74	18-6847	Volvo	3862613	971
18-6821	Yamaha	688-43880-11-00	500	18-6848	Valeo	A0002655299	971
18-6821	Yamaha	6E5-43880-01-00	500	18-6848	Volvo	2656299	971
18-6821	Yamaha	6E5-43880-02-00	500	18-6848	Volvo	3862612	971
18-6822	OMC	172543	973	18-6849	Denso	101211-9940	679
18-6822	OMC	382715	973	18-6849	Yanmar	119773-77200	679
18-6822	Volvo Penta	820545	973	18-6851	Universal	Universal	70
18-6822	Volvo Penta	852928	973	18-6852	Universal	Universal	71
18-6823	Universal	259, 278, 474, 480, 500, 720, 896, 973		18-6853	Universal	Universal	72
18-6824	Mercuriser	50-60594A	392	18-6854	Universal	Universal	73
18-6824	Mercuriser	50-60594A1	392	18-6855	Universal	Universal	74
18-6824	Mercuriser	50-60594T01	392	18-6856	Universal	Universal	75
18-6825	Mercury	50-86976	392	18-6857	Yamaha PWC	63M-81960-00-00	570
18-6826	Johnson/Evinrude	586768	284	18-6858	Yamaha PWC	6H2-81960-00-00	570
18-6827	Suzuki	31100-94600	479	18-6859	Sea-Doo	278-001-376	569
18-6827	Suzuki	31100-94601	479	18-6859	Sea-Doo	278-001-802	569
18-6827	Suzuki	31100-94610	479	18-6860	Sea-Doo		569
18-6828	Mercury	50-41583	392	18-6861	Hitachi	S114-559B	496
18-6829	Mercury	859168	392	18-6861	Yamaha	61A-81800-01-00	496
18-6829	Mercury	50-859168T	392	18-6861	Yamaha	69L-81800-00-00	496
18-6829	Mercury	50-852570	392	18-6861	Yamaha	69W-81800-00	496
18-6829	Mercury	50-852570T	392	18-6862	Yamaha	64X-81800-00-00	569
18-6829	Mercury	50-857065	392	18-6862	Yamaha	6M6-81800-10-00	569
18-6829	Mercury	50-859168	392	18-6863	OMC	584605, 586275	284
18-6829	Mercury	859168T	392	18-6864	Mercury	50-819271	392
18-6831	Hitachi	S114-837	479	18-6864	Mercury	50-820193A1	392
18-6831	Hitachi	S114-837A	479	18-6866	Sea-Doo	278-000-576	569
18-6831	Suzuki	31100-90J00	479	18-6866	Sea-Doo	278-000-577	569
18-6832	Yamaha	60V-81800-00-00	496	18-6866	Sea-Doo	278-001-038	569
18-6832	Yamaha	60X-81800-00-00	496	18-6866	Sea-Doo	278-001-301	569
18-6833	Yamaha	69L-81800-00-00	496	18-6867	Denso	228000-4550	569
18-6834	GM Engines		615, 664, 969, 1012	18-6867	Sea-Doo	278-000-484	569
18-6835	GM Engines		583, 595, 615, 633, 644, 969, 1012	18-6867	Sea-Doo	278-000-485	569
18-6836	Yamaha	6C5-43880-00-00	500	18-6867	Sea-Doo	278-001-300	569
18-6836	Yamaha	6C5-43880-01-00	500	18-6867	Sea-Doo	278-001-935	569
18-6838	Volvo	852928	973	18-6868	Denso	995435	569
18-6838	Volvo	872449	973	18-6868	Denso	128000-4860	569
18-6838	Volvo	873051	973	18-6868	Denso	128000-4861	569
18-6838	Volvo	3586765	973	18-6868	Denso	128000-4862	569
18-6839	Volvo	1357199	970	18-6868	Denso	128000-4863	569
18-6839	Volvo	3523301	970	18-6868	Denso	128000-4864	569
18-6839	Volvo	5003564	970	18-6868	Sea-Doo	278-000-186	569
				18-6868	Sea-Doo	278-000-311	569

1 This product is priced per piece. To order, priced per package, please add -9 to the part number

2 Items ending in "D" are display packaged - regular number is non-display

3 For discount shop pack of 10, please add -10 to the part number

SIERRA #	O.E.M.	O.E. #	PAGE #	SIERRA #	O.E.M.	O.E. #	PAGE #
SIERRA							
18-6868	Sea-Doo	278-000-316	569	18-6936	Yanmar	114362-77010	680
18-6869	Sea-Doo	278-001-497	569	18-6936	Yanmar	114362-77011	680
18-6869	Sea-Doo	278-001-936	569	18-6936	Yanmar	114399-77010	680
18-6870	Mercury	50-805833	680	18-6937	Hitachi	S114-303	680
18-6870	Mercury	50-805833T	680	18-6937	Hitachi	S114-303A	680
18-6871	Sea-Doo	278-001-292	570	18-6937	Yanmar	128170-77010	680
18-6872	Volvo	233991	680, 970	18-6937	Yanmar	128170-77010D	680
18-6872	Volvo	240501	680, 970	18-6938	Yanmar	119773-77010	680
18-6872	Volvo	837924	680, 970	18-6939	Yanmar	121254-77010	680
18-6872	Volvo	842775	680, 970	18-6939	Yanmar	121254-77011	680
18-6872	Volvo	843511	680, 970	18-6939	Yanmar	121254-77012	680
18-6872	Volvo	881681	680, 970	18-6939	Yanmar	121254-77019	680
18-6872	Volvo	847306-8	680, 970	18-6939	Yanmar	129429-77010	680
18-6873	Denso	428000-0081	569	18-6939	Yanmar	129429-77011	680
18-6873	Kawasaki	21163-3715	569	18-6940	Mercury	50-825991A2	392
18-6873	Kawasaki	21163-3719	569	18-6941	Suzuki	31100-93J00	479
18-6874	Sea-Doo	278-001-581	570	18-6941	Suzuki	31100-96J00	479
18-6875	Kawasaki PWC	21174-3703	570	18-6941	Suzuki	31100-96J01	479
18-6876	Sea-Doo	278-001-554	570	18-6942	Hitachi	S114-682	496
18-6877	Honda PWC	31200-HW1-671	569	18-6942	Yamaha	69W-81800-00-00	392
18-6878	Sea-Doo	278-000-123	570	18-6943	Mercury	50-893894	496
18-6879	Sea-Doo	278-001-239	570	18-6943	Yamaha	66M-81800-01-00	496
18-6880	Hitachi	S114-257	680	18-6943	Yamaha	66M-81800-02-00	496
18-6880	Hitachi	S114-257G	680	18-6944	Bosch	0-001-109-035	680
18-6880	Hitachi	S114-483	680	18-6944	Caterpillar	163-3361	680
18-6880	Hitachi	S114-483A	680	18-6944	Perkins	185086600	680
18-6880	Yanmar	129573-77010	680	18-6944	Volvo	3583555	680
18-6880	Yanmar	171008-77010	680	18-6944	Volvo	21323043	680
18-6881	Prestolite	873051	973	18-6945	Johnson	5036972	284
18-6881	Volvo	852928	973	18-6945	Suzuki	31100-95J00	479
18-6881	Volvo	872449	973	18-6945	Suzuki	31100-95J01	479
18-6904	Kawasaki	21163-3720	569	18-6945	Mercuriser	50-8M8021116	717
18-6904	Kawasaki	21163-3720	569	18-6947	Mercuriser	50-805991	680, 717
18-6905	Sea-Doo	290-888-993	569	18-6948	Mercury	822571	679
18-6905	Sea-Doo	290-888-999	569	18-6948	Mercury	8M0084523	721
18-6905	Sea-Doo	420-888-9933	569	18-6949	Mercuriser	50-831001562	680, 717
18-6905	Sea-Doo	420-888-994	569	18-6949	Mercuriser	50-831001961	680, 717
18-6905	Sea-Doo	420-888-996	569	18-6950	OMC	982019	896
18-6906	Yamaha PWC	64X-81800-00-00	569	18-6951	Volvo	851120	679
18-6907	Yamaha PWC	6D3-81800-00-00	569	18-6952	Cummins	214169	679
18-6908	Yamaha PWC	63M-81800-00-00	570	18-6952	Cummins	3920618	679
18-6909	Yamaha PWC	6S5-81800-00-00	570	18-6952	Cummins	3603853RX	679
18-6919	Arctic Cat PWC	3008-093	570	18-6952	Delco	1100077	679
18-6919	Arctic Cat PWC	3008-327	570	18-6952	Delco	1100093	679
18-6919	Arctic Cat PWC	3008-462	570	18-6952	Delco	1100211	679
18-6919	Arctic Cat PWC	3008-536	570	18-6952	Delco	1100274	679
18-6921	Yamaha PWC	60E-81800-00-00	570	18-6952	Delco	1105474	679
18-6925	Hitachi	LR135-105	679	18-6952	Delco	1105475	679
18-6925	Yanmar	128270-77200	679	18-6952	Delco	1105476	679
18-6926	Yanmar	119836-77200	679	18-6952	Delco	10459244	679
18-6926	Yanmar	119836-77200-2	679	18-6953	Volvo	3803645	679
18-6926	Yanmar	119836-77200-3	679	18-6953	Volvo	8602629	679
18-6926	Yanmar	129612-77230	679	18-6953	Volvo	8602710	679
18-6927	Yanmar	119573-77200	679	18-6953	Volvo	8602714	679
18-6927	Yanmar	119573-77201	679	18-6953	Volvo	8676496	679
18-6927	Yanmar	129470-77200	679	18-6953	Volvo	8676498	679
18-6928	Hitachi	LR135-74	679	18-6953	Volvo	8676499	679
18-6928	Hitachi	LR135-74B	679	18-6954	Mercury	50-831001671	680
18-6928	Yanmar	128170-77200	679	18-6954	Mercury	50-831001672	680
18-6928	Yanmar	128170-77201	679	18-6954	Mercury	50-831002050	680
18-6928	Yanmar	128170-77202	679	18-6954	Mercury	50-831002051	680
18-6929	Hitachi	129470-77200	679	18-6954	Mercury	50-831002052	680
18-6929	Hitachi	LR180-03A	679	18-6955	Caterpillar	3001117	679, 971
18-6929	Hitachi	LR180-03B	679	18-6955	Caterpillar	10-258	679, 971
18-6929	Hitachi	LR180-03C	679	18-6955	Prestolite	110-258	679, 971
18-6929	Yanmar	119573-77200	679	18-6955	Prestolite	110-258A	679, 971
18-6929	Yanmar	119573-77201	679	18-6955	Volvo	849748-9	679, 971
18-6930	Yanmar	104211-77010	680	18-69550	Volvo	3854164	972
18-6930	Yanmar	104211-77011	680	18-6956	Volvo	6209190	970
18-6931	Yanmar	119209-77010	680	18-6957	Mercuriser	50-801333980	680, 717
18-6931	Yanmar	121120-77010	680	18-6957	Mercuriser	50-854178	680, 717
18-6931	Yanmar	121120-77011	680	18-6957	Mercuriser	50-855507	680, 717
18-6931	Yanmar	121120-77012	680	18-6958	Volvo	870998	680, 970
18-6931	Yanmar	124520-77010	680	18-6958	Volvo	881682	680, 970
18-6931	Yanmar	124520-77011	680	18-6958	Volvo	847308-4	680, 970
18-6932	Yanmar	121370-77010	680	18-6959	Honda	31200-ZY6-003	259
18-6932	Yanmar	129242-77010	680	18-6959	Honda	31200-ZY9-003	259
18-6932	Yanmar	129698-77010	680	18-6959	Honda	31200-ZY9A-0031	259
18-6934	Hitachi	S13-68	680	18-6960	Denso	101211-3020	721
18-6934	Hitachi	S13-68A	680	18-6960	Denso	101211-3021	721
18-6934	Hitachi	S13-68C	680	18-6960	Mercuriser	821663	721
18-6934	Hitachi	S13-86	680	18-6960	Mercuriser	8216631	721
18-6934	Yanmar	123500-77010	680	18-6960	Mercuriser	821663A1	721
18-6934	Yanmar	124610-77010	680	18-6961	Yamaha	6CB-81800-00-00	496
18-6934	Yanmar	124610-77019	680	18-6970	Yanmar	129470-77200	679
18-6934	Yanmar	424610-77010	680	18-6971	Yanmar		679
18-6935	Yanmar	119225-77010	680	18-6975	Universal		664, 721, 971
18-6935	Yanmar	119225-77011	680	18-7000	Volvo	841292	974
18-6935	Yanmar	119226-77010	680	18-7000	Volvo	856471	974
18-6935	Yanmar	119226-77011	680	18-7000	Volvo	856472	974

1 This product is priced per piece. To order, priced per package, please add -9 to the part number

2 Items ending in "D" are display packaged - regular number is non-display

3 For discount shop pack of 10, please add -10 to the part number

SIERRA #	O.E.M.	O.E. #	PAGE #	SIERRA #	O.E.M.	O.E. #	PAGE #
SIERRA							
18-7000	Volvo	841836-0	974	18-7052	Honda		261
18-7001	Volvo	841293-4	974	18-7053	Honda		261
18-7002	Yamaha	6E5-W0093-06-00	501	18-7054	Yamaha	6G1-14546-00-00	502
18-70021			984	18-7054	Yamaha	6G1-14546-01-00	502
18-7004	Mercury Marine	1395-6200	395	18-7055	Yamaha	6E5-14546-00-00	502
18-7005	Mercury Marine	1395-6452	395	18-7055	Yamaha	6J8-14546-00-00	502
18-700-5500			104	18-7056	Yamaha	67F1439A-00-00	502
18-7006-1	Mercury Marine	879194024	395	18-7056	Yamaha	6H2-14591-00-00	502
18-7006-1	Mercury Marine	1395-4808	395	18-7056	Yamaha	6H3-14590-00-00	502
18-7006-1	Mercury Marine	1395-879194024	395	18-7056	Yamaha	6H3-14590-01-00	502
18-7006-1	Mercury Marine	1399-1717	395	18-7057	Chrysler Force	F010790	243
18-7006-1	Mercury Marine	1399-2015	395	18-7057	Mercury Marine	1395-9258	396
18-7006-1	Mercury Marine	1399-3523	395	18-7057	Mercury Marine	1395-9258 1	396
18-700-6250			104	18-7057	Mercury Marine	1399-1138	396
18-700-6500			104	18-7057	Mercury Marine	1399-1473	396
18-700-6750			104	18-7058	Yamaha	63V-W0093-00-00	500
18-7007	Mercury Marine	1399-5135	395	18-7059	Yamaha	677-W0093-00-00	500
18-7007	Mercury Marine	1399-5198	395	18-7059	Yamaha	677-W0093-04-00	500
18-700-7000			104	18-7060	Yamaha	692-14590-00-00	503
18-700-7250			104	18-7060	Yamaha	692-14590-01-00	503
18-700-7500			104	18-7061	Mercury Marine	1395-8318	396
18-700-7750			104	18-7061	Mercury Marine	1395-83181	396
18-7008			976	18-7062	Mercury Marine	1395-95951	396
18-700-8000			104	18-7063	Yamaha	6L2-14385-00-00	503
18-700-8250			104	18-7064	Yamaha	63V-14985-00	503
18-700-8500			104	18-7065	Yamaha	647-14385-00-00	503
18-700-9000A			104	18-7066	Yamaha	648-14385-00-00	503
18-700-9250			104	18-7067	Yamaha	6G1-14985-00-00	503
18-700-9500			104	18-7068	Yamaha	6E5-14385-00-00	503
18-7010	OMC	382050	285	18-7068	Yamaha	6E5-14385-01-00	503
18-7010	OMC	382051	285	18-7069	Yamaha	6E5-14385-02-00	503
18-7010	OMC	382054	285	18-7070	Mercury Marine	1397-2072	737
18-7013			395	18-7070	Mercury Marine	1397-2637	737
18-7017	OMC	985052	898	18-7070	Mercury Marine	1397-3464	737
18-7017	Pleasurecraft	RN0118-1	645	18-7070	Mercury Marine	1397-7542	737
18-7017	Pleasurecraft	RN0120-1	645	18-7070	Mercury Marine	1397-7543	737
18-7018	OMC	982352	Obsolete	18-7070	Mercury Marine	1397-8872	737
18-7019			584, 616	18-7070	OMC	383615	898
18-7021			395	18-7070	OMC	982384	898
18-7022			584, 616	18-7070			584, 616, 653
18-7023			584	18-70704	Mercury Marine	32-89653	737
18-7024	OMC	382052	285	18-70704	Volvo	838513	984
18-7024	OMC	382053	285	18-70704	Volvo	856308	984
18-7024	OMC	385356	285	18-70704			910
18-7025			584	18-7071	Mercury Marine	1397-3458	737
18-7026	OMC	382057	Obsolete	18-7071	OMC	380186	898
18-7033	Chrysler Force	FK10003	243	18-7071			653
18-7033	Chrysler Force	FK10026	243	18-7072	Mercury Marine	1397-3306	738
18-7033	Chrysler Force	FK10053	243	18-7072	Mercury Marine	1397-4329	738
18-7033	Chrysler Force	FK10102-1	243	18-7072	Mercury Marine	1397-5635	738
18-7037	Chrysler Force	FK10004	243	18-7072	Mercury Marine	1397-6638	738
18-7037	Chrysler Force	FK10005	243	18-7072	Mercury Marine	823426A1	738
18-7037	Chrysler Force	FK10007	243	18-7072	OMC	384743	898
18-7037	Chrysler Force	FK10008	243	18-7072	OMC	979659	898
18-7037	Chrysler Force	FK10027	243	18-7072	Volvo	855889	974
18-7037	Chrysler Force	FK10057	243	18-7072			584, 616
18-7037	Chrysler Force	FK10108	243	18-7073	Yamaha	6E7-14390-12-00	503
18-7037	Chrysler Force	FRK739	243	18-7073	Yamaha	6E8-14380-12-00	503
18-7093	OMC	379312	286	18-7075	Mercury Marine	1397-5830	737
18-7093	OMC	387262	286	18-7075	Mercury Marine	1397-5831	737
18-7093	OMC	396520	286	18-7075	Mercury Marine	1397-7099	737
18-7039			175	18-7075	Mercury Marine	1397-8760	737
18-7040			976	18-7076	Mercury Marine	1397-6367	738
18-7041	Chrysler Force	FO10790	245	18-7076	Mercury Marine	1397-8367A1	738
18-7041	Chrysler Force	FO16311	245	18-7077	Mercury Marine	1397-8952	738
18-7042	OMC	392061	285	18-7077	Mercury Marine	823426A1	738
18-7042	OMC	396701	285	18-7078	Mercury Marine	1337-2103	738
18-7042	OMC	398729	285	18-7078	Mercury Marine	1337-2604	738
18-7043	OMC	382045	285	18-7078	Mercury Marine	1397-2133	738
18-7043	OMC	382046	285	18-7078	Mercury Marine	1397-2605	738
18-7043	OMC	382047	285	18-7078	Mercury Marine	1397-3462	738
18-7043	OMC	382049	285	18-7078			616
18-7043	OMC	383052	285	18-7079	Yamaha	626-14390-90	503
18-7043	OMC	383067	285	18-7080	Mercury Marine	1346-2770	738
18-7043	OMC	398532	285	18-7080	Mercury Marine	1398-3089	738
18-7043	OMC	439071	285	18-7080	OMC	979719	898
18-7044-1		175158+437228	286	18-7081	Mercury Marine	1396-4656	738
18-7046	OMC	390055	285	18-7081	OMC	982537	898
18-7046	OMC	392550	285	18-7081	OMC	983538	645
18-7046	OMC	398526	285	18-7081	Pleasurecraft	RN0116	645
18-7046	OMC	434888	285	18-7081	Pleasurecraft	RN0116-2	645
18-7046	OMC	435443	285	18-7083	Mercury	684311	404
18-7046	OMC	439076	285	18-7083	Mercury	816877	404
18-7047	Honda	16011-ZV4-005	261	18-7083	Mercury	858763	404
18-7048	Honda	16011-881-741	261	18-7083	Mercury	8168771	404
18-7049	Yamaha	61N-14392-00-00	502	18-7083	Mercury	8168772	404
18-7049	Yamaha	62Y-14392-00-00	502	18-7083	Mercury	8168773	404
18-7049	Yamaha	6L2-14392-00-00	502	18-7085	Volvo	875407	974
18-7050	Honda		261	18-7086	OMC	984487	898
18-7051	Honda		261	18-7086	Volvo	841994	975

1 This product is priced per piece. To order, priced per package, please add -9 to the part number

2 Items ending in "D" are display packaged - regular number is non-display

3 For discount shop pack of 10, please add -10 to the part number

SIERRA #	O.E.M.	O.E. #	PAGE #	SIERRA #	O.E.M.	O.E. #	PAGE #
SIERRA							
18-7086			616	18-710-28-2			122
18-7089			595	1 18-7103	Mercury Marine	25-29845	467, 872, 876
18-7091			595	1 18-7103	OMC	308624	368, 951
18-70924			773, 910, 984	18-710-32-2			122, 855, 932
18-70925	Mercury Marine	32-16021	772	18-710-36-2			122
18-70925	Mercury Marine	32-160211	772	1 18-7104	OMC	308627	368, 951
18-70925	Mercury Marine	32-87116	772	18-710-40-2			122
18-70926	Mercury Marine	32-73796	772	18-710-44-2			122
18-70927	Mercury Marine	32-73795	772	18-710-48-2	Mercury Marine	54-32533	855
18-70928	Mercury Marine	32-71613	772	18-710-48-2	Mercury Marine	54-815504348	855
18-70929	Mercury Marine	32-73794	772	18-710-48-2	Volvo	3852604	1006
18-7093	OMC	378895	286	18-710-48-2			124, 1006
18-7093	OMC	396521	286	1 18-7105	Mercury Marine	25-62705	467, 876
18-7093	OMC	678882	286	1 18-7105	Mercury Marine	25-F7848342	467, 876
18-70930	Mercury Marine	32-52481	772	1 18-7105	OMC	311338	368, 951
18-70931	Mercury Marine	32-47640	772	18-710-52-2			122
18-70931	Mercury Marine	32-8M0071007	772	18-710-56-2			122
18-70931	Mercury Marine	32-96679	772	1 18-7106	OMC	307583	286
18-70932	Mercury Marine	32-87117	772	18-710-60-2			122
18-70932	Mercury Marine	32-871171	772	18-710-64-2	Volvo	853012	1006
18-70934	Mercury Marine	32-897181	771	18-710-64-2			122, 855, 932
18-70935	Mercury Marine	32-806856	771	1 18-7107	Mercury Marine	25-67202	467, 876
18-70936	OMC	321724	319	1 18-7107	OMC	313175	368, 951
18-70936	OMC	340975	319	18-710-72-2	Mercury Marine	54-31765	855
18-70937	OMC	340976	319	18-710-72-2	OMC		932
18-70938	Mercury Marine	32-8066351	771	1 18-710-72-2			122
18-70939	Mercury Marine	32-8066361	771	1 18-7108	OMC	313893	368, 951
18-7094	OMC	379313	286	1 18-7108	OMC	338518	368, 951
18-7094	OMC	396522	286	18-710-80-2			122
18-70940	Mercury Marine	32-860144	771	1 18-710-88-2			122
18-70943	Mercury Marine	32-897491	771	18-7109	OMC	317178	368, 951
18-70945	Mercury Marine	32-862139	770	1 18-710-96-2			122
18-70946	Mercury Marine	32-8066362	771	18-7110	OMC	335523	325
18-70947	Mercury Marine	32-862124	770	18-71102	OMC		355
18-70948	Mercury Marine	32-808033	770	18-7111	OMC	301824	368, 951
18-70949	Mercury Marine	32-807407	770	18-7112	OMC	302493	368, 951
18-7095	Crusader	45334	616	18-7113-9	Mercury Marine	25-897536	408
18-7095	Mercury Marine	1397-7539	738	18-7113-9	Mercury Marine	25-98277	408
18-7095	Mercury Marine	1397-7540	738	1 18-7114	Mercury Marine	25-23145	467, 876
18-7095	Mercury Marine	1397-7544	738	1 18-7114	Mercury Marine	25-843315	467, 876
18-7095	Mercury Marine	1397-8535	738	1 18-7114	Mercury Marine	25-F702736	467, 876
18-7095	Mercury Marine	1397-9723	738	1 18-7114	OMC	302540	368, 951
18-7095	OMC	383918	898	18-7115	Mercury Marine	25-26722	467, 876
18-7095	OMC	983864	898	18-7115	OMC	302588	368, 951
18-7095	Volvo	834985-4	975	18-7116	Mercury Marine	802206	467, 876
18-7095			170, 1774 584, 595	18-7116	Mercury Marine	25-20633	467, 876
18-70951	Mercury Marine	32-8078961	770	18-7116	Mercury Marine	25-22174	467, 876
18-70951	Mercury Marine	32-8078962	770	18-7116	Mercury Marine	25-62704	467, 876
18-70951	Mercury Marine	32-860205	770	18-7116	Mercury Marine	25-85148	467, 876
18-70952	Mercury Marine	32-887952	770	18-7116	Mercury Marine	25-F24342	467, 876
18-70953	Mercury Marine	32-8080441	770	18-7116	OMC	303067	368, 951
18-70954	Mercury Marine	32-860089	770	18-7116	Volvo	3852045	951
18-70954	Mercury Marine	32-8600891	770	18-7117	Mercury Marine	25-35027	467, 876
18-70955	Mercury Marine	32-16011	770	18-7117	OMC	303360	368, 951
18-70956	Mercury Marine	32-16012	770	1 18-7118	OMC	305242	368, 951
18-70958	Mercury Marine	32-96246	771	1 18-7118	Suzuki	09280-08008	
18-70958	Mercury Marine	32-96246A1	771	18-7119	Yamaha	93210-33M85-00	
18-70958	Mercury Marine	32-96246A4	771	18-7120	Chrysler Force	25-F498618	
18-7096	Mercury Marine	1356-4066	738	18-7120	Mercury Marine	25-38933	467, 876
18-7096	Mercury Marine	1356-4092	738	18-7120	OMC	307853	368, 951
18-7096	Mercury Marine	1356-5155	738	18-7120	OMC	332598	951
18-7096	Mercury Marine	1356-5169	738	18-7121	Mercury Marine	802231	467, 876
18-7096	Mercury Marine	1396-5222	738	18-7121	Mercury Marine	25-35029	467, 876
18-7096	Mercury Marine	1396-5238	738	18-7121	Mercury Marine	25-882613	467, 876
18-7096	OMC	982539	899	18-7121	OMC	308621	368, 951
18-7096	OMC	85F-4541	899	18-71218	Mercury Marine	32-48131	773
18-7096	Pleasurecraft	RM0118	645	18-71218	Mercury Marine	32-48132	773
18-7096	Pleasurecraft	RM0120	645	18-71218			910, 984
18-7097	Mercury Marine	3302-804845	738	18-7122	Volvo	925095	1011
18-7097	Mercury Marine	3302-9437	738	18-7123	OMC	308876	368, 951
18-7098-1	Mercury Marine	3302-804844	738	18-7124			467
18-7098-1	Mercury Marine	3302-804844001	738	18-7125			467
18-7098-1	Mercury Marine	3302-804844002	738	18-7126	OMC	313340	368, 951
18-7099	Volvo	824803	975	18-7127	Chrysler Force	25-32507	257
18-7099	Volvo	856470	975	18-7127	Chrysler Force	25-F84305	257
1 18-7100	Chrysler Force	25-85594	254	18-7127	Chrysler Force	F83404	257
1 18-7100	Mercury Marine	25-85594	467	18-7127	Mercury Marine	25-32507	876
1 18-7100	OMC	301877	368, 951	18-7127	Mercury Marine	25-F84305	876
18-710-06-2			122, 855, 932	18-7127	OMC	313446	368, 951
18-710-08-2			122	18-7128	OMC	313754	368, 951
1 18-7101	OMC	305739	368, 951	1 18-7129	OMC	314491	368, 951
18-710-10-2			122, 855	18-7130	OMC	314728	368, 951
18-710-104-2			122, 855	1 18-7133	OMC	305123	368, 951
18-710-12-2			122, 855, 932	1 18-7133	OMC	322119	368, 951
18-710-16-2			122, 855, 932	1 18-71330	Yamaha	93210-05001	523
1 18-7102	Mercury Marine	25-62706	467	18-71331	Yamaha	93210-44704	522
1 18-7102	OMC	307450	368, 951	18-71332	Yamaha	93210-45161	523
1 18-7102	Volvo	3852073	1011	18-71333	Yamaha	93210-49046	522
18-710-20-2			122, 855, 932	18-71334	Yamaha	93210-59MG7	523
18-710-24-2			122, 855, 932	18-71335	Honda	91301-ZG3-000	263

1 This product is priced per piece. To order, priced per package, please add -9 to the part number

2 Items ending in "D" are display packaged - regular number is non-display

3 For discount shop pack of 10, please add -10 to the part number

SIERRA #	O.E.M.	O.E. #	PAGE #	SIERRA #	O.E.M.	O.E. #	PAGE #
SIERRA							
18-71336	Johnson/Evinrude	302035	302, 303	18-7168	OMC	202893	368, 951
18-71337	Mercury Marine	32-806825	773	18-7168	Volvo	3852033	1011
18-71337	Mercury Marine	32-861590A05	773	18-7169	Chrysler Force	25-F24278	257
18-71337	Mercury Marine	32-861590A1	773	18-7169	Mercury Marine	25-35984	467, 876
18-71337	Mercury Marine	32-861590A2	773	18-7169	Mercury Marine	25-70937	467, 876
18-71337	OMC	312781	911	18-7169	OMC	911686	368, 951
18-71337			984	18-7170	Mercury Marine	25-33504	467, 876
18-71338	Johnson/Evinrude	346865	302	18-7170	OMC	307239	368, 951
18-71340	Johnson/Evinrude	342370	303	18-7171	Mercury Marine	25-30529	467, 876
18-7134	Chrysler Force	25-20195	257	18-7172	Mercury Marine	25-31305	467, 876
18-7134	Chrysler Force	25-201951	257	18-7172	OMC	553126	368, 951
18-7134	Mercury Marine	25-20195	876	18-7173	Mercury Marine	25-27018	467, 876
18-7134	Mercury Marine	25-201951	876	18-7173	Mercury Marine	25-30224	467, 876
18-7134	OMC	303059	368, 951	18-7173	OMC	310327	368, 951
18-7135	Mercury Marine	25-20365	467, 876	18-7174	Mercury Marine	25-45711	467, 876
18-7135	Mercury Marine	25-35276	467, 876	18-7174	Mercury Marine	25-F455342	876
18-7135	OMC	310584	368, 951	18-7174	OMC	326649	368, 951
18-7135	Volvo	3852089	1011	18-7174	OMC	910562	368, 951
18-7137	OMC	318372	368, 951	18-7175	Mercury Marine	25-62817	467, 876
18-7138	OMC	318717	368, 951	18-7176	Chrysler Force	25-F74305	257
18-7139	OMC	319085	368, 951	18-7176	Mercury Marine	25-896523	467, 876
18-7140	OMC	323003	368, 951	18-7176	Mercury Marine	25-F74305	467, 876
18-7140	Suzuki	09280-75002	490	18-7176	Mercury Marine	F694555	467, 876
18-7141	OMC	321117	368, 951	18-7176	Mercury Marine	F74305	467, 876
18-7141	Volvo	3852165	1011	18-7176	Mercury Marine	F74305-1	467, 876
18-7142	OMC	322119	368, 951	18-7177	Mercury Marine	25-53421	467, 877
18-7143	Mercury Marine	25-65936	467, 876	18-7177	Mercury Marine	25-59712	467, 877
18-7143	Mercury Marine	27-58025	467, 876	18-7178	OMC	320140	368, 951
18-7143	Mercury Marine	391-5081	467, 876	18-7178	Volvo	125017	1011
18-7143	OMC	322501	368, 951	18-7179	Volvo	925054	1011
18-7143	OMC	331188	368, 951	18-7180	Mercury Marine	12-31060	467, 877
18-7143	Volvo	3852169	368, 951	18-7180	Mercury Marine	25-26802	467, 877
18-7144	OMC	326849	368, 951	18-7180	Mercury Marine	25-8M2000926	467, 877
18-7145	Mercury Marine	25-64068	467, 876	18-7180	OMC	303347	368, 951
18-7145	OMC	333572	368, 951	18-7180	Volvo	925055	1011
18-7146	Mercury Marine	25-47632	467, 876	18-7181	Volvo	925091	993, 1011
18-7146	OMC	554545	368, 951	18-7181	Volvo	975672	993, 1011
18-7147-9	Volvo	949658-9	1011	18-7182	Volvo	925092	489, 1011
18-7149	Volvo	955989	255, 1011	18-7183	Volvo	925093	489, 1011
18-7150	OMC	303598	368, 951	18-7184	Volvo	925256	1011
18-7150	OMC	331380	368, 951	18-7186	Volvo	925259	1011
18-7150	OMC	334913	368, 951	18-7187	Volvo	925261	1011
18-7151	Mercury Marine	25-20081	467, 876	18-7188	Mercury Marine	25-805726	467, 877
18-7151	Mercury Marine	25-39572	467, 876	18-7188	Volvo	955983	1011
18-7152	Mercury Marine	25-20863	467, 876	18-7190	Volvo	925065	1011
18-7152	OMC	307082	368, 951	18-7192	Volvo	955995	1011
18-7153	Mercury Marine	25-20679	467, 876	18-7193	Volvo	955974	1011
18-7153	Mercury Marine	25-25439	467, 876	18-7194	Volvo	956000	1011
18-7153	Mercury Marine	25-F53795-1	467, 876	18-7195	Mercury Marine	25-8M0027717	467, 877
18-7153	Mercury Marine	F53795	467, 876	18-7198	Honda	91353-ZW1-003	268
18-7153	OMC	911851	368, 951	18-7198	Mercury Marine	25-45710	467, 877
18-7153	OMC	3852565	368, 951	18-7198	OMC	308626	368, 951
18-7154	Volvo	949656	1011	18-7200	Crusader	45303	617
18-7155	Mercury Marine	25-26855	467, 876	18-7200	Mercury Marine	1397-2060	739
18-7155	OMC	305270	368, 951	18-7200	OMC	381389	900
18-7156	Mercury Marine	25-29439	467, 876	18-7200	Volvo	841634-9	975
18-7156	OMC	309731	368, 951	18-7200			584
18-7157	Mercury Marine	25-29976	467, 876	18-72000	Mercury Marine	1395-9594	396
18-7158	Mercury Marine	25-30613	467, 876	18-72005			864
18-7158	Mercury Marine	25-846357	467, 876	18-7201	Mercury Marine	1397-3327	739
18-7158	OMC	310585	368, 951	18-7201	Mercury Marine	1397-8546	739
18-7158	OMC	310967	368, 951	18-7201	Mercury Marine	1397-8959	739
18-7159	Mercury Marine	25-31534	467, 876	18-7201	OMC	383087	900
18-7159	Mercury Marine	25-48451	467, 876	18-7201	OMC	983871	900
18-7160	Mercury Marine	25-31986	467, 876	18-7201			584, 585, 617
18-7161	Mercury Marine	25-32546	467, 876	18-7202	Mercury Marine	1397-5837	739
18-7162	Mercury Marine	25-32424	467, 876	18-7202	Mercury Marine	3302-9031	739
18-7162	Mercury Marine	25-33145	467, 876	18-7202			617, 975
18-7162	OMC	302337	467, 876	18-7208	Mercury Marine	1395-8673	396
18-7162	Volvo	3852044	1011	18-7208	Mercury Marine	1395-8963	396
18-7163	Mercury Marine	25-33465	467, 876	18-7209	Mercury Marine	1395-9293	396
18-7163	Mercury Marine	25-807149	467, 876	18-7210	OMC	382363	286
18-7163	Mercury Marine	25-853220	467, 876	18-7211-1	Mercury Marine	1395-8112231	395
18-7164	Mercury Marine	25-33466	467, 876	18-7212	Mercury Marine	1395-811357	395
18-7164	Mercury Marine	25-33466	467, 876	18-7212	Mercury Marine	1395-9179	395
18-7164	Mercury Marine	25-67675	467, 876	18-7212	Mercury Marine	1395-9377	395
18-7164	Mercury Marine	25-846356	467, 876	18-7212	Mercury Marine	1395-9645	395
18-7164	OMC	302537	368, 951	18-7212	Mercury Marine	1395-9725	395
18-7165	Mercury Marine	25-32509	467, 876	18-7212	Mercury Marine	1395-9761	395
18-7165	Mercury Marine	25-806609	467, 876	18-7212	Mercury Marine	1395-97611	395
18-7165	Mercury Marine	25-F461342	467, 876	18-7212	Mercury Marine	1395-9803	395
18-7165	OMC	304174	368, 951	18-7213	Mercury Marine	8107492	395
18-7166	Mercury Marine	25-45254	467, 876	18-7214	Mercury Marine	8107493	395
18-7167	Mercury Marine	25-861844	467, 876	18-7215	Mercury Marine	1395-9024	395
18-7167	OMC	310414	368, 951	18-7219	OMC	431897	285
18-7168	Mercury Marine	25-20587	467, 876	18-7219	OMC	439073	285
18-7168	Mercury Marine	25-21720	467, 876	18-7221	OMC	435442	285
18-7168	Mercury Marine	25-26834	467, 876	18-7222	OMC	392061	285
18-7168	Mercury Marine	25-48171	467, 876	18-7222	OMC	396701	285
18-7168	Mercury Marine	25-801334436	467, 876	18-7222	OMC	398729	285

1 This product is priced per piece. To order, priced per package, please add -9 to the part number

2 Items ending in "D" are display packaged - regular number is non-display

3 For discount shop pack of 10, please add -10 to the part number

SIERRA #	O.E.M.	O.E. #	PAGE #	SIERRA #	O.E.M.	O.E. #	PAGE #
SIERRA							
18-7223	OMC	391305	286	18-7272	Crusader	97039	167, 169, 618
18-7223	OMC	391937	286	18-7272			585
18-7223	OMC	398452	286	18-7274	Mercury Marine	71646	167, 743
18-7223	OMC	398453	286	18-7274	Mercury Marine	78485	167, 743
18-7223	OMC	439072	286	18-7274	Mercury Marine	86246	167, 743
18-7226	Mercury Marine	1395-9650	395	18-7274	Mercury Marine	86246A1	167, 743
18-7227	Mercury Marine	1396-4148	739	18-7274	Mercury Marine	86246T	167
18-7227	Pleasurecraft	RN0067	644	18-7274	OMC	509409	167
18-7228	Mercury Marine	85784A1	742	18-7275	Mercury Marine	46860	167, 743
18-7229	Mercury Marine	85785-2	742	18-7275	Mercury Marine	63196	167, 743
18-7229	Mercury Marine	85785T	742	18-7275	Mercury Marine	78820	167, 743
18-7229	OMC	981566	902	18-7275	Mercury Marine	86247	167, 743
18-7229	OMC	986865	902	18-7275	Mercury Marine	86247A2	167, 743
18-7229	Volvo	3854026	976	18-7275	Mercury Marine	86247T	167, 743
18-7230	Chrysler Inboard	4142886	596	18-7275	OMC	509410	167
18-7230	Mercury Marine	41639	742	18-7278	Mercury Marine	47585	167, 743
18-7230	Mercury Marine	41639A1	742	18-7278	Mercury Marine	71327	167, 743
18-7231	Crusader	97214	617	18-7278	Mercury Marine	77594	167, 743
18-7231	Crusader	97595	617	18-7278	Mercury Marine	86234	167, 743
18-7231	Mercury Marine	85785A2	742	18-7278	Mercury Marine	86234A05	167, 743
18-7232	Crusader	33628	617	18-7278	Mercury Marine	86234A3	167, 743
18-7232	Mercury Marine	57882	664, 742	18-7278	Mercury Marine	86234A4	167, 743
18-7232	Mercury Marine	57882T	664, 742	18-7278	OMC	509395	167
18-7233	Mercury Marine	1395-7824	396	18-7278	OMC	982240	167, 901
18-7234	Mercury Marine	805016A1	742	18-7278	OMC	985602	167, 901
18-7235	OMC	986783	899	18-7278	OMC	985603	167, 901
18-7236	OMC	986782	899	18-7278			585
18-7237	OMC	986784	899	18-7281	Volvo	826493	167, 976
18-7237	OMC	986799	899	18-7282	Mercury Marine	42725A3	167, 743
18-7237			975	18-7282	Mercury Marine	861676T09	167, 743
18-7238	OMC	986796	899	18-7282	OMC	509407	167
18-7238	Volvo	3854020	975	18-7283	Mercury Marine	97401	167, 743
18-7239	OMC	986800	899	18-7283	Mercury Marine	861678A1	167, 743
18-7241	OMC	986804	899	18-7283	Mercury Marine	861678A1	167, 743
18-7241	Volvo	3855017	975	18-7283	Mercury Marine	8M0058164	167, 743
18-7242	OMC	987313	899	18-7283	Mercury Marine	97401A2	167, 743
18-7242	Volvo	3854105	975	18-7283	Mercury Marine	97401A8	167, 743
18-7243	OMC	987315	899	18-7283	OMC	509404	167
18-7244	OMC	987317	899	18-7284	Mercury Marine	41141A2	167, 743
18-7244	Volvo	3854106	975	18-7284	Mercury Marine	862077A1	167, 743
18-7245	OMC	987319	899	18-7284	OMC	509408	167
18-7245	Volvo	3854107	975	18-7286	Volvo	841161	168, 976
18-7246	OMC	987438	899	18-7288-1	Mercury Marine	97399	168, 743
18-7246	OMC	987440	899	18-7288-1	Mercury Marine	812454A1	168, 743
18-7246	OMC	987485	899	18-7288-1	Mercury Marine	812454A3	168, 743
18-7246	Volvo	3854116	975	18-7288-1	Mercury Marine	862048A1	168, 743
18-7247	OMC	435442	285	18-7288-1	Mercury Marine	97399A2	168, 743
18-7247	OMC	438996	285	18-7289	OMC	982997	168, 901
18-7248	OMC	435676	286	18-7290	Mercury Marine	84419M	395
18-7248	OMC	435677	286	18-7290	Nissan/Tohatsu	345871224M	475
18-7248	OMC	435678	286	18-7290	Yamaha	696-W0093-02-00	501
18-7248	OMC	435752	286	18-7291	Mercury Marine	84475M	395
18-7248	OMC	437327	286	18-7291	Nissan/Tohatsu	346871220M	475
18-7248	OMC	439078	286	18-7291	Yamaha	6H1-W0093-01-00	501
18-7248	OMC	439079	286	18-7293	Mercury Marine	92520M	395
18-7249	Mercury Marine	19273	396	18-7293	Yamaha	6A1-W0093-01-00	501
18-72510			865	18-7295	Mercury Marine	1395-9022	396
18-725-2000			122	18-7296	OMC	315232	286
18-7254	Chrysler Force	3745414	167, 596	18-7300			1006
18-7254	Chrysler Inboard	3745414	167, 596	18-7306	Volvo	853548	1006
18-725-4000			122	18-73131	Mercury	98230A1	849
18-7255	Chrysler Force	3745415	167, 596	18-7321	Mercury Marine	54-38863	853
18-7255	Chrysler Inboard	3745415	167, 596	18-7321	Mercury Marine	54-866507	853
18-7256	Crusader	32722	167, 617	18-7321	Mercury Marine	54-8M0090424	853
18-7256	Mercury Marine	32722	167, 743	18-7326	Mercury Marine	805025A2	168, 743
18-7256			901	18-7326	Mercury Marine	805656A2	168, 743
18-7258	GM	6414989	168	18-7326	Mercury Marine	805656A5	168, 743
18-7258	OMC	380986	168	18-7326	Mercury Marine	805656A6	168, 743
18-7260			167, 169, 585, 617	18-7326	Mercury Marine	861155A5	168, 743
18-7264	Chrysler Force	1736073	167, 596	18-7326	Mercury Marine	861155A6	168, 743
18-7264	Chrysler Force	2279913	167, 596	18-7326	OMC	3850809	168, 902
18-7264	Chrysler Inboard	1736073	167, 596	18-7326	OMC	3854620	168, 902
18-7264	Chrysler Inboard	2279913	167, 596	18-7326	OMC	3857986	168, 902
18-7265	Chris-Craft	16.83-08758	167, 169, 585, 901	18-7326	OMC	3858261	168, 902
18-7265	Chris-Craft	F18308762	167, 169, 585, 901	18-7326	Volvo	3850809	168, 978
18-7265			167, 169, 585, 901	18-7326	Volvo	3854620	168, 978
18-72656	Nissan/Tohatsu	332600052M	477	18-7326	Volvo	3857986	168, 978
18-72656	Nissan/Tohatsu	332600060M	477	18-7326	Volvo	3858261	168, 978
18-7266			167, 743	18-7328	Mercury	14307701	399
18-7267	Mercury Marine	54552	167, 743	18-7330	OMC	988037	168, 902
18-7267	Mercury Marine	62092	167, 743	18-7330	OMC	3854280	168, 902
18-7267	Mercury Marine	62092	167, 743	18-7330	OMC	3855958	168, 902
18-7267	Mercury Marine	62092T	167, 743	18-7330	OMC	3857650	168, 902
18-7267	OMC	982063	167, 901	18-7330	Volvo	988037	168, 978
18-7267			617, 646	18-7330	Volvo	3854280	168, 978
18-7268	OMC	981650	167, 901	18-7330	Volvo	3855958	168, 978
18-7268	Volvo	3855276	167, 978	18-7330	Volvo	3857650	168, 978
18-7268			617	18-7331	OMC	3850810	168, 902
18-7270	Crusader	21140	167, 169, 618	18-7331	OMC	3857985	168, 902
18-7271	Crusader	21141	169	18-7331	OMC	3858714	168, 902

1 This product is priced per piece. To order, priced per package, please add -9 to the part number

2 Items ending in "D" are display packaged - regular number is non-display

3 For discount shop pack of 10, please add -10 to the part number

SIERRA #	O.E.M.	O.E. #	PAGE #	SIERRA #	O.E.M.	O.E. #	PAGE #
SIERRA							
18-7331	Volvo	3850810	168, 978	18-73979	Yamaha	6L2-45987-01-00	551
18-7331	Volvo	3857985	168, 978	18-73990	Yamaha	6H4-W4599-00-00	551
18-7331	Volvo	3858714	168, 978	18-73993	Yamaha		Obsolete
18-7332			168, 665	18-73994	Yamaha		551
18-7333			168	18-73995	Yamaha	66T-W4599-00-00	552
18-7334	Yamaha	663-24410-00-00	505	18-73996	Yamaha	67F-W4599-00-00	552
18-7334	Yamaha	692-24410-00-00	505	18-7400	Mercury Marine	25-818573	435
18-7334	Yamaha	6A0-24410-00-00	505	18-7400	OMC	908194	368, 951
18-7334	Yamaha	6A0-24410-01-00	505	18-7401	OMC	908383	368, 951
18-7334	Yamaha	6A0-24410-02-00	505	18-7403	OMC	909316	368, 951
18-7334	Yamaha	6A0-24410-03-00	505	18-7404	OMC	909747	368, 951
18-7334	Yamaha	6A0-24410-04-00	505	18-7406	OMC	911311	368, 951
18-7334	Yamaha	6A0-24410-05-00	505	18-7406	Volvo	3852523	951
18-7336	Mercury	888733T02	399	18-7407	OMC	911700	368, 951
18-7337	Mercury	898101T67	399	18-7407	OMC	3852531	368, 951
18-7338	Mercury	880596T55	399	18-7407	Volvo	3852531	951
18-7339	Yamaha	691-13907-04-00	505	18-7408	OMC	911718	368, 951
18-7340	Yamaha	68V-13907-00-00	505	18-7409	OMC	911871	368, 951
18-7340	Yamaha	68V-13907-01-00	505	18-7410	Mercury Marine	25-36390	467, 877
18-7340	Yamaha	68V-13907-02-00	505	18-74108	OMC	5030973	364
18-7340	Yamaha	68V-13907-03-00	505	18-7411	Mercury Marine	25-35480	467, 877
18-7341	Yamaha	66K-13907-00-00	505	18-7411	Mercury Marine	25-47386	467, 877
18-7342	Yamaha	68F-13907-00-00	505	18-7411	Mercury Marine	25-8M2000816	467, 877
18-7342	Yamaha	68F-13907-01-00	505	18-7411	OMC	321921	368
18-7343	Yamaha	60V-13907-00-00	505	18-7413	Mercury Marine	22-22175	467, 877
18-7344	Yamaha	6AW-13907-00-00	505	18-7413	Mercury Marine	25-62702	467, 877
18-7345	Yamaha	68J-13907-04-00	505	18-7413	Mercury Marine	25-F50342-1	467, 877
18-7346	Mercury	880596T58	399	18-7413	Mercury Marine	F17510	467, 877
18-7347	Mercury	8M0065218	399	18-7413	Mercury Marine	F50342	467, 877
18-7348	Suzuki	15200-96J00	480	18-7413	OMC	303191	368, 951
18-7349	Yamaha	6E5-24410-00-00	505	18-7414	Mercury Marine	25-62384	467, 877
18-7349	Yamaha	6E5-24410-01-00	505	18-7414	Mercury Marine	25-823683	467, 877
18-7349	Yamaha	6E5-24410-02-00	505	18-7415	Mercury Marine	25-64966	Obsolete
18-7349	Yamaha	6E5-24410-03-00	505	18-7416	OMC	329380	368, 951
18-7349	Yamaha	6E5-24410-04-00	505	18-7417	OMC	329381	368, 951
18-7349	Yamaha	6E5-24410-10-00	505	18-7418	OMC	326741	368, 951
18-7350	OMC	391638	288	18-7419	Mercury Marine	25-69202	467, 877
18-7350	OMC	395091	288	18-7420	Mercury Marine	25-21836	467, 877
18-7350	OMC	397274	288	18-7421	Mercury Marine	25-16524	467, 877
18-7350	OMC	397839	288	18-7426	Mercury Marine	25-30271	467, 877
18-7351	OMC	438562	288	18-7428	OMC	307103	332, 363
18-7352	OMC	382354	288	18-7432	Yamaha	93210-32738-00	568
18-7352	OMC	385781	288	18-7436	Yamaha	93210-46044-00	568
18-7352	OMC	388268	288	18-7439-9	Yamaha	93210-54M54-00	568
18-7352	OMC	394543	288	18-7440-1	Mercury Marine	25-36318	467, 877
18-7352	OMC	395713	288	18-7440-1	OMC	301967	368, 951
18-7352	OMC	398338	288	18-7442	Yamaha	93210-74M35-00	568
18-7352	OMC	398387	288	18-7444	Yamaha	93211-04384-00	568
18-7352	OMC	432451	288	18-7445	Mercury Marine	25-55801	Obsolete
18-7352	OMC	433387	288	18-7449	Mercury Marine	25-97387	467, 877
18-7352	OMC	438556	288	18-74501	Mariner	27-99049M	462
18-7353	OMC	433386	288	18-74501	Yamaha	683-W0001-C1-00	567
18-7353	OMC	438555	288	18-74504	Yamaha	6H3-W0001-22-00	567
18-7354	Mercury Marine	1395-8506	395	18-74507	Yamaha	63V-W0001-21-00	567
18-7355	Mercury Marine	1395-811691 2	395	18-74510	Yamaha	65L-W0001-C0-00	567
18-7356	Mercury Marine	1395-811691 3	395	18-74512	Yamaha	66K-W0001-20-00	567
18-7367	Yamaha		506	18-74515	Yamaha	68V-W0001-20-00	567
18-7368	Yamaha		506	18-74527	Yamaha	6G9-W0001-C6-00	567
18-7369	Yamaha		506	18-74535	Yamaha	67F-W0001-20-00	567
18-7370N	MerCruiser	1389-815396A2	170, 732	18-74540	Yamaha	62Y-W0001-20-00	567
18-7370N	MerCruiser	1389-8490A2	170, 732	18-74544	Yamaha	68T-W0001-20-00	567
18-7370N	MerCruiser	1389-9350A2	170, 732	18-74546	Yamaha		567
18-7370N	MerCruiser	1389-9562A1	170, 732	18-7457	Chrysler Force	25-F45530	257
18-7370N	MerCruiser	3310-806077A2	170, 732	18-7457	OMC	319662	368, 951
18-7370N	MerCruiser	3310-806078A2	170, 732	18-7459	Mercury Marine	20311	467, 877
18-7370N	MerCruiser	3310-860070A2	170, 732	18-7459	Mercury Marine	25-20826	467, 877
18-7373N	MerCruiser	3310-864941A01	170, 732	18-7461	OMC	308458	368, 951
18-7375N	MerCruiser	3310-861448A1	170, 732	18-74610	Nissan/Tohatsu	398873213M	476
18-7375N	MerCruiser	3310-861448A1	170, 732	18-74611	Nissan/Tohatsu	346873217M	476
18-7375N	MerCruiser	3310-864942A01	170, 732	18-7463	Yamaha	93210-19123-00	568
18-7376N	MerCruiser	3310-861245A1	170, 732	18-7464	Mercury Marine	25-39695	467, 877
18-7376N	MerCruiser	3310-864943A01	170, 732	18-7464	Mercury Marine	25-846361	467, 877
18-7380	Mercury	809569	396	18-7467	Mercury Marine	25-54030	467, 877
18-7381	Mercury	16253	396	18-7467	Mercury Marine	25-F523555	467, 877
18-7382	Mercury	804184	396	18-7467	Mercury Marine	F532555	467, 877
18-7388	Yamaha	6G1-24411-00-00	505	18-7468	Yamaha	6G5-43864-00-00	568
18-7389	Yamaha	6E0-24411-00-00	505	18-7469	Yamaha	64E-43869-00-00	568
18-73891	Yamaha	68D-G5987-00-00	551	18-7470	Yamaha	65W-43865-00-00	568
18-73892	Yamaha	6L5-45616-00-00	552	18-7471	Yamaha	93210-94003-00	568
18-73893	Yamaha	91490-25030-00	551	18-7474	Mercury Marine	25-94288	467, 877
18-7390	Yamaha	63V-24411-00-00	505	18-7475	OMC	332584	368, 951
18-73907	Yamaha	90171-14056-00	552	18-7477	OMC	909048	368, 951
18-7391	Yamaha	892-24411-00-00	505	18-7480	Pleasurecraft	R047111	646
18-73914	Yamaha	670-45997-02-00	551	18-7481	OMC	324981	332
18-73918	Yamaha	63P-45987-00-00	551	18-7483	Yamaha	93210-37M67-00	568
18-7392	Yamaha	676-14985-01-00	503	18-7484	Yamaha	65W-43871-00-00	500
18-7393	Yamaha	6E7-14385-00-00	503	18-7485	Yamaha	93210-86M38-00	568
18-7394	Racor	RK10012	154	18-7486	Yamaha	61A-24564-00-00	509
18-73964	Nissan/Tohatsu		477	18-7487	Yamaha	65L-24564-00-00	509
18-73978	Yamaha	90201-08M54-00	551	18-7488	Yamaha	6P3-24564-00-00	509

1 This product is priced per piece. To order, priced per package, please add -9 to the part number
 2 Items ending in "D" are display packaged - regular number is non-display
 3 For discount shop pack of 10, please add -10 to the part number

SIERRA #	O.E.M.	O.E. #	PAGE #	SIERRA #	O.E.M.	O.E. #	PAGE #
SIERRA							
18-7489	Mallory	9-34081	666	18-7609-1	Rochester	7036543	171
18-7492	Volvo	3854161	958	18-7609-1	Rochester	7040082	171
18-7493	Mercury Marine	392889925	678	18-7609-1	Rochester	7041369	171
18-7493	Volvo	3859078	958	18-7609-1	Rochester	7043182	171
18-7494	Honda	30520-PNA-007	258	18-7609-1	Rochester	7044182	171
18-7508	Mercury Marine	16792A33	809	18-7609-1	Rochester	17059054	171
18-7508	Mercury Marine	16792A39	809	18-7610-1	Mercury Marine	1347-818621	171, 732
18-7510	OMC	321163	368, 951	18-7610-1	Mercury Marine	1347-818621 1	171, 732
18-75100	Mercury Marine	32-8M0062614	773	18-7610-1	Mercury Marine	1347-818621 1R02	171, 732
18-75100	OMC	910305	911	18-7610-1	Rochester	17081060	171
18-75100	OMC	912424	911	18-7611-2	Mercury Marine	3310-807312R02	171, 732
18-75100	OMC	913488	911	18-7611-2	Mercury Marine	3310-807312A1	171, 732
18-75100	OMC		984	18-7613-1	Mercury Marine	3310-806969 R01	171, 732
18-7511-9	Yamaha	93210-16716-00	568	18-7613-1	Mercury Marine	3310-806969A1	171, 732
18-7512	Chrysler Inboard	7087-OR	Obsolete	18-7615-1	Mercury Marine	1347-804624 R02	171, 732
18-75125	Mercury Marine	32-5346170	773	18-7615-1	Mercury Marine	1347-804624R1	171, 732
18-75125	Mercury Marine	32-865672070	773	18-7615-1	Mercury Marine	1347-816373A4	171, 732
18-75125	Mercury Marine	32-8M0062665	773	18-7615-1	OMC	981359	171, 897
18-75125	OMC	912793	911	18-7615-1	OMC	981428	171, 897
18-75125	Volvo	826423	984	18-7615-1	OMC	981564	171, 897
18-75125	Volvo	845792	984	18-7615-1	OMC	981705	171, 897
18-7513	Volvo	3862500	20, 980	18-7615-1	OMC	981803	171, 897
18-7514	Volvo Penta	22797780	995	18-7615-1	OMC	982223	171, 897
18-7516	Yamaha	67F-24251-02-00	509	18-7615-1	OMC	983855	171, 897
18-7517	Yamaha	65L-24563-00-00	509	18-7615-1	OMC	985822	171, 897
18-7518	Yamaha	6P2-WS245-00-00	509	18-7615-1	Rochester	17057298	171
18-7521	Honda	16910-ZVL-003	260	18-7615-1	Rochester	17059280	171
18-7523	Mercury	35-880084T01	408	18-7615-1	Rochester	17059288	171
18-7550	Mercury	861249	727	18-7615-1	Rochester	17080561	171
18-7550	Mercury	861249A1	727	18-7615-1	Rochester	17085013	171
18-7551	Mercury	861425	728	18-7615N	Mercuriser		170, 174, 732, 897
18-7552	Honda	37830-PGK-A01	261	18-7616-1	Mercury Marine	1347-804626 R02	171, 733
18-7553	Mercury	808015T	728	18-7616-1	Mercury Marine	1347-8288A1	171, 733
18-7554	Mercury	878187	728	18-7616-1	Rochester	1708563	171
18-7556	Mercury	864297001	698	18-7616-1	Rochester	17057287	171
18-7558	Honda	30530-PPL-A01	261	18-7616-1	Rochester	17059287	171
18-7559	Honda	30530-PBF-A01	261	18-7616-1	Rochester	17059290	171
18-7596	Mercury	35-866594K01	407	18-7616-1	Rochester	17080560	171
18-7598			163	18-7617-1	Mercury Marine	1347-804625R02	171, 733
18-7599			163, 261, 403	18-7617-1	Mercury Marine	1347-804625R1	171, 733
18-7600	Crusader	47002	616	18-7617-1	Mercury Marine	1347-9863A3	171, 733
18-7600	Mercury Marine	805218T	727	18-7617-1	Rochester	17059280	171
18-7601	OMC	3854158	896	18-7618-1	Mercury Marine	1347-804624 R1	171, 733
18-7601	Volvo	3854158	980	18-7618-1	Mercury Marine	1347-804624R02	171, 733
18-7603-1	Mercury Marine	1347-818622	171, 732	18-7618-1	Mercury Marine	1347-8289A1	171, 733
18-7603-1	Mercury Marine	1347-818622 1	171, 732	18-7618-1	Rochester	7044291	171
18-7603-1	Mercury Marine	1347-818622R02	171, 732	18-7618-1	Rochester	17059289	171
18-7603-1	Mercury Marine	1376-5659A1	171, 732	18-7618-1	Rochester	17080561	171
18-7603-1	Rochester	7044185	171	18-7618-1	Rochester	17080562	171
18-7604-1	Mercury Marine	1347-804623R02	171, 732	18-7619-1	Mercury Marine	1347-8460A3	176, 733
18-7604-1	Mercury Marine	1347-804623R1	732	18-7619-1	Mercury Marine	1347-9142A2	176, 733
18-7604-1	Mercury Marine	3304-9354A2	171, 732	18-7619-1	Rochester	17059283	171
18-7605-1	Mercury Marine	1347-804623A1	171, 732	18-7619-1	Rochester	17059298	171
18-7605-1	Mercury Marine	1347-804623R02	171, 732	18-7619-1	Rochester	17081299	171
18-7605-1	Mercury Marine	1347-9661A3	171, 732	18-7619-1	Rochester	17083522	171
18-7605-1	OMC	382821	174, 897	18-7628			170, 666
18-7605-1	OMC	383766	174, 897	18-7630	Crusader	47032	616
18-7605-1	OMC	384194	174, 897	18-7630	Mercury Marine	805226A1	727
18-7605-1	Rochester	17057283	171	18-7632-1	Crusader	47033	616
18-7605-1	Rochester	17057285	171	18-7632-1	Mercury Marine	805224A1	727
18-7605-1	Rochester	17059291	171	18-7633	Mercury Marine	17693A2	868
18-7605-1	Rochester	17059292	171	18-7633	Mercury Marine	63115A12	868
18-7605-1	Rochester	17080564	171	18-7633	Mercury Marine	805320A03	868
18-7605-1	Rochester	17080565	171	18-7633	Mercury Marine	805320A1	868
18-7606	Yamaha	MAR-10171-30-00	512	18-7633	Mercury Marine	88678A4	868
18-7607-1	Rochester	17082403	171	18-7633	Mercury Marine	88678A5	868
18-7608-1	Mercury Marine	1347-818620	171, 732	18-7633	Mercury Marine	96863A15	868
18-7608-1	Mercury Marine	1347-818620 1	171, 732	18-7634	OMC	984748	945
18-7608-1	Mercury Marine	1347-818620R02	171, 732	18-7635			170, 897
18-7608-1	OMC	381668	174, 897	18-7636			170, 897
18-7608-1	OMC	980528	174, 897	18-7637			170, 664, 897
18-7608-1	OMC	982217	174, 897	18-7638			170, 664, 897
18-7608-1	OMC	982219	174, 897	18-7639			171, 732
18-7608-1	Rochester	7040080	171	18-7639	Mercury Marine	3310-864943A01	171, 732
18-7608-1	Rochester	7040083	171	18-7640	Mercury Marine	861245A1	171, 732
18-7608-1	Rochester	7040089	171	18-7641	Volvo	3856393	170, 732, 897
18-7608-1	Rochester	7042183	171	18-7641	Volvo	841047-4	974
18-7608-1	Rochester	7043183	171	18-7641	Volvo	841313-0	974
18-7608-1	Rochester	7043184	171	18-7642	Volvo	3863130	959
18-7608-1	Rochester	17059052	171	18-7643	Volvo	3859082	959
18-7608-1	Rochester	17059057	171	18-7646	Mercury Marine	892615	728
18-7609-1	Mercury Marine	1347-818619	171, 732	18-7646	Mercury Marine	892615001	728
18-7609-1	Mercury Marine	1347-818619 1	171, 732	18-7646	Mercury Marine	892615002	728
18-7609-1	Mercury Marine	1347-818619 1R02	171, 732	18-7646	Pleasurecraft	R020035A	640
18-7609-1	OMC	381494	174, 897	18-7647	Volvo	872066	985
18-7609-1	OMC	382733	174, 897	18-7648	Mercury Marine	392-881732	698
18-7609-1	OMC	772831	174, 897	18-7648	Pleasurecraft	R117012	643
18-7609-1	OMC	980530	174, 897	18-7648	Volvo	3861267	959
18-7609-1	OMC	982217	174, 897	18-7655	Yamaha	67H-8592A-00-00	512
18-7609-1	OMC	984180	174, 897	18-7655	Yamaha	67H-8592A-01-00	512

1 This product is priced per piece. To order, priced per package, please add -9 to the part number

2 Items ending in "D" are display packaged - regular number is non-display

3 For discount shop pack of 10, please add -10 to the part number

SIERRA #	O.E.M.	O.E. #	PAGE #	SIERRA #	O.E.M.	O.E. #	PAGE #
SIERRA							
18-7656	Yamaha	68F-8592A-00-00	512	18-7723			158
18-7657	Honda	35655-ZY3-013	Obsolete	18-7724			158
18-7658	Honda	35655-ZY9-003	261	18-7725			Obsolete
18-7659	Honda	35655-ZY6-013	261	18-7726			595
18-7660	Mercury Marine	881731	727	18-7727			899
18-7660	Mercury Marine	8M0054726	727	18-7728			738
18-7663	Mercury Marine	802630	727	18-7729			899
18-7663	Mercury Marine	802630001	727	18-7730			899
18-7663	Mercury Marine	802630T	727	18-7732	Zenith	K-2035	584
18-7663	Mercury Marine	802630T01	727	18-7732	Zenith	K-2036	584
18-7663	Mercury Marine	8M0069803	727	18-7735	Suzuki	15410-94400	481
18-7664	Mercury Marine	809066	739	18-7736	Yamaha	67D-W0093-00-00	501
18-7665	Mercury Marine	70125	739	18-7737	Yamaha	61N-W0093-00-00	501
18-7665	Mercury Marine	70125A02	739	18-7738	Mercury Marine	802706A1	395
18-7665	Mercury Marine	70125A1	739	18-7738	Yamaha	66M-W0093-00-00	501
18-7666	Mercury Marine	1397-8582	739	18-7738	Yamaha	66M-W0093-01-00	501
18-7667	Mercury Marine	71464	739	18-7739	Yamaha	6L2-W0093-00-00	501
18-7667	Mercury Marine	72625	739	18-7740	Yamaha	6E9-W0093-02-00	501
18-7667	Mercury Marine	71464A01	739	18-7741	Yamaha	6E9-W0093-03-00	501
18-7668	Mercury Marine	854445	728	18-7742	Yamaha	6H0-W0093-00-00	501
18-76689	Yamaha	65W-14198-00-00	568	18-7743	Mercury Marine	804346T1	395
18-76690	Yamaha	93210-46M16-00	568	18-7743	Yamaha	67F-W0093-00-00	501
18-76691	Yamaha	93210-27ME3-00	568	18-7744	Yamaha	6N6-W0093-02-00	501
18-76692	Yamaha	93210-75M51-00	568	18-7746	Mercury Marine	1397-2067	738
18-76693	Yamaha	93210-31MJS-00	568	18-7746	Mercury Marine	1397-2631	738
18-76694	Yamaha	93210-24M79	568	18-7746	Mercury Marine	1397-2634	738
18-76695	Mercury	25-803513007	467	18-7746	Mercury Marine	1397-2637	738
18-76695	Nissan/Tohatsu	3R0074220M	477	18-7746	Mercury Marine	1397-3459	738
18-7677	Mercury Marine	806612T	728	18-7746	Mercury Marine	1397-3464	738
18-7677	OMC	3850357	896	18-7746	Mercury Marine	1397-7542	738
18-7677	Pleasurecraft	R020027	645	18-7746	Mercury Marine	1397-7543	738
18-7677	Volvo	3850357	896	18-7746	Mercury Marine	1397-7547	738
18-7679	OMC	3854905	896	18-7746	Mercury Marine	1397-8872	738
18-7679	Volvo	3854905	980	18-7746	Mercury Marine	1397-8873	738
18-7682	Mercury Marine	849934	727	18-7746	Mercury Marine	823427A1	738
18-7682	Mercury Marine	879150150	727	18-7747	Yamaha	6G5-W0093-08-00	501
18-7683	Mercury Marine	849899	727	18-7748	Mercury Marine	809064	738
18-7684	Mercury Marine	805217A1	727	18-7749	Mercury Marine	809065	738
18-7684	Mercury Marine	864856A1	727	18-7749	Mercury Marine	823728	738
18-7684	OMC	3850396	986	18-7749	Mercury Marine	835076	738
18-7684	Volvo	3850396	980	18-7750-1	Mercury Marine	1395-811222	396
18-7685	Mercury Marine	852956A1	728	18-7750-1	Mercury Marine	1395-823635	396
18-7685	Volvo	3858941	980	18-7750-1	Mercury Marine	1395-8236351	396
18-7688	Mercury Marine	885176	738	18-7750-1	Mercury Marine	1395-8236352	396
18-7689	OMC	3855182	896	18-7750-1	Mercury Marine	1395-8236353	396
18-7689	Volvo	3855182	980	18-7750-1	Mercury Marine	1395-8236354	396
18-7690	Mercury Marine	27-852957	729	18-7750-1	Mercury Marine	1395-9599	396
18-7691	Mercury Marine	806807A1	Obsolete	18-7751	Mercuriser	13220	664, 736
18-7692	Mercury Marine	861260	729	18-7752	Suzuki	13910-87D00	481
18-7692	Mercury Marine	861260T	729	18-7753	Suzuki	13910-94400	481
18-7693			729	18-7754	Suzuki	13910-94701	481
18-7694			729	18-7755	Suzuki	13910-95D00	481
18-7695			729	18-7756	Yamaha	64D-W0093-00-00	501
18-7696			729	18-7757	Mercury Marine	803148	738
18-7697	Mercury Marine	803149	727	18-7757	Volvo	3855296	959
18-7697	Pleasurecraft	R084003	645	18-7758	Mercury Marine	35-877761K01	201, 429
18-7698	Mercury Marine	881693002	Obsolete	18-7758	Mercury Marine	35-877761Q01	201, 429
18-7700	Mercury Marine	853678T	727	18-7759	Yamaha	6K7-W0093-09-00	501
18-7700	Volvo	3857487	980	18-7761			285, 480
18-7701	Mercury Marine	862998	727	18-7765	Mercury Marine	11502M	396
18-7702	Mercury Marine	805223T	769	18-7765	Nissan/Tohatsu	369871221M	475
18-7702	Volvo	3854527	980	18-7765	Yamaha	6G1-W0093-00-00	501
18-7703	Mercury Marine	805544T	728	18-7766	Yamaha	6H3-W0093-02-00	502
18-7703	OMC	3854512	986	18-7767	Yamaha	6H4-W0093-01-00	502
18-7703	Volvo	3854512	980	18-7768	Yamaha	6H4-W0093-03-00	502
18-7704	Volvo	3855194	980	18-7769	Mercury Marine	814481M	396
18-7705	Volvo	3843751	980	18-7769	Yamaha	6E7-W0093-04-00	502
18-7706	Volvo	3858979	959	18-7770	Mercury Marine	84456M	396
18-7708	Volvo	3808516	Obsolete	18-7770	Yamaha	689-W0093-02-00	502
18-7709	Volvo	3840335	979	18-7772	Yamaha	61A-W0093-00-00	502
18-7710-1	Yamaha	68T-24251-00-00	509	18-7772	Yamaha	61A-W0093-01-00	502
18-7711	Suzuki	15410-96J00	481	18-7773	OMC	5032424	285
18-7712	Honda	16910-GB2-005	260	18-7773	Suzuki	13910-89J01	480
18-7712	Mercury Marine	35-16248	407	18-7774			105, 155, 291, 406, 508, 750, 904, 978
18-7712	Nissan/Tohatsu	369022300M	475	18-7775			105, 153, 290, 507, 684, 748
18-7713	Mercury Marine	35-80365M	407	18-7775-1			153, 290, 405, 507, 749, 903, 977
18-7713	Yamaha	646-24251-02-00	509	18-7775-1			749, 903, 977
18-7714	Mercury Marine	35-877565T	407	18-7776			153, 290, 405, 507, 749, 903, 977
18-7714	Mercury Marine	35-877565T1	407	18-7776-1			153, 290, 405, 507, 749, 903, 977
18-7715	Mercury Marine	35-892665	751				
18-7716	OMC	5032323	292, 481				
18-7716	Suzuki	15410-87J10	292, 481				
18-7717	Mercury Marine	35-93568	751				
18-7717			618, 751, 905, 980	18-7777	Yamaha	MAR-FLTHD-SS-12	153, 507
18-7718	Mercury Marine	35-879885T	407	18-7777			105, 291, 405, 507, 749, 902, 977
18-7719	OMC	5032238	292, 481	18-7777-1	Yamaha	ABB-SPRTR-HD-SS	153, 507
18-7719	Suzuki	15410-98500	292, 481	18-7777-1			290, 405, 749
18-7720	Honda	16900-SR3-004	260	18-7778	Volvo	3850861	155, 978
18-7721	Mercury Marine	35-864572	751	18-7780	Yamaha	6F5-24563-00-00	509
18-7722	OMC	5005266	292				

1 This product is priced per piece. To order, priced per package, please add -9 to the part number
 2 Items ending in "D" are display packaged - regular number is non-display
 3 For discount shop pack of 10, please add -10 to the part number

SIERRA #	O.E.M.	O.E. #	PAGE #	SIERRA #	O.E.M.	O.E. #	PAGE #
SIERRA							
18-7781	Yamaha	61N-24563-00-00	509	18-7829	Mercury Marine	35-816296K03	158, 408
18-7782	Yamaha	61A-24563-00-00	509	18-7829	Mercury Marine	35-816296Q	158, 408
18-7783	Volvo	273663	Obsolete	18-7829	Mercury Marine	35-816296T	408
18-7784	Mercury Marine	35-11004A1	751	18-7829			292, 372, 475, 509
18-7784	Mercury Marine	35-803897Q1	751	18-7830	Mercury Marine	35-134301	158, 408
18-7785	Honda	16010-ST5-993	260	18-7830	Mercury Marine	35-164941	158
18-7786	Honda	16900-SA5-004	260	18-7830	Mercury Marine	35-8162961	158, 408
18-7787			505	18-7830	Mercury Marine	35-816296-1	408
18-7788			505	18-7830	Mercury Marine	35-816296B1	158, 408
18-7789	OMC	502906	155, 292, 904	18-7830	Mercury Marine	35-816296B2	158, 408
18-7789	Volvo	3852413	155, 978	18-7830	Mercury Marine	35-816296Q2	158, 408
18-7789	Volvo	3851218-2	155, 978	18-7830	Mercury Marine	35-816296T1	158, 408
18-7790			158, 665	18-7830	Mercury Marine	35-816396Q1	158, 408
18-7791			158, 665	18-7830	OMC	398327	292
18-7792	OMC	910641	904	18-7830	Yamaha	65W-24251-10-00	509
18-7792	OMC	3855104	904	18-7830			158, 372, 475
18-7792	Volvo	3855104	979	18-7831	Mercury Marine	802128A1	158, 408
18-7796	OMC	335334	289	18-7831	OMC	398319	158, 292
18-7797			506	18-7831			372, 475
18-7798			506	18-7832	Mercury Marine	1399-1136	407
18-7799			506	18-7832	Mercury Marine	1399-1754	407
18-7800	OMC	433519	289	18-7832	Mercury Marine	1399-3938	407
18-7800	OMC	438616	289	18-7833	Mercury Marine	11497M	400
18-7801	OMC	379777	289	18-7833	Yamaha	6G1-24471-00-00	506
18-7802	Mercury Marine	35-87946A3	407	18-7834	Mercury Marine	91748M	400
18-7802	Mercury Marine	35-87946Q3	407	18-7834	Yamaha	6E0-24471-00-00	506
18-7802	Mercury Marine	35-87946Q4	407	18-7837	Mercury Marine	84262M	506
18-7804	Mercury Marine	23014A1	400	18-7837	Yamaha	677-24411-02-00	400
18-7805	Chrysler Force	F24747-1	243	18-7838	Mercury Marine	84265M	400
18-7806-1			243, 400	18-7838	Yamaha	677-24471-01-00	506
18-7807	Mercury Marine	55278A1	400	18-7839	Mercury Marine	80606M	400
18-7808	Mercury Marine	55278A5	400	18-7839	Yamaha	648-24411-00-00	505, 506
18-7809	Mercury Marine	55278A3	400	18-7840	Mercury Marine	84141M	400
18-7809	Mercury Marine	55278A4	400	18-7840	Yamaha	663-24411-00-00	505, 506
18-7810	Mercury Marine	90363A1	400	18-7841	Yamaha	6J8-24471-00-00	506
18-7811	Mercury Marine	66599A1	400	18-7842	Yamaha	6E5-24471-00-00	505, 506
18-7811	Mercury Marine	89031A1	400	18-7843	Yamaha	6E5-24411-00-00	505, 506
18-7812	Mercury Marine	66599A2	400	18-7844	Mercury Marine	35-802893Q	153, 407, 750
18-7812	Mercury Marine	89031A2	400	18-7844	Mercury Marine	35-807172	153, 407, 750
18-7813	Mercury Marine	66599A3	400	18-7844			105, 292, 508, 904, 978
18-7813	Mercury Marine	89031A3	400	18-7845	Mercury Marine	35-55501	153, 407, 750
18-7814	Mercury Marine	89031A4	400	18-7845	Mercury Marine	35-57250	153, 407, 750
18-7815	Mercury Marine	1399-5137	396	18-7845	Mercury Marine	35-604941	153, 407, 750
18-7817	Chrysler Force	21-42990A10	243	18-7845	Mercury Marine	35-60494A4	153, 407, 750
18-7817	Chrysler Force	21-42990A7	243	18-7845	Mercury Marine	35-8053691	153, 407, 750
18-7817	Chrysler Force	21-42990A8	243	18-7845	Mercury Marine	35-806771	153, 407, 750
18-7817	Chrysler Force	21-42990A9	243	18-7845	Mercury Marine	35-807172	153, 407, 750
18-7817	Chrysler Force	21-857005A1	243	18-7845	Yamaha	ABB-FUELF-IL-TR	153, 508
18-7817	Mercury Marine	21-42990A10	400	18-7845			105, 292, 508, 904, 978
18-7817	Mercury Marine	21-42990A7	400	18-7846	Crusader	98041	618
18-7817	Mercury Marine	21-42990A8	400	18-7846	OMC	502905	155, 292, 618, 904, 978
18-7817	Mercury Marine	21-42990A9	400	18-7846			978
18-7817	Mercury Marine	21-857005A1	400	18-7847			400
18-7818-1	Mercury Marine	42909A1	400	18-7848-1	Mercury Marine	52444	153, 405, 749
18-7818-1	Mercury Marine	42909A2	400	18-7848-1	Mercury Marine	35-52456A1	153, 405, 749
18-7818-1	Mercury Marine	42909A3	400	18-7848-1	Mercury Marine	35-55501A1	153, 405, 749
18-7818-1	Mercury Marine	42909A4	400	18-7848-1	Mercury Marine	35-57250A1	153, 405, 749
18-7820	OMC	393103	288	18-7848-1	Mercury Marine	35-60494A1	153, 405, 749
18-7821	OMC	395867	288	18-7848-1	Mercury Marine	35-60494A4	153, 405, 749
18-7821	OMC	398514	288	18-7848-1	Mercury Marine	35-802893Q4	153, 405, 749
18-7822	OMC	432962	288	18-7848-1	Mercury Marine	35-805369A4	153, 405, 749
18-7823	OMC	393088	289	18-7848-1	Mercury Marine	35-807172A4	153, 405, 749
18-7824-2	Chris-Craft	16.81-08746	589	18-7848-1			290, 507, 903, 977
18-7824-2	Crusader	201104	201, 630	18-7848-2			154, 290, 405, 507
18-7824-2	Indmar	50-1001	201	18-7852-1	Crusader	22687	618
18-7824-2	Mercury Marine	14957	201, 708	18-7852-1	Yamaha	MAR-SEPAR-AT-OR	153, 507
18-7824-2	Mercury Marine	32716	201, 792	18-7852-1			290, 372, 405
18-7824-2	Mercury Marine	32717	201, 792	18-7852-2			154, 405, 507, 749
18-7824-2	Mercury Marine	52022	201, 792	18-7853-1	Mercury Marine	55481	153, 405, 748
18-7824-2	Mercury Marine	52731	201, 792	18-7853-1	Mercury Marine	89876	153, 405, 748
18-7824-2	Mercury Marine	54111	201, 792	18-7853-1	Mercury Marine	89876A3	153, 405, 748
18-7824-2	Mercury Marine	35-802885Q	201, 792	18-7853-1	Yamaha	MAR-FLTHD-AL-12	153, 507
18-7824-2	Mercury Marine	35-866340K01	201, 792	18-7853-1			105, 292, 902, 977
18-7824-2	Mercury Marine	35-866340Q	201, 792	18-7854	OMC	311684	904
18-7824-2	Mercury Marine	35-866340Q02	201, 792	18-7854	OMC	984491	904
18-7824-2	Mercury Marine	35-866340Q02	201, 792	18-7854	Rochester	17078904	904
18-7824-2	Mercury Marine	35-866340Q03	201, 792	18-7855	Mercury Marine	1397-2150	751
18-7824-2	Mercury Marine	52731A1	201, 792	18-7855	OMC	910139	904
18-7824-2	OMC	173232, 502902	201, 920	18-7855	OMC	983870	904
18-7824-2	OMC	173232, 502902	201, 920	18-7855	Rochester	17068453	904
18-7824-2	Pleasurecraft	R077002	201, 920	18-7856-1	A.C. Delco	GF-61	158
18-7824-2	Volvo	835440	201, 959	18-7857-1	A.C. Delco	GF-61P	158
18-7824-2	Yamaha	YSC-10231-20-0C	201, 665	18-7858	Volvo	858201	153, 688, 979
18-7824-2	Yamaha	YSC-13231-20-0C	1013	18-7859	Mercury Marine	3302-9033	751
18-7824C-2			665	18-7859	Mercury Marine	35-53336	751
18-7826	OMC	305185	292	18-7859	Mercury Marine	35-53336Q	751
18-7828-1			158, 292, 372	18-7859	OMC	908034	905
18-7829	Mercury Marine	35-16494	408, 475, 509	18-7859	Volvo	835576	979
18-7829	Mercury Marine	35-816296	158, 408	18-7860	Chns-Craft	16.83-90006	586
			158, 408	18-7860	Mercury Marine	35-49088	751

1 This product is priced per piece. To order, priced per package, please add -9 to the part number

2 Items ending in "D" are display packaged - regular number is non-display

3 For discount shop pack of 10, please add -10 to the part number

SIERRA #	O.E.M.	O.E. #	PAGE #	SIERRA #	O.E.M.	O.E. #	PAGE #
SIERRA							
18-7860	Mercury Marine	35-49088A2	751	18-7901	Mercury Marine	825467T1	201
18-7860	Mercury Marine	35-49088Q2	751	18-7901	Yamaha	6G8-13440-00-00	201, 535
18-7860	Mercury Marine	F18390006	751	18-7902	Yamaha	3FV-13440-00-00	201, 535
18-7860	OMC	312456	905	18-7902	Yamaha	3FV-13440-20-00	201, 535
18-7860	OMC	381690	905	18-7903	OMC	763364	202, 319
18-7861	OMC	981911	905	18-7903	OMC	5033102	202, 319
18-7862	Crusader	91806	618	18-7903	Suzuki	16510-05240	202, 487
18-7862	OMC	982230	905	18-7905-1	Suzuki	16510-96J00	202, 487
18-7862	Volvo	841162	979	18-7906-1	Mercury Marine	35-8226267	202, 429
18-7865	Yamaha	MAR-MINIF-IL-TR	155, 508	18-7906-1	Mercury Marine	35-822626Q15	202, 429
18-7865			105, 292, 407, 750,	18-7906-1	Mercury Marine	35-822626T7	202, 429
18-7865			904, 978	18-7906-1	Yamaha	69J-13440-00-00	202, 319
18-7866	Yamaha	MAR-FUELF-IL-TR	153, 508, 665	18-7906-1	Yamaha	69J-13440-01-00	202, 319
18-7866			105, 292, 407, 750,	18-7907	Volvo	858488	995
18-7866			904, 978	18-7908	Volvo	3582358	995
18-7869	Mercury Marine	1397-8545	751	18-7909	Honda	15400-PLM-A01PE	202, 267
18-7869	Mercury Marine	1397-8767	751	18-7909	Honda	15400-POH-305	202, 267
18-7871	Mercury Marine	35-805809	200, 690, 808	18-7909	Honda	15400-POH-305PE	202, 267
18-7871	Mercury Marine	35-805809T	808	18-7909	Honda	15400-ZJI-004	202, 267
18-7873	Mercury Marine	35-808275	157, 888, 751	18-7910-1	Westerbeke	30220	200, 691
18-7875	Chris-Craft	16.81-06536	201, 589	18-7910-1	Yanmar	119350-35150	200, 691
18-7875	Chrysler Inboard	56874	201, 597	18-7910-1	Yanmar	119350-35151	200, 691
18-7875	Chrysler Inboard	1851658	201, 597	18-7910-1	Yanmar	124450-35100	200, 691
18-7875	Chrysler Inboard	F724002	201, 597	18-7911-1	Honda	15400-PFB-007	202, 267
18-7875	Crusader	9002514	201, 630	18-7911-1	Nissan/Tohatsu	3R0-07615-0	202, 476
18-7875	Mercury Marine	60565	201, 808	18-7911-1	Yamaha	5GH-13440-00-00	202, 534
18-7875	Mercury Marine	35-802886Q	201, 808	18-7913	Honda	15400-PFB-014	202, 267
18-7875	OMC	173231	201, 920	18-7913	Mercury Marine	35-822626Q03	202, 429
18-7875	OMC	502900	201, 920	18-7913	Mercury Marine	35-822626Q1	202, 429
18-7875	Pleasurecraft	R077001	201, 650	18-7914	Mercury Marine	35-822626K04	202, 429
18-7875	Yamaha	YSC-16231-20-0C	201, 1013	18-7914	Mercury Marine	35-822626Q04	202, 429
18-7876-1			201, 589	18-7914	Mercury Marine	35-822626Q2	202, 429
18-7876-1	Crusader	201104	201, 589	18-7914	Mercury Marine	35-822626T2	202, 429
18-7876-1	Mercury Marine	14957	201, 808	18-7914	Mercury Marine	35-877768K01	202, 429
18-7876-1	Mercury Marine	32716	201, 808	18-7914	Mercury Marine	35-8M0008397	202, 429
18-7876-1	Mercury Marine	32717	201, 808	18-7914	Mercury Marine	35-8M0064104	202, 429
18-7876-1	Mercury Marine	52022	201, 808	18-7915-1	OMC	778865	202, 319
18-7876-1	Mercury Marine	52731	201, 808	18-7915-1	OMC	5031411	202, 319
18-7876-1	Mercury Marine	54111	201, 808	18-7915-1	Suzuki	16510-87J00	202, 487
18-7876-1	Mercury Marine	32-802885Q	201, 808	18-7916	OMC	434839	202, 319
18-7876-1	Mercury Marine	35-866340Q02	201, 808	18-7917	Yanmar	124085-35113	200, 691
18-7876-1	Mercury Marine	35-866340Q03	201, 808	18-7917	Yanmar	124450-35110	200, 691
18-7876-1	Mercury Marine	52731A1	201, 808	18-7917	Yanmar	124550-35110	200, 691
18-7876-1	OMC	173233	201	18-7917	Yanmar	171056-35110	200, 691
18-7876-1	OMC	502901	201	18-7917	Yanmar	171056-35111	200, 691
18-7876-1	Volvo	3850559	201	18-7918	Mercury Marine	35-877769K01	202, 429
18-7876-1	Yamaha	YSC-14231-20-0C	201	18-7918	Mercury Marine	35-883701K01	202, 429
18-7876-1			589, 630	18-7919	Mercury Marine	35-809097	154, 407, 750, 751
18-7878-1	Chrysler Inboard	3549957	201, 597	18-7919	Mercury Marine	35-8M0103095	154, 407, 750, 751
18-7878-1	Chrysler Inboard	L-1008	201, 597	18-7919	Racor	S3213	154, 292, 407, 508, 750, 751, 904, 979
18-7878-1	Chrysler Inboard	L-19	201, 597	18-7919	Yamaha	MAR-24563-00-00	154, 508
18-7878-1	Mercury Marine	38463	201, 808	18-7920	Mercury Marine	35-809099	155, 407, 750
18-7878-1	Mercury Marine	46692	201, 808	18-7920	OMC	771839	155, 904
18-7878-1	Mercury Marine	803470	201, 808	18-7920	Racor	S3214	154, 292, 407, 508, 750, 751, 904, 979
18-7878-1	Mercury Marine	803470Q	201, 808	18-7921	Mercury Marine	35-877767K01	202, 429
18-7878-1	OMC	502904	201, 920	18-7921	Mercury Marine	35-896546T	202, 429
18-7878-1	Volvo	430143	201, 995	18-7922-1	Suzuki	99105-20004-BWL	154, 481
18-7878-1	Volvo	1266286	201, 995	18-7922-1			155, 157, 292, 407, 508
18-7878-1	Volvo	3517857	201, 995	18-7924	Yamaha	MAR-10171-00-10	154, 292, 508, 750, 751, 904, 979
18-7879-1			630, 650	18-7924			154, 292, 407, 750, 904, 979
18-7879-1	Chrysler Force	L-319	201, 597	18-7925	Westerbeke	21235	200, 691
18-7879-1	Mercury Marine	41815	201, 808	18-7925	Volvo	423135	200, 691
18-7879-1	Mercury Marine	32-883702K	201, 808	18-7926	Volvo	4785974	200, 691
18-7879-1	Mercury Marine	32-883702Q	201, 808	18-7926	Volvo	4785974	200, 691
18-7879-1	Mercury Marine	35-802884Q	201, 808	18-7927	Caterpillar	1R-0714	200, 691
18-7879-1	OMC	173834	201, 920	18-7928-1	Racor	B32013	154
18-7879-1	OMC	502903	201, 920	18-7928-1			105, 154, 292, 407, 508
18-7879-1	Volvo	841750	201, 995	18-7929	Mercury Marine	35-809100	154
18-7880	Caterpillar	1R-0658	200, 690	18-7929	Racor	B32020MAM	154
18-7880	Volvo	466634	201, 995	18-7929			105, 154, 292, 407, 508, 750, 904, 979
18-7884	Universal	299381	200, 690	18-7930	OMC	173326	155, 904
18-7884	Volvo	834337	201, 995	18-7931	Detroit Diesel	5574508	157, 688
18-7886	Perkins	2654403	200, 690	18-7932-1			154, 291, 406, 508
18-7888	Volvo	826848	981	18-7934	Cerlist Diesel	1512904	157
18-7888	Volvo	862293	981	18-7935	FRAM	CCS 1136	157, 688
18-7890	Volvo	463505	995	18-7936	Mercury Marine	35-888289T2	407
18-7890	Volvo	876185	995	18-7936	Suzuki	15412-93J00	481
18-7891			215	18-7937-1			154, 291, 406, 508, 508
18-7894			215	18-7938			154, 291, 406, 508, 750, 903, 978
18-7895	OMC	778888	201, 319	18-7941-1			155, 292, 904
18-7895	OMC	5035703	201, 319	18-7942	Volvo	466987	157, 688, 979
18-7895	Suzuki	16510-93J00	201, 487	18-7942	Volvo	3825133	157, 688, 979
18-7896	OMC	778886	201, 319	18-7943			155, 292, 750, 904
18-7896	OMC	5033539	201, 319	18-7944	Mercury Marine	35-52456	153, 407, 750
18-7896	Suzuki	16510-61A20-MHL	201, 487	18-7944	Mercury Marine	35-55501	153, 407, 750
18-7897	OMC	778887	201, 319	18-7944	Mercury Marine	35-57250	153, 407, 750
18-7897	OMC	5033919	201, 319	18-7944	Mercury Marine	35-60494	153, 407, 750
18-7897	Suzuki	16510-62703	201, 487				
18-79007	Volvo	3825036	980				
18-7901	Mercury Marine	825467A1	201, 429				

1 This product is priced per piece. To order, priced per package, please add -9 to the part number

2 Items ending in "D" are display packaged - regular number is non-display

3 For discount shop pack of 10, please add -10 to the part number

SIERRA #	O.E.M.	O.E. #	PAGE #	SIERRA #	O.E.M.	O.E. #	PAGE #	
SIERRA								
18-7944	Mercury Marine	35-604941	153, 407, 750	18-79820-1			223	
18-7944	Mercury Marine	35-802893Q	153, 407, 750	18-7982-1		153, 291, 406, 507, 749, 903, 977		
18-7944	Mercury Marine	35-805369	153, 407, 750	18-7982-2		153, 291, 406, 507, 749, 903, 977		
18-7944	Mercury Marine	35-8053691	153, 407, 750	18-79823			223	
18-7944	Mercury Marine	35-806771	153, 407, 750	18-79825			223	
18-7944	Mercury Marine	35-807172	153, 407, 750	18-7983-1	Mercury Marine	35-52456A1	153, 153, 405, 749	
18-7944		105, 153, 154, 291, 292, 406, 407, 507, 508, 749, 750, 751, 903, 903, 904, 977, 978		18-7983-1	Mercury Marine	35-55501A1	153, 153, 405, 749	
18-7945	Mercury Marine	35-52456	153, 407, 750	18-7983-1	Mercury Marine	35-57250A1	153, 153, 405, 749	
18-7945	Mercury Marine	35-55501	153, 407, 750	18-7983-1	Mercury Marine	35-60494A1	153, 153, 405, 749	
18-7945	Mercury Marine	35-57250	153, 407, 750	18-7983-1	Mercury Marine	35-60494A4	153, 153, 405, 749	
18-7945	Mercury Marine	35-60494	153, 407, 750	18-7983-1	Mercury Marine	35-802893A4	153, 153, 405, 749	
18-7945	Mercury Marine	35-604941	153, 407, 750	18-7983-1	Mercury Marine	35-802893Q4	153, 153, 405, 749	
18-7945	Mercury Marine	35-802893Q	153, 407, 750	18-7983-1	Mercury Marine	35-807172A4	153, 153, 405, 749	
18-7945	Mercury Marine	35-805369	153, 407, 750	18-7983-1		153, 291, 406, 507, 749, 903, 977		
18-7945	Mercury Marine	35-8053691	153, 407, 750	18-7983-2		153, 291, 406, 507, 749, 903, 977		
18-7945	Mercury Marine	35-8053691	153, 407, 750	18-79833-1	Mercury		223	
18-7945	Mercury Marine	35-806771	153, 407, 750	18-79834	OMC		223	
18-7945	Mercury Marine	35-807172	153, 407, 750	18-7984-1	Yamaha	MAR-SPRTR-HD-SS	153, 507	
18-7945	Yamaha	ABB-FUELF-IL-TR	153, 508, 665	18-7984-1		153, 291, 406, 507, 749, 903, 977		
18-7945		105, 292, 407, 750, 904, 978, 665		18-7985-1		153, 291, 406, 507, 749, 903, 977		
18-7945C				18-7986-1		153, 291, 406, 507, 749, 903, 977		
18-7946	OMC	502905	155, 292, 904, 978	18-7987	Racor	RK10222	157	
18-7946			155, 292, 904, 978	18-7987	Suzuki	99105-20006-BWL	157, 481	
18-7947	Honda	17670-ZW1-030GH	157, 260	18-7988			155, 155, 157	
18-7947	Racor	S3240	157, 260, 481, 508, 750, 904, 979	18-7989	OMC	502906	155, 292, 904, 978	
18-7947	Suzuki	99105-20006	157, 481	18-7989	Volvo	3852413	155, 292, 904, 978	
18-7948	Honda	17670-ZW1-801AH	157, 260	18-7989	Volvo	3862228	155, 292, 904, 978	
18-7948	Mercury Marine	35-886638	157, 407, 750	18-7989	Volvo	3851218-2	155, 292, 904, 978	
18-7948	Racor	S3227	157, 260, 481, 508, 750, 904, 979	18-79900	Yamaha	66K-13915-00-00	510, 511	
18-7948	Suzuki	99105-20005	157, 481	18-79901	Mer cruiser	65L-13915-00-00	510, 751	
18-7949	Racor	S3232	157, 260, 481, 508, 750, 904, 979	18-79901	Yamaha	65L-13915-00-00	510, 751	
18-7950	Chrysler Force	25-45258	255, 257, 430, 460, 154, 291, 406, 508, 750, 903, 978	18-79902	Yamaha	63P-13915-00-00	511	
18-7951				18-79903	Yamaha	68V-13915-00-00	511	
1	18-7952	Chrysler Force	25-88657	255, 257	18-79904	Yamaha	68F-13915-00-00	511
18-7953	OMC	5035974	292, 481	18-79905	Yamaha	69J-24501-10-00	509, 511	
18-7953	Suzuki	15410-87J30	481	18-79906			155	
18-7954	Yamaha	N26-13440-00-00	202, 534, 535	18-79907	Yamaha	60V-24251-01-00	510	
18-7954	Yamaha	N26-13440-02-00	202, 534, 535	18-79908	Honda	16911-ZY3-010	261	
18-7955	Yamaha	68F-24563-10-00	509	18-79909	Honda	16901-ZY3-003	261	
1	18-7956	Chrysler Force	25-85549	257	18-79910	Yamaha	61N-24560-10	511
1	18-7956	Mercury Marine	25-85549	257	18-79911	Mercury	35-8M0079962	153, 407, 750
18-7958	Crusader	47047	618	18-79912	Mercury	35-8M0082290	153	
18-7961	Mercury Marine	25-47254	467, 877	18-79912			153, 406, 749	
18-7961	Mercury Marine	25-861844	467, 877	18-7994-1			157, 407	
18-7961	Mercury Marine	785-97386	877	18-79950	Yamaha		511	
18-7962	Volvo Penta	3840525	996	18-79951	Yamaha		511	
18-7963	OMC	331353	333	18-79952	Yamaha		511	
18-7964-1	Mercury Marine	879194241	751	18-79953	Yamaha		511	
18-7964-1	Mercury Marine	35-813405	751	18-79954	Yamaha		511	
18-7964-1	Mercury Marine	35-813405A1	751	18-79955	Yamaha		511	
18-7964-1	Mercury Marine	35-815419	751	18-79956	Yamaha		511	
18-7964-1	Mercury Marine	FFF001138	751	18-79957	Yamaha		511	
18-7964-1	Mercury Marine	FI9608751	751	18-79960	Yanmar	104500-55710	157, 688	
18-7964-1		586, 596, 618,		18-79961	Yamaha	6H1-13411-00	534	
18-7965-1	Yamaha	MAR-MINIF-LT-AS	155, 508	18-79961	Mercury Marine	35-853333	408	
18-7965-1			291, 406, 750	18-7997	Mercury Marine	35-853333T	408	
18-7966-1	Yamaha	MAR-SEPAR-AT-OR	155, 507	18-79970	Yamaha	6BG-13915-00	509	
18-7966-1			291, 406, 749	18-79971	Yamaha	68F-13440-00	534	
18-7967	Mercury Marine	35-14571A1	153, 407	18-79972	Yamaha	67F-14371-01	509	
18-7967	Mercury Marine	35-17808A1	153, 407	18-79973	Yamaha	6C5-13915-00	509, 511	
18-7967	Mercury Marine	35-18458A2	153, 407	18-79974	Yamaha	6J8-13411-00	534	
18-7967	Mercury Marine	35-18458A3	153, 407	18-79975	Yamaha	6E5-13411-00	534	
18-7967	Mercury Marine	35-18458Q3	153, 407	18-79976	Yamaha	61A-13411-00	534	
18-7968	Mercury Marine	35-184585	153, 407	18-79977	Yamaha	6LS-24251-00	510	
18-7968	Mercury Marine	35-18458Q4	153, 407	18-79978	Yamaha	6CB-13915-00	511	
18-7969		157, 407, 750		18-79979	Yamaha	6CB-24501-00	510	
18-7970	Cerlist Diesel	1512903	157	18-79980	Yamaha	68F-24563-00	510	
18-7974	Volvo	3827069	202, 996	18-79981	Yamaha	69J-24501-00	510	
18-7976	Indmar	S556003	Obsolete	18-79982	Yamaha	69J-24502-00	510	
18-7976	Pleasurecraft	9-37824	Obsolete	18-79983	Yamaha	6C5-24251-00	510	
18-7976	Crusader	23250	Obsolete	18-79984	Yamaha	6AW-24502-00-00	510	
18-7977	Mercury Marine	35-866171A01	751	18-79984	Yamaha	6AW-24502-10	510	
18-79781	OMC	433190	292	18-79985	Yamaha	68V-24502-20-00	510	
18-7979	Mercury Marine	881540	407	18-79985	Yamaha	68V-24502-30	510	
18-7979	Yamaha	68V-24563-00-00	509	18-79986	Yamaha	68V-24502-00-00	510	
18-79799	Yamaha	6D8-WS24A-00-00	509	18-79986	Yamaha	68V-24502-01-00	510	
18-79809	Yamaha	6P3-WS24A-00-00	509	18-79986	Yamaha	68V-24502-02	510	
18-7981	Mercury Marine	35-884380T	407	18-79987			70, 220	
18-7981	Mercury Marine	35-8M0020349	407	18-79988			70, 220	
18-79813			223	18-79989	Universal	257, 268, 355, 372, 458, 477, 488, 552		
18-79814	Mercury	91-896661	223	18-7999	Mercury Marine	35-896247	408	
18-79815	Yamaha	YB-ACC04	223	18-79994N	Mercury	3310-866142A03	733	
18-79816	Mercury	91-879172T28	216	18-79994N	Mercury	3310-866142A04	733	
18-79816-24			216	18-79995N	Mercury	3310-866143A03	Obsolete	
18-79817			223	18-79998	Volvo	R80316	974	

1 This product is priced per piece. To order, priced per package, please add -9 to the part number

2 Items ending in "D" are display packaged - regular number is non-display

3 For discount shop pack of 10, please add -10 to the part number

SIERRA #	O.E.M.	O.E. #	PAGE #	SIERRA #	O.E.M.	O.E. #	PAGE #	
SIERRA								
3	18-80008	Volvo	R7044289		18-8055	Mercury Marine	22-63187	163, 403
	18-8002EP-1			105, 158, 247, 260, 372, 403, 475, 482, 512	18-8055	OMC	173311	163, 293, 905
	18-8002S				18-8055	Yamaha	ABA-FLINE-BA-RB	512
	18-8003-1	Volvo	8692305		18-8055			104, 512
	18-8004-10EP-1			202, 996	3	18-8056	OMC	174508
				140, 275, 464	3	18-8056	OMC	775640
3	18-8004EP-1	Mercury Marine	89396A38	158, 293, 482	18-8062	Chrysler Force	197787-3	247
3	18-8004EP-1	Mercury Marine	89396Q38	158, 164, 403	18-8062	Suzuki	65750-98505	482
3	18-8004EP-1	OMC	174511	158, 293	3	18-8063	OMC	502867
3	18-8004EP-1			105, 247, 260, 293	3	18-8063	OMC	772681
				403, 475, 482, 512	3	18-8063	OMC	772681
	18-8004S	Mercury Marine	89396A38	158, 164, 403	18-8067			163
	18-8004S	Mercury Marine	89396Q38	158, 164, 403	18-8068			404
	18-8004S	OMC	174511	158, 164, 166	18-8069	Mercury Marine	22831A1	404
3	18-8005-10EP-1			140, 275, 158, 293	18-8069	Mercury Marine	22831A3	404
3	18-8005EP-1	Mercury Marine	13330A3	158, 164, 403	18-8069	Mercury Marine	22831A4	404
3	18-8005EP-1	OMC	174512	158, 293	18-8069	Mercury Marine	22831B3	404
	18-8005EP-1			158, 293	18-8069	Mercury Marine	22831Q3	404
	18-8005S	Mercury Marine	13330A3	158, 164, 403	18-8070	Mercury Marine	29196	404
	18-8005S	Mercury Marine	13330Q	158, 164, 403	18-8070	Mercury Marine	16610M	404
	18-8005S	OMC	174512	154	18-8070	Mercury Marine	30185A1	404
	18-8009EP-2	OMC	398549	160, 293	18-8070	Mercury Marine	30185A3	404
	18-8009S-1	OMC	398549	165	18-8070	Mercury Marine	30185B3	404
	18-8010EP-2			160, 402	18-8070	Mercury Marine	30185Q3	404
	18-8011EP-2	Chrysler Force	FS409752	159, 247	18-8071	Suzuki	99105-00192	482
	18-8012EP-2	Mercury Marine	32-858114K08	160, 402	18-8071			247
	18-8012EP-2	Mercury Marine	32-858114Q08	160, 402	18-8072	OMC	174177	293, 905
	18-8013EP-2			162, 372	18-8073			104, 160, 403
	18-8013S-1			166	18-8074	OMC	173312	163, 293, 905
	18-8014EP-2	OMC	174509	160, 293	18-8074			104, 403
	18-8014S-1	OMC	174509	165	18-8075	Mercury Marine	22-14213M	404
	18-8015EP-2			162, 372	18-8075	Mercury Marine	22-14213Q	404
	18-8015S-1			166	18-8075	Mercury Marine	22-81042M	404
	18-8016EP-2	Mercury Marine	32-858109K12	161, 403	3	18-8076	Mercury Marine	22-13563A3
	18-8016EP-2	Mercury Marine	32-858109Q12	161, 403	3	18-8076	Mercury Marine	22-13563Q3
	18-8016S-1	Mercury Marine	32-858109K12	165	3	18-8077-1		404, 512
	18-8017EP-2	Yamaha	6YL-24306-60-00	162, 165, 512	18-8078	Suzuki	65740-95500	482
	18-8017S-1	Yamaha	6YL-24306-60-00	166, 512	18-8078	Suzuki	99105-00193	482
1	18-8020	Mercury Marine	54-41582-7	163	18-8078			475
1	18-8020	OMC	322652	294, 905	18-8079	Nissan/Tohatsu	3B2702810M	475
1	18-8020	Volvo	3852170	981	18-8079	Nissan/Tohatsu	65750-95500	475
1	18-8020			475	18-8079	Suzuki	65750-95500	482
1	18-8021	OMC	911616	163, 294, 905	18-8079	Suzuki	65750-95510	482
1	18-8021	Volvo	3852529	981	18-8082			404
1	18-8021			475	18-8083			404
	18-8024EP-2	Mercury Marine	32-858104K08	161, 402	18-8084	Mercury Marine	29196	404
	18-8024EP-2	Mercury Marine	32-858104Q08	161, 402	18-8084	Mercury Marine	22-16610M	404
	18-8025EP-2	Mercury Marine	32-858105K08	161, 403	18-8084	Mercury Marine	30185A1	404
	18-8025EP-2	Mercury Marine	32-858105Q08	161, 403	18-8084	Mercury Marine	30185A3	404
	18-8032EP-2			162, 372	18-8084	Mercury Marine	30185B3	404
	18-8032S-1			166	18-8084	Mercury Marine	30185Q3	404
1	18-8034	OMC	329654	163, 294, 905, 981	3	18-8085		404
1	18-8034	Volvo		981	18-8087	Suzuki	65720-94411	482
	18-8040	Yamaha	ABA-FBARB-90-DG	512	18-8088	Nissan/Tohatsu	3B2702501M	475
	18-80400	Honda	16977-ZV5-A00	260	18-8089	Nissan/Tohatsu	3B2-70260-0	475
	18-80401			260	18-8090			482
	18-80402			404	18-8091	Mercury Marine	22-13563A6	404
	18-80403			260	18-8091	Mercury Marine	22-13563A7	404
	18-80404			482	18-8091	Mercury Marine	22-13563Q7	404
	18-80405			482	18-8091	Mercury Marine	22-13563T7	404
	18-80406	Honda	16977-ZV5-900	260	18-8092	OMC	176445	293
	18-80407	Honda	17710-ZW9-033	260	18-8092	OMC	775641	163
	18-80408	Honda	17650-ZW9-003	260	18-8093			163
	18-80409	Suzuki	65720-94401	482	18-8094			163
	18-8041			104, 163	18-8095			218
	18-80410-1	Mercury Marine	22-13563T3	404	18-81006	OMC		
	18-80410-1	Nissan/Tohatsu	3GR702500M	404, 475	18-81042EP-2	Honda	17700-ZW9-010	159, 260
	18-80412	Mercury Marine	22-816856T2	404	18-81042EP-2	Honda	17700-ZW9-020	159, 260
	18-80413	Yamaha	6Y1-24305-04	513	18-8108			104, 163
	18-80414	Yamaha	6G1-24305-04	513	18-8109			163
	18-80414	Yamaha	6G1-24305-05-00	513	18-8110			163
	18-80415	Yamaha	6E5-24305-05	513	18-81100			Obsolete
	18-80415	Yamaha	6Y2-24305-05	513	18-81101			Obsolete
	18-80418	Suzuki	65750-94404	482	18-81103			218
	18-80419	Suzuki	65750-87J10	482	1	18-8111	Mercury Marine	22-36392
	18-80419	Suzuki	65750-87J11	482	18-8112	Crusader	97854	798
	18-8042			104, 163	18-8114			621, 622, 624, 627
	18-80420	Honda	17650-921-003ZB	260	18-8115			172, 585, 596, 617, 633,
	18-80425	Suzuki	65720-988B0	482				653, 665, 737, 901, 975
	18-8043			104, 163				172, 585, 596, 617, 633,
	18-8045			163	18-8124	Volvo	829913	653, 665, 737, 901, 975
	18-8046			163	18-8125	Volvo	3583443	157, 688, 979
	18-8047			163	18-8126	Volvo	861477	157, 688, 979
	18-8048			164, 293	18-8127	Pleasurecraft	RP080026	646
	18-8050			164, 293	18-8149	Volvo	3847644	155, 979
	18-8051	OMC	322656	164, 293	18-8150			163
	18-8052	OMC	122838	164, 293	18-8150-10			163
	18-8054	Mercury Marine	22-63186	163, 403	18-8151			163
	18-8054			104	18-8151-10			163

1 This product is priced per piece. To order, priced per package, please add -9 to the part number
 2 Items ending in "D" are display packaged - regular number is non-display
 3 For discount shop pack of 10, please add -10 to the part number

SIERRA #	O.E.M.	O.E. #	PAGE #	SIERRA #	O.E.M.	O.E. #	PAGE #
SIERRA							
18-8152			163	18-8377			Obsolete
18-8152-10			163	18-8378			490
18-8200	OMC	322653	163, 294, 905	18-8380	Suzuki	25700-93J00	488
18-8200	Volvo	3852171	981	18-8381	Suzuki	25700-99E00	488
18-8201	OMC	124249	163, 294, 905	18-8382	Mercury Marine	26-816575A4	462
18-8202	OMC	322654	163, 294, 905	18-8383	OMC	5000309	364
18-8202	Volvo	3852172	981	18-8384	OMC	5006373	364
18-8203	OMC	329653	163, 294, 905	18-8385	Suzuki	25700-95J00	490
18-8203	Volvo	329653	981	18-8386	Suzuki	25700-98J00	490
18-8204	OMC	324825	163, 294, 905	18-8387	BRP	5007987	364
18-8204	Volvo	324825	981	18-8400-9	Yamaha	90119-08M15-00	519
18-8205	Mercury Marine	30-803098T1	851	18-8402	Mercury Marine	10-8053432	718
18-8206-1	Mercury Marine	30-803099T1	851	18-8402-1	Mercury Marine	10-8053432	718
18-8208	Mercury Marine	31-803090T1	873	18-8404-1	Mercury Marine	10-8083434	718
18-8212-1	Mercury Marine	30-803100T1	851	18-8406	Yamaha	97595-06535	523
18-8212-1	Mercury Marine	8M0095485	851	18-8407	Yamaha	97595-06540	523
18-8213	Mercuriser	30-803097T1	852	18-8410	Mercury Marine	10-43749	798
18-8215			606, 634, 650	18-8411	Mercury Marine	10-44387	798
18-8216	Mercury Marine	22-36305	793	18-8412			717, 893
18-8216	Mercury Marine	22-36305T	801	18-8500			778
18-8216			606, 916	18-8501	Barr	CM-20-9234 P	Obsolete
18-8217	Mercuriser	30-803098T1	852	18-8502			917
18-8218	Mercuriser	30-803099T1	852	18-8503			648
18-8219	Mercuriser	30-803100T1	852	18-8504			648
18-8220	Mercury Marine	88-79023A91	722	18-8505			798
18-8226	Honda	16910-ZV4-015	260	18-8506	Barr	CM-20-6674JP	606
18-8227	Mercury Marine	73873	809	18-8507	Barr	CM-20-6674JP	606, 917, 989
18-8227	Mercury Marine	73873A1	809	18-8508			Obsolete
18-8297	Mercury Marine	861578	809	18-8510			989
18-8298	Honda	91252-935-004	266	18-8511			989
18-8299	Honda	91356-ZY3-003	266	18-8512			778
18-8300	OMC	341280	365	18-8514			778
18-8301	OMC	341281	365	18-8515			627
18-8304	OMC	321830	349, 365	18-8516			588
18-8305	Mercury Marine	42838	431	18-8518	Barr	CM-20-9232P	606
18-8305	Mercury Marine	69668	431	18-8519			627
18-8305	Mercury Marine	88726	431	18-8520			798
18-8305	Mercury Marine	428381	431	18-8521			627
18-8305	Mercury Marine	26-814754	431	18-8523			628
18-8307	OMC	331103	365	18-8524			628
18-8308	Mercury Marine	26-30696	460, 464	18-8526			606
18-8309	Mercury Marine	18717	443	18-8527	Barr	CM-1-6677SS P	606
18-8310	Mercury Marine	26-30900	460, 464	18-8529			799
18-8311			849	18-8530			799
18-8312			849	18-8531			799
18-8313			849	18-8532			799
18-8325	OMC	342786	341, 365	18-8533			799
18-8326	OMC	342787	341, 365	18-8534			917
18-8331	Suzuki	09168-10022	488	18-8535			588, 606, 628, 636, 648,
18-8334	Suzuki	25223-94400	488				661, 799, 917,
18-8335	Suzuki	25700-87D00	489	18-8536	Marine Power	0994-000	636
18-8337	OMC	5031456	364	18-8536			588, 606, 628, 636, 648,
18-8337	Suzuki	25700-94400	489				661, 799, 917,
18-8338	Suzuki	25700-94500	489	18-8538			588, 606, 628, 636, 648,
18-8339	Suzuki	25700-94700	489				661, 799, 917,
18-8340	Suzuki	25700-95500	489	18-8539			989
18-8341	Suzuki	25700-95D00	489	18-8547			628
18-8345	Suzuki	09289-22007	489	18-8548			799
18-8347	Chrysler Force	26-76384	257	18-8549			799
18-8347	Chrysler Force	26-816464	257	18-8551			799
18-8347	Chrysler Force	26-8164641	257	18-8553			917
18-8347	Mercury Marine	26-76384	464	18-8554			799
18-8347	Mercury Marine	26-816464	464	18-8555			799
18-8347	Mercury Marine	26-8164641	464	18-8556			799
18-8349	OMC	911795	365	18-8600			217
18-8349	OMC	3852548	949	18-8601			217
18-8350	OMC	328603	365	18-8602			217
18-8351	OMC	308500	365	18-8603			217
18-8351	OMC	321504	365	18-8604			217
18-8352	OMC	332253	327	18-8605			217
18-8353	OMC	320961	333	18-8606	Mercury	92-8M0062765	217
18-8354	Chrysler Force	26-828627	257	18-8607			217
18-8355			318	18-8608			217
18-8357	Volvo	875741	1011	18-8609			217
18-8358	Volvo	876267	1011	18-8610			217
18-8359	Volvo	876268	1011	18-8611			227
18-8360			944	18-8612			227
18-8361	Volvo	576266-8	1011	18-8613	Universal	88-831	227
18-8362-1			268	18-8614			227
18-8363			268	18-8615			227
18-8365			268	18-8616			227
18-8366			268	18-8617			227
18-8367	OMC	334950	365	18-8623	Indmar	501022S	Obsolete
18-8368	Volvo	813967	1007	18-8700	Yamaha	1WD-E3440-00-00	202, 535
18-8369	OMC	914488	929, 931	18-8700	Yamaha	2MB-E3440-00-00	202, 535
18-8370			873	18-8700	Yamaha	5GH-13440-20	202, 535
18-8372	OMC	323582	333	18-8700	Yamaha	5GH-13440-50-00	202, 535
18-8373	Suzuki	25700-90J01	489	18-8700	Yamaha	5JW-13400-00-00	202, 535
18-8374	Suzuki	25700-92J00	489	18-8701	Volvo Penta	861476	996
18-8375			490	18-8702	Volvo Penta	30788490	996

1 This product is priced per piece. To order, priced per package, please add -9 to the part number

2 Items ending in "D" are display packaged - regular number is non-display

3 For discount shop pack of 10, please add -10 to the part number

SIERRA #	O.E.M.	O.E. #	PAGE #	SIERRA #	O.E.M.	O.E. #	PAGE #
18-8779	Indmar	872025	201, 634	18-8834-1	Mercury Marine	84-816608Q83	190-199,711
18-8800-1	Mercury Marine	84-43376A7	190-199,711	18-8835-1	Mercury Marine	84-816608Q82	190-199,711
18-8800-1	Mercury Marine	84-813720A5	190-199,711	18-8836-1	Mercury Marine	84-816608A71	190-199,711
18-8800-1	Mercury Marine	84-816761A7	190-199,711	18-8836-1	Mercury Marine	84-816608Q71	190-199,711
18-8800-1	Mercury Marine	84-816761Q5	190-199,711	18-8837-1	Mercury Marine	84-847701A7	190-199,711
18-8800-1	OMC	503748	190-199, 890	18-8837-1	Mercury Marine	84-847701Q7	190-199,711
18-8800-1			580-635	18-8838-1	Mercury Marine	84-881698	190-199,711
18-8801-1	Mercury Marine	84-813720A7	190-199,711	18-8838-1			191, 192-194, 197, 580,
18-8801-1	Mercury Marine	84-816761Q7	190-199,711				962, 965, 966
18-8801-1	OMC	503750	190-199, 890	18-8839-1			189, 276
18-8801-1	Volvo	876532-3	190-199, 962	18-8840-1			189, 276
18-8802-1	Mercury Marine	84-43376A12	190-199,711	18-8841-1	OMC	503749	190, 967
18-8802-1	Mercury Marine	84-813720A12	190-199,711	18-8842-1	OMC	503753	190-199, 890
18-8802-1	Mercury Marine	84-816761A12	190-199,711	18-8843-1	OMC	503756	190-199, 890
18-8802-1	Mercury Marine	84-816761Q12	190-199,711	18-8844-1	Crusader		190
18-8802-1	OMC	503752	190-199, 890	18-8847-1	Yamaha	67F-82341-00-00 +	492
18-8802-1	OMC	503755	190-199, 890	18-8847-1	Yamaha	67F-82342-00-00 +	492
18-8802-1	Volvo	8757166	190-199, 962	18-8847-1	Yamaha	67F-82343-00-00 +	492
18-8803-2	Mercury Marine	84-43376A9	190-199,711	18-8847-1	Yamaha	67F-82344-00-00	492
18-8803-2	Mercury Marine	84-813720A10	190-199,711	18-8860	Mercury Marine	861677T	743
18-8803-2	Mercury Marine	84-813720A9	190-199,711	18-8861	Mercury Marine	861156A02	Obsolete
18-8803-2	Mercury Marine	84-816761A9	190-199,711	18-8862	Mercury Marine	861156A03	Obsolete
18-8803-2	Mercury Marine	84-816761Q10	190-199,711	18-8864	Mercury Marine	866169A01	742
18-8803-2	Mercury Marine	84-816761Q9	190-199,711	18-8864	Mercury Marine	866169T01	742
18-8803-2	OMC	503752	190-199, 890	18-8865	Mercury Marine	866170A01	742
18-8803-2	OMC	503755	190-199, 890	18-8866	Mercury Marine	892874T01	400
18-8803-2			190-199,711	18-8866	Mercury Marine	899106T01	400
18-8804-1	Mercury Marine	84-813720A2	190-199,711	18-8867	Mercury Marine	805025A2	Obsolete
18-8804-1	Mercury Marine	84-813720A3	190-199,711	18-8867	Mercury Marine	805656A2	Obsolete
18-8804-1	Mercury Marine	84-813720A4	190-199,711	18-8867	Mercury Marine	805656A5	Obsolete
18-8804-1	Mercury Marine	84-816608Q61	190-199,711	18-8867	Mercury Marine	805656A6	Obsolete
18-8804-1	Mercury Marine	84-816761A4	190-199,711	18-8867	Mercury Marine	861155A5	Obsolete
18-8804-1	Mercury Marine	84-816761Q3	190-199,711	18-8867	Mercury Marine	861155A6	Obsolete
18-8804-1	Mercury Marine	84-816761Q4	190-199,711	18-8868	Mercury Marine	861155A2	Obsolete
18-8805-1			190	18-8868	Mercury Marine	861155A3	Obsolete
18-8806-1			190-199	18-8870	Suzuki	16510-45H10	487
18-8807-1	OMC	503747	190-199, 890	18-8880	BRP	420956741	570
18-8808-2	Mercury Marine	84-813720A6	190-199,711	18-8898			662
18-8808-2	Mercury Marine	84-816761Q6	190-199,711	18-8899			662
18-8809-1	Mercury Marine	84-43376A8	190-199,711	18-8900	Chrysler Force	47-19453	248, 411
18-8809-1	Mercury Marine	84-813720A8	190-199,711	18-8900	Mercury Marine	47-19453	248, 411
18-8809-1	Mercury Marine	84-816761A8	190-199,711	18-8901	Chrysler Force	47-F462065	248
18-8809-1	Mercury Marine	84-816761Q8	190-199,711	18-8903	Chrysler Force	47-F436065-2	248
18-8810-1	Mercury Marine	84-813720A11	190-199,711	18-8904	OMC	5031417	295
18-8810-1	Mercury Marine	84-816761Q16	190-199,711	18-8905	OMC	5008968	294
18-8810-1	OMC	503751	190-199, 890	18-8906	OMC	436137	295
18-8811-1	Mercury Marine	84-813720A13	190-199,711	18-8907	OMC	5033542	295
18-8811-1	Mercury Marine	84-816761Q13	190-199,711	18-8910	Yamaha	68T-44352-00-00	514, 519
18-8811-1	OMC	503749	190-199, 890	18-8911	Yamaha	6L5-44352-00-00	514
18-8811-1			190-199,711	18-8920	Nissan/Tohatsu	3B2650211M	476
18-8813-1	Volvo	875571	190-199, 962	18-8921	Nissan/Tohatsu	334650210M	476
18-8814-1	OMC	503749	190	18-8922	Nissan/Tohatsu	3C8650212M	476
18-8815-1	OMC	582365	189, 276	18-8923	Nissan/Tohatsu	346560210M	476
18-8816-1	OMC	582365	189, 276	18-8924	Nissan/Tohatsu	3B7650212M	476
18-8817-1			190, 191, 191, 580, 580	18-8924	Nissan/Tohatsu	3C7650211M	476
18-8818-1	OMC	582365	189, 276	18-8925	Yamaha	GAW-44352-00-00	514
18-8819-1			189, 241, 380	18-8926	Crusader	RF061022	618
18-8820-1	OMC	503754	190-199, 890	18-8950	Yanmar	124223-42092	689
18-8820-1			190-199	18-8951	Yanmar	128176-42071	689
18-8821-1	Mercury Marine	84-813720A3	190-199,711	18-8952	Yanmar	104211-42071	689
18-8821-1	Mercury Marine	84-813720A4	190-199,711	18-8953			153, 508
18-8821-1	Mercury Marine	84-816761A17	190-199,711	18-8954			153, 508
18-8821-1	Mercury Marine	84-816761A4	190-199,711	18-8955			153, 407, 751
18-8821-1	Mercury Marine	84-816761Q17	190-199,711	18-8956	Mercury	22-8M0001721	400
18-8821-1	Mercury Marine	84-816761Q3	190-199,711	18-8957	Mercury	22-818994	400
18-8821-1	Mercury Marine	84-816761Q4	190-199,711	18-8957	Mercury	22-8189941	400
18-8822-1	Mercury Marine	84-816608A81	190-199,711	18-8958	Mercury	22-424254	400
18-8822-1	Mercury Marine	84-816608Q81	190-199,711	18-8960			229
18-8823-1	OMC	503752	190-199, 890	18-8962	GM		669
18-8823-1	OMC	503755	190-199, 890	18-8963	GM		669
18-8823-1	Volvo	8757166	190-199, 962	18-8964	Volvo	3853804	995
18-8823-1			191, 192-194, 197, 580,	18-8997			220
			962, 965, 966	18-8998-1			220
18-8824-1	Mercury Marine	84-816608Q78	191, 192-194,	18-8999			220
			197, 580, 962, 965, 966	18-9009			220
18-8824-1			191, 192-194, 197, 580,	18-9010			220, 458, 867
			962, 965, 966	18-9013	Mercury Marine	92-78383A12	216
18-8825-1			190	18-9013	Mercury Marine	92-817529A12	216
18-8826-1			190-199, 591	18-9013	OMC	174275	216
18-8827-1			190-199, 591	18-9013	OMC	175068	216
18-8828-1	Mercury Marine	84-863656A1	190-199,711	18-9013	OMC	175613	216
18-8829-1	Mercury Marine	84-863656A2	190-199,711	18-9024	Mercury Marine	92-78383A12	216
18-8830-1	Mercury Marine	84-816608Q80	190-199,711	18-9024	Mercury Marine	92-817529A12	216
18-8832-1	Mercury Marine	84-816608A68	190-199,711	18-9024	OMC	174275	216
18-8832-1	Mercury Marine	84-816608K68	190-199,711	18-9024	OMC	175068	216
18-8832-1	Mercury Marine	84-816608Q68	190-199,711	18-9024	OMC	175613	216
18-8833-1	Mercury Marine	84-816608A14	190-199,711	18-9065	Mercury Marine	92-78383A12	216
18-8833-1	Mercury Marine	84-816608Q14	190-199,711	18-9065	Mercury Marine	92-817529A12	216
18-8833-1	Mercury Marine	84-816761K14	190-199,711	18-9065	OMC	174275	216
18-8834-1	Mercury Marine	84-816608A83	190-199,711	18-9065	OMC	175068	216

1 This product is priced per piece. To order, priced per package, please add -9 to the part number
 2 Items ending in "D" are display packaged - regular number is non-display
 3 For discount shop pack of 10, please add -10 to the part number

SIERRA #	O.E.M.	O.E. #	PAGE #	SIERRA #	O.E.M.	O.E. #	PAGE #
SIERRA							
18-9065	OMC	775613	216	18-9218	Mercury Marine	814819A2	848
18-9066			219	18-9219	OMC	335677	352
18-9067			219	18-9240-0	Mercury	92-802859A1	215, 858
18-9075	Mercury Marine	23-888690	458	18-9240-1	Mercury	92-802863A1	215, 858
18-9075	Yamaha	61A-45538-00-00	515	18-9320			213
18-9076	Mercury Marine	23-888690-1	458	18-9350			213
18-9076	Yamaha	61A-45527-00-00	515	18-9360			Obsolete
18-9077	Mercury Marine	13-888363-2	458	18-9390	Yamaha	LUB-MRNSM-KT-10	215, 535
18-9077	Yamaha	90206-22M19	515	18-9391	Yamaha	LUB-MRNMD-KT-10	215, 535
18-9078	Mercury Marine	12-855682-2	458	18-9392	Yamaha	LUB-MRNMR-KT-10	216, 535
18-9078	Yamaha	90201-22M01	515	18-9393	Yamaha	LUB-MRNLG-KT-10	216, 535
18-9079	Yamaha	61A-45538-00-00 +	515	18-9400-2	Mercury Marine	92-802837Q1	206
18-9079	Yamaha	61A-45527-00-00 +	515	18-9400-2P	Mercuriser	92-802837Q1	206
18-9079	Yamaha	90206-22M19 +	515	18-9400-30			206
18-9079	Yamaha	90201-22M01	515	18-9400-30P			206
18-9080	Mercury Marine	92-78383A12	216	18-9400-4	Mercury Marine	92-857389A1	206
18-9080	Mercury Marine	92-817529A12	216	18-9400-4P	Mercuriser	92-857389A1	206
18-9080	OMC	174275	216	18-9400-7	Mercury Marine	92-802841A1	206
18-9080	OMC	175068	216	18-9400-7P	Mercuriser	92-802841A1	206
18-9080	OMC	775613	216	18-9400CAT-2	Mercury Marine	92-8M0078627	209
18-9081	Yamaha	6E5-44312-00-00	515	18-9400CAT-2P			92-8M0078627
18-9082	Yamaha	6AW-44312-00-00	515	209	18-9400CAT-4	Mercury Marine	209
18-9083	Yamaha	63D-44312-00	515	18-9400CAT-4P			Mercury Marine
18-9084	Johnson/Evinrude	354578	302	209	18-9400CAT-7	Mercury Marine	92-8M0078621
18-9089	Yamaha	6EG-G4328-00	523	18-9400CAT-7P			Mercury Marine
18-9090	Yamaha	63V-44328-01	522	209	18-9410-2	Volvo	3842343
18-9091	Yamaha	69M-G4328-00	523	18-9410-4	Volvo	3842344	207
18-9092	Yamaha	6L2-44328-00	523	18-9410-7	Volvo	3858061	207
18-9093			108, 217	18-9420-2	Mercury Marine	92-802833Q1	206
18-9095			108, 217	18-9420-2P	Mercury	92-802833Q1	206
18-9096	Volvo	3847547	1006	18-9420-3	Mercury Marine	92-802835Q1	206
18-9098	OMC	174448	943	18-9420-3P	Mercury	92-802835Q1	206
18-9098	Volvo	174448	1006	18-9420-30	Mercury	92-802835Q1	206
18-9099	Mercury Marine	86459	868	18-9420-30P	Mercury	92-802835Q1	206
18-9099	Mercury Marine	879078	868	18-9420-7	Mercury Marine	92-802836A1	206
18-9099	Mercury Marine	32657A3	868	18-9420-7P	Mercury	92-802836A1	206
18-9099	Mercury Marine	32657A4	868	18-9420CAT-2	Mercury Marine	92-8M0078625	209
18-9099	Mercury Marine	41155A1	868	18-9420CAT-2P			Mercury Marine
18-9099	Mercury Marine	41155A2	868	209	18-9420CAT-3	Mercury Marine	92-8M0078626
18-9099	Mercury Marine	817019A1	868	18-9420CAT-3P			Mercury Marine
18-9099	Mercury Marine	817019A2	868	209	18-9420CAT-7	Mercury Marine	92-8M0078618
18-9099	Mercury Marine	817019Q2	868	18-9420CAT-7P			Mercury Marine
18-9099	Mercury Marine	86459A1	868	209	18-9440-2	Mercury Marine	92-883724K01
18-9099	Mercury Marine	86459A2	868	18-9440-2P	Mercury Marine	92-883724K01	206
18-9125	Oetiker	787133	220, 294	18-9440-3	Mercury Marine	92-883723K01	207
18-9125	OMC	787133	220, 294	18-9440-4	Mercury Marine	92-883725K01	206
18-9125	OMC	787145	220, 294	18-9440-4P	Mercury Marine	92-883725K01	206
18-9126-9	Oetiker	16700004	220, 294	18-9440-7	Mercury Marine	92-858057K01	206
18-9126-9	OMC	346930	220, 294	18-9440-7P	Mercuriser	92-858057K01	206
18-9127-9	Oetiker	16700006	220, 294	18-9440-8	Mercury Marine	92-883722K01	207
18-9127-9	OMC	348838	220, 294	18-9440CAT-2	Mercury Marine	92-8M0078629	210
18-9128-9	Oetiker	16700007	220, 294	18-9440CAT-2P			Mercury Marine
18-9128-9	OMC	349516	220, 294	210	18-9440CAT-4	Mercury Marine	92-883724K01
18-9129-9	Oetiker	16700010	220, 294	18-9440CAT-4P			Mercury Marine
18-9129-9	OMC	347107	220, 294	210	18-9440CAT-7	Mercury Marine	92-8M0078624
18-9130-9	Oetiker	16700011	220, 294	18-9440CAT-7P			Mercury Marine
18-9130-9	OMC	347108	220, 294	210	18-9450-2	Yamaha	LUB-20W40-FC-12
18-9131-9	Oetiker	16700012	220, 294	18-9490-1			204
18-9131-9	OMC	346931	220, 294	18-9493			216
18-9132-9	Oetiker	16700013	220, 294	18-9494			204
18-9132-9	OMC	346785	220, 294	18-9495			204
18-9133-9	Oetiker	16700016	220, 294, 513	18-9499			204
18-9133-9	OMC	346786	220, 294	18-9500-1			204
18-9133-9	Yamaha	YB-6AW04-1	220, 513	18-9500-1P			204
18-9134-9	Oetiker	16700017	220, 294	18-9500-2			204
18-9134-9	OMC	348839	220, 294	18-9500-2P			204
18-9135-9	Oetiker	16700024	220, 294	18-9500-3			204
18-9135-9	OMC	346151	220, 294	18-9500-3P			204
18-9136-9	Oetiker	16700031	220, 294	18-9500-4			204
18-9136-9	OMC	346152	220, 294	18-9500-4P			204
18-9137-9	Oetiker	16700037	220, 294	18-9500-6			204
18-9137-9	OMC	346153	220, 294	18-9500-7			204
18-9138-9	Oetiker	16700040	220, 294	18-9500-7P			204
18-9138-9	OMC	349759	220, 294	18-9500-7P			204
18-9139-9	Oetiker	16700053	220, 294	18-9530-3	Mercury Marine	92-858037K01	204
18-9139-9	OMC	349729	220, 294	18-9530-3	OMC	764354	204
18-9140-9	Oetiker	16700020	220, 294	18-9530-3	Yamaha	LUB-25TRK-M1-4	204
18-9140-9	OMC	346150	220, 294	18-9530-3P			204
18-9141	Oetiker	14100082	220, 294, 513	18-9530-4			204
18-9141	OMC	787145	220, 294	18-9530-4P			204
18-9145	Yamaha	YB-6AW04-A	220, 513	18-9530-6			204
18-9146-9	Yamaha	YB-6AW04-3	220, 513	18-9530-7			204
18-9182			217	18-9530-7P			204
18-9183			217	18-9530-3	Mercury Marine	92-858037K01	204
18-9200-0	Mercury Marine	92-8M0071838	215	18-9530-3	OMC	764354	204
18-9200-1	Mercury Marine	92-8M0071841	215	18-9530-3	Yamaha	LUB-25TRK-M1-4	204
18-9200-2	Mercury Marine	92-8M0071837	215	18-9530-3P			204
18-9200-4	Mercury Marine	92-8M0071837	215	18-9530-4			204
18-9218	Mercury Marine	59829A1	848	18-9530-4P			204
18-9218	Mercury Marine	59830A5	848	18-9530-6			204
				18-9530-7	Mercury Marine	92-858039K01	204

1 This product is priced per piece. To order, priced per package, please add -9 to the part number

2 Items ending in "D" are display packaged - regular number is non-display

3 For discount shop pack of 10, please add -10 to the part number

SIERRA #	O.E.M.	O.E. #	PAGE #	SIERRA #	O.E.M.	O.E. #	PAGE #
SIERRA							
18-9530-7	OMC	777228	204	18-9801	Mercury Marine	91-99750A1	227, 383
18-9530-7	Yamaha	LUB-2STRK-M1-55	204	18-9802	Mercury Marine	91-99379	383
18-9530-7P			204				228, 241, 274, 383, 479,
18-9540-2			204				500, 581, 594, 615, 643,
18-9540-3	OMC	764357	204				719, 896, 972
18-9540-3P			204	18-9803	Mercury Marine	91-17256	224, 858
18-9540-7	OMC	777120	204	18-9803	Mercury Marine	91-36235	858
18-9550-0			216	18-9804			219
18-9550-3			216	18-9805	Mercury Marine	12-34961	225
18-9551-2	Suzuki	990C0-10W40-1QT	205	18-9806E	Mercury Marine	91-12037	223
18-9551-3	Suzuki	990C0-10W40-1GL	205	18-9806E			854
18-9551-6			205	18-9807	Mercury Marine	91-12427	224
18-9551-7			205	18-9807	Mercury Marine	91-12427T	224
18-9552-3	Mercury Marine	92-858084K01	205	18-9808	Mercury Marine	91-15755	224
18-9552-6			205	18-9808	Mercury Marine	91-15755T	224
18-9552-8			205	18-9808	Mercury Marine	91-31109	224
18-9553-2	Volvo	40005011	205	18-9808	Mercury Marine	91-37263	224
18-9553-2			205	18-9809	Mercury Marine	91-17257	224
18-9553-3	Mercury Marine	92-858042K01	205	18-9810	Mercury Marine	91-17262A1	224
18-9553-3	Mercury Marine	92-858042Q01	205	18-9812	Mercury Marine	91-17275A1	224
18-9553-3	Volvo	40005012	205	18-9814	Mercury Marine	91-29310	224
18-9553-5	Volvo	40005013	205	18-9815	Mercury Marine	91-37324	230
18-9553-6			205	18-9816	Mercury Marine	91-30366T1	230
18-9553-7	Volvo	40005014	205	18-9817	Mercury Marine	91-23033	224
18-9554-2	Indmar	872005	208	18-9817	Mercury Marine	91-23033T	224
18-9554-4	Indmar	872006	208	18-9817	Mercury Marine	91-24150	224
18-9554-5	Indmar		208	18-9817	Mercury Marine	91-31107	224
18-9554-7	Indmar		208	18-9817	Mercury Marine	91-31107T	224
18-9555-2	Indmar	872003	208	18-9819	Mercury Marine	91-31229	230
18-9555-4	Indmar	872004 (7QT)	208	18-9820-1	Mercury Marine	91-31229A7	225
18-9555-7	Indmar		208	18-9821	Mercury Marine	91-32325	224
18-9558-2	Ilmor/MasterCraft	550022689	208	18-9821	Mercury Marine	91-32325T	224
18-9558-4	Ilmor/MasterCraft	550046126	208	18-9822	Mercury Marine	91-32336	225
18-9558-7	Ilmor/MasterCraft		208	18-9823	Mercury Marine	91-33489	224
18-95560			223	18-9824	Mercury Marine	91-33491	224
18-9570-0			216	18-9825	Mercury Marine	91-33492	224
18-9580-3			216	18-9825	Mercury Marine	91-33492T	224
18-9600-0	Mercury Marine	92-802844Q02	214	18-9826	Mercury Marine	91-33493	224
18-9600-2	Mercury Marine	92-858058Q01	214	18-9826	Mercury Marine	91-33493T	224
18-9600-2P	Mercury Marine	92-858058Q01	214	18-9827	Mercury Marine	91-34379T	224
18-9600-5	Mercury Marine	92-858007Q01	214	18-9828	Mercury Marine	91-36379	230
18-9600-5P	Mercury Marine	92-858007Q01	214	18-9829	Mercury Marine	91-36569	225
18-9600-6	Mercury Marine	92-858061Q01	214	18-9829	Mercury Marine	91-36569T	225
18-9600-7	Mercury Marine	92-858062Q01	214	18-9830	Mercury Marine	91-36571	225
18-9600-7P	Mercury Marine	92-858062Q01	214	18-9830	Mercury Marine	91-36571T	225
18-9600-9			214	18-9831	Mercury Marine	91-36577	225
18-9620-0			Obsolete	18-9831	Mercury Marine	91-36577T	225
18-9620-2			Obsolete	18-9832	Mercury Marine	91-37292	230
18-9620-5			Obsolete	18-9833	Mercury Marine	91-37311	230
18-9650-0			214	18-9834	Mercury Marine	91-37312	230
18-9650-2	Mercury Marine	92-858064Q01	214	18-9835	Mercury Marine	91-37323	225
18-9650-2P	Mercury Marine	92-858064Q01	214	18-9836	Mercury Marine	91-37350	225
18-9650-2QP	Mercury Marine	91-8M0101435	214, 218	18-9837	Mercury Marine	91-38628T	225
18-9650-5	Mercury Marine	92-858008Q01	214	18-9838	Mercury Marine	91-38756	225
18-9650-5P	Mercury Marine	92-858008Q01	214	18-9839	Mercury Marine	91-38918T	225
18-9650-6	Mercury Marine	92-858067Q01	214	18-9840	Mercury Marine	91-38919	Obsolete
18-9650-6P	Mercury Marine	92-858067Q01	214	18-9841	Mercury Marine	91-42840T	225
18-9650-7	Mercury Marine	92-858068Q01	214	18-9842	Mercury Marine	91-43506T	225
18-9650-7P	Mercury Marine	92-858068Q01	214	18-9843	Mercury Marine	91-43559	Obsolete
18-9680-2	Volvo	1141679	214	18-9844	Mercury Marine	91-43579	225
18-9680-5	Volvo	1141681	214	18-9845	Mercury Marine	91-43591T	225
18-9680-7	Volvo	1141682	214	18-9846	Mercury Marine	91-44110	Obsolete
18-9690-2			207, 210	18-9847	Mercury Marine	91-45497A1	225
18-9690-3			207, 210	18-9848	Mercury Marine	91-52393	225
18-9730-1			217	18-9849	Mercury Marine	91-52394	225
18-9750-0			216	18-9850	Mercury Marine	91-53459	225
18-9751-0			216	18-9851	Mercury Marine	91-55916	225
18-9751-2			216	18-9852	Mercury Marine	91-55918	226
18-9775			216	18-9853	Mercury Marine	91-56048001	226
18-9776			216	18-9853	Mercury Marine	91-56048T	226
18-9777			216	18-9854	Mercury Marine	91-56775T	226
18-9778			218	18-9855	Mercury Marine	91-60523	226
18-9779			218	18-9856	Mercury Marine	91-60526T	226
18-9780			217	18-9857	Mercury Marine	91-61067A3	226
18-9781	Mercury Marine	91-850730Q01	218	18-9858	Mercury Marine	91-61069T	226
18-9781	Mercury Marine	91-8M0072133	218	18-9859	Mercury Marine	91-63616	226
18-9782	Mercury Marine	91-74057Q6	218	18-9860	Mercury Marine	91-63638T	226
18-9783	Mercury Marine	91-74057Q6	218	18-9861	Mercury Marine	91-78310	226
18-9784			219	18-9862	Mercury Marine	91-87119	229
18-9785	Mercury Marine	91-30500	219	18-9863	Mercury Marine	91-89865	227
18-9786			214	18-9865	Mercury Marine	91-90774	227
18-9787			218	18-9866	Mercury Marine	91-89897	227
18-9788			218	18-9868	Mercury Marine	91-61077	226
18-9789			218	18-9869	Mercury Marine	91-817570T	226
18-9790			218	18-9870	Mercury Marine	91-818162	226
18-9794	Mercury Marine	91-883704Q03	218	18-9871	Mercury Marine	91-818169T	226
18-9795			218	18-9872	Mercury Marine	91-821571A1	226
18-9798			204, 217	18-9873	Mercury Marine	91-813653	224
18-9800			227, 383	18-9874	Mercury Marine	91-14311A04	229
18-9801	Mercury Marine	91-99750A1	227, 383	18-9874	Mercury Marine	91-14311A1	224

1 This product is priced per piece. To order, priced per package, please add -9 to the part number

2 Items ending in "D" are display packaged - regular number is non-display

3 For discount shop pack of 10, please add -10 to the part number

SIERRA #	O.E.M.	O.E. #	PAGE #	SIERRA #	O.E.M.	O.E. #	PAGE #
SIERRA							
18-9874	Mercury Marine	91-14311A2	224	18-99069	Yamaha	65W-11351-00	544
18-9874	Mercury Marine	91-44307A1	224	18-9907			228
18-9875	Mercury Marine	91-90244A1	Obsolete	18-99070	Yamaha	65W-11356-00	544
18-9876	OMC	349957	223, 932	18-99071	Yamaha	65W-14457-10	544
18-9879	Mercury		223	18-99072	Yamaha	65W-41114-00	544
18-9884	Racor	RK22628	154, 157, 158, 217	18-99073	Yamaha	65W-W0001-20	536
18-9885	OMC	328360	223	18-99074	Yamaha	66M-11351-10	544
18-9886	OMC	328361	223	18-99075	Yamaha	66M-11356-00	544
18-9887	OMC	328363	223	18-99076	Yamaha	66M-13329-10	544
18-9888	OMC	328364	223	18-99078	Yamaha	66M-41138-00	544
18-9889	OMC	328365	223	18-99079	Yamaha	66M-45115-00	544
18-9890	OMC	328366	223	18-9908			228
18-9891	OMC	328367	223	18-99080	Yamaha	67E-13646-A0	544
18-9892	OMC	341440	223	18-99081	Yamaha	67E-41112-A0	Obsolete
18-9894	OMC	393279	223	18-99082	Yamaha	67E-44315-A1	544
18-9895	Merco/Evinrude	881150K1	220	18-99083	Yamaha	67E-44324-A0	544
18-9896	Mercury	91-47448A1	223	18-99084	Yamaha	67E-45127-00	544
18-9896	Mercury	91-75132	223	18-99085	Yamaha	67E-45128-00	544
18-9896	Mercury	91-878232	223	18-99086	Yamaha	67E-44316-A0	544
18-9896	Mercury	91-90455	223	18-99087	Yamaha	67E-45315-A0	544
18-9896	Mercury	91-904551	223	18-99088	Yamaha	67C-11356-00	544
18-9896	Mercury	91-90455T	223	18-99089	Yamaha	67C-41114-00	545
18-9896	Mercury	91-90455T1	223	18-9909			229
18-9897	Mercury	91-895343A02	223	18-99091	Yamaha	67C-45113-00	545
18-9897	Mercury	91-895343T01	223	18-99092	Yamaha	67C-W0001-00	536
18-9897	Mercury	91-895343T02	223	18-99093	Yamaha	67C-W0001-20	536
18-9898			218	18-99094	Yamaha	67F-11181-02	539
18-9900	Universal			18-99095	Yamaha	682-11351-A0	545
18-99000	Yamaha	61A-41134-A0	541	18-99096	Yamaha	682-41112-A1	545
18-99001	Yamaha	61A-45114-A0	541	18-99097	Yamaha	682-W0001-06	537
18-99002	Yamaha	62Y-41133-00	541	18-99098	Yamaha	688-13621-A1	545
18-99003	Yamaha	62Y-41134-01	541	18-99099	Yamaha	68F-11193-01	545
18-99004	Yamaha	63D-45114-A0	541	18-9910			229
18-99005	Yamaha	63D-45123-00	541	18-99100	Yamaha	68F-11381-00	545
18-99006	Yamaha	63V-41133-A1	541	18-99101	Yamaha	68F-41114-00	545
18-99008	Yamaha	64J-41133-10	542	18-99102	Yamaha	68F-45113-00	545
18-99009	Yamaha	663-45123-00	542	18-99103	Yamaha	68F-W0001-01	537
18-99010	Yamaha	664-41134-A0	542, 564, 564	18-99104	Yamaha	6A0-W0001-21	537
18-99012	Yamaha	66M-41133-00	542	18-99105	Yamaha	6E5-13621-A1	545
18-99013	Yamaha	66M-45113-00	542	18-99106	Yamaha	6E9-11193-A0	545
18-99014	Yamaha	67E-41133-A0	542	18-99107	Yamaha	6E9-41114-A0	545
18-99015	Yamaha	67E-45114-A0	542	18-99108	Yamaha	6G1-11193-A1	545
18-99016	Yamaha	67C-41133-00	542	18-99109	Yamaha	6G1-13621-A1	545
18-99017	Yamaha	67C-45123-00	542	18-9911			229
18-99018	Yamaha	67F-41133-A1	542	18-99110	Yamaha	6G1-13645-A1	545
18-99019	Yamaha	67F-41134-A0	542	18-99111	Yamaha	6G1-14198-A1	545
18-9902	Universal		227	18-99112	Yamaha	6G1-41112-A1	545
18-99020	Yamaha	67F-45123-00	542	18-99113	Yamaha	6G1-41114-A0	545
18-99021	Yamaha	682-41133-A0	542	18-99114	Yamaha	6G1-41133-A0	545
18-99022	Yamaha	682-45113-A1	542	18-99115	Yamaha	6G1-45113-A1	545
18-99023	Yamaha	688-41133-00	542	18-99116	Yamaha	6G1-45315-A0	545
18-99024	Yamaha	688-41134-A0	542	18-99117	Yamaha	6G1-W0001-A2	537
18-99025	Yamaha	688-45114-A1	542	18-99118	Yamaha	6G5-14483-A1	545
18-99026	Yamaha	688-45123-00	542	18-99119	Yamaha	6G8-11351-A0	545
18-99027	Yamaha	68T-13475-00	542	18-9912			229
18-99028	Yamaha	68V-15312-00	542	18-99120	Yamaha	6G8-12414-A0	545
18-9903			228, 228, 228	18-99121	Yamaha	6G8-13646-A0	546
18-99030	Yamaha	697-45114-A0	543	18-99122	Yamaha	6G8-14198-A0	546
18-99032	Yamaha	69J-41134-A0	543	18-99123	Yamaha	6G8-15374-00	546
18-99033	Yamaha	69J-41135-A0	543	18-99124	Yamaha	6H3-12414-A1	546
18-99034	Yamaha	69J-41136-A0	543	18-99125	Yamaha	6H3-13622-00	546
18-99037	Yamaha	6E5-41134-A0	543	18-99126	Yamaha	6H3-14198-01	546
18-99038	Yamaha	6E5-41135-A0	543	18-99127	Yamaha	6P-12414-00-00	548
18-99039	Yamaha	6G5-41134-A1	543	18-99128	Yamaha	6H3-41112-A0	546
18-9904			228	18-99129	Yamaha	6H3-41114-A0	546
18-99040	Yamaha	6G5-45114-A1	543	18-9913			229
18-99045	Yamaha	6G8-45113-A1	543	18-99130	Yamaha	6H3-45113-A0	546
18-99046	Yamaha	6H3-45114-A1	543	18-99132	Yamaha	6H4-13621-A1	546
18-99047	Yamaha	6H3-45123-00	543	18-99133	Yamaha	6H4-14198-01	546
18-99048	Yamaha	60V-11181-00	539	18-99134	Yamaha	6H4-15369-A1	546
18-99049	Yamaha	60V-13621-A0	543	18-99135	Yamaha	6H4-41112-A0	546
18-9905			228	18-99136	Yamaha	6K7-13686-A1	546
18-99050	Yamaha	60V-13645-00	543	18-99137	Yamaha	6L2-41133-A2	546
18-99051	Yamaha	61A-11193-A1	543	18-99138	Yamaha	6L2-45315-A0	546
18-99052	Yamaha	61A-11381-A0	543	18-99139	Yamaha	6OV-13646-00	546
18-99053	Yamaha	61A-13621-A0	543	18-9914			228
18-99054	Yamaha	61A-13645-00	543	18-99140	Yamaha	63V-11181-A2	546
18-99055	Yamaha	61A-13646-00	543	18-99141	Yamaha	6H3-11193-A1	546
18-99056	Yamaha	61A-45113-A0	543	18-99142	Yamaha	6E9-12414-A1	546
18-99057	Yamaha	61T-11193-A1	543	18-99143	Yamaha	6H3-13621-A1	546
18-99059	Yamaha	63D-11193-A0	539	18-99144	Yamaha	6E7-14227-00	546
18-9906			228	18-99145	Yamaha	677-14198-A1	546
18-99060	Yamaha	63D-11181-A1	539	18-99146	Yamaha	677-14384-01	504
18-99061	Yamaha	63D-W0001-00	538	18-99147	Yamaha	6G1-24431-01	546
18-99062	Yamaha	68F-11181-00	539	18-99148	Yamaha	688-41114-A0	546
18-99063	Yamaha	63V-45315-A0	544	18-99149	Yamaha	663-44316-A0	547
18-99064	Yamaha	64E-13645-A0	544	18-99150	Yamaha	63V-45113-A1	547
18-99066	Yamaha	65L-13645-00	544	18-99151	Yamaha	688-45113-A0	547
18-99067	Yamaha	65L-13646-00	544	18-99152	Yamaha	683-45315-A0	547
18-99068	Yamaha	65W-11169-00	544	18-99153	Honda	19232-ZW9-000	263

1 This product is priced per piece. To order, priced per package, please add -9 to the part number

2 Items ending in "D" are display packaged - regular number is non-display

3 For discount shop pack of 10, please add -10 to the part number

SIERRA #	O.E.M.	O.E. #	PAGE #	SIERRA #	O.E.M.	O.E. #	PAGE #
SIERRA							
18-99154	Honda	19234-ZX2-C00	263	35-SS700			230
18-99155	Mercury	27-822217	416	35-SS715	Mercury		230
18-99156	Johnson/Evinrude	325040	303	35-SSKIT1			230
18-99157	Yamaha	6EG-G4315-00	523	72-5100-2	Arctic Cat	0436-880	211
18-99175	Yamaha	63V-W0001-01	538	72-5100-2	Honda	HP4	211
18-99176	RACOR	6H3-W0001-02	538	72-5100-2			211
18-99186	RACOR	2010SM-OR	156	72-5100-3	Arctic Cat	0436-879	211
18-99182	RACOR	2010TM-OR	156	72-5100-7			211
18-99183	RACOR	2010PM-OR	156	72-5101-2	Arctic Cat	1436-434	211
18-99184	RACOR	2040N-30	156	72-5101-2	Can-Am	XPS #779139	211
18-99185	RACOR	2040N-10	156	72-5101-3	Arctic Cat	1436-435	211
18-99191	RACOR	2040N-02	156	72-5101-3	Can-Am	XPS #779140	211
18-99180	RACOR	2020N-30	156	72-5101-7			211
18-99181	RACOR	2020N-10	156	72-5102-2	Arctic Cat	1436-159	212
18-99187	RACOR	2020N-02	156	72-5102-2	Honda	06208-0080	212
18-99193	RACOR	R12T	156	72-5102-2			212
18-99194	RACOR	R12S	156	72-5102-4	Arctic Cat	0436-901	212
18-99196	RACOR	R20S	156	72-5102-4			212
18-99199	RACOR	R12P	156	72-5102-5			212
18-99200	RACOR	R20P	156	72-5102-7			212
18-99201	RACOR	RK10215	156	72-5103-2	Arctic Cat	4639-349	211
18-99203	RACOR	RK22368	156	72-5103-2	Honda	HP2	211
18-99202		RK350-02	156	72-5103-2	Yamaha		211
18-ADC400			236	72-5103-2	Ski-Doo	XPS 779126	211
18-ADC401			236	72-5103-2	Polaris	VES	211
18-ADC402			236	72-5103-2	Kawasaki	K61021-208A	211
18-ADC403			237	72-5103-3	Arctic Cat	5639-469	211
18-ADC404			237	72-5103-3	Honda	HP2	211
18-ADC406			237	72-5103-3			211
18-ADC407			237	72-5103-3	Ski-Doo	XPS 779127	211
18-ADC408			237	72-5103-3	Polaris	VES	211
18-ADC409			236	72-5103-4	Honda	HP2	211
18-ADC410			237	72-5103-4	Yamaha		211
18-ADC411			237	72-5103-4	Polaris	VES	211
18-ADC412			236	72-5103-5	Honda	HP2	211
18-ADC414			237	72-5103-5	Polaris	VES	211
18-ADC415			237	72-5103-7	Honda	HP2	211
18-ADC416			237	72-5103-7	Polaris	VES	211
18-ADC417			237	72-5104-2	Polaris	PS-4	212
18-ADC418			237	72-5104-3	Polaris	PS-4	212
18-ADC419			238	72-5104-7	Polaris	PS-4	212
18-ADC420			238	72-5105-2			212
18-ADC421			238	72-5105-3			212
18-ADC422			238	72-5105-7			212
18-ADC423			238	56966P			21, 135
18-ADC424			238	56967P			21, 135
18-ADC425			238	BC88523			76
18-ADC427			238	BC88533			76
18-ADC428			238	BC88543			76
18-ADC450			236	BC88553			76
18-SD111			238	BC88563			76
18-SD112			238	BC88573			76
18-SD113			238	BC88583			76
18-SD114			238	BC88593			76
18-SD115			238	EC01350			73, 229
18-SD115SUB			234	EC09040			73, 229
18-SD116			238	EC09090			73, 228
18-SD116SUB			234	GS62600			221
18-SD117			238	GS62610			221
18-SD117SUB			234	GS62620			221
18-SD405			238	GS62630			221
18-SD406			238	GS62640			221
18-SD406SUB			234	GS62650			221
18-SD407			238	GS62660			221
18-SD407SUB			234	GS62670			221
18-SD410			234	GS62680			221
18-SD413			238	GS62690			221
18-SD413SUB			234	GS62700			221
18-SD414			238	GS62710			221
18-SD415			238	GS62720			221
18-SD500			234	GS62730			221
18-SD501			234	GS62740			221
35-SS800			Obsolete	GS62750			221
35-SS805			230	GS62760			221
35-SS610			230	GS62770			221
35-SS615			230	GS62780			221
35-SS620			230	GS62790			221
35-SS625			230	GS62800			221
35-SS630			230	GS62810			221
35-SS635			Obsolete	GS62820			221
35-SS645			230	GS62830			221
35-SS650			230	GS62840			222
35-SS655	Volvo		Obsolete	GS62850			222
35-SS660			Obsolete	GS62860			222
35-SS665			Obsolete	GS62870			222
35-SS670	Johnson/Evinrude		Obsolete	GS62880			222
35-SS680	Johnson/Evinrude		Obsolete	GS62890			222
35-SS685	Honda		Obsolete	GS62900			222
35-SS690	Yamaha		Obsolete	GS62910			222
35-SS695			230	GS62920			222

1 This product is priced per piece. To order, priced per package, please add -9 to the part number

2 Items ending in "D" are display packaged - regular number is non-display

3 For discount shop pack of 10, please add -10 to the part number

SIERRA #	O.E.M.	O.E. #	PAGE #	SIERRA #	O.E.M.	O.E. #	PAGE #
SIERRA							
GSS62600			222	MP41000	Mercury Marine	87-88107	381
GSS62610			222	MP41070-2	Mercury Marine	87-17009A2	381
GSS62630			222	MP51010	Suzuki	37110-99-E00	25, 478
GSS62640			222	MP51012	Suzuki	37110-99-E00	25, 478
GSS62670			222	MP51020	Yamaha	703-82510-12-00	25, 492
GSS62680			222	MP51022	Yamaha	703-82510-12-00	25, 492
GSS62700			222	MP51030	Yamaha	61B-82510-00-00	25, 492
GSS62710			222	MP51030	Yamaha	61B-82510-01-00	25, 492
GSS62720			222	MP51032	Yamaha	61B-82510-01-00	25, 492
GSS62740			222	MP51040	Yamaha	703-82510-43-00	25, 493
GSS62750			222	MP51042	Yamaha	703-82510-43-00	25, 493
GSS62760			222	MP51050	Yamaha	6K1-82510-06-00	25, 493
GSS62770			222	MP51052	Yamaha	6K1-82510-06-00	25, 493
GSS62780			222	MP51090	Mercury Marine	87-17009A5	25, 381
GSS62790			222	MP51092	Mercury Marine	87-17009A5	25, 381
GSS62800			222	MP52000	Mercury Marine	87-88107A5	25, 381, 381
GSS62820			222	PC51000			65
GSS62830			222	PC51010			65
MP28860	Yamaha	682-82556-00-00	32, 493	PC51020			65
MP28860			32, 493	PC51030			65
MP28870	OMC	585134	32, 277	PC51040			65
MP28870			32, 277	PC51050			65
MP28880	OMC	432230	32, 277, 889	PC51060			65
MP28890	OMC	176288	32, 277, 889	PC51070			65
MP28900	OMC	432230	32, 278	PC51080			65
MP28902-1	OMC	432230	32, 278	PC51090			65
MP39100	OMC	386545	31, 277	PC51100			65
MP39160			50, 492	PC51110			65
MP39760	OMC	393301	30, 277	PC51120			65
MP39760	OMC	508180	30, 277	PC51130			65
MP39830	OMC	386545	31, 277				65



1 This product is priced per piece. To order, priced per package, please add -9 to the part number

2 Items ending in "D" are display packaged - regular number is non-display

3 For discount shop pack of 10, please add -10 to the part number

OIL FILTER QUICK-REFERENCE GUIDE

All listed oil capacities are approximate amounts only and may or may not include the oil filter capacity.
ALWAYS follow proper crankcase drain and fill procedures. Check engine dipstick for proper crankcase oil level.

ALBIN

Model	Year	Oil Filter	Replaces	Crankcase Capacity	Recommended Oil
AD-21		18-7878-1	3875827	See Owners Manual	See Owners Manual

B & W LATHROP

Model	Year	Oil Filter	Replaces	Crankcase Capacity	Recommended Oil
130155		18-7875		See Owners Manual	See Owners Manual

CATERPILLAR

Model	Year	Oil Filter	Replaces	Crankcase Capacity	Recommended Oil
3304, 3306, D330		18-7880	1R-0658	See Owners Manual	See Owners Manual
3116, 3116TA, 3208, 3208T, 3208TA		18-7927	1R-0714	See Owners Manual	See Owners Manual

CHRIS-CRAFT

Model	Year	Oil Filter	Replaces	Crankcase Capacity	Recommended Oil
307G, 305K, 307K		18-7824-2	16.81-08746	See Owners Manual	See Owners Manual

CHRYSLER

Model	Year	Oil Filter	Replaces	Crankcase Capacity	Recommended Oil
(Chrysler-Volvo) 100, 110, 120, 130,		18-7878-1		See Owners Manual	See Owners Manual
165, 170		18-7878-1		See Owners Manual	See Owners Manual
125, 150, 155, 175, Fury 190, 195, 200,		18-7875	1851658	See Owners Manual	See Owners Manual
210, 225, 235, 250, 260, 280, 300, 330,		18-7875	1851658	See Owners Manual	See Owners Manual
335, 375, 525, CM6-55, CMC-55NA,		18-7875	1851658	See Owners Manual	See Owners Manual
M-170A, M-225A, M-225D, M-273A,		18-7875	1851658	See Owners Manual	See Owners Manual
M-273B, M-273BD/D, LM-318, LM-318A,		18-7875	1851658	See Owners Manual	See Owners Manual
LM-318B, M-318B, M-318C, M-383B,		18-7875	1851658	See Owners Manual	See Owners Manual
M-413B, M-413D, M-413E, M-440B,		18-7875	1851658	See Owners Manual	See Owners Manual
M-440D, Model 340, M-80, M-81,		18-7875	1851658	See Owners Manual	See Owners Manual
Super Crown 145, 150, Imperial 290,		18-7875	1851658	See Owners Manual	See Owners Manual
325, Jet II, Jet III, Jet IV, Super Bee,		18-7875	1851658	See Owners Manual	See Owners Manual
Super Bee II, Super Bee III,		18-7875	1851658	See Owners Manual	See Owners Manual
V-8 Engines 1962-on		18-7875	1851658	See Owners Manual	See Owners Manual
V-6 GM		18-7879-1	L-319	See Owners Manual	See Owners Manual
3.7L, 5.2L		18-7878-1	3549957, L-19, L1008	See Owners Manual	See Owners Manual

COMMANDER

Model	Year	Oil Filter	Replaces	Crankcase Capacity	Recommended Oil
225, 340 Clever		18-7875		See Owners Manual	See Owners Manual

CRUSADER

Model	Year	Oil Filter	Replaces	Crankcase Capacity	Recommended Oil
150, 160, 165, CH185, 210, CH220,		18-7824-2	201104	See Owners Manual	See Owners Manual
CH270, 350, CH350		18-7824-2	201104	See Owners Manual	See Owners Manual
SS330		18-7876-1 (Long), 18-7824-2 (Short)	201104	See Owners Manual	See Owners Manual
220 Conqueror, 255 Conqueror,		18-7875	9002514	See Owners Manual	See Owners Manual
255 Conqueror Jet, 250 (71),		18-7875	9002514	See Owners Manual	See Owners Manual
300 Scorpion, 460		18-7875	9002514	See Owners Manual	See Owners Manual
220, 300, 320, 325		18-7878-1		See Owners Manual	See Owners Manual
5.0L Carbureted (Classic)	1999 - 2008	18-7875	22679	See Owners Manual	Start with 4 Quarts - Fill to full level
1999 - 2010	1999 - 2010	18-7875	22679	See Owners Manual	Start with 4 Quarts - Fill to full level
5.0L MPI (Captain's Choice)	2004 - 2013	18-7875	22679	5.67L / 6.0 Qt.	Start with 4 Quarts - Fill to full level
5.7L MPI (Captain's Choice)	2005 - 2013	18-7875	22679	5.67L / 6.0 Qt.	Start with 4 Quarts - Fill to full level

CRUSADER CONTINUED ON NEXT PAGE

OIL FILTER QUICK-REFERENCE GUIDE

CRUSADER

Model	Year	Oil Filter	Replaces	Crankcase Capacity	Recommended Oil
6.0L MPI (Captain's Choice)	2006 - 2013	18-7875	22679	4.75L / 5.0 Qt.	API 15W-40 SM or Higher
7.4L MPI (Captain's Choice)	All	18-7875	22679	See Owners Manual	API 15W-40 SM or Higher
8.1L MPI (Captain's Choice)	2001 - 2010	18-7875	22679	6.65 L / 7.0 Qt.	API 15W-40 SM or Higher
8.1L MPI HD (Captain's Choice)	2009 - 2010	18-7875	22679	6.65 L / 7.0 Qt.	API 15W-40 SM or Higher

DETROIT DIESEL

Model	Year	Oil Filter	Replaces	Crankcase Capacity	Recommended Oil
2-71 (142), 3-71 (213), 4-53 (212), 4-71 (284), 6V-53 (318), 6-71 (426), 6-71E (426), 671N (426), 6-71T (426), 6V-71 (426), 6V-71T (426), 6V-92 (552), 6V-92T (522), 8V-71 (568), 8V-71T (568), 8V-92 (736), 8V-92T (736), 12V-71 (1788), 12V-71T (1788), 12V-149 (1788), 16V-71 (1136), 16V-71T (1136), 16V-92 (1472), 16V-92T (1472), 16V-149 (2384) Series		N/A	25010495	See Owners Manual	See Owners Manual

EVINRUDE / JOHNSON

Model	Year	Oil Filter	Replaces	Crankcase Capacity	Recommended Oil
9.9 HP	1995 - 2001	18-7916	434839	1272 ml. / 43 oz.	10W40 Synthetic Blend FC-W
9.9 HP	2002-2007	18-7903	5033102; 763364	1.1 L / 1.2 Qt.	10W40 Synthetic Blend FC-W
15 HP	1995-2001	18-7916	434839	1272 ml. / 43 oz.	10W40 Synthetic Blend FC-W
15 HP	2002-2007	18-7903	5033102; 763364	1.1 L / 1.2 Qt.	10W40 Synthetic Blend FC-W
25 HP	2000-2001	18-7915-1	5031411; 778885	3.2 L / 3.4 Qt.	10W40 Synthetic Blend FC-W
25 HP	2004-2007	18-7915-1	5031411; 778885	3.2 L / 3.4 Qt.	10W40 Synthetic Blend FC-W
30 HP	2000-2001	18-7915-1	5031411; 778885	3.2 L / 3.4 Qt.	10W40 Synthetic Blend FC-W
30 HP	2004-2007	18-7915-1	5031411; 778885	3.2 L / 3.4 Qt.	10W40 Synthetic Blend FC-W
40 HP	1999-2006	18-7915-1	5031411; 778885	2.4 L / 2.5 Qt.	10W40 Synthetic Blend FC-W
50 HP	1999-2006	18-7915-1	5031411; 778885	2.4 L / 2.5 Qt.	10W40 Synthetic Blend FC-W
60 HP	2002-2006	18-7915-1	5031411; 778885	4.5 L / 4.8 Qt.	10W40 Synthetic Blend FC-W
70 HP	1998-2000	18-7916	434839	4.5 L / 4.8 Qt.	10W40 Synthetic Blend FC-W
70 HP	2001-2006	18-7915-1	5031411; 778885	4.5 L / 4.8 Qt.	10W40 Synthetic Blend FC-W
90 HP	2003-2006	18-7896	5033539; 778886	5.7 L / 6.0 Qt.	25W40 Synthetic Blend FC-W
115 HP	2003-2006	18-7896	5033539; 778886	5.7 L / 6.0 Qt.	25W40 Synthetic Blend FC-W
140 HP	2003-2006	18-7897	5033919; 778887	5.7 L / 6.0 Qt.	25W40 Synthetic Blend FC-W
200 HP	2004-2006	18-7895	5035703; 778888	8.2 L / 8.7 Qt.	25W40 Synthetic Blend FC-W
225 HP	2004-2006	18-7895	5035703; 778888	8.2 L / 8.7 Qt.	25W40 Synthetic Blend FC-W

FISCHER PANDA

Model	Year	Oil Filter	Replaces	Crankcase Capacity	Recommended Oil
PMS 8 Mini		23-7804	SE15853-99170	2.5L / 2.64 Qt.	15W-40 API CF or Higher
PMS 8 DP		23-7804	SE15853-99170	2.5L / 2.64 Qt.	15W-40 API CF or Higher
PMS 4200		23-7804	SE15853-99170	1L / 1.05 Qt.	15W-40 API CF or Higher
PMS 6500		23-7804	SE15853-99170	2.5L / 2.64 Qt.	15W-40 API CF or Higher
PMS 12 DP		23-7804	SE15853-99170	3.8L / 4.0 Qt.	15W-40 API CF or Higher
PMS 12 Mini		23-7804	SE15853-99170	3.8L / 4.0 Qt.	15W-40 API CF or Higher
PMS 16 DP		23-7842		See Owners Manual	15W-40 API CF or Higher
PMS 22		23-7842		See Owners Manual	15W-40 API CF or Higher
16V-92T (1472), 16V-149 (2384) Series		N/A	25010495	See Owners Manual	See Owners Manual

OIL FILTER QUICK-REFERENCE GUIDE

FLAGSHIP

Model	Year	Oil Filter	Replaces	Crankcase Capacity	Recommended Oil
150FA, 220FF, 250FA, 400FA,		18-7824-2		See Owners Manual	See Owners Manual
425FAJ, 650FAJ, 950FAJ		18-7824-2		See Owners Manual	See Owners Manual
292, 300, 307, 327, 350, 482		18-7824-2 (Short) 18-7876-1-1 (Long)		See Owners Manual	See Owners Manual

FORD

Model	Year	Oil Filter	Replaces	Crankcase Capacity	Recommended Oil
CSG850M, WSG858M, LSG875M,		18-7875		See Owners Manual	See Owners Manual
SSD-655, -655M, -655MT, (5.5 Liter),		18-7875		See Owners Manual	See Owners Manual
140(2.3L) FOUR, 170, 200 Six, 240 Six,		18-7875		See Owners Manual	See Owners Manual
300 Six, 302 (5.0L), 351 (5.8L),		18-7875		See Owners Manual	See Owners Manual
460 (7.5L), 2711E, 2712E, 2713E,		18-7875		See Owners Manual	See Owners Manual
2714E, 2715E (diesel)		18-7875		See Owners Manual	See Owners Manual
254 (DSD-442 4.2 Liter), 362		18-7875		See Owners Manual	See Owners Manual
(DSD-659 5.9 Liter)		18-7875		See Owners Manual	See Owners Manual
91—V4, 104 V4, 380 (DSD-662 6.2 Liter)		18-7876-1		See Owners Manual	See Owners Manual

GM

Model	Year	Oil Filter	Replaces	Crankcase Capacity	Recommended Oil
IL6-194	1962 - 1967	18-7876-1		See Owners Manual	See Owners Manual
IL6-230	1963 - 1968	18-7876-1		See Owners Manual	See Owners Manual
267	1979 - 1981	18-7876-1		See Owners Manual	See Owners Manual
305	1976 - 1987	18-7876-1		See Owners Manual	See Owners Manual
307	1970 - 1973	18-7876-1		See Owners Manual	See Owners Manual
350	1970 - 1987	18-7876-1		See Owners Manual	See Owners Manual
366	1970 - 1987	18-7876-1		See Owners Manual	See Owners Manual
400	1971 - 1972	18-7876-1		See Owners Manual	See Owners Manual
400	1975 - 1983	18-7876-1		See Owners Manual	See Owners Manual
454	1973 - 1987	18-7876-1		See Owners Manual	See Owners Manual
400	1974 - 1977	18-7824-2		See Owners Manual	See Owners Manual

GREENWICH

Model	Year	Oil Filter	Replaces	Crankcase Capacity	Recommended Oil
Porpoise (w/IH V8-275B)		18-7875		See Owners Manual	See Owners Manual

HONDA

Model	Year	Oil Filter	Replaces	Crankcase Capacity	Recommended Oil
BF2A	All	----	----	0.40 L / 0.42 Qt.	10W-30 FC-W
BF2D	All	----	----	0.25 L / 0.26 Qt.	10W-30 FC-W
BF5	All	----	----	0.55 L / 0.58 Qt.	10W-30 FC-W
BF75 (7.5hp)	All	----	----	0.76 L / 0.80 Qt.	10W-30 FC-W
BF8 / BFP8	2001 - Current	18-7913	15400-PFB-014 15400-PFB-004	0.76 L / 0.80 Qt.	10W-30 FC-W
BF9.9 / BFP9.9	2001 - Current	18-7913	15400-PFB-014 15400-PFB-004	1.1L / 1.2 Qt.	10W-30 FC-W
BF100 (10 hp.)		----	----	0.76 L / 0.80 Qt.	10W-40 FC-W
BF15 / BFP15	2003 - Current	18-7913	15400-PFB-014 15400-PFB-004	1.1L / 1.2 Qt.	10W-30 FC-W
BF20	2003 - Current	18-7913	15400-PFB-014 15400-PFB-004	1 L / 1.1 Qt.	10W-30 FC-W

All listed oil capacities are approximate amounts only and may or may not include the oil filter capacity. ALWAYS follow proper crankcase drain and fill procedures. Check engine dipstick for proper crankcase oil level.

HONDA CONTINUED ON NEXT PAGE

OIL FILTER QUICK-REFERENCE GUIDE

HONDA

Model	Year	Oil Filter	Replaces	Crankcase Capacity	Recommended Oil
BF25	1998 & Earlier	18-7913	15400-PFB-014 15400-PFB-004 15400-PM3-004 15400-PJ7-015	1.6L / 1.7 Qt.	10W-30 FC-W
BF25 (Up to serial number 1003206)	1999 - 2005	18-7911-1	15400-PFB-007	1.6L / 1.7 Qt.	10W-30 FC-W
BF25 (Starting serial number 1003207)	2005 - Current	18-7913	15400-PFB-014	1.6L / 1.7 Qt.	5W-30 FC-W
BF30	1998 & Earlier	18-7913	15400-PFB-014 15400-PFB-004 15400-PM3-004 15400-PJ7-015	1.6L / 1.7 Qt.	10W-30 FC-W
BF30 (Up to serial number 1005016)	1999 - 2005	18-7911-1	15400-PFB-007	1.6L / 1.7 Qt.	10W-30 FC-W
BF30 (Starting serial number 1005017)	2005 - Current	18-7913	15400-PFB-014	1.6L / 1.7 Qt.	5W-30 FC-W
BF35	1997	18-7913	15400-PFB-014 15400-PFB-004 15400-PM3-004 15400-PJ7-015	2.4L / 2.5 Qt.	10W-30 FC-W
BF40	1998 & Earlier	18-7913	15400-PFB-014 15400-PFB-004	2.4L / 2.5 Qt.	10W-30 FC-W
BF40 (Up to serial number 3007642)	1999 - 2005	18-7911-1	15400-PFB-007	2.4L / 2.5 Qt.	10W-30 FC-W
BF40 (Starting serial number 3007643)	2005 - Current	18-7913	15400-PFB-014	2.0L / 2.1 Qt.	5W-30 FC-W
BF45	1997	18-7913	15400-PFB-014 15400-PFB-004 15400-PM3-004 15400-PJ7-015	2.4L / 2.5 Qt.	10W-30 FC-W
BF50	1998 & Earlier	18-7913	15400-PFB-014 15400-PFB-004 15400-PM3-004 15400-PJ7-015	2.4L / 2.5 Qt.	10W-30 FC-W
BF50 (Up to serial number 3014456)	1999 - 2005	18-7911-1	15400-PFB-007	2.4L / 2.5 Qt.	10W-30 FC-W
BF50 (Starting serial number 301457)	2005 - Current	18-7913	15400-PFB-014	2.0L / 2.1 Qt.	5W-30 FC-W
BF60 / BFP60	All	18-7913	15400-PFB-014 15400-PFB-004	2.6L / 2.7 Qt.	10W-30 FC-W
BF75	1997 - Current	18-7909	15400-PLM-A01PE 15400-P0H-305PE 15400-ZJ1-004	4.2L / 4.4 Qt.	10W-30 FC-W
BF90	1997 - Current	18-7909	15400-PLM-A01PE 15400-P0H-305PE 15400-ZJ1-004	4.2L / 4.4 Qt.	10W-30 FC-W
BF115	1999 - 2009	18-7909	15400-PLM-A01PE 15400-P0H-305PE 15400-ZJ1-004	5.6L / 5.9 Qt.	10W-30 FC-W
BF115	2010 - Current	18-7909	15400-PLM-A01PE 15400-P0H-305PE 15400-ZJ1-004	6.5L / 6.9Qt.	10W-30 FC-W
BF130	1999 - 2004	18-7909	15400-PLM-A01PE 15400-P0H-305PE 15400-ZJ1-004	5.6L / 5.9 Qt.	10W-30 FC-W
BF135	2004 - Current	18-7909	15400-PLM-A01PE 15400-P0H-305PE 15400-ZJ1-004	6.5L / 6.9Qt.	10W-30 FC-W
BF150	2004 - Current	18-7909	15400-PLM-A01PE 15400-P0H-305PE 15400-ZJ1-004	6.5L / 6.9Qt.	10W-30 FC-W

HONDA CONTINUED ON NEXT PAGE

OIL FILTER QUICK-REFERENCE GUIDE

HONDA

Model	Year	Oil Filter	Replaces	Crankcase Capacity	Recommended Oil
BF200	2002 - Current	18-7909	15400-PLM-A01PE 15400-PDH-305PE 15400-ZJ1-004	7.6L / 8.0 Qt.	10W-30 FC-W
BF225	2002 - Current	18-7909	15400-PLM-A01PE 15400-PDH-305PE 15400-ZJ1-004	7.6L / 8.0 Qt.	10W-30 FC-W
BF250A	All	18-7909	15400-PLM-A01PE, 15400-PDH-305PE, 15400-ZJ1-004	7.6L / 8.0 Qt.	7.6L / 8.0 Qt.

HYDRO-MARINE

Model	Year	Oil Filter	Replaces	Crankcase Capacity	Recommended Oil
All Models (Knecht F0335/1)		18-7875		See Owners Manual	See Owners Manual

INDMAR

Model	Year	Oil Filter	Replaces	Crankcase Capacity	Recommended Oil
200, 225, 250, 275 (SP), 300 (SP), 350-2, 350-4,	1993 & OLDER	18-7875			
350(SP), 454-2, 454-4, 400 (SP)		18-7824-2 (Short) 18-7876-1(Long)		See Owners Manual	See Owners Manual
454 Carb	2003 - 2006	18-7824-2	872023	6.62L / 7.0 Qt.	15W-40 API SL/SJ/C14/
5.7 HO	2007 - 2009	18-7824-2	872023	See Owners Manual	15W-40 API SL/SJ/C14/
5.7 Vortec	2007 - 2012	18-7824-2	872023	5.25L / 5.5 Qt.	15W-40 API SL/SJ/C14/
5.7L MPFI	2007 - 2012	18-7824-2	872023	5.25L / 5.5 Qt.	15W-40 API SL/SJ/C14/
502 Carb	2003 - 2006	18-7824-2	872023	6.62L / 7.0 Qt.	15W-40 API SL/SJ/C14/
6.0 PFI	2003 - 2006	18-7824-2	872023	See Owners Manual	15W-40 API SL/SJ/C14/
8.1L Vortec (Remote Oil Filter)	2007 - 2009	18-7824-2	872023	9.5L / 10 Qt.	15W-40 API SL/SJ/C14/
Assault 310, 325, 340, 385	2003 - 2007	18-7824-2	872023	See Owners Manual	15W-40 API SL/SJ/C14/
Malibu 350 Vortec Carbureted	2003 - 2005	18-7824-2	872023	5.25L / 5.5 Qt.	15W-40 API SL/SJ/C14/
Malibu Anniversary Edition LS6	2007	18-7824-2	872023	5.25L / 5.5 Qt.	15W-40 API SL/SJ/C14/
Malibu Hammerhead	2003 - 2007	18-7824-2	872023	5.25L / 5.5 Qt.	15W-40 API SL/SJ/C14/
Malibu LC2	2003 - 2006	18-7824-2	872023	See Owners Manual	15W-40 API SL/SJ/C14/
Malibu LS1	2003 - 2006	18-7824-2	872023	5.25L / 5.5 Qt.	15W-40 API SL/SJ/C14/
Malibu Monsoon	2003 - 2007	18-7824-2	872023	See Owners Manual	15W-40 API SL/SJ/C14/
MasterCraft 5.7L LCR	2007 - 2009	18-7824-2	872023	See Owners Manual	15W-40 API SL/SJ/C14/
MasterCraft 6.0L (LY5, LY6)	2007 - 2009	18-7824-2	872023	5.25L / 5.5 Qt.	15W-40 API SL/SJ/C14/
MasterCraft LQ9	2003 - 2006	18-7824-2	872023	5.25L / 5.5 Qt.	15W-40 API SL/SJ/C14/
MasterCraft MCX	2003 - 2007	18-7824-2	872023	See Owners Manual	15W-40 API SL/SJ/C14/CI4Plus
MasterCraft RTP-1	2003 - 2007	18-7824-2	872023	6.62L / 7.0 Qt.	15W-40 API SL/SJ/C14/
5.7L - Serial Number 174786 & Below	2013 - 2015	18-7824-2	872023	5.25L / 5.5 Qt.	15W-40 API SL/SJ/C14/
L96 (6.0L - Serial Number 174786 & Below, GM)	2014 - 2015	18-7824-2	872023	5.7L / 6.0 Qt.	15W-40 API SL/SJ/C14/
LS3, LSA (6.2L - Serial Number 174786 & Below, GM)	2015 - 2015	18-7824-2	872023	8.0L / 8.5 Qt.	5W-30 Full Synthetic

All listed oil capacities are approximate amounts only and may or may not include the oil filter capacity.
ALWAYS follow proper crankcase drain and fill procedures. Check engine dipstick for proper crankcase oil level.

OIL FILTER QUICK-REFERENCE GUIDE

INTERCEPTOR

Model	Year	Oil Filter	Replaces	Crankcase Capacity	Recommended Oil
IV4-80, OV4-80, OV6-100 (Taurus), 80, 85, 100, 110, 120, 140, 190, 200, 210, Interceptor 160, Interceptor 165	1960 & UP	18-7878-1		See Owners Manual	See Owners Manual

KOHLER

Model	Cyl.	Year	Oil Filter	Replaces	Crankcase Capacity	Recommended Oil
4CZ	2	ALL	23-7823	267714	1.4L / 1.48 Qt.	10W-40
4EF	2	ALL	23-7821	359771	1.36L / 1.44 Qt.	
4ESZ	2	ALL	23-7823	267714	Refer to Owners Manual	10W-40
5E	2	ALL	23-7821	359771	1.36L / 1.44 Qt.	
6.5CZ	2	ALL	23-7823	267714	1.4L / 1.48 Qt.	10W-40
6.5ESZ	2	ALL	23-7823	267714	Refer to Owners Manual	10W-40
7.3E	2	ALL	23-7821	359771	1.36L / 1.44 Qt.	10W-40
10EOZ	3	ALL	23-7824	GM47465 252834	5.2L / 5.5 Qt.	15W-40 API CI-4, CI-4 Plus
10EOZD	3	ALL	23-7824 (Variation 1)	GM47465 252834	3.6L / 3.8 Qt.	15W-40 API CI-4, CI-4 Plus
13.5CCOZ	3	ALL	23-7824	GM47465 252834	5.8L / 6.1 Qt.	15W-40 API CI-4, CI-4 Plus
13EOZ	3	ALL	23-7824	GM47465 252834	4.7L / 5.0 Qt.	15W-40 API CI-4, CI-4 Plus
13EOZD	3	ALL	23-7824	GM47465 252834	4.7L / 5.0 Qt.	15W-40 API CI-4, CI-4 Plus
14CCOZ	3	ALL	23-7824	GM47465 252834	Refer to Owners Manual	15W-40 API CI-4, CI-4 Plus
14EOZ	3	ALL	23-7824	GM47465 252834	4.7L / 5.0 Qt.	15W-40 API CI-4, CI-4 Plus
14EOZD	3	ALL	23-7824	GM47465 252834	4.7L / 5.0 Qt.	15W-40 API CI-4, CI-4 Plus
15.5EOZ	3	ALL	23-7824	GM47465 252834	4.7L / 5.0 Qt.	15W-40 API CI-4, CI-4 Plus
15.5EOZD	3	ALL	23-7824	GM47465 252834	4.7L / 5.0 Qt.	15W-40 API CI-4, CI-4 Plus
5CCOZ	3	ALL	23-7822	229678	Refer to Owners Manual	Refer to Owners Manual
5EOZ	3	ALL	23-7822	229678	3.0L / 3.2 Qt.	15W-40 API CI-4, CI-4 Plus
8EOZ	3	ALL	23-7822	229678	2.3L / 2.4 Qt.	15W-40 API CI-4, CI-4 Plus
9CCOZ	3	ALL	23-7824	GM47465 252835	Refer to Owners Manual	Refer to Owners Manual
9EOZ	3	ALL	23-7824	GM47465 252835	Refer to Owners Manual	15W-40 API CI-4, CI-4 Plus
9EOZD	3	ALL	23-7824 (Variation 1)	GM47465 252835	3.6L / 3.8 Qt.	15W-40 API CI-4, CI-4 Plus
10E	4	ALL	23-7803		3.25L / 3.50 Qt.	10W-40
12.5E	4	ALL	23-7803	326817	3.25L / 3.50 Qt.	10W-40
15C	4	ALL	23-7820	279449	4.7L / 5.0 Qt.	10W-40
16CF	4	ALL	23-7820	279449	Refer to Owners Manual	Refer to Owners Manual

OIL FILTER QUICK-REFERENCE GUIDE

KOHLER

Model	Cyl.	Year	Oil Filter	Replaces	Crankcase Capacity	Recommended Oil
18.5CCOZ	4	ALL	23-7824	GM47465 252834	5.8L / 6.1 Qt.	Refer to Owners Manual
20C	4	ALL	23-7820	279449	4.7L / 5.0 Qt.	10W-40
20EOZ	4	ALL	23-7824	GM47465 252834	5.8L / 6.1 Qt.	15W-40 API CI-4, CI-4 Plus
20EOZD	4	ALL	23-7824	GM47465 252834	5.8L / 6.1 Qt.	15W-40 API CI-4, CI-4 Plus
23EOZ	4	ALL	23-7824	GM47465 252834	5.8L / 6.1 Qt.	15W-40 API CI-4, CI-4 Plus
23EOZD	4	ALL	23-7824	GM47465 252834	5.8L / 6.1 Qt.	15W-40 API CI-4, CI-4 Plus
24CCOZ	4	ALL	23-7824	GM47465 252834	5.8L / 6.1 Qt.	Refer to Owners Manual
24EOZ	4	ALL	23-7824	GM47465 252834	5.8L / 6.1 Qt.	15W-40 API CI-4, CI-4 Plus
24EOZD	4	ALL	23-7824	GM47465 252834	5.8L / 6.1 Qt.	15W-40 API CI-4, CI-4 Plus
28EOZ	4	ALL	23-7824	GM47465 252834	10.2L / 10.78 Qt.	15W-40 API CI-4, CI-4 Plus
28EOZD	4	ALL	23-7824	GM47465 252834	10.2L / 10.78 Qt.	15W-40 API CI-4, CI-4 Plus
32EOZ	4	ALL	23-7824	GM47465 252834	10.2L / 10.78 Qt.	15W-40 API CI-4, CI-4 Plus
32EOZD	4	ALL	23-7824	GM47465 252835	10.2L / 10.78 Qt.	15W-40 API CI-4, CI-4 Plus
8E	4	ALL	23-7803	326817	3.25L / 3.50 Qt.	10W-40

LEHMAN

Model	Oil Filter	Replaces	Crankcase Capacity	Recommended Oil
Models (w/ Ford 242), (w/ Ford 254), (w/ Ford 363), (w/ Ford 380), (Lehman 2N50)	18-7875		See Owners Manual	See Owners Manual

MERCURISER

Model	Cyl.	CID/Litre	Year	Oil Filter	Replaces	Crankcase Capacity	Recommended Oil
ALL CYLINDER BLOCKS MANUFACTURED BY GENERAL MOTORS (GM) UNLESS NOTED IN MODEL COLUMN							
Vazer	4	1.6L	2007 - 2010	18-7824-2	35-866340K01, 35-866340Q03	4.02L / 4.25 Qt.	25W-40 FC-W
Vazer	4	1.6L	2011 - Current	18-7824-2	35-866340K01, 35-866340Q03	4.02L / 4.25 Qt.	20W-40 Synthetic Catalyst (1)
60 (Renault)	4	68 / 1.1L	1985 - 1988	----	38463	2.8L / 2.75 Qt.	See Owners Manual
80 (Renault)	4	80 / 1.3L	1986 - 1989	----	----	4.7L / 5.0 Qt.	See Owners Manual
90 (Renault)	4	96 / 1.6L	1970 - 1972	----	----	4.7L / 5.0 Qt.	See Owners Manual
110	4	153 / 2.5L	1963 - 1966	18-7824-2	35-866340K01, 35-866340Q03	3.8L / 4.0 Qt.	See Owners Manual
120	4	153 / 2.5L	1964 - 1986	18-7824-2	35-866340K01, 35-866340Q03	3.8L / 4.0 Qt.	25W-40 FC-W
140	4	181 / 3.0L	1968 - 1986	18-7824-2	35-866340K01, 35-866340Q03	3.8L / 4.0 Qt.	25W-40 FC-W

All listed oil capacities are approximate amounts only and may or may not include the oil filter capacity.
ALWAYS follow proper crankcase drain and fill procedures. Check engine dipstick for proper crankcase oil level.

MERCURISER CONTINUED ON NEXT PAGE

OIL FILTER QUICK-REFERENCE GUIDE

MERCURISER

Model	Cyl.	CID/Litre	Year	Oil Filter	Replaces	Crankcase Capacity	Recommended Oil
165	4	224 / 3.7L	1987	18-7824-2	35-866340K01, 35-866340Q03	5.2L / 5.5 Qt.	25W-40 FC-W
170	4	224 / 3.7L	1985 - 1986	18-7824-2	35-866340K01, 35-866340Q03	5.2L / 5.5 Qt.	25W-40 FC-W
180	4	224 / 3.7L	1987	18-7824-2	35-866340K01, 35-866340Q03	6.1L / 6.5 Qt.	25W-40 FC-W
190	4	224 / 3.7L	1985 - 1986	18-7824-2	35-866340K01, 35-866340Q03	6.1L / 6.5 Qt.	25W-40 FC-W
2.5L	4	153 / 2.5L	1987 - 1989	18-7824-2	35-866340K01, 35-866340Q03	3.8L / 4.0 Qt.	25W-40 FC-W
3.0L / LX	4	181 / 3.0L	1987 - 2010	18-7824-2	35-866340K01, 35-866340Q03	3.8L / 4.0 Qt.	25W-40 FC-W
3.0L MPI EC (Catalyzed)	4	182 / 3.0L, 3.0LX	2011 - 2020	18-7824-2	35-866340K01, 35-866340Q03	3.8L / 4.0 Qt.	20W-40 Synthetic Catalyst (1)
3.7L	4	224 / 3.7L	1988 - 1989	18-7824-2	35-866340K01, 35-866340Q03	5.2L / 5.5 Qt.	25W-40 FC-W
3.7LX	4	224 / 3.7L	1983 - 1989	18-7824-2	35-866340K01, 35-866340Q03	6.1L / 6.5 Qt.	25W-40 FC-W
470	4	224 / 3.7L	1976 - 1984	18-7824-2	35-866340K01, 35-866340Q03	5.2L / 5.5 Qt.	25W-40 FC-W
485	4	224 / 3.7L	1980 - 1982	18-7824-2	35-866340K01, 35-866340Q03	5.4L / 5.75 Qt.	25W-40 FC-W
488	4	224 / 3.7L	1983 - 1984	18-7824-2	35-866340K01, 35-866340Q03	6.1L / 6.5 Qt.	25W-40 FC-W
140	6 IL	194 / 3.2L	1963	18-7876-1	35-99894	4.7L / 5.0 Qt.	25W-40 FC-W
150	6 IL	230 / 3.8L	1964 - 1966	18-7876-1	35-99894	4.7L / 5.0 Qt.	25W-40 FC-W
160	6 IL	250 / 4.1L	1967 - 1969	18-7876-1	35-99894	4.7L / 5.0 Qt.	25W-40 FC-W
165	6 IL	250 / 4.1L	1970 - 1981	18-7876-1	35-99894	4.7L / 5.0 Qt.	25W-40 FC-W
175	V6	262 / 4.3L	1987	18-7879-1*	35-883702	4.3L / 4.5 Qt.	25W-40 FC-W
185	V6	262 / 4.3L	1985 - 1987	18-7879-1*	35-883702	4.3L / 4.5 Qt.	25W-40 FC-W
200	6 IL	292 / 4.8L	1969	18-7876-1	35-99894	5.7L / 6.0 Qt.	25W-40 FC-W
205	V6	262 / 4.3L	1985 - 1987	18-7879-1*	35-883702	4.3L / 4.5 Qt.	25W-40 FC-W
262 Mag EFI	V6	263 / 4.3L	1996 - 1997	18-7879-1*	35-883702	4.3L / 4.5 Qt.	25W-40 FC-W
4.3L / LX / LH / LXH	V6	264 / 4.3L	1988 - 2001	18-7879-1*	35-883702	4.3L / 4.5 Qt.	25W-40 FC-W
4.3L	V6	265 / 4.3L	2002 - 2010	18-7879-1*	35-883702	4.3L / 4.5 Qt.	25W-40 FC-W
4.3L EFI	V6	266 / 4.3L	1998 - 2001	18-7879-1*	35-883702	4.3L / 4.5 Qt.	25W-40 FC-W
4.3L MPI	V6	267 / 4.3L	2002 - 2010	18-7879-1*	35-883702	3.8L / 4.0 Qt.	25W-40 FC-W
4.3L MPI (Catalyzed)	V6	268 / 4.3L	2011 - 2020	18-7824-2	35-866340K01, 35-866340Q03	3.8L / 4.0 Qt.	20W-40 Synthetic Catalyst (1)
*NOTE: V6 engines equipped with the oil filter relocation option will use filter 18-7824-2.							
190	V8	283 / 4.6L	1963 - 1964	18-7824-2	35-866340K01, 35-866340Q03	4.7L / 5.0 Qt.	25W-40 FC-W
198	V8	305 / 5.0L	1977 - 1988	18-7876-1	35-99894	5.7L / 6.0 Qt.	25W-40 FC-W
200	V8	305 / 5.0L	1985 - 1987	18-7824-2	35-866340K01, 35-866340Q03	4.7L / 5.0 Qt.	25W-40 FC-W
215 (Ford)	V8	302 / 5.0L	1970 - 1972	18-7875	35-802886	6.6L / 7.0 Qt.	25W-40 FC-W
225 (Ford)	V8	302 / 5.0L	1973 - 1974	18-7875	35-802886	5.7L / 6.0 Qt.	25W-40 FC-W

MERCURISER CONTINUED ON NEXT PAGE

OIL FILTER QUICK-REFERENCE GUIDE

MERCUISER							
Model	Cyl.	CID/Litre	Year	Oil Filter	Replaces	Crankcase Capacity	Recommended Oil
225	V8	327 / 5.4L	1963 - 1966	18-7824-2	35-866340K01, 35-866340Q03	4.7L / 5.0 Qt.	25W-40 FC-W
225	V8	327 / 5.4L	1967 - 1969	18-7824-2	35-866340K01, 35-866340Q03	6.6L / 7.0 Qt.	25W-40 FC-W
228	V8	305 / 5.0L	1977 - 1978	18-7824-2	35-866340K01, 35-866340Q03	4.7L / 5.0 Qt.	25W-40 FC-W
230	V8	305 / 5.0L	1985 - 1987	18-7824-2	35-866340K01, 35-866340Q03	5.2L / 5.5 Qt.	25W-40 FC-W
233 (Ford)	V8	351 / 5.8L	1975 - 1977	18-7875	35-802886	4.7L / 5.0 Qt.	25W-40 FC-W
233 (Ford) Inboard	V8	351 / 5.8L	1973 - 1976	18-7875	35-802886	6.6L / 7.0 Qt.	25W-40 FC-W
250	V8	327 / 5.4L	1969	18-7876-1	35-99894	6.6L / 7.0 Qt.	25W-40 FC-W
250	V8	327 / 5.4L	1968	18-7876-1	35-99894	5.7L / 6 Qt.	25W-40 FC-W
250	V8	350 / 5.7L	1975 - 1977	18-7876-1	35-99894	4.7L / 5.0 Qt.	25W-40 FC-W
255	V8	350 / 5.7L	1975 - 1977	18-7876-1	35-99894	4.7L / 5.0 Qt.	25W-40 FC-W
255 (Ford)	V8	351 / 5.8L	1973 - 1974	18-7875	35-802886	4.7L / 5.0 Qt.	25W-40 FC-W
255 (Ford) Inboard	V8	351 / 5.8L	1973 - 1976	18-7875	35-802886	6.6L / 7.0 Qt.	25W-40 FC-W
260	V8	350 / 5.7L	1975 - 1987	18-7824-2	35-866340K01, 35-866340Q03	5.2L / 5.5 Qt.	25W-40 FC-W
270	V8	350 / 5.7L	1969 - 1972	18-7876-1	35-99894	6.6L / 7.0 Qt.	25W-40 FC-W
280 TRS	V8	350 / 5.7L	1975 - 1976	18-7876-1	35-99894	6.0L / 6.5 Qt.	25W-40 FC-W
300 Tempest	V8	350 / 5.7L	1985 - 1986	18-7876-1	35-99894	6.0L / 6.5 Qt.	25W-40 FC-W
320 EFI	V8	350 / 5.7L	1987 - 1989	18-7824-2	35-866340K01, 35-866340Q03	6.0L / 6.5 Qt.	25W-40 FC-W
325	V8	427 / 7.0L	1969 - 1972	18-7876-1	35-99894	7.6L / 8.0 Qt.	25W-40 FC-W
325 Inboard	V8	427 / 7.0L	1968 - 1974	18-7824-2	35-866340K01, 35-866340Q03	6.6L / 7.0 Qt.	25W-40 FC-W
330	V8	454 / 7.4L	1977 - 1981	18-7876-1	35-866340K01, 35-866340Q03	5.7L / 6.0 Qt.	25W-40 FC-W
330	V8	454 / 7.4L	1982 - 1987	18-7824-2	35-866340K01, 35-866340Q03	6.6L / 7.0 Qt.	25W-40 FC-W
350 Mag.	V8	350 / 5.7L	1986 - 1997	18-7824-2	35-866340K01, 35-866340Q03	5.2L / 5.5 Qt.	25W-40 FC-W
350 Mag. EFI	V8	350 / 5.7L	1996 - 1997	18-7824-2	35-866340K01, 35-866340Q03	5.2L / 5.5 Qt.	25W-40 FC-W
350 Mag. MPI	V8	350 / 5.7L	1996 - 2001	18-7824-2	35-866340K01, 35-866340Q03	5.2L / 5.5 Qt.	25W-40 FC-W
350 Mag. MPI	V8	350 / 5.7L	2002 - 2010	18-7824-2	35-866340K01, 35-866340Q03	4.25L / 4.5 Qt.	25W-40 FC-W
350 Mag. MPI (Catalyzed)	V8	350 / 5.7L	2011 - Current	18-7824-2	35-866340K01, 35-866340Q03	4.25L / 4.5 Qt.	20W-40 Synthetic Catalyst (1)
370 TRS	V8	454 / 7.4L	1978 - 1987	18-7824-2	35-866340K01, 35-866340Q03	5.7L / 6.0 Qt.	25W-40 FC-W
377 Scorpion	V8	377 / 6.2L	1997 - 2010	18-7824-2		4.7L / 5.0 Qt.	25W-40 FC-W
390	V8	482 / 7.9L	1969 - 1970	18-7876-1	35-99894	7.6L / 8.0 Qt.	25W-40 FC-W
390 Inboard	V8	482 / 7.9L	1969 - 1970	18-7876-1	35-99894	6.6L / 7.0 Qt.	25W-40 FC-W
400 TRS	V8	454 / 7.4L	1978 - 1987	18-7824-2	35-866340K01, 35-866340Q03	6.6L / 7.0 Qt.	25W-40 FC-W

All listed oil capacities are approximate amounts only and may or may not include the oil filter capacity.
ALWAYS follow proper crankcase drain and fill procedures. Check engine dipstick for proper crankcase oil level.

MERCUISER CONTINUED ON NEXT PAGE

OIL FILTER QUICK-REFERENCE GUIDE

MERCUISER							
Model	Cyl.	CID/Litre	Year	Oil Filter	Replaces	Crankcase Capacity	Recommended Oil
420	V8	454 / 7.4L	1987 - 1989	18-7824-2	35-866340K01, 35-866340Q03	5.7L / 6.0 Qt.	25W-40 FC-W
425	V8	454 / 7.4L	1990 - 1993	18-7824-2	35-866340K01, 35-866340Q03	7.6L / 8.0 Qt.	25W-40 FC-W
440 TRS Cyclone	V8	454 / 7.4L	1983 - 1986	18-7876-1	35-99894	6.6L / 7.0 Qt.	25W-40 FC-W
450	V8	454 / 7.4L	1995 - 1996	18-7876-1	35-99894	7.6L / 8.0 Qt.	25W-40 FC-W
454 Mag. Alpha	V8	454 / 7.4L	1986 - 1988	18-7824-2	35-866340K01, 35-866340Q03	6.6L / 7.0 Qt.	25W-40 FC-W
454 Mag.	V8	454 / 7.4L	1989 - 1991	18-7824-2	35-866340K01, 35-866340Q03	7.6L / 8.0 Qt.	25W-40 FC-W
454 Mag.	V8	454 / 7.4L	1992 - 1997	18-7824-2	35-866340K01, 35-866340Q03	6.6L / 7.0 Qt.	25W-40 FC-W
454 Mag. EFI	V8	454 / 7.4L	1994 - 1996	18-7824-2	35-866340K01, 35-866340Q03	6.6L / 7.0 Qt.	25W-40 FC-W
454 Mag. MPI	V8	454 / 7.4L	1996 - 2001	18-7824-2	35-866340K01, 35-866340Q03	6.6L / 7.0 Qt.	25W-40 FC-W
460 TRS	V8	482 / 7.9L	1983 - 1986	18-7876-1	35-99894	9.4L / 10 Qt.	25W-40 FC-W
465	V8	502 / 8.2L	1990 - 1994	18-7824-2	35-866340K01, 35-866340Q03	7.6L / 8.0 Qt.	25W-40 FC-W
496 Mag.	V8	496 / 8.1L	2001 - 2010	18-7824-2	35-866340K01, 35-866340Q03	8.5L / 9.0 Qt.	25W-40 FC-W
496 Mag. HO	V8	496 / 8.1L	2001 - 2010	18-7824-2	35-866340K01, 35-866340Q03	8.5L / 9.0 Qt.	25W-40 FC-W
496 Mag. (Catalyzed)	V8	496 / 8.1L	2011 - 2020	18-7824-2	35-866340K01, 35-866340Q03	8.5L / 9.0 Qt.	20W-40 Synthetic Catalyst (1)
496 Mag. HO (Catalyzed)	V8	496 / 8.1L	2011 - 2020	18-7824-2	35-866340K01, 35-866340Q03	8.5L / 9.0 Qt.	20W-40 Synthetic Catalyst (1)
5.0L	V8	305 / 5.0L	1988 - 1995	18-7824-2	35-866340K01, 35-866340Q03	4.7L / 5.0 Qt.	25W-40 FC-W
5.0L	V8	305 / 5.0L	1998 - 2002	18-7824-2	35-866340K01, 35-866340Q03	5.2L / 5.5 Qt.	25W-40 FC-W
5.0L	V8	305 / 5.0L	2003 - 2010	18-7824-2	35-866340K01, 35-866340Q03	4.25L / 4.5 Qt.	25W-40 FC-W
5.0LX	V8	305 / 5.0L	1988 - 1995	18-7824-2	35-866340K01, 35-866340Q03	5.2L / 5.5 Qt.	25W-40 FC-W
5.0 EFI	V8	305 / 5.0L	1998 - 2001	18-7824-2	35-866340K01, 35-866340Q03	5.2L / 5.5 Qt.	25W-40 FC-W
5.0 MPI	V8	305 / 5.0L	2002 - 2010	18-7824-2	35-866340K01, 35-866340Q03	4.25L / 4.5 Qt.	25W-40 FC-W
5.0 MPI (Catalyzed)	V8	305 / 5.0L	2011 - 2020	18-7824-2	35-866340K01, 35-866340Q03	4.25L / 4.5 Qt.	20W-40 Synthetic Catalyst (1)
5.7L	V8	350 / 5.7L	1978 - 2002	18-7824-2	35-866340K01, 35-866340Q03	5.2L / 5.5 Qt.	25W-40 FC-W
5.7L	V8	350 / 5.7L	2003 - 2010	18-7824-2	35-866340K01, 35-866340Q03	4.25L / 4.5 Qt.	25W-40 FC-W
5.7LX	V8	350 / 5.7L	1996 - 1997	18-7824-2	35-866340K01, 35-866340Q03	5.2L / 5.5 Qt.	25W-40 FC-W
5.7 EFI	V8	350 / 5.7L	1995 - 2001	18-7824-2	35-866340K01, 35-866340Q03	5.2L / 5.5 Qt.	25W-40 FC-W

MERCUISER CONTINUED ON NEXT PAGE

OIL FILTER QUICK-REFERENCE GUIDE

MERCURISER							
Model	Cyl.	CID/Litre	Year	Oil Filter	Replaces	Crankcase Capacity	Recommended Oil
5.7 MPI (Catalyzed)	V8	350 / 5.7L	2011 - 2020	18-7824-2	35-866340K01, 35-866340Q03	4.25L / 4.5 Qt.	25W-40 Synthetic Catalyst
5.7L Black Scorpion Ski	V8	350 / 5.7L	1996 - 1997	18-7824-2	35-866340K01, 35-866340Q04	4.7L / 5.0 Qt.	25W-40 FC-W
5.7L Black Scorpion Ski	V8	351 / 5.7L	1998 - 2001	18-7824-2	35-866340K01, 35-866340Q05	5.2L / 5.5 Qt.	25W-40 FC-W
5.7L Black Scorpion Ski	V8	352 / 5.7L	2002 - 2010	18-7824-2	35-866340K01, 35-866340Q06	4.25L / 4.5 Qt.	25W-40 FC-W
5.7L Black Scorpion Ski (Catalyzed)	V8	352 / 5.7L	2011 - 2020	18-7824-2	35-866340K01, 35-866340Q06	4.25L / 4.5 Qt.	25W-40 Synthetic Catalyst
500	V8	502 / 8.2L	1994 - 1999	18-7824-2	35-866340K01, 35-866340Q03	7.6L / 8.0 Qt.	25W-40 FC-W
500 EFI	V8	502 / 8.2L	1999 - 2005	18-7824-2	35-866340K01, 35-866340Q03	6.6L / 7.0 Qt.	25W-40 FC-W
502 Mag.	V8	502 / 8.2L	1990 - 1993	18-7824-2	35-866340K01, 35-866340Q03	7.6L / 8.0 Qt.	25W-40 FC-W
502 Mag. EFI	V8	502 / 8.2L	1993 - 1995	18-7824-2	35-866340K01, 35-866340Q03	6.6L / 7.0 Qt.	25W-40 FC-W
502 Mag. MPI	V8	502 / 8.2L	1996 - 2001	18-7824-2	35-866340K01, 35-866340Q03	6.6L / 7.0 Qt.	25W-40 FC-W
6.2 MPI (up to OM299999)	V8	377 / 6.2L	2000 - 2002	18-7824-2	35-866340K01, 35-866340Q03	5.2L / 5.5 Qt.	25W-40 FC-W
6.2MPI (OM300000 & up)	V8	377 / 6.2L	2002 - 2010	18-7824-2	35-866340K01, 35-866340Q03	4.25L / 4.5 Qt.	25W-40 FC-W
6.2MPI (OM300000 & up) (Catalyzed)	V8	377 / 6.2L	2011 - 2020	18-7824-2	35-866340K01, 35-866340Q03	4.25L / 4.5 Qt.	25W-40 Synthetic Catalyst
6.2 Black Scorpion (OM391599 & up)	V8	377 / 6.2L	2001 - 2003	18-7824-2	35-866340K01, 35-866340Q03	5.2L / 5.5 Qt.	25W-40 FC-W
6.2 Black Scorpion (OM391599 & up)	V8	377 / 6.2L	2003 - 2010	18-7824-2	35-866340K01, 35-866340Q03	4.25L / 4.5 Qt.	25W-40 FC-W
6.2 Black Scorpion (OM391599 & up) (Catalyzed)	V8	377 / 6.2L	2011 - 2020	18-7824-2	35-866340K01, 35-866340Q03	4.25L / 4.5 Qt.	25W-40 Synthetic Catalyst
7.4L	V8	454 / 7.4L	1988 - 1991	18-7824-2	35-866340K01, 35-866340Q03	7.6L / 8.0 Qt.	25W-40 FC-W
7.4L with Borg Warner	V8	454 / 7.4L	1981 - 1992	18-7824-2	35-866340K01, 35-866340Q03	6.6L / 7.0 Qt.	25W-40 FC-W
7.4L with Hurth	V8	454 / 7.4L	1988 - 1992	18-7824-2	35-866340K01, 35-866340Q03	7.6L / 8.0 Qt.	25W-40 FC-W
7.4L	V8	454 / 7.4L	1992 - 1997	18-7824-2	35-866340K01, 35-866340Q03	6.6L / 7.0 Qt.	25W-40 FC-W
7.4LX TBI	V8	454 / 7.4L	1996 - 1997	18-7824-2	35-866340K01, 35-866340Q03	6.6L / 7.0 Qt.	25W-40 FC-W
7.4LX MPI	V8	454 / 7.4L	1996 - 1997	18-7824-2	35-866340K01, 35-866340Q03	6.6L / 7.0 Qt.	25W-40 FC-W
7.4L MPI	V8	454 / 7.4L	1998 - 2001	18-7824-2	35-866340K01, 35-866340Q03	6.6L / 7.0 Qt.	25W-40 FC-W
8.1L	V8	496 / 8.1L	2001 - 2010	18-7824-2	35-866340K01, 35-866340Q03	8.5L / 9.0 Qt.	25W-40 FC-W
8.1L (Catalyzed)	V8	496 / 8.1L	2011 - 2020	18-7824-2	35-866340K01, 35-866340Q03	8.5L / 9.0 Qt.	20W-40 Synthetic Catalyst (1)

All listed oil capacities are approximate amounts only and may or may not include the oil filter capacity.
ALWAYS follow proper crankcase drain and fill procedures. Check engine dipstick for proper crankcase oil level.

MERCURISER CONTINUED ON NEXT PAGE

OIL FILTER QUICK-REFERENCE GUIDE

MERCURISER

Model	Cyl.	CID/Litre	Year	Oil Filter	Replaces	Crankcase Capacity	Recommended Oil
8.1L HO	V8	496 / 8.1L	2001 - 2010	18-7824-2	35-866340K01, 35-866340Q03	8.5L / 9.0 Qt.	25W-40 FC-W
8.1L HO (Catalyzed)	V8	496 / 8.1L	2011 - 2020	18-7824-2	35-866340K01, 35-866340Q03	8.5L / 9.0 Qt.	20W-40 Synthetic Catalyst (1)
8.2L	V8	502 / 8.2L	1992 - 1996	18-7824-2	35-866340K01, 35-866340Q03	7.6L / 8.0 Qt.	25W-40 FC-W
8.2L Mag. MPI (Catalyzed)	V8	502 / 8.2L	2010 - 2020	18-7824-2	35-866340K01, 35-866340Q04	7.6L / 8.0 Qt.	25W-40 Synthetic Catalyst
8.2L MPI	V8	502 / 8.2L	1996 - 2001	18-7824-2	35-866340K01, 35-866340Q03	6.6L / 7.0 Qt.	25W-40 FC-W
888 (Ford)	V8	302 / 5.0L	1971 - 1977	18-7875	35-802886	5.7L / 6.0 Qt.	25W-40 FC-W
898	V8	305 / 5.0L	1977 - 1984	18-7876-1	35-99894	4.7L / 5.0 Qt.	25W-40 FC-W

MERCURY OUTBOARD

Model	Year	Oil Filter	Replaces	Crankcase Capacity	Recommended Oil
2.5HP / 3.5HP	2006 - 2020	-----		0.30 L / 0.31 Qt.	10W-30 FC-W
4HP / 5HP / 6 HP	1999 - 2020	-----		0.45L / 0.48 Qt.	10W-30 FC-W
8HP (232cc)	1995-2000	18-7901	825467T1, A1	1.0L / 1.05 Qt.	10W-30 FC-W
8HP (323cc)	2001-2004	18-7913	35-822626Q1, Q3, K03	1.0L / 1.05 Qt.	10W-30 FC-W
8HP (209cc)	2005-2020	-----	35-895152, 35-895152002	0.80L / 0.85 Qt.	10W-30 FC-W
9.9HP (232cc)	1995-1998	18-7901	825467T1, A1	1.0L / 1.05 Qt.	10W-30 FC-W
9.9HP (323cc)	1999-2004	18-7913	35-822626Q1, Q3, K03	1.0L / 1.05 Qt.	10W-30 FC-W
9.9HP (209cc)	2005-2020	-----	35-895152, 35-895152002	0.80L / 0.85 Qt.	10W-30 FC-W
15HP (323cc)	1998-2020	18-7913	35-822626Q1, Q3, K03	1.0L / 1.05 Qt.	10W-30 FC-W
20HP (351cc)	2006-2020	18-7913	35-822626Q1, Q3, K03	1.0L / 1.05 Qt.	10W-30 FC-W
25HP (OT800999 and lower.)	1998-2006	18-7914	35-822626Q2, Q04, K04	3.0L / 3.17 Qt.	10W-30 FC-W
25HP (OT801000 and up.)	2006-2011	18-7913	35-822626Q1, Q3, K03	1.8L / 1.90 Qt.	10W-30 FC-W
30HP (OT800999 and lower.)	1999-2006	18-7914	35-822626Q2, Q04, K04	3.0L / 3.17 Qt.	10W-30 FC-W
30HP (OT801000 and up.)	2006-2020	18-7913	35-822626Q1, Q3, K03	1.8L / 1.90 Qt.	10W-30 FC-W
40HP (3 cyl)	1999-2011	18-7914	35-822626Q2, Q04, K04	3.0L / 3.17 Qt.	10W-30 FC-W
40HP (4 cyl)	2001-2011	18-7914	35-822626Q2, Q04, K04	3.0L / 3.17 Qt.	10W-30 FC-W
50HP (996cc)	2001-2011	18-7914	35-822626Q2, Q04, K04	3.0L / 3.17 Qt.	10W-30 FC-W
50HP (935cc)	1995-2000	18-7914	35-822626Q2, Q04, K04	3.0L / 3.17 Qt.	10W-30 FC-W
60HP	2001-2011	18-7914	35-822626Q2, Q04, K04	3.0L / 3.17 Qt.	10W-30 FC-W
75HP Carbureted	2000-2005	18-7914	35-822626Q2, Q04, K04	5.0L / 5.28 Qt.	10W-30 FC-W
75HP EFI (1B366822 & Below)	1999-2006	18-7914	35-822626Q2, Q04, K04	4.5L / 4.80 Qt.	10W-30 FC-W
75HP EFI (1B366822 & Above)	2006-2011	18-7758	35-877761K01	5.0L / 5.28 Qt.	10W-30 FC-W
80HP	2006-UP	18-7914	35-822626Q2, Q04, K04	4.5L / 4.80 Qt.	10W-30 FC-W
90HP Carbureted	2000-2005	18-7914	35-822626Q2, Q04, K04	5.0L / 5.28 Qt.	10W-30 FC-W
90HP EFI (1B366822 & Below)	1999-2006	18-7914	35-822626Q2, Q04, K04	4.5L / 4.80 Qt.	10W-30 FC-W
90HP EFI (1B366822 & Above)	2006-2011	18-7758	35-877761K01	5.0L / 5.28 Qt.	10W-30 FC-W
115HP EFI (1B366822 & Below)	2001-2006	18-7914	35-822626Q2, Q04, K04	5.0L / 5.28 Qt.	10W-30 FC-W
115HP EFI (1B366822 & Above)	2006-2011	18-7758	35-877761K01	5.0L / 5.28 Qt.	10W-30 FC-W
135 Verado L4	2006-2020	18-7921	35-877767K01, 35-877767Q01	6.0L / 6.34 Qt.	25W-40 Synthetic Blend FC-W
150 (4-Stroke)	2011-2020	18-7758	35-877761K01, 35-877761Q01	6.0L/6.34 Qt.	25W-40 Synthetic Blend FC-W
150 Verado L4	2006-2020	18-7921	35-877767K01, 35-877767Q01	6.0L / 6.34 Qt.	25W-40 Synthetic Blend FC-W
175 Verado L4	2006-2020	18-7921	35-877767K01, 35-877767Q01	6.0L / 6.34 Qt.	25W-40 Synthetic Blend FC-W
200 Verado L4	2007-2020	18-7921	35-877767K01, 35-877767Q01	6.0L / 6.34 Qt.	25W-40 Synthetic Blend FC-W
200 Verado L6	2005-2020	18-7918	35-877769K01, 35-877769Q01	7.0L / 7.40 Qt.	25W-40 Synthetic Blend FC-W

MERCURY OUTBOARD CONTINUED ON NEXT PAGE

OIL FILTER QUICK-REFERENCE GUIDE

MERCURY OUTBOARD

Model	Year	Oil Filter	Replaces	Crankcase Capacity	Recommended Oil
225HP EFI	2003-2020	18-7906-1	35-822626T7, Q1S	6.0L / 6.34 Qt.	25W-40 Synthetic Blend FC-W
225 Verado L6	2005-2020	18-7918	35-8777769K01, 35-877769Q01	7.0L / 7.40 Qt.	25W-40 Synthetic Blend FC-W
250 Verado L6	2005-2020	18-7918	35-8777769K01, 35-877769Q01	7.0L / 7.40 Qt.	25W-40 Synthetic Blend FC-W
275 Verado L6	2005-2020	18-7918	35-8777769K01, 35-877769Q01	7.0L / 7.40 Qt.	25W-40 Synthetic Blend FC-W
300 Verado L6	2007-2020	18-7918	35-8777769K01, 35-877769Q01	7.0L / 7.40 Qt.	25W-40 Synthetic Blend FC-W
350 Verado	2015-2020	18-7918	35-8777769K01, 35-877769Q01	7.0L / 7.40 Qt.	25W-40 Synthetic Blend FC-W
400R Verado	2015-2020	18-7918	35-8777769K01, 35-877769Q01	7.0L / 7.40 Qt.	25W-40 Synthetic Blend FC-W

MOHAWK

Model	Year	Oil Filter	Replaces	Crankcase Capacity	Recommended Oil
V8-302, V8-351		18-7875		See Owners Manual	25W-40 FC-W

NISSAN TOHATSU

Model	Year	Oil Filter	Replaces	Crankcase Capacity	Recommended Oil
F2	2006	----	----	300 ml. / 10 oz.	10W-40 FC-W
F2.5	2006 - Current	----	----	300 ml. / 10 oz.	10W-40 FC-W
F3.5	2006 - Current	----	----	300 ml. / 10 oz.	10W-40 FC-W
F4	1999 - Current	----	3H6-07413-0	450 ml. / 16 oz.	10W-40 FC-W
F5	1998 - Current	----	3H6-07413-0	450 ml. / 16 oz.	10W-40 FC-W
F6	2002 - Current	----	3H6-07413-0	450 ml. / 16 oz.	10W-40 FC-W
F8	2003 - Current	----	3V1-07410-1	800 ml. / 27 oz.	10W-40 FC-W
F9.8	2003 - Current	----	3V1-07410-1	800 ml. / 27 oz.	10W-40 FC-W
F9.9	2000 - 2008	18-7911-1	3R007-6150M 3R0-07615-0	1.0L / 1.06 Qt.	10W-40 FC-W
F15	2000 - Current	18-7911-1	3R007-6150M 3R0-07615-0	1.0L / 1.06 Qt.	10W-40 FC-W
F18	2001 - 2006	18-7911-1	3R007-6150M 3R0-07615-0	1.0L / 1.06 Qt.	10W-40 FC-W
F20	2008 - Current	18-7911-1	3R007-6150M 3R0-07615-0	1.0L / 1.06 Qt.	10W-40 FC-W
F25	2002 - Current	18-7911-1	3R007-6150M 3R0-07615-0	1.8L / 1.9 Qt.	10W-40 FC-W
F30	2002 - Current	18-7911-1	3R007-6150M 3R0-07615-0	1.8L / 1.9 Qt.	10W-40 FC-W

NORTHERN LIGHTS

Model	Year	Oil Filter	Replaces	Crankcase Capacity	Recommended Oil
M753		23-7801	140516190	3.5L / 3.7 Qt.	15W-40 API CF or Higher
M753G		23-7801	140516190	3.5L / 3.7 Qt.	15W-40 API CF or Higher
M753K		23-7801	140516190	3.5L / 3.7 Qt.	15W-40 API CF or Higher
M753W		23-7801	140516190	3.5L / 3.7 Qt.	15W-40 API CF or Higher
M753w2		23-7801	140516190	3.5L / 3.7 Qt.	15W-40 API CF or Higher
M773L		23-7801	140516190	4.0L / 4.2 Qt.	15W-40 API CF or Higher
M773LW2		23-7801	140516190	4.9L / 4.75 Qt.	15W-40 API CF or Higher
M773LW3: 9/7Kw		23-7801	140516190	4.9L / 4.75 Qt.	15W-40 API CF or Higher
M843		23-7801	140516190	5.5L / 5.8 Qt.	15W-40 API CF or Higher
M843N		23-7801	140516190	5.5L / 5.8 Qt.	15W-40 API CF or Higher
M843NK		23-7801	140516190	5.5L / 5.8 Qt.	15W-40 API CF or Higher
M843NK2		23-7801	140516190	5.5L / 5.8 Qt.	15W-40 API CF or Higher
M843NW		23-7801	140516190	5.5L / 5.8 Qt.	15W-40 API CF or Higher
M843NW2		23-7801	140516190	5.5L / 5.8 Qt.	15W-40 API CF or Higher
M844		23-7801	140516190	8.2L / 8.66 Qt.	15W-40 API CF or Higher

All listed oil capacities are approximate amounts only and may or may not include the oil filter capacity.
ALWAYS follow proper crankcase drain and fill procedures. Check engine dipstick for proper crankcase oil level.

NORTHERN LIGHTS CONTINUED ON NEXT PAGE

OIL FILTER QUICK-REFERENCE GUIDE

NORTHERN LIGHTS

Model	Year	Oil Filter	Replaces	Crankcase Capacity	Recommended Oil
M844K		23-7801	140516190	8.2L / 8.66 Qt.	15W-40 API CF or Higher
M844L		23-7801	140516190	8.2L / 8.66 Qt.	15W-40 API CF or Higher
M844LK		23-7801	140516190	8.2L / 8.66 Qt.	15W-40 API CF or Higher
M844LW		23-7801	140516190	8.2L / 8.66 Qt.	15W-40 API CF or Higher
M844LW2		23-7801	140516190	8.2L / 8.66 Qt.	15W-40 API CF or Higher
M844W		23-7801	140516190	8.2L / 8.66 Qt.	15W-40 API CF or Higher
M844W2		23-7801	140516190	8.2L / 8.66 Qt.	15W-40 API CF or Higher
M844W3: 16/12KW		23-7801	140516190	8.2L / 8.66 Qt.	15W-40 API CF or Higher
M844W3: 20/16Kw		23-7801	140516190	8.2L / 8.66 Qt.	15W-40 API CF or Higher
M844NK2		23-7801	140516190	8.2L / 8.66 Qt.	15W-40 API CF or Higher
M844LK2		23-7801	140516190	8.2L / 8.66 Qt.	15W-40 API CF or Higher
M844NW2		23-7801	140516190	8.2L / 8.66 Qt.	15W-40 API CF or Higher
M844NW3		23-7801	140516190	8.2L / 8.66 Qt.	15W-40 API CF or Higher
ML844		23-7801	140516190	8.2L / 8.66 Qt.	15W-40 API CF or Higher
ML844K		23-7801	140516190	8.2L / 8.66 Qt.	15W-40 API CF or Higher
ML844L		23-7801	140516190	8.2L / 8.66 Qt.	15W-40 API CF or Higher
ML844LK		23-7801	140516190	8.2L / 8.66 Qt.	15W-40 API CF or Higher
M864K		23-7801	140516190	7.4L / 7.8 Qt.	15W-40 API CF or Higher
M864W		23-7801	140516190	7.4L / 7.8 Qt.	15W-40 API CF or Higher
M864W3: 25/20Kw		23-7801	140516190	7.4L / 7.8 Qt.	15W-40 API CF or Higher
M16C		23-7801	140516190	Refer to Owner's Manual	15W-40 API CF or Higher
M20CL		23-7801	140516190	8.2L / 8.66 Qt.	15W-40 API CF or Higher
M20CR		23-7801	140516190	8.2L / 8.66 Qt.	15W-40 API CF or Higher

OMC

Model	Cyl.	Year	Oil Filter	Replaces	Crankcase Capacity	Recommended Oil
100	4	1972 - 1973	18-7824	502902	3.3L / 3.5 Qt.	25W-40 FC-W
120	4	1965 - 1981	18-7824	502902	3.3L / 3.5 Qt.	25W-40 FC-W
140	4	1973 - 1981	18-7824	502902	3.3L / 3.5 Qt.	25W-40 FC-W
2.3L (Ford)	4	1987 - 1990	18-7875	502900	3.8L / 4.0 Qt.	25W-40 FC-W
2.5L	4	1982 - 1986	18-7824	502902	3.3L / 3.5 Qt.	25W-40 FC-W
3.0L / GL / GS	4	1982 - 1998	18-7824	502902	3.8L / 4.0 Qt.	25W-40 FC-W
165	6	1972 - 1976	18-7876-1	502901	3.8L / 4.0 Qt.	25W-40 FC-W
3.8L	6	1981 - 1985	18-7879-1	502903	3.8L / 4.0 Qt.	25W-40 FC-W
4.3L	6	1985 - 1998	18-7879-1	502903	3.8L / 4.0 Qt.	25W-40 FC-W
4.3 HO (Remote Oil Filter)	6	1989 - 1991	18-7876-1	502901	4.0L / 4.5 Qt.	25W-40 FC-W
175 (Ford)	8	1975 - 1977	18-7875	502900	4.7L / 5.0 Qt.	25W-40 FC-W
185 (Ford)	8	1978 - 1980	18-7875	502900	3.8L / 4.0 Qt.	25W-40 FC-W
190 (Ford)	8	1974 - 1977	18-7875	502900	4.7L / 5.0 Qt.	25W-40 FC-W
200	8	1978 - 1981	18-7876-1	502901	3.8L / 4.0 Qt.	25W-40 FC-W
225	8	1972 - 1978	18-7876-1	502901	4.7L / 5.0 Qt.	25W-40 FC-W
230	8	1978 - 1981	18-7876-1	502901	4.7L / 5.0 Qt.	25W-40 FC-W
235	8	1971 - 1977	18-7876-1	502901	4.7L / 5.0 Qt.	25W-40 FC-W
245	8	1972 - 1975	18-7876-1	502901	4.7L / 5.0 Qt.	25W-40 FC-W
250 (Ford)	8	1979	18-7875	502900	4.7L / 5.0 Qt.	25W-40 FC-W
260	8	1978 - 1981	18-7876-1	502901	4.7L / 5.0 Qt.	25W-40 FC-W
262 King Cobra	8	1989	18-7876-1	502901	3.8L / 4.0 Qt.	25W-40 FC-W
350 King Cobra	8	1986 - 1989	18-7876-1	502901	4.7L / 5.0 Qt.	25W-40 FC-W
351 EFI	8	1994 - 1995	18-7875	502900	3.8L / 4.0 Qt.	25W-40 FC-W

OMC CONTINUED ON NEXT PAGE

OIL FILTER QUICK-REFERENCE GUIDE

OMC						
Model	Cyl.	Year	Oil Filter	Replaces	Crankcase Capacity	Recommended Oil
351 King	8	1992	18-7875	502900	4.7L / 5.0 Qt.	25W-40 FC-W
351 King	8	1993	18-7875	502900	3.8L / 4.0 Qt.	25W-40 FC-W
454 HO	8	1991 - 1993	18-7876-1	502901	5.7L / 6.0 Qt.	25W-40 FC-W
454 King Cobra	8	1989 - 1990	18-7876-1	502901	5.7L / 6.0 Qt.	25W-40 FC-W
460 King Cobra	8	1986 - 1989	18-7878-1	502904	5.7L / 6.0 Qt.	25W-40 FC-W
5.0L	8	1986-1996, 1998	18-7876-1	502901	4.7L / 5.0 Qt.	25W-40 FC-W
5.0L EFI (Ford)	8	1993 - 1996	18-7875	502900	4.7L / 5.0 Qt.	25W-40 FC-W
502 King Cobra (8.2L)	8	1992 - 1993	18-7876-1	502901	5.7L / 6.0 Qt.	25W-40 FC-W
5.7L	8	1982 - 1985	18-7876-1	502901	5.7L / 6.0 Qt.	25W-40 FC-W
5.7L / GL / Gi	8	1986 - 1998	18-7876-1	502901	4.7L / 5.0 Qt.	25W-40 FC-W
5.8L (Ford)	8	1989 - 1991	18-7875	502900	4.7L / 5.0 Qt.	25W-40 FC-W
5.8L (Ford) / FL / EFI	8	1992 - 1995	18-7875	502900	3.8L / 4.0 Qt.	25W-40 FC-W
5.8L HO EFI	8	1995	18-7875	502900	3.8L / 4.0 Qt.	25W-40 FC-W
7.4L / GL	8	1988, 1991-1998	18-7876-1	502901	5.7L / 6.0 Qt.	25W-40 FC-W
7.4L Gi	8	1996 - 1998	18-7876-1	502901	7.6L / 8.0 Qt.	25W-40 FC-W
7.5L (Ford)	8	1987 - 1990	18-7878-1	502904	4.7L / 5.0 Qt.	25W-40 FC-W
8.2L	8	1984 - 1985	18-7876-1	502901	5.7L / 6.0 Qt.	25W-40 FC-W
8.2L GSi	8	1998	18-7876-1	502901	7.6L / 8.0 Qt.	25W-40 FC-W
ONAN						
Model	Year	Oil Filter	Replaces	Crankcase Capacity	Recommended Oil	
MDKAU		23-7804	185-744	2.1L / 2.2 Qt.	15W-40 API CF or Higher	
MDKAV		23-7842	185-5835	4.0L / 4.2 Qt.	15W-40 API CF or Higher	
MDKBG		23-7842	185-5835	4.0L / 4.2 Qt.	15W-40 API CF or Higher	
MDKAW (Spacesaver)		23-7842	185-5835	4.3L / 4.5 Qt.	15W-40 API CF or Higher	
MDKAZ		23-7842	185-5835	4.3L / 4.5 Qt.	15W-40 API CF or Higher	
MDKBD		23-7840	122-0810	7.6L / 8.0 Qt.	15W-40 API CF or Higher	
MDKBE		23-7840	122-0810	7.6L / 8.0 Qt.	15W-40 API CF or Higher	
MDKBF		23-7840	122-0810	12L / 12.7 Qt.	15W-40 API CF or Higher	
MDKBD (w/ Isolated Ground)		23-7840	122-0810	7.6L / 8.0 Qt.	15W-40 API CF or Higher	
MDKBE (w/ Isolated Ground)		23-7840	122-0810	7.6L / 8.0 Qt.	15W-40 API CF or Higher	
MDKBF (w/ Isolated Ground)		23-7840	122-0810	12L / 12.7 Qt.	15W-40 API CF or Higher	
MDKBH		23-7804	185-744	2.1L / 2.2 Qt.	15W-40 API CF or Higher	
MDJB		23-7841	122-0185	3.3L / 3.5 Qt.	15W-40 API CF or Higher	
MDJC		23-7841	122-0185	6.2L / 6.5 Qt.	15W-40 API CF or Higher	
MDJE		23-7841	122-0185	3.3L / 3.5 Qt.	15W-40 API CF or Higher	
MDJF		23-7841	122-0185	6.2L / 6.5 Qt.	15W-40 API CF or Higher	
MJA		23-7841	122-0185	Refer to Owners Manual	15W-40 API CF or Higher	
MJB		23-7841	122-0185	Refer to Owners Manual	15W-40 API CF or Higher	
MJC		23-7841	122-0185	Refer to Owners Manual	15W-40 API CF or Higher	
MDKAD/E/F		23-7840	122-0810	7.6L / 8.0 Qt.	15W-40 API CF or Higher	
MDKAL/A/B		23-7842	185-5835	4.0L / 4.2 Qt.	15W-40 API CF or Higher	
PCM PLEASURECRAFT						
Model	Year	Oil Filter	Replaces	Crankcase Capacity	Recommended Oil	
200		18-7875	R077001	Refer to Owners Manual	Refer to Owners Manual	
220		18-7875	R077001	Refer to Owners Manual	Refer to Owners Manual	
8200		18-7875	R077001	Refer to Owners Manual	Refer to Owners Manual	
8240		18-7875	R077001	Refer to Owners Manual	Refer to Owners Manual	

All listed oil capacities are approximate amounts only and may or may not include the oil filter capacity. ALWAYS follow proper crankcase drain and fill procedures. Check engine dipstick for proper crankcase oil level.

PCM PLEASURECRAFT CONTINUED ON NEXT PAGE

OIL FILTER QUICK-REFERENCE GUIDE

PCM PLEASURECRAFT

Model	Year	Oil Filter	Replaces	Crankcase Capacity	Recommended Oil
230		18-7824	R077002	Refer to Owners Manual	Refer to Owners Manual
280		18-7824	R077002	Refer to Owners Manual	Refer to Owners Manual
300		18-7824	R077002	Refer to Owners Manual	Refer to Owners Manual
350		18-7824	R077002	Refer to Owners Manual	Refer to Owners Manual
5.0L MPI (Remote Oil Filter)	2007 & Older	18-7875	R077001	3.8L / 4.0 Qt.	15W-40 API SL or Higher
5.7L MPI (Remote Oil Filter)	2007 & Older	18-7875	R077001	3.8L / 4.0 Qt.	15W-40 API SL or Higher
6.0L MPI (Remote Oil Filter)	2007 & Older	18-7875	R077001	4.75L / 5.0 Qt.	15W-40 API SL or Higher
5.0L MPI (Serial 473065 & UP) (Remote Oil Filter)	2007 - 2009	18-7875	R077001	3.8L / 4.0 Qt.	15W-40 API SL or Higher
EX 343 (Serial 473065 & UP) (Remote Oil Filter)	2007 - 2012	18-7875	R077001	3.8L / 4.0 Qt.	15W-40 API SL or Higher
ZR6 390 (Serial 470365 & UP) (Remote Oil Filter)	2007	18-7875	R077001	4.75L / 5.0 Qt.	15W-40 API SL or Higher
5.0L Pro Sport Catanium™ CES (Remote Oil Filter)	2008 - 2010	18-7875	R077001	4.5L / 4.75 Qt.	15W-40 API SM or Higher
5.7L EX343 Catanium™ CES (Remote Oil Filter)	2008 - 2016	18-7875	R077001	4.5L / 4.75 Qt.	*Below 50° 5W-30 Semi-Synth Above 50° 15W-40 SM or Higher*
6.0L ZR-409 Catanium™ CES (Remote Oil Filter)	2011 - 2016	18-7875	R077001	4.75L / 5.0 Qt.	15W-40 API SM or Higher
6.0L MPI - ZR409 (Remote Oil Filter)	2009 - 2010	18-7875	R077001	4.75L / 5.0 Qt.	15W-40 API SM or Higher
H0303 MPI	2010 - Older	18-7875	R077001	3.8L / 4.0 Qt. (Starting Amount)	15W-40 API SM or Higher
H0303 Catanium™ CES	2011 - 2016	18-7875	R077001	3.8L / 4.0 Qt. (Starting Amount)	*Below 50° 5W-30 Semi-Synth Above 50° 15W-40 SM or Higher*
ZR450 Catanium™ CES	2011 - 2012	18-7875	R077001	3.8L / 4.0 Qt. (Starting Amount)	15W-40 API SM or Higher
ZR550 6.2L MPI	2011 - 2012	18-7875	R077001	3.8L / 4.0 Qt. (Starting Amount)	5W-30 Full Synthetic

SUZUKI

Model	Year	Oil Filter	Replaces	Crankcase Capacity	Recommended Oil
DF9.9A	2011 - 2020	18-7903	16510-05240	0.8L / 0.85 Qt.	10W-40 Synthetic Blend FC-W
DF9.9-DF15 (9.9 hp. serial 110001 and below)	1996 - 2010	18-7903	16510-05240 16510-45H10	1.0 L / 1.1 Qt.	10W-40 Synthetic Blend FC-W
DF9.9T / DF9.9TH / DF9.9B	2011 - 2020	18-8870	16510-45H10	1.0 L / 1.1 Qt.	10W-40 Synthetic Blend FC-W
DF15 / DF15A	2011 - 2020	18-8870	16510-45H10	1.0 L / 1.1 Qt.	10W-40 Synthetic Blend FC-W
DF20A	2011 - 2020	18-8870	16510-45H10	1.0 L / 1.1 Qt.	10W-40 Synthetic Blend FC-W
DF25	2000 - 2006	18-7915-1	16510-87J00	3.0 L / 3.2 Qt.	10W-40 Synthetic Blend FC-W
DF25 V-Twin	2006 - 2010	18-7915-1	16510-87J00	1.5L / 1.6 Qt.	10W-40 Synthetic Blend FC-W
DF25A	2011 - 2020	18-7915-1	16510-87J00	3.0 L / 3.2 Qt.	10W-40 Synthetic Blend FC-W
DF30	2000 - 2007	18-7915-1	16510-87J00	3.0 L / 3.2 Qt.	10W-40 Synthetic Blend FC-W
DF30A	2011 - 2020	18-7915-1	16510-87J00	3.0 L / 3.2 Qt.	10W-40 Synthetic Blend FC-W
DF40	1999 - 2010	18-7915-1	16510-87J00	2.2 L / 2.3 Qt.	10W-40 Synthetic Blend FC-W
DF40A	2011 - 2020	18-7915-1	16510-87J00	2.7 L / 3.0 Qt.	10W-40 Synthetic Blend FC-W
DF50	1999 - 2010	18-7915-1	16510-87J00	2.2 L / 2.3 Qt.	10W-40 Synthetic Blend FC-W
DF50A	2011 - 2020	18-7915-1	16510-87J00	2.7 L / 3.0 Qt.	10W-40 Synthetic Blend FC-W
DF60	1998 - 2009	18-7915-1	16510-87J00	4.5 L / 4.8 Qt.	10W-40 Synthetic Blend FC-W
DF70	1998 - 2009	18-7915-1	16510-87J00	4.5 L / 4.8 Qt.	10W-40 Synthetic Blend FC-W
DF60A	2010	18-7915-1	16510-87J00	2.7 L / 3.0 Qt.	10W-40 Synthetic Blend FC-W
DF70A	2009 - 2010	18-7896	16510-61A20-MHL	4.2 L / 4.0 Qt.	10W-40 Synthetic Blend FC-W
DF80A	2009 - 2010	18-7896	16510-61A20-MHL	4.2 L / 4.0 Qt.	10W-40 Synthetic Blend FC-W
DF90A	2009 - 2010	18-7896	16510-61A20-MHL	4.2 L / 4.0 Qt.	10W-40 Synthetic Blend FC-W
DF90	2001 - 2008	18-7896	16510-61A20-MHL	5.5 L / 5.8 Qt.	10W-40 Synthetic Blend FC-W
DF115	2001 - 2010	18-7896	16510-61A20-MHL	5.5 L / 5.8 Qt.	10W-40 Synthetic Blend FC-W
DF140	2002 - 2010	18-7897	16510-82703	5.5 L / 5.8 Qt.	10W-40 Synthetic Blend FC-W
DF150-DF175	2006 - 2010	18-7905	16510-96J00	8.0 L / 8.5 Qt.	10W-40 Synthetic Blend FC-W

All listed oil capacities are approximate amounts only and may or may not include the oil filter capacity.
ALWAYS follow proper crankcase drain and fill procedures. Check engine dipstick for proper crankcase oil level.

SUZUKI CONTINUED ON NEXT PAGE

OIL FILTER QUICK-REFERENCE GUIDE

SUZUKI						
Model	Year	Oil Filter	Replaces	Crankcase Capacity	Recommended Oil	
DF200 / DF225 / DF250	2004 - 2010	18-7905	16510-96J00	8.0 L / 8.5 Qt.	10W-40 Synthetic Blend FC-W	
DF300	2007 - 2010	18-7905	16510-96J00	8.0 L / 8.5 Qt.	10W-40 Synthetic Blend FC-W	
DF300A	2011 - 2020	18-7905-1	16510-96J10	8.0 L / 8.5 Qt.	10W-40 Synthetic Blend FC-W	
DF300B	2017 - 2020	18-7905-1	16510-96J10	7.8L / 8.2 Qt.	10W-40 Synthetic Blend FC-W	
DF350A	2018 - 2020	18-7905-1	16510-96J10	7.8L / 8.2 Qt.	10W-40 Synthetic Blend FC-W	
VOLVO GASOLINE						
Model	Cyl.	Year	Oil Filter	Replaces	Crankcase Capacity	Recommended Oil
230 A/B	4	1989 - 1993	18-7878-1	3517857	4.5L / 4.75 Qt.	10W-40 FC-W
250 A/B	4	1989 - 1993	18-7878-1	3517857	4.5L / 4.75 Qt.	10W-40 FC-W
251A	4	1989 - 1992	18-7878-1	3517857	4.5L / 4.75 Qt.	10W-40 FC-W
3.0L	4	1993 - Current	18-7824	835440	3.8L / 4.0 Qt.	Synthetic SAE 30 (1)
AQ100	4	1961 - 1963	18-7878-1	3517857	3.8L / 4.0 Qt.	10W-40 FC-W
AQ110	4	1963 - 1966	18-7878-1	3517857	3.8L / 4.0 Qt.	10W-40 FC-W
AQ115 A/B	4	1969 - 1975	18-7878-1	3517857	3.8L / 4.0 Qt.	10W-40 FC-W
AQ120 A/B	4	1966 - 1980	18-7878-1	3517857	3.8L / 4.0 Qt.	10W-40 FC-W
AQ125 A/B	4	1981 - 1985	18-7878-1	3517857	4.2L / 4.5 Qt.	10W-40 FC-W
AQ130 A/B/C/D	4	1968 - 1977	18-7878-1	3517857	3.8L / 4.0 Qt.	10W-40 FC-W
AQ131 A/B/C/D	4	1985 - 1989	18-7878-1	3517857	3.8L / 4.0 Qt.	10W-40 FC-W
AQ140A	4	1975 - 1979	18-7878-1	3517857	3.8L / 4.0 Qt.	10W-40 FC-W
AQ145 A/B	4	1979 - 1985	18-7878-1	3517857	4.2L / 4.5 Qt.	10W-40 FC-W
AQ151 A/B/C	4	1985 - 1989	18-7878-1	3517857	3.8L / 4.0 Qt.	10W-40 FC-W
AQ170 A/B/C	4	1969 - 1980	18-7878-1	3517857	3.8L / 4.0 Qt.	10W-40 FC-W
AQ171 A/C	4	1986 - 1989	18-7878-1	3517857	3.8L / 4.0 Qt.	10W-40 FC-W
AD60F	4	1962 - 1968	18-7878-1	3517857	Check Owners Manual	10W-40 FC-W
AQ90	4	1962 - 1964	18-7878-1	3517857	3.8L / 4.0 Qt.	10W-40 FC-W
AQ95 /A	4	1964 - 1966	18-7878-1	3517857	3.8L / 4.0 Qt.	10W-40 FC-W
BB100	4	1963 - 1969	18-7878-1	3517857	Check Owners Manual	10W-40 FC-W
BB115 A/B/C	4	1969 - 1977	18-7878-1	3517857	Check Owners Manual	10W-40 FC-W
BB140A	4	1975 - 1979	18-7878-1	3517857	Check Owners Manual	10W-40 FC-W
BB145A	4	1979 - 1985	18-7878-1	3517857	Check Owners Manual	10W-40 FC-W
BB165A	4	1965 - 1969	18-7878-1	3517857	Check Owners Manual	10W-40 FC-W
BB170 A/B/C	4	1969 - 1978	18-7878-1	3517857	Check Owners Manual	10W-40 FC-W
BB30	4	1963 - 1969	18-7878-1	3517857	Check Owners Manual	10W-40 FC-W
MB10A	4	1971 - 1977	18-7878-1	3517857	Check Owners Manual	10W-40 FC-W
MB20 A/B/C	4	1969 - 1980	18-7878-1	3517857	Check Owners Manual	10W-40 FC-W
4.3L	V6	1993 - 2006	18-7879-1	841750	4.2L / 4.5 Qt.	Synthetic SAE 30 (1)
4.3L	V6	2007 - Current	18-8003-1	8692305	4.7L / 5.0 Qt.	Synthetic SAE 30 (1)
430 A/B	V6	1990 - 1992	18-7879-1	841750	4.2L / 4.5 Qt.	10W-40 FC-W
431 A/B	V6	1989 - 1992	18-7879-1	841750	4.2L / 4.5 Qt.	10W-40 FC-W
432A/B	V6	1992 - 1998	18-7879-1	841750	4.2L / 4.5 Qt.	10W-40 FC-W
434A/B	V6	1992 - 1997	18-7879-1	841750	4.2L / 4.5 Qt.	10W-40 FC-W
AQ175A	V6	1981 - 1985	18-7879-1	841750	6.0L / 6.5 Qt.	10W-40 FC-W
AQ205A	V6	1988 - 1989	18-7879-1	841750	6.0L / 6.5 Qt.	10W-40 FC-W
5.0L (Ford)	V8	1993 - 1999	18-7875	835779	5.7L / 6.0 Qt.	Synthetic SAE 30 (1)
5.0L (GM)	V8	1997 - 2006	18-7824	835440	5.7L / 6.0 Qt.	Synthetic SAE 30 (1)
5.0L (GM)	V8	2007 - Current	18-8003-1	8692305	5.2L / 5.5 Qt.	Synthetic SAE 30 (1)
5.7L	V8	1993 - 2006	18-7824	835440	5.7L / 6.0 Qt.	Synthetic SAE 30 (1)
5.7L	V8	2007 - Current	18-8003-1	8692305	5.2L / 5.5 Qt.	Synthetic SAE 30 (1)

VOLVO GASOLINE CONTINUED ON NEXT PAGE

OIL FILTER QUICK-REFERENCE GUIDE

VOLVO GASOLINE

Model	Cyl.	Year	Oil Filter	Replaces	Crankcase Capacity	Recommended Oil
5.8L	V8	1993 - 1996	18-7875	835779	5.7L / 6.0 Qt.	Synthetic SAE 30 (1)
500 A/B	V8	1989 - 1993	18-7824	835440	5.7L / 6.0 Qt.	10W-40 FC-W
501 A/B	V8	1989 - 1993	18-7824	835440	5.7L / 6.0 Qt.	10W-40 FC-W
570 A/MS4A	V8	1989 - 1993	18-7824	835440	5.7L / 6.0 Qt.	10W-40 FC-W
571A	V8	1989 - 1992	18-7824	835440	5.7L / 6.0 Qt.	10W-40 FC-W
572A	V8	1991 - 1993	18-7824	835440	5.7L / 6.0 Qt.	10W-40 FC-W
7.4L	V8	1993 - 2000	18-7876-1	3850559	6.6L / 7.0 Qt.	Synthetic SAE 30 (1)
740 A/B	V8	1992 - 1993	18-7876-1	3850559	6.6L / 7.0 Qt.	10W-40 FC-W
8.1L	V8	1999 - 2006	18-7824	835440	8.0L / 8.5 Qt.	Synthetic SAE 30 (1)
8.1L	V8	2007 - Current	18-8003-1	8692305	8.0L / 8.5 Qt.	Synthetic SAE 30 (1)
8.2L	V8	1993 - 2000	18-7876-1	3850559	6.6L / 7.0 Qt.	Synthetic SAE 30 (1)
AQ190A	V8	1976 - 1977	18-7875	835779	4.0L / 4.2 Qt.	10W-40 FC-W
AQ211A	V8	1986 - 1989	18-7824	835440	4.0L / 4.2 Qt.	10W-40 FC-W
AQ225 B/C/D/E/F	V8	1973 - 1976	18-7824	835440	4.4L / 4.7 Qt.	10W-40 FC-W
AQ231A	V8	1986 - 1989	18-7824	835440	4.4L / 4.7 Qt.	10W-40 FC-W
AQ231B	V8	1987 - 1989	18-7824	835440	4.4L / 4.7 Qt.	10W-40 FC-W
AQ240A	V8	1976 - 1977	18-7875	835779	4.4L / 4.7 Qt.	10W-40 FC-W
AQ255 A/B	V8	1977 - 1978	18-7824	835440	5.7L / 6.0 Qt.	10W-40 FC-W
AQ260 A/B	V8	1979 - 1986	18-7824	835440	5.7L / 6.0 Qt.	10W-40 FC-W
AQ271 A/B/C/D	V8	1986 - 1989	18-7824	835440	5.4L / 5.7 Qt.	10W-40 FC-W
AQ280A	V8	1978 - 1979	18-7824	835440	5.4L / 5.7 Qt.	10W-40 FC-W
AQ290A	V8	1979 - 1985	18-7824	835440	5.4L / 5.7 Qt.	10W-40 FC-W
AQ311 A/B	V8	1986 - 1987	18-7824	835440	5.4L / 5.7 Qt.	10W-40 FC-W
BB225 A/B/C	V8	1973 - 1977	18-7824	835440	4.4L / 4.7 Qt.	10W-40 FC-W
BB231A	V8	1987	18-7824	835440	4.4L / 4.7 Qt.	10W-40 FC-W
BB260 A/B/C	V8	1978 - 1987	18-7824	835440	5.7L / 6.0 Qt.	10W-40 FC-W
BB261A	V8	1988 - 1989	18-7824	835440	5.7L / 6.0 Qt.	10W-40 FC-W

VOLVO DIESEL

Model	Cyl.	Year	Oil Filter	Replaces	Crankcase Capacity	Recommended Oil
2001 / B	1	1984 - 1993	18-7884	834337	1.4L / 1.5 Qt.	15W-40 VDS-2 or VDS-3 / API CI-4 or higher
MD1B	1	1970 - 1973	18-7884	834337	1.5L / 1.8 Qt.	15W-40 VDS-2 or VDS-3 / API CI-4 or higher
MD5A / B / C	1	1975 - 1982	18-7884	834337	2.0L / 2.10 Qt.	15W-40 VDS-2 or VDS-3 / API CI-4 or higher
2002 / B	2	1983 - 1993	18-7884	834337	2.75L / 2.9 Qt.	15W-40 VDS-2 or VDS-3 / API CI-4 or higher
AQD2B	2	1972 - 1975	18-7884	834337	See Owners Manual	15W-40 VDS-2 or VDS-3 / API CI-4 or higher
MD11C / D	2	1975 - 1983	18-7884	834337	2.6L / 2.7 Qt.	15W-40 VDS-2 or VDS-3 / API CI-4 or higher
MD2	2	1964 - 1967	18-7884	834337	See Owners Manual	15W-40 VDS-2 or VDS-3 / API CI-4 or higher
MD2B	2	1970 - 1975	18-7884	834337	2.6L / 2.7 Qt.	15W-40 VDS-2 or VDS-3 / API CI-4 or higher
MD6A / B	2	1971 - 1976	18-7884	834337	2.8L / 2.9 Qt.	15W-40 VDS-2 or VDS-3 / API CI-4 or higher
MD7A / B	2	1976 - 1983	18-7884	834337	2.8L / 2.9 Qt.	15W-40 VDS-2 or VDS-3 / API CI-4 or higher
2003 / B / TB	3	1983 - 1993	18-7884	834337	4.1L / 4.3 Qt.	15W-40 VDS-2 or VDS-3 / API CI-4 or higher
MD17C / D	3	1975 - 1984	18-7884	834337	4.2L / 4.4 Qt.	15W-40 VDS-2 or VDS-3 / API CI-4 or higher
MD3B	3	1971 - 1975	18-7884	834337	4.8L / 5.8 Qt.	15W-40 VDS-2 or VDS-3 / API CI-4 or higher
AD31A / L-A / P-A / D / X	4	1986 - 2004	18-7878-1	3517857	8.5L / 9.0 Qt.	15W-40 VDS-2 or VDS-3 / API CI-4 or higher
AQAD30A	4	1983 - 1986	18-7878-1	3517857	8.5L / 9.0 Qt.	15W-40 VDS-2 or VDS-3 / API CI-4 or higher
AQAD31A	4	1986 - 1989	18-7878-1	3517857	8.5L / 9.0 Qt.	15W-40 VDS-2 or VDS-3 / API CI-4 or higher
AQD21A / B	4	1969 - 1981	18-7974	3827069	5.5L / 5.8 Qt.	15W-40 VDS-2 or VDS-3 / API CI-4 or higher
D4-180B / C / D / E	4	2005 - Current	18-0035	3582732 Full Flow	12.5L / 13.2 Qt.	15W-40 VDS-2 or VDS-3 / API CI-4 or higher

All listed oil capacities are approximate amounts only and may or may not include the oil filter capacity. ALWAYS follow proper crankcase drain and fill procedures. Check engine dipstick for proper crankcase oil level.

VOLVO DIESEL CONTINUED ON NEXT PAGE

OIL FILTER QUICK-REFERENCE GUIDE

VOLVO DIESEL						
Model	Cyl.	Year	Oil Filter	Replaces	Crankcase Capacity	Recommended Oil
D4-180iB / C / D / E	4	2005 - Current	18-0036	3582733 Bypass	12.5L / 13.2 Qt.	15W-40 VDS-2 or VDS-3 / API Ci-4 or higher
D4-210A-A / A-B	4	2003 - 2006	18-0035	3582732 Full Flow	12.5L / 13.2 Qt.	15W-40 VDS-2 or VDS-3 / API Ci-4 or higher
D4-210A-A / B	4	2003 - 2006	18-0036	3582733 Bypass	12.5L / 13.2 Qt.	15W-40 VDS-2 or VDS-3 / API Ci-4 or higher
D4-210i-A / B	4	2003 - 2006	18-0035	3582732 Full Flow	12.5L / 13.2 Qt.	15W-40 VDS-2 or VDS-3 / API Ci-4 or higher
D4-210i-A / B	4	2003 - 2006	18-0036	3582733 Bypass	12.5L / 13.2 Qt.	15W-40 VDS-2 or VDS-3 / API Ci-4 or higher
D4-225A-B	4	2005 - 2008	18-0035	3582732 Full Flow	12.5L / 13.2 Qt.	15W-40 VDS-2 or VDS-3 / API Ci-4 or higher
D4-225A-B	4	2005 - 2008	18-0036	3582733 Bypass	12.5L / 13.2 Qt.	15W-40 VDS-2 or VDS-3 / API Ci-4 or higher
D4-225i-B	4	2005 - 2008	18-0035	3582732 Full Flow	12.5L / 13.2 Qt.	15W-40 VDS-2 or VDS-3 / API Ci-4 or higher
D4-225i-B	4	2005 - 2008	18-0036	3582733 Bypass	12.5L / 13.2 Qt.	15W-40 VDS-2 or VDS-3 / API Ci-4 or higher
D4-260A-A / A-B / D-B	4	2004 - 2008	18-0036	3582733 Bypass	12.5L / 13.2 Qt.	15W-40 VDS-2 or VDS-3 / API Ci-4 or higher
D4-260A-A / A-B / D-B (IPS)	4	2004 - 2008	18-0035	3582732 Full Flow	12.5L / 13.2 Qt.	15W-40 VDS-2 or VDS-3 / API Ci-4 or higher
D4-260i-A / B	4	2004 - 2008	18-0035	3582732 Full Flow	12.5L / 13.2 Qt.	15W-40 VDS-2 or VDS-3 / API Ci-4 or higher
D4-260i-A / B	4	2004 - 2008	18-0036	3582733 Bypass	12.5L / 13.2 Qt.	15W-40 VDS-2 or VDS-3 / API Ci-4 or higher
D4-300A-A / A-E / D-A	4	2007 - Current	18-0035	3582732 Full Flow	12.5L / 13.2 Qt.	15W-40 VDS-2 or VDS-3 / API Ci-4 or higher
D4-300A-A / A-E / D-A	4	2007 - Current	18-0036	3582733 Bypass	12.5L / 13.2 Qt.	15W-40 VDS-2 or VDS-3 / API Ci-4 or higher
D4-300i-A / C / D	4	2007 - 2010	18-0035	3582732 Full Flow	12.5L / 13.2 Qt.	15W-40 VDS-2 or VDS-3 / API Ci-4 or higher
D4-300i-A / C / D	4	2007 - 2010	18-0036	3582733 Bypass	12.5L / 13.2 Qt.	15W-40 VDS-2 or VDS-3 / API Ci-4 or higher
KAD32P	4	1997 - 2005	18-7926		8.5L / 9.0 Qt.	15W-40 VDS-2 or VDS-3 / API Ci-4 or higher
MD21A / B	4	1969 - 1981	18-7974	3827069	5.5L / 5.8 Qt.	15W-40 VDS-2 or VDS-3 / API Ci-4 or higher
MD30A	4	1983 - 1986	18-7878-1	3517857	8.5L / 9.0 Qt.	15W-40 VDS-2 or VDS-3 / API Ci-4 or higher
MD31A	4	1986 - 1994	18-7878-1	3517857	8.5L / 9.0 Qt.	15W-40 VDS-2 or VDS-3 / API Ci-4 or higher
TAMD30A	4	1983 - 1986	18-7878-1	3517857	8.5L / 9.0 Qt.	15W-40 VDS-2 or VDS-3 / API Ci-4 or higher
TAMD31B / D / PL	4	1989 - 2003	18-7878-1	3517857	8.5L / 9.0 Qt.	15W-40 VDS-2 or VDS-3 / API Ci-4 or higher
TMD30A	4	1983 - 1986	18-7878-1	3517857	8.5L / 9.0 Qt.	15W-40 VDS-2 or VDS-3 / API Ci-4 or higher
TMD31A / B / D	4	1986 - 1994	18-7878-1	3517857	8.5L / 9.0 Qt.	15W-40 VDS-2 or VDS-3 / API Ci-4 or higher
TMD31L-A	4	1994 - 1997	18-7878-1	3517857	8.5L / 9.0 Qt.	15W-40 VDS-2 or VDS-3 / API Ci-4 or higher
D3-110i-A / B / C	5	2004 - 2006	18-8003-1	8692305	5.65L / 6.0 Qt.	15W-40 VDS-2 or VDS-3 / API Ci-4 or higher
D3-130A-A / A-B	5	2005 - 2006	18-8003-1	8692305	5.65L / 6.0 Qt.	15W-40 VDS-2 or VDS-3 / API Ci-4 or higher
D3-130i-A / B / C	5	2004 - 2006	18-8003-1	8692305	5.65L / 6.0 Qt.	15W-40 VDS-2 or VDS-3 / API Ci-4 or higher
D3-160A-A / A-B / A-C	5	2004 - 2006	18-8003-1	8692305	5.65L / 6.0 Qt.	15W-40 VDS-2 or VDS-3 / API Ci-4 or higher
D3-160i-A / B / C	5	2004 - 2006	18-8003-1	8692305	5.65L / 6.0 Qt.	15W-40 VDS-2 or VDS-3 / API Ci-4 or higher
D3-190A-B	5	2005 - 2007	18-8003-1	8692305	5.65L / 6.0 Qt.	15W-40 VDS-2 or VDS-3 / API Ci-4 or higher
D3-190i-B / C	5	2005 - Current	18-8003-1	8692305	5.65L / 6.0 Qt.	15W-40 VDS-2 or VDS-3 / API Ci-4 or higher
A0D70B / C	6	1972 - 1978	18-7926	423135	20L / 5.28 Gal.	15W-40 VDS-2 or VDS-3 / API Ci-4 or higher
D11A-A / B / C / D	6	2007 - Current	18-0033	478736	38L / 10 Gal.	15W-40 VDS-2 or VDS-3 / API Ci-4 or higher
D11A-A / B / C / D	6	2007 - Current	18-0034	477556	38L / 10 Gal.	15W-40 VDS-2 or VDS-3 / API Ci-4 or higher
D11A-C (IPS) / D11A-D (IPS)	6	2009 - Current	18-0033	478736	38L / 10 Gal.	15W-40 VDS-2 or VDS-3 / API Ci-4 or higher
D11A-C (IPS) / D11A-D (IPS)	6	2009 - Current	18-0034	477556	38L / 10 Gal.	15W-40 VDS-2 or VDS-3 / API Ci-4 or higher
D12D-AMP / B / C / E / F / G / H	6	1999 - 2009	18-0033	478736	44L / 11.62 Gal.	15W-40 VDS-2 or VDS-3 / API Ci-4 or higher
D12D-AMG / EMG (Gen Set)	6	2002 - 2008	18-0034	477556	44L / 11.62 Gal.	15W-40 VDS-2 or VDS-3 / API Ci-4 or higher
D12D-AMH / B / C / E / G	6	2002 - 2008	18-0033	478736	44L / 11.62 Gal.	15W-40 VDS-2 or VDS-3 / API Ci-4 or higher
D13AMP / B / C / G / H	6	2009 - Current	18-0033	478736	45L / 11.89 Gal.	15W-40 VDS-2 or VDS-3 / API Ci-4 or higher
D13AMP / B / C / G / H	6	2009 - Current	18-0034	477556	45L / 11.89 Gal.	15W-40 VDS-2 or VDS-3 / API Ci-4 or higher
D16C-AMG / B / C (Gen Set)	6	2006 - 2009	18-0034	477556	49L / 13 Gal.	15W-40 VDS-2 or VDS-3 / API Ci-4 or higher
D16C-AMH / B / C	6	2006 - 2009	18-0033	478736	49L / 13 Gal.	15W-40 VDS-2 or VDS-3 / API Ci-4 or higher
D6-280A-A / A-B / A-C / A-D	6	2004 - 2010	18-0035	3582732 Full Flow	20L / 5.28 Gal.	15W-40 VDS-2 or VDS-3 / API Ci-4 or higher
D6-280i-A / B	6	2004 - 2008	18-0035	3582732 Full Flow	20L / 5.28 Gal.	15W-40 VDS-2 or VDS-3 / API Ci-4 or higher

VOLVO DIESEL CONTINUED ON NEXT PAGE

OIL FILTER QUICK-REFERENCE GUIDE

VOLVO DIESEL

Model	Cyl.	Year	Oil Filter	Replaces	Crankcase Capacity	Recommended Oil
D6-280i-A / B	6	2004 - 2008	18-0036	3582733 Bypass	20L / 5.28 Gal.	15W-40 VDS-2 or VDS-3 / API CI-4 or higher
D6-310i-A / B / C / D	6	2003 - 2010	18-0035	3582732 Full Flow	20L / 5.28 Gal.	15W-40 VDS-2 or VDS-3 / API CI-4 or higher
D6-310i-A / B / C / D	6	2003 - 2010	18-0036	3582733 Bypass	20L / 5.28 Gal.	15W-40 VDS-2 or VDS-3 / API CI-4 or higher
D6-330A-B / D-B	6	2004 - 2008	18-0035	3582732 Full Flow	20L / 5.28 Gal.	15W-40 VDS-2 or VDS-3 / API CI-4 or higher
D6-330A-B / D-B	6	2004 - 2008	18-0036	3582733 Bypass	20L / 5.28 Gal.	15W-40 VDS-2 or VDS-3 / API CI-4 or higher
D6-330i-B / C / D	6	2007 - 2010	18-0035	3582732 Full Flow	20L / 5.28 Gal.	15W-40 VDS-2 or VDS-3 / API CI-4 or higher
D6-330i-B / C / D	6	2007 - 2010	18-0036	3582733 Bypass	20L / 5.28 Gal.	15W-40 VDS-2 or VDS-3 / API CI-4 or higher
D6-370A-B / A-C / A-D / D-B / D-C / D-D	6	2007 - 2010	18-0035	3582732 Full Flow	20L / 5.28 Gal.	15W-40 VDS-2 or VDS-3 / API CI-4 or higher
D6-370A-B / A-C / A-D / D-B / D-C / D-D	6	2007 - 2010	18-0036	3582733 Bypass	20L / 5.28 Gal.	15W-40 VDS-2 or VDS-3 / API CI-4 or higher
D6-400A-E	6	2011 - Current	18-0035	3582732 Full Flow	20L / 5.28 Gal.	15W-40 VDS-2 or VDS-3 / API CI-4 or higher
D6-400A-E	6	2011 - Current	18-0036	3582733 Bypass	20L / 5.28 Gal.	15W-40 VDS-2 or VDS-3 / API CI-4 or higher
D6-435D-C / D-D / D-E	6	2006 - Current	18-0035	3582732 Full Flow	20L / 5.28 Gal.	15W-40 VDS-2 or VDS-3 / API CI-4 or higher
D6-435D-C / D-D / D-E	6	2006 - Current	18-0036	3582733 Bypass	20L / 5.28 Gal.	15W-40 VDS-2 or VDS-3 / API CI-4 or higher
D6-435i-A / C / D / E	6	2006 - Current	18-0035	3582732 Full Flow	20L / 5.28 Gal.	15W-40 VDS-2 or VDS-3 / API CI-4 or higher
D6-435i-A / C / D / E	6	2006 - Current	18-0036	3582733 Bypass	20L / 5.28 Gal.	15W-40 VDS-2 or VDS-3 / API CI-4 or higher
D9A2A	6	2004 - 2006	18-0033	478736	31L / 32.75 Qt.	15W-40 VDS-2 or VDS-3 / API CI-4 or higher
D9A2A MG (Gen. Set)	6	2004 - Current	18-0033	478736	31L / 32.75 Qt.	15W-40 VDS-2 or VDS-3 / API CI-4 or higher
KAD300-A	6	2001 - 2005	18-7926		11L / 11.6 Qt.	15W-40 VDS-2 or VDS-3 / API CI-4 or higher
KAD42B/P/PA	6	1993 - 1997	18-7926		10.5L / 11.0 Qt.	15W-40 VDS-2 or VDS-3 / API CI-4 or higher
KAD43P-A	6	1997 - 2005	18-7926		10.5L / 11.0 Qt.	15W-40 VDS-2 or VDS-3 / API CI-4 or higher
KAD44P-A/B/C	6	1997 - 2004	18-7926		11L / 11.6 Qt.	15W-40 VDS-2 or VDS-3 / API CI-4 or higher
KAMD300-A	6	2001 - 2004	18-7926		11L / 11.6 Qt.	15W-40 VDS-2 or VDS-3 / API CI-4 or higher
KAMD42A/B/P/PA	6	1991 - 1997	18-7926		10.5L / 11.0 Qt.	15W-40 VDS-2 or VDS-3 / API CI-4 or higher
KAMD43P-A	6	1997 - 2005	18-7926		10.5L / 11.0 Qt.	15W-40 VDS-2 or VDS-3 / API CI-4 or higher
KAMD44P-B/C	6	1999 - 2004	18-7926		11L / 11.6 Qt.	15W-40 VDS-2 or VDS-3 / API CI-4 or higher
MD100A/B	6	1965 - 1984	18-7926		50L / 13.21 Gal.	15W-40 VDS-2 or VDS-3 / API CI-4 or higher
MD120A/B	6	1970 - 1980	18-7926		50L / 13.21 Gal.	15W-40 VDS-2 or VDS-3 / API CI-4 or higher
MD32A	6	1970 - 1977	18-7974	3827069	8L / 8.4 Qt.	15W-40 VDS-2 or VDS-3 / API CI-4 or higher
MD70B	6	1970 - 1978	18-7926		15L / 16 Qt.	15W-40 VDS-2 or VDS-3 / API CI-4 or higher
TAMD102A (Long Filter)	6	1991 - 2000	18-0033	478736	50L / 13.21 Gal.	15W-40 VDS-2 or VDS-3 / API CI-4 or higher
TAMD102A / D (Short Filter)	6	1991 - 2000	18-0032	847741	50L / 13.21 Gal.	15W-40 VDS-2 or VDS-3 / API CI-4 or higher
TAMD103A-A (Long Filter)	6	2000 - 2004	18-0033	478736	50L / 13.2 Gal.	15W-40 VDS-2 or VDS-3 / API CI-4 or higher
TAMD103A-A, AUX (Short Filter)	6	2000 - 2004	18-0032	847741	50L / 13.2 Gal.	15W-40 VDS-2 or VDS-3 / API CI-4 or higher
TAMD120A / B	6	1972 - 1983	18-7926		50L / 13.2 Gal.	15W-40 VDS-2 or VDS-3 / API CI-4 or higher
TAMD122D	6	1989 - 1996	18-0032	847741	50L / 13.2 Gal.	15W-40 VDS-2 or VDS-3 / API CI-4 or higher
TAMD122P-A, B, C	6	1995 - 2002	18-0033	478736	50L / 13.2 Gal.	15W-40 VDS-2 or VDS-3 / API CI-4 or higher
TAMD162A / B / C	6	1988 - 1996	18-0033	478736	73L / 19.3 Gal.	15W-40 VDS-2 or VDS-3 / API CI-4 or higher
TAMD162C-C	6	1999 - 2001	18-0033	478736	Refer to Owners Manual	15W-40 VDS-2 or VDS-3 / API CI-4 or higher
TAMD163A-A / PA	6	1994 - 2001	18-0033	478736	73L / 19.3 Gal.	15W-40 VDS-2 or VDS-3 / API CI-4 or higher
TAMD165A-A / C-A / P-A	6	2002 - 2005	18-0033	478736	73L / 19.3 Gal.	15W-40 VDS-2 or VDS-3 / API CI-4 or higher
TAMD40A / B	6	1980 - 1986	18-7926	423135	10.5L / 11.0 Qt.	15W-40 VDS-2 or VDS-3 / API CI-4 or higher
TAMD41A/B/D	6	1986 - 1994	18-7926	423135	10.5L / 11.0 Qt.	15W-40 VDS-2 or VDS-3 / API CI-4 or higher
TAMD42 B/WJ-A	6	1993 - 2003	18-7926	423135	10.5L / 11.0 Qt.	15W-40 VDS-2 or VDS-3 / API CI-4 or higher
TAMD60A/B/C	6	1976 - 1987	18-7926	423135	20L / 5.28 Gal.	15W-40 VDS-2 or VDS-3 / API CI-4 or higher

All listed oil capacities are approximate amounts only and may or may not include the oil filter capacity.
ALWAYS follow proper crankcase drain and fill procedures. Check engine dipstick for proper crankcase oil level.

VOLVO DIESEL CONTINUED ON NEXT PAGE

OIL FILTER QUICK-REFERENCE GUIDE

VOLVO DIESEL

Model	Cyl.	Year	Oil Filter	Replaces	Crankcase Capacity	Recommended Oil
TAMD61A	6	1986 - 1999	18-0032	847741	20L / 5.28 Gal.	15W-40 VDS-2 or VDS-3 / API CI-4 or higher
TAMD62A	6	1992 - 1994	18-0032	847741	20L / 5.28 Gal.	15W-40 VDS-2 or VDS-3 / API CI-4 or higher
TAMD63LA, 63PA	6	1994 - 2005	18-7974	3827069	20L / 5.28 Gal.	15W-40 VDS-2 or VDS-3 / API CI-4 or higher
TAMD63P-A	6	1994 - 2005	18-0032	847741	20L / 5.28 Gal.	15W-40 VDS-2 or VDS-3 / API CI-4 or higher
TAMD70B/C	6	1970 - 1978	18-7926	423135	20L / 5.28 Gal.	15W-40 VDS-2 or VDS-3 / API CI-4 or higher
TAMD71A	6	1986 - 1994	18-0032	847741	20L / 5.28 Gal.	15W-40 VDS-2 or VDS-3 / API CI-4 or higher
TAMD71B	6	1989 - 2000	18-1974	3827069	20L / 5.28 Gal.	15W-40 VDS-2 or VDS-3 / API CI-4 or higher
TAMD72A	6	1991 - 1994	18-0032	847741	20L / 5.28 Gal.	15W-40 VDS-2 or VDS-3 / API CI-4 or higher
TAMD72P-A	6	1995 - 1997	18-0032	847741	27L / 7.1 Gal.	15W-40 VDS-2 or VDS-3 / API CI-4 or higher
TAMD72WJ-A	6	1993 - 1997	18-0032	847741	20L / 5.28 Gal.	15W-40 VDS-2 or VDS-3 / API CI-4 or higher
TAMD73P-A/WJ-A	6	1997 - 1999	18-7926	423135	28L / 7.4 Gal.	15W-40 VDS-2 or VDS-3 / API CI-4 or higher
TAMD74A	6	2000 - 2001	18-0032	847741	29L / 7.7 Gal.	15W-40 VDS-2 or VDS-3 / API CI-4 or higher
TAMD74A-A / A-B / P-B	6	2000 - 2005	18-7926		24L / 6.3 Gal.	15W-40 VDS-2 or VDS-3 / API CI-4 or higher
TAMD74C-A, B	6	2000 - 2001	18-0032	847741	25L / 6.6 Gal.	15W-40 VDS-2 or VDS-3 / API CI-4 or higher
TAMD74L-A, B	6	2000 - 2005	18-0032	847741	25L / 6.6 Gal.	15W-40 VDS-2 or VDS-3 / API CI-4 or higher
TAMD74P-A, B	6	1998 - 2005	18-0032	847741	25L / 6.6 Gal.	15W-40 VDS-2 or VDS-3 / API CI-4 or higher
TAMD75P-A	6	1998 - 2005	18-7926		24L / 6.3 Gal.	15W-40 VDS-2 or VDS-3 / API CI-4 or higher
THAMD70B/C	6	1972 - 1979	18-7926		24L / 6.3 Gal.	15W-40 VDS-2 or VDS-3 / API CI-4 or higher
TMD100A	6	1985 - 1983	18-7926		50L / 13.2 Gal.	15W-40 VDS-2 or VDS-3 / API CI-4 or higher
TMD102A	6	1988 - 2000	18-0033	478736	50L / 13.2 Gal.	15W-40 VDS-2 or VDS-3 / API CI-4 or higher
TMD120A/B	6	1970 - 1983	18-7878-1	3517857	50L / 13.2 Gal.	15W-40 VDS-2 or VDS-3 / API CI-4 or higher
TMD41B	6	1989 - 1993	18-7926		8.5L / 9 Qt.	15W-40 VDS-2 or VDS-3 / API CI-4 or higher
TMD41L-A	6	1994 - 1997	18-7926		10.5L / 11.0 Qt.	15W-40 VDS-2 or VDS-3 / API CI-4 or higher
TMD70B/C	6	1972 - 1985	18-0032	847741	20L / 5.28 Gal.	15W-40 VDS-2 or VDS-3 / API CI-4 or higher

WESTERBEKE

Model	Cyl.	Year	Oil Filter	Replaces	Crankcase Capacity	Recommended Oil
PROPULSION ENGINES						
11A One	1	2001 - Current	23-7800	036918	1.6L / 1.7 Qt.	SAE 10W-30
12B Two	2	1983 - 1992	23-7800	036918	2.8L / 3.0 Qt.	SAE 10W-30
12C Two	2	1992 - Current	23-7800	036918	2.8L / 3.0 Qt.	SAE 10W-30
12D Two	2	Current	23-7800	036918	2.8L / 3.0 Qt.	15W-40 API CI-4, CI-4 Plus, CJ-4
20B Two	2	1987 - Current	23-7800	036918	2.8L / 3.0 Qt.	15W-40 API CI-4, CI-4 Plus, CJ-4
W13	2	1980 - 1984	23-7800	036918	2.8L / 3.0 Qt.	SAE 10W-30
W13A	2	1984 - 1988	23-7800	036918	2.8L / 3.0 Qt.	SAE 10W-30
30B Three	3	1987 - Current	23-7800	036918	2.8L / 3.0 Qt.	15W-40 API CI-4, CI-4 Plus, CJ-4
30C Three	3	Current	23-7800	036918	2.8L / 3.0 Qt.	15W-40 API CI-4, CI-4 Plus, CJ-4
35B Three	3	1987 - 2000	23-7800	036918	4.5L / 4.75 Qt.	SAE 10W-30
35C Three	3	2000 - 2002	23-7800	036918	4.5L / 4.75 Qt.	15W-40 API CI-4, CI-4 Plus, CJ-4
35D Three	3	2002 - Current	23-7800	036918	4.5L / 4.75 Qt.	15W-40 API CI-4, CI-4 Plus, CJ-4
35E Three	3	Current	23-7800	036918	4.5L / 4.75 Qt.	15W-40 API CI-4, CI-4 Plus, CJ-4
W18	3	1985 - 1989	23-7800	036918	3.78L / 4.0 Qt.	SAE 10W-30
W21	3	1980 - 1984	23-7800	036918	3.78L / 4.0 Qt.	SAE 10W-30
W21A	3	1984 - 1987	23-7800	036918	3.78L / 4.0 Qt.	SAE 10W-30
38B Four	4	1987 - 2001	23-7825	035828	4.5L / 4.75 Qt.	SAE 10W-30
42B Four	4	1987 - 1999	23-7825	035828	4.5L / 4.75 Qt.	SAE 10W-30

All listed oil capacities are approximate amounts only and may or may not include the oil filter capacity.
ALWAYS follow proper crankcase drain and fill procedures. Check engine dipstick for proper crankcase oil level.

WESTERBEKE CONTINUED ON NEXT PAGE

OIL FILTER QUICK-REFERENCE GUIDE

WESTERBEKE

Model	Cyl.	Year	Oil Filter	Replaces	Crankcase Capacity	Recommended Oil
44A Four	4	1999 - 2002	23-7800	036918	4.5L / 4.75 Qt.	15W-40 API CI-4, CI-4 Plus, CJ-4
44B Four	4	2002 - Current	23-7800	036918	4.5L / 4.75 Qt.	15W-40 API CI-4, CI-4 Plus, CJ-4
44C Four	4	Current	23-7800	036918	4.5L / 4.75 Qt.	15W-40 API CI-4, CI-4 Plus, CJ-4
55A Four	4	1995 - 2002	23-7825	035828	5.0L / 5.28 Qt.	SAE 30 CF
55B Four	4	2002 - 2005	23-7800	036918	7.6L / 8.0 Qt.	SAE 30 CF
55C Four	4	2005 - Current	23-7800	036918	7.6L / 8.0 Qt.	SAE 30 CF
55D Four	4	Current	23-7800	036918	7.6L / 8.0 Qt.	SAE 30 CF
63B Four	4	1990 - 1994	23-7825	035828	11.3L / 12 Qt.	15W-40 API CI-4, CI-4 Plus, CJ-4
63C Four	4	1994 - 2000	23-7825	035828	11.3L / 12 Qt.	15W-40 API CI-4, CI-4 Plus, CJ-4
63D Four	4	2001 - 2003	23-7825	035828	5.0L / 5.28 Qt.	15W-40 API CI-4, CI-4 Plus, CJ-4
64A Four	4	2003 - Current	23-7826	040154	6.15L / 6.5 Qt.	15W-40 API CI-4, CI-4 Plus, CJ-4
71B Four	4	1991 - 1994	23-7825	035828	11.3L / 12 Qt.	15W-40 API CI-4, CI-4 Plus, CJ-4
71C Four	4	1994 - Current	23-7826	040154	11.3L / 12 Qt.	15W-40 API CI-4, CI-4 Plus, CJ-4
82B Four	4	1991 - Current	23-7826	040154	11.3L / 12 Qt.	15W-40 API CI-4, CI-4 Plus, CJ-4
90A Four	4	1999 - Current	23-7826	040154	6.0L / 6.3 Qt.	15W-40 API CI-4, CI-4 Plus, CJ-4
W27	4	1980 - 1984	23-7800	036918	3.78L / 4.0 Qt.	SAE 10W-30
W27A	4	1984 - 1988	23-7800	036918	3.78L / 4.0 Qt.	SAE 10W-30
W33	4	1980 - 1984	23-7825	035828	3.78L / 4.0 Qt.	SAE 10W-30
W33A	4	1984 - 1988	23-7825	035828	3.78L / 4.0 Qt.	SAE 10W-30
W41G	4	1986 - 1993	23-7800	036918	-	-
W46	4	1985 - 1990	23-7825	035828	6.15L / 6.5 Qt.	SAE 10W-30
W70	4	1982 - 1991	23-7826	040154	6.15L / 6.5 Qt.	SAE 10W-30
W70G	4	1988 - 2001	23-7800	036918	-	-
W70GA	4	2003 - Current	23-7800	036918	-	-
108B Six	6	1991 - 1994	23-7826	040154	11.3L / 12 Qt.	15W-40 API CI-4, CI-4 Plus, CJ-4
108C Six	6	1994 - Current	23-7826	040154	11.3L / 12 Qt.	15W-40 API CI-4, CI-4 Plus, CJ-4
W100	6	1982 - 1991	23-7826	040154	11.3L / 12 Qt.	-
GEN SET (ALL MODELS ARE 60HZ. USA / NORTH AMERICAN)						
10.0 BTD	3	1984 - 2000	23-7800	036918	3.3 Qt.	15W-40 API CI-4, CI-4 Plus, CJ-4
10.0 BTDA	3	2000 - Current	23-7800	036918	3.8L / 4.0 Qt.	15W-40 API CI-4, CI-4 Plus, CJ-4
10.0 EDT D-NET	3	-	23-7800	036918	3.8L / 4.0 Qt.	15W-40 API CI-4, CI-4 Plus, CJ-4
10.0 SBEG Low-CO	4	2005 - Current	23-7800	036918	3.5 Qt.	SAE 10W-30
11.0 TWG	4	1984 - 1987	23-7800	036918	-	SAE 10W-30
11.0 WMD	4	1980 - 1987	23-7800	036918	6.15 Qt.	15W-40 API CI-4, CI-4 Plus, CJ-4
11.5 BTD	3	-	23-7800	036918	4.7L / 5.0 Qt.	15W-40 API CI-4, CI-4 Plus, CJ-4
11.5 EDT D-NET	3	-	23-7800	036918	4.7L / 5.0 Qt.	15W-40 API CI-4, CI-4 Plus, CJ-4
12.06 EDT D-NET	3	-	23-7800	036918	4.7L / 5.0 Qt.	15W-40 API CI-4, CI-4 Plus, CJ-4
12.5 BEG	4	2002 - Current	23-7800	036918	3.5 Qt.	SAE 10W-30
12.5 BTDB	4	-	23-7800	036918	5.2L / 5.5 Qt.	15W-40 API CI-4, CI-4 Plus, CJ-4
12.5 BTG	4	1987 - 2001	23-7800	036918	3.8L / 4.0 Qt.	SAE 10W-30
12.5 BTGA	4	2001 - 2002	23-7800	036918	-	SAE 10W-30
12.5 EDT D-NET	4	-	23-7800	036918	5.2L / 5.5 Qt.	15W-40 API CI-4, CI-4 Plus, CJ-4
12.5 SBEG Low-CO	4	2005 - Current	23-7800	036918	3.5 Qt.	SAE 10W-30
12.6 BTD	3	2002 - Current	23-7800	036918	3.8L / 4.0 Qt.	15W-40 API CI-4, CI-4 Plus, CJ-4
14.0 SBEG Low-CO	4	2005 - Current	23-7800	036918	3.5 Qt.	SAE 10W-30
15.0 BEG	4	2002 - Current	23-7800	036918	3.5 Qt.	SAE 10W-30

All listed oil capacities are approximate amounts only and may or may not include the oil filter capacity.
ALWAYS follow proper crankcase drain and fill procedures. Check engine dipstick for proper crankcase oil level.

WESTERBEKE CONTINUED ON NEXT PAGE

OIL FILTER QUICK-REFERENCE GUIDE

15.0 BTDC	4	2000 - Current	23-7800	036918	5.2L / 5.5 Qt.	15W-40 API CI-4, CI-4 Plus, CJ-4
15.0 BTG	4	1987 - 2001	23-7800	036918	3.8L / 4.0 Qt.	SAE 10W-30
15.0 EDT D-NET	4	-	23-7800	036918	5.2L / 5.5 Qt.	15W-40 API CI-4, CI-4 Plus, CJ-4
20.0 BEG	4	1995 - 2004	23-7800	036918	4.5 Qt.	SAE 10W-30
20.0 BEGA	4	2004 - Current	23-7800	036918	-	SAE 10W-30
20.0 SBEG Low-CO	4	2005 - Current	23-7800	036918	4.5 Qt.	SAE 10W-30
20.0 SBEGA Low-CO	4	-	23-7800	036918	-	SAE 10W-30
22.5 SBEG Low-CO	4	2005 - Current	23-7800	036918	-	SAE 10W-30
22.5 SBEGA Low-CO	4	-	23-7800	036918	4.5 Qt.	SAE 10W-30
25.0 BEG	4	1999 - 2004	23-7800	036918	4.5 Qt.	SAE 10W-30
3.0 WMD	2	1982 - 1988	23-7800	036918	2.0 Qt.	15W-40 API CI-4, CI-4 Plus, CJ-4
4.0 BCD (60 Hz.) ONLY	3	2002 - Current	23-7800	036918	3.05L / 3.2 Qt.	15W-40 API CI-4, CI-4 Plus, CJ-4
4.0 BCDA 60Hz. ONLY	3	2008 - Current	23-7800	036918	3.05L / 3.2 Qt.	15W-40 API CI-4, CI-4 Plus, CJ-4
4.4 BCD	2	1986 - 1989	23-7800	036918	2.4L / 2.5 Qt.	15W-40 API CI-4, CI-4 Plus, CJ-4
4.4 WMD	2	1980 - 1986	23-7800	036918	2.4L / 2.5 Qt.	15W-40 API CI-4, CI-4 Plus, CJ-4
4.5 BCG	3	1988 - 1997	23-7800	036918	2.8L / 3.0 Qt.	SAE 10W-30
4.5 BCGA	3	1997	23-7800	036918	2.4L / 2.5 Qt.	SAE 10W-30
4.5 BCGB	3	1999 - 2002	23-7800	036918	2.4L / 2.5 Qt.	SAE 10W-30
4.5 BCGTC	3	1997 - 2002	23-7800	036918	2.6L / 2.7 Qt.	SAE 10W-30
4.5 BCGTE	3	1997 - 2001	23-7800	036918	2.6L / 2.7 Qt.	SAE 10W-30
5.0 BCD	3	1989 - 1996	23-7800	036918	3.0L / 3.2 Qt.	15W-40 API CI-4, CI-4 Plus, CJ-4
5.0 BCDA	3	1996	23-7800	036918	3.0L / 3.2 Qt.	15W-40 API CI-4, CI-4 Plus, CJ-4
5.0 BCD(60Hz)	3	1996 - Current	23-7800	036918	3.0L / 3.2 Qt.	15W-40 API CI-4, CI-4 Plus, CJ-4
5.0 BCG low profile	3	2002 - Current	23-7800	036918	2.4L / 2.5 Qt.	SAE 40 SJ
5.0 BCGA	3	2002	23-7800	036918	2.4L / 2.5 Qt.	SAE 40 SJ
5.0 SBEG Low-CO	3	2005 - Current	23-7800	036918	2.8L / 3.0 Qt.	SAE 40 SJ
5.5 BCD	3	-	23-7800	036918	3.0L / 3.2 Qt.	15W-40 API CI-4, CI-4 Plus, CJ-4
5.5 EDC D-NET	3	-	23-7800	036918	3.6L / 3.8 Qt.	15W-40 API CI-4, CI-4 Plus, CJ-4
6.0 BCD	3	1986 - 1989	23-7800	036918	3.0L / 3.2 Qt.	15W-40 API CI-4, CI-4 Plus, CJ-4
GEN SET (ALL MODELS ARE 60HZ. USA / NORTH AMERICAN)						
6.0 WMD	3	-	23-7800	036918	3.0L / 3.2 Qt.	15W-40 API CI-4, CI-4 Plus, CJ-4
6.5 SBEG Low-CO	3	2005 - Current	23-7800	036918	2.8L / 3.0 Qt.	SAE 40 SJ
6.5 TWG	4	1984 - 1987	23-7800	036918	3.0L / 3.2 Qt.	SAE 10W-30
7.0 BCG / BCGA	3	1989 - 1997	23-7800	036918	2.8L / 3.0 Qt.	SAE 10W-30
7.0 BCGB	3	1999 - 2002	23-7800	036918	2.4L / 2.5 Qt.	SAE 10W-30
7.0 BCGC Low Profile	3	2002 - 2004	23-7800	036918	2.4L / 2.5 Qt.	SAE 40 SJ
7.0 BCGD Low Profile	3	2004 - Current	23-7800	036918	2.4L / 2.5 Qt.	SAE 40 SJ
7.2 BCGTC	3	1997 - 2002	23-7800	036918	2.6L / 2.7 Qt.	SAE 10W-30
7.2 BCGTE	3	1997 - 2001	23-7800	036918	2.6L / 2.7 Qt.	SAE 10W-30
7.6 BTD	3	1993 - Current	23-7800	036918	3.6L / 3.8 Qt.	15W-40 API CI-4, CI-4 Plus, CJ-4
7.6 EDT D-NET	3	-	23-7800	036918	3.6L / 3.8 Qt.	15W-40 API CI-4, CI-4 Plus, CJ-4
7.7 WMD	3	1980 - 1984	23-7800	036918	3.0L / 3.2 Qt.	15W-40 API CI-4, CI-4 Plus, CJ-4
8.0 BCDT	2	2002 - 2004	23-7800	036918	2.9L / 3.1 Qt.	15W-40 API CI-4, CI-4 Plus, CJ-4
8.0 BTD	3	1984 - 2000	23-7800	036918	3.0L / 3.2 Qt.	15W-40 API CI-4, CI-4 Plus, CJ-4
8.0 BTDA	3	2000 - Current	23-7800	036918	3.0L / 3.2 Qt.	15W-40 API CI-4, CI-4 Plus, CJ-4
8.0 EDT D-NET	3	-	23-7800	036918	3.8L / 4.0 Qt.	15W-40 API CI-4, CI-4 Plus, CJ-4
8.0 SSEG Low-CO	4	2005 - Current	23-7800	036918	3.3L / 3.5 Qt.	SAE 10W-30
8.0 TWG	4	1983 - 1987	23-7800	036918	3.0L / 3.2 Qt.	SAE 10W-30
8.0 WMD	3	1980 - 1984	23-7800	036918	3.0L / 3.2 Qt.	15W-40 API CI-4, CI-4 Plus, CJ-4
8.5 BTG	4	1987 - 1993	23-7800	036918	3.7L / 3.9 Qt.	SAE 10W-30

WESTERBEKE CONTINUED ON NEXT PAGE

OIL FILTER QUICK-REFERENCE GUIDE

8.5 BTGA	4	1993 - 2002	23-7800	036918	3.8L / 4.0 Qt.	SAE 10W-30
9.6 BCGTC	3	1997 - 2002	23-7800	036918	2.6L / 2.7 Qt.	SAE 10W-30
9.6 BCGTE	3	-	23-7800	036918	2.6L / 2.7 Qt.	SAE 10W-30
11.0 BTD	4	1987 - 2001	23-7825	035828	4.0L / 4.2 Qt.	15W-40 API CI-4, CI-4 Plus, CJ-4
12.5 BTDA	4	1988 - 2000	23-7825	035828	4.5L / 4.7 Qt.	15W-40 API CI-4, CI-4 Plus, CJ-4
12.5 WMD	4	1980 - 1987	23-7825	035828	4.5L / 4.7 Qt.	15W-40 API CI-4, CI-4 Plus, CJ-4
15.0 BTD	4	1987 - 1990	23-7825	035828	6.6L / 7.0 Qt.	15W-40 API CI-4, CI-4 Plus, CJ-4
15.0 BTDA	4	1990 - 1994	23-7825	035828	5.0L / 5.3 Qt.	15W-40 API CI-4, CI-4 Plus, CJ-4
15.0 BTDB	4	1994 - 2000	23-7825	035828	5.0L / 5.3 Qt.	15W-40 API CI-4, CI-4 Plus, CJ-4
20.0 BED	4	1990 - 1995	23-7825	035828	6.15L / 6.5 Qt.	15W-40 API CI-4, CI-4 Plus, CJ-4
25.0 BED PTO	4	1992 - Current	23-7826	040154	6.15L / 6.5 Qt.	15W-40 API CI-4, CI-4 Plus, CJ-4
25.0 WTA	4	1982 - 1985	23-7826	040154	6.0L / 6.3 Qt.	15W-40 API CI-4, CI-4 Plus, CJ-4
32.0 BED	6	1993 - 1994	23-7826	040154	Refer to Owners Manual	15W-40 API CI-4, CI-4 Plus, CJ-4
32.0 BEDA	4	1994 - Current	23-7826	040154	6.0L / 6.3 Qt.	15W-40 API CI-4, CI-4 Plus, CJ-4
32.0 BEDB	6	1994	23-7826	040154	11.3L / 12 Qt.	15W-40 API CI-4, CI-4 Plus, CJ-4
20.0 BEDA	4	1995 - Current	23-7826	040154	6.15L / 6.5 Qt.	15W-40 API CI-4, CI-4 Plus, CJ-4
25.0 BED	4	1992 - Current	23-7826	040154	6.15L / 6.5 Qt.	15W-40 API CI-4, CI-4 Plus, CJ-4

YAMAHA

Model	Year	Oil Filter	Replaces	Crankcase Capacity	Recommended Oil
F2.5	2003 - 2011	----		0.35 L / 0.35 Qt.	10W-30 FC-W
F4	1999 - 2011	----		0.50 L / 0.53 Qt.	10W-30 FC-W
F6, F7B	2001 - 2011	----		0.80 L / 0.84 Qt.	10W-30 FC-W
F8S / F8L	2015 - 2020	----		0.27 oz.	10W-30 FC-W
T9.9 (Model 6G8)	1991 - 04/2005	18-7901	6G8-13440-00-00	1.0 L / 1.06 Qt.	10W-30 FC-W
F9.9 (Model 6G8)	1990 - 04/2005	18-7901	6G8-13440-00-00	1.0 L / 1.06 Qt.	10W-30 FC-W
T9.9 (Model 66R)	2005 - 04/2006	18-7911-1	5GH-13440-00-00	0.80 L / 0.84 Qt.	10W-30 FC-W
F9.9 (Model 66R)	2005 - 04/2006	18-7911-1	5GH-13440-00-00	0.80 L / 0.84 Qt.	10W-30 FC-W
F9.9F / F9.9G	2008 - 2020	----		0.27 oz.	10W-30 FC-W
F15	1998 - 1999	18-7902	3FV-13440-10-00	1.0 L / 1.06 Qt.	10W-30 FC-W
F15	2000 - 2006	18-7911-1	5GH-13440-00-00	1.8 L / 1.9 Qt.	10W-30 FC-W
F15C	2007 - 2020	18-8700	5GH-13440-20-00	1.8 L / 1.9 Qt.	10W-30 FC-W
F20	2007 - 2020	18-8700	5GH-13440-20-00	1.8 L / 1.9 Qt.	10W-30 FC-W
F25	1998 - 1999	18-7902	3FV-13440-10-00	1.7 L / 1.8 Qt.	10W-30 FC-W
F25 / T25	2000 - 04/2006	18-7911-1	5GH-13440-00-00	1.7 L / 1.8 Qt.	10W-30 FC-W
F25	2008 - 2020	18-8700	5GH-13440-20-00	1.7 L / 1.8 Qt.	10W-30 FC-W
F30	2017 - 2020	18-7911-1	5GH-13440-00-00	2.0 L / 2.1 Qt.	10W-30 FC-W
F40	1999 - 2000	18-7902	3FV-13440-10-00	2.0 L / 2.1 Qt.	10W-30 FC-W
F40 / F40B (International)	2001 - 2008	18-7911-1	5GH-13440-00-00	2.0 L / 2.1 Qt.	10W-30 FC-W
F40A	2001 - Current	18-8700	5GH-13440-20-00	2.0 L / 2.1 Qt.	10W-30 FC-W
T50	1996 - 1999	18-7902	3FV-13440-10-00	2.0 L / 2.1 Qt.	10W-30 FC-W
T50	2000 - 2004	18-7911-1	5GH-13440-00-00	2.0 L / 2.1 Qt.	10W-30 FC-W
T50	2005 - Current	18-8700	5GH-13440-20-00	2.0 L / 2.1 Qt.	10W-30 FC-W
F50	1995 - 1999	18-7902	3FV-13440-10-00	2.0 L / 2.1 Qt.	10W-30 FC-W
F50	1999 - 2004	18-7911-1	5GH-13440-00-00	2.0 L / 2.1 Qt.	10W-30 FC-W
F50	2005 - Current	18-8700	5GH-13440-20-00	2.0 L / 2.1 Qt.	10W-30 FC-W
T60	1999 - 2004	18-7911-1	5GH-13440-00-00	2.0 L / 2.1 Qt.	10W-30 FC-W
T60	2005 - Current	18-8700	5GH-13440-20-00	2.0 L / 2.1 Qt.	10W-30 FC-W
F60	1999 - 2004	18-7911-1	5GH-13440-00-00	2.0 L / 2.1 Qt.	10W-30 FC-W
F60	2005 - Current	18-8700	5GH-13440-20-00	2.0 L / 2.1 Qt.	10W-30 FC-W

All listed oil capacities are approximate amounts only and may or may not include the oil filter capacity.
 ALWAYS follow proper crankcase drain and fill procedures. Check engine dipstick for proper crankcase oil level.

YAMAHA CONTINUED ON NEXT PAGE

OIL FILTER QUICK-REFERENCE GUIDE

YAMAHA

Model	Year	Oil Filter	Replaces	Crankcase Capacity	Recommended Oil
F70	All Years	18-8700	5GH-13440-20-00	2.0 L / 2.1 Qt.	10W-30 FC-W
F75	All Years	18-7911-1	5GH-13440-00-00	4.3 L / 4.5 Qt.	10W-30 FC-W
F80	1999	18-7902	3FV-13440-10-00	4.3 L / 4.5 Qt.	10W-30 FC-W
F80	2000 - Current	18-7911-1	5GH-13440-00-00	4.3 L / 4.5 Qt.	10W-30 FC-W
F90	All Years	18-7911-1	5GH-13440-00-00	4.3 L / 4.5 Qt.	10W-30 FC-W
F100	1999	18-7902	3FV-13440-10-00	4.3 L / 4.5 Qt.	10W-30 FC-W
F100	2000 - Current	18-7911-1	5GH-13440-00-00	4.3 L / 4.5 Qt.	10W-30 FC-W
F115	All Years	18-7911-1	5GH-13440-00-00	4.3 L / 4.5 Qt.	10W-30 FC-W
F150	2004 - Current	18-7906-1	69J-13440-01-00	5.4 L / 5.7 Qt.	10W-30 FC-W
F200 (3.3L)	All Years	18-7906-1	69J-13440-01-00	5.8 L / 6.13 Qt.	10W-30 FC-W
F200 (4.2L SHO)	2009 - Current	18-7954	N26-13440-00-00	7.1L / 7.5 Qt.	5W-30 FC-W Full Synthetic
F225 (3.3L)	All Years	18-7906-1	69J-13440-01-00	5.8 L / 6.13 Qt.	10W-30 FC-W
F225 (4.2L)	2009 - Current	18-7954	N26-13440-00-00	7.1L / 7.5 Qt.	10W-30 FC-W
F250 (3.3L)	All Years	18-7906-1	69J-13440-01-00	5.8 L / 6.13 Qt.	10W-30 FC-W
F250 (4.2L)	2009 - Current	18-7954	N26-13440-00-00	7.1L / 7.5 Qt.	10W-30 FC-W
F300 (V8)	2007 - Current	18-7954	N26-13440-00-00	8.0 L / 8.45 Qt.	10W-30 FC-W
F350 (V8)	2007 - Current	18-7954	N26-13440-00-00	8.0 L / 8.45 Qt.	10W-30 FC-W

YANMAR

Model	Cyl.	Year	Oil Filter	Replaces	Crankcase Capacity	Recommended Oil
1GM	1	1980 - 1983	18-7910-1	124450-35100 119660-35150 119660-35150	1.6 Qt.	SAE 15W-40 CI-4 Refer to owners manual
1GM10	1	1983 - 2009	18-7910-1	124450-35100 119660-35150 119305-35151	1.6 Qt.	SAE 15W-40 CI-4 Refer to owners manual
2GM	2	1980 - 1983	18-7910-1	124450-35100 119660-35150 119305-35151	2.1 Qt.	SAE 15W-40 CI-4 Refer to owners manual
2GM20	2	1983 - 2005	18-7910-1	124450-35100 119660-35150 119305-35151	2.1 Qt.	SAE 15W-40 CI-4 Refer to owners manual
2GM20-YEU (Serial No. Starts w/ E)	2	1997 - Current	18-7910-1	119660-35150 119305-35151	2.1 Qt.	SAE 15W-40 CI-4 Refer to owners manual
2GM20F	2	1983 - 2005	18-7910-1	124450-35100 119660-35150 119305-35151	2.1 Qt.	SAE 15W-40 CI-4 Refer to owners manual
2GMF	2	1980 - 1983	18-7910-1	124450-35100 119660-35150 119305-35151	2.1 Qt.	SAE 15W-40 CI-4 Refer to owners manual
2QM15	2	1977 - 1980	18-7910-1	124450-35100 119660-35150 119305-35151	2.1 Qt.	SAE 15W-40 CI-4 Refer to owners manual
2QM20 (Serial #81181 and Higher)	2	1975 - 1980	18-7917	124550-35110 124085-35113	2.1 Qt.	SAE 15W-40 CI-4 Refer to owners manual
2YM15	2	2004 - Current	18-7910-1	119305-35151	2.1 Qt.	SAE 15W-40 CI-4 Refer to owners manual
3GM30	3	1983 - Current	18-7910-1	124450-35100 119660-35150 119305-35151	2.7 Qt.	SAE 15W-40 CI-4 Refer to owners manual
3GM30-YEU (Serial No. Starts w/ E)	3	1997 - Current	18-7910-1	119660-35150 119305-35151	2.7 Qt.	SAE 15W-40 CI-4 Refer to owners manual
3GM30F	3	1983 - 2005	18-7910-1	124450-35100 119660-35150 119305-35151	2.7 Qt.	SAE 15W-40 CI-4 Refer to owners manual

YANMAR CONTINUED ON NEXT PAGE

OIL FILTER QUICK-REFERENCE GUIDE

YANMAR

Model	Cyl.	Year	Oil Filter	Replaces	Crankcase Capacity	Recommended Oil
3GM	3	1980 - 1983	18-7910-1	124450-35100 119660-35150 119305-35151	2.7 Qt.	SAE 15W-40 CI-4 Refer to owners manual
3GMD	3	1980 - 1983	18-7910-1	119660-35150 119305-35151	2.7 Qt.	SAE 15W-40 CI-4 Refer to owners manual
3GMF	3	1980 - 1983	18-7910-1	124450-35100 119660-35150 119305-35151	2.7 Qt.	SAE 15W-40 CI-4 Refer to owners manual
3HM	3	1980 - 1983	18-7917	124550-35110 124085-35113		Refer to owners manual
3HM35	3	1983 - 1992	18-7917	124550-35110 124085-35113		SAE 15W-40 CI-4 Refer to owners manual
3HM35F	3	1983 - 1992	18-7917	124550-35110 124085-35113		SAE 15W-40 CI-4 Refer to owners manual
3HMF	3	1980 - 1983	18-7917	124550-35110 124085-35113		SAE 15W-40 CI-4 Refer to owners manual
3JH2TBE	3	1991-1999	18-7910-1	119305-35151		SAE 15W-40 CI-4 Refer to owners manual
3JH2BE	3	1989-1999	18-7910-1	119305-35151		SAE 15W-40 CI-4 Refer to owners manual
3JH2	3	1992-1999	18-7910-1	119305-35151		SAE 15W-40 CI-4 Refer to owners manual
3JH3	3	1999 - 2004	18-7910-1	119305-35150 119305-35151		SAE 15W-40 CI-4 Refer to owners manual
3JH3E-YEU	3	2004 - Current	18-7910-1	119305-35150 119305-35151	5.2 Qt.	SAE 15W-40 CI-4 Refer to owners manual
3JH4E (40hp.)	3	2004 - Current	18-7910-1	119305-35150 119305-35151		SAE 15W-40 CI-4 Refer to owners manual
3QM30	3	1976 - 1980	18-7917	124550-35110 124085-35113		SAE 15W-40 CI-4 Refer to owners manual
3QM30F	3	1976 - 1980	18-7917	124550-35110 124085-35113		SAE 15W-40 CI-4 Refer to owners manual
3YM20	3	2004 - Current	18-7910-1	119305-35151	2.6 Qt.	SAE 15W-40 CI-4 Refer to owners manual
3YM30	3	2004 - Current	18-7910-1	119305-35151	2.6 Qt.	SAE 15W-40 CI-4 Refer to owners manual

ALPHA CROSS REFERENCE

AC		BALDWIN		FRAM	
PF1250	18-7758	B7333	18-7897	PH13	18-7876-1
PF1267	18-0034	B75*	18-0032	PH16*	18-7878-1
PF454	18-7824	B75*	18-7927	PH16*	23-7841
PF2	18-7875	B76	18-7880	PH2821A	18-7886
PF1218	18-7876-1	B7685	18-0034	PH2870A	18-7925
PF13	18-7878-1	B76-SS	18-0033	PH2921	23-7825
PF857F	18-7880	BT216	18-7886	PH2951*	18-7897
PF2210	18-7884	BT223	18-7915-1	PH2951*	23-7801
PF939	18-7886	BT237	----	PH30	18-7824
PF881F	----	P7417	18-8003-1	PH3306A	18-7926
SPF53	18-7897	* Refer to Engine Mtg. Section		PH3387A	18-7974
PF911F	N/A	BRP		PH3545*	18-0032
PF1127	18-7910-1	See Evinrude / Johnson / OMC		PH3545*	18-7927
PF1237*	18-7911-1	CATERPILLAR		PH3593A*	18-7910-1
PF1237*	18-7913	1R-0658		PH3593A*	23-7800
PF2057	18-7914	1R-0658		PH3612	N/A
PF1233	18-7918	CHRYSLER INBOARD		PH3614	18-7884
PF60	18-7925	1851658		PH3766	18-7871
PF2207	18-7926	3549957		PH3980	18-7879-1
PF2203	18-7927	L-1108		PH4386*	18-7895
PF2257	18-8003-1	L-19		PH4386*	18-7896
PF1127	23-7800	L-319		PH4967*	18-7897
* Refer to Engine Mtg. Section		CRUSADER		PH4967*	18-7906-1
BALDWIN		22679		PH4967*	18-7916
B131	23-7801	201101		PH4967*	23-7821
B134	18-7871	201104		PH49A*	18-0033
B1400*	18-7902	DETROIT DIESEL		PH49A*	18-7880
B1400*	18-7911-1	25010495		PH5	18-7876-1
B1400*	18-7913	25010495		PH5046	18-7917
B1402*	18-7909	EVINRUDE / JOHNSON / OMC		PH6017A*	18-7902
B1402*	18-7914	173232		PH6017A*	18-7909
B161-S	23-7842	173233		PH6017A*	18-7911-1
B163	23-7841	173834		PH6017A*	18-7913
B167	18-7926	434839		PH6017A*	18-8700
B168	18-7917	502901		PH6811	23-7842
B178	18-7925	502902		PH7317	18-7914
B179*	18-7910-1	502903		PH7328	23-7841
B179*	23-7800	502904		PH7575*	18-7884
B179*	23-7824	763364		PH7575*	18-7915-1
B2	18-7875	778885		PH8842	18-0033
B202	23-7825	778886		PH8A	18-7875
B233*	18-7878-1	778887		PH9688	23-7842
B233*	23-7840	5031411		PH977A	----
B33*	18-7916	5033102		* Refer to Engine Mtg. Section	
B33*	23-7821	5033539		HONDA	
B35-S	18-7879-1	5033919		15400-PFB-007	18-7911-1
B360	18-7824	5035703		15400-PFB-014	18-7913
B37*	18-7895	FRAM		15400-PLM-A01PE	18-7909
B37*	18-7896	CH9954		15400-POH-305PE	18-7909
B43-S	18-7974	P9407		15400-POH-305PE	18-7909
B6	18-7876-1	PH10809		15400-ZJ1-004	18-7909
B7165	18-7884				

All listed oil capacities are approximate amounts only and may or may not include the oil filter capacity.
ALWAYS follow proper crankcase drain and fill procedures. Check engine dipstick for proper crankcase oil level.

GEAR LUBE CAPACITY CHARTS

GEAR LUBE CAPACITY CHART - HONDA ENGINES

Model	Oil Capacity		Model	Oil Capacity	
	Std. (Qt.)	Notes		Std. (Qt.)	Notes
BF2A/BF20	1.7		BF50A	17.6	UP to 3213356
BF5A/BF50	3.4		BF50A	13.9	FROM 3213357
BF8A/BF80	7.8		BF50D	13.9	
BF75/BF100	7.8		BF(P)60A	16	
BF(P)8D	9.6		BF75AT-AW	22.3	
BF9.9A	8.1		BF75AX	33.8	
BF(P)9.9D	9.6		BF75D	32.1	
BF15A	8.1		BF90AT-AW	22.3	
BF(P)15D	9.6		BF90AX	33.8	
BF(P)20D	9.6		BF90D	32.1	
BF25A	9.8		BF115A	33.8	
BF25D	9.1		BF115D	33.1	
BF30A	9.8		BF130A	33.8	
BF30D	9.1		BF135A	33.1	
BF35A	17.6		BF150A	33.1	
BF40A	17.6	UP to 3212165	BF200A	39.6	
BF40A	13.9	FROM 3212166	BF225A	39.6	
BF40D	13.9		BF250A	49.6	
BF45A	17.6				

GEAR LUBE CAPACITY CHART - JOHNSON/EVINRUDE/OMC ENGINES

Evinrude-Johnson Outboards			Evinrude-Johnson Outboards		
Model	Year	Capacity (Qt.)	Model	Year	Capacity (Qt.)
1.5	1968-70	1	14	1988-90	8
2	1971-85	2	15	1953-65	10
Colt@Junior@	1986-91	2	15	1956	9
2.0,2.3,3.3	1991-Thru	3	15	1974-Thru	9
2.5	1987-88	3	18	1957-73	9
3	1982-72	3	20	1966-73	9
3	1990-Thru	3	20	1985-Thru	11
4 (8110)	1969-82	4	25	1951-1955	14
4 (90)	1973-Thru	3	25	1969-84	9
Ultra 4, Excel 4	1987-91	3	25 Comm.	1985-Thru	9
4 Deluxe	1986-Thru	11	25 Comm. Thru Hub	1991-Thru	11
4 4-Stroke	2003	7	25	1985-Thru	11
4.5	1980-83	11	25, 30 4-Stroke	2000-01	8
5	1965-68	3	28	1962-64	14
5	1998	6.4	28	1986-Thru	9
5.5	1954-64	9	30	1956	14
6	1965-79	9	30	1984-Thru	11
6	1984-Thru	11	33	1965-70	14
6 4-Stroke	1997-Thru	11	35	1957-69	14
7.5	1951-53	4	35	1976-82	10
7.5	1954-56	9	35	1983-84	11
7.5	1980-83	11	35 45 Cu. In./737 CC	1987	22
8	1984-Thru	11	40	1960-76	14
8 4-Stroke	1999-Thru	9	40 Elec. Shift	1962-70	15
9.5	1964-73	10	40 Comm.	1981-90	14
9.9 2-Stroke	1974-Thru	9	40 Comm. (RS)	1991-Thru	16
9.9, 15 4-Stroke	1995-01	9	40 Comm. (RP,RW)	1993	22
9.9, 15 4-Stroke	2002-Thru	6	40	1984-88	22
10	1956-57	9	40	1989-Thru	16
10	1958-63	10			
14	1951-52	10			

*Sierra Premium Gear Lube (18-9600 series) recommended for under 75 HP • Sierra Hi-Performance Gear Lube (18-9650 series) recommended for 75 HP and above

GEAR LUBE CAPACITY CHARTS

GEAR LUBE CAPACITY CHART - JOHNSON/EVINRUDE/OMC ENGINES (CONT.)						
Evinrude-Johnson Outboards			Evinrude-Johnson Outboards			
Model	Year	Capacity (Oz.)	Model	Year	Capacity (Oz.)	
45 Comm.	1986-Thru	22	110	1986-89	26	
48	1987-88	22	112	1994-Thru	26	
46	1989-Thru	16	115 Elec. Shift	1969-70	27	
40, 50 4-Stroke	1999-Thru	21	115	1973-76	28	
50	1958-59	35	115 20"	1977	29	
50 1971-72 Electric	1971-74	26	115 25"	1977	35	
50	1975-88	22	115	1978	38	
50	1989-Thru	16	115	1979-85	27	
50 Comm.	1977-79	26	115	1990-Thru	26	
50 3 cyl. 56 Cu.In.	1995-Thru	22	115 4-Stroke	2003-Thru	36	
55 Electric Shift 3 Cyl	1968-69	26	115 60V4 EL, GL, SL	1995-Thru	31	
55	1976-79	22	115 60V4 EX, SX V6 G/C	1995-Thru	34	
55 Comm.	1980-Thru	22	120 V6 G/C	1985	34	
60 Std.	1964-67	20	120	1986-1993	26	
60 Heavy-Duty	1964-67	35	120 20"	1994	26	
60 Electric Shift	1970-71	26	120 25" V6 G/C	1994	34	
60	1980-85	22	125 Elec. Shift	1971-1972	27	
60	1986-Thru	22	130 V6 G/C	1995-Thru	34	
60 4-Stroke	2002-Thru	19	135	1973-74	28	
65 Standard	1968	20	135	1975-76	29	
65 Heavy-Duty	1968	35	140	1977	35	
65 1972 Electric	1972-73	26	140	1978	38	
65 Comm.	1984-Thru	22	140	1979-84	27	
70	1974-Thru	22	140 4-Stroke	2003-Thru	36	
70 4-Stroke	1998-Thru	19	140 V6 G/C	1985	34	
75	1960	22	140 V4 Loop	1986-87	26	
75 Man. Shift	1961-65	20	140 20" V4 Loop	1988-94	26	
75 Elec. Shift	1962-65	18	140 25" V6 G/C	1988-94	34	
75 15" Small G/C	1975-88	22	150	1978	43	
75 20"	1975-84	25	150	1979-82	29	
80 Man. Shift	1966-67	20	150 V6 Cross	1983-91	34	
80 Heavy-Duty	1966-67	35	150 60V6	1991-Thru	34	
80 Elec. Shift	1966-67	18	150 DI	1997-Thru	34	
85 Man. Shift - Std.	1968	20	150 Comm.	1993-Thru	34	
85 Elec. Shift	1968	18	155 Comm.	1984-90	77	
85 Elec. Shift	1969-71	27	155 Comm.	1991-92	34	
85 1972 Elec. Shift	1972-76	26	175	1977	44	
85 20"	1977	29	175	1978	43	
85 25"	1977	35	175	1979-82	29	
85	1978	38	175	1983	34	
85	1979-80	27	175 V6 Cross	1986-91	34	
85	1991-Thru	26	175 60V6	1991-Thru	34	
88	1987-Thru	26	175 DI	1998-Thru	34	
90 Elec. Shift	1964-65	18	185	1984-85	34	
90 Cross V4	1981-Thru	26	200	1976-77	44	
90 60V4 EL, SL	1995-Thru	31	200	1978	43	
90 60V4 EX, SX V6 G/C	1995-Thru	34	200	1979-82	29	
90 4-Stroke	2003-Thru	36	200	1983	34	
100" Elec. Shift	1966	28	200 V6 Loop	1986-Thru	34	
100 Elec. Shift	1967-68	38	200/225 4-Stroke	2004	37	
100 Elec. Shift	1971-72	27	225 V6 Loop	1986-Thru	34 V6 Core 31	
100	1979-80	27	235	1978	43	
100	1988-Thru	26	235	1979-82	28	
100 Comm. V6 G/C	1984-Thru	34	235	1983-85	34	

GEAR LUBE CAPACITY CHARTS

GEAR LUBE CAPACITY CHART - JOHNSON/EVINRUDE/OMC ENGINES (cont.)

Evinrude-Johnson Outboards			Evinrude-Johnson Outboards		
Model	Year	Capacity (Oz.)	Model	Year	Capacity (Oz.)
2.6L	1984-85	34	V4/V6 w/ Type D	2002-Thru	34
250 V8 Loop	1991-Thru	77	V4/V6 w/ Type D - Counter Rot.	2002-Thru	31
275 V8 Loop	1985-87	77 V8 Coro 72	V6 Type L Gearcase	2002-Thru	34
300 V8 Loop	1985-Thru	77	V6 Type L2 - GLE	2009-Thru	32.5
3.6L V8 Loop	1985-87	77	V6 Type M	2002-Thru	44
4.0 V8 Loop	1988-92	77	V6 Type M - Counter Rot.	2002-Thru	41
Turbo Jet	1994-Thru	84.6	V6 Type M2	2009-Thru	38.9
Magnum	2002-Thru	44	V6 Type M2 - Counter Rot.	2009-Thru	35.8
Magnum CX	2002-Thru	41	* Gearcase with Fill Plug Above Cavitation Plate 32 Oz.		

GEAR LUBE CAPACITY CHART - JOHNSON/EVINRUDE/OMC ENGINES

OMC Cobra®		OMC Cobra®	
Model	Capacity (Oz.)	Model	Capacity (Oz.)
2.3L, 128 Model	60	262 OMC King Cobra	64
2.5L	60	350 OMC King Cobra	64
3.0L (1990-93)	64	460 OMC King Cobra	108
3.0L 130 Model	60	460 OMC King Cobra (Cone Clutch)	103
4.3L 175 Model	64	1990-94 King Cobra (Cone Clutch)	103
5.0L	64	1994-Thru Cobra (Cone Clutch)	71
5.7L, 260 Model	64	1996-Thru Dual Prop	81
7.5L	108	OMC Sail Drive	—
1990-93 3.0L, 3.0L HO	64	1977-86	20
185, 200, 235 Models	64		

GEAR LUBE CAPACITY CHART - MERCURY ENGINES

Brand	Model	Cycle	Model Note	Oz.	mL
Mercury/Mariner	2.2, 2.5, 3.3	2 Cycle		4.5	135
Mercury/Mariner	4.5	2 Cycle		6.8	200
Mercury/Mariner	6, 8, 9.9, 15	2 Cycle		6.8	200
Mercury/Mariner	20, 25	2 Cycle		8.8	260
Mercury/Mariner	30, 40	2 Cycle	2 cylinder	14.9	440
Mercury/Mariner	40, 50	2 Cycle	3 cylinder, std. Gearcase	14.9	440
Mercury/Mariner	55, 60	2 Cycle	Standard Gearcase	11.5	340
Mercury/Mariner	60	2 Cycle	Big Foot	22.5	665
Mercury/Mariner	75, 90	2 Cycle	3 cylinder	22.5	665
Mercury/Mariner	100, 115, 125	2 Cycle	4 cylinder	22.5	665
Mercury/Mariner	115	2 Cycle	3 cylinder Optimax	22.5	665
Mercury/Mariner	135, 150	2 Cycle	2.0L	22.5	665
Mercury/Mariner	150, 175, 200	2 Cycle	2.5L Carb/EFI/Optimax	22.5	665
Mercury/Mariner	200, 225, 250	2 Cycle	3.0L Carb/EFI/Optimax	27	798
Force	5	2 Cycle		4	120
Force	9.9, 15	2 Cycle		6.8	200
Force	25	2 Cycle		8.8	260
Force	40, 50	2 Cycle		14.9	440
Force	75	2 Cycle		12	355
Force	90, 120	2 Cycle		22.5	655
Mercury/Mariner	4.5	FourStroke		6.8	200
Mercury/Mariner	8, 9.9	FourStroke	MY 2004 & prior Standard Gearcase	6.8	200
Mercury/Mariner	8, 9.9	FourStroke	MY 2005 & newer	10.8	320
Mercury/Mariner	9.9	FourStroke	MY 2004 & prior Big Foot	8.8	260
Mercury/Mariner	9.9	FourStroke	MY 2005 & newer Big Foot	12.5	370

GEAR LUBE CAPACITY CHARTS

GEAR LUBE CAPACITY CHART - MERCURY ENGINES (cont.)

Brand	Model	Cycle	Model Note	Qt.	ml.
Mercury/Mariner	15	FourStroke	Standard Gearcase	6.8	200
Mercury/Mariner	15	FourStroke	Big Foot	8.8	260
Mercury/Mariner	25	FourStroke	Big Foot	14.9	440
Mercury/Mariner	30, 40	FourStroke	3 cylinder, standard Gearcase	14.9	440
Mercury/Mariner	30, 40	FourStroke	3 cylinder, Big Foot	22.5	665
Mercury/Mariner	40, 45, 50	FourStroke	4 cylinder, 935 cc, standard Gearcase	14.9	440
Mercury/Mariner	40, 45, 50	FourStroke	4 cylinder, 935 cc, Big Foot	22.5	655
Mercury/Mariner	40	FourStroke	4 cylinder, 996 cc, Big Foot	24	710
Mercury/Mariner	50, 60	FourStroke	4 cylinder, 996 cc, standard Gearcase	11.5	340
Mercury/Mariner	50, 60	FourStroke	4 cylinder, 996 cc, Big Foot	24	710
Mercury/Mariner	75, 90	FourStroke		22.5	665
Mercury/Mariner	115	FourStroke		24	710
Mercury/Mariner	200	FourStroke	Verado (RH Rotation)	32.8	970
Mercury/Mariner	225	FourStroke	Standard Gearcase	39	1,15L
Mercury/Mariner	225/250/275	FourStroke	Verado (RH Rotation)	32.8	970

GEAR LUBE CAPACITY CHART - MERCUISER STERNDRIVE

Brand	Model	Cycle	Model Note	Qt.	ml.
MerCruiser	Vazer Drive	4 cycle	with Gear Lube Monitor	2.0 US Quarts	1.9L
MerCruiser	Alpha One Gen II	4 cycle	without Gear Lube Monitor	1.22 US Quarts	1.16L
MerCruiser	Alpha One Gen II	4 cycle	with Round Gear Lube Monitor	2.0 US Quarts	1.9L
MerCruiser	Alpha One Gen II	4 cycle	with Rectangular Gear Lube Monitor	1.75 US Quarts	1.66L
MerCruiser	Bravo One	4 cycle	without Gear Lube Monitor	2.0 US Quarts	1.9L
MerCruiser	Bravo One	4 cycle	with Round Gear Lube Monitor	3.25 US Quarts	3.07L
MerCruiser	Bravo One	4 cycle	with Rectangular Gear Lube Monitor	2.75 US Quarts	2.6L
MerCruiser	Bravo Two	4 cycle	without Gear Lube Monitor	2.5 US Quarts	2.4L
MerCruiser	Bravo Two	4 cycle	with Round Gear Lube Monitor	3.75 US Quarts	3.55L
MerCruiser	Bravo Two	4 cycle	with Rectangular Gear Lube Monitor	3.25 US Quarts	3.07L
MerCruiser	Bravo Three	4 cycle	without Gear Lube Monitor	2.0 US Quarts	1.9L
MerCruiser	Bravo Three	4 cycle	with Rectangular Gear Lube Monitor	3.0 US Quarts	2.84L
MerCruiser	Blackhawk	4 cycle	without Gear Lube Monitor	1.75 US Quarts	1.66L
MerCruiser	Blackhawk	4 cycle	with Rectangular Gear Lube Monitor	2.25 US Quarts	2.1L

GEAR LUBE CAPACITY CHART - NISSAN ENGINES

Model	Approximate Fluid Quinces Required	Model	Approximate Fluid Quinces Required
2A & 3.5A (4-Stroke)	6.1	25 (4-Stroke)	9.5
2.5A & 3.5A (2-Stroke)	3	30 (2-Stroke)	14.5
3.5B (2-Stroke)	6	30 (4-Stroke)	9.5
4 (4-Stroke)	6.6	40C (2 cyl)	15.9
5 (2-str/4-str)	6.6	40D (3 cyl)	16.9
6 (4-Stroke)	6.6	NSD40 (TLDI) / NSF40	16.9
8 (2-str/4-str)	10.8	50D (3 cyl)	16.9
9.8 (2-str/4-str)	10.8	NSD50 (TLDI) / NSF50	16.9
9.9 (2-Stroke)	12.5	70B (3 cyl)	23.7
9.9A (4-Stroke)	6.8	70C (3 cyl)	30.4
9.9B (4-Stroke)	12.5	NSD70 / 75 (TLDI)	30.4
15 (2-Stroke)	12.5	90A (2-Stroke)	30.4
15A (4-Stroke)	6.8	NSD90 (TLDI)	30.4
15B (4-Stroke)	12.5	115A (2-Stroke)	30.4
18 (2-str/4-str)	12.5	NSD115 (TLDI)	30.4
20 (4-Stroke)	12.5	140A (2-Stroke)	30.4
25 (2-Stroke)	14.5		

* Sierra Premium Gear Lube (18-9600 series) recommended for under 75 HP • Sierra Hi-Performance Gear Lube (18-9650 series) recommended for 75 HP and above

GEAR LUBE CAPACITY CHARTS

GEAR LUBE CAPACITY CHART - SUZUKI ENGINES

Model	Gear Case Oil Capacity (CC)	Gear Case Oil Capacity (Oz.)	Model	Gear Case Oil Capacity (CC)	Gear Case Oil Capacity (Oz.)
DT2 (Short Shaft)	70	2.4	DT40	610	20.6
DT2 (Long Shaft)	120	4	DF40/50	610	20.6
DT3.5	85	2.9	DT50/55/60/65	650	22
DT4	190	6.4	DF60/70	600	20.3
DF4/6	190	6.4	DT75/85	700	23.7
DT5/6/8	240	11.5	DT90/100	560	18.9
DT8C/9.9C/9.9CN	175	5.9	DT115/140	1100	37.2
DF9.9/15	175	5.9	DF90/115/140	1050	35.5
DT9.9/15/15C	170	5.7	DT150/175/200/225	1050	35.5
DT20/25/30/30C/35C	230	7.8	DF150/175/200/225/250/300	1100	37.2
DF25/30	230	7.8			

GEAR LUBE CAPACITY CHART - YAMAHA ENGINES

Model	CC	Oz.	Model	CC	Oz.
2	45	1.5	F50	430	14.5
F2.5	75	2.5	T50 (1996-00)	430	14.5
3	75	2.5	T50 (2001-02)	610	20.6
4	105	3.6	C55	500	16.9
F4	100	3.5	60	610	20.6
5	105	3.6	E60	610	20.6
6	160	5.4	F60	430	14.5
8	160	5.4	P60	610	20.6
F8	150	5.1	T60	670	23
T8	320	10.9	70	610	20.6
9.9	185	6	C70	610	20.6
F9.9	185	6	C75	610	20.6
T9.9	320	10.8	E75	610	20.6
15 (1984-97)	185	6.03	F75	670	23
15 (1998-02)	250	8.5	P75	610	20.6
F15	250	8.5	C80	610	20.6
20	370	12.7	F80	670	23
25 (1984-87)	180	6.1	C85	610	20.6
25 (1988-02)	370	12.7	90/B90/C90	610	20.6
25 3cyl.	200	6.8	F90	670	23
C25	180	6.1	F100	670	23
F25	320	10.8	115	760	25.7
T25	430	14.5	B115/C115	760	25.7
30	200	6.8	F115	760	25.7
30 (1984-86) 3cyl.	180	6.1	LF115	715	24.2
30 (1987-02) 3cyl.	200	6.8	P115/S115	760	25.7
C30 (1989-92)	180	6.1	130	760	25.7
C30 (1993-97)	320	10.8	L130	715	24.2
F30	430	14.5	S130	760	25.7
40 (1984-94)	415	14	150	980	33.1
40 (1995-02)	430	14.5	C150	980	33.1
C40 (1989-97)	315	10.6	D150 (1997-99)	900	30.4
C40 (1997-02) 3cyl.	430	14.5	DX150 (1999)	980	33.1
F40	430	14.5	L150	870	29.4
E48	500	16.9	SX150 (1999-02)	980	33.1
50/P50 (1984-94)	415	14	V150 (1998-99)	980	33.1
50/P50 (1995-02)	430	14.5			
C50	430	14.5			

*Sierra Premium Gear Lube (18-9600 series) recommended for under 75 HP • Sierra Hi-Performance Gear Lube (18-9650 series) recommended for 75 HP and above

GEAR LUBE CAPACITY CHARTS

GEAR LUBE CAPACITY CHART - YAMAHA ENGINES (cont.)					
Model	CC	Oz.	Model	CC	Oz.
VX150	980	34.5	Model	CC	OZ
VZ150	980	33.1	LX225	1000	33.8
Z150	980	33.1	S225 3.1L	1150	38.9
175 (1984-99)	980	33.1	SX225	1000	33.8
P175	980	33.1	V225 3.1L	1150	38.9
S175	980	33.1	VX225	1150	38.9
V175	980	33.1	VZ225 3.3L	1000	33.8
VZ175	980	33.1	250	1150	38.9
Z175	980	33.1	L250	1000	33.8
200 (1984-99)	980	33.1	Model	CC	OZ
F200	1150	38.9	LX250	1000	33.8
L200 (1986-95)	900	30.4	S250	1150	38.9
L200 (1996-99)	870	30.4	LZ250 3.3L	1150	38.9
LF200	1000	33.8	SX250	1150	38.9
LX200 (1999-02)	980	33.1	VX250	1150	38.9
LZ200	870	29.4	VZ250 3.3L	1000	33.8
P200	980	33.1	Z250 3.3L	1000	33.8
LF225	1000	33.8			

*Sierra Premium Gear Lube (18-9600 series) recommended for under 75 HP • Sierra Hi-Performance Gear Lube (18-9650 series) recommended for 75 HP and above

