

SHAD

ZONTES U1 125 / U 125 '20

ZOU110IF

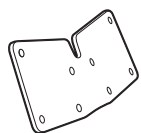

1 262675 x1



2 260213 x4
Ø16 Ø9 x12



3 303020 x6
Ø8

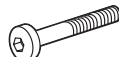

4 304169 x4
M8 x 50 DIN 7380

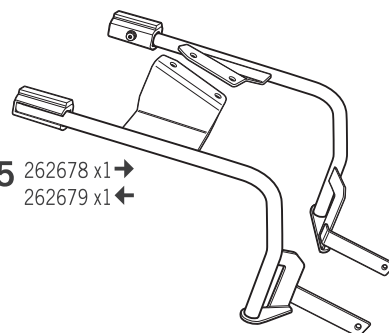

5 262678 x1 →
262679 x1 ←



6 303045 x10
Ø8

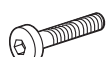

7 304053 x6
M8 x 30 DIN 7380



8 302024 x6
M8



9 260648 x2
Ø16 Ø9 x5

! WARNING!

GB

Do not fully tighten the screws until it is ensured that the KIT is correctly attached and aligned.

ATTENTION: For a full equip assembly, mount the 3P System after the top master.

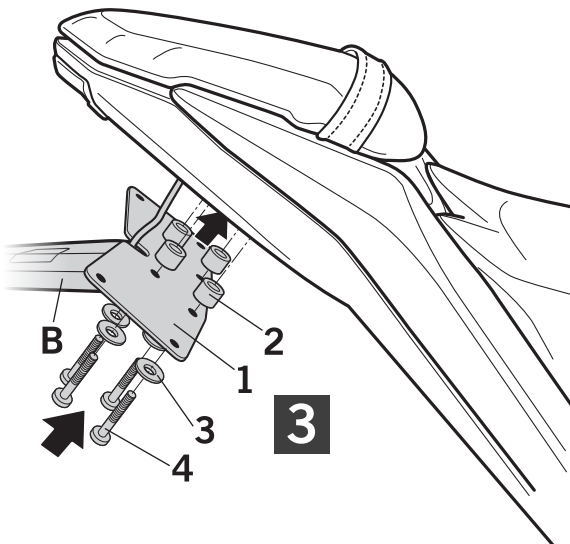
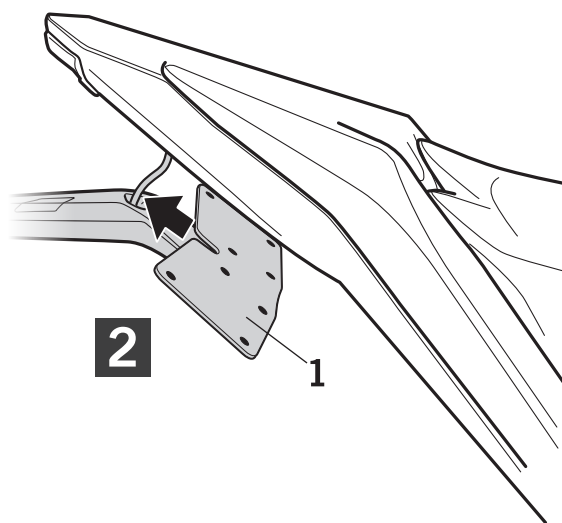
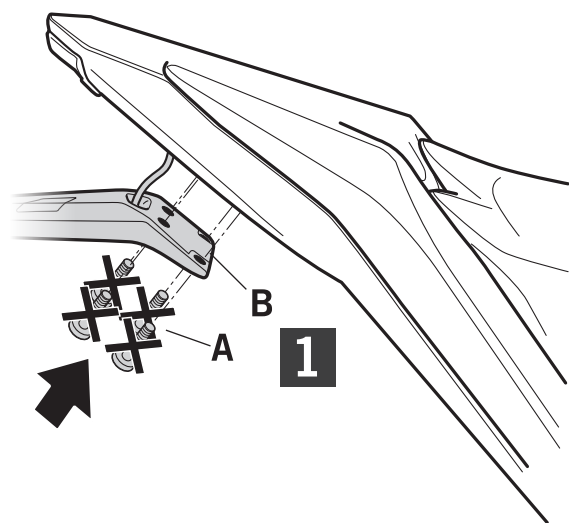

IMPORTANT: Based on European models.

