

SHAD

YAMAHA MT 03 '21

YOMT31IF

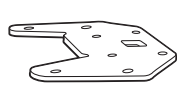

1 262723 x1



2 260641 x2
Ø16 Ø9 x 22



3 260596 x2
Ø16 Ø9 x 20

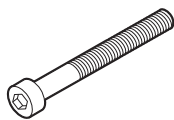

4 304178 x4
M6 x 60 Din 912



5 303017 x9
Ø6

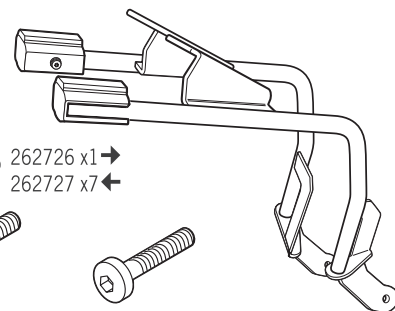

6 262726 x1 →
262727 x7 ←



7 302021 x4
M6

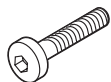

8 304053 x4
M8 x 30
Din 7380



9 303045 x10
Ø8



10 302024 x5
M8



11 260648 x4
Ø16 Ø9 x 5

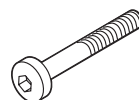

12 304069 x1
M8 x 55
Din 7380

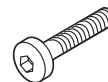

13 304079 x1
M6 x 30
Din 7380



WARNING!

(GB) Do not fully tighten the screws until it is ensured that the KIT is correctly attached and aligned.

ATTENTION: For a complete set of equipment, mount the TOP bracket above the stand (1).

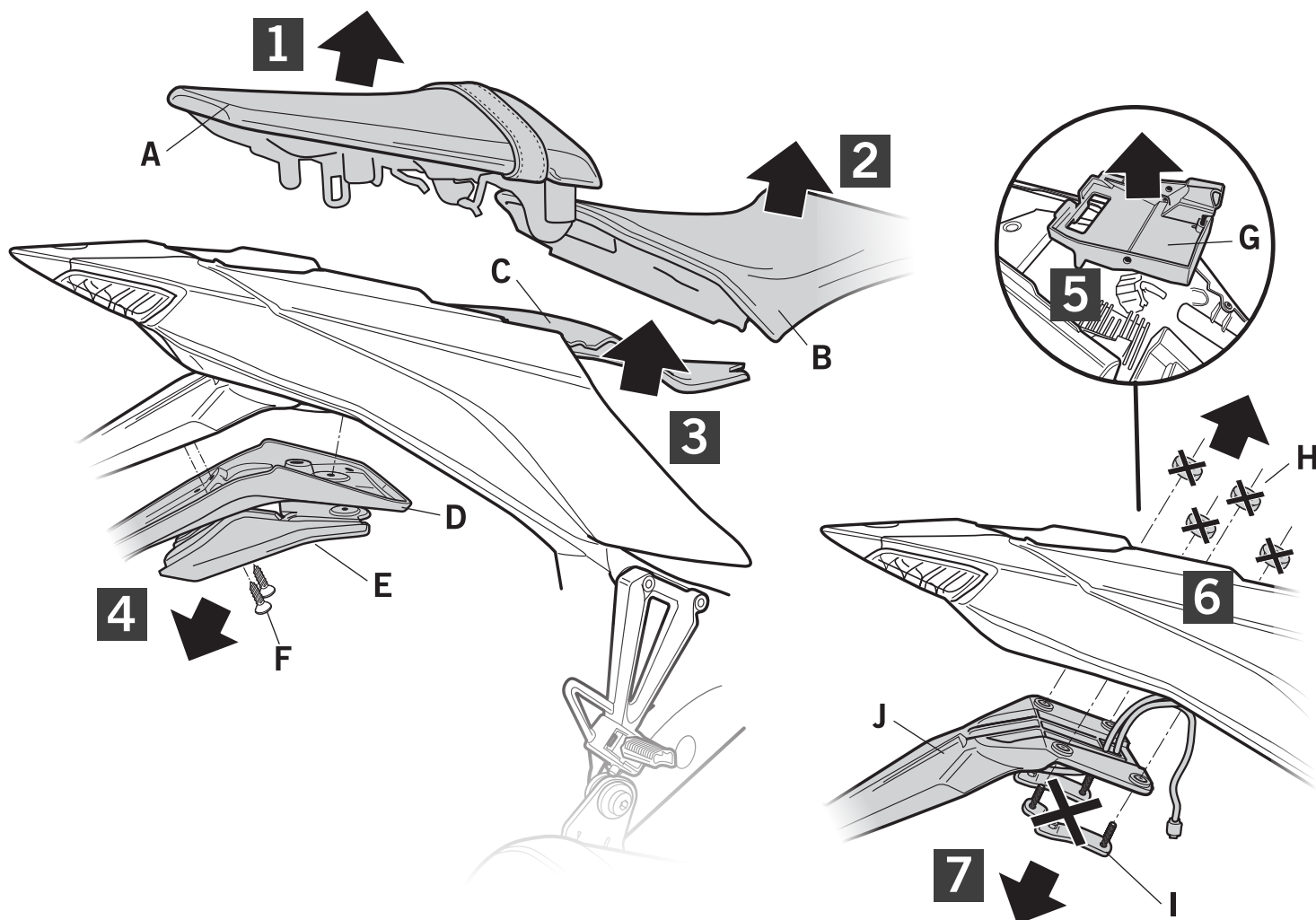

IMPORTANT: Based on European models.

