

# SADDLE BAGS

Ref: X0SE48

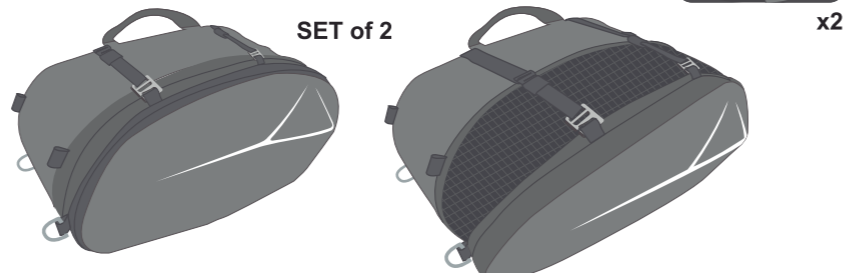

# SHAD SOFTBAGS

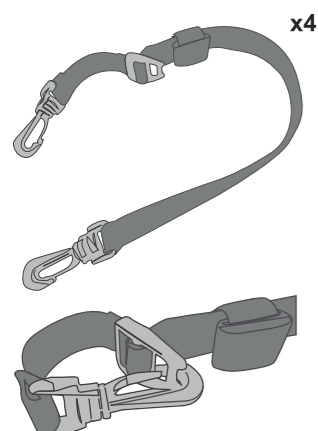
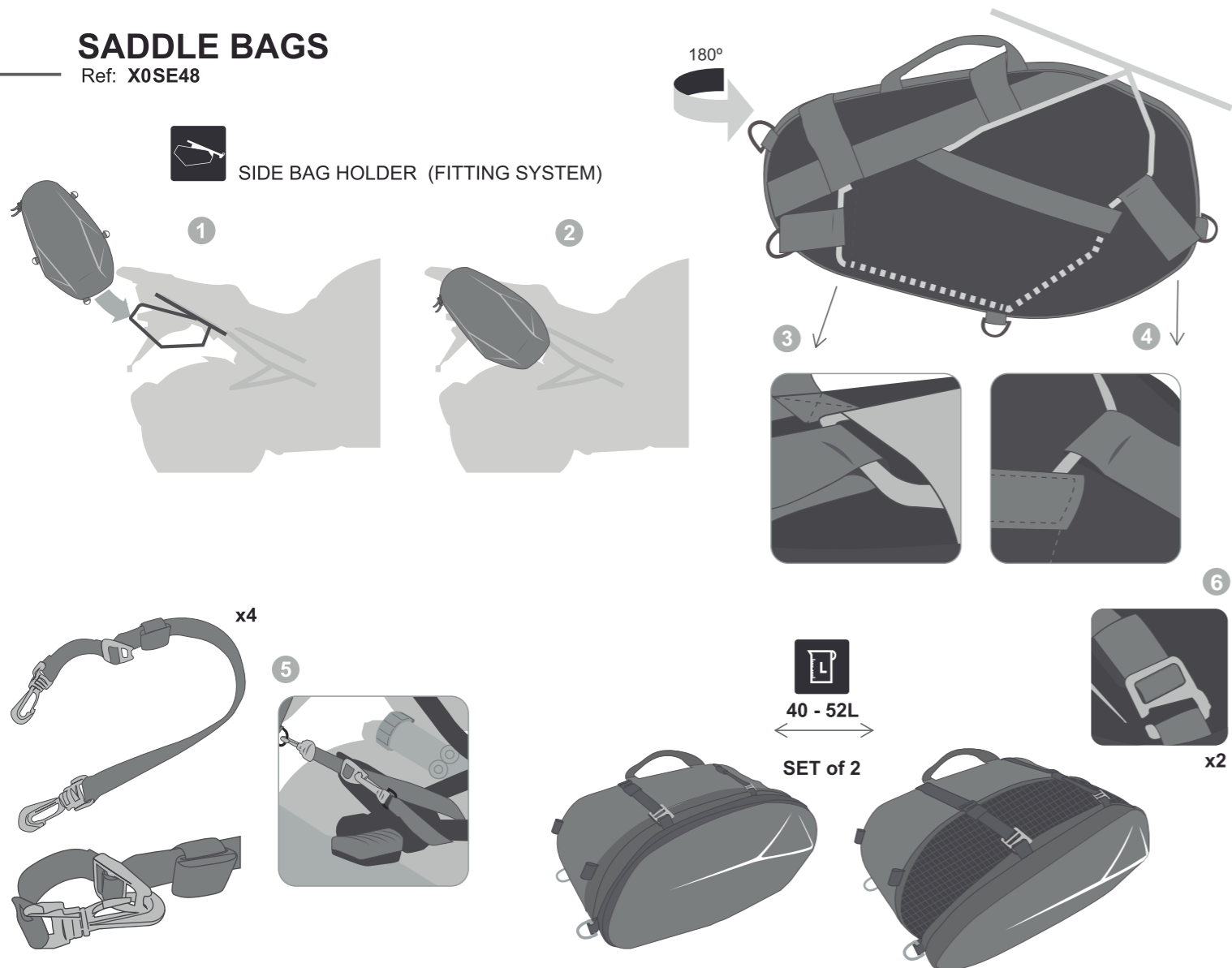
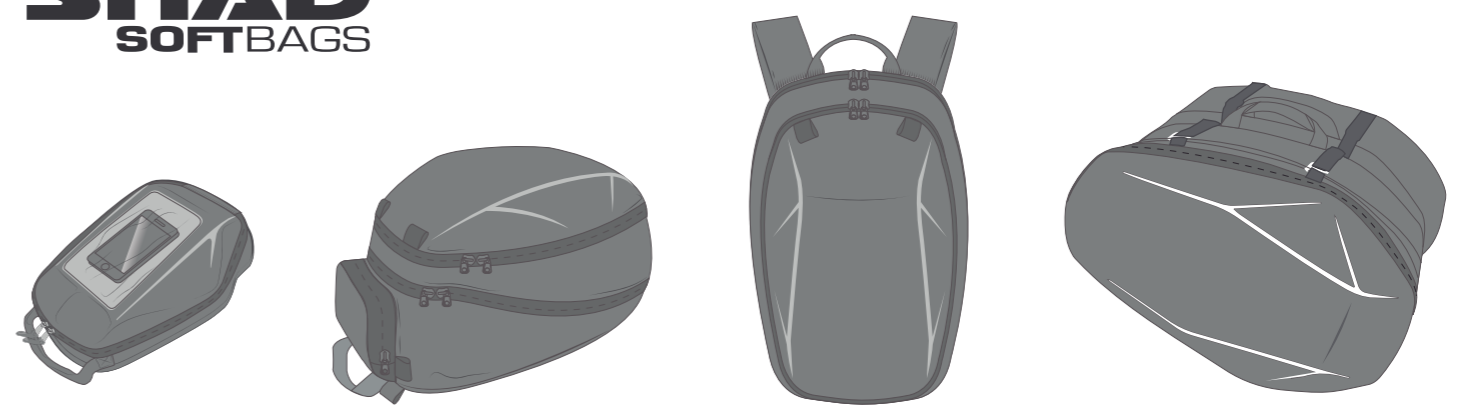

Ref: X0SE04  
Name: Tank Bag 3L

- Semi rigid
- Capacity 3L
- Water resistant zipper
- Universal base tank
- Inner pockets
- Reflective
- Rain cover
- Outlet for USB charger
- Mobile phone holder
- Touch screen

Ref: X0SE22  
Name: Tank Bag 16L

- Semi rigid
- Capacity 16L - 21L
- Water resistant zipper
- Universal base tank
- Inner pockets
- Reflective
- Rain cover
- Outlet for USB charger
- Compression straps
- Expandable
- Shoulder strap

Ref: X0SB83  
Name: Backpack with laptop protection

- Semi rigid
- Capacity 17L
- Water resistant zipper
- Helmet holder
- Inner pockets / laptop compartment
- Reflective

Ref: X0SE48  
Name: Saddle Bags

- Semi rigid
- Capacity 40L - 52L
- Water resistant zipper
- Expandable
- Compression straps
- Reflective
- Rain cover
- Inner reinforcement

## WARNING

Clean the tank of the bike before placing the Universal Base Tank to avoid scratches in the paint.

Make sure the bag and its accessories are properly assembled.

When cleaning the bags use a damp cloth with neutral soap, always avoid using solvents or chemical products.

Prolonged exposure to weather might discolor fabrics and wear away plastic components.

Waterproof zippers and rain covers do not guarantee that the bag is fully water resistant.

Use zippers with care. To open the bags slide zip all the way without forcing.

The maximum speed of the motorcycle with the bag must not exceed 120 Km/h / 74 Mph (this may vary depending on the legislation of each country).

Load capacity. Tank bag SE-22: 2 Kg (4 Lb) max. Saddle bags SE-48: 2 Kg (4 Lb) / each max. Backpack SE-83: 3 Kg (6 Lb) max.

SHAD will not hold responsibility for damages caused by an incorrect assembly.

# INSULATION THERMAL PAD - ACCESSORY -

Ref: X1SB97

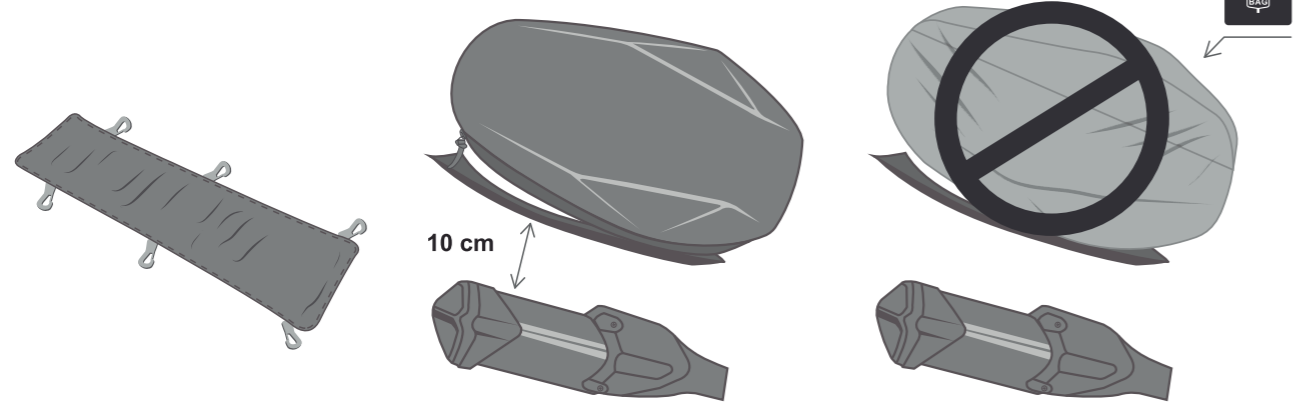

10 cm



## UNIVERSAL BASE TANK

Included in Tank bags E-04, E-22

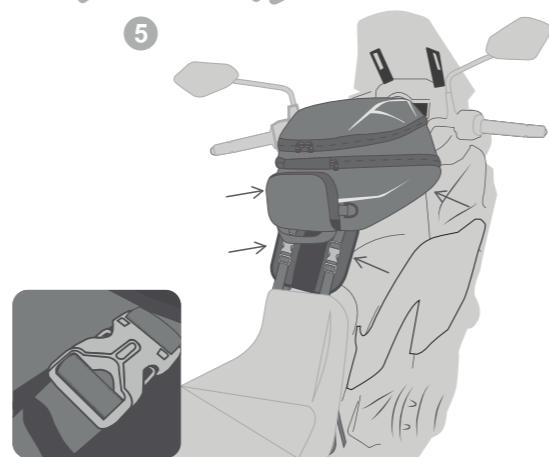
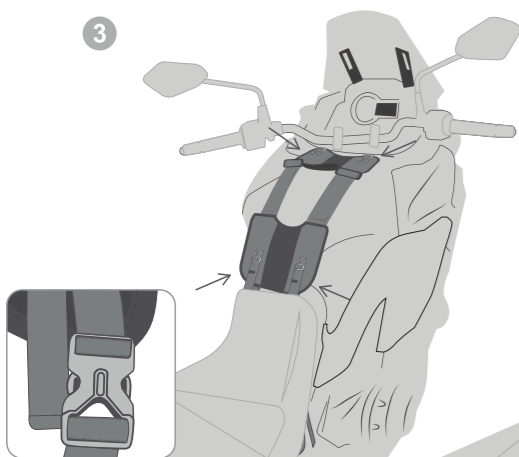
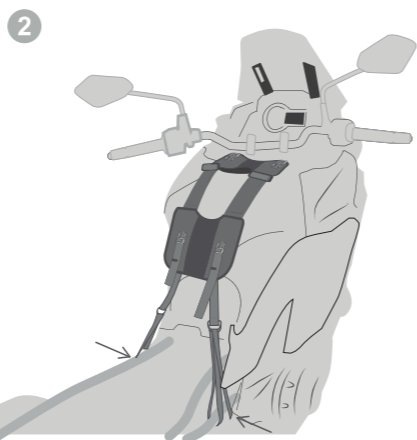
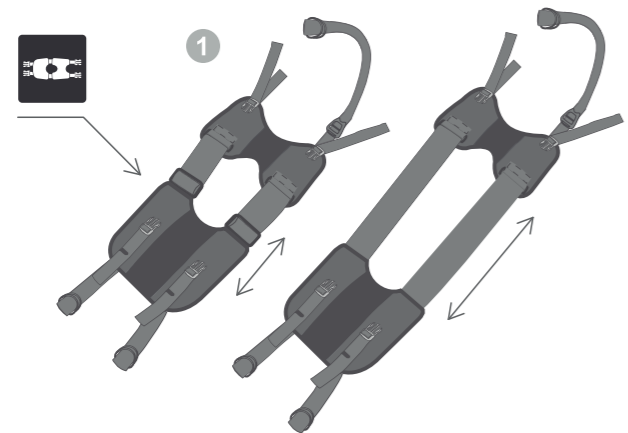

x4

x4

## SMALL TANK BAG E-04

Ref: X0SE04

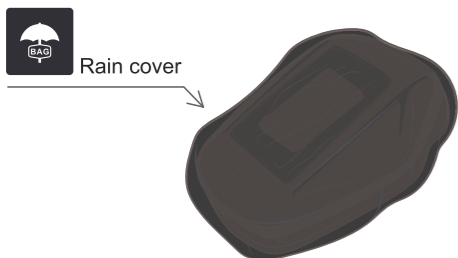

Cable outlet for USB Universal adapter for motobike X1 SB95

### OPTIONAL ACCESSORIES - SOLD SEPARATELY



USB Universal Moto Charger  
Ref: X1SB95



Magnets system  
Ref: X1SL11

## TANK BAG E-22

Ref: X0SE22

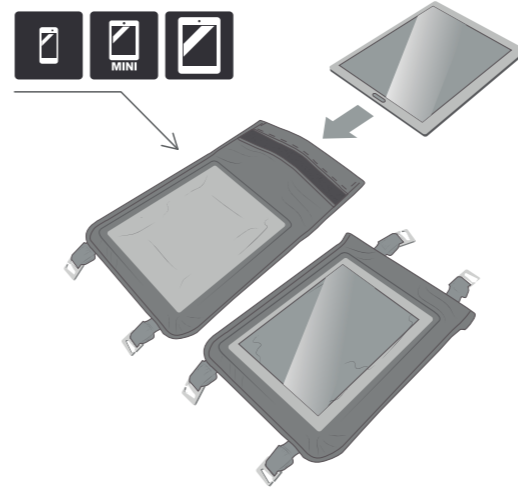

Mobile/Tablets holder  
Optional Accessory - Sold separately

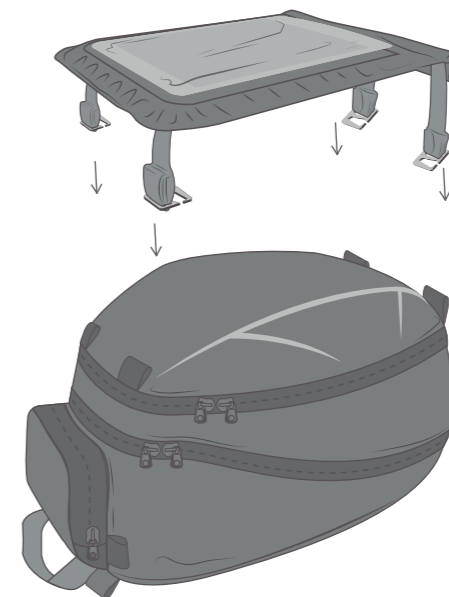

Rain cover



16 - 21L

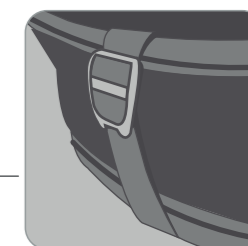
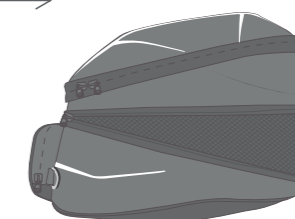
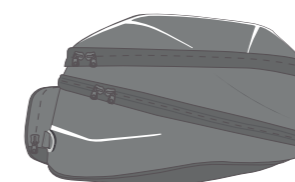

Adjustable buckle

### OPTIONAL ACCESSORIES - SOLD SEPARATELY



USB Universal Moto Charger  
Ref: X1SB95



Magnets system  
Ref: X1SL11

## BACKPACK E-83

with laptop protection  
Ref: X0SE83



x4



Helmet Holder  
Included

Discover other luggage systems & saddlebags on our website.