

PIN SYSTEM INSTALLATION

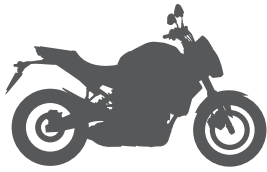

Motorcycle

1 REF. 262054 M4	2 REF. 304085 M4 x 25 DIN 913	3 REF. 260241 Ø8 x Ø5,5 x 2
<p>x3</p>	<p>x3</p>	<p>x3</p>

1

2

3

2.5 N·m

PLATE INSTALLATION

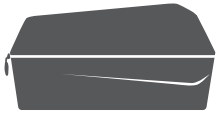

Tank Bag

3 REF. 20119N	4 REF. 262055	5 REF. 304208 Torx 20 Ø 4 x 16
<p>x1</p>	<p>x1</p>	<p>x3</p>

4

5

Check your bag's manual before the installation of the fitting plate.
Always use the security strap.

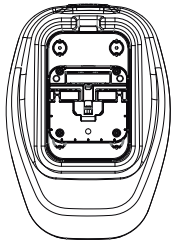

E16P

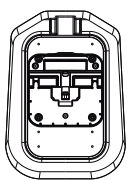

E10P

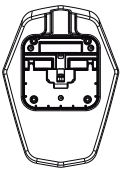

E04P

QUICK FITTING TANK BAGS

Easy to use, easy to install

Installation



Usage



Fully integrated



**PATENT
PENDING**



1 PLATE FOR TANK BAG

2 PINS FOR BIKE TANK

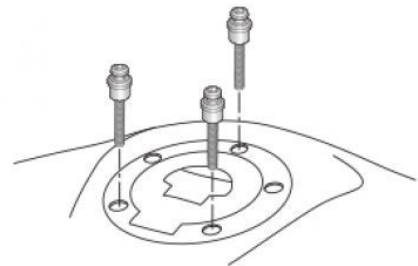
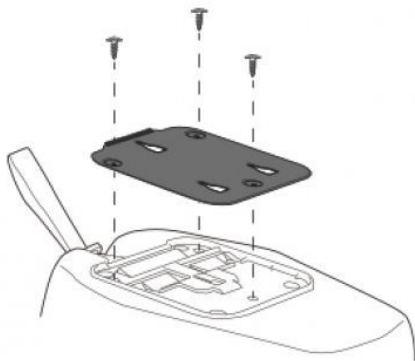

1 PLACE

2 REMOVE

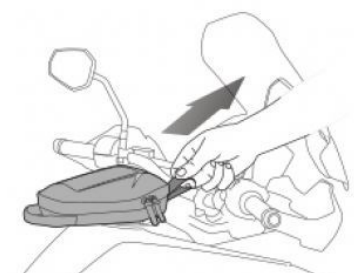

Discover other luggage systems & saddlebags on our website.