

Advice for correct fitting of the kit: Do not fully tighten the screws until sure that the kit is correctly positioned and aligned. **Note:** If the bike already has KIT SIDE (KOER65SF) assemble KIT TOP (KOER65ST) according to the instructions.

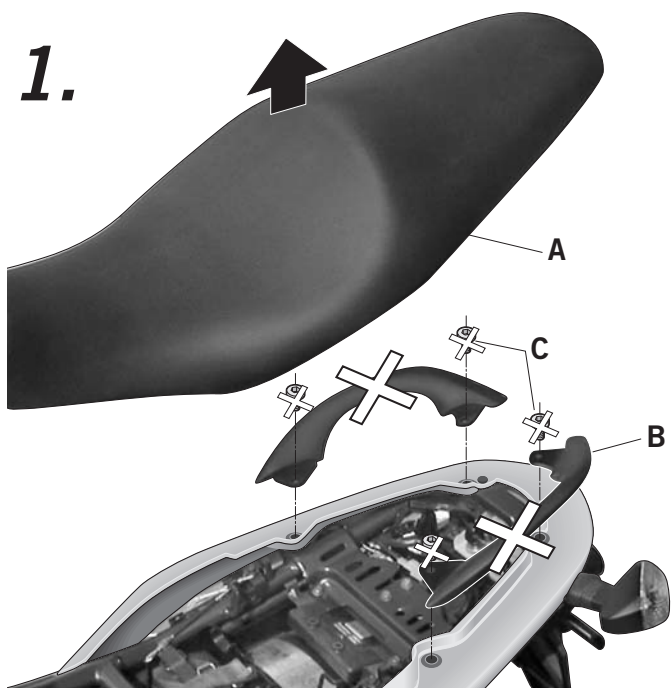

Take apart the seat (A).
 Take apart and loosen the side handles (B), through the screws (C) which also need loosening.

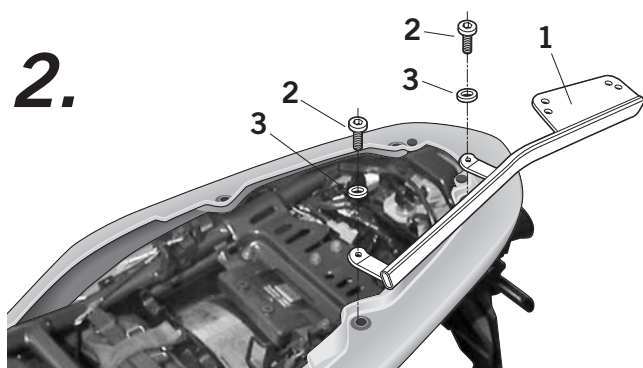



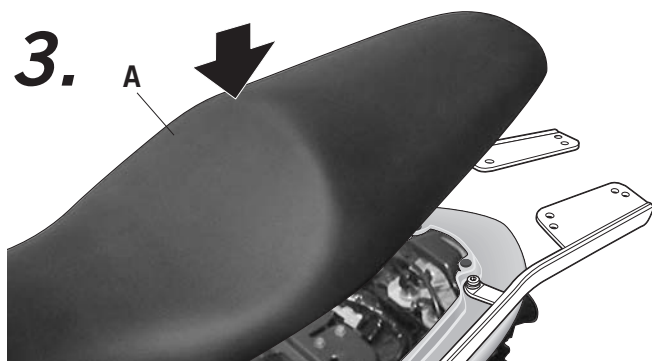

Assemble the kit top support (1) using washers (3) and screws (2).



Assemble the seat (A).

PARTS :

Pos.	Ref.		Cant.	
1	260440		1	Top right support
	260441		1	Top left support
2	304028		4	M8 x 25 DIN 7380 - Screw
3	303020		4	Ø8 - Washer

