

**Proper kit assembly:** Do not fully tighten the screws until it is ensured that the KIT is correctly attached and aligned.  
**N.B.** If your motorbike already has KIT TOP (HOVF82 SF) first dismantle and take out side handgrips (B) and attach KIT TOP supports as shown in the instructions, but removing the thick panels (1).

1.

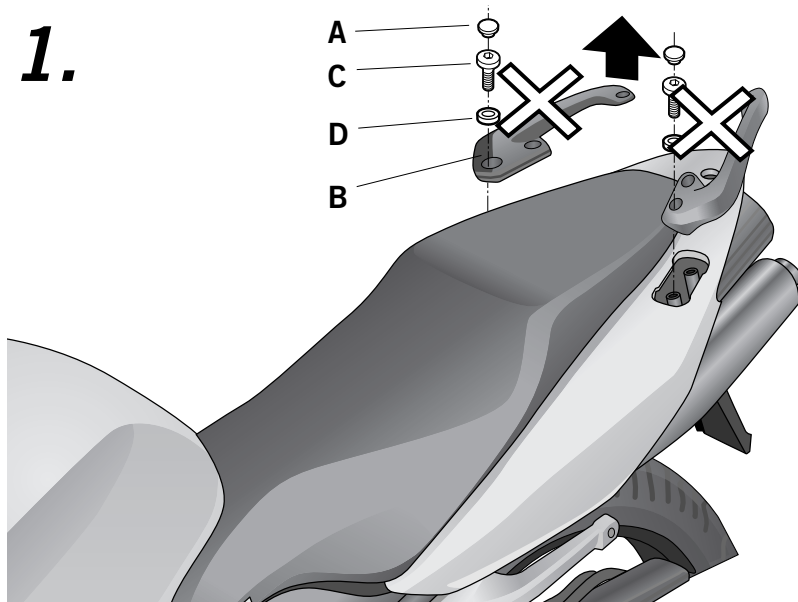





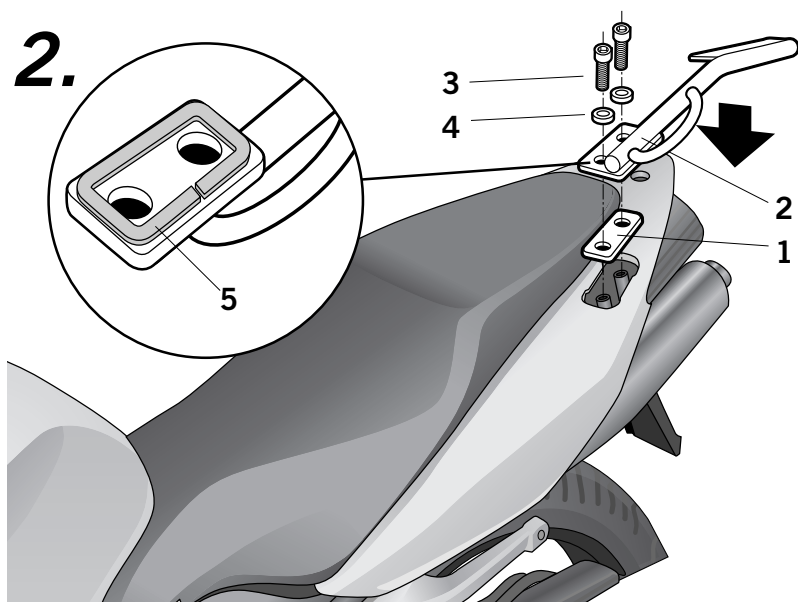

Dismantle and remove covers on handgrips (A). Dismantle and remove side handgrips (B) using screws (C) and washers (D), remove these screws and washers.

2.



Place the protective stickers (5). Attach the thick panels (1) into the side handgrip housing (B). Mount KIT TOP supports (2) and attach them with screws (3) and washers (4).

**PARTS :**

Pos.	Ref.		Cant.	
1	260702		2	79 x 25 x 5 - Thick panel
2	260703		1	Right top kit support -
	260704		1	Left top kit support
				Supporto sinistro kit top
3	304039		4	M8 x 40 DIN 7380 - Screw
4	303020		4	Ø8 - Washer
5	201022		0,54 m	Adhesive

Discover other luggage systems & saddlebags on our website.