

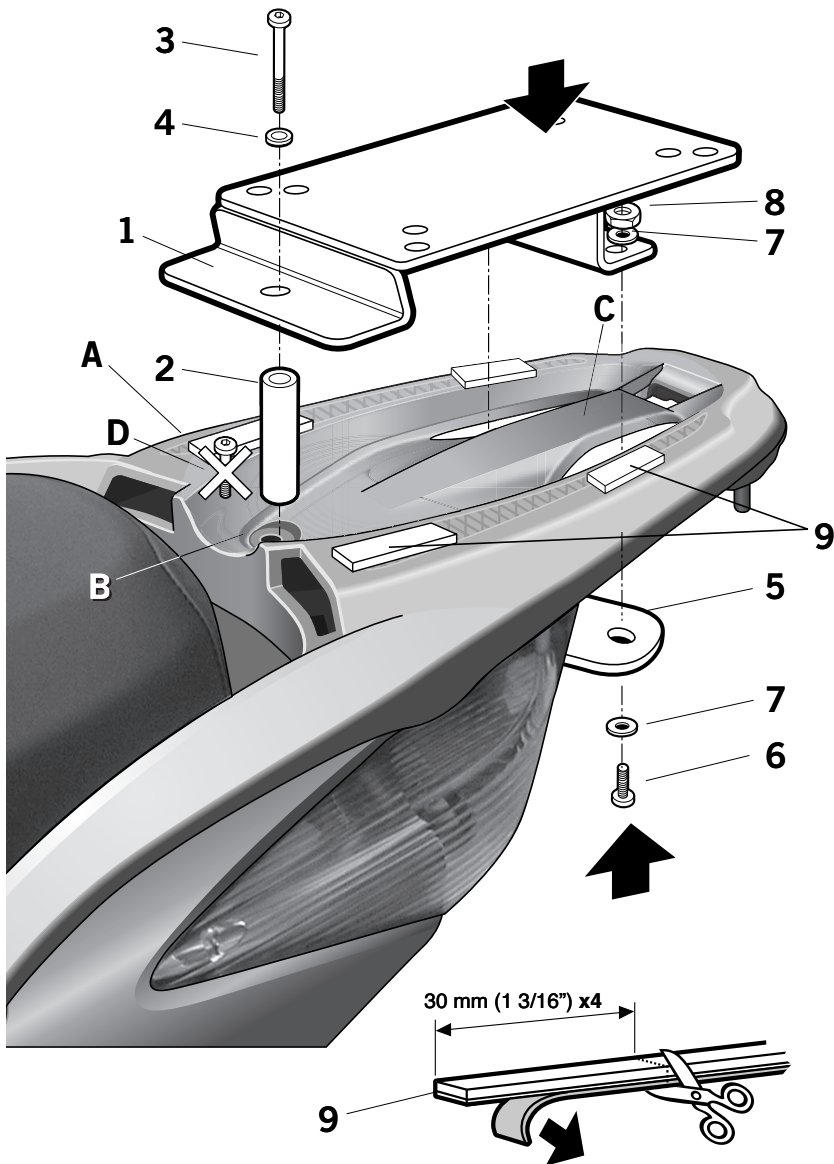









Advice for correct fitting of the kit: Do not fully tighten the screws until it is ensured that the KIT is correctly attached and aligned.

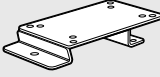

Dismantle and remove the screw (D). Put the adhesive rubber (9) as show in the draw in order to protect the fairing. Assemble the KIT TOP support (1) on the original fold-back seat (A) of the motorcycle and fix it in area (B) using the distance piece (2), the screw (3) and the washer (4). And in area (C) using the flange (5), the screws (6), the washers (7), and the nuts (8).

**HONDA SH125i SH150i SCOOPY '10**  
HOSH10ST  
**KIT TOPMASTER**

**PARTS:**

Pos.	Ref.		Cant.	
1	260983		1	Ø14 Ø9 x 29 - Spacer
2	261316		1	KIT TOP
3	304170		1	M8 x 60 DIN 7380 - Screw
4	303020		1	Ø8 - Washer
5	261317		1	Cover flange
6	304103		2	M6 x 45 DIN 912 - Screw -
7	303017		4	Ø16- Ø6 - Washer
8	302021		2	Self-blocking Nut M6
9	400253		120 mm	Protective stickers

**SHAD**

REF. 500479  
Edición 2ª

Discover other luggage systems & saddlebags on our website.