

SH47

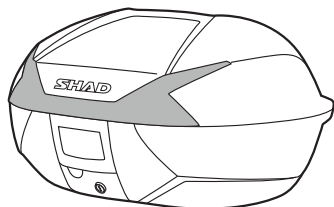

SH46

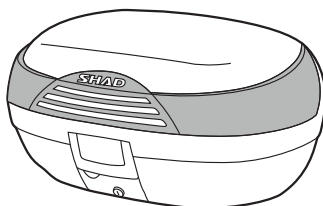

SH45

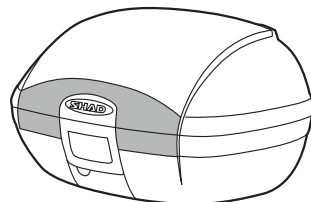

SH42

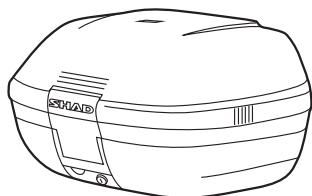

SH40

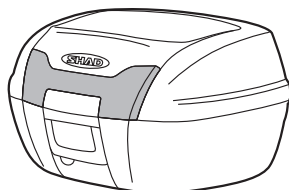

SH40 CARGO

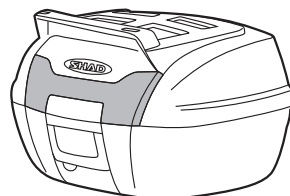

ACCESSORIES (OPTIONAL)

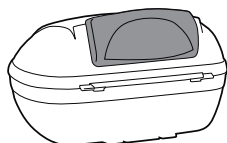

Backrest

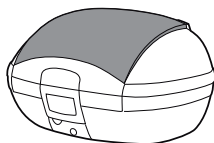

Colour cover



Brake light
Ref. D0B40KL

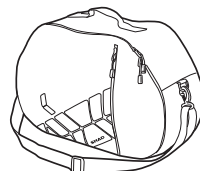

Inner Bag
(SH42, SH45, SH46, SH47)

OPEN

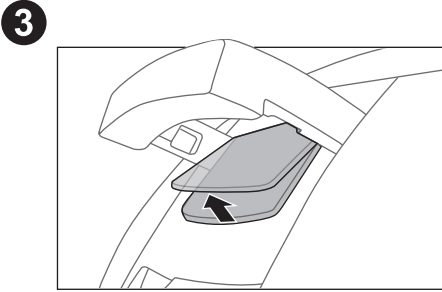
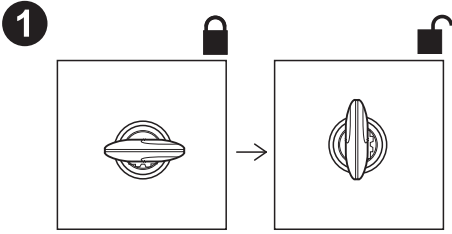

2

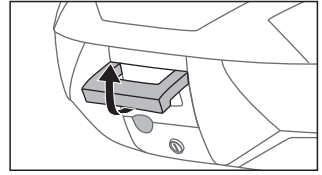

4

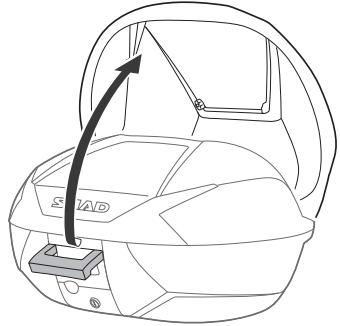

ASSEMBLY

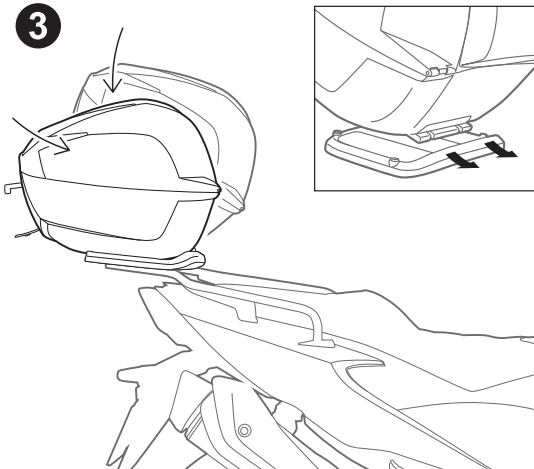
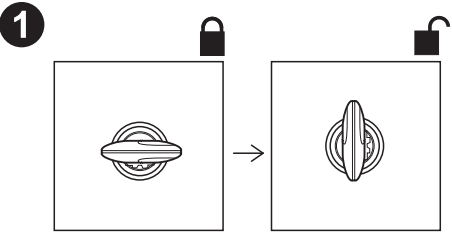

2

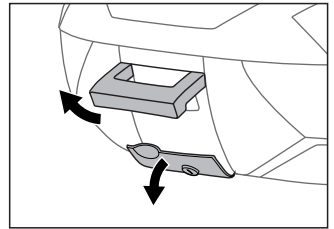

4

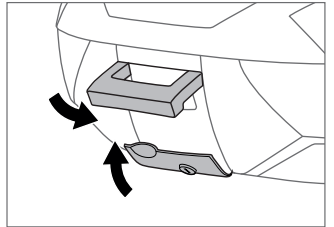

5

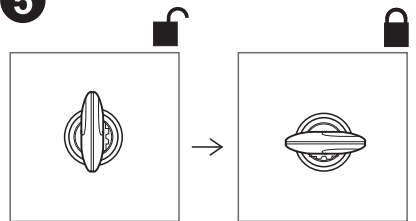

CLOSE

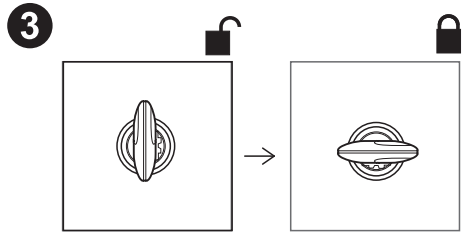
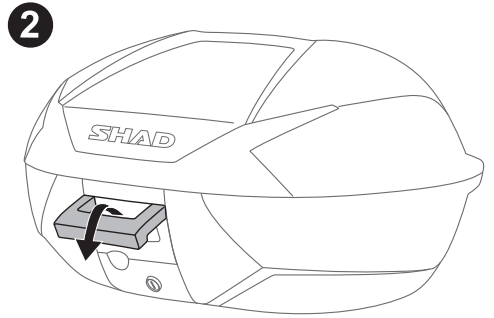
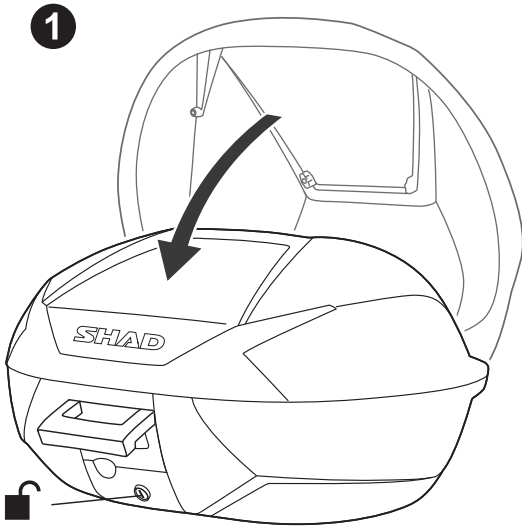

RELEASE

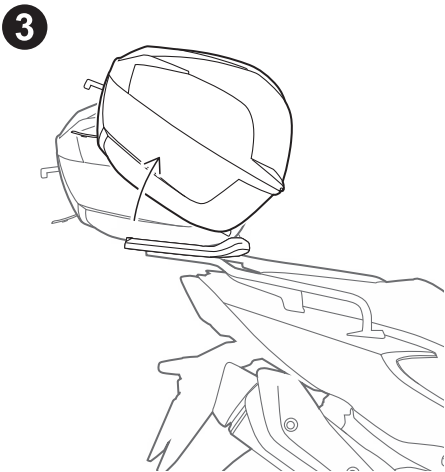
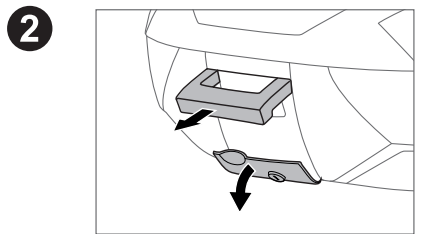
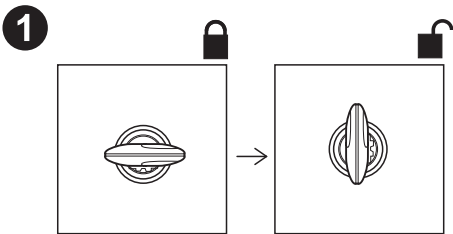

SH40 Cargo

* Only for SH40 Cargo

#	Piece	Quantity
1	Clip	4
2	Screw	4
3	Washer	4

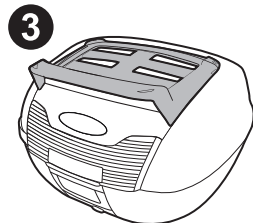
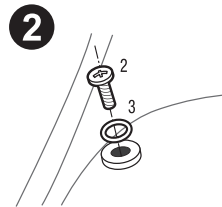
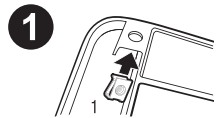

TOP CASE SUPPORT ASSEMBLY

Use top case parts

#	Piece	Quantity
1	Clip	4
2	Screw M6x40	4
3	Plastic spacer	4
4	Ø6 Washer M6	4
5	Nut M6	4
6	Screw M6x30	4

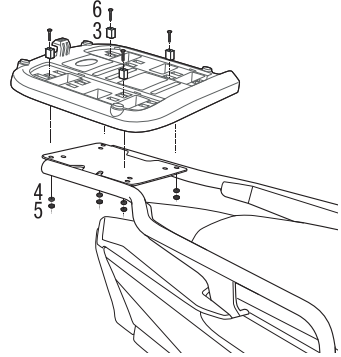
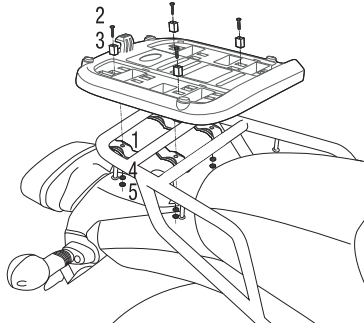
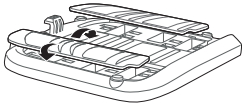

SHAD Top Master*

Use fitting kit parts

#	Piece	Quantity
7	Metal spacer	4
8	Screw M8x20	4
9	Washer M8	4
10	Nut M8	4



⚠ CHECK BIKE COMPATIBILITY

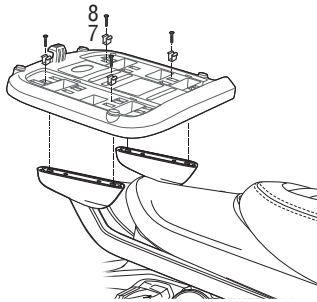

SHAD Top Master*

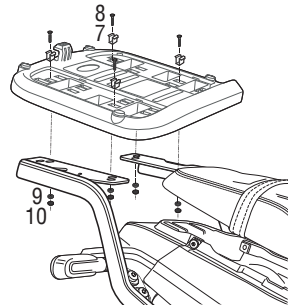

SHAD Top Master*

CARE AND MAINTENANCE



1 M. MINIMUM DISTANCE WITH POWER WASHER.



ALWAYS SECURE AND LOCK PRODUCTS.



MAXIMUM WEIGHT.
(SH42, SH45, SH46, SH47)



CASES ARE NOT DESIGNED TO PROTECT FRAGILE OBJECTS.



MAXIMUM WEIGHT.
(SH40, SH40 Cargo)



MAXIMUM SPEED, CHECK LOCAL LAWS.

SHAD

Learn more about motorcycle luggage systems and saddlebags we have.