

FREEWIRE

Quick Start Guide

Bluetooth® CB and Audio Adapter

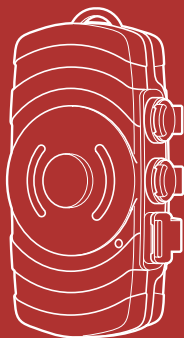

PREPARATION

Knowing the FreeWire Layout

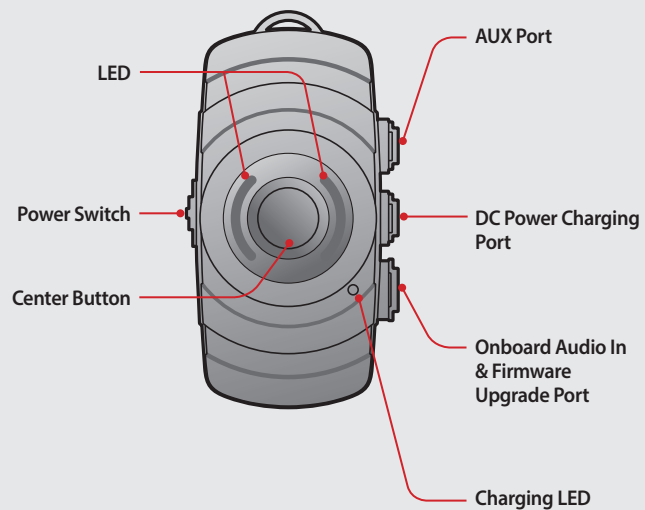

INSTALLATION

Installing on the Handlebar

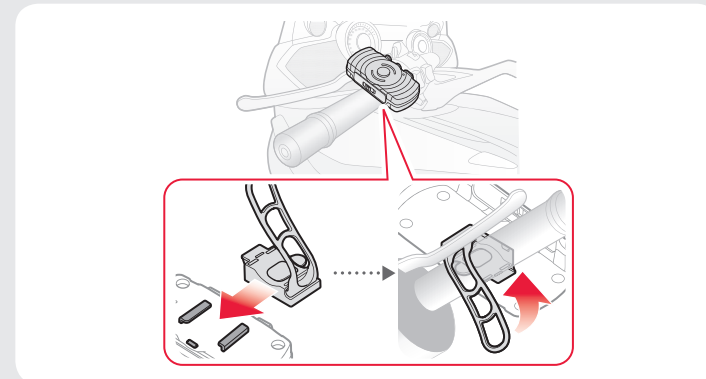

Placing on the Mounting Cradle

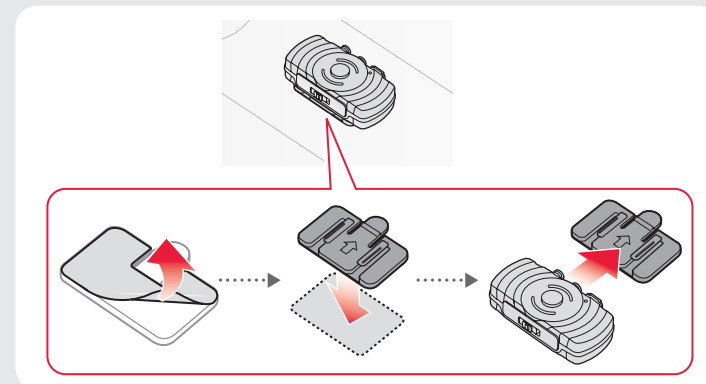

BASIC OPERATION

Turning On/Off the FreeWire

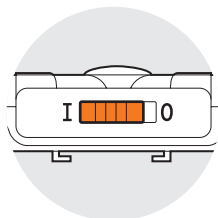

ON

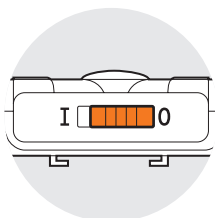

OFF

To turn on the FreeWire, slide the **Power Switch** to **I**. To turn off, slide the **Power Switch** to **O**.

Charging the FreeWire

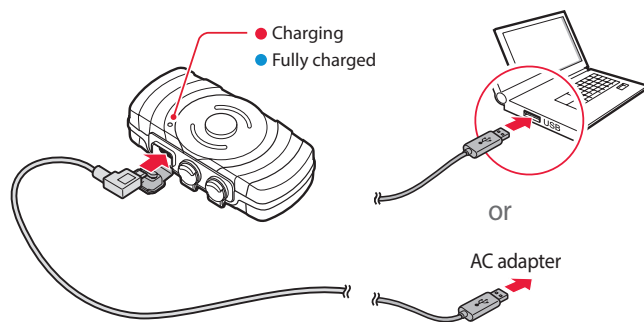

USING THE FREEWIRE

Pairing with a Sena Bluetooth Headset

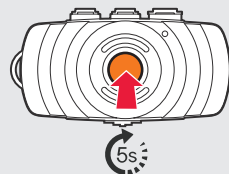

Press the **Center Button** for 5 seconds.

Note The FreeWire will transmit wireless audio signals once it is paired with the headset. If Bluetooth connection is lost, tap the **Center Button** once.

Connecting with the Onboard Audio System

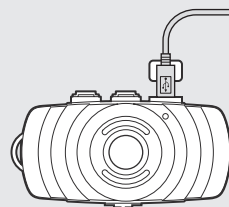

Micro USB to 7 Pin DIN Cable for Harley-Davidson or Micro USB to 5 Pin DIN Cable for Honda Goldwing

TROUBLESHOOTING

Factory Reset

If you want to restore the FreeWire to factory default settings, press and hold the **Center Button** for 14 seconds. Tap the **Center Button**. The headset automatically restores the default settings and turns off.

Note If you reset your headset paired with your FreeWire to factory default settings, you should reset your FreeWire to factory default settings as well in order to pair them again.

Fault Reset

If the FreeWire is not working properly for any reason, push the pin-hole **Reset** button located on the back of the FreeWire while it is powered on.

