

20S EVO Quick Start Guide

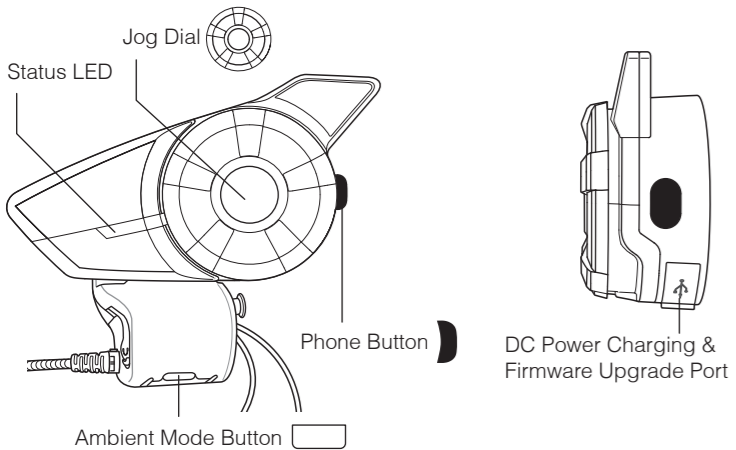

Installation

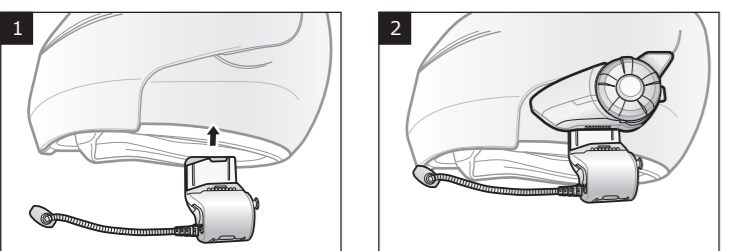

1 17.Apr. 2

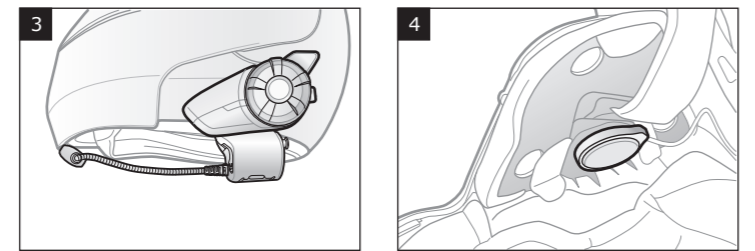

Button Operation

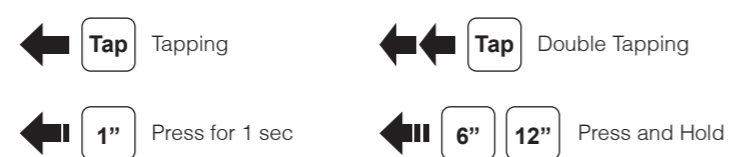

3 4

Power On/Off



Ambient Mode



Bluetooth Pairing Phone, MP3 and GPS

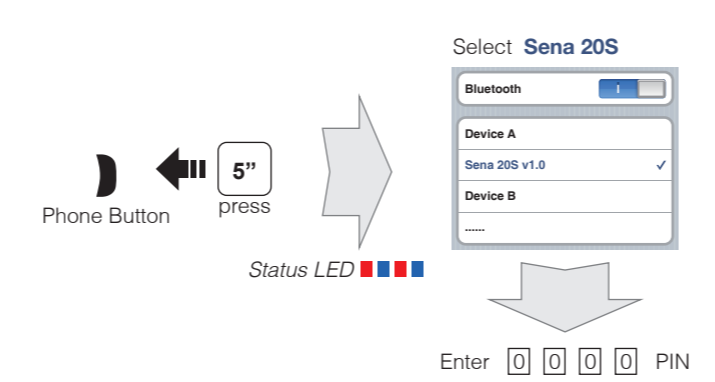

3

Mobile Phone

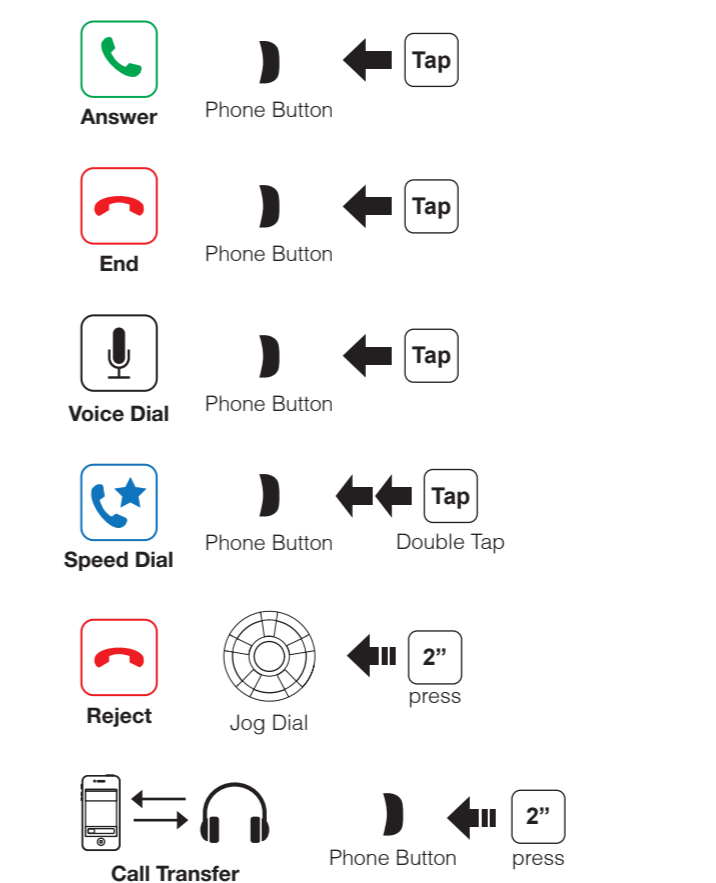

4

Music

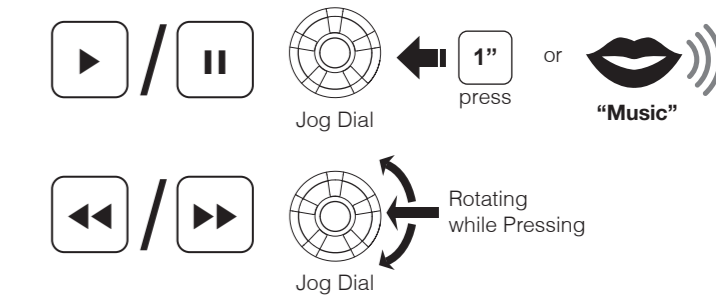

Battery Check

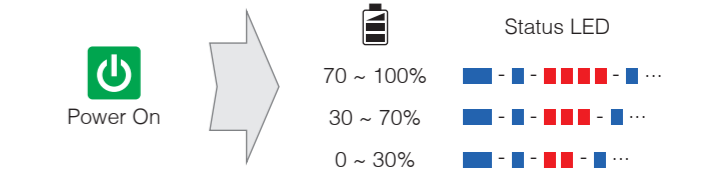

Configuration Menu

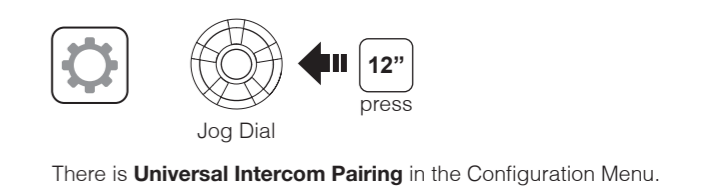

There is **Universal Intercom Pairing** in the Configuration Menu.

5

Quick Pairing Intercom

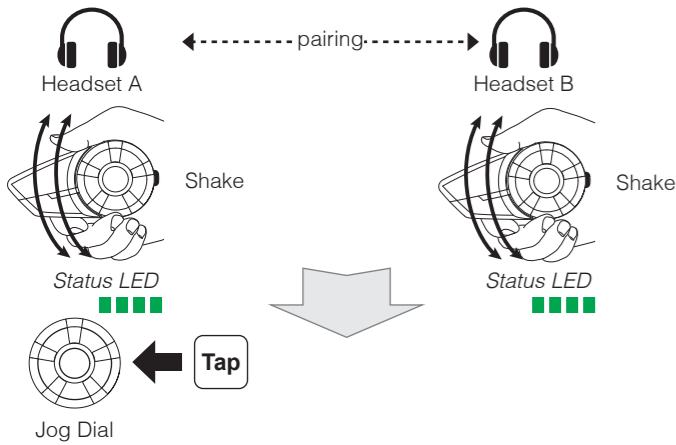

Normal Pairing Intercom

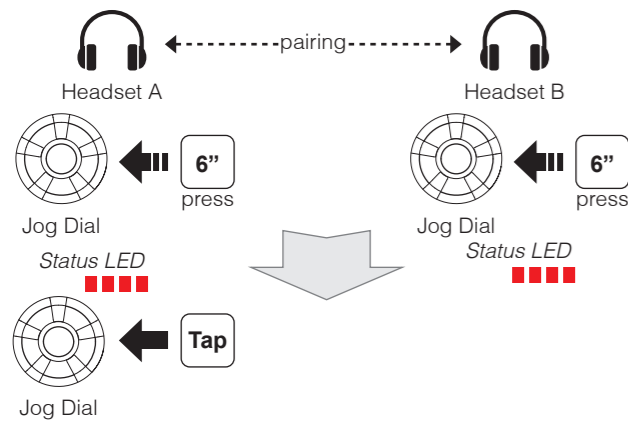

Start / End Intercom

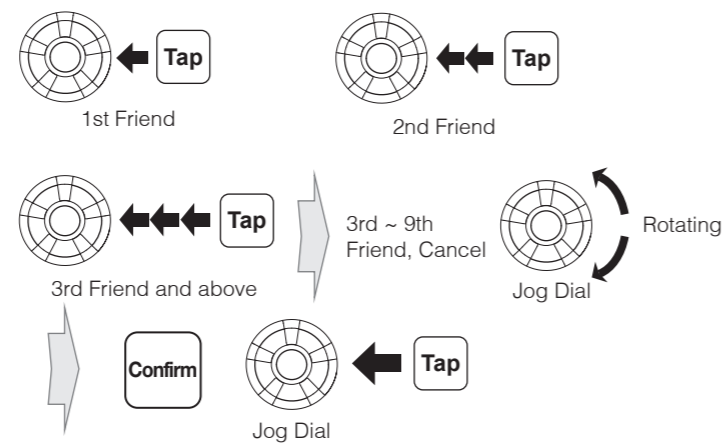

Start / End Group Intercom



Radio On / Off



Radio Seek Stations



Radio Scan Up FM Band



Save to preset while scanning



Radio Save or Delete Preset

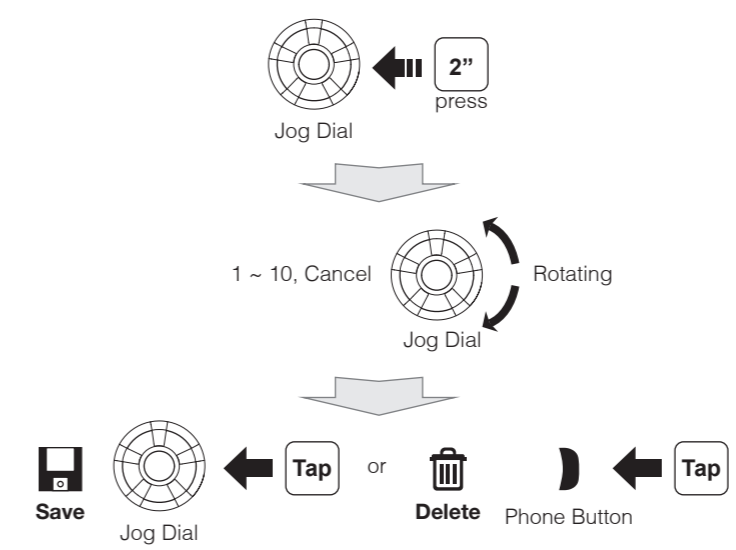

Radio Move to Preset Station

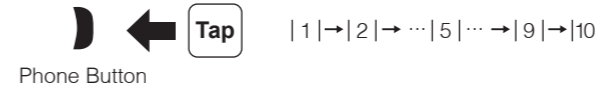

Voice Command

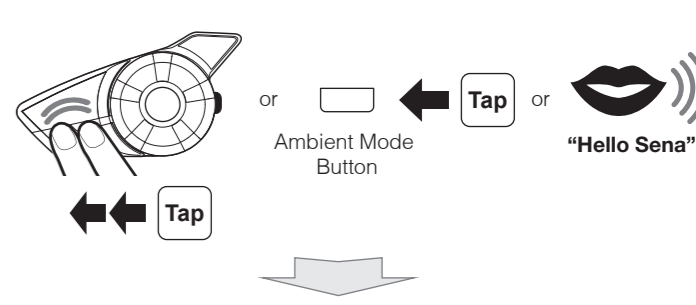

| Voice Command | Function |
|-----------------------------------|-------------------------|
| "Music" | Music play/pause |
| "FM radio" | FM Radio on/off |
| "Intercom [one, two, ... , nine]" | Start/End each intercom |
| "Speed dial [one, two, three]" | Speed dialing |



205 EVO

Motorcycle Bluetooth®
Communication System

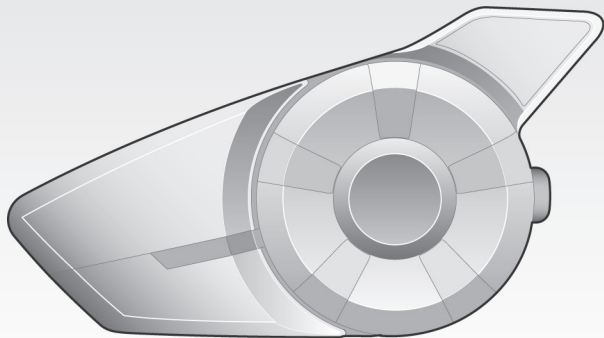



WARNING

To minimize the risk of serious injury, death or product damage, read this User's Guide and the Quick Start Guide before using the product for the first time. .

© 1998-2017 Sena Technologies, Inc. All rights reserved.

Sena Technologies, Inc reserves the right to make any changes and improvements to its product without providing prior notice.

Sena™ is a trademark of Sena Technologies, Inc. or its subsidiaries in the USA and other countries. 20S™, 10U™, 10C™, 10S™, 10R™, Prism™, 3S™, SMH10™, SMH5™, SMH5-FM™, SPH10™, SPH10H-FM™, SMH10R™, SR10™, SR10i™, SM10™, EXPAND™, Bluetooth Audio Pack for GoPro®, Bluetooth Mic & Intercom™, Snowtalk™, Handlebar Remote™, Wristband Remote™, RC4™, RC3™, RC1™, and FreeWire™ are trademarks of Sena Technologies, Inc. or its subsidiaries. These trademarks may not be used without the express permission of Sena.

GoPro® is a registered trademark of Woodman Labs of San Mateo, California. Sena Technologies, Inc. ("Sena") is not affiliated with Woodman Labs. The Sena Bluetooth Pack for GoPro® is an after-market accessory specially designed and manufactured by Sena Technologies, Inc. for the GoPro® Hero3 allowing for Bluetooth capabilities.

The Bluetooth® word mark and logos are owned by the Bluetooth SIG, Inc. and any use of such marks by Sena is under license. iPhone, iPod touch are registered trademarks of Apple Inc. Zumo™ is a trademark of Garmin Ltd. or its subsidiaries. TomTom™ is the trademark or registered trademark owned by TomTom International B.V. Other trademarks and tradenames are those of their respective owners.

CONTENTS

| | | | |
|---|----|---|----|
| Safety Precautions | 5 | 7 MOBILE PHONE CALL MAKING AND ANSWERING | 25 |
| 1 INTRODUCTION | 8 | 7.1 Mobile Phone Call Making and Answering..... | 25 |
| 2 PACKAGE CONTENTS | 9 | 7.2 Speed Dialing..... | 26 |
| 2.1 Headset Main Unit..... | 9 | 7.3 Intercam and Mobile Phone Call | 27 |
| 2.2 Universal Helmet Clamp | 10 | 8 STEREO MUSIC | 28 |
| 3 INSTALLING THE 20S EVO ON YOUR HELMET | 12 | 8.1 By Stereo Audio Cable..... | 28 |
| 3.1 Helmet Installation | 12 | 8.2 By Bluetooth Wireless Stereo | 28 |
| 3.2 Glued Surface Mounting Adapter..... | 14 | 8.3 Music Sharing | 29 |
| 3.3 Switching the Microphone | 14 | 9 GPS NAVIGATION..... | 30 |
| 3.4 Earbuds..... | 16 | 10 SENA SR10, TWO-WAY RADIO ADAPTER..... | 30 |
| 4 GETTING STARTED..... | 16 | 11 FM RADIO | 31 |
| 4.1 Charging | 16 | 11.1 FM Radio On / Off | 31 |
| 4.2 Low Battery Warning..... | 17 | 11.2 Preset Stations..... | 31 |
| 4.3 Checking the Battery Level | 17 | 11.3 Seek and Save | 31 |
| 4.4 Powering On and Off..... | 17 | 11.4 Scan and Save..... | 32 |
| 4.5 Volume Adjustment | 18 | 11.5 Temporary Preset | 32 |
| 4.6 Software..... | 18 | 11.6 Region Selection | 33 |
| 5 PAIRING THE 20S EVO WITH BLUETOOTH DEVICES | 19 | 12 AMBIENT MODE..... | 33 |
| 5.1 Mobile Phone Pairing | 19 | 13 VOICE COMMAND | 34 |
| 5.2 Second Mobile Phone Pairing | 20 | 14 INTERCOM PAIRING | 35 |
| 5.3 Bluetooth Stereo Device Pairing..... | 21 | 14.1 Pairing with Other 20S EVO Headsets for Intercam Conversation | 35 |
| 5.4 Bluetooth GPS Navigation Pairing | 21 | 14.2 Pairing with Other Sena Headset Models for Intercam Conversation | 37 |
| 5.5 Pairing with the Sena SR10, Bluetooth Two-way Radio Adapter | 23 | 15 TWO-WAY & MULTI-WAY INTERCOM | 37 |
| 6 PAIRING WITH SELECTIVE PROFILE: A2DP STEREO OR HANDSFREE | 24 | 15.1 Two-way Intercam | 37 |
| 6.1 A2DP Stereo Music Only..... | 24 | 15.2 Multi-way Intercam | 38 |
| 6.2 HFP for Phone Call Only | 25 | 15.3 Intercam Failure..... | 41 |
| | | 15.4 Intercam Reconnection..... | 41 |

| | | | | | |
|----|--|----|---|---|----|
| 16 | THREE-WAY CONFERENCE PHONE CALL WITH INTERCOM PARTICIPANT..... | 41 | 23 | FAULT RESET | 57 |
| 17 | GROUP INTERCOM..... | 42 | 24 | FIRMWARE UPGRADE..... | 58 |
| 18 | UNIVERSAL INTERCOM..... | 42 | 25 | OPERATION QUICK REFERENCE | 58 |
| | 18.1 Universal Intercom Pairing..... | 42 | CERTIFICATION AND SAFETY APPROVALS | | |
| | 18.2 Two-way Universal Intercom..... | 43 | | • FCC Compliance Statement..... | 60 |
| | 18.3 Three-way Universal Intercom..... | 44 | | • FCC RF Exposure Statement..... | 61 |
| | 18.4 Four-way Universal Intercom | 45 | | • FCC Caution | 61 |
| 19 | REMOTE CONTROL | 47 | | • CE Declaration of Conformity | 61 |
| 20 | FUNCTION PRIORITY..... | 47 | | • Industry Canada Statement | 61 |
| 21 | 20S EVO CONFIGURATION SETTING | 48 | | • Bluetooth License | 61 |
| | 21.1 Assigning Speed Dial | 49 | | • WEEE (Waste Electrical and Electronic Equipment)..... | 62 |
| | 21.2 Enabling/Disabling Audio Multitasking | 50 | | | |
| | 21.3 Setting Intercom-audio Overlay Sensitivity..... | 50 | | | |
| | 21.4 Enabling/Disabling Navigation App Support | 51 | | | |
| | 21.5 Enabling/Disabling Audio Boost | 51 | | | |
| | 21.6 Setting Smart Volume Control | 51 | | | |
| | 21.7 Setting Motion Sensor Sensitivity | 52 | | | |
| | 21.8 Enabling/Disabling Voice Activated Phone Answering..... | 52 | | | |
| | 21.9 Enabling/Disabling HD Intercom | 53 | | | |
| | 21.10 Enabling/Disabling Eight-way Intercom..... | 53 | | | |
| | 21.11 Enabling/Disabling Voice Prompts..... | 54 | | | |
| | 21.12 Enabling/Disabling FM Station Guide..... | 54 | | | |
| | 21.13 Enabling/Disabling Sidetone..... | 54 | | | |
| | 21.14 Enabling/Disabling Advanced Noise Control™..... | 55 | | | |
| | 21.15 Delete All Bluetooth Pairing Information | 55 | | | |
| | 21.16 Remote Control Pairing | 55 | | | |
| | 21.17 Universal Intercom Pairing..... | 56 | | | |
| | 21.18 Exit Voice Configuration Menu | 56 | | | |
| 22 | RESET TO FACTORY DEFAULT SETTINGS..... | 57 | | | |

Safety Precautions

Please ensure that the product is properly used by observing the safety precautions below to prevent any risk of serious injury, death and/or damage to property.

Hazard alert signal words

The following safety symbols and signal words are used in this manual.

**WARNING**

Indicates a potential hazardous situations that, if not avoided, could result in death or serious injury.

**CAUTION**

Indicates a potential hazardous situation that, if not avoided, could result in minor or moderate injury.

NOTICE

Indicates information considered important, but not hazard-related. If not avoided, it could cause damage to your product.

Note

Notes, usage tips, or additional information

Product Use

Observe the following precautions to avoid injury or damage to your product while using the product.

**WARNING**

- Use of the product at a high volume for a long period of time may damage your eardrums or hearing ability.
- If the product emits an unusual smell, feels hot, or appears abnormal in any other way while using or charging, stop using it immediately. It may cause damage, explosion, or fire. Contact your sales location if any of these problems are observed.
- Careless use of the product on the road is risky and may result in serious injury, death or damage. You must heed all safety precautions in all documents that come with this product. This will help minimize the chance these risks may occur while riding.
- In any place where wireless communication is prohibited, such as hospitals or airplanes, turn off the power. In a place where wireless communication is prohibited, electromagnetic waves may cause hazards or accidents.

- Before riding, fasten the product from the helmet, and double-check that it is properly fastened. Separation of the product while riding will cause damage to the product and may result in an accident.
- Do not use the product in an explosive atmosphere. If you are in such a location, turn off the power and heed any regulations, instructions, and signs in the area.
- When you use the product while you operating any vehicle or equipment such as motorcycles, scooters, mopeds, ATVs, or quadbikes (hereinafter called "transportation means"), you need to follow the safety precautions provided by the manufacturer of the vehicle.
- When you use the product, use good judgment; never use it under the influence of alcohol or drugs or when you are extremely tired.

NOTICE

- Attaching the product to the helmet is considered a modification to the helmet and may void your helmet's warranty or compromise your helmet's functionality. This may entail risks during an accident, so be fully aware of this fact before using the product. Should you not accept this fact, you may return the product for a full refund.
- In some regions, it is prohibited by law to ride motorcycles while wearing headsets or earbuds. Therefore be certain you are aware of all relevant laws in the region where you are using the product and are sure that you comply with them.
- The headset is for motorcycle helmets only. To install the headset, you must follow the installation instructions shown in the User's Guide.
- Do not impact the product with sharp tools as this may damage the product.
- Keep product away from pets or small children. They may damage the product.
- Any changes or modifications to the equipment not expressly approved by the party responsible for compliance could void the limited warranty to operate the equipment.

Battery

Your product has a built-in battery. Be careful to heed all safety information in this guide. Failure to carefully observe the safety precautions can cause battery heat generation, bursting, fire and serious personal injury.



WARNING

- Do not use the product in direct sunlight for a long period of time. Doing so can damage the product and generate heat that can cause burns.
- Do not use or store the product inside cars in hot weather. It may cause the battery to generate heat, rupture, or ignite.
- Do not continue charging the battery if it does not recharge within the specified charging time. Doing so may cause the battery to become hot, explode, or ignite.
- Do not leave the product near open flames. Do not dispose of the product in a fire. It may cause the battery to become hot, explode, or ignite and cause serious injury.
- Never attempt to charge a battery with the charger which has been physically damaged. It may cause explosion and/or accidents.

Product Storage and Management

Take the following precautions to avoid personal injury or damage to your product while storing and maintaining the product.



CAUTION

- Do not dispose of the product with household waste. The built-in battery is not to be disposed of in municipal waste stream and requires separate collection. Disposal of the product should be done in accordance with the local regulations.

NOTICE

- Keep the product free of dust. Dust may damage mechanical and electronic parts of the product.
- The product should be stored at room temperature. Do not expose the product to extremely high or low temperature as this may reduce the life span of electronic devices, damage the battery, and/or melt plastic parts of the product.

- Do not clean the product with cleaning solvents, toxic chemicals, or strong detergents as this may damage the product.
- Do not paint the product. Paint may obstruct moving parts or interfere with the normal operation of the product.
- Do not drop or otherwise shock the product. It may damage the product or its internal electronic circuits.
- Do not disassemble, repair or modify the product as this may damage the product and invalidate the product warranty.
- Do not store the product in humid environments, especially for long periods of time. It may damage the internal electronic circuits.
- Battery performance will deteriorate over time if stored for a long period of time without being used.

1 INTRODUCTION

Thank you for choosing the 20S EVO, Motorcycle Bluetooth Communication System. With the 20S EVO, you can call handsfree on your Bluetooth mobile phone, listen to stereo music or voice instructions of GPS navigations by Bluetooth wirelessly, and have intercom conversations in full duplex with a passenger or other motorcycle riders.

The 20S EVO is compliant with Bluetooth 4.1 supporting the following profiles: Headset Profile, Hands-Free Profile (HFP), Advanced Audio Distribution Profile (A2DP) and Audio Video Remote Control Profile (AVRCP). Please check with the manufacturers of other devices to determine their compatibility with this headset.

Please read this user's guide carefully before using the headset. Also check www.sena.com for the latest version of the User's Guide and additional information related to Sena Bluetooth products.

The 20S EVO features:

- Bluetooth 4.1
- Dual Bluetooth module communication system
- Audio Multitasking™
- Multi-way intercom up to 8 connections
- Group Intercom™
- Bluetooth intercom up to 2.0 kilometers (1.2 miles)*

- Smartphone App for iPhone and Android
- Universal Intercom™
- Advanced Noise Control™
- Intuitive voice prompts and voice commands
- HD quality crystal clear and natural sound
- Bluetooth Audio Recording™
- Versatile functions using motion sensor technology
- All-in-one helmet clamp kit
- Built-in FM radio tuner with a station scan and save function
- Bluetooth pairing for dual mobile phones
- Bluetooth handsfree for Bluetooth mobile phones
- Bluetooth stereo headset for Bluetooth audio devices such as MP3 players
- Bluetooth stereo headset for Bluetooth GPS navigations
- Firmware upgradeable

.....
* in open terrain

Key Specifications:

- Bluetooth 4.1
- Bluetooth 2.4 GHz ~ 2.48 GHz / max output power 0.057W
- Supporting profiles: Headset Profile, Hands-Free Profile (HFP), Advanced Audio Distribution Profile (A2DP), and Audio Video Remote Control Profile (AVRCP)

2 PACKAGE CONTENTS

2.1 Headset Main Unit

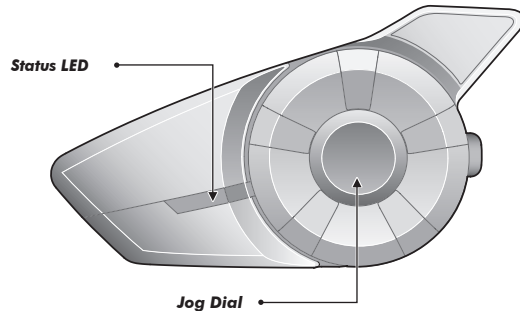

- Answer and end a mobile phone call
- Reject an incoming mobile phone call
- Start and end intercom conversation
- Volume adjustment by rotating
- Play and pause Bluetooth stereo device
- Track-forward and track-back by pressing down and rotating
- Enter into intercom pairing mode
- Enter into voice configuration setting
- Navigate through configuration menu
- Seek FM radio station

2.2 Universal Helmet Clamp

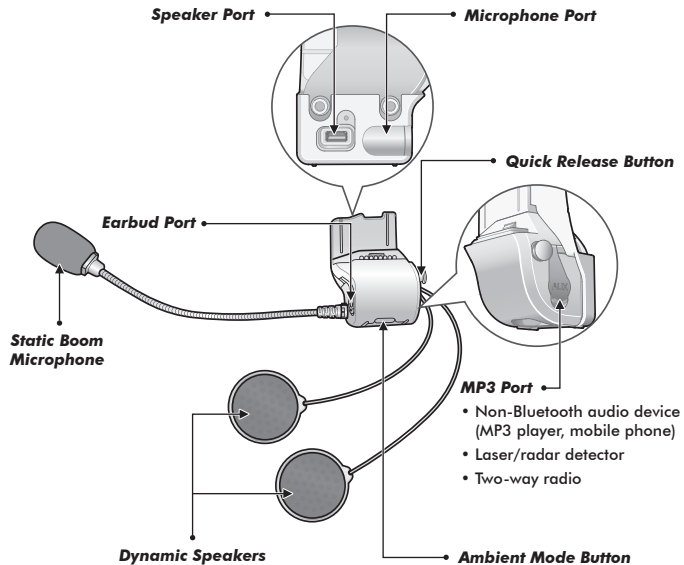
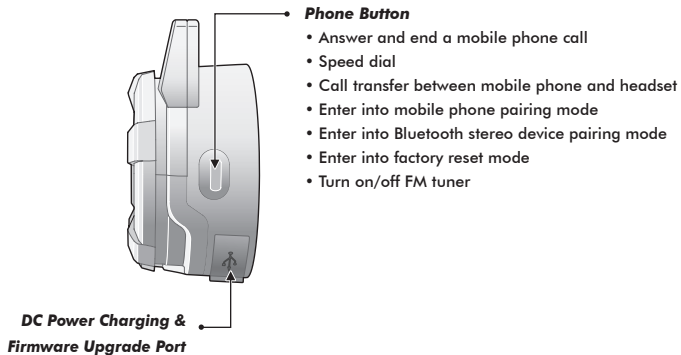

• **Wired Boom Microphone** 

• **Wired Microphone** 

• **USB Power & Data Cable** 

• **Cigarette Charger** 

• **2.5 to 3.5mm Stereo Audio Cable** 

• **Glued Surface Mounting Adapter** 

• **Speaker Port Cover** 

• **Rubber Pads** 

• **Foam Speaker Covers** 

• **Hook and Loop Fasteners for Speakers** 

• **Hook and Loop Fastener for Boom Microphone** 

• **Hook and Loop Fastener for Wired Microphone** 

• **Speaker Pads** 

• **Allen Wrench** 

3 INSTALLING THE 20S EVO ON YOUR HELMET

3.1 Helmet Installation

To securely install the 20S EVO on the helmet, please follow this procedure.

1. Loosen the two screws on the back plate of the clamp unit using the enclosed allen wrench. Insert the back plate of the clamp unit between the internal padding and external shell of the helmet, and tighten the two screws. Please make sure that the microphone is located properly close to your mouth when you wear the helmet.

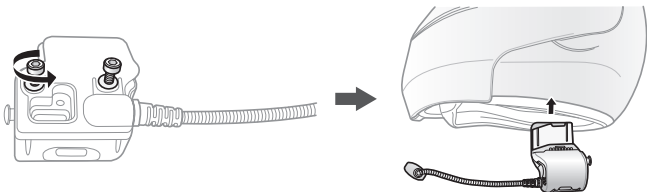

2. Depending on the size and shape of your helmet, you may need to change the thickness of the rubber pad between the clamp plates. You can find two extra rubber pads in the box. To increase the overall thickness, attach the thinner one to the original rubber pad or replace the original rubber pad with the thicker one.

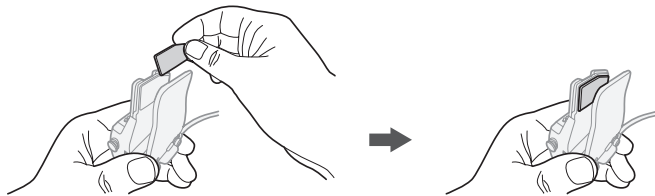

3. Please adjust the direction of the microphone so that the fin side of the microphone is facing outward; away from your lips. You can easily recognize it by touching the fin with your fingers.

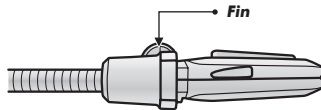

- Place the helmet speakers along with the hook and loop fasteners, centered to your ear, in the ear pockets of the helmet. If the helmet has deep ear pockets, you can use the speaker pads to place the speakers closer to your ears.

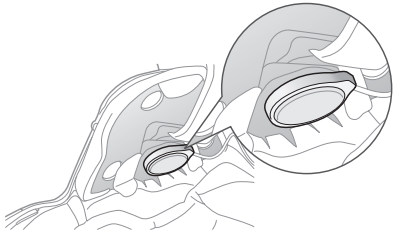

Note:

To enhance the audio quality, you can make use of the foam speaker covers. Cover each speaker with the foam and attach the hook fastener at the back of the speaker. Then place the speakers in the helmet as described above. Foam covered speakers work most effectively when they are slightly touching your ears.

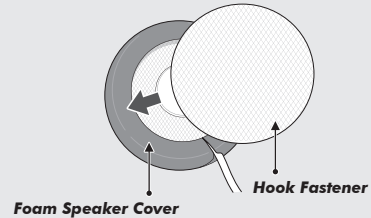

- Attach the headset main unit to the clamp unit. Slide the main unit down onto the clamp unit until it clicks firmly into the bottom portion of the clamp unit.

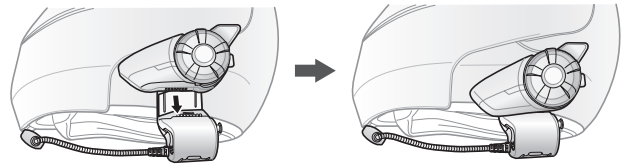

- To remove the main unit from the clamp unit, press the Quick Release Button to slide it off the clamp unit.

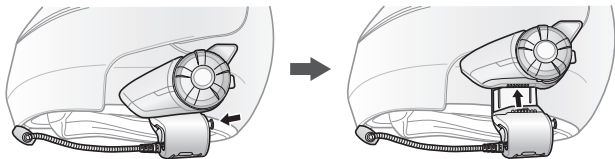

3.2 Glued Surface Mounting Adapter

If you have any problem equipping the clamp unit on the helmet for any reason, you may use the glued surface mounting adapter to attach the clamp unit on the external surface of the helmet.

- Remove the speaker unit from the speaker port.
- Remove the back plate of the clamp unit completely.
- Remove the rubber pad and replace it with the thicker rubber pad included in the package.
- Put the speaker cable through the glued external adapter and reconnect it to the speaker port.
- Hook on the adapter to the clamp unit then screw in the glued external adapter to the clamp unit.
- Locate a proper surface on the helmet to attach the unit then clean the helmet surface location with a moistened towel and allow to dry thoroughly.

- Peel off the cover of the adhesive tape of the adapter and attach the unit on the proper surface of your helmet.

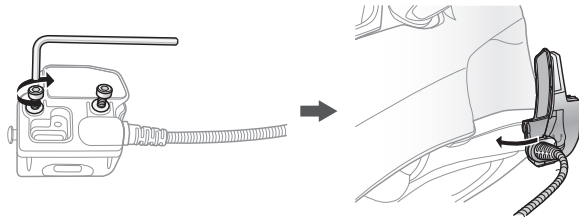

Note:

Sena recommends the clamp unit over the glued surface mounting adapter. Even though the glued surface mounting adapter is provided for convenience, Sena does not assume any responsibility for use of it. Users may have to use the glued adapter at their own risk and responsibility.

3.3 Switching the Microphone

If you want to use a different microphone instead of the static boom microphone, please refer to the following steps.

- Remove the back plate of the clamp unit by loosening the two screws with the enclosed allen wrench.
- If you look into the back side of the clamp, the left port is for speakers and the right port is for microphone.

3. Two extra microphones are provided, a wired boom microphone and a wired microphone. Connect the one you need according to your helmet type.
4. Lock the microphone to the clamp by turning the lock clockwise.
5. Reattach the back plate to cover the microphone and the speaker port.
6. Follow steps in section 3.1, “Helmet Installation” to complete the clamp installation.

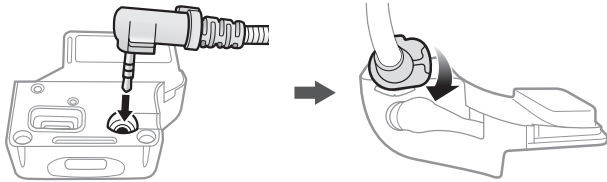

3.3.1 Wired Boom Microphone

When installing the included wired boom microphone, place the hook and loop fastener end of the boom microphone between the internal helmet cheek pad and the internal wall of the helmet shell. The boom microphone should be mounted so it is facing close to your mouth when you wear the helmet.

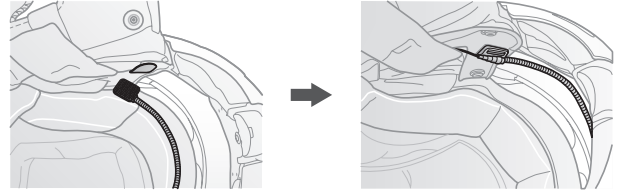

3.3.2 Wired Microphone

In case of the wired microphone, attach the enclosed hook and loop fastener for the wired microphone to the inside of the chin guard for full-face helmets. Place the wired microphone on the hook and loop fastener and connect it to the connector of the clamp unit.

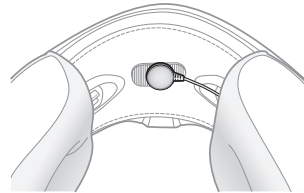

3.4 Earbuds

If you want to wear your own earbuds, connect the earbuds to the earbud port on the left side of the clamp. You can connect your earbuds to the clamp while having the speakers connected to the clamp. The sound of the earbuds will be active while the sound of the outer speakers becomes inactive.

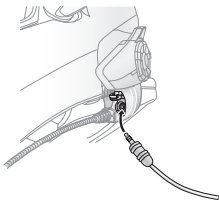

Note:

If you remove the outer speakers from the clamp, make sure to reassemble the speaker port cover and tighten the screw.

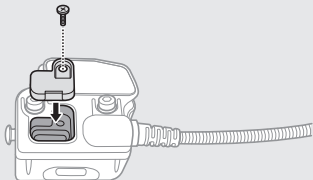

4 GETTING STARTED

4.1 Charging

WARNING

When charging the battery, use only the approved charger provided by the manufacturer. Use of a non-approved charger may cause fire, explosion, leakage, and other hazards which may also reduce the life time or performance of the battery.

You can charge the 20S EVO by connecting the supplied USB power & data cable into a computer USB port or USB wall charger. You can use any standard micro-USB cable to charge the 20S EVO. The LED turns red while the headset is charging and turns blue when it is fully charged. It takes about 2.5 hours to be completely charged.

Note:

Any 3rd party USB charger can be used with Sena products if the charger is approved by either the FCC, CE, IC or other locally approved agencies that Sena accepts.

**CAUTION**

Please make sure to take off your 20S EVO-installed helmet while charging. The headset automatically turns off during charging.

Note:

1. The battery performance may be reduced over time with usage.
2. Battery life may vary depending on conditions, environmental factors, functions of the product in use, and devices used with it.

4.2 Low Battery Warning

When the battery is low, the blinking blue LED in stand-by mode turns to red and you will hear three, mid-toned beeps and a voice prompt saying “**Low Battery**”.

4.3 Checking the Battery Level

You can check the battery level in two different ways when the headset is powering on.

4.3.1 LED Indicator

When the headset is powering on, the red LED flashes rapidly indicating the battery level.

- 4 flashes = High, 70~100%
- 3 flashes = Medium, 30~70%
- 2 flashes = Low, 0~30%

4.3.2 Voice Prompt Indicator

When you power on the headset, keep pressing the Jog Dial and the Phone Button simultaneously for about 3 seconds until you hear three, high toned beeps. Then you will hear voice prompt indicating the battery level. However, if you release the buttons as soon as the headset turns on, you will not hear the voice prompt for the battery level indication.

4.4 Powering On and Off

Press the Jog Dial and the Phone Button at the same time to power the headset either on or off. When powering on the headset, press the Jog Dial and the Phone button at the same time until the blue LED appears while hearing the ascending beeps. When powering off the headset, press the Jog Dial and the Phone Button at the same time until the red LED appears briefly and the headset turns off completely while hearing descending beeps.

4.5 Volume Adjustment

You can easily adjust the volume by rotating the Jog Dial. You will hear a beep when the volume reaches maximum or minimum level. The volume is set and maintained independently at different levels for each audio source even when you turn off and on the headset. For example, once you set the volume for mobile phone handsfree, it will not change even if you adjust the volume for your Bluetooth MP3 music. So you can always maintain the preferred optimum volume level for each audio source.



WARNING

Use of the product at a high volume for a long period of time may damage your eardrums or hearing ability. Keep the volume at a modest level to prevent damage.

4.6 Software

4.6.1 Sena Device Manager

The Device Manager allows you to upgrade the firmware and configure the device settings directly from your PC. Using this software, you can assign speed dial presets, FM radio frequency presets and more. It is available to download for both Windows and Mac.

4.6.2 Sena Smartphone App

The Sena Smartphone App allows you to configure the device settings, create groups of intercom friends, and view the quick start guide. Simply pair your phone with your 20S EVO headset, run the Sena Smartphone App and you can configure its settings directly from your smartphone.

5 PAIRING THE 20S EVO WITH BLUETOOTH DEVICES

Before using the 20S EVO Bluetooth headset with any Bluetooth devices for the first time, you will need to pair them together. It can be paired with Bluetooth mobile phones, Bluetooth stereo devices such as MP3 players, or motorcycle specific Bluetooth GPS navigation, and with other Sena Bluetooth headsets. This pairing operation is only required once for each Bluetooth device. The headset remains paired with the devices and automatically reconnects to them when they are within range. You will hear a high tone single beep and a voice prompt when the headset connects to the paired device automatically: **“Phone connected”** to a mobile phone, **“Media connected”** to a Bluetooth stereo device.

5.1 Mobile Phone Pairing

5.1.1 General Mobile Phone Pairing

1. Turn on the 20S EVO and press the Phone Button for 5 seconds until the LED flashes red and blue alternately and you hear multiple beeps. You will hear a voice prompt saying **“Phone pairing”**.
2. Search for Bluetooth devices on your mobile phone. Select the 20S EVO in the list of the devices detected on the mobile phone.
3. Enter 0000 for the PIN. Some mobile phones may not ask for the PIN.
4. The mobile phone confirms that pairing has completed and the 20S EVO is ready to use. You will hear a voice prompt from the 20S EVO saying **“Your headset is paired”**.
5. If the pairing process is not completed within three minutes, the 20S EVO will return to stand-by mode.

5.1.2 NFC Mobile Phone Pairing

You can quickly pair your mobile phone using NFC (Near Field Communication) technology with your NFC-enabled mobile phone.

1. Make sure that your mobile phone has the NFC function turned on and that the phone screen is active.
2. Turn on the 20S EVO and remove the main unit from the clamp unit.
3. Place your mobile phone over the back side of the 20S EVO so that the NFC detection area of each device touches each other.
4. Follow the pairing instructions that appear on your phone. If a passcode is required, enter "0000".
5. The mobile phone confirms that pairing has completed and the 20S EVO is ready to use.
6. Reattach the 20S EVO to the clamp unit.

5.2 Second Mobile Phone Pairing

Typical Bluetooth headsets can connect with only one Bluetooth device, but a second mobile phone pairing allows the headset to connect with another Bluetooth device such as a second mobile phone, an MP3 Player, or the Sena SR10, the Bluetooth adapter.

1. To pair the second mobile phone, press the Jog Dial for 6 seconds until the red LED is rapidly flashing and you hear multiple beeps.

2. Within 2 seconds, tap the Phone Button again, then the LED turns to blue flashing and the beeps turn to high toned double beeps. You will hear a voice prompt saying "**Second mobile phone pairing**".
3. Search for Bluetooth devices on your mobile phone. Select the 20S EVO in the list of the devices detected on the mobile phone.
4. Enter 0000 for the PIN. Some mobile phones may not ask for the PIN.
5. The mobile phone confirms that pairing has completed and the 20S EVO is ready to use. You will hear a voice prompt from the 20S EVO saying "**Your headset is paired**".
6. If you want to pair the Sena SR10, Bluetooth adapter, please refer to the section 5.5, "Pairing with the Sena SR10, Bluetooth Two-way Radio Adapter".

Note:

If you have two audio (A2DP) devices connected to your headset then the audio from one device will interrupt the audio from the other device. For example, if you are playing music from the primary mobile phone, then it can be interrupted by playing music from the secondary mobile phone and vice versa.

5.3 Bluetooth Stereo Device Pairing

1. If the Bluetooth stereo device is integrated with the mobile phone such as smartphones, you don't need to pair the 20S EVO with it separately. When the 20S EVO is paired with the mobile phone, it is also paired as a stereo music device.
2. If you have a stand alone Bluetooth stereo device, follow the pairing procedure separately. The procedure is the same as the procedure in section 5.1, "Mobile Phone Pairing".

Note:

1. If Bluetooth connection between the headset and a mobile phone is disconnected, tap the Phone Button to recover the Bluetooth connection immediately.
2. If Bluetooth connection between the headset and a media player is disconnected, press the Jog Dial for 1 second to recover the Bluetooth connection and play.

5.4 Bluetooth GPS Navigation Pairing

5.4.1 GPS Pairing

1. Turn on the headset and press the Jog Dial for 6 seconds until the red LED is rapidly flashing and you hear multiple beeps.
2. Within 2 seconds, tap the Phone Button and hear the voice prompt, "**Second mobile phone pairing**". Again within 2 seconds, tap the Phone Button and the LED turns to green flashing and the beeps turn to multiple mid-toned beeps. You will hear the voice prompt, "**GPS pairing**".
3. Search for Bluetooth devices on the GPS navigation screen. Select the 20S EVO in the list of the devices detected on the GPS.
4. Enter 0000 for the PIN.
5. The GPS confirms that pairing has completed and the 20S EVO is ready to use. You will hear a voice prompt from the 20S EVO saying "**Your headset is paired**".
6. If the pairing process is not completed within three minutes, the 20S EVO will return to stand-by mode.

Note:

If you pair your GPS device via GPS Pairing, its instructions will not interrupt your intercom conversations, but overlay with them.

The pairing diagram for GPS pairing is shown in the figure below.

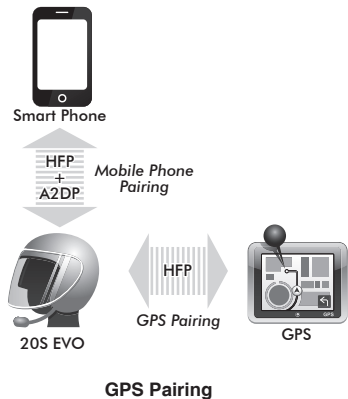

5.4.2 GPS Pairing as Mobile Phone

If a GPS is not only used for turn-by-turn voice instructions but also is your preferred Bluetooth stereo music source, you can pair the GPS to the 20S EVO by following the simple procedures in “5.1 Mobile Phone Pairing”. However, since some GPS systems support mobile phone bridging over Bluetooth, you can pair the mobile phone to the GPS to use your mobile phone. When you do this, the 20S EVO thinks the GPS is a mobile phone so you can no longer pair your mobile phone to the 20S EVO directly. Please refer to the user’s guide of your GPS for details.

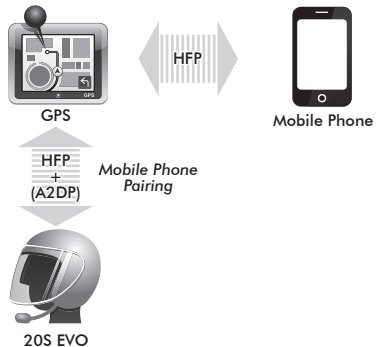

GPS Pairing as Mobile Phone

Note:

You have to use a motorcycle specific GPS which transmits turn-by-turn voice instruction to the headset by Bluetooth. Most automotive GPS systems don't have this feature.

5.5 Pairing with the Sena SR10, Bluetooth Two-way Radio Adapter

The Sena SR10 is a Bluetooth two-way radio adapter for group communication, and uses HFP as do most motorcycle specific GPS navigation systems. If you pair the 20S EVO with a SR10 by second mobile phone pairing, the 20S EVO is able to have two HFP devices at the same time: a mobile phone and the Sena SR10.

1. Turn on the headset and press the Jog Dial for 6 seconds until the red LED is rapidly flashing and you hear multiple beeps.
2. Within 2 seconds, tap the Phone Button again, then the LED turns to blue flashing and the beeps turn to high tone double beeps. You will hear a voice prompt saying **“Second mobile phone pairing”**.
3. Turn on the SR10 and follow the SR10’s “Bluetooth Headset Pairing” procedure to complete the process. Please refer to the SR10 user’s guide for details.

4. When the pairing is completed, you will hear a voice prompt saying **“Your headset is paired”**.
5. If the pairing process is not completed within three minutes, the 20S EVO will return to stand-by mode.

The incoming audio from the two-way radio via SR10 is heard in the background while having an intercom conversation or a mobile phone call. You can listen to music, answer a mobile call, have an intercom conversation and use a two-way radio via the SR10 for group communication as shown in the figure below. A GPS system or a radar detector which has a headphone jack or audio line-out could be connected to the SR10 by a wire. The GPS voice instruction or the radar detector alarm is also heard in the background via the SR10 while having an intercom conversation or a phone call. Please refer to the SR10 User’s Guide for details.

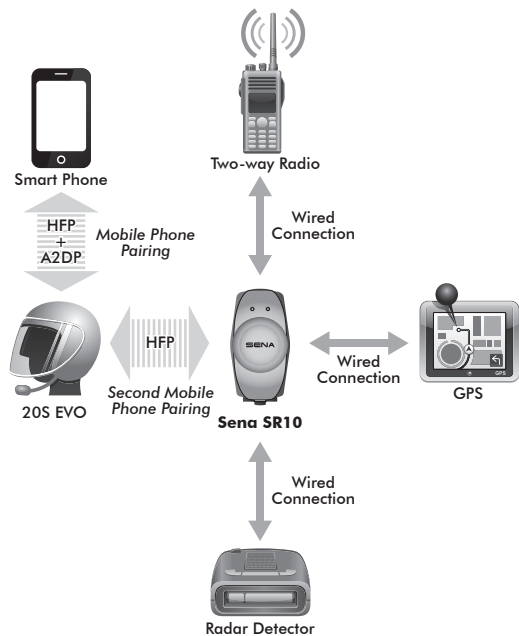

**Parallel Connection of SR10 and Mobile Phone
by Bluetooth Second Mobile Phone Pairing**

6 PAIRING WITH SELECTIVE PROFILE: A2DP STEREO OR HANDSFREE

If you have a MP3 stereo music phone such as a smartphone, sometimes you may need to selectively use the 20S EVO for A2DP stereo music only or for mobile phone handsfree only. These instructions are for advanced users who want to pair the 20S EVO to their smartphones only with one selective profile: A2DP stereo for music or HFP for phone calls.

If you have previously paired a mobile phone to the 20S EVO, you must clear the previous pairing list on both devices; the mobile phone and 20S EVO. To clear the pairing list on 20S EVO, please do a factory reset or follow the pairing list clearing procedure described in this manual. To clear the pairing list on the mobile phone, please refer to the mobile phone manual. For most smartphones, delete the 20S EVO from the list of Bluetooth devices in the settings menu.

6.1 A2DP Stereo Music Only

1. Turn on the headset and press the Phone Button for 5 seconds until the LED flashes red and blue alternately and you hear multiple beeps.

2. Within 2 seconds, tap the Jog Dial again, then the LED turns to red flashing and the beeps turn to double mid-tone beeps. You will hear a voice prompt saying **“Media selective pairing”**.
3. Search for Bluetooth devices on your smartphone. Select the 20S EVO in the list of devices detected on your phone.
4. Enter 0000 for the PIN. Some smartphones may not ask for the PIN.

6.2 HFP for Phone Call Only

1. Turn on the headset and press the Phone Button for 5 seconds until the LED flashes red and blue alternately and you hear multiple beeps.
2. Within 2 seconds, tap the Phone Button again, then the LED turns to blue flashing and the beeps turn to multiple mid-tone beeps. You will hear a voice prompt saying **“Phone selective pairing”**.
3. Search for Bluetooth devices on your smartphone. Select the 20S EVO in the list of devices detected on your phone.
4. Enter 0000 for the PIN. Some smart phones may not ask for the PIN.

7 MOBILE PHONE CALL MAKING AND ANSWERING

7.1 Mobile Phone Call Making and Answering

1. When you have an incoming call, simply tap the Phone Button or the Jog Dial to answer the call.
2. You can also answer the incoming call by loudly speaking any word of your choice if Voice Activated Phone Answering (VOX Phone) is enabled, unless you are connected to intercom.
3. To end a call, tap the Phone Button or press the Jog Dial for 2 seconds until you hear a beep, or wait for the called person to end the call.
4. To reject a call, press the Jog Dial for 2 seconds until you hear a beep while the phone is ringing.
5. To transfer a call between the mobile phone and the headset during the phone conversation, press the Phone Button for 2 seconds until you hear a beep.
6. There are several ways to make a phone call:
 - Enter numbers on your mobile phone’s keypad and make a call. Then the call is automatically transferred to the headset.

- For some older mobile phones which do not automatically transfer calls to the headset, press the Phone Button after entering phone numbers on the mobile phone keypad.
- Tap the Phone Button in stand-by mode to activate the voice dialer of your mobile phone. For this, the voice dialing feature must be available on the mobile phone. Refer to your mobile phone manual for further instruction.

Note:

1. *If you are using second mobile phone connection and you have an incoming call from the second phone during a call involving the first phone, then you may still receive the call from second phone. In this case, the call from the first phone is on waiting mode. If you end a call, then it will automatically transfer you to the first phone call.*
2. *If you are using second mobile phone connection of mobile phone and GPS, you may not be able to listen to the GPS voice instruction during the phone call.*

7.2 Speed Dialing

You can quickly make a phone call by using the voice speed dial menu.

1. To enter into the voice speed dial menu, double tap the Phone Button and you will hear a mid-tone single beep and a voice prompt saying “**Speed dial**”.
2. Rotate the Jog Dial clockwise or counter-clockwise to navigate between the menus. You will hear voice prompts for each menu item.
3. Tap the Phone Button to select a voice menu among the followings:

(1) Last number redial

(4) Speed dial 3

(2) Speed dial 1

(5) Cancel

(3) Speed dial 2

4. After selecting the last number redial menu, you will hear a voice prompt saying “**Last number redial**”. Then, to redial the last phone call number, tap the Phone Button.
5. To call one of the speed dials, rotate the Jog Dial clockwise or counter-clockwise to navigate between the menus until you hear a voice prompt saying “**Speed dial (#)**”. Then, tap the Phone Button.

- If you want to exit the speed dial immediately, rotate the Jog Dial until you hear a voice prompt saying **“Cancel”**, and tap the Phone Button or the Jog Dial. If any button is not pressed within 15 seconds, the 20S EVO will exit the voice speed dial menu and go back to stand-by mode.

Note:

- Make sure that you connect the mobile phone and the headset in order to use the speed dial function.
- Speed dial needs to be setup through the headset (refer to section 21.1, “Assigning Speed Dial”), Sena Smartphone App, or Device Manager first.

| | |
|------------|--|
| Answer | Tap Phone Button or Tap Jog Dial or Say “Hello” |
| End | Tap Phone Button or Press Jog Dial for 2” |
| Reject | Press Jog Dial for 2” |
| Transfer | Press Phone Button for 2” |
| Call | Use phone keypad |
| Speed Dial | Double tap Phone Button |
| Voice Dial | Tap Phone Button |

Mobile Phone Call Button Operations**7.3 Intercom and Mobile Phone Call**

- When you have an incoming mobile phone call during an intercom conversation, you will hear a ring tone. You can choose whether to 1) answer the mobile phone call and stop the intercom conversation, or 2) reject the phone call and stay on the intercom conversation.
 - To answer the phone call and stop the intercom conversation, tap the Jog Dial or the Phone Button. The VOX Phone feature does not work if you are connected to intercom. When you hang up the phone call, the intercom will automatically be recovered.
 - To reject the phone call and stay on the intercom conversation, press the Jog Dial for 2 seconds until you hear a beep. Unlike other motorcycle Bluetooth headsets, this prevents a user from being dropped out of an intercom conversation by an incoming mobile call.
- When you have an incoming intercom call during a mobile phone call, you will hear 4 high tone beeps, alerting you that there is an incoming intercom call. You will also hear a voice prompt saying **“Intercom requested”**. In this case, the intercom call does not override the mobile phone call because intercom has lower priority than mobile call. You have to hang up the mobile phone call to make or receive an intercom call.

8 STEREO MUSIC

You can listen to stereo music in two ways: with the enclosed stereo audio cable or by Bluetooth wireless stereo.

8.1 By Stereo Audio Cable

Plug your stereo MP3 player directly to the 20S EVO by using the enclosed 2.5mm to 3.5mm stereo audio cable. To adjust the volume, rotate the Jog Dial on the headset. You may adjust the volume on the MP3 player also.

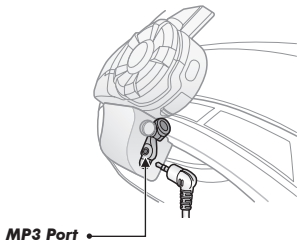

8.2 By Bluetooth Wireless Stereo

The Bluetooth audio device must be paired with the 20S EVO by following the “Bluetooth Stereo Device Pairing” procedures described in the section 5.3. The 20S EVO supports the Audio/Video Remote Control Profile (AVRCP), so if your Bluetooth audio device also supports the AVRCP, you can use the 20S EVO to remotely control music playback. Not only can you adjust the volume but you can also use the functions such as play, pause, next track and previous track. If the Audio Multitasking feature is enabled, you can listen to the music while having an intercom conversation.

1. To adjust the volume, rotate the Jog Dial.

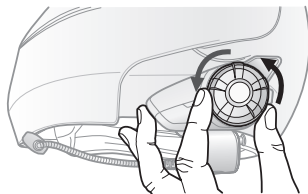

- To play or pause music, press and hold the Jog Dial for 1 second until you hear a double beep.

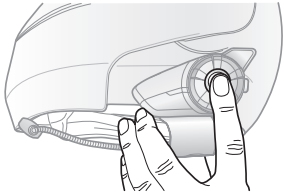

- To track forward or track back, rotate while pressing the Jog Dial clockwise or counter clockwise.

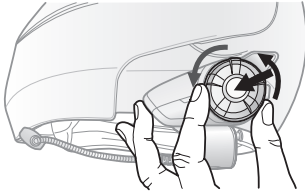

Note:

Bluetooth music is available only when the MP3 port remains open. Please make sure the audio cable is unplugged from the clamp unit to play music by Bluetooth.

8.3 Music Sharing

You can start sharing music with an intercom friend using Bluetooth stereo music during a two-way intercom conversation.

- Enter into a two-way intercom and press and hold the Jog Dial for one second to play music.
- Press and hold the Jog Dial until you hear triple beeps and you will hear a voice prompt saying **“Music sharing on”**.
- To track forward or track back, rotate while pressing down the Jog Dial clockwise or counter clockwise.
- To terminate music sharing, press and hold the Jog Dial until you hear triple beeps and you will hear a voice prompt saying **“Music sharing off”**.

Please refer to chapter 15 for more information on intercom connections.

Note:

- Audio Multitasking must be enabled to use music sharing. Please refer to section 21.2 for more details on the Audio Multitasking feature.*
- Both you and your intercom friend can remotely control music playback during music sharing such as track forward and track back.*
- When you have an incoming call, make a phone call, or hear the turn-by-turn voice instruction of GPS during music sharing, the function will be paused.*

9 GPS NAVIGATION

If you pair a Bluetooth GPS to the 20S EVO as described in section 5.4, “Bluetooth GPS Navigation Pairing”, you can hear the voice instruction of the GPS while having an intercom conversation. The GPS voice instruction does not interrupt intercom conversations.

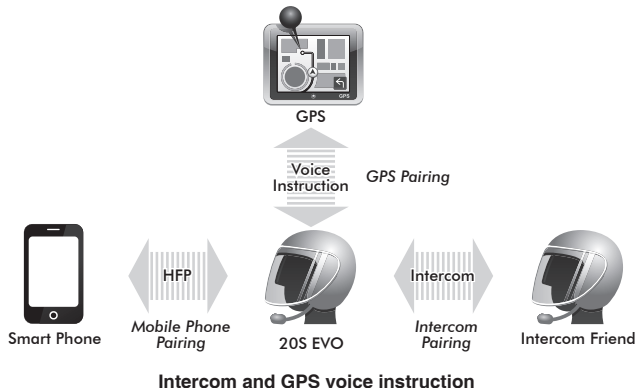

10 SENA SR10, TWO-WAY RADIO ADAPTER

As described in section 5.5, you can use a two-way radio and the 20S EVO Bluetooth intercom simultaneously by using the Sena SR10, a Bluetooth Two-way Radio Adapter, along with the 20S EVO. Incoming audio from the two-way radio will not interrupt an intercom conversation but is heard in background. This is useful when you have an intercom conversation with a passenger on the back seat and use a two-way radio for group communication with other motorcycle riders.

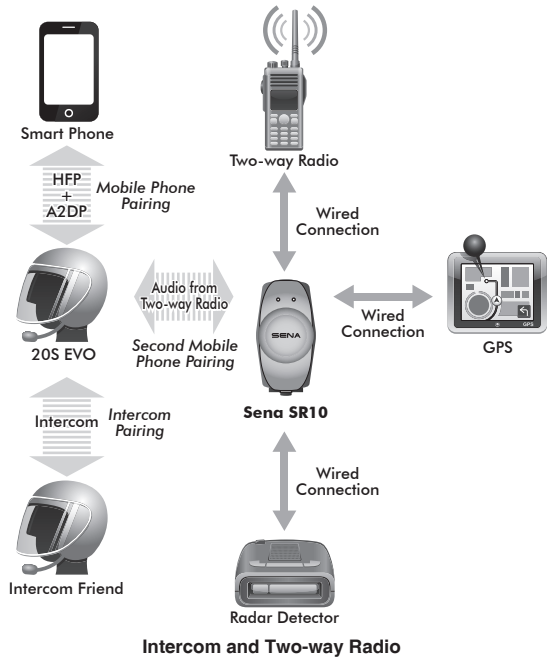

11 FM RADIO

11.1 FM Radio On / Off

To turn on the FM radio, press and hold the Phone Button for 2 seconds until you hear a mid-tone double beep sound. You will then hear a voice prompt saying **“FM on”**. In order to turn off the FM radio, press and hold the Phone Button for 2 seconds until you hear a voice prompt saying **“FM off”**. When you power off, the 20S EVO will remember the last station frequency. When you power it on, the last station frequency will be playing.

11.2 Preset Stations

You can listen to preset stations while listening to the FM radio. Tap the Phone Button once to go upward to your next saved preset station.

11.3 Seek and Save

“Seek” is the function that searches from station to station frequencies. To use the “Seek” function, please follow the procedure below:

1. Rotate while pressing the Jog Dial clockwise to search up the station dial or counter clockwise to search down the station dial.
2. If the tuner finds a station while searching frequencies, it stops the seek function.

3. To save the current station, press and hold the Jog Dial for 2 seconds until you hear a voice prompt saying “**Preset (#)**”.
4. Rotate the Jog Dial clockwise or counter clockwise, in order to select which preset number you want for that specific station. You can save up to 10 preset stations. (You may cancel the preset operation by waiting approximately 10 seconds. You will then hear “**Save preset cancelled**”. You can also rotate the Jog Dial clockwise or counter clockwise until you hear “**Cancel**”. Tap the Jog Dial to confirm cancellation. You will then hear “**Save preset cancelled**”).
5. To save the current station, tap the Jog Dial again. You will then hear a voice prompt saying “**Save preset (#)**”.
6. To delete the saved station in the preset number, tap the Phone Button. You will then hear a voice prompt saying “**Delete preset (#)**”.

Note:

1. You can save FM stations to presets before using FM radio. Connect the 20S EVO to your PC and open the Device Manager. It allows you to save up to 10 FM station frequency presets on the 20S EVO settings menu. You may do the same operation by using the Sena Smartphone App.
2. You can still answer an incoming phone call and intercom while listening to the FM radio.

11.4 Scan and Save

"Scan" is the function that automatically searches station frequencies, starting from the current frequency and up. To use the scan function, please follow the procedures below:

1. Double tap the Phone Button. Then the current station frequency moves upward to find other station frequencies.
2. If the tuner finds a station, it stays at the station frequency for 8 seconds, then scanning to the next station frequency.
3. Scan function stops when you double tap the Phone Button again.
4. To save a station while scanning frequencies, tap the Phone Button when at that station. You will hear a voice prompt from the 20S EVO saying “**Save preset (#)**”. The station will be saved as the next preset number.
5. All stations preset during “Scan”, will overwrite previously set stations.

11.5 Temporary Preset

With the temporary preset function, you may temporarily preset stations automatically without changing the existing preset stations. Tap the Phone Button three times to automatically scan for 10 temporary preset stations. The temporary preset stations will be cleared when the system is powered off.

11.6 Region Selection

You can select proper FM frequency region from the Device Manager. With the region setting, you may optimize seek function to avoid unnecessary frequency range (Factory default: Americas).

| Region | Frequency range | Step |
|-----------|------------------|-----------|
| Worldwide | 76.0 ~ 108.0 MHz | ± 100 kHz |
| Americas | 87.5 ~ 107.9 MHz | ± 200 kHz |
| Asia | 87.5 ~ 108.0 MHz | ± 100 kHz |
| Australia | 87.5 ~ 107.9 MHz | ± 200 kHz |
| Europe | 87.5 ~ 108.0 MHz | ± 100 kHz |
| Japan | 76.0 ~ 95.0 MHz | ± 100 kHz |

12 AMBIENT MODE

You can hear the ambient sound outside of your helmet by activating the Ambient Mode. To activate the Ambient Mode, press twice the Ambient Mode Button which is placed on the bottom of the clamp unit. To deactivate the Ambient Mode, press twice the Ambient Mode Button again.

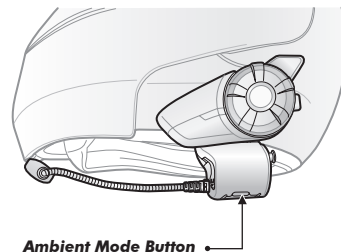

Note:

The ambient mode has higher priority than mobile phone, so you cannot make or answer phone call, listen to music, or have an intercom conversation if the Ambient Mode is activated.

13 VOICE COMMAND

The voice command of the 20S EVO allows you to operate certain operations by simply using your voice. You can control the 20S EVO completely handsfree using the voice recognition. The voice command function works only with English commands.

Voice Command Procedure:

1. There are three ways to enter the voice command mode. The simplest way is to tap once on the Ambient Mode Button. Another way is to double tap the surface of the 20S EVO or the helmet surrounding the 20S EVO. Be careful not to press the Jog Dial during this process. Lastly, you can say, **“Hello Sena”** during standby mode.
2. Speak a voice command from the table below:

| Mode Status | Function | Voice Command |
|---------------------------------|-------------------------|--|
| Standby / Music / FM Radio / | Start/End each Intercom | “Intercom [one, two, ... , nine]” |
| | End all intercoms | “End intercom” |
| | Call last intercom | “Last intercom” |
| | Group Intercom | “Group intercom” |
| | Intercom pairing | “Pairing intercom” |
| | Cancelling operations | “Cancel” |
| Standby | Play/Pause music | “Music” or “Stereo” |
| | Turn on/off FM radio | “FM radio” |
| | Check battery | “Check battery” |
| | Speed dialing | “Speed dial [one, two, three]” |
| | Redial the last call | “Redial” |
| | Voice command help | “What can I say?” |
| | Check connected devices | “Connected devices” |
| Configuration menus | “Configuration” | |

| Mode Status | Function | Voice Command |
|------------------|---|---------------|
| Music / FM Radio | Next track (music) / next preset (FM radio) | “Next” |
| | Previous track (music) / previous preset (FM radio) | “Previous” |
| | Stop music / FM Radio | “Stop” |

Note:

- Voice command performance may vary based on the environmental conditions including riding speed, helmet type and ambient noise. To improve the performance, minimize wind noise on the microphone by using the large microphone sponge and closing the visor.*
- To activate the voice command during non-stand-by functions, tap the Ambient Mode Button or double tap the surface of the main unit.*
- If the 20S EVO is in stand-by mode for longer than one minute then the microphone will automatically be disabled and the Voice Command feature cannot be activated by saying “Hello Sena”. The Voice Command feature will need to be activated by tapping the Ambient Mode Button once or double tapping the surface on the 20S EVO.*

14 INTERCOM PAIRING

14.1 Pairing with Other 20S EVO Headsets for Intercom Conversation

The 20S EVO can be paired with up to nine other headsets for Bluetooth intercom conversation.

- Turn on the two 20S EVO headsets (A and B) that you would like to pair with each other.
- There are two ways you can enter the two headsets into pairing mode.
 - Press and hold the Jog Dial of the headset A and B for 6 seconds until red LEDs of both units start to flash rapidly. You will hear a voice prompt saying “**Intercom pairing**”.
 - Remove the two headsets from the clamps. Grab them with each hand and shake them simultaneously until the green LEDs of the both units start to flash rapidly.

- Simply tap the Jog Dial of any one of the two headsets A or B (It doesn't matter that you choose A or B.) and wait until the LEDs of both headsets turn to blue and intercom connection is automatically established. The two 20S EVO headsets A and B are paired with each other for intercom conversation. If the pairing process is not completed within one minute, the 20S EVO will return to stand-by mode.

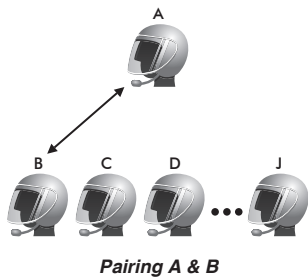

- You can pair with up to nine other headsets. To pair with more headsets such as A and C, A and D, and more, simply follow the same procedure as above.

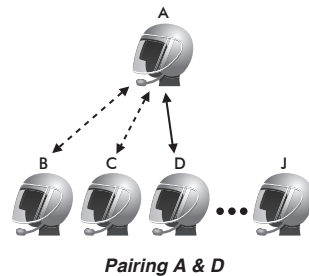
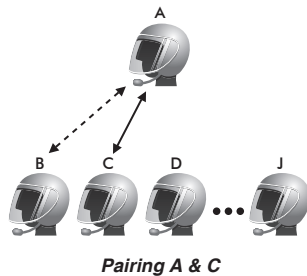

- The intercom pairing queue is '**Last-Come, First-Served**'. If a headset has multiple paired headsets for intercom conversations, the last paired headset is set as **first intercom friend**. The previous intercom friend becomes **second intercom friend**, and **third intercom friend**.

Note:

- For example, after the pairing procedures listed above, headset D is the **first intercom friend** of headset A. Headset C is the **second intercom friend** of headset A, and headset B is the **third intercom friend** of headset A.
- Pairing by shaking works only between 20S EVO devices.
- If you want to cancel pairing, double tap the Jog Dial during pairing mode.

14.2 Pairing with Other Sena Headset Models for Intercom Conversation

The 20S EVO can be paired with other Sena headset models such as the SPH10 and the SMH5 for intercom conversation. Please follow the same procedure as above to pair with these headset models.

Note:

The SMH5 cannot participate in multi-way intercom with the 20S EVO or the SMH10. The SMH5 has a limited capability of having two-way intercom with each other or with other Sena headsets such as the SMH10 and the SMH5.

15 TWO-WAY & MULTI-WAY INTERCOM

15.1 Two-way Intercom

- You can start an intercom conversation with one of any intercom friends by using either the Jog Dial or the voice command. Single tap to start intercom with the **first intercom friend** and double tap to start intercom with the **second intercom friend**. To start intercom with the **third intercom friend** and above, triple tap to enter into friend selection mode. Rotate the Jog Dial to select a friend and tap once more to initiate the intercom with that friend.
- You can end an intercom conversation by using either the Jog Dial or the voice commands. Press and hold for 2 seconds to end any intercom, or use the voice command, "**End Intercom**". Or, you can single tap to end intercom with the **first intercom friend** and double tap to end intercom with the **second intercom friend**. To end intercom with the **third intercom friend** and above, triple tap to enter into friend selection mode. Rotate the Jog Dial to select a friend and tap once more to end intercom with that friend. Also, use the voice command, "**Intercom [one~nine]**" to end each intercom.

| | 1st intercom friend | 2nd intercom friend | 3rd ~ 9th intercom friend |
|------------------|-----------------------------|---------------------|---|
| Start intercom | Single tap | Double tap | Triple tap → Rotate to select friend → Single tap |
| End intercom | Single tap | Double tap | Triple tap → Rotate to select friend → Single tap |
| End any intercom | press and hold for 2 second | | |

Start & End Two-way Intercom

15.2 Multi-way Intercom

15.2.1 Start Three-way Intercom

You (A) can have a three-way intercom with two other 20S EVO friends (B & C) by establishing two intercom connections at the same time.

1. You (A) need to be paired with two other friends (B & C) for three-way intercom.

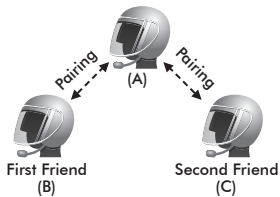

2. Start an intercom conversation with one of the two friends in your intercom group. For example, you (A) may start an intercom conversation with the intercom friend (B). Or intercom friend (B) may start an intercom call with you (A).

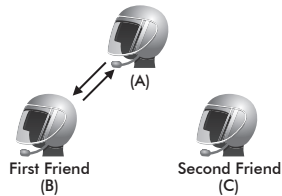

3. The second intercom friend (C) may join the intercom by making an intercom call to you (A). You (A) may also connect the second intercom friend (C).

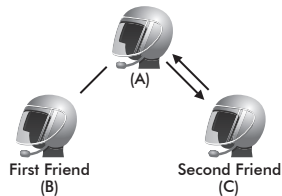

4. Now you (A) and two 20S EVO intercom friends (B & C) are having a three-way intercom.

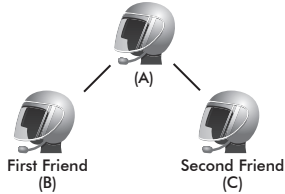

15.2.2 End Three-way Intercom

When you are a member of an active three-way intercom, you can completely terminate the intercom or just disconnect an intercom connection with one of your active intercom friends.

1. Press the Jog Dial for 2 seconds until you hear double beeps to terminate a three-way intercom completely. It terminates both intercom connections with (B) and (C).
2. Tap or double tap the Jog Dial to disconnect intercom connection with one of the two intercom friends accordingly. For example, by single tapping the Jog Dial, you can just terminate the intercom connection with the first intercom friend (B). However, you still have the intercom connection with your second intercom friend (C).

| Jog Dial Operation | Result |
|--------------------|----------------------|
| Press for 2" | Disconnect (B) & (C) |
| Single tap | Disconnect (B) |
| Double tap | Disconnect (C) |

15.2.3 Start Multi-way Intercom

You can have multi-way intercom with up to seven other 20S EVO users by creating an intercom chain. Both the head and the tail of the chain can add new participants.

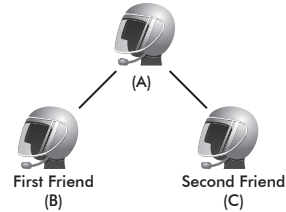

For example, if you have a three-way intercom set up, the new participant (D) can be added to either (B)-the head, or (C)-the tail. If (D) were added to (C), then (D) becomes the new tail of the chain. If (D) were added to (B), then (D) becomes the new head. In this way, an intercom chain can hold up to eight people.

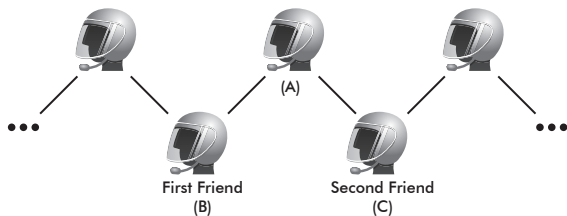

Please note that each participant's intercom friends are the ones adjacent to each other.

Note:

To have multi-way intercom with more than four participants, you must enable Eight-way Intercom. Please refer to section 21.10 "Enabling/Disabling Eight-way Intercom" for more details.

15.2.4 End Multi-way Intercom

You can completely get out of the multi-way intercom or just disconnect a part of the chain.

1. Press the Jog Dial for 2 seconds until you hear double beeps to terminate multi-way intercom. It terminates the intercom connections between you (A), and all participants in the chain.
2. Single tap or double tap the Jog Dial to disconnect intercom connection between one of the two intercom friends. A single tap will disconnect the intercom connection between you (A) and (B).

Rest of the connection of the chain will be preserved. Likewise, double tap will disconnect the intercom connection between you (A) and (C), while preserving rest of the connections.

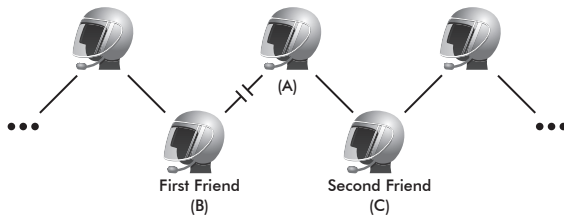

Single Tap

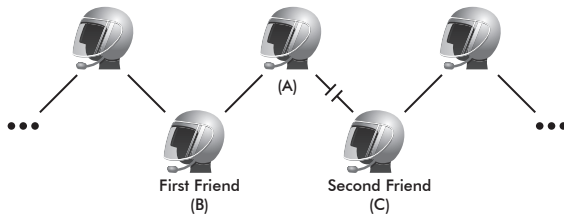

Double Tap

| Jog Dial Operation | Result |
|-----------------------|--|
| Press and hold for 1" | Disconnect all participants |
| Single tap | Disconnect participants chained to (B) |
| Double tap | Disconnect participants chained to (C) |

Note:

Multiple headsets are connected during multi-way intercom. With various signals interfering each other, the intercom distance of multi-way intercom is somewhat shorter than that of two-way intercom.

15.3 Intercom Failure

When you try to start an intercom conversation with an intercom friend who is already having a multi-way intercom with other riders or a mobile phone call, you will hear a low tone double beep signifying an intercom busy signal. In this case, you have to try again later.

15.4 Intercom Reconnection

If your intercom friend goes out of range while having an intercom conversation, you may hear static noise and eventually the intercom will be disconnected. In this case, the 20S EVO automatically tries to reconnect the intercom every 8 seconds and you will hear high tone double beeps until the intercom is reestablished. If you don't want to make a reconnection, tap the Jog Dial to stop the attempt.

16 THREE-WAY CONFERENCE PHONE CALL WITH INTERCOM PARTICIPANT

You can have a three-way conference phone call by adding an intercom friend to the mobile phone conversation. While having a mobile phone call, make an intercom call to one of the intercom friends by tapping the Jog Dial to form a three-way conference call with the person on the mobile phone line. To disconnect the intercom first and go back to your private mobile phone call, terminate the intercom by tapping the Jog Dial. To end the mobile phone call first and maintain the intercom conversation, press the Jog Dial for 2 seconds, or tap the phone button, or wait for the person on the mobile phone line to end the call.

| | |
|----------------------|---|
| Start | Tap Jog Dial while having a mobile phone call |
| End intercom first | Tap Jog Dial |
| End phone call first | Press Jog Dial for 2" or Tap Phone Button or Wait for the called person to end the call |

Start & End Three-way Conference Phone Call

17 GROUP INTERCOM

Group Intercom allows you to instantly create a multi-way conference intercom of up to eight participants. You can create and start Group Intercom through your Smartphone App.

1. Start your Smartphone App and go to 'Group Setting' under 'Group Intercom'.
2. Browse your friends, and select up to seven other people you want to group with.
3. Check your friends and press 'Save to My 20S EVO' on the screen.
4. Press 'Connect' on the screen or the Ambient Mode Button for 1 second to begin Group Intercom.

Note:

To use Group Intercom with more than four participants, you must enable Eight-way Intercom. Please refer to section 21.10, "Enabling/Disabling Eight-way Intercom" for more details.

18 UNIVERSAL INTERCOM

You can have an intercom conversation with non-Sena Bluetooth headsets using the Universal Intercom function. Non-Sena Bluetooth headsets can be connected to the Sena Bluetooth headset if they support the Bluetooth Hands-Free Profile (HFP). The working distance may differ depending on the performance of Bluetooth headset that it is connected to. In general, it is shorter than normal intercom distance since it uses the Bluetooth handsfree profile.

18.1 Universal Intercom Pairing

The 20S EVO can be paired with non-Sena Bluetooth headsets for Bluetooth intercom conversation. You can pair the 20S EVO with only one non-Sena Bluetooth headset so if you pair with a different non-Sena Bluetooth headset, the previous pairing list will be removed.

1. Turn on the 20S EVO and a non-Sena Bluetooth headset that you want to pair with.

2. Press the Jog Dial for 12 seconds to enter the configuration menu. Rotate the Jog Dial until you hear a voice prompt saying **“Universal intercom pairing”**. Press the Phone Button to enter into Universal Intercom Pairing mode and the blue LED will flash rapidly and you will hear multiple beeps. Please refer to section 21.17, “Universal Intercom Pairing” for more details.
3. Perform the operation required for handsfree pairing on the non-Sena Bluetooth headset (refer to the user’s manual of the headsets you want to use). The 20S EVO will automatically perform pairing with non-Sena Bluetooth headsets in pairing mode.

18.2 Two-way Universal Intercom

You can initiate the Universal Intercom connection with non-Sena Bluetooth headsets using the same intercom connection method as you would between other Sena headsets. You may single tap the Jog Dial to begin an intercom conversation with the first intercom friend, double tap with the second intercom friend, and triple tap with the third intercom friend.

Non-Sena Bluetooth headsets may initiate the Universal Intercom connection by activating the voice dialing or using the redialing operation. You may also disconnect the existing connection by ending a call operation function (refer to the user’s manual of the headsets for voice dialing, redialing, and ending a call).

18.3 Three-way Universal Intercom

You may make a three-way Universal Intercom connection with two 20S EVOs and one non-Sena Bluetooth headset.

1. You (A) need to be paired with a non-Sena Bluetooth headset (B) and another 20S EVO headset (C) for the three-way intercom.

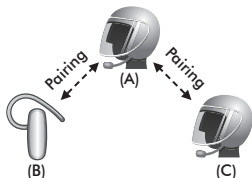

2. Start an intercom conversation with non-Sena Bluetooth headset (B) in your intercom group. For example, you (A) may start an intercom conversation with non-Sena Bluetooth headset (B). The non-Sena Bluetooth headset (B) may also start an intercom call with you (A).

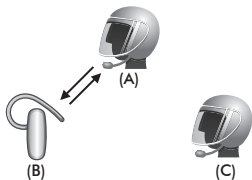

3. The other 20S EVO (C) may join the intercom by making an intercom call to you (A).

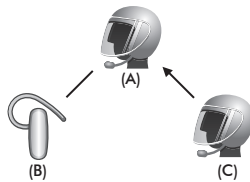

4. Now you (A), non-Sena Bluetooth headset (B), and the other 20S EVO (C) are having a three-way intercom.

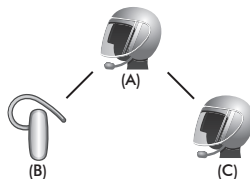

5. You may disconnect three-way Universal Intercom using the same way as you do in normal three-way intercom. Please refer to section 15.2.2, "End Three-way Intercom".

18.4 Four-way Universal Intercom

You may make a four-way Universal Intercom connection with a couple of different configurations, 1) three 20S EVOs and one non-Sena Bluetooth headset or 2) two 20S EVOs and two non-Sena Bluetooth headsets.

You may have a couple of other four-way Universal Intercom configurations, 1) your headset (A), a non-Sena Bluetooth headset (B), another 20S EVO (C), and a non-Sena Bluetooth headset (D), 2) your headset (A), a non-Sena Bluetooth headset (B), and two other 20S EVO headsets (C and D). You may make the four-way Universal Intercom call the same way as a normal four-way intercom call.

18.4.1 Four-way Universal Intercom Case 1

Two 20S EVO headsets (A and C) and two non-Sena Bluetooth headsets (B and D).

1. You (A) may start an intercom conversation with the non-Sena Bluetooth headset (B).

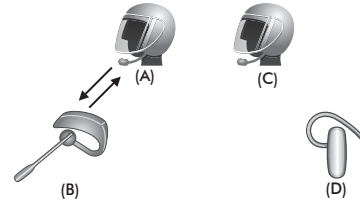

2. The other 20S EVO (C) may join the intercom by making an intercom call to you (A).

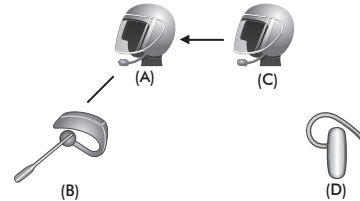

- The non-Sena Bluetooth headset (D) may join the three-way intercom by making an intercom call to the 20S EVO (C).

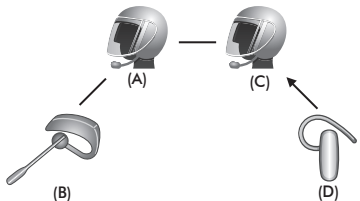

- Now two 20S EVO headsets (A & C) and two non-Sena Bluetooth headsets (B & D) are connected with the four-way Universal Intercom.

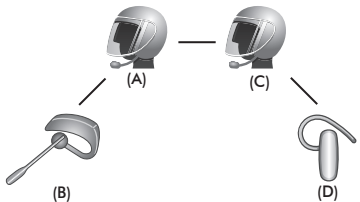

You may disconnect a four-way Universal Intercom using the same way as you do in a normal four-way intercom. Please refer to section 15.2.4, “End Multi-way Intercom”.

18.4.2 Four-way Universal Intercom Case 2

Three 20S EVO headsets (A, C and D) and one non-Sena Bluetooth headset (B).

The procedure is the same as case 1 described in section 18.4.1.

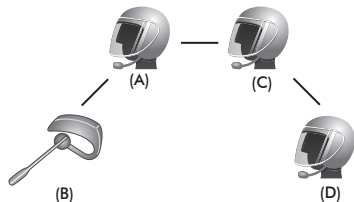

19 REMOTE CONTROL

You can remotely control the 20S EVO via Bluetooth using the Remote Control (sold separately). This eliminates the need to take off your hand for button operations. Your 20S EVO and the Remote Control must be paired together before use.

1. Turn on the 20S EVO and the Remote Control.
2. Press the Jog Dial for 12 seconds to enter the configuration menu. Rotate the Jog Dial until you hear a voice prompt saying, **“Remote control pairing”**. Press the Phone Button to enter into Remote Control Pairing mode and the red LED will flash rapidly and you will hear multiple beeps. Please refer to section 21.16, “Remote Control Pairing” for more details.
3. Enter Bluetooth pairing mode on your Remote Control. The 20S EVO will automatically perform pairing with the Remote Control in pairing mode. You will hear a voice prompt, **“Remote control connected”**, when they are successfully connected.

20 FUNCTION PRIORITY

The 20S EVO operates in the following order of priority:

- (highest)** Ambient mode
- Mobile phone
- Voice command mode
- Intercom
- Stereo music by audio cable
- Music sharing by Bluetooth stereo music
- FM Radio
- (lowest)** Bluetooth stereo music

A lower priority function is always interrupted by a higher priority function. For example, stereo music is interrupted by intercom call, and intercom conversation is interrupted by incoming mobile phone call.

21 20S EVO CONFIGURATION SETTING

You can set the configuration of the 20S EVO by the voice menu instruction as below.

1. To enter into voice configuration menu, press and hold the Jog Dial for 12 seconds until the LED shows solid blue and you hear high tone double beeps. You will also hear a voice prompt saying **“Configuration menu”**.
2. Rotate the Jog Dial clockwise or counter-clockwise to navigate between the menus. You will hear voice prompts for each menu item as below.
3. You can enable the feature or execute the command by tapping the Phone Button, or disable the feature by tapping the Jog Dial.
4. If any button is not pressed within 10 seconds, the 20S EVO will exit the configuration and go back to stand-by.
5. If you want to exit the configuration immediately, rotate the Jog Dial until you hear a voice prompt saying **“Exit configuration”**, and tap the Phone Button.

The voice prompt for each menu item is as below:

- | | |
|---|--|
| (1) Speed dial | (10) Eight-way intercom |
| (2) Audio multitasking | (11) Voice prompt |
| (3) Intercom-audio overlay sensitivity | (12) FM station guide |
| (4) Navigation app support | (13) Sidetone |
| (5) Audio boost | (14) Noise control |
| (6) Smart volume control | (15) Delete all pairings |
| (7) Motion sensor sensitivity | (16) Remote control pairing |
| (8) VOX phone | (17) Universal intercom pairing |
| (9) HD intercom | (18) Exit configuration |

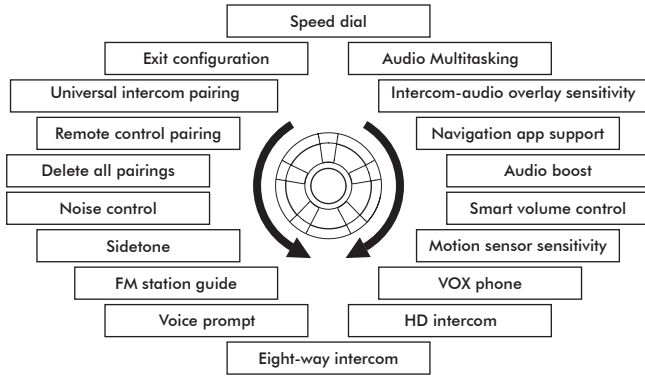

21.1 Assigning Speed Dial

| | |
|-----------------|----------------------|
| Voice Prompt | “Speed dial” |
| Factory Default | N/A |
| Execute | Tap the Phone Button |

- To assign a phone number as a speed dial, rotate the Jog Dial until you hear a voice prompt saying **“Speed dial”**.
- Tap the Phone Button, and you will hear voice prompts saying **“Speed dial one”** and **“Phone connected”**.
 - Rotate the Jog Dial to select one of three speed dial numbers and you hear a voice prompt saying **“Speed dial (#)”**.
- Call a phone number you want to assign and you will hear a voice prompt saying **“Save speed dial (#)”**. The phone number is automatically assigned to the selected speed dial number. Then the phone call will hang up before being connected.
- To exit the menu, rotate the Jog Dial clockwise or counter clockwise until you hear a voice prompt saying **“Exit”**, and tap the Phone Button to confirm. You will then hear a voice prompt saying **“Exit”**. If any button is not pressed within 1 minute, the 20S EVO will exit the configuration menu and go back to stand-by mode.

Note:

1. After assigning a phone number to one of three speed dials, you can continually assign another phone number to the rest of two speed dials.
2. You can also assign phone numbers for speed dialing by using the Device Manager software or the Sena Smartphone App. Please visit the Sena Bluetooth website at www.sena.com for more information.

21.2 Enabling/Disabling Audio Multitasking

| | |
|-----------------|-----------------------------|
| Voice Prompt | “Audio multitasking” |
| Factory Default | Enable |
| Enable | Tap the Phone Button |
| Disable | Tap the Jog Dial |

Audio Multitasking allows you to have an intercom conversation while simultaneously listening to music, FM radio, or GPS instructions. The overlaid audio is played in the background with reduced volume whenever there is an intercom conversation and will return to normal volume once the conversation is finished. If this feature is disabled, any incoming or outgoing intercom will interrupt your audio channel.

21.3 Setting Intercom-audio Overlay Sensitivity

| | |
|------------------|---|
| Voice Prompt | “Intercom-audio overlay sensitivity” |
| Factory Default | 6 |
| Level Adjustment | Rotate the Jog Dial (1~10) |
| Apply | Tap the Phone Button |

When the Audio Multitasking setting is enabled, if you talk over the intercom while music is playing, then the music volume will be lowered to play in the background. You can adjust the intercom sensitivity to activate this background music mode. To adjust this intercom sensitivity, tap the Phone Button when you hear the voice prompt, **“Intercom-audio overlay sensitivity”**. Rotate the Jog Dial to adjust the sensitivity level. Level 1 has the lowest sensitivity and level 10 has the highest sensitivity. Tap the Phone Button to save the level of sensitivity and you will hear the voice prompt **“Save (#)”**.

Before you confirm the selected level, you can test its sensitivity by saying a word out loud or blowing into the mic. If your voice is larger than the sensitivity of the selected level, you will hear double beeps. If your voice is smaller than the sensitivity of the selected level, you will not hear anything.

21.4 Enabling/Disabling Navigation App Support

| Voice Prompt | “Navigation app support” |
|-----------------|--------------------------|
| Factory Default | Disable |
| Enable | Tap the Phone Button |
| Disable | Tap the Jog Dial |

When Audio Multitasking is enabled, your smartphone’s GPS application reduces in volume whenever there is an ongoing intercom conversation. To listen to your smartphone’s GPS navigation clearly without this volume reduction, enable Navigation App Support.

Note:

The volume level of the music will not be reduced during an intercom conversation when the Navigation App Support setting is enabled.

21.5 Enabling/Disabling Audio Boost

| Voice Prompt | “Audio boost” |
|-----------------|----------------------|
| Factory Default | Disable |
| Enable | Tap the Phone Button |
| Disable | Tap the Jog Dial |

Audio Boost increases the overall maximum volume. Disabling Audio Boost will reduce the overall maximum volume.

21.6 Setting Smart Volume Control

| Voice Prompt | “Smart volume control” |
|------------------|--|
| Factory Default | Disable |
| Level Adjustment | Rotate the Jog Dial (Low/Medium/High/Disable) |
| Apply | Tap the Jog Dial |

Smart Volume Control automatically changes the level of the speaker volume based on the level of the environmental noise. When it is disabled, volume is controlled manually. Rotate the Jog Dial until you hear the voice prompt, “**Smart volume control**”. By tapping the Phone Button, it will lead you to the level adjustment mode. You can enable it by setting the sensitivity to low, medium, or high. Smart Volume Control responds to smaller environmental noises as the sensitivity level becomes higher.

21.7 Setting Motion Sensor Sensitivity

| | |
|------------------|---|
| Voice Prompt | “Motion sensor sensitivity” |
| Factory Default | Low |
| Level Adjustment | Rotate the Jog Dial (High/Low/Disable) |
| Apply | Tap the Phone Button |

Motion Sensor Sensitivity determines the sensitivity when you double tap on the surface of the 20S EVO to enter voice command mode. Rotate the Jog Dial until you hear the voice prompt, **“Motion sensor sensitivity”**. By tapping the Phone Button, it will lead you to level adjustment mode. Default is at low, but you may change it to high, or disable the feature by rotating the Jog Dial. After you have completed the setting, tap the Phone Button to apply the changes. If this feature does not work properly, disable this feature, and press on the Ambient Mode Button to enter voice command mode.

21.8 Enabling/Disabling Voice Activated Phone Answering

| | |
|-----------------|----------------------|
| Voice Prompt | “VOX phone” |
| Factory Default | Enable |
| Enable | Tap the Phone Button |
| Disable | Tap the Jog Dial |

If this feature is enabled, you can answer incoming calls by simply saying a word loudly enough, unless you are connected to intercom. For example, when you hear a series of beeps for an incoming call, you can answer the phone by saying **“Hello”** or any other word loudly. However, the VOX Phone feature does not work if you are connected to the intercom. This feature is enabled from the factory but can be disabled through the configuration menu, Device Manager, or the Sena Smartphone App. If this mode is disabled, you have to tap the Jog Dial or the Phone Button to answer an incoming call.

21.9 Enabling/Disabling HD Intercom

| | |
|-----------------|----------------------|
| Voice Prompt | “HD intercom” |
| Factory Default | Enable |
| Enable | Tap the Phone Button |
| Disable | Tap the Jog Dial |

HD Intercom enhances the two-way intercom audio from normal quality to HD quality. HD Intercom will become temporarily disabled when you enter into a multi-way intercom. If this feature is disabled, the two-way intercom audio will change to normal quality.

Note:

The intercom distance of HD Intercom is relatively shorter than that of normal intercom.

21.10 Enabling/Disabling Eight-way Intercom

| | |
|-----------------|----------------------|
| Voice Prompt | “Eight-way intercom” |
| Factory Default | Disable |
| Enable | Tap the Phone Button |
| Disable | Tap the Jog Dial |

Disabling the Eight-way Intercom optimizes the intercom performance for a small group up to four participants. Enabling the Eight-way Intercom optimizes the intercom performance for a larger group up to eight participants.

21.11 Enabling/Disabling Voice Prompts

| Voice Prompt | “Voice prompt” |
|-----------------|----------------------|
| Factory Default | Enable |
| Enable | Tap the Phone Button |
| Disable | Tap the Jog Dial |

You can disable voice prompts, but the following voice prompts are always on.

- Voice prompts for configuration setting menu
- Voice prompts for battery level Indicator
- Voice prompts for factory reset
- Voice prompts for speed dial
- Voice prompts for FM radio functions

21.12 Enabling/Disabling FM Station Guide

| Voice Prompt | “FM station guide” |
|-----------------|----------------------|
| Factory Default | Enable |
| Enable | Tap the Phone Button |
| Disable | Tap the Jog Dial |

When FM Station Guide is enabled, FM station frequencies are given by voice prompts as you select preset stations. When FM Station Guide is disabled, the voice prompts on FM station frequencies will not be given as you select preset stations.

21.13 Enabling/Disabling Sidetone

| Voice Prompt | “Sidetone” |
|-----------------|----------------------|
| Factory Default | Disable |
| Enable | Tap the Phone Button |
| Disable | Tap the Jog Dial |

Sidetone is the sound of your own voice as picked up by your headset's microphone and reproduced in your own ear, by your own speaker. It helps you to naturally speak at the correct level according to varying helmet noise conditions. If this feature is enabled, you can hear what you are speaking during an intercom conversation or a phone call.

21.14 Enabling/Disabling Advanced Noise Control™

| | |
|-----------------|------------------------|
| Voice Prompt | “Noise control” |
| Factory Default | Enable |
| Enable | Tap the Phone Button |
| Disable | Tap the Jog Dial |

When Advanced Noise Control is enabled, the background noise is reduced during an intercom conversation. When it is disabled, the background noise is mixed with your voice during intercom.

Note:

If you use your 20S EVO with the Bluetooth Audio Pack for GoPro, you can enable or disable this feature only during Normal Voice Recording. This feature is automatically disabled while in Ultra HD (UHD) Voice Recording mode.

21.15 Delete All Bluetooth Pairing Information

| | |
|-----------------|------------------------------|
| Voice Prompt | “Delete all pairings” |
| Factory Default | N/A |
| Execute | Tap the Phone Button |

To delete all Bluetooth pairing information of the 20S EVO, rotate the Jog Dial until you hear a voice prompt saying **“Delete all pairings”**, and tap the Phone Button to confirm. Tapping the Jog Dial is not available for this setting.

21.16 Remote Control Pairing

| | |
|-----------------|---------------------------------|
| Voice Prompt | “Remote control pairing” |
| Factory Default | N/A |
| Execute | Tap the Phone Button |

To enter into Remote Control Pairing mode, rotate the Jog Dial until you hear a voice prompt, **“Remote control pairing”**. Then press the Phone Button to enter into Remote Control Pairing mode. The headset will automatically exit from the configuration menu. Please refer to section 19 for details on remote control.

21.17 Universal Intercom Pairing

| | |
|-----------------|-------------------------------------|
| Voice Prompt | “Universal intercom pairing” |
| Factory Default | N/A |
| Execute | Tap the Phone Button |

To enter into Universal Intercom Pairing mode, rotate the Jog Dial until you hear a voice prompt, **“Universal intercom pairing”**. Then press the Phone Button to enter into Universal Intercom Pairing mode. The headset will automatically exit from the configuration menu. Please refer to section 18.1 for details on Universal Intercom.

21.18 Exit Voice Configuration Menu

| | |
|-----------------|-----------------------------|
| Voice Prompt | “Exit configuration” |
| Factory Default | N/A |
| Execute | Tap the Phone Button |

To exit voice configuration menu and get back to stand-by mode, rotate the Jog Dial until you hear a voice prompt saying **“Exit configuration”**, and tap the Phone Button to confirm. Tapping the Jog Dial is not available for this setting.

| Rotate Jog Dial | Tap Phone Button | Tap Jog Dial |
|------------------------------------|------------------|--------------|
| Speed Dial | Execute | N/A |
| Audio Multitasking | Enable | Disable |
| Intercom-audio Overlay Sensitivity | Execute | N/A |
| Navigation App Support | Enable | Disable |
| Audio Boost | Enable | Disable |
| Motion Sensor Sensitivity | Execute | N/A |
| VOX Phone | Enable | Disable |
| HD Intercom | Enable | Disable |
| Eight-way Intercom | Enable | Disable |
| Voice Prompt | Enable | Disable |
| FM Station Guide | Enable | Disable |
| Sidetone | Enable | Disable |
| Advanced Noise Control | Enable | Disable |
| Delete All Pairings | Execute | N/A |
| Remote Control Pairing | Execute | N/A |
| Universal Intercom Pairing | Execute | N/A |
| Exit Configuration | Execute | N/A |

Voice Configuration Menu & Button Operations

22 RESET TO FACTORY DEFAULT SETTINGS

1. To restore the 20S EVO to factory default settings, press and hold the Phone Button for 12 seconds until the LED shows solid red and you hear double beeps. You will hear a voice prompt saying **“Factory reset”**.
2. Within 5 seconds, press the Jog Dial to confirm reset. The headset will be restored to factory setting and switched off automatically. You will hear a voice prompt saying **“Headset reset, good-bye”**.
3. If you press the Phone Button or don't press the Jog Dial within 5 seconds, the reset attempt is canceled and the headset returns to stand-by mode. You will hear a voice prompt saying **“Canceled”**

23 FAULT RESET

When the 20S EVO is not working properly or is in faulty status for any reason, you may reset by pushing the pin-hole reset button at the back of the headset main unit. Insert a paper clip into the reset pin-hole and press the reset button for a second with light pressure. The 20S EVO will be switched off, and you have to turn the system back on and try again. However, this will not restore the headset to factory default settings.

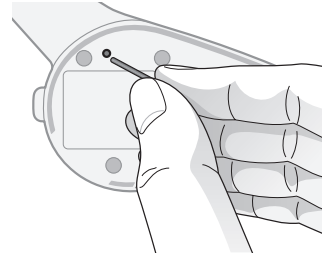

24 FIRMWARE UPGRADE

The 20S EVO supports firmware upgrade function. Please visit Sena Bluetooth web site at www.sena.com to check the latest software downloads.

25 OPERATION QUICK REFERENCE

| Type | Function | Button Command | Voice Command | LED | Beep |
|----------------|-------------------|--|------------------------|----------------|------------------------|
| Basic Function | Power-on | Press the Phone Button and the Jog Dial for 1 second | - | Solid blue | Ascending beeps |
| | Power-off | Press the Phone Button and the Jog Dial | - | Solid red | Descending beeps |
| | Volume adjustment | Rotate the Jog Dial | - | - | - |
| | Configuration | Press the Jog Dial for 12 seconds | “Configuration” | Solid blue | High tone double beeps |
| | Voice command | Double tap the surface of the main unit | “Hello Sena!” | Green flashing | - |
| | Ambient Mode | Double tap the Ambient Mode Button | - | Green flashing | - |

| Type | Function | Button Command | Voice Command | LED | Beep | |
|----------------------|----------------------------------|---|---------------------------------------|-----------------------------------|--------------------------|--|
| Mobile Phone | Mobile phone pairing | Press the Phone Button for 5 seconds | - | Blue & red alternatively flashing | High tone multiple beeps | |
| | Second mobile phone pairing | Press the Jog Dial for 6 seconds | - | Red flashing | Multiple beeps | |
| | | Tap the Phone Button within 2 seconds | | | | |
| | GPS pairing | Press the Jog Dial for 6 seconds | - | Red flashing | Multiple beeps | |
| | | Tap the Phone Button within 2 seconds | | | | |
| | | Tap the Phone Button again within 2 seconds | | | | |
| | Call transfer | Press the Phone Button for 2 seconds | - | - | High tone single beep | |
| | Answer & end phone call | Tap the Phone Button | - | - | - | |
| | Voice dial | Tap the Phone Button | - | - | - | |
| | Speed dial | Double Tap the Phone Button | “Speed dial [one, two, three]” | - | Mid-tone single beep | |
| Reject incoming call | Press the Jog Dial for 2 seconds | - | - | - | | |

| Type | Function | Button Command | Voice Command | LED | Beep |
|----------|----------------------------|---|---------------------------------------|----------------|-----------------------|
| Intercom | Intercom pairing | Press the Jog Dial for 6 seconds | “Pairing intercom” | Red flashing | Mid-tone single beep |
| | | Tap the Jog Dial of any one of the two headsets | | | |
| | Start/End each intercom | Tap the Jog Dial | “Intercom [one, two ... nine]” | - | - |
| | End all intercoms | Press the Jog Dial for 2 seconds | “End intercom” | Blue flashing | Mid-tone double beeps |
| Music | Start Group Intercom | Press the Ambient Mode Button for 1 second | “Group intercom” | Green flashing | - |
| | Play/Pause Bluetooth music | Press the Jog Dial for 1 second | “Music” | - | Mid-tone double beeps |
| | Track forward/back | Rotate the Jog Dial while pressing | “Next”/“Previous” | - | - |

| Type | Function | Button Command | Voice Command | LED | Beep |
|----------|----------------------------|---------------------------------------|-------------------------------|-----------|------------------------|
| FM radio | FM radio on | Press the Phone Button for 2 seconds | "FM radio" | - | Mid-tone double beeps |
| | FM radio off | Press the Phone Button for 2 seconds | "FM radio"/ "Stop" | - | Mid-tone double beeps |
| | Select preset | Tap the Phone Button | "Next"/ "Previous" | - | Mid-tone single beep |
| | Seek stations | Rotate the Jog Dial while pressing | - | - | High tone triple beeps |
| | Scan up FM band | Double tap the Phone Button | - | - | - |
| | Stop scanning | Double tap the Phone Button | - | - | High tone double beeps |
| | Save preset while scanning | Tap the Phone Button | - | - | High tone double beeps |
| Reset | Factory reset | Press the Phone Button for 12 seconds | - | Solid red | High tone double beeps |
| | | Tap the Jog Dial within 5 seconds | | | |
| | Fault reset | Press the Reset Button | - | - | - |

CERTIFICATION AND SAFETY APPROVALS

FCC Compliance Statement

This device complies with part 15 of the FCC rules. Operation is subject to the following two conditions:

- (1) This device may not cause harmful interference, and
- (2) This device must accept any interference received, including interference that may cause undesired operation.

This equipment has been tested and found to comply with the limits for a Class B digital device pursuant to part 15 of the FCC rules. These limits are designed to provide reasonable protection against harmful interference in a residential installation. This equipment generates, uses and can radiate radio frequency energy and, if not installed and used in accordance with the instructions, may cause harmful interference to radio communications. However, there is no guarantee that interference will not occur in a particular installation. If this equipment does cause harmful interference to radio or television reception, which can be determined by turning the equipment on and off, the user is encouraged to try to correct the interference by one or more of the following measures:

- Reorient or relocate the receiving antennae
- Increase the separation between the equipment and the receiver
- Connect the equipment into an outlet on a circuit different from that to which the receiver is connected.
- Consult the dealer or an experienced radio/TV technician for help.

FCC RF Exposure Statement

This equipment complies with FCC radiation exposure limits set forth for an uncontrolled environment. End users must follow the specific operating instructions for satisfying RF exposure compliance. The antenna used for this transmitter must not transmit simultaneously with any other antenna or transmitter, except in accordance with FCC multi-transmitter product procedures.

FCC Caution

Any changes or modifications to the equipment not expressly approved by the party responsible for compliance could void user's authority to operate the equipment.

CE Declaration of Conformity

This product is CE marked according to the provisions of the R&TTE Directive (2014/53/EU). Hereby, Sena declares that the radio equipment type SP38 is in compliance with Directive 2014/53/EU. Please note that this product uses radio frequency bands not harmonized within EU. Within the EU this product is intended to be used in Austria, Belgium, Denmark, Finland, France, Germany, Greece, Ireland, Italy, Luxembourg, The Netherlands, Portugal, Spain, Sweden, United Kingdom and within EFTA in Iceland, Norway and Switzerland.

Industry Canada Statement

This device complies with Industry Canada license-exempt RSS standard(s). Operation is subject to the following two conditions:

- (1) This device may not cause interference.
- (2) This device must accept any interference, including interference that may cause undesired operation of the device.

Bluetooth License

The Bluetooth® word mark and logos are owned by the Bluetooth SIG, Inc. and any use of such marks by Sena is under license. Other trademarks and trade names are those of their respective owners.

The product is compliant with and adopts the Bluetooth® Specification 4.1 and has successfully passed all interoperability tests that are specified in the Bluetooth® specification. However, interoperability between the device and other Bluetooth®-enabled products is not guaranteed.

WEEE (Waste Electrical and Electronic Equipment)



The crossed-out wheel bin symbol on the product, literature, or packaging reminds you that all electrical and electronic products, batteries, and accumulators must be taken to separate collection at the end of their working life. This requirement applies to the European Union and other locations where separate collection

systems are available. To prevent possible harm to the environment or human health from uncontrolled waste disposal, please do not dispose of these products as unsorted municipal waste, but hand it in at an official collection point for recycling.