

RIDE CONNECTED

Blast your favorite tunes, talk over the intercom with your buddies, hear directions from your GPS and more, all through your headset. With built-in Bluetooth® capabilities, Quad HD camera, HD speakers and a microphone using Advanced Noise Control™, technology has never felt so minimal or freeing.

- Bluetooth® Integrated
- 1.6 Km (1.0 Mile) Intercom
- Quad HD Camera Integrated
- Four-Way Intercom
- Unibody Design
- Smart Audio Mix™
- Advanced Noise Control™
- WiFi Enabled
- Audio Multitasking™
- Audio Source Priority

GETTING STARTED

- This product comes with a Quick Start Guide, which is a basic version of the User's Guide. **A FULL VERSION OF THE USER'S GUIDE CAN BE DOWNLOADED AT SENA.COM.**
- Update this product for free with the latest firmware to fully enjoy the new advanced features built into this product. Visit SENA.COM to see how to update your product.
- Users can follow Sena on Facebook, YouTube, Twitter and Instagram to receive the most up to date information on products, helpful tips and all other announcements regarding Sena products.

10C PRO

GETTING STARTED

GETTING STARTED

How to Use This Guide

The legend and callouts are here to help you read the illustrations. New technology can be confusing, but we've created a simple way to perform actions using illustrations.

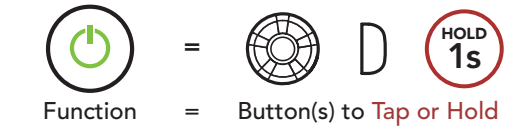

Buttons

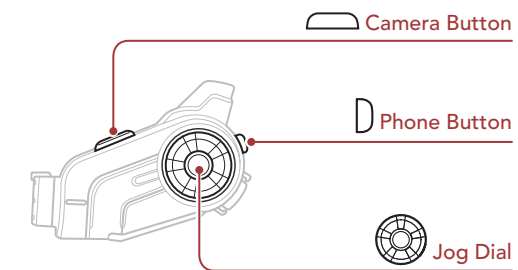

GETTING STARTED

Icon Legend

TAP 1x Tap button/Jog Dial the specified number of times

HOLD 10s Press and Hold button/Jog Dial for the specified amount of time

ROTATE L **ROTATE R** **ROTATE** Rotate Jog Dial clockwise (right) or counterclockwise (left).

ROTATE L **ROTATE R** **ROTATE** Rotate while Pressing Jog Dial clockwise (right) or counterclockwise (left).

"Hello" Audible prompt

QUICK START GUIDE

Product Details

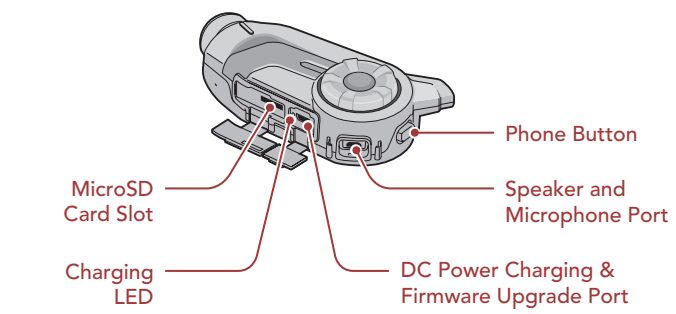
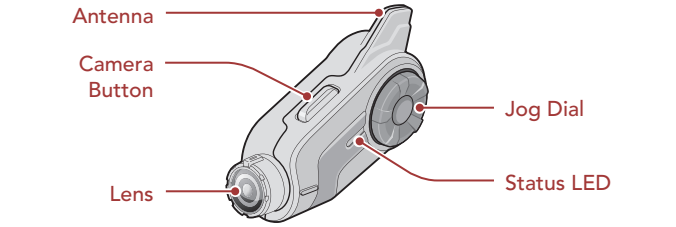

10C PRO

QUICK START GUIDE

QUICK START GUIDE

Installation

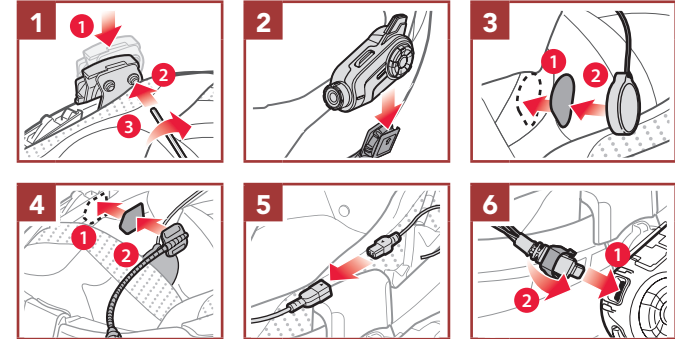

Basic Operations

Powering On



Volume Up



Powering Off

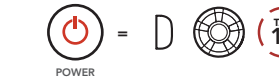

Volume Down

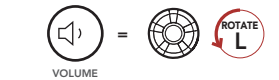

QUICK START GUIDE

Checking the Battery Level

Visual Method

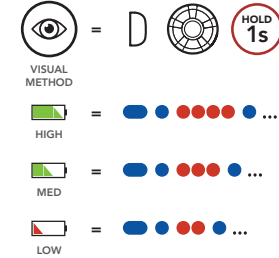

Audible Method

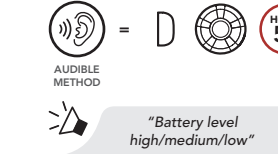

Bluetooth Pairing (Phone, MP3, GPS)

Mobile Phone Pairing



Start Phone Pairing



Steps continued...

Alternating blue and red flashing lights indicate **device is now discoverable**.

LED STATUS

IPIN NUMBER



QUICK START GUIDE

Mobile Phone

Answer a Call



End a Call



Music Controls

Play/Pause

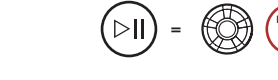

Track forward



Track backward



QUICK START GUIDE

Camera Controls

Camera On



Camera Off

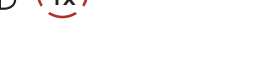

Taking Photos



Note:

- You cannot record videos without a microSD card.
- Your microSD card needs to be formatted before using the camera.
- MicroSD cards up to 64GB and Class 10 or higher cards are compatible.

QUICK START GUIDE

Intercom

Up to three other people can be paired with the headset for Bluetooth intercom conversations.

Pairing Headset A with Headset B

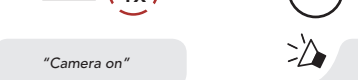

Start Recording



Stop Recording



Note:

- You cannot record videos without a microSD card.
- Your microSD card needs to be formatted before using the camera.
- MicroSD cards up to 64GB and Class 10 or higher cards are compatible.

Intercom pairing



Start/End Intercom with Headset B



LED STATUS

Flashing blue LED confirms intercoms are paired.

LED STATUS

QUICK START GUIDE

Group Intercom

Start Group Intercom

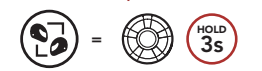

START GROUP INTERCOM

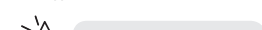

"Group intercom"

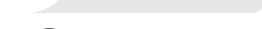

"Group intercom terminated"

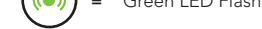

LED STATUS = Green LED Flashing



LED STATUS



LED STATUS

LED STATUS

LED STATUS

LED STATUS

LED STATUS

LED STATUS

LED STATUS

LED STATUS

LED STATUS

LED STATUS

LED STATUS

LED STATUS

LED STATUS

LED STATUS

LED STATUS

LED STATUS

LED STATUS

QUICK START GUIDE

Headset Configuration Menu

Accessing the Headset Configuration Menu



CONFIG. MENU



"Configuration menu"



"Configuration menu"



"Configuration menu"



"Configuration menu"



"Configuration menu"

"Configuration menu"

"Configuration menu"

"Configuration menu"

"Configuration menu"

"Configuration menu"

"Configuration menu"

"Configuration menu"

"Configuration menu"

"Configuration menu"

"Configuration menu"

"Configuration menu"

"Configuration menu"

"Configuration menu"

"Configuration menu"

"Configuration menu"

"Configuration menu"

Camera Configuration Menu

Accessing the Camera Configuration Menu



CAMERA CONFIG. MENU



"Camera Setup"

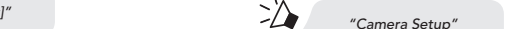

"Camera Setup"



"Camera Setup"



"Camera Setup"



"Camera Setup"

"Camera Setup"

"Camera Setup"

"Camera Setup"

"Camera Setup"

"Camera Setup"

"Camera Setup"

"Camera Setup"

"Camera Setup"

"Camera Setup"

"Camera Setup"

"Camera Setup"

"Camera Setup"

"Camera Setup"

"Camera Setup"

"Camera Setup"

"Camera Setup"

Sena Device Manager

Accessing the Sena Device Manager



CAMERA CONFIG. MENU



"Sena Device Manager"

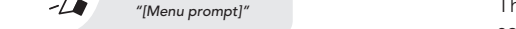

"Sena Device Manager"



"Sena Device Manager"



"Sena Device Manager"

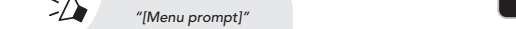

"Sena Device Manager"

"Sena Device Manager"

"Sena Device Manager"

"Sena Device Manager"

"Sena Device Manager"

"Sena Device Manager"

"Sena Device Manager"

"Sena Device Manager"

"Sena Device Manager"

"Sena Device Manager"

"Sena Device Manager"

"Sena Device Manager"

"Sena Device Manager"

"Sena Device Manager"

"Sena Device Manager"

"Sena Device Manager"

"Sena Device Manager"

Sena Smartphone App

Accessing the Sena Smartphone App

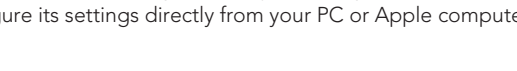

CAMERA CONFIG. MENU



"Sena Smartphone App"



"Sena Smartphone App"



"Sena Smartphone App"



"Sena Smartphone App"



"Sena Smartphone App"

"Sena Smartphone App"

"Sena Smartphone App"

"Sena Smartphone App"

"Sena Smartphone App"

"Sena Smartphone App"

"Sena Smartphone App"

"Sena Smartphone App"

"Sena Smartphone App"

"Sena Smartphone App"

"Sena Smartphone App"

"Sena Smartphone App"

"Sena Smartphone App"

"Sena Smartphone App"

"Sena Smartphone App"

"Sena Smartphone App"

"Sena Smartphone App"

Sena Camera App

Accessing the Sena Camera App

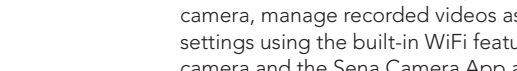

CAMERA CONFIG. MENU

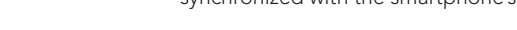

"Sena Camera App"



"Sena Camera App"



"Sena Camera App"



"Sena Camera App"



"Sena Camera App"

"Sena Camera App"

"Sena Camera App"

"Sena Camera App"

"Sena Camera App"

"Sena Camera App"

"Sena Camera App"

"Sena Camera App"

"Sena Camera App"

"Sena Camera App"

"Sena Camera App"

"Sena Camera App"

"Sena Camera App"

"Sena Camera App"

"Sena Camera App"

"Sena Camera App"

"Sena Camera App"

Troubleshooting

Factory Reset

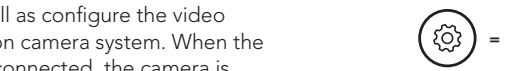

CAMERA CONFIG. MENU

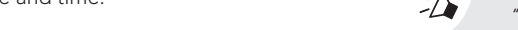

"Factory reset"



"Factory reset"



"Factory reset"



"Factory reset"

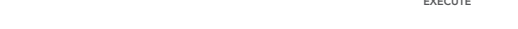

"Factory reset"

"Factory reset"

"Factory reset"

"Factory reset"

"Factory reset"

"Factory reset"

"Factory reset"

"Factory reset"

"Factory reset"

"Factory reset"

"Factory reset"

"Factory reset"

"Factory reset"

"Factory reset"

"Factory reset"

"Factory reset"

"Factory reset"

Fault Reset

Accessing the Fault Reset



CAMERA CONFIG. MENU



"Fault Reset"

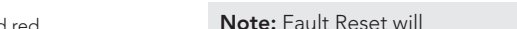

"Fault Reset"

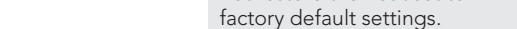

"Fault Reset"



"Fault Reset"



"Fault Reset"

"Fault Reset"

"Fault Reset"

"Fault Reset"

"Fault Reset"

"Fault Reset"

"Fault Reset"

"Fault Reset"

"Fault Reset"

"Fault Reset"

"Fault Reset"

"Fault Reset"

"Fault Reset"

"Fault Reset"

"Fault Reset"

"Fault Reset"

"Fault Reset"

Basic Operations

Power on / Power off



POWER ON / POWER OFF



POWER ON / POWER OFF

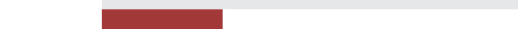

POWER ON / POWER OFF



POWER ON / POWER OFF



POWER ON / POWER OFF



POWER ON / POWER OFF

POWER ON / POWER OFF

POWER ON / POWER OFF

POWER ON / POWER OFF

POWER ON / POWER OFF

POWER ON / POWER OFF

POWER ON / POWER OFF

POWER ON / POWER OFF

POWER ON / POWER OFF

POWER ON / POWER OFF

POWER ON / POWER OFF

POWER ON / POWER OFF

POWER ON / POWER OFF

POWER ON / POWER OFF

POWER ON / POWER OFF

POWER ON / POWER OFF

POWER ON / POWER OFF

Music

Play/Pause music



PLAY/PAUSE MUSIC



PLAY/PAUSE MUSIC



PLAY/PAUSE MUSIC









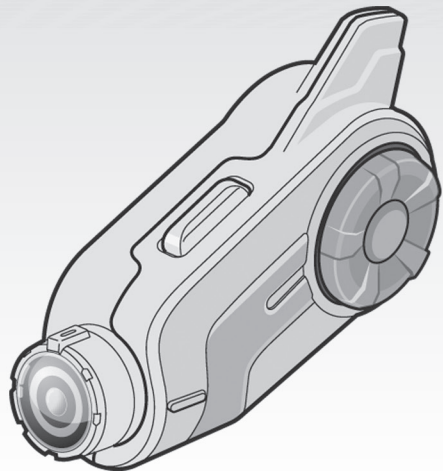









PLAY

10C PRO

Motorcycle Bluetooth®
Camera & Communication System



-  Bluetooth® 4.1
-  Unibody Design
-  QUAD HD 1440P
-  Lens Rotation 30°
-  1.8km Intercom 1.0 mile
-  Four-way Intercom
-  Voice Prompt
-  Smart Audio Mix™
-  Advanced Noise Control
-  Universal Intercom
-  Music Sharing
-  FM Radio
-  Versatile Jog Dial
-  Use While Charging
-  WiFi Enabled
-  Audio Source Priority
-  Audio Multitasking

© 1998-2018 Sena Technologies, Inc. All rights reserved.

Sena Technologies, Inc. reserves the right to make any changes and improvements to its product without providing prior notice.

Sena™ is a trademark of Sena Technologies, Inc. or its subsidiaries in the USA and other countries. SF1™, SF2™, SF4™, SFR™, SRL™, Momentum™, Momentum INC™, Momentum Lite™, Momentum Pro™, Momentum INC Pro™, Cavalry™, 30K™, 20S EVO™, 20S™, 10S™, 10C™, 10C PRO™, 10U™, 10Upad™, 10R™, 3S™, SMH5™, SMH5-FM™, SMH5 MultiCom™, SMH10™, SMH10R™, SPH10™, SPH10H-FM™, Savage™, Prism Tube WiFi™, Prism™, Bluetooth Audio Pack for GoPro®, R1™, RC3™, RC4™, Handlebar Remote™, Wristband Remote™, PowerPro Mount™, Powerbank™, FreeWire™, SR10™, SM10™, X1™, X1 Pro™, Expand™, Tufftalk™, Tufftalk Lite™ are trademarks of Sena Technologies, Inc. or its subsidiaries. These trademarks may not be used without the express permission of Sena.

GoPro® is a registered trademark of Woodman Labs of San Mateo, California. Sena Technologies Inc. ("Sena") is not affiliated with Woodman Labs. The Sena Bluetooth Pack for GoPro® is an after-market accessory specially designed and manufactured by Sena Technologies, Inc. for the GoPro® Hero3 allowing for Bluetooth capabilities.

The Bluetooth® word mark and logos are owned by the Bluetooth SIG, Inc. and any use of such marks by Sena is under license. iPhone, iPod touch are registered trademarks of Apple Inc. Zumo™ is a trademark of Garmin Ltd. or its subsidiaries. TomTom™ is the trademark or registered trademark owned by TomTom International B.V. Other trademarks and tradenames are those of their respective owners.

CONTENTS

Safety Precautions.....	4
1 PACKAGE CONTENTS.....	7
2 INSTALLING THE HEADSET ON YOUR HELMET.....	8
2.1 Installing the Main Unit.....	8
2.2 Installing the Speakers.....	9
2.3 Installing the Microphone.....	10
2.4 Adjusting the angle.....	12
3 GETTING STARTED.....	12
3.1 Product Details.....	12
3.2 Powering On and Off.....	13
3.3 Charging.....	13
3.4 Checking the Battery Level.....	13
3.5 Volume Adjustment.....	13
3.6 Sena Softwares.....	14
4 CAMERA OPERATION.....	15
4.1 Camera On or Off.....	15
4.2 Camera Modes.....	15
4.3 Video Recording.....	15
4.4 Video Mode (Default: Normal Recording Mode).....	16
4.5 Photo Taking.....	16
4.6 Video Tagging.....	16
5 PAIRING THE HEADSET WITH BLUETOOTH DEVICES.....	17
5.1 Mobile Phone Pairing - Mobile Phone, Bluetooth Stereo Device.....	17
5.2 Second Mobile Phone Pairing - Second Mobile Phone, GPS, and SR10.....	17
5.3 Advanced Selective Pairing: A2DP Stereo or Handsfree.....	18
5.4 Intercom Pairing.....	19
6 MOBILE PHONE, GPS.....	20
6.1 Mobile Phone Call Making and Answering.....	20
6.2 Speed Dialing.....	21
6.3 GPS Navigation.....	21
7 STEREO MUSIC.....	22
7.1 Bluetooth Stereo Music.....	22
7.2 Music Sharing.....	22
8 INTERCOM.....	23
8.1 Two-way Intercom.....	23
8.2 Multi-Way Intercom.....	23
9 THREE-WAY CONFERENCE PHONE CALL WITH INTERCOM PARTICIPANT.....	25
10 GROUP INTERCOM.....	25
11 UNIVERSAL INTERCOM.....	26
12 FM RADIO.....	27
12.1 FM Radio On/Off.....	27
12.2 Preset Stations.....	27
12.3 Seek and Save.....	27
12.4 Scan and Save.....	27
12.5 Temporary Preset.....	27
12.6 FM Sharing.....	28
12.7 Region Selection.....	28
13 FUNCTION PRIORITY.....	29
14 CONFIGURATION SETTING.....	29
14.1 Headset Configuration Setting.....	29
14.2 Software Configuration Setting.....	30
14.3 Camera Configuration Setting.....	34
15 FIRMWARE UPGRADE.....	36
16 TROUBLESHOOTING.....	36
16.1 Fault Reset.....	36
16.2 Factory Reset.....	36

Safety Precautions

Please ensure that the product is properly used by observing the safety precautions below to prevent any risk of serious injury, death and/or damage to property.

Hazard alert signal words

The following safety symbols and signal words are used in this manual.

 **WARNING** Indicates a potential hazardous situations that, if not avoided, could result in death or serious injury.

 **CAUTION** Indicates a potential hazardous situation that, if not avoided, could result in minor or moderate injury.

NOTICE Indicates information considered important, but not hazard-related. If not avoided, it could cause damage to your product.

Note Notes, usage tips, or additional information

Product Use

Observe the following precautions to avoid injury or damage to your product while using the product.

 **WARNING**

- Use of the product at a high volume for a long period of time may damage your eardrums or hearing ability.

- When relevant, follow all regulations regarding the use of the camera.
 - (1) Do not use your camera in an aircraft, unless permitted.
 - (2) Turn off the camera when you are near medical equipment. Your camera can cause interference with medical devices in hospital or healthcare facilities.
- The camera generates a low level magnetic field. Keep a safe distance between the camera and cardiac pacemakers to avoid potential interference. Turn off the camera immediately if your camera indicates interference with a pacemaker and contact the pacemaker manufacturer or a physician.
- Avoid interference with other electronic devices. Your camera generates a low level magnetic field that may interfere with unsealed or improperly shielded electronic equipment in homes or vehicles. Consult the manufacturers of your electronic devices to resolve any interference problems you experience.
- Never use a damaged memory card. This may result in electric shock, camera malfunction, or fire.
- Careless use of the product on the road is risky and may result in serious injury, death or damage. You must heed all safety precautions in all documents that come with this product. This will help minimize the chance these risks may occur while riding.
- In any place where wireless communication is prohibited, such as hospitals or airplanes, turn off the power. In a place where wireless communication is prohibited, electromagnetic waves may cause hazards or accidents.
- Before riding, fasten the product from the helmet, and double-check that it is properly fastened. Separation of the product while riding will cause damage to the product and may result in an accident.
- When you use the product while you operating any vehicle or equipment such as motorcycles, scooters, mopeds, ATVs, or quadbikes (hereinafter called "transportation means"), you need to follow the safety precautions provided by the manufacturer of the vehicle.
- When you use the product, use good judgment; never use it under the influence of alcohol or drugs or when you are extremely tired.

⚠ CAUTION

- If the product emits an unusual smell, feels hot, or appears abnormal in any other way while using or charging, stop using it immediately. It may cause damage, explosion, or fire. Contact your sales location if any of these problems are observed.
- Do not use the product in an explosive atmosphere. If you are in such a location, turn off the power and heed any regulations, instructions, and signs in the area.

NOTICE

- Attaching the product to the helmet is considered a modification to the helmet and may void your helmet's warranty or compromise your helmet's functionality. This may entail risks during an accident, so be fully aware of this fact before using the product. Should you not accept this fact, you may return the product for a full refund.
- In some regions, it is prohibited by law to ride motorcycles while wearing headsets or earbuds. Therefore be certain you are aware of all relevant laws in the region where you are using the product and are sure that you comply with them.
- The headset is for motorcycle helmets only. To install the headset, you must follow the installation instructions shown in the User's Guide.
- Do not impact the product with sharp tools as this may damage the product.
- Keep product away from pets or small children. They may damage the product.
- Any changes or modifications to the equipment not expressly approved by the party responsible for compliance could void the limited warranty to operate the equipment.
- High internal temperature may result in noisy photos. This is not a malfunction and does not affect your camera's overall performance.
- Check that the camera is operating properly in advance. Any file loss or camera damage caused by camera malfunction or improper use is not covered under warranty.

Battery

Your product has a built-in battery. Be careful to heed all safety information in this guide. Failure to carefully observe the safety precautions can cause battery heat generation, bursting, fire and serious personal injury.

⚠ WARNING

- Do not use the product in direct sunlight for a long period of time. Doing so can damage the product and generate heat that can cause burns.
- Do not use or store the product inside cars in hot weather. It may cause the battery to generate heat, rupture, or ignite.
- Do not continue charging the battery if it does not recharge within the specified charging time. Doing so may cause the battery to become hot, explode, or ignite.
- Do not leave the product near open flames. Do not dispose of the product in a fire. It may cause the battery to become hot, explode, or ignite and cause serious injury.
- Never attempt to charge a battery with the charger which has been physically damaged. It may cause explosion and/or accidents.

NOTICE

- Battery life may vary depending on conditions, environmental factors, functions of the product in use, and devices used with it.

Product Storage and Management

Take the following precautions to avoid personal injury or damage to your product while storing and maintaining the product.

⚠ CAUTION

- Do not dispose of the product with household waste. The built-in battery is not to be disposed of in municipal waste stream and requires separate collection. Disposal of the product should be done in accordance with the local regulations.

NOTICE

- Keep the product free of dust. Dust may damage mechanical and electronic parts of the product.
- The product should be stored at room temperature. Do not expose the product to extremely high or low temperature as this may reduce the life span of electronic devices, damage the battery, and/or melt plastic parts of the product.
- Do not clean the product with cleaning solvents, toxic chemicals, or strong detergents as this may damage the product.
- Do not paint the product. Paint may obstruct moving parts or interfere with the normal operation of the product.
- Do not drop or otherwise shock the product. It may damage the product or its internal electronic circuits.
- Do not disassemble, repair or modify the product as this may damage the product and invalidate the product warranty.
- Do not store the product in humid environments, especially for long periods of time. It may damage the internal electronic circuits.
- Battery performance will deteriorate over time if stored for a long period of time without being used.
- Do not store the camera in proximity to magnetic fields. Doing so may result in camera malfunction.
- Be careful to protect the lens by avoiding rough handling or physical shock.
- Wipe the surface of the lens with a soft cloth in the following situations:
 - (1) When there are fingerprints on the lens surface.
 - (2) When the lens is used in hot or humid environments, such as near oceans or rivers.
- Store the product in a well-ventilated room to protect the lens from dirt and dust.

1 PACKAGE CONTENTS

- **Headset Main Unit**



- **Clamp Unit**



- **Glued Surface Mounting Plate**



Speaker

- **Speakers**



- **Hook and Loop Fasteners for Speakers (4)**



- **Foam Speaker Covers (2)**



- **Speaker Pads (Thick) (2)**



- **Speaker Pads (Thin) (2)**



Attachable Boom Microphone

- **Attachable Boom Microphone**



- **Microphone Sponges (2)**



- **Hook and Loop Fastener for Attachable Boom Microphone**



- **Boom Microphone Holder**



- **Hook and Loop Fastener for Boom Microphone Holder**



Wired Microphone

- **Wired Microphone**



- **Hook and Loop Fastener for Wired Microphone**



Others

- **USB Power & Data Cable**



- **Allen Wrench**



- **Cigarette Charger**



- **Lens Cap**



2 INSTALLING THE HEADSET ON YOUR HELMET

2.1 Installing the Main Unit

2.1.1 Using the Clamp Unit

1. Loosen the two screws on the back plate of the clamp unit with the included allen wrench.
2. Insert the back plate of the clamp unit between the internal padding and external shell of the left side of the helmet.
3. Tighten the two screws until the clamp unit is fastened firmly to the helmet.
4. Insert a microSD card into the card slot to use camera.
5. Attach the main unit to the clamp unit until you hear a click.

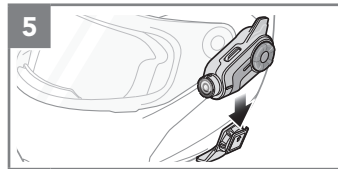
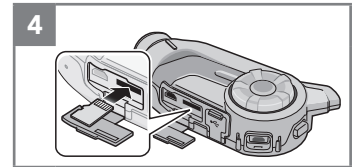
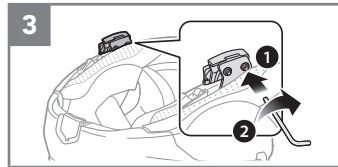
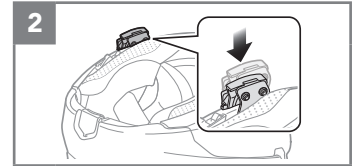
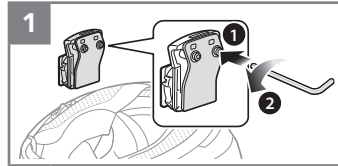

2.1.2 Using the Glued Surface Mounting Plate

If you cannot install the clamp unit on the helmet, you can use the glued surface mounting plate to attach the clamp unit to the surface of the helmet.

1. Attach adhesive tape of the glued surface mounting plate to the helmet.
2. Make sure that the glued surface mounting plate sticks on the helmet firmly. Maximum adhesion occurs after 24 hours.
3. Attach the main unit to the glued surface mounting plate until you hear a click.

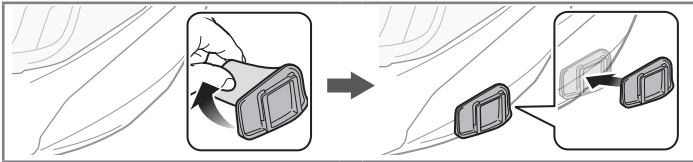

2.2 Installing the Speakers

1. Attach the hook and loop fasteners for speakers to ear pockets inside the helmet.
2. Attach the speakers to the hook and loop fasteners for speakers inside the helmet.

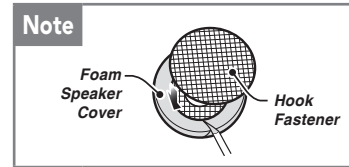
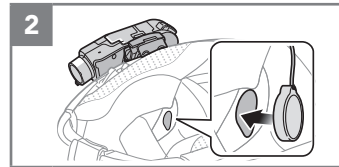
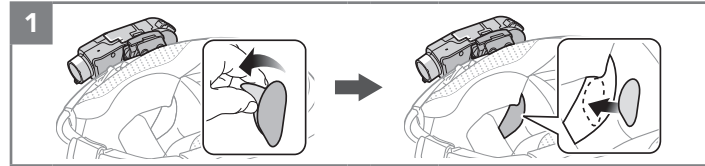

Note:

1. If the helmet has deep ear pockets, you can use the speaker pads to bring the speakers closer to your ears.
2. To enhance the audio quality, you can make use of the foam speaker covers. Cover each speaker with the foam and attach the hook fastener at the back of the speaker. Then place the speakers in the helmet as described above. Foam covered speakers work most effectively when they are slightly touching your ears.

2.3 Installing the Microphone

2.3.1 Using the Attachable Boom Microphone

1. Attach the hook and loop fastener for attachable boom microphone on the inside surface of the left external shell.
2. Attach the attachable boom microphone's mounting plate to the hook and loop fastener.
3. Adjust the head of the microphone so that the tab is facing away from your mouth.
4. Align the arrows on the microphone and speaker cables and insert the microphone cable into the speaker cable.
5. Insert the speaker connector into the speaker port to connect it to the main unit.
6. Close the cover of the speaker cable to lock the cable to the port.

Note:

You can use the boom microphone holder after attaching the hook and loop fastener for boom microphone holder on it to ensure secure installation.

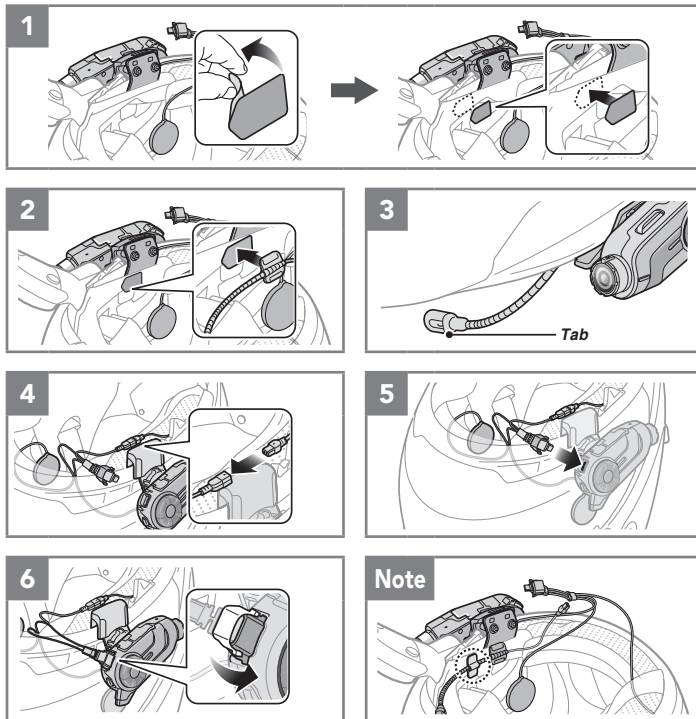

2.3.2 Using the Wired Microphone

If you have a full face helmet, you can use the wired microphone.

1. Attach the included hook and loop fastener for wired microphone to the inside of the helmet's chin guard.
2. Attach the wired microphone to the hook and loop fastener for wired microphone.
3. Align the arrows on the microphone and speaker cables and insert the microphone cable into the speaker cable.
4. Insert the speaker connector into the speaker port to connect it to the main unit.
5. Close the cover of the speaker cable to lock the cable to the port.

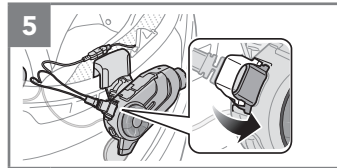
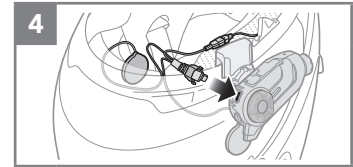
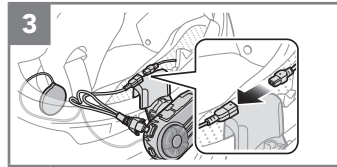
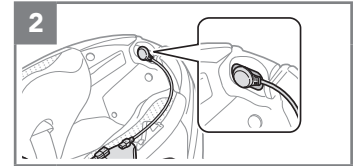
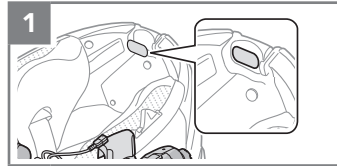

2.4 Adjusting the angle

You can adjust the angle for taking photos or recording videos.

1. You can rotate the vertical angle by 360°. Loosen the wheel next to the main unit and rotate the main unit to set the desired angle. Tighten the wheel to lock it into position.
2. You can rotate the horizontal angle by 30°. Open the cover of the lens and rotate the lens to set the desired angle. The red tip of the lens should be perpendicular to the ground.

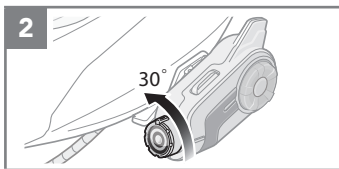
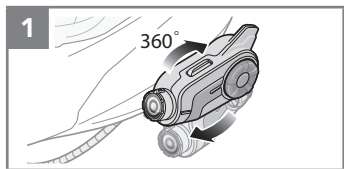

3 GETTING STARTED

3.1 Product Details

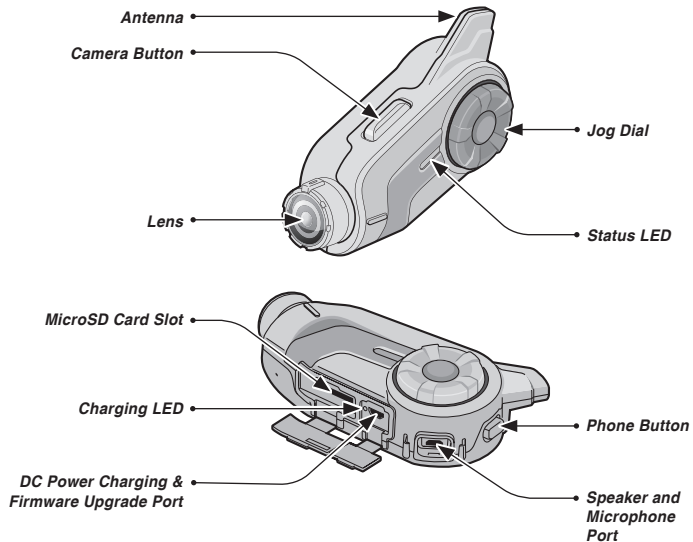

3.2 Powering On and Off

Press the Jog Dial and the Phone Button for 1 second to power on. Tap the Jog Dial and the Phone Button to power off.

3.3 Charging

The headset can be charged using many common methods via the supplied USB power & data cable. The LED turns red while the headset is charging and turns blue when it is fully charged. Depending upon the charging method, the headset will be fully charged in about 3.5 hours.

3.4 Checking the Battery Level

3.4.1 LED Indicator

When the headset is powering on, the red LED flashes rapidly indicating the battery level.

4 flashes = High, 70~100%

3 flashes = Medium, 30~70%

2 flashes = Low, 0~30%

3.4.2 Voice Prompt Indicator

When you power on the headset, keep pressing the Jog Dial and the Phone Button simultaneously for about 5 seconds until you hear high tone triple beeps. Then you will hear a voice prompt indicating the battery level is high, medium, or low.

3.5 Volume Adjustment

You can raise or lower the volume by rotating the Jog Dial. Volume is set and maintained independently at different levels for each audio source, even when the headset is rebooted.

3.6 Sena Softwares

3.6.1 Sena Device Manager

You can upgrade the headset's firmware and configure its settings directly from your PC or Apple computer. Download the Sena Device Manager, please visit sena.com.

3.6.2 Sena Smartphone App

You can configure its settings directly from your smartphone. Download the Sena Smartphone App for Android or Apple operating systems from sena.com.

3.6.3 Sena Camera App

You can see a live preview from the camera, manage recorded videos as well as configure the video settings using the built-in WiFi feature. When the camera and the Sena Camera App are connected, the camera is synchronized with the smartphone's date and time. Download the Sena Camera App for Android and Apple operating systems from sena.com.

Note:

- 1. When the camera is powered on, WiFi is automatically powered on and set to its default settings.*
- 2. WiFi will automatically be terminated if:*
 - You do not use WiFi on the product for 3 minutes.*
 - You do not use the Sena Camera App for 3 minutes.*
- 3. If you want to reactivate the WiFi after it is terminated, you will need to restart the camera.*

4 CAMERA OPERATION

4.1 Camera On or Off

To turn on the camera, tap the Camera Button. The camera turns off automatically after 5 minutes of inactivity. To turn off the camera manually, tap the Camera Button and the Phone Button simultaneously.

4.2 Camera Modes

Mode	Application	Button
Video	Record video (normal recording, timelapse, loop recording)	Press and hold the Camera Button for 1 sec
Photo	Capture a single photo (Single Shot)	Tap the Camera Button
Settings	Adjust camera settings	Press and hold the Camera Button for 5 secs

4.3 Video Recording

Press and hold the Camera Button for 1 second to start video recording. The green LED will flash and you will hear a voice prompt, “Recording”. Press and hold the Camera Button for 1 second to stop

recording. You will hear a voice prompt, “Recording stopped”.

Below is a table of approximate video recording times to microSD card size in specific resolutions and frame rates.

	1440p/30fps	1080p/60fps	1080p/30fps
1GB	4 min	4 min	9 min
2GB	8 min	8 min	18 min
4GB	16 min	16 min	36 min
8GB	33 min	33 min	1h 12 min
16GB	1 h 5 min	1 h 5 min	2 h 24 min
32GB	2 h 11 min	2 h 11 min	4 h 48 min
64GB	4 h 24 min	4 h 24 min	9 h 30 min

Note:

- MicroSD cards up to 64GB are compatible. Using a Class 10 microSD card is suggested. Your microSD card needs to be formatted using the camera.
- The camera gives a warning and automatically stops recording when the microSD card is full or the battery becomes low.
- The maximum size per video is limited to 4GB. Therefore, when the video reaches the 4GB size limit during recording, it saves and creates a new video to continue recording.

4.4 Video Mode (Default: Normal Recording Mode)

4.4.1 Timelapse Video Mode

Timelapse video records series of photos at timed intervals and makes it into a video.

4.4.2 Loop Recording Mode

Loop Recording mode continuously records videos to create footages of assigned length of time (3 minutes). If the memory reaches maximum, then the oldest footage will be deleted to store the most recent footage.

4.5 Photo Taking

To take a single photo, tap the Camera Button to take a photo. The green LED will flash and you will hear a shutter sound.

Note:

The camera resolution is fixed to 3.7MP with 16:9 aspect ratio. However, when you take a photo during video recording, the photo resolution is the same as the video resolution.

4.6 Video Tagging

Video Tagging allows the camera to record video continuously, but save only the important events.

It creates video files of past, present, and future with each footage having an assigned length of time (3 minutes).

1. When you encounter an event that is worth saving, press and hold the Camera Button for 3 seconds. You will hear a voice prompt, **“Video tagging”**.
2. When Video Tagging is completed, you will hear a voice prompt, **“Tagging complete”**.

Note:

- Video Tagging can be operated only in the Loop Recording mode.
- Video Tagging recorded files are stored in **TAGGING** folder.

5 PAIRING THE HEADSET WITH BLUETOOTH DEVICES

You can pair the headset with Bluetooth mobile phones, Bluetooth stereo devices such as MP3, SR10, or GPS, and with other Sena Bluetooth headsets. The pairing operation is required only once for each Bluetooth device. The headset can also be paired with up to three other Sena headsets.

5.1 Mobile Phone Pairing - Mobile Phone, Bluetooth Stereo Device

1. Press and hold the Phone Button for 5 seconds until the LED flashes red and blue alternately and you hear multiple beeps. You will hear a voice prompt, **“Phone pairing”**.
2. Search for Bluetooth devices on your mobile phone. Select the Sena 10C Pro in the list of the devices detected on the mobile phone.
3. If your mobile phone asks for a PIN, enter 0000.

5.2 Second Mobile Phone Pairing - Second Mobile Phone, GPS, and SR10

1. Press and hold the Jog Dial for 5 seconds until the red LED flashes rapidly and you hear a voice prompt, **“Intercom pairing”**.
2. Within 2 seconds, tap the Phone Button again, then the LED flashes blue rapidly and you will hear a voice prompt, **“Second mobile phone pairing”**.
3. Search for Bluetooth devices on your mobile phone. Select the Sena 10C Pro in the list of the devices detected on the mobile phone.
4. If your mobile phone asks for a PIN, enter 0000.

Note:

- 1. If you have two audio (A2DP) devices connected to your headset then the audio from one device will interrupt the audio from the other device. For example, if you are playing music from the primary mobile phone, then it can be interrupted by playing music from the secondary mobile phone and vice versa.*
- 2. You have to use a motorcycle specific GPS, which transmits turn-by-turn voice instructions to the headset by Bluetooth.*
- 3. The Sena SR10 is a Bluetooth two-way radio adapter for group communication, and uses Hands-Free-Profile. The incoming audio from the two-way radio via SR10 is heard in the background while having an intercom conversation or a mobile phone call.*
- 4. The GPS navigation or a radar detector could be connected to the SR10 by wire. The GPS voice instruction or the radar detector alarm is also heard in the background via SR10 while having an intercom conversation or a phone call. Please refer to the SR10 User's Guide for details.*

5.3 Advanced Selective Pairing: A2DP Stereo or Handsfree

Phone Pairing allows the headset to establish two Bluetooth profiles: Hands-Free or A2DP Stereo. Advanced Selective Pairing allows the headset to separate the profiles to enable connection with two devices.

5.3.1 A2DP Stereo Music Only

1. Press the Phone Button for 5 seconds until the LED flashes red and blue alternately and you hear multiple beeps.
2. Within 2 seconds, tap the Jog Dial again, then the LED flashes red and you hear **“Media selective pairing”**.
3. Search for Bluetooth devices on your smartphone. Select the Sena 10C Pro in the list of devices detected on your phone.
4. If your mobile phone asks for a PIN, enter 0000.

5.3.2 HFP for Phone Call Only

1. Press the Phone Button for 5 seconds until the LED flashes red and blue alternately and you hear multiple beeps.
2. Within 2 seconds, tap the Phone Button again, then the LED flashes blue and you hear “**Phone selective pairing**”.
3. Search for Bluetooth devices on your smartphone. Select the Sena 10C Pro in the list of devices detected on your phone.
4. If your mobile phone asks for a PIN, enter 0000.

5.4 Intercom Pairing

5.4.1 Pairing with Other Headsets for Intercom Conversation

The headset can be paired with up to three other headsets for Bluetooth intercom conversation.

1. Press and hold the Jog Dial of the **headset A and B** for 5 seconds until red LEDs of the both units start to flash rapidly.
2. Simply tap the Jog Dial of any one of the two **headsets A and B**, and wait until the LEDs of both headsets turn to blue and intercom connection is automatically established.
3. You can make other pairings between **headsets A and C**, and between **headsets A and D** by following the same procedure as above.
4. The intercom pairing queue is ‘**Last-Come, First-Served**’. If a headset has multiple paired headsets for intercom conversations, the last paired headset is set as **first intercom friend**. The previous intercom friend becomes **second intercom friend**, and **third intercom friend**.

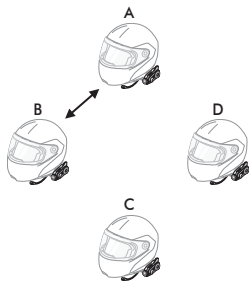
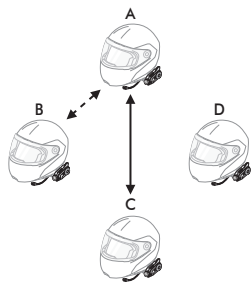
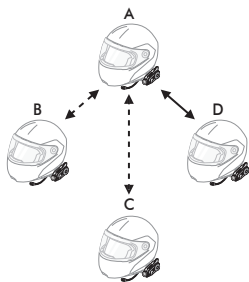
**Pairing A & B****Pairing A & C****Pairing A & D**

6 MOBILE PHONE, GPS

6.1 Mobile Phone Call Making and Answering

1. To answer a call, tap the Phone Button or the Jog Dial to answer the call.
2. You can also answer the incoming call by loudly speaking any word of your choice if VOX Phone is enabled, unless you are connected to intercom.
3. To end a call, tap the Phone Button or press the Jog Dial for 2 seconds until you hear a beep.
4. To reject a call, press the Jog Dial for 2 seconds until you hear a beep while the phone is ringing.
5. To transfer a call between the mobile phone and the headset during the phone conversation, press the Phone Button for 2 seconds until you hear a beep.
6. To make a call with voice dialer, Tap the Phone Button in stand-by mode to activate the voice dialer of your mobile phone.

Note:

If you have a mobile phone and a GPS connected to your headset, you may not be able to listen to the GPS voice instruction during the phone call.

6.2 Speed Dialing

1. Double tap the Phone Button and you will hear a mid-tone single beep and a voice prompt, “**Speed dial**”.
2. Rotate the Jog Dial clockwise or counter clockwise to navigate between the menus. You will hear prompts for each menu item.
3. Tap the Phone Button to select a voice menu among the followings:

(1) Last number redial	(4) Speed dial 3
(2) Speed dial 1	(5) Cancel
(3) Speed dial 2	
4. After selecting the last number redial menu, “**Last number redial**”. Then, to redial the last phone call number, tap the Phone Button.
5. To call one of the speed dials, rotate the Jog Dial clockwise or counter clockwise to navigate between the menus until you hear a voice prompt, “**Speed dial (#)**”. Then, tap the Phone Button.
6. If you want to exit the speed dial immediately, rotate the Jog Dial until you hear a voice prompt, “**Cancel**”, and tap the Phone Button or the Jog Dial.

6.3 GPS Navigation

6.3.1 GPS Pairing

1. Press and hold the Jog Dial for 5 seconds until you will hear a voice prompt saying “**Intercom pairing**”.
2. Within 2 seconds, double tap the Phone Button and you will hear the voice prompt saying “**GPS pairing**”.
3. Search for Bluetooth devices on the GPS navigation. Select the Sena 10C Pro in the list of the devices detected on the GPS.
4. Enter 0000 for the PIN.

Note:

When Audio Multitasking is enabled, if you pair your GPS device via GPS Pairing, its instructions will not interrupt your intercom conversations, but will overlay with them.

7 STEREO MUSIC

7.1 Bluetooth Stereo Music

1. To play or pause music, press and hold the Jog Dial for 1 second until you hear a double beep.
2. To adjust the volume, rotate the Jog Dial.
3. To track forward or track back, rotate while pressing the Jog Dial clockwise or counter clockwise.

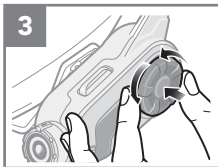
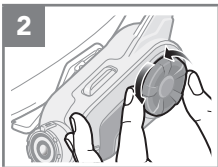
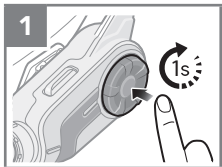

7.2 Music Sharing

You can start sharing music with an intercom friend using Bluetooth stereo music during a two-way intercom conversation. When you terminate music sharing, you can go back to the intercom conversation. To start or terminate sharing music, press and hold the Jog Dial for 1 second during an intercom conversation until you hear a double beep.

Note:

1. Both you and your intercom friend can remotely control music playback such as track forward and track back.
2. Music sharing will be paused when you are using your mobile phone or listening to GPS instructions.
3. When Audio Multitasking is enabled, if an intercom call is made when you are listening to music, music sharing will not work.

8 INTERCOM

8.1 Two-way Intercom

8.1.1 Starting Two-way Intercom

You can start an intercom conversation with one of any intercom friends by tapping the Jog Dial: single tap to intercom with the **first intercom friend**, double tap to intercom with the **second intercom friend**, and triple tap to intercom with the **third intercom friend**.

8.1.2 Ending Two-way Intercom

Press and hold the Jog Dial for 1 second to end any intercom. Or, you can single tap to end intercom with the **first intercom friend**, double tap to end intercom with the **second intercom friend**, and triple tap to end intercom with the **third intercom friend**.



8.2 Multi-Way Intercom

Multi-Way Intercom enables conference-call-style conversations with up to three intercom friends at the same time. While multi-way intercom is in progress, mobile phone connection is temporarily disconnected. However, as soon as multi-way intercom terminates, the mobile phone connection will be reestablished.

8.2.1 Starting Three-way Intercom

1. You (A) need to be paired with two other friends (B & C) for three way conference intercom.
2. Start an intercom conversation with one of the two friends in your intercom group.
3. You (A) can call the second intercom friend (C) by double tapping the Jog Dial, or the second intercom friend (C) may join the intercom by making an intercom call to you (A).

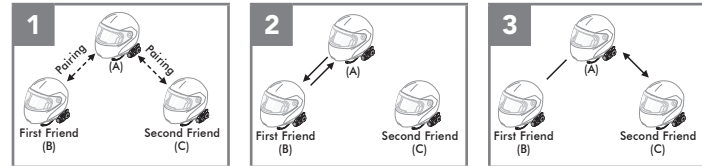

8.2.2 Starting Four-way Intercom

With three intercom friends connected, a new participant (D) can make it a four-way intercom conference by making an intercom call to either (B) or (C).

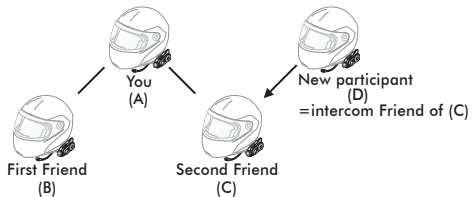

8.2.3 Ending Multi-Way Intercom

You can completely terminate the conference intercom or just disconnect an intercom connection with one of your active intercom friends.

1. Press and hold the Jog Dial for 3 seconds until you hear a beep to terminate all intercom connections.
2. Tap the Jog Dial to disconnect from your first intercom friend. Double tap the Jog Dial to disconnect from your second intercom friend.

Note:

Multiple headsets are connected during multi-way intercom. With various signals interfering each other, the intercom distance of multi-way intercom is relatively shorter than that of two-way intercom.

9 THREE-WAY CONFERENCE PHONE CALL WITH INTERCOM PARTICIPANT

You can have a three-way conference phone call by adding an intercom friend to the mobile phone conversation.

1. During a mobile phone call, tap the Jog Dial to invite one of your intercom friends to the conversation.
2. To disconnect the intercom during a conference phone call, tap the Jog Dial.
3. To disconnect the mobile phone call during a conference phone call, press the Jog Dial for 2 seconds or tap the Phone Button.

10 GROUP INTERCOM

Group Intercom allows you to instantly create a multi-way conference intercom with three other most recently paired headsets.

1. Go through intercom pairing with up to three headsets you want to have Group Intercom with.
2. Press the Jog Dial for 3 seconds to begin Group Intercom. The LED will flash green.
3. To terminate Group Intercom, press the Jog Dial for 3 seconds during Group Intercom.

11 UNIVERSAL INTERCOM

Universal Intercom allows you to have intercom conversations with users of non-Sena Bluetooth headsets. You can pair the headset with only one non-Sena headset at a time. The intercom distance depends on the performance of the Bluetooth headset to which it's connected. When a non-Sena Bluetooth headset is paired with the headset, if another Bluetooth device is paired via Second Mobile Phone Pairing, it will be disconnected.

1. Press and hold the Jog Dial for 10 seconds to enter the headset configuration menu. Rotate the Jog Dial until you hear a voice prompt, **“Universal intercom pairing”**. Tap the Phone Button to enter into Universal Intercom Pairing mode and you will hear multiple beeps.
2. Put the non-Sena Bluetooth headset in Pairing Mode. The headset will automatically pair with a non-Sena Bluetooth headset.
3. You can have a two-way intercom or multi-way intercom communication with up to three intercom friends using non-Sena headset.

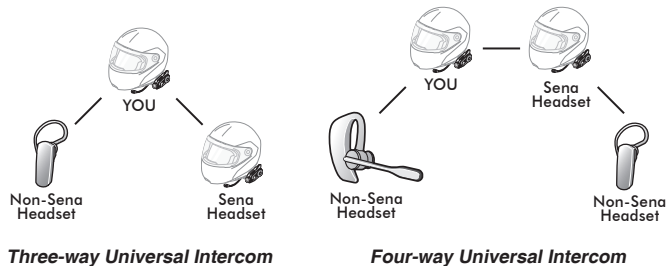

12 FM RADIO

12.1 FM Radio On/Off

To turn on or off the FM radio, press and hold the Phone Button for 1 seconds until you hear a mid-toned double beep sound.

12.2 Preset Stations

You can listen to preset stations while listening to the FM radio. Tap the Phone Button once to go upward to your next saved preset station.

12.3 Seek and Save

1. Rotate while pressing the Jog Dial clockwise or counter clockwise.
2. To save the current station, press and hold the Jog Dial for 1 second until you hear a voice prompt, “**Preset (#)**”.
3. Rotate the Jog Dial clockwise or counter clockwise, in order to select which preset number you want for that specific station. (You can save up to 10 preset stations.)

4. To save the current station, tap the Jog Dial again. You will then hear a voice prompt, “**Save preset (#)**”.
5. To delete the saved station in the preset number, tap the Phone Button. You will then hear a voice prompt “**Delete preset (#)**”.

12.4 Scan and Save

1. Double tap the Phone Button.
2. The Sena tuner pauses at each station it finds for 8 seconds before moving to the next.
3. To save a station while scanning frequencies, tap the Phone Button when at that station. You will hear a voice prompt, “**Save preset (#)**”. The station will be saved as the next preset number.

12.5 Temporary Preset

The temporary station preset feature automatically finds and saves the nearest 10 radio stations without changing your existing preset stations.

1. Tap the Phone Button 3 times to automatically scan for 10 temporary preset stations.
2. The temporary preset stations will be cleared when the headset is powered off.

12.6 FM Sharing

You can listen to the radio during the intercom conversation. To start FM sharing, press and hold the Phone Button for 1 second during the intercom conversation. During FM sharing, you can move to the next preset station and you or your friend on the intercom can change frequencies. If either person changes the frequency, the other will listen to the same frequency. To terminate FM sharing, press and hold the Phone Button for 1 second or end the intercom call.

Note:

1. FM sharing will be terminated if the headset starts a multi-way intercom conference.
2. When Audio Multitasking is enabled, if an intercom call is made while you are listening to the FM radio, FM sharing will not work.
3. FM sharing is only supported between Sena headsets that currently support this feature.

12.7 Region Selection

You can select the proper FM frequency region from the Sena Device Manager. With the region setting, you may optimize the seek function to avoid unnecessary frequency ranges.

Region	Frequency Range	Step
Worldwide	76.0 ~ 108.0 MHz	± 100 kHz
Americas	87.5 ~ 107.9 MHz	± 200 kHz
Asia	87.5 ~ 108.0 MHz	± 100 kHz
Australia	87.5 ~ 107.9 MHz	± 200 kHz
Europe	87.5 ~ 108.0 MHz	± 100 kHz
Japan	76.0 ~ 95.0 MHz	± 100 kHz

13 FUNCTION PRIORITY

The headset operates in the following order of priority:

- (highest)** Mobile phone
Intercom/FM sharing
Music sharing by Bluetooth stereo music
Bluetooth stereo music
- (lowest)** FM radio

A lower priority function is always interrupted by a higher priority function.

Note:

If you select music as the audio source priority, the order of priority will change as below:

- (highest)** Mobile phone
Bluetooth stereo music
Intercom/FM sharing
Music sharing by Bluetooth stereo music
- (lowest)** FM radio

14 CONFIGURATION SETTING

14.1 Headset Configuration Setting

- To enter into configuration menu, press and hold the Jog Dial for 10 seconds until you will also hear a voice prompt, “**Configuration menu**”.
- Rotate the Jog Dial clockwise or counter clockwise to navigate between the menus. You will hear voice prompts for each menu item.
- You can execute the command by tapping the Phone Button.

Configuration Menu	Tap Phone Button
Delete All Pairings	Execute
Remote Control Pairing	Execute
Universal Intercom Pairing	Execute
Exit Configuration	Execute

14.1.1 Remote Control Pairing

You can remotely control the headset using Sena Remote Control devices (sold separately).

1. Turn on the headset and the Remote Control device.
2. Execute Remote Control Pairing.
3. Enter pairing mode in the Remote Control device. The headset will automatically connect with the Remote Control device in pairing mode.

14.2 Software Configuration Setting

You can change the settings of the headset through the Sena Device Manager or the Sena Smartphone App.

14.2.1 Speed Dial

Assign phone numbers for speed dialing to make a phone call quickly.

14.2.2 Audio Source Priority (Default: Intercom)

Audio Source Priority allows you to select the priority between the intercom and music (which includes GPS app instructions and message notifications) from a smartphone. If the intercom is selected as the audio source priority, your music will be interrupted during an intercom conversation. If music is selected as the audio source priority, intercom conversations will be interrupted while your music is heard.

Note:

Audio Source Priority is active only when Audio Multitasking is disabled.

14.2.3 Audio Boost (Default: Disable)

Enabling Audio Boost increases the overall maximum volume. Disabling Audio Boost reduces the overall maximum volume, but delivers more balanced sound.

14.2.4 VOX Phone (Default: Enable)

If this feature is enabled, you can answer incoming calls by voice. When you hear a ringtone for an incoming call, you can answer the phone by saying a word such as **“Hello”** loudly or by blowing air into the microphone. VOX phone is temporarily disabled if you are connected to intercom. If this feature is disabled, you have to tap the Phone Button to answer an incoming call.

14.2.5 VOX Intercom (Default: Disable)

If this feature is enabled, you can initiate an intercom conversation with the last connected intercom friend by voice. When you want to start intercom, say a word such as **“Hello”** loudly or blow air into the microphone. If you start an intercom conversation by voice, the intercom terminates automatically when you and your intercom friend remain silent for 20 seconds. However, if you manually start an intercom conversation by tapping the Jog Dial, you have to terminate the intercom conversation manually. However, if you start intercom by voice and end it manually by tapping the Jog Dial, you will not be able to start intercom by voice temporarily. In this case, you have to tap the Jog Dial to restart the intercom. This is to prevent repeated unintentional intercom connections by strong wind noise. After rebooting the headset, you can start intercom by voice again.

14.2.6 HD Voice (Default: Disable)

HD Voice allows you to communicate in high-definition during phone calls. This feature increases the quality so that the audio will be crisp and clear during phone call conversations.

If this feature is enabled, incoming phone calls will interrupt intercom conversations and audio from the SR10 will not be heard during intercom conversations. Three-Way Conference Phone Call with Intercom Participant will not be available if HD Voice is enabled.

Note:

1. Refer to the manufacturer of your Bluetooth device that will be connected to the headset to see if it supports HD Voice.
2. HD Voice is active only when Audio Multitasking is disabled.

14.2.7 HD Intercom (Default: Enable)

HD Intercom enhances the two-way intercom audio from normal quality to HD quality. HD Intercom will become temporarily disabled when you enter into a multi-way intercom. If this feature is disabled, the two-way intercom audio will change to normal quality.

Note:

- 1. The intercom distance of HD Intercom is relatively shorter than that of normal intercom.*
- 2. HD intercom is active only when Audio Multitasking is disabled.*

14.2.8 Voice Prompts (Default: Enable)

You can disable voice prompts by software configuration setting, but the following voice prompts are always on.

- Headset configuration setting menu, battery level indicator, speed dial, FM radio functions

14.2.9 RDS AF Setting (Default: Disable)

Radio Data System (RDS) Alternative Frequency (AF) Setting allows a receiver to re-tune to the second frequency location when the first signal becomes too weak. With RDS AF enabled on the receiver, a radio station with more than one frequency can be used.

14.2.10 FM Station Guide (Default: Enable)

When FM Station Guide is enabled, FM station frequencies are given by voice prompts as you select preset stations. When FM Station Guide is disabled, the voice prompts on FM station frequencies will not be given as you select preset stations.

14.2.11 Sidetone (Default: Disable)

Sidetone is audible feedback of your own voice. It helps you to naturally speak at the correct level according to varying helmet noise conditions. If this feature is enabled, you can hear what you are speaking during an intercom conversation or a phone call.

14.2.12 Advanced Noise Control™ (Default: Enable)

When Advanced Noise Control is enabled, the background noise is reduced during an intercom conversation. When it is disabled, the background noise is mixed with your voice during intercom.

14.2.13 Audio Multitasking™ (Default: Disable)

Audio Multitasking allows you to hear the audio from two features simultaneously. When Audio Multitasking is enabled, phone calls, GPS instructions and intercom conversations can be overlaid with audio from the FM radio, music or GPS app instructions from a smartphone in the background with reduced volume. Increasing or decreasing the volume of the audio in the foreground will also increase or decrease the volume of the overlaid audio in the background. The volume of the foreground audio can be adjusted using the headset. How much background audio that is heard can be adjusted using the SENA Smartphone App. HD Intercom, HD Voice and Audio Source Priority become disabled temporarily when Audio Multitasking is enabled.

Model	Foreground*			Background**	
	Phone	GPS	Intercom	FM Radio	Music or Smart Navi
10C Pro	○ ^A	○ ^A			
		○	○		
			○ ^B	○	○ ^B
		○ ^C		○ ^C	○

Foreground and Background Combination Table

* Two audio sources in the foreground can be heard simultaneously with the same volume level.

** Only one background source can be heard at a time while listening to an audio source in the foreground.

- A. GPS instructions can be heard during phone calls and the volume level of both audio sources can be adjusted using the headset.
- B. GPS app directions will be heard in the background during intercom conversations.
- C. The FM radio will be heard in the background when GPS instructions are heard.

Note:

1. Audio Multitasking will be activated during two-way intercom conversations with a headset that also supports this feature.
2. When Audio Multitasking is disabled, the background audio source will return to its independent volume level.
3. For Audio Multitasking to work properly, you need to power the headset off and on. Please restart the headset.
4. Some GPS devices may not support this feature.

14.2.14 Background Volume (Default: Level 5)

The Background Volume can be adjustable only when the Audio Multitasking turns on. Level 9 is the highest volume and 0 is the lowest.

14.3 Camera Configuration Setting

1. To enter into camera configuration menu, press and hold the Camera Button for 5 seconds until you hear a voice prompt, “**Camera setup**”.
2. Rotate the Jog Dial clockwise or counter clockwise to navigate between the menus. You will hear voice prompts for each menu item as below.
3. You can enable or disable a feature, or execute a command by tapping the Phone Button.

Configuration Menu	Tap Phone Button
Video Mode Setting	Normal Recording Mode
	Timelapse Mode
	Loop Recording Mode
Video Resolution Setting	1080p/30fps
	1080p/60fps
	1440p/30fps
Timelapse Interval Setting	Per 1 second
	Per 10 seconds

Configuration Menu	Tap Phone Button
Video Microphone Gain Setting	Low
	Medium
	High
Date Caption	On
	Off
Speaker Sound Recording	On
	Off
Auto Camera Sleep	On
	Off
Format SD Card	Execute

14.3.1 Video Mode (Default: Normal Recording Mode)

You can select the video mode to be normal recording mode, timelapse mode, or loop recording mode. Timelapse mode records series of photos at timed intervals and makes it into a video. Loop recording mode constantly records videos at timed intervals, replacing old video files when memory is full.

14.3.2 Video Resolution (Default: 1080p/30fps)

You can select the video resolution to be 1440p/30fps, 1080p/60fps, or 1080p/30fps.

14.3.3 Timelapse Interval (Default: 1 sec)

You can select the timelapse interval to be either 1 second or 10 seconds.

14.3.4 Video Microphone Gain (Default: Medium)

You can select the microphone gain for video recording to be low, medium, or high.

14.3.5 Date Caption (Default: Off)

You can record or hide date caption during video recording. If you select on, the date caption will be displayed on top of your recorded video. If you select off, the date caption will not be shown on your recorded video.

14.3.6 Smart Audio Mix™ (Default: On)

Smart Audio Mix allows you to record everything you hear through your speakers as well as your voice during video recording. The function that governs **Smart Audio Mix** is called **Speaker Sound Recording**. Turn on the Speaker Sound Recording setting if you want to record music and intercom conversations on your video. Turn off this setting if you want to record your voice only.

14.3.7 Auto Camera Sleep (Default: On)

You can set the camera to automatically power off after 5 minutes of inactivity. This feature does not work while charging the camera.

14.3.8 Format SD Card

SD card format will remove all files from a microSD card. When you use a new card for the first time, always format it before using the camera.

15 FIRMWARE UPGRADE

The headset supports firmware upgrades. You can update the firmware using the Sena Device Manager.

16 TROUBLESHOOTING

16.1 Fault Reset

When the headset is not working properly, you can easily reset the unit:

1. Locate the pinhole reset button at the back of the headset main unit.
2. Gently insert a paperclip into the hole and tap the Fault Reset Button with light pressure.

3. The headset will shut down.

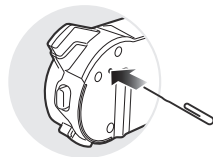

Note:

Fault Reset will not restore the headset to factory default settings.

16.2 Factory Reset

1. To restore the headset to factory default settings, press and hold the Phone Button for 10 seconds until the LED shows solid red and you hear **“Factory reset”**.
2. Within 10 seconds, press the Jog Dial to confirm reset. The headset will be restored to factory setting and switched off automatically. You will hear **“Headset reset, good-bye”**.