



## Installation Instructions: S&S Stealth Air Cleaner Kit for Harley-Davidson<sup>®</sup> Models with Milwaukee Eight<sup>®</sup> Engines

### DISCLAIMER:

Many S&S parts are designed for high performance, closed course, racing applications and are intended for the very experienced rider only. The installation of S&S parts may void or adversely affect your factory warranty. In addition such installation and use may violate certain federal, state, and local laws, rules and ordinances as well as other laws when used on motor vehicles used on public highways. Always check federal, state, and local laws before modifying your motorcycle. It is the sole and exclusive responsibility of the user to determine the suitability of the product for his or her use, and the user shall assume all legal, personal injury risk and liability and all other obligations, duties, and risks associated therewith.

Exempt from emissions tampering regulations on 2017-2018 touring models and 2018 Softail<sup>®</sup> models under CARB EO# D-355-24

### IMPORTANT NOTICE:

Statements in this instruction sheet preceded by the following words are of special significance.



#### WARNING

Means there is the possibility of injury to yourself or others.



#### CAUTION

Means there is the possibility of damage to the part or motorcycle.

#### NOTE

*Other information of particular importance has been placed in italic type.*

*S&S recommends you take special notice of these items.*

### SAFE INSTALLATION AND OPERATION RULES:

Before installing your new S&S part, it is your responsibility to read and follow the installation and maintenance procedures in these instructions and follow the basic rules below for your personal safety.

- Gasoline is extremely flammable and explosive under certain conditions and toxic when breathed. Do not smoke. Perform installation in a well ventilated area away from open flames or sparks.
- If motorcycle has been running, wait until engine and exhaust pipes have cooled down to avoid getting burned before performing any installation steps.
- Before performing any installation steps, disconnect battery to eliminate potential sparks and inadvertent engagement of starter while working on electrical components.
- Read instructions thoroughly and carefully so all procedures are completely understood before performing any installation steps. Contact S&S with any questions you may have if any steps are unclear or any abnormalities occur during installation or operation of motorcycle with an S&S part on it.
- Consult an appropriate service manual for your motorcycle for correct disassembly and reassembly procedures for any parts that need to be removed to facilitate installation.
- Use good judgment when performing installation and operating motorcycle. Good judgment begins with a clear head. Don't let alcohol, drugs or fatigue impair your judgment. Start installation when you are fresh.
- Be sure all federal, state and local laws are obeyed with the installation.
- For optimum performance and safety and to minimize potential damage to carb or other components, use all mounting hardware that is provided and follow all installation instructions.
- Motorcycle exhaust fumes are toxic and poisonous and must not be breathed. Run motorcycle in a well ventilated area where fumes can dissipate.

**Kit Contents:**

- Backplate
- Wiring cover
- Filter
- Filter Top Plate
- 243 Blue Loctite
- QTY of 3 - 1/4" X 20 Backplate Screws
- QTY of 2 - 3/8" X 16 Breather Bolts
- QTY of 2 - 1/4" X 20 Flanged Button Head Screws
- QTY of 8 – Rubber Coated Washers
- Electrical Plug Cover Kit
- Cover Screw
- Backplate O-Ring
- CARB EO# Label

**WARNING**

- The safety of the motorcycle rider is dependent of proper installation of this product. If you are not certain of your capabilities or do not have the correct tools for this installation, please consult a shop to have it done. Improper installation of this product could result in injury or death to the rider.
- Be sure to disconnect the battery of your motorcycle before starting on this procedure. Accidental starting of the motorcycle could cause injury to you or others around you during the installation.

**Disassembly**

**Stock Air Cleaner Removal**

1. Disconnect the negative battery cable from the motorcycle and route it away from any metal parts in the area.
2. Remove the stock air cleaner cover and backplate assembly following your service manual for the specific year and model bike you are working on.
3. If equipped, remove the throttle body support bracket and plastic wiring harness retaining clip. **Picture 1** illustrates the bracket and clip.

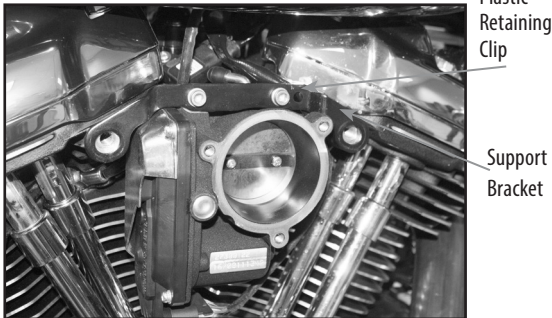

**Picture 1**

**Installation**

**Installing the S&S Stealth AC Kit**

1. Hold the electrical plug cover on the back side of the air cleaner backplate with one hole over the locating boss. Fasten with the #10-14 x .375" self-tapping screw provided, in the other hole. As shown in **Picture 2**



**Picture 2**

2. Locate the three back plate screws. See **Picture 3**.



**Picture 3**

3. Install the three screws in the backplate as illustrated in **Picture 4**.

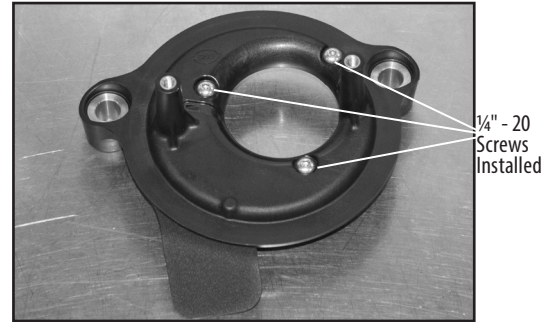

**Picture 4**

**NOTE:** The screws will thread in with some resistance due to the slight interference fit of the threads in backplate.

4. Install the supplied o-ring in groove as illustrated in **Picture 5**. A small dab of grease makes it easier to keep the o-ring in place during installation.

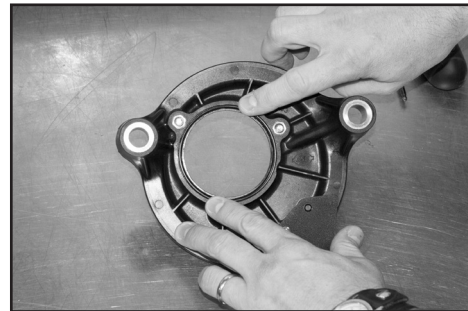

**Picture 5**

5. Locate the two 3/8"-16 breather bolts and the eight rubber coated washers. Put one washer on each breather bolt and pass through the backplate mounting holes. Install another rubber coated washer onto each breather bolt. As illustrated in **Picture 6**.

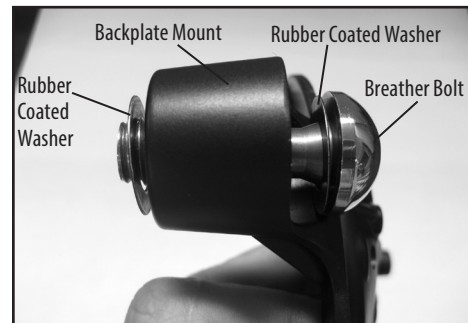

**Picture 6**

- Apply a drop of 243 blue Loctite® to the threads of each screw and breather bolt. **Picture 7** illustrates all five fasteners that require 243 blue Loctite.

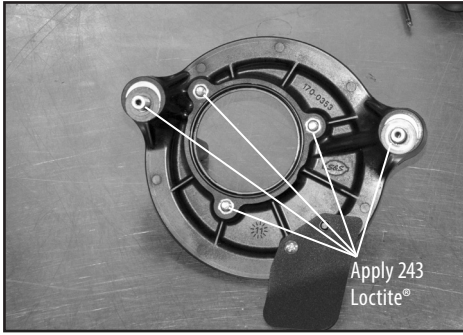

**Picture 7**

- Fit the backplate to the throttle body and the cylinder heads. Start the threads of all the screws and tighten evenly until the backplate is snug.
- Now that the backplate is positioned, finish torque the ¼"-20 fasteners to 72 in.-lbs. as illustrated in **Picture 8**.



**Picture 8**

- Check between the cylinder head and the backplate for air gaps.

**NOTE:** A feeler gauge works well for determining the amount of gap, if any, between the head and the backplate as illustrated in **Picture 9**.



**Picture 9**

- If a gap less than the thickness of a rubber coated washer is present, torque the breather bolts down 10-12 ft.-lbs. If a gap of more than the thickness of a rubber coated washer is present, determine how much and select the appropriate number of rubber coated washers needed to take up the gap.
- If more than one rubber coated washer is needed between the head and backplate, back out the breather bolts and install the correct number of rubber coated washers.
- Thread the breather bolts in and finish torque breather bolts to 10-12 ft.-lbs.
- Locate the filter, plastic filter top plate and the two ¼"-20 flanged head fasteners as illustrated in **Picture 10**.

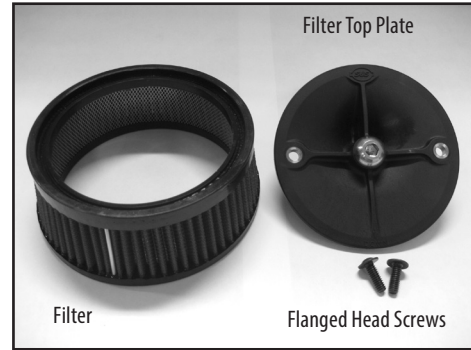

**Picture 10**

- Apply a drop of 243 blue Loctite® to the threads of each ¼"-20 flanged head screw and set aside.
- Hold the filter on the backplate and put the filter top plate on top of the filter making sure that the word "Down" is facing down and sitting flat on the filter and locked into the groove as illustrated in **Picture 11**.

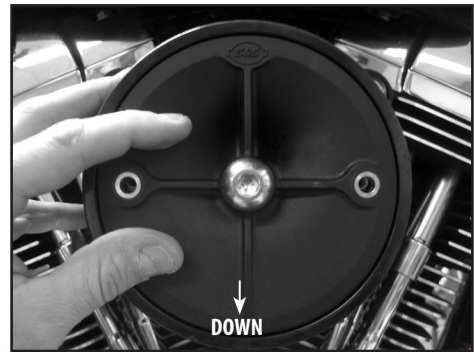

**Picture 11**

- Pass the ¼"-20 flanged head screws through the plastic top filter plate, thread in and tighten down evenly until snug and then finish torque to 72 in.-lbs. as illustrated in **Picture 12**.

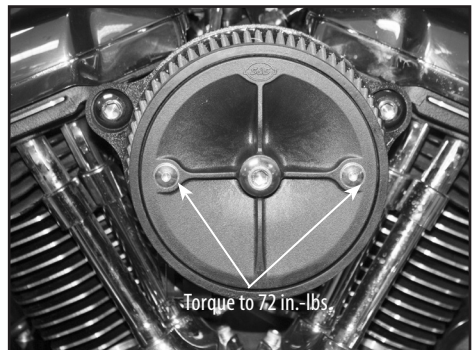

**Picture 12**

17. Remove the 5/16" button head screw from the plastic top filter plate.

Picture 13 illustrates the button head screw.



Picture 13

18. Attach an S&S air cleaner cover to the stealth air cleaner kit, and fasten in place the 5/16" button head screw with 243 blue Loctite applied to the threads. Torque to 10ft.-lbs. A stock Harley-Davidson® Milwaukee Eight® 2017-2018 Touring air cleaner cover may also be installed, but Adaptor Kit #170-0352 is required for this installation.



Picture 14 shows a Stealth kit with a stock cover

19. Apply the included label containing the CARB EO number to the frame down tube above or below the factory label. Do not cover up any portion of the factory label. See Picture 15



Picture 15

**S&S Stealth Air Cleaner Kit for HD® Models with Milwaukee Eight® Engines**

- 1. Screw, SHCB, 5/16-18 x .500", Polished, Stainless Steel .....500-0051
- 2. Screw, SHC, Flanged Button, 1/4-20 UNC x .750" (Each) .....500-0060
- 3. Plate, Top, Air Filter, Molded, Plastic.....170-0026
- 4. Filter, Air, Tapered, Standard Pleated,  
5.500" x 6.000" x 2.375", Cotton.....170-0126
- 5. Screw, SHCB, 1/4-20 UNC X .825" (Each) 3 required .....500-0059
- 6. Backplate, Air Cleaner, Throttle-by-Wire, Stock Bore, Black,  
Die Cast, M8 .....170-0353
- 7. Screw, Backplate Vent, SHCB, 3/8-16 x 1-1/2",  
Polished,Stainless Steel (Each) 2 required.....170-0045
- 8. Washer, Flat,.380" x .880" x .024", Nitrile Rubber Coated,  
Cold Rolled Steel (Each) 8 required.....50-7054
- 9. O-ring, 2.75" ID x 2.875 OD, X 1 /16" Buna, (-039).....50-8207-S
- 10. Cover,Electrical Plug,Throttle by Wire,Aluminum.....170-0355
- 11. Screw,#10-14 x .375" Long,Plastite .....500-0568

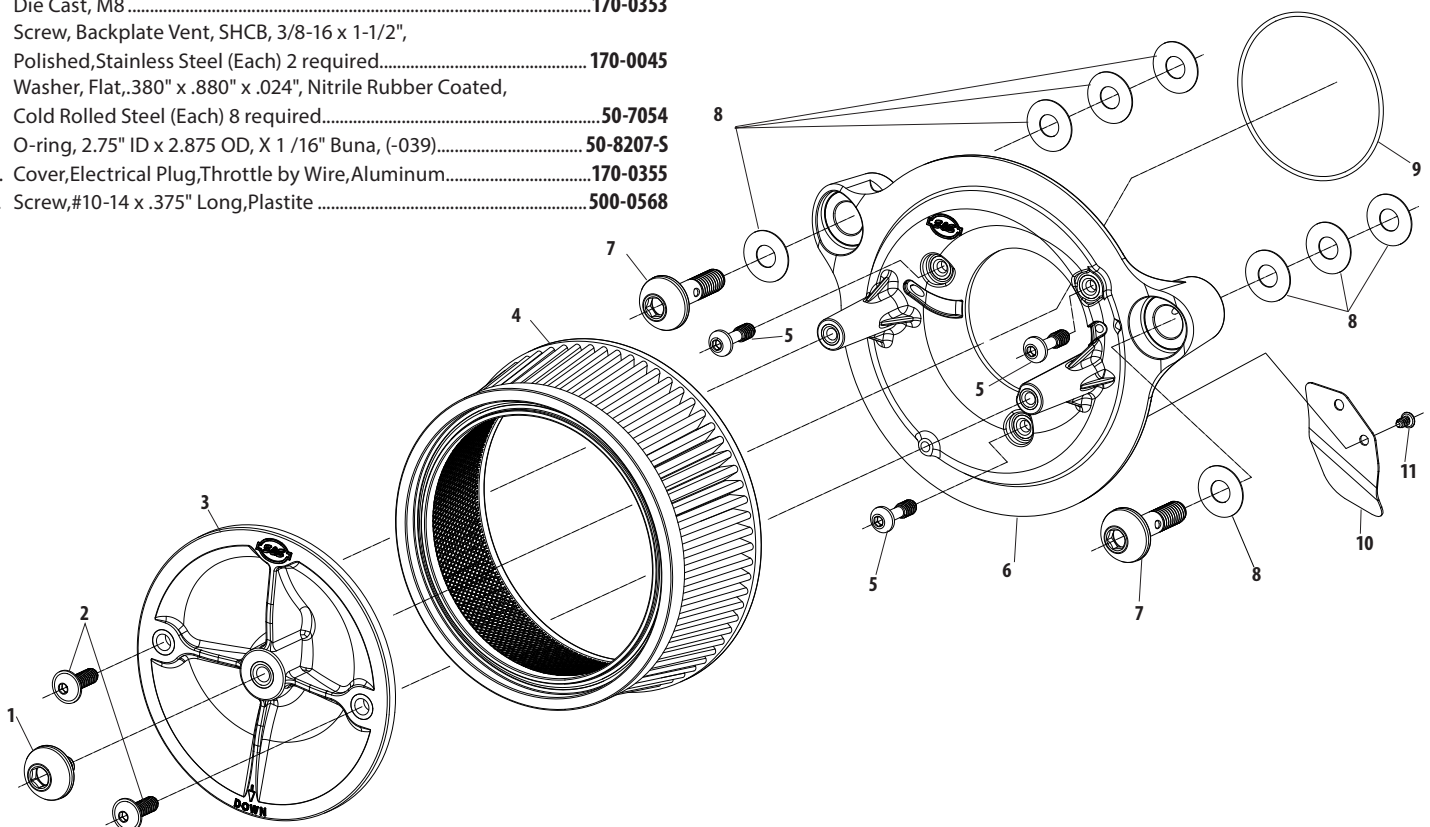



## Installation Instructions: S&S Carbon Fiber Teardrop Cover for S&S Stealth Air Cleaners

### DISCLAIMER:

Many S&S parts are designed for high performance, closed course, racing applications and are intended for the very experienced rider only. The installation of S&S parts may void or adversely affect your factory warranty. In addition such installation and use may violate certain federal, state, and local laws, rules and ordinances as well as other laws when used on motor vehicles used on public highways. Always check federal, state, and local laws before modifying your motorcycle. It is the sole and exclusive responsibility of the user to determine the suitability of the product for his or her use, and the user shall assume all legal, personal injury risk and liability and all other obligations, duties, and risks associated therewith.

### IMPORTANT NOTICE:

Statements in this instruction sheet preceded by the following words are of special significance.



#### WARNING

Means there is the possibility of injury to yourself or others.



#### CAUTION

Means there is the possibility of damage to the part or motorcycle.

#### NOTE

*Other information of particular importance has been placed in italic type.*

*S&S recommends you take special notice of these items.*

### SAFE INSTALLATION AND OPERATION RULES:

Before installing your new S&S part, it is your responsibility to read and follow the installation and maintenance procedures in these instructions and follow the basic rules below for your personal safety.

- Gasoline is extremely flammable and explosive under certain conditions and toxic when breathed. Do not smoke. Perform installation in a well ventilated area away from open flames or sparks.
- If motorcycle has been running, wait until engine and exhaust pipes have cooled down to avoid getting burned before performing any installation steps.
- Before performing any installation steps, disconnect battery to eliminate potential sparks and inadvertent engagement of starter while working on electrical components.
- Read instructions thoroughly and carefully so all procedures are completely understood before performing any installation steps. Contact S&S with any questions you may have if any steps are unclear or any abnormalities occur during installation or operation of motorcycle with an S&S part on it.
- Consult an appropriate service manual for your motorcycle for correct disassembly and reassembly procedures for any parts that need to be removed to facilitate installation.
- Use good judgment when performing installation and operating motorcycle. Good judgment begins with a clear head. Don't let alcohol, drugs or fatigue impair your judgment. Start installation when you are fresh.
- Be sure all federal, state and local laws are obeyed with the installation.
- For optimum performance and safety and to minimize potential damage to carb or other components, use all mounting hardware that is provided and follow all installation instructions.
- Motorcycle exhaust fumes are toxic and poisonous and must not be breathed. Run motorcycle in a well ventilated area where fumes can dissipate.

**NOTE:** This instruction sheet details installation of the S&S Carbon Fiber Teardrop air cleaner cover only, and is intended to be used in conjunction with model specific air cleaner kit instructions for S&S Stealth air cleaners.

1. If the S&S Carbon Fiber Teardrop air cleaner cover was purchased as part of a complete Stealth air cleaner kit, follow the instructions provided with the kit to install the air cleaner on the engine. Stop at the step that instructs you to install the air filter and cover plate. A cover plate will not be provided in a Stealth air cleaner kit that includes a Carbon Fiber Teardrop air cleaner cover. Skip to Step 5 of this instruction sheet.
2. If you purchased the S&S Carbon Fiber Teardrop as a cover only, to install on an existing Stealth air cleaner, proceed with steps 3 and 4.
3. Remove the existing cover, if one is installed.
4. Remove the two cover plate screws (see **Picture 1**) and remove the cover plate and filter. The cover plate and screws will not be needed in this installation.

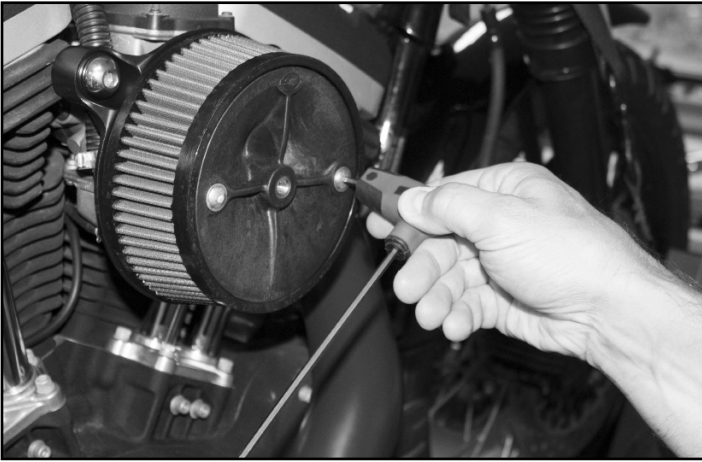

**Picture 1**

5. Locate the two air cleaner cover screws included in the kit, see **Picture 2**.



**Picture 2**

6. Insert the filter into the top plate on the filter as pictured in **Picture 3**.



**Picture 3**



**Picture 4**

7. Align the filter top plate assembly with the mounting screw holes in the Stealth back plate. Insert ring on the cover. Apply 243 Loctite® on screws and pass the screws through the cover ring, carbon cover, and the filter top plate. Torque screws to 50 in-lbs.



**Picture 5**

- 1. Cover, Air Cleaner, Stealth, Teardrop, Carbon Fiber. . . . . **N/A**
- 2. Plate, Top, Air Filter, Teardrop, Packaged . . . . . **170-0503**
- 3. Insert, Cover, Air Cleaner, Stealth, Teardrop, Packaged . . . . **170-0502**
- 4. Screw, Flat Head, Packaged, ¼-20 x 7/8",  
Stainless Steel (qty 2) . . . . . **500-0854**

