



Installation Instructions for S&S[®] Forged Pistons For Stock Bore And 3⁵/₈" Bore Harley-Davidson[®] 1936-'99 Big Twin And 1957- Present Sportster[®] Models

DISCLAIMER:

S&S parts are designed for high performance, closed course, racing applications and are intended for the very experienced rider only. The installation of S&S parts may void or adversely affect your factory warranty. In addition such installation and use may violate certain federal, state, and local laws, rules and ordinances as well as other laws when used on motor vehicles used on public highways, especially in states where pollution laws may apply. Always check federal, state, and local laws before modifying your motorcycle. It is the sole and exclusive responsibility of the user to determine the suitability of the product for his or her use, and the user shall assume all legal, personal injury risk and liability and all other obligations, duties, and risks associated therewith.

The words Harley[®], Harley-Davidson[®], H-D[®], Sportster[®], Evolution[®], and all H-D part numbers and model designations are used in reference only. S&S Cycle is not associated with Harley-Davidson, Inc.

SAFE INSTALLATION AND OPERATION RULES:

Before installing your new S&S part it is your responsibility to read and follow the installation and maintenance procedures in these instructions and follow the basic rules below for your personal safety.

- Gasoline is extremely flammable and explosive under certain conditions and toxic when breathed. Do not smoke. Perform installation in a well ventilated area away from open flames or sparks.
- If motorcycle has been running, wait until engine and exhaust pipes have cooled down to avoid getting burned before performing any installation steps.
- Before performing any installation steps disconnect battery to eliminate potential sparks and inadvertent engagement of starter while working on electrical components.
- Read instructions thoroughly and carefully so all procedures are completely understood before performing any installation steps. Contact S&S with any questions you may have if any steps are unclear or any abnormalities occur during installation or operation of motorcycle with a S&S part on it.
- Consult an appropriate service manual for your motorcycle for correct disassembly and reassembly procedures for any parts that need to be removed to facilitate installation.
- Use good judgment when performing installation and operating motorcycle. Good judgment begins with a clear head. Don't let alcohol, drugs or fatigue impair your judgment. Start installation when you are fresh.
- Be sure all federal, state and local laws are obeyed with the installation.
- For optimum performance and safety and to minimize potential damage to carb or other components, use all mounting hardware that is provided and follow all installation instructions.
- Motorcycle exhaust fumes are toxic and poisonous and must not be breathed. Run motorcycle in a well ventilated area where fumes can dissipate.

IMPORTANT NOTICE:

Statements in this instruction sheet preceded by the following words are of special significance.



WARNING

Means there is the possibility of injury to yourself or others.



CAUTION

Means there is the possibility of damage to the part or motorcycle.

NOTE

Other information of particular importance has been placed in italic type.

S&S recommends you take special notice of these items.

GENERAL INFORMATION

1. For maximum piston and ring life, fit pistons using close fit dimensions. Close fit requires absolute adherence to new engine break-in as described on page 6.
2. For immediate drag strip use, fit pistons using loose fit dimensions. Break in rings and pistons with 50 easy miles if possible. Piston and ring life will be reduced with loose fit dimensions.
3. Measure all pistons at widest point across thrust face, perpendicular to wristpin hole. Several measurements should be taken to locate widest point. Typically, this will be at bottom of piston skirt for pre-1984 Harley-Davidson® big twins, and approximately ½" below level of wristpin hole in pistons for Evolution® engines. If pre-1984 piston is notched for placement in rear cylinder, use measurement directly above notch for skirt measurement.
4. S&S® recommends #220-#280 grit stone for final honing of stock bore and Sidewinder®, S&S T124 and S&S big bore cylinders.
5. Follow procedure recommended in Harley-Davidson® service manual for boring and honing stock bore cylinders. Follow instructions included with S&S Cylinder Torque Plate Kit when boring and honing S&S stock bore and 3⅝" bore cylinders. Torque plates must be used when boring or honing aluminum cylinders to simulate compressive stress in an assembled engine. Cylinder bores will not be straight when engine is assembled, if torque plates are not used.

CAUTION

Failure to follow instructions and perform required clearancing, installation and/or break-in procedures may result in damage to pistons and/or other engine components not covered under warranty

PISTON INSTALLATION



Picture 1

NOTE: Pistons may have piston to piston clearance on both the front and rear. The notches must face each other. Pistons for pre-1984 application have no wristpin offset and can be installed in the front or rear. Pistons for 1984-up applications should be installed according to the marks on the top of the piston.

1. Check all installations for minimum of .060" clearance between pistons at closest point near bottom of stroke.
2. Check all installations for minimum of .060" clearance between pistons and flywheels at bottom of stroke. Replacement pistons may or may not have adequate clearance. Compare replacement pistons with ones being replaced and make corrections accordingly.

NOTE: In all cases it is the engine builder's responsibility to confirm proper clearances when assembling an engine. This is especially critical with performance components such as higher compression pistons and high lift camshafts. In addition to clearances mentioned, .060" valve-to-piston clearance must be confirmed.

CAUTION

Failure to establish proper clearances can result in severe engine damage not covered under warranty.

WRISTPIN RETAINER INSTALLATION

NOTE: Thoroughly clean wristpin before installation, paying particular attention to bore. Pass clean, lint-free cloth back and forth through wristpin bore several times to insure removal of contaminants.

1. If wristpin clips are used, insure that groove in piston is free of burrs and foreign matter.
2. Round "wire" style clips identical to and interchangeable with stock Harley-Davidson® Evolution® clips. Round wire clips require wristpins with specially chamfered ends. Install wire clips using procedure recommended in a Harley-Davidson® service manual. End of clip must rest over notch in piston below wristpin hole to allow removal of clip in future. Be sure clip is fully seated in groove.

RING INSTALLATION

1. Ring widths on some piston series are subject to change from time to time. Part numbers of rings originally supplied with pistons should be recorded for future reference in the event replacement rings are required. Measure rings to ensure that you get the correct replacement ring set.
2. The majority of ring kits presently supplied by S&S® contain a moly faced top ring, a cast, reverse torsion second ring, and a three piece oil ring. This may be confirmed as follows:
 - a. Top compression ring has a gray finish that is relatively light in color, and may or may not have a slight bevel along the inner edge. It has no dot or other identifying mark. The light color can best be recognized by comparing compression rings to each other beneath a good light. Install light colored ring without dot in top groove, bevel up. If there is no bevel, ring can be installed either side up.
 - b. Second compression ring has a darker, charcoal gray finish and slight bevel along inner surface. This ring has a dot. See Figure 1. Install in second or middle groove with dot up.
 - c. Oil rings are three piece type with two rails and one expander. Do not shorten expander for any reason! Installation is straightforward with one rail placed above expander, other rail below expander. Rails may be shortened to correct gap, but burrs must be carefully removed.

NOTE: In some cases, same expander is used for several bore sizes. Over-size rings will not necessarily have a larger expander.

CAUTION

Failure to remove burrs may cause engine damage. Incorrect installation of rings may result in poor performance, excessive oil consumption or engine damage.

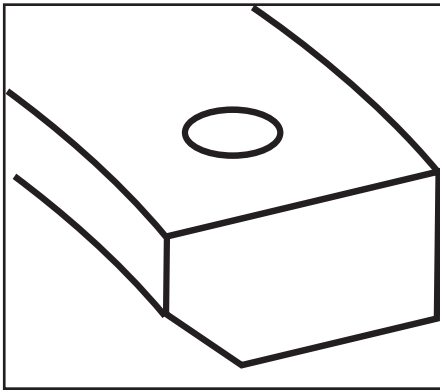

Figure 1

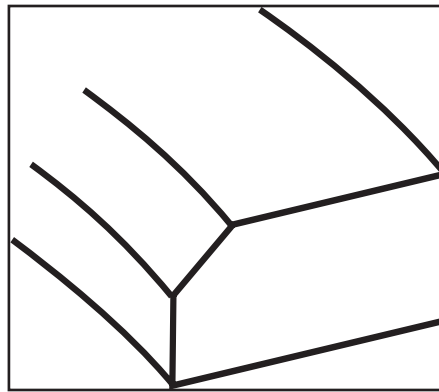

Figure 2

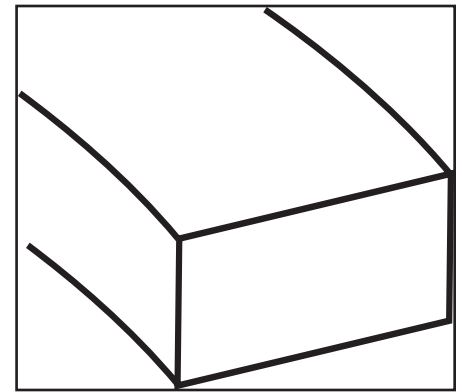

Figure 3

3. For ring kits in which section #2 above does not apply, compression rings may be of plain cast iron type, chrome faced cast iron type, moly faced cast type or chrome type.

- a. The most common combinations are:
 - i. Two chrome faced cast rings
 - ii. One chrome faced cast ring & one plain cast ring.
 - iii. One moly faced cast ring & one plain cast ring.
- b. Install as follows:
 - i. Chrome faced or moly faced ring always goes in top groove
 - ii. Plain cast ring usually goes in second groove. Plain cast type is usually a reverse torsion ring distinguished by an inside diameter bevel on one side of ring and a "dot" or oversize mark on other side. **See Figure 1** above. If two cast iron compression rings are supplied in a set, check to see if one is reverse torsion style ring with dot and bevel. Reverse torsion style ring always goes in second groove with dot up if present.
- c. The following rules apply to compression ring identification and placement. Rules are listed in order of priority. In other words, if both Rule #2 and Rule #4 apply, for example, Rule #2 will be followed and Rule #4 ignored.
 - i. Chrome or moly ring goes in top groove.
 - ii. Cast iron regular or reverse torsion ring goes in second groove.
 - iii. Any identifying "pip" marks, dots or oversize marks go to top of piston.
 - iv. Ring with one dot goes in top groove, ring with two dots goes in second groove.
 - v. If both rings are identical and have one dot or two dots, either ring can go in either groove.
 - vi. If ring has dot and inside diameter bevel, dot goes to top of piston. **See Figure 1** above.
 - vii. If ring has no dot but does have inside diameter bevel, bevel goes to top of piston. **See Figure 2** above.
 - viii. If ring has no dots and no bevel, it can go either way. **See Figure 3** above.

4. Ring Gap Measurements

- a. Compression ring end gap on big twins with $3\frac{7}{16}$ ", $3\frac{1}{2}$ " and $3\frac{5}{8}$ " bore is .014" to .022".
- b. End gap on all other compression rings is .016" to .024".
- c. Oil ring rail end gap on big twins with $3\frac{7}{16}$ ", $3\frac{1}{2}$ " and $3\frac{5}{8}$ " bore is .015" to .035".

NOTE: In certain instances, the next oversize ring set may be supplied with pistons, for example +.060" oversize rings with +.050" pistons. In this case end gaps must be measured and rings filed as necessary. Ends must then be carefully deburred.

5. Install ring support rail in front piston so that the end gap is toward the rear of the cylinder (90° from wristpin). Install ring support rail on rear piston so that the end gap is toward front of the cylinder (90° from wristpin).

6. Ring Gap Placement

- a. Oil ring
 - i. Expander gap must be in center of thrust face (rear of piston), or 90° from wristpin.
 - ii. Bottom rail gap should be approximately 1.5" or 45° to right of expander gap.
 - iii. Top rail gap should be approximately 1.5" or 45° to left of expander gap.

NOTE: Confirm that ends of expander do not overlap during installation. Properly installed expander will appear larger than piston but will compress when cylinder installed.

- b. Top compression ring gap should be 135° or approximately $4\frac{1}{2}$ " to left of oil expander gap.
- c. Second compression ring gap should be 135° or approximately $4\frac{1}{2}$ " to right of oil expander gap.

***NOTE:** Fit wristpins at .0007" to .0014."

ENGINE BREAK-IN PROCEDURE

NOTES:

S&S® engines are designed for high performance and as such are not as tolerant of inadequate break-in. Correct break-in will assure longer engine life and will prevent unnecessary engine damage. Engine damage caused by improper break-in is not covered under the S&S warranty. If new pistons have not been installed, only steps A, B, and C are required. If new pistons have been installed, all break in steps are required.

1. Initial start up. Run engine approximately one minute at 1250-1750 rpm. DO NOT crack throttle or subject to any loads during this period as head gaskets are susceptible to failure at this time. During this time check to see that oil pressure is normal, that oil is returning to the oil tank, and that no leaks exist.
2. Shut off engine and thoroughly check for any leaks or other problems. Let engine cool to the touch
3. After engine has cooled, start up again and allow the motor to build some heat. Engine should be run no longer than three to four minutes. When the cylinders become warm/hot to the touch (approximately 150°) shut the motor down and let it cool to room temp. Follow the same cautions as for the initial start-up, and continue to watch for problems.



Failure to deburr rings may result in engine damage.

4. Repeat this procedure 3 or 4 times. Each successive time it should take slightly longer to warm up and you can increase the temp slightly each time (+10°). You can be more liberal each time with the rpm, gently vary rpm continuously from idle up to 2500 rpm in the final cycle. Don't be too concerned with final carb settings at this time because idle speed and mixture cannot be correctly set until the motor reaches full operating temperature. The motor should not reach that temperature during these cycles. Do not allow engine temperature to become excessive. After the motor has cooled to room temperature for the final time you are ready to start the 500 mile engine break-in process.
5. The first 50 miles are most critical for new rings and piston break-in. Engine damage is most likely to occur during this period. Keep heat down by not exceeding 2500 rpm. Avoid lugging the motor, riding in hot weather or in traffic. Vary the engine speed. Do not lug the engine. We recommend changing the oil at 50 miles.
6. The next 500 miles should be spent running engine no faster than 3500 rpm or 60 mph. Avoid continuous steady speeds, and do not lug the engine. Vary engine rpm. We recommend changing the oil again at 500 miles.



Lugging or running engine prematurely at sustained high rpm may result in damage to pistons and other engine components. S&S® voids its guarantee if engine is not broken in properly.

7. For the balance of the first 1000 miles the motor can be run in a normal but conservative manner. You can be more liberal with the rpm range and motorcycle can be operated at normal highway speeds. Avoid overheating or putting any hard strain on the engine: no drag racing, dyno runs, excessive speed, trailer towing or sidecar operation.
8. After 1000 miles, verify carburetor jetting and adjustment. Change the engine oil. Motorcycle can now be operated normally.
9. Have Fun!

SET PART #	DESCRIPTION	PART # STAMPED ON PISTON	CLOSE FIT	LOOSE FIT	OLD S&S PNs THAT ARE SUPERCEDED					
106-5495	Piston Set 3/16" Std, LC, Forged, .791" WP, 1936-'84 bt	106-5491	.0035" to .004"	.0045" to .0055"	92-2500	92-2510				
106-5496	Piston Set 3/16" +.010", LC, Forged, .791" WP, 1936-'84 bt	106-5492	.0035" to .004"	.0045" to .0055"	92-2501	92-2511				
106-5497	Piston Set 3/16" +.020", LC, Forged, .791" WP, 1936-'84 bt	106-5493	.0035" to .004"	.0045" to .0055"	92-2502	92-2512				
106-5498	Piston Set 3/16" +.030", LC, Forged, .791" WP, 1936-'84 bt	106-5494	.0035" to .004"	.0045" to .0055"	92-2503	92-2513				
106-5773	Piston Set 3/16" +.040", LC, Forged, .791" WP, 1936-'84 bt	106-5774	.0035" to .004"	.0045" to .0055"	92-2504	92-2514				
106-5503	Piston Set 3/16" Standard, HC, .791" WP, 1936-'84 bt	106-5499	.0035" to .004"	.0045" to .0055"						
106-5504	Piston Set 3/16" +.010", HC, .791" WP, 1936-'84 bt	106-5500	.0035" to .004"	.0045" to .0055"						
106-5505	Piston Set 3/16" +.020", HC, .791" WP, 1936-'84 bt	106-5501	.0035" to .004"	.0045" to .0055"						
106-5506	Piston Set 3/16" +.030", HC, .791" WP, 1936-'84 bt	106-5502	.0035" to .004"	.0045" to .0055"						
106-5775	Piston Set 3/16" +.040", HC, .791" WP, 1936-'84 bt	106-5776	.0035" to .004"	.0045" to .0055"						
106-5511	Piston Set 3/16" Standard, LC, .791" WP, 1936-'84 bt	106-5507	.0035" to .004"	.0045" to .0055"	92-2606	92-2616				
106-5512	Piston Set 3/16" +.010", LC, .791" WP, 1936-'84 bt	106-5508	.0035" to .004"	.0045" to .0055"	92-2607	92-2617				
106-5513	Piston Set 3/16" +.020", LC, .791" WP, 1936-'84 bt	106-5509	.0035" to .004"	.0045" to .0055"	92-2608	92-2618				
106-5514	Piston Set 3/16" +.030", LC, .791" WP, 1936-'84 bt	106-5510	.0035" to .004"	.0045" to .0055"	92-2609	92-2619				
106-5519	Piston Set 3/16" Standard, HC, .791" WP, 1936-'84 bt	106-5515	.0035" to .004"	.0045" to .0055"	92-2506	92-2516				
106-5520	Piston Set 3/16" +.010", HC, .791" WP, 1936-'84 bt	106-5516	.0035" to .004"	.0045" to .0055"	92-2507	92-2517				
106-5521	Piston Set 3/16" +.020", HC, .791" WP, 1936-'84 bt	106-5517	.0035" to .004"	.0045" to .0055"	92-2508	92-2518				
106-5522	Piston Set 3/16" +.030", HC, .791" WP, 1936-'84 bt	106-5518	.0035" to .004"	.0045" to .0055"	92-2509	92-2519				
920-0073	Piston Set 3-7/16" x 4-3/4", Standard, LC, .791" WP, 1936-'84 bt	920-0072	.0035" to .004"	.0045" to .0055"	92-2800	92-2720	92-2730	92-2900		
920-0075	Piston Set 3-7/16" x 4-3/4", +.010, LC, .791" WP, 1936-'84 bt	920-0074	.0035" to .004"	.0045" to .0055"	92-2801	92-2721	92-2731	92-2901		
920-0077	Piston Set 3-7/16" x 4-3/4", +.020, LC, .791" WP, 1936-'84 bt	920-0076	.0035" to .004"	.0045" to .0055"	92-2802	92-2722	92-2732	92-2902		
920-0079	Piston Set 3-7/16" x 4-3/4", +.030, LC, .791" WP, 1936-'84 bt	920-0078	.0035" to .004"	.0045" to .0055"	92-2803	92-2723	92-2733	92-2903		
920-0081	Piston Set 3-7/16" x 4-3/4", +.040, LC, .791" WP, 1936-'84 bt	920-0080	.0035" to .004"	.0045" to .0055"	92-2804	92-2724	92-2734	92-2904		
920-0083	Piston Set 3-7/16" x 4-3/4", +.050, LC, .791" WP, 1936-'84 bt	920-0082	.0035" to .004"	.0045" to .0055"	92-2805	92-2725	92-2735	92-2905		
920-0085	Piston Set 3-7/16" x 4-3/4", +.060, LC, .791" WP, 1936-'84 bt	920-0084	.0035" to .004"	.0045" to .0055"	92-2806	92-2726	92-2736	92-2906		
920-0087	Piston Set 3-7/16" x 4-3/4", +.070, LC, .791" WP, 1936-'84 bt	920-0086	.0035" to .004"	.0045" to .0055"	92-2807	92-2727	92-2737	92-2907		
920-0089	Piston Set 3-7/16" x 4-3/4", +.080, LC, .791" WP, 1936-'84 bt	920-0088	.0035" to .004"	.0045" to .0055"	92-2808	92-2728	92-2738	92-2908		
920-0091	Piston Set 3-7/16" x 4-3/4", +.090, LC, .791" WP, 1936-'84 bt	920-0090	.0035" to .004"	.0045" to .0055"	92-2809	92-2729	92-2739	92-2909		
106-5527	Piston Set 3/16" x 4 3/4", Std, HC, .791" WP, 1936-'84 bt	106-5523	.0035" to .004"	.0045" to .0055"	92-2800	92-2720	92-2730	92-2900		
106-5528	Piston Set 3/16" x 4 3/4", +.010", HC, .791" WP, 1936-'84 bt	106-5524	.0035" to .004"	.0045" to .0055"	92-2801	92-2721	92-2731	92-2901		
106-5529	Piston Set 3/16" x 4 3/4", +.020", HC, .791" WP, 1936-'84 bt	106-5525	.0035" to .004"	.0045" to .0055"	92-2802	92-2722	92-2732	92-2902		
106-5530	Piston Set 3/16" x 4 3/4", +.030", HC, .791" WP, 1936-'84 bt	106-5526	.0035" to .004"	.0045" to .0055"	92-2803	92-2723	92-2733	92-2903		
106-5777	Piston Set 3/16" x 4 3/4", +.040", HC, .791" WP, 1936-'84 bt	106-5783	.0035" to .004"	.0045" to .0055"	92-2804	92-2724	92-2734	92-2904		
106-5778	Piston Set 3/16" x 4 3/4", +.050", HC, .791" WP, 1936-'84 bt	106-5784	.0035" to .004"	.0045" to .0055"	92-2805	92-2725	92-2735	92-2905		
106-5779	Piston Set 3/16" x 4 3/4", +.060", HC, .791" WP, 1936-'84 bt	106-5785	.0035" to .004"	.0045" to .0055"	92-2806	92-2726	92-2736	92-2906		
106-5780	Piston Set 3/16" x 4 3/4", +.070", HC, .791" WP, 1936-'84 bt	106-5786	.0035" to .004"	.0045" to .0055"	92-2807	92-2727	92-2737	92-2907		
106-5781	Piston Set 3/16" x 4 3/4", +.080", HC, .791" WP, 1936-'84 bt	106-5787	.0035" to .004"	.0045" to .0055"	92-2808	92-2728	92-2738	92-2908		
106-5782	Piston Set 3/16" x 4 3/4", +.090", HC, .791" WP, 1936-'84 bt	106-5788	.0035" to .004"	.0045" to .0055"	92-2809	92-2729	92-2739	92-2909		
106-5535	Piston Set 3/16" Standard, HC, .791" WP, 1936-'84 bt	106-5531	.0035" to .004"	.0045" to .0055"	92-1800	92-1830	92-1840	92-1620	92-1630	92-1640
106-5536	Piston Set 3/16" +.010", HC, .791" WP, 1936-'84 bt	106-5532	.0035" to .004"	.0045" to .0055"	92-1801	92-1831	92-1841	92-1621	92-1631	92-1641
106-5537	Piston Set 3/16" +.020", HC, .791" WP, 1936-'84 bt	106-5533	.0035" to .004"	.0045" to .0055"	92-1802	92-1832	92-1842	92-1622	92-1632	92-1642
106-5538	Piston Set 3/16" +.030", HC, .791" WP, 1936-'84 bt	106-5534	.0035" to .004"	.0045" to .0055"	92-1803	92-1833	92-1843	92-1623	92-1633	92-1643
106-5789	Piston Set 3/16" +.060", HC, .791" WP, 1936-'84 bt	106-5790	.0035" to .004"	.0045" to .0055"	92-1806	92-1836	92-1846	92-1626	92-1636	92-1646
106-5542	Piston Set 3/16" +.010", HC, .791" WP, 1972-'85 xl	106-5539	.0035" to .004"	.0045" to .0055"	92-3701					
106-5543	Piston Set 3/16" +.020", HC, .791" WP, 1972-'85 xl	106-5540	.0035" to .004"	.0045" to .0055"	92-3702					
106-5544	Piston Set 3/16" +.030", HC, .791" WP, 1972-'85 xl	106-5541	.0035" to .004"	.0045" to .0055"	92-3703					
106-5791	Piston Set 3/16" +.060", HC, .791" WP, 1972-'85 xl	106-5792	.0035" to .004"	.0045" to .0055"	92-3706					
106-5548	Piston Set 3/16" Standard, DD, .792" WP, 883 to 1200 conversion, 1986-up xl	106-5545	.0025" to .0030"	.0035 to .0045"	92-2446					
106-5549	Piston Set 3/16" +.010", DD, .792" WP, 883 to 1200 conversion, 1986-up xl	106-5546	.0025" to .0030"	.0035 to .0045"	92-2447					
106-5550	Piston Set 3/16" +.020", DD, .792" WP, 883 to 1200 conversion, 1986-up xl	106-5547	.0025" to .0030"	.0035 to .0045"	92-2448					
106-5554	Piston Set 3/16" Standard, FD, .792" WP, 1984-'99 bt	106-5551	.0025" to .0030"	.0035 to .0045"	92-2426					
106-5555	Piston Set 3/16" +.010", FD, .792" WP, 1984-'99 bt	106-5552	.0025" to .0030"	.0035 to .0045"	92-2427					
106-5556	Piston Set 3/16" +.020", FD, .792" WP, 1984-'99 bt	106-5553	.0025" to .0030"	.0035 to .0045"	92-2428					
106-5793	Piston Set 3/16" +.030", FD, .792" WP, 1984-'99 bt	106-5794	.0025" to .0030"	.0035 to .0045"	92-2429					



Installation Instructions for S&S[®] Piston Rings

DISCLAIMER:

S&S parts are designed for high performance, closed course, racing applications and are intended for the very experienced rider only. The installation of S&S parts may void or adversely affect your factory warranty. In addition such installation and use may violate certain federal, state, and local laws, rules and ordinances as well as other laws when used on motor vehicles used on public highways, especially in states where pollution laws may apply. Always check federal, state, and local laws before modifying your motorcycle. It is the sole and exclusive responsibility of the user to determine the suitability of the product for his or her use, and the user shall assume all legal, personal injury risk and liability and all other obligations, duties, and risks associated therewith.

The words Harley[®], Harley-Davidson[®], H-D[®], Sportster[®], Evolution[®], and all H-D part numbers and model designations are used in reference only. S&S Cycle is not associated with Harley-Davidson, Inc.

IMPORTANT NOTICE:

Statements in this instruction sheet preceded by the following words are of special significance.



WARNING

Means there is the possibility of injury to yourself or others.



CAUTION

Means there is the possibility of damage to the part or motorcycle.

NOTE

Other information of particular importance has been placed in italic type.

S&S recommends you take special notice of these items.

SAFE INSTALLATION AND OPERATION RULES:

Before installing your new S&S part it is your responsibility to read and follow the installation and maintenance procedures in these instructions and follow the basic rules below for your personal safety.

- Gasoline is extremely flammable and explosive under certain conditions and toxic when breathed. Do not smoke. Perform installation in a well ventilated area away from open flames or sparks.
- If motorcycle has been running, wait until engine and exhaust pipes have cooled down to avoid getting burned before performing any installation steps.
- Before performing any installation steps disconnect battery to eliminate potential sparks and inadvertent engagement of starter while working on electrical components.
- Read instructions thoroughly and carefully so all procedures are completely understood before performing any installation steps. Contact S&S with any questions you may have if any steps are unclear or any abnormalities occur during installation or operation of motorcycle with a S&S part on it.
- Consult an appropriate service manual for your motorcycle for correct disassembly and reassembly procedures for any parts that need to be removed to facilitate installation.
- Use good judgment when performing installation and operating motorcycle. Good judgment begins with a clear head. Don't let alcohol, drugs or fatigue impair your judgment. Start installation when you are fresh.
- Be sure all federal, state and local laws are obeyed with the installation.
- For optimum performance and safety and to minimize potential damage to carb or other components, use all mounting hardware that is provided and follow all installation instructions.
- Motorcycle exhaust fumes are toxic and poisonous and must not be breathed. Run motorcycle in a well ventilated area where fumes can dissipate.

Ring Identification

'Ring widths on S&S® pistons may change from time to time. Part numbers of rings originally supplied with pistons should be recorded for future reference in the event replacement rings are required.

1. The majority of ring kits presently supplied by S&S® contain a moly faced top ring, a cast, reverse torsion second ring, and a three piece oil ring. This may be confirmed as follows:
2. Top compression ring has a gray finish that is relatively light in color, and may or may not have a slight bevel along the inner edge. **See Figure 1.** It generally has no dot or other identifying mark. The light color can best be recognized by comparing compression rings to each other beneath a good light. Install light colored ring in top groove, bevel up. If there is no bevel, ring can be installed either side up.
3. Second compression ring has a darker, charcoal gray finish and may have slight bevel along inner surface, or a hook-like relief machined on the bottom of the outer diameter. **See Figures 2 and 3.** This ring may have a dot or letter on the top side. Install in second or middle groove with dot or letter up. Bevel on the inner surface or groove on outer diameter will face down.
4. Oil rings are three piece type with two rails and one expander. Do not shorten expander for any reason! Installation is straightforward with one rail placed above expander, other rail below expander. Rails may be shortened to correct gap, but burrs must be carefully removed.

NOTE: In some cases, same expander is used for several bore sizes. Oversize rings will not necessarily have a larger expander



**Failure to remove burrs may cause engine damage.
Incorrect installation of rings may result in poor performance,
excessive oil consumption or engine damage.**

5. Rings supplied in some ring kits may differ from those described in point #1 above. Compression rings may be of plain cast iron type, chrome, or moly faced cast iron.
6. The most common combinations are:
 - a. Two chrome faced cast rings
 - b. One chrome faced cast ring & one plain cast ring.
 - c. One moly faced cast ring & one plain cast ring.
 - d. Some S&S Pistons have a ring support rail that must installed after the piston and wrist pin are installed on the connecting rod and before any other rings are installed. Install ring support rail in front piston so that the end gap is toward the rear of the cylinder (90° from wristpin). Install ring support rail on rear piston so that the end gap is toward front of the cylinder (90° from wristpin). The dimple in the ring must face down and be lined up with the wrist pin on both pistons.
7. Install as follows:
 - a. Chrome faced or moly faced ring always goes in top groove
 - b. Plain cast ring usually goes in second groove. Plain cast type is usually a reverse torsion ring. distinguished by an inside diameter bevel on one side of ring, and a dot, letter, or oversize

mark on other side. **See Figure 2.** Some second rings may have a hook shaped groove machined around the bottom of the the outer diameter. If two cast iron compression rings are supplied in a set, check to see if one has mark and bevel or hook shaped groove. These rings always go in second groove with marking up if present and bevel or groove facing down.

8. The following general rules apply to compression ring identification and placement. Rules are listed in order of priority. In other words, if both Rule b and Rule d apply, for example, Rule b will be followed and Rule d is ignored.
 - a. Chrome or moly ring goes in top groove.
 - b. Cast iron regular or reverse torsion ring goes in second groove.
 - c. Any identifying pip marks, dots, letters, or oversize marks go to top of piston.
 - d. Ring with one dot goes in top groove, ring with two dots goes in second groove.
 - e. If both rings are identical and have one dot or two dots, either ring can go in either groove.
 - f. If ring has dot or letter and inside diameter bevel, dot or letter goes to top of piston. **See Figure 2 and 3.**
 - g. If ring has no dot but does have inside diameter bevel, bevel goes to top of piston. **See Figure 1** below.
 - h. If ring has no dots and no bevel, it can go either way. **See Figure 4** below.

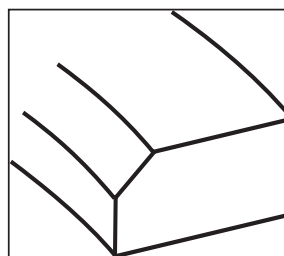

Figure 1

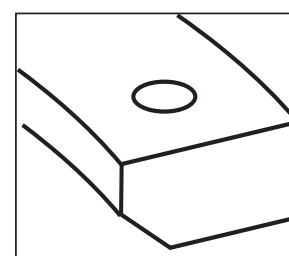

Figure 2

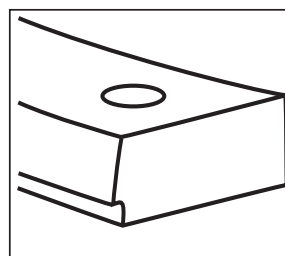

Figure 3

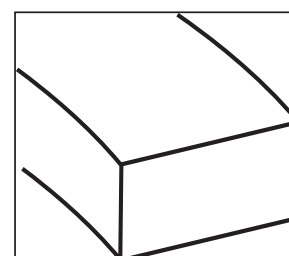
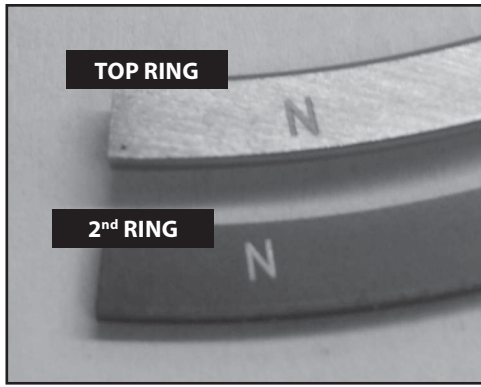

Figure 4

9. Rings for S&S 4 1/8" bore pistons and Pistons for CVO 110 engines
 - a. The 2nd compression ring is dark grey in color with a letter "N" on the top side. (**see Picture 1**).
 - b. The top ring compression is a light grey or silver with a letter "N" on the top side (**see Picture 1**). The top ring will have a chamfer on the inside edge, this chamfer will face up.



Picture 1

Setting Ring End Gaps

NOTES

1. Thoroughly wash cylinders with hot soapy water, then wash with brake cleaner and wipe with a clean white towel. Repeat until towel does not show evidence of debris and apply a light coat of oil immediately.
2. Check the ring end gap by placing the ring into the cylinder. Use a piston or caliper to ensure that the ring is placed squarely in the bore. See **Picture 2**.



Picture 2

3. Measure the ring end gap with a feeler gauge. See **Picture 3**.

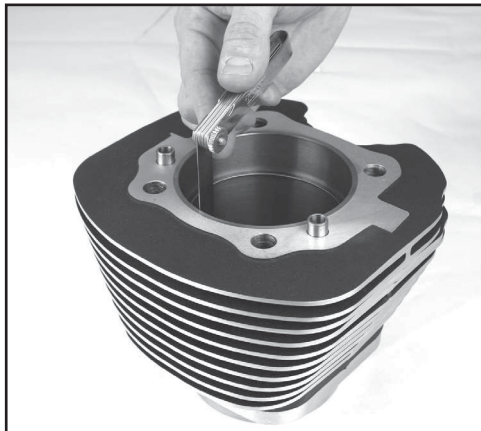

Picture 3

4. See **Table 1** for proper end gap measurement. If adjustment to the gap must be made, use a proper ring end gap filing tool.

Ring End Gap			
Application	Top Ring	Second Ring	Oil Ring
Street/Hi Performance	Bore x 0.0045"	0.004"-0.008" Bigger than top ring	Minimum 0.015" Do not file
Drag Racing	Bore x 0.005"	0.004"-0.008" Bigger than top ring	Minimum 0.015" Do not file
Nitrous/Turbo Supercharged	Bore x 0.0055"	0.004"-0.008" Bigger than top ring	Minimum 0.015" Do not file

Table 1

5. Always file from the ring face towards the inside diameter to avoid damaging the face coating.
6. Remove material from only one end of the ring.
7. Ensure that ring end gaps are square.
8. Remove sharp edges and burrs.
9. Recheck gap measurement and adjust as necessary.
10. Repeat procedure with the other rings.



Failure to deburr rings may result in engine damage.

NOTES:

- In certain instances, the next oversize ring set may be supplied with pistons, for example +.060" oversize rings with +.050" pistons. In this case end gaps must be measured and rings filed as necessary. Ends must then be carefully deburred.
- Important! The gap of the second ring should be larger than the top ring; this will help keep the top ring seated for improved performance.
- All rings should be fitted to the particular cylinder in which they will be installed.
- Oil rails can normally be installed without adjusting the end gap. The minimum gap should be 0.015"
- Never alter the end gap of the oil expander ring.
- Always install the ends of the expander facing up as shown in **Figure 5**.

Piston Ring installation

1. Piston rings may be installed either before piston is installed on connecting rod or afterward. However, if piston has a oil ring support rail, pistons must be installed on rods before support rail and rings are installed.
2. Install the oil ring expander in the bottom ring groove of the piston. The expander ring has a silver finish. Make sure the ends of the expander ring are butted together and not overlapping (**Figure 5**, below). If the tips are overlapped, excessive oil consumption will result.



Figure 5

3. Install oil rails. The oil rails are the thinnest of all the rings. Either side can be placed up. Install the rails into the groove by hand. Install one rail above the expander, and one below. Orient the gaps according to **Picture 4**
4. Install the 2nd ring with the correct side facing up. Use a piston ring expander to install the ring in the 2nd groove in the piston. Orient the gap according to **Picture 4**.
5. Install the top ring with the correct side facing up. Use a ring expander tool to install the ring in the top groove. Orient the gap according to **Picture 4**.

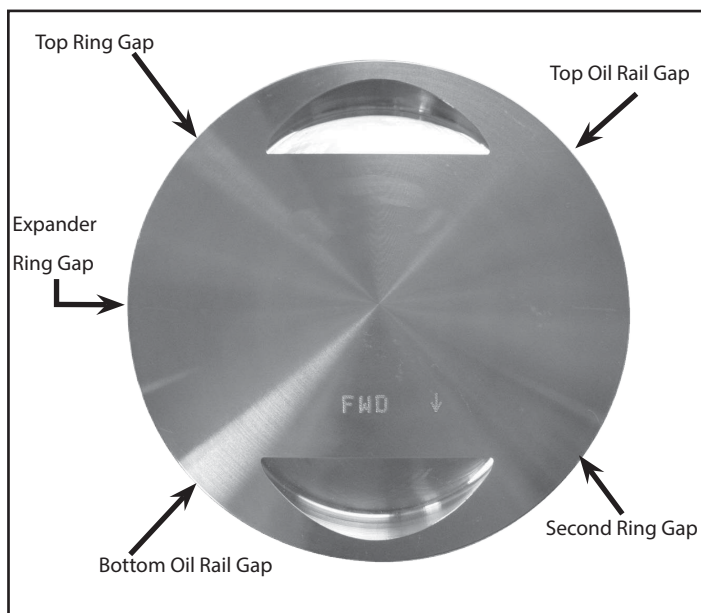

Picture 4

6. Compress ring pack using a suitable ring compressor. If possible, position the ring compressor so that you can see the oil expander gap during installation. See **Picture 5**.

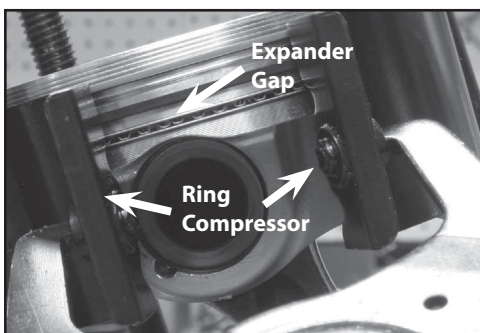

Picture 5

7. Install cylinder on piston, making sure not to overlap ends of oil ring expander. See **Picture 6**.

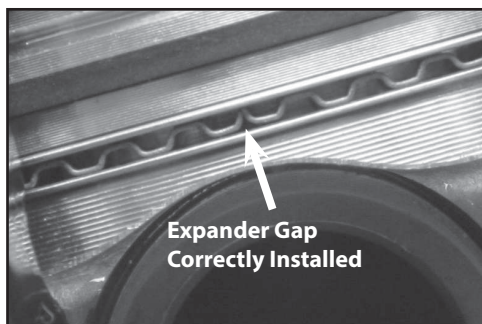

Picture 6

8. Proceed with engine reassembly according to procedures described in service manual for that type of engine.

Break In Procedure

1. Initial start up. Run engine approximately one minute at 1250-1750 rpm. DO NOT crack throttle or subject to any loads during this period as head gaskets are susceptible to failure at this time. During this time, check to see that oil pressure is normal, that oil is returning the oil tank, and that no leaks exist.
2. Shut off engine and thoroughly check for any leaks or other problems. Let engine cool to the touch.
3. After engine has cooled, start up again and allow the motor to build some heat. Engine should be run no longer than three to four minutes. When the cylinders become warm/hot to the touch (approximately 150° F) shut the motor down and let it cool to room temp. Follow the same cautions as for the initial start-up, and continue to check for problems.
4. First 50 Miles -
 - a. Street - Ride normally, do not lug the engine. Avoid high heat conditions and vary the RPM while riding. No stop and go traffic, extended idle periods, or high load or high RPM conditions. Max of 3,500 rpm or 60 mph.
 - b. Dyno - A chassis dynamometer can be used to put the first 50 miles on a new engine.
5. 50-100 Miles- Ride normally, do not lug the engine. Avoid high heat conditions, no stop and go traffic or extended idle periods. Limited short bursts of throttle can aid in ring seating from this point forward during the break-in, but avoid continuous high speed or load conditions. Max of 4,250 RPM/70 mph.
6. 100-500 Miles- Avoid lugging the engine and high heat conditions. Max of 5,000 rpm. Change oil at 500 miles.
7. 500 to 1,000 miles - Ride bike normally, but avoid continuous high load operation and high heat conditions.
8. From 1,000 miles on – Break-in is complete, enjoy!