













Congratulations on your purchase of this Pyle Cycle Series premier amplified speaker system. Like all Pyle products, this motorcycle system has been thoroughly tested to ensure consistent, reliable performance under some rigorous conditions. Our systems were designed to withstand water, moisture, heat, and direct sun exposure. We pride ourselves in customer satisfaction. If you should have any questions regarding the installation and/or operation of your Pyle Cycle Series motorcycle speaker system, which is not covered in this manual, please contact your Pyle Dealer or Pyle Technical Support.

What is Included?

Upon un-packing your new Pyle Cycle Series audio system, please check to ensure you have all the included parts.

Part # with Image	PLMCA31BT	PLMCA62BT	Part # with Image	PLMCA31BT	PLMCA62BT
#1 	(1) Pair of 300 Watt Stereo Chrome Speaker Enclosures with Speaker Wires	(1) Pair of 200 Watt Stereo Chrome Speaker Enclosures with Speaker Wires	#9 	(1) 12 Volt Direct Plug, for Compatible Motorcycles	(1) 12 Volt Direct Plug, for Compatible Motorcycles
#2 	(1) Pair of Handlebar Speaker Enclosure "P" Shape Clamp	(1) Pair of Handlebar Speaker Enclosure "P" Shape Clamp	#10 	(1) USB Charger/ Power Source	NA
#3 	(1) Pair of Handlebar Music Source Mount "Z" Shape Clamp	(1) Pair of Handlebar Music Source Mount "Z" Shape Clamp	#11 	(1) Bluetooth Control Box	(1) Bluetooth Control Box
#4 	(1) Micro Stereo 2CH Amplifier (300 Watts x 2 Max Output Power)	(1) Micro Stereo 2CH Amplifier (200 Watts x 2 Max Output Power)	#12 	(1) Black Industrial Velcro Adhesive Strips	NA
#5 	(1) Universal chrome Handlebar Mp3/Audio Mount with (2) Black Industrial Velcro	NA	#13 	(6) Black Wire Tie Lockable Straps	(6) Black Wire Tie Lockable Straps
#6 	(1) Amplifier 12 Volt (-) Ground Blue Spade Terminal	(1) Amplifier 12 Volt (-) Ground Blue Spade Terminal	#14 	(4) Screws for Speaker	(4) Screws for Speaker
#7 	(1) Amplifier 12 Volt (+) Blue Male Terminal Connector	(1) Amplifier 12 Volt (+) Blue Male Terminal Connector	#15 	(2) Screw, Washer and Nut for Amplifier	(2) Screw, Washer and Nut for Amplifier
#8 	(1) Universal 12 Volt Wire Harness Connection	(1) Universal 12 Volt Wire Harness Connection			

Installation Instructions:



- Step #1:** Install "P" shaped clamp (Item #2)/"Z" shaped clamp (Item #3) threaded on to the bottom of each speaker enclosure (Item #1). Use the provided bolts (item #14).
- Step #2:** Bolt each speaker with its mount to the handlebar of the vehicle. Hardware included will allow for mounting on to 1" diameter and smaller handlebars. Project each speaker at desired listening level, for best performance.
- Step #3:** Secure speaker wires either through handlebars for a custom look, or use (Item #13) wire ties to secure to the handlebars.
- Step #4:** Bolt the rotary volume control (Item #11) to the handlebars using the vehicle provided hardware. Then run 3.5 mm connection down to desired amplifier location. Use (Item #13) wire ties to secure to the handlebars. Have 3.5 mm male connection close to mount.

The Connector that comes pre-installed on the amplifier wire harness (Item #8) was designed to allow for direct plug-in for most American Motorcycles (Item #9). If mounting on a metric or universal vehicle, this harness will not be used, and replaced with the terminals/connectors provided in the enclosed parts bag according to the installation instructions (Items #6, #7, & #8). Follow wire instructions as shown in Diagram A Be sure to match the proper polarity for all connections. The polarity for the speaker terminals solid color wire (+), wire with stripe (-). Blue wire 12 Volt Positive (+) terminal trigger wire. Black wire 12 Volt (-) Ground to chassis of vehicle.

Step #5: Bolt the Universal Handlebar MP3/Audio Mount (Item #5) using provided black industrial velcro adhesive strips (Item #12). Remove bolt from existing switch housing on motorcycle and secure to bracket.

Step #6: (Only for use with PLMCA31BT/PLMCA62BT) : Bolt the USB Charger/ Power Source (Item #10) using vehicle provided hardware. This wire should be connected 12 Volt power source.

Step #7: Run wires up to neck area of motorcycle and plug into harness. Use (Item #13) wire ties to the frame.

Step #8: Bolt amplifier on Motorcycle with provided Bolt (item #15). Best if mounted directly to frame out of reach from direct heat or crash bar.

Step #9: Attach Velcro strips (Item #12) one side to our Universal Bracket (Item #5) the other to your MP3 player/ audio source.

Step #10: Connect 3.5mm male connection into Audio device, and opposite side into Micro Amplifier

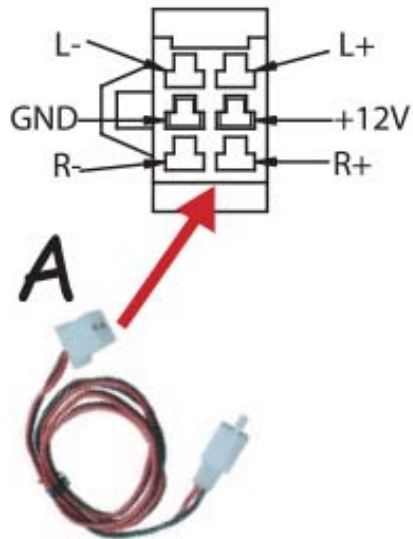

BLUETOOTH CONTROLLER

