

# YAMAHA MT09 '17-

REF 9955

SELF-ADJUSTING INCLINATION AND ELEVATION SYSTEM



1 Person



15 min







EASY

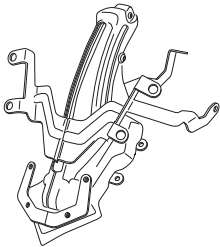
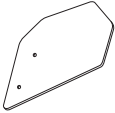
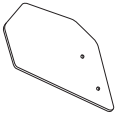

ALLEN  
Nº3  
Nº4  
Nº5



ID	PART	DESCRIPTION	QTY	REF
1		Mechanism	1	9955
2		Left deflector	1	9955HM3
3		Right deflector	1	9955HM3
4		M5 nylon washer	4	ARNV0000000245
5		M5 ISO 7380 screw cap	4	TAPON-----85
6		M5x11 Ø11 ISO7380 Allen screw	4	TORNI-AI----520
7		Ø4,5 x Ø11 x 2mm rubber washer	4	ARAND-EPDM--722

# YAMAHA MT09 '17-

## MOUNTING INSTRUCTIONS

**1**

DISASSEMBLY

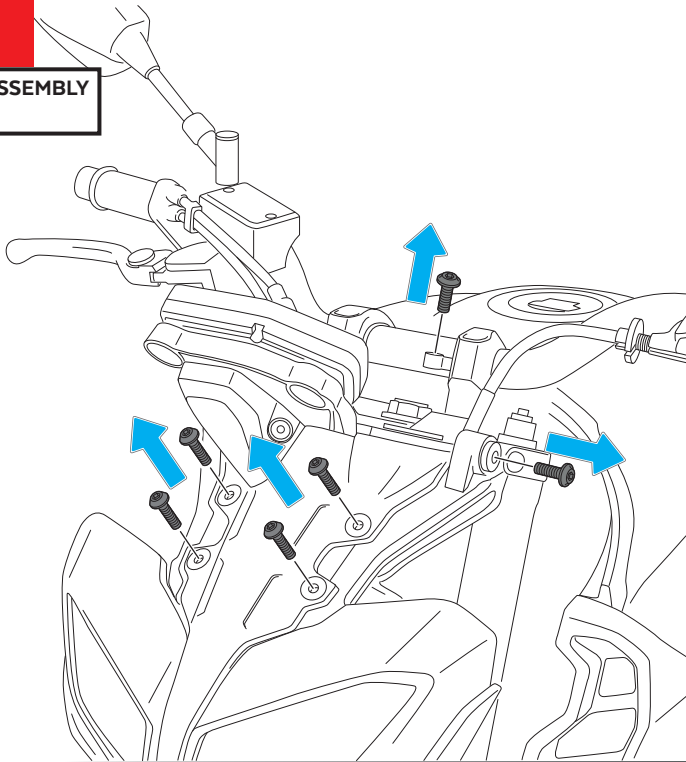

**2**

ASSEMBLY

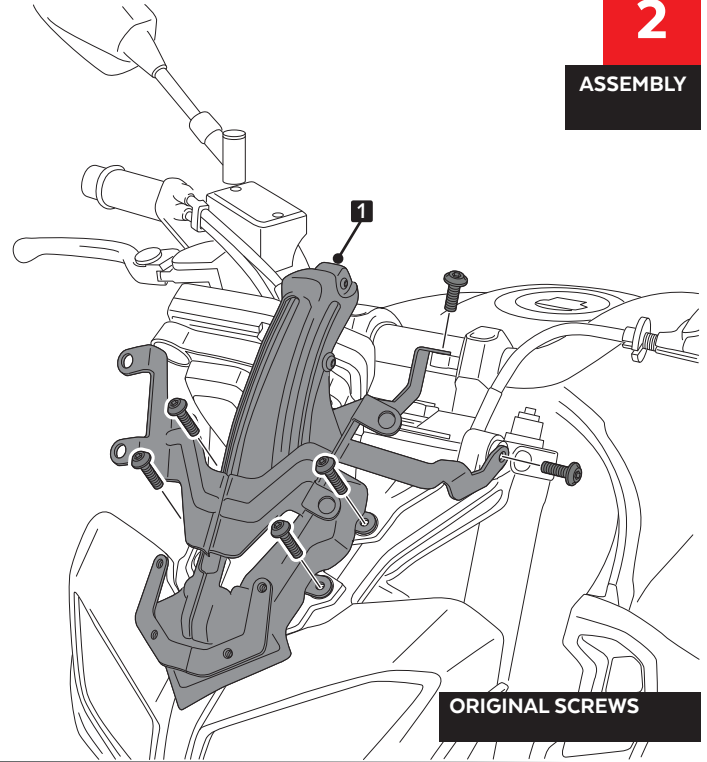

**3**

ASSEMBLY

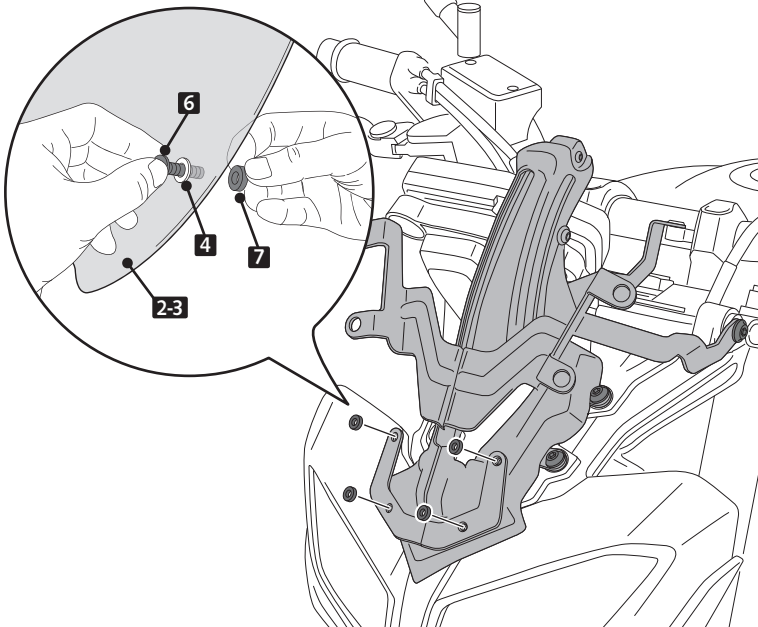





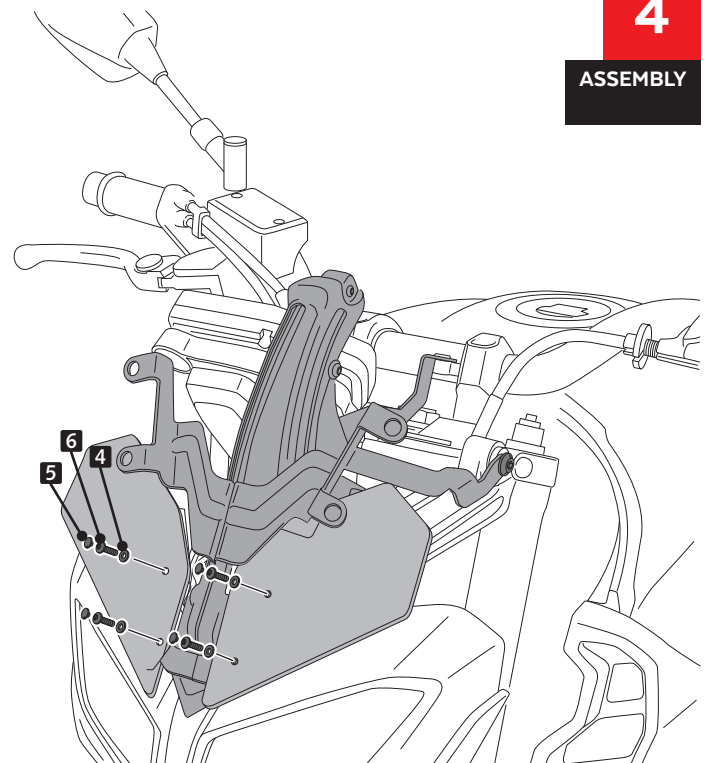





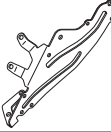

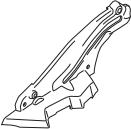







**4**

ASSEMBLY



## YAMAHA MT09 '17-

ID	PART	DESCRIPTION	QTY	REF
1		Central support	1	SOPOR-5P-6-9955
2		Left support	1	SOPOR-5P-6-9955
3		Right support	1	SOPOR-5P-6-9955
4		Reinforcement support	1	SOPOR-5P-6-9955
5		Right cover	1	9955JM3
6		Left cover	1	9955JM3
7		Friction plates	2	PLACA-FRICCION-
8		Spacer	5	CASQUI-----833
9		M5x16 Ø11 ISO7380 Allen screw	5	TORNI-I7380-493
10		M5x25 Ø11 ISO 7380 Allen screw	1	TORNI-I7380-766
11		M5 ISO 7380 screw cap	2	TAPON-----85
12		Ø12 x Ø6 x 9 silentblock	2	AROPASACABLES-1
13		Ø12 x Ø6,8 x 7,3 bush with flange	2	CASQUI-1A---750
14		Ø3,5 x Ø11 x 2 Rubber washer	5	ARAND-----816
15		M4x8 ISO7380 screw	5	TORNI-I7380-757
16		M4x0,5 nylon washer	5	ARNV00000000311
17		Cam lever	1	EXCENTRICAM6-QR
18		Spacer cam lever	1	CASQUI-----831
19		M6 DIN9021 Ø18xØ6,5x1,6 metal washer	1	ARANDPD9021-037
20		M8 DIN125 Ø16xØ8,5 x1,6 metal washer	1	ARANDPD125A-018
21		M6 lock nut	1	TUERCA-D982-745