

**TRIUMPH BONNEVILLE T100/T120/T200/
BONNEVILLE BOBBER / STREET TWIN / STREET CUP**









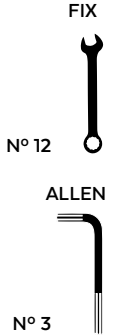

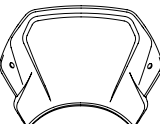
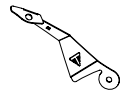
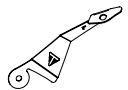
REF 9808

**ALUMINUM
FRONT PLATE**

REF 9191

**ABS
FRONT PLATE**



ID.	ART	DESCRIPTION	QTY.	REF.:
1		ABS front plate	1	10526J/C
		ALUMINUM front plate		9807P/N
2		Left support	1	SOPOR-2P-3-9191
3		Right support	1	SOPOR-2P-3-9191
4		M5 silentblock	2	SILENBTM5-046/1
5		Ø8,5 x Ø13 x6 spacer	2	CASQUI-----776
6		M8x20 DIN912 allen screw	2	TORNI-D912--164
7		M5x1 nylon washer	2	ARNV0000000245
8		M5x16 Ø11 ISO 7380 allen screw (INOX)	2	TORNI-IA----423
9		M5 screw cap	2	TAPON-----85
10		Ø8 x2 silicon spacers (Supplied mounted with part 1/2)	2	ADHESI-GT-D8---
11		Self-adhesive trim lenght 190mm 6,2x2,6mm *ONLY FOR ALUMINUM FRONT PLATE (REF:9807)	4	RIBETETP---0900
12		M5x16 Ø11 ISO 7380 allen screw	1	TORNI-I7380-493
13		Stickers set	1	10535

TRIUMPH BONNEVILLE T100/T120/T200/ BONNEVILLE BOBBER / STREET TWIN / STREET CUP

MOUNTING INSTRUCTIONS

1

DISASSEMBLY

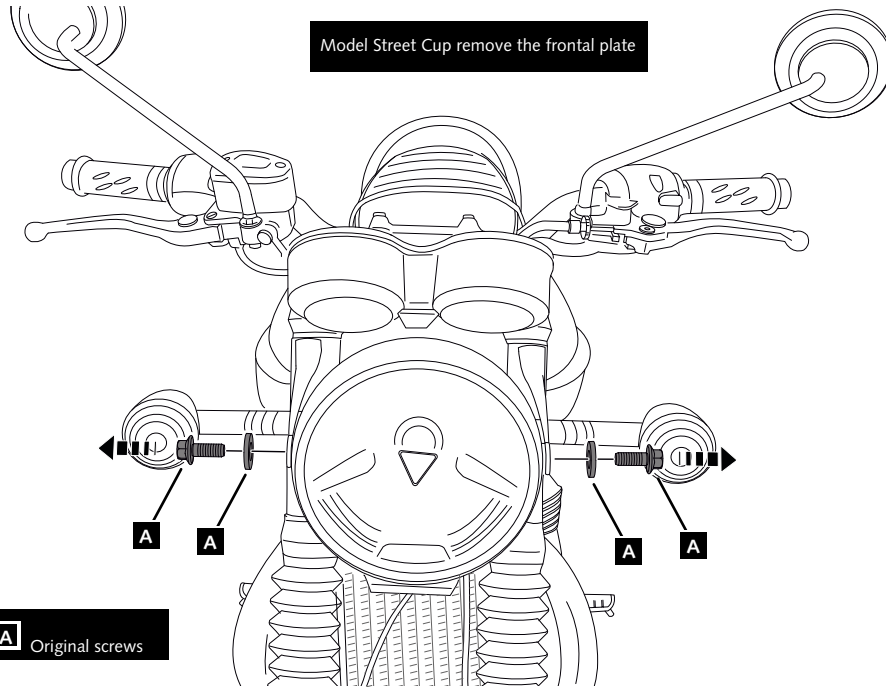

2

ASSEMBLY

BONNEVILLE T100 / T120 / T200

STREET CUP / STREET TWIN

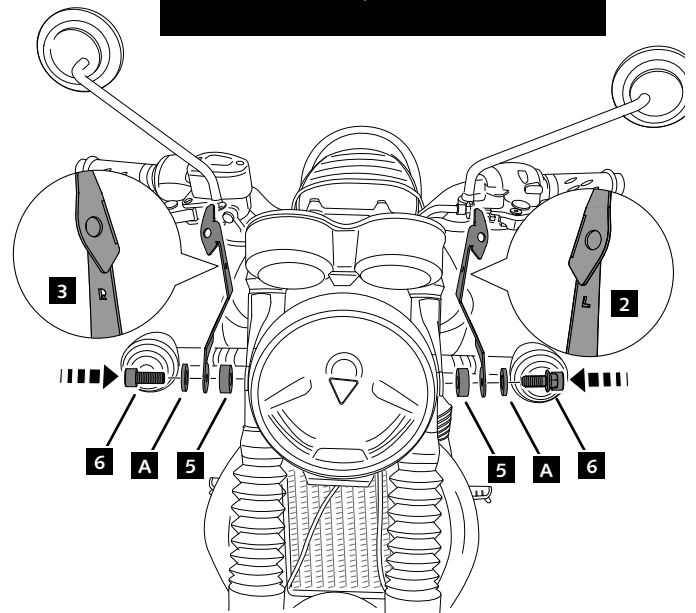
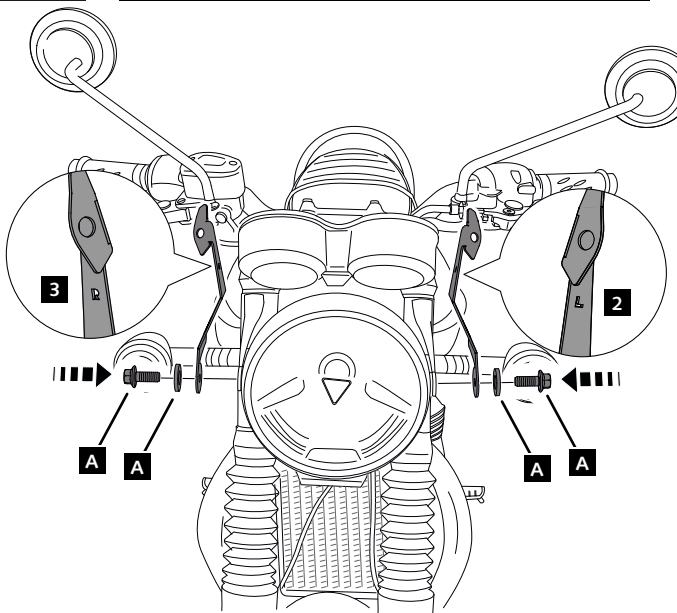

TRIUMPH BONNEVILLE T100/T120/T200/ BONNEVILLE BOBBER / STREET TWIN / STREET CUP

MOUNTING INSTRUCTIONS

3

ASSEMBLY

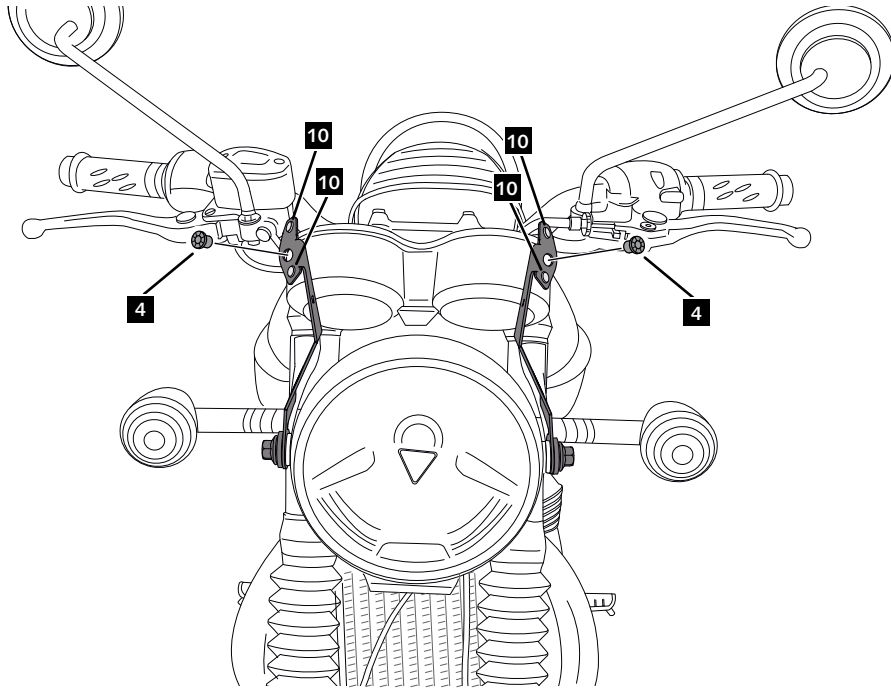

4

ASSEMBLY

ALUMINUM

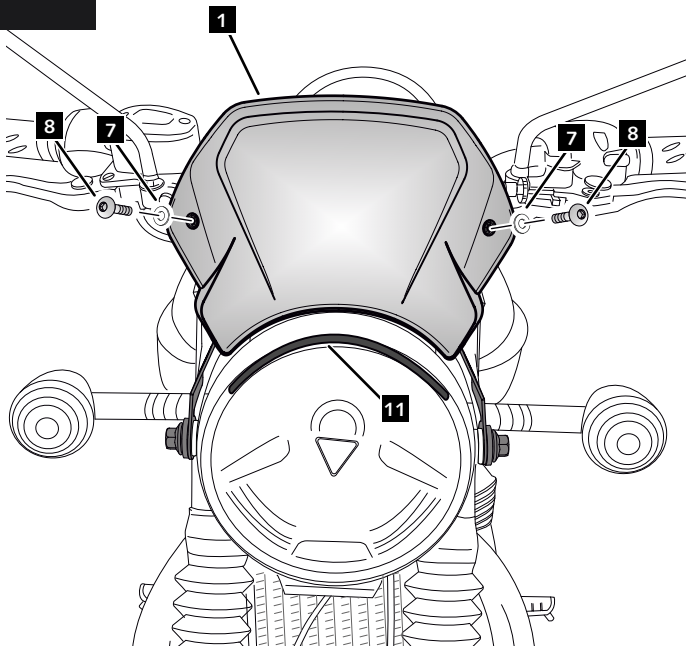

ABS

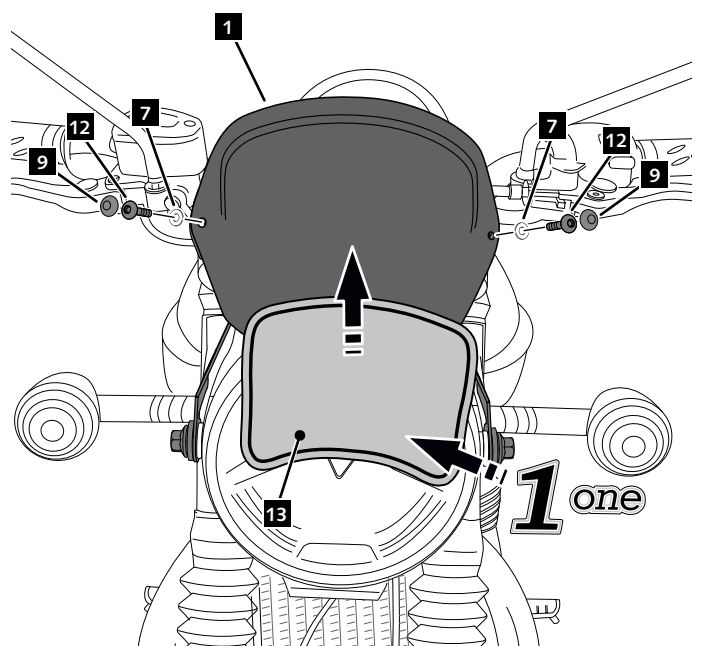

ID13 ONLY SUPPLIED WITH ABS FRONT PLATE