

HONDA CB1000R '18- / CB650R '19-









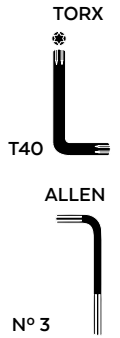

REF 9803

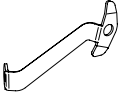
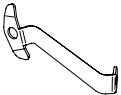
**ALUMINUM
FRONT PLATE**

REF 9768

**ABS
FRONT PLATE**



| ID. | PART | DESCRIPTION | QTY. | REF.: |
|-----|---|---|------|-----------------|
| 1 |  | ABS front plate | 1 | 10526J/C |
| |  | Al front plate | | 9807P/N |
| 2 |  | Left support | 1 | SOPOR-2P-2-9768 |
| 3 |  | Right support | 1 | SOPOR-2P-2-9768 |
| 4 |  | M5 silentblock | 2 | SILENBTM5-046/1 |
| 5 |  | M5x1 nylon washer | 2 | ARNV0000000245 |
| 6 |  | M5x16 Ø11 ISO 7380 allen screw (INOX) | 2 | TORNI-IA----423 |
| 7 |  | M5 screw cap | 2 | TAPON-----85 |
| 8 |  | Ø8 x2 silicon spacers (Applied) | 4 | ADHESI-GT-D8--- |
| 9 |  | Self-adhesive trim lenth 190mm, 6,2mm x 2,6mm <small>*ONLY FOR ALUMINUM FRONT PLATE (REF:9807)</small> | 1 | RIBETETP---0900 |
| 10 |  | M5x16 Ø11 ISO 7380 allen screw | 2 | TORNI-I7380-493 |
| 11 |  | Stickers set | 1 | 10535 |

HONDA CB1000R '18- / CB650R '19-

- MOUNTING INSTRUCTIONS

1

DISASSEMBLY

A Original screws

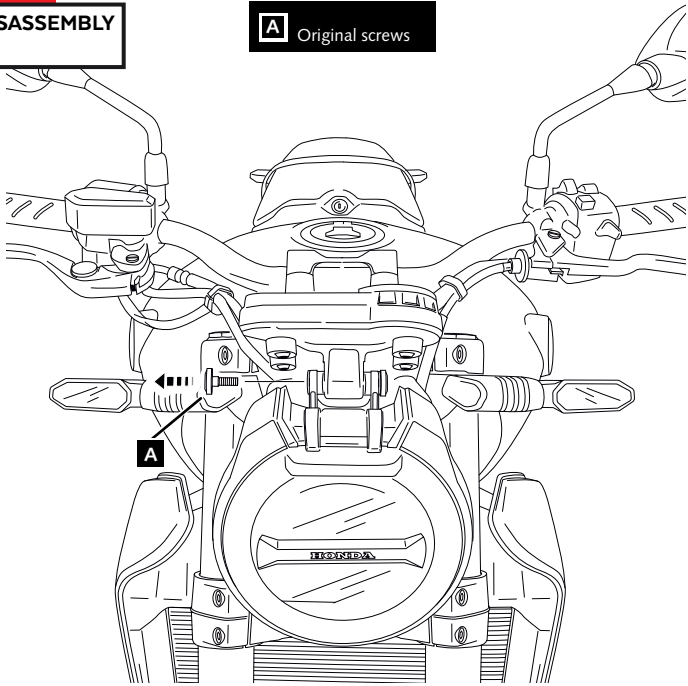

2

ASSEMBLY

A Original screws

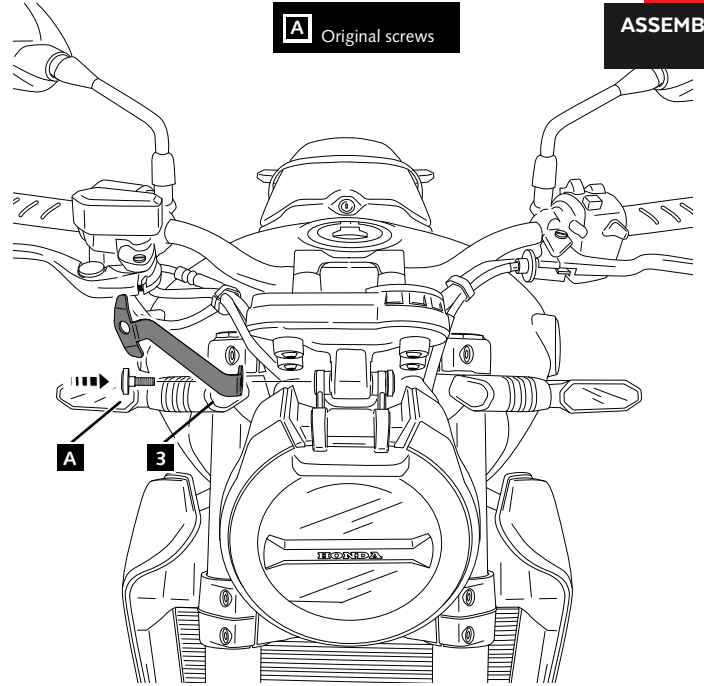

3

DISASSEMBLY

A Original screws

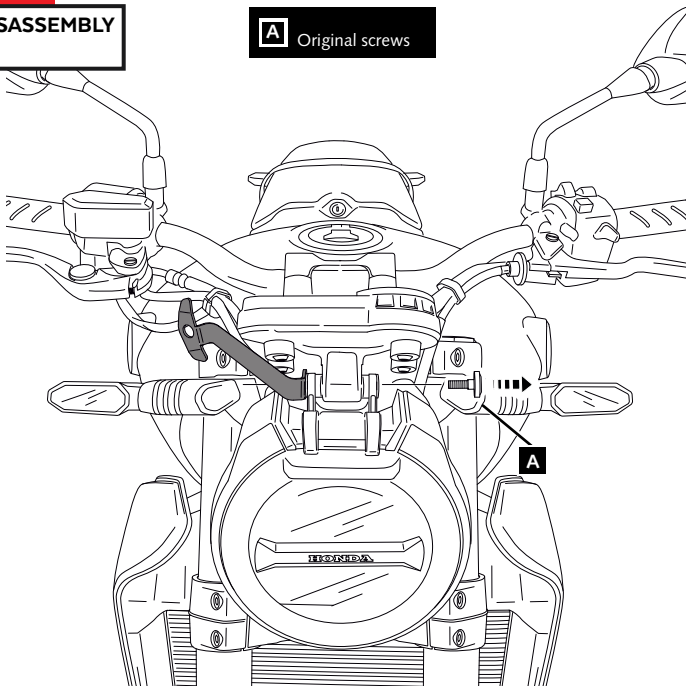

4

ASSEMBLY

A Original screws

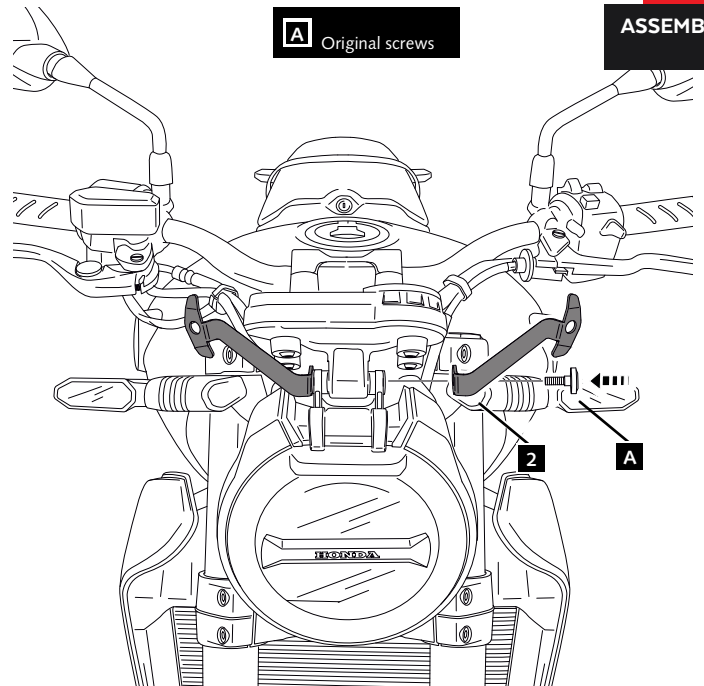

HONDA CB1000R '18- / CB650R '19-

MOUNTING INSTRUCTIONS

5

ASSEMBLY

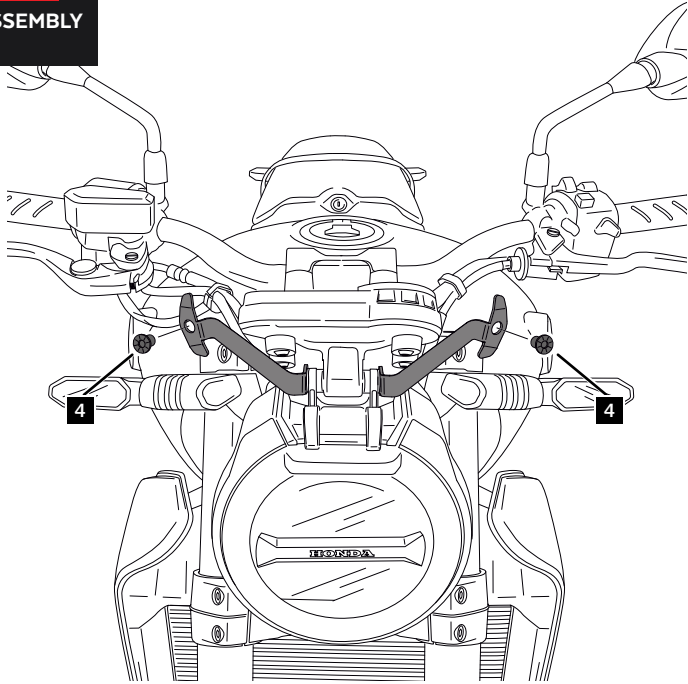

6

ASSEMBLY

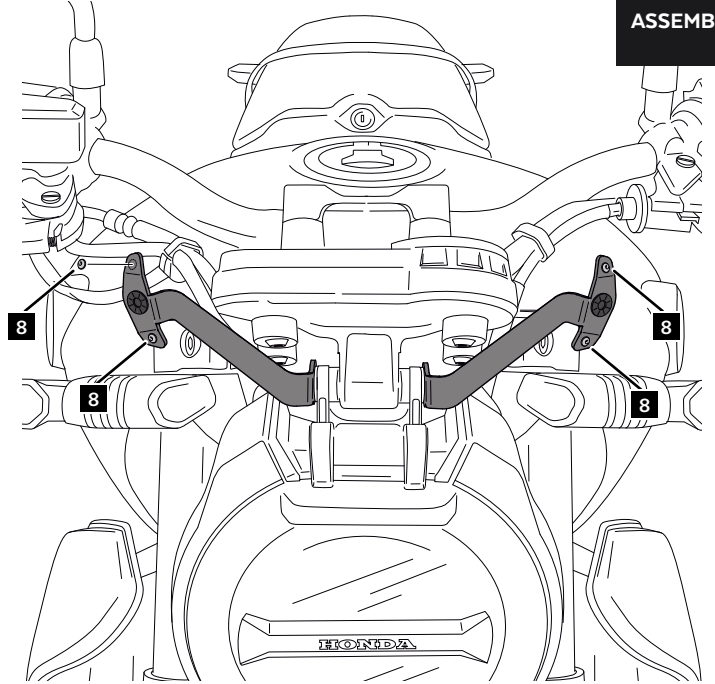

7

ASSEMBLY

ALUMINUM

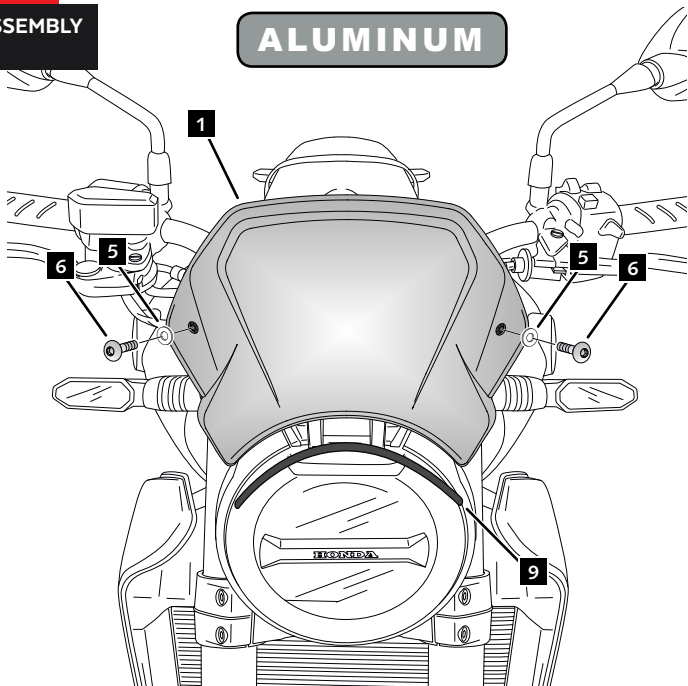

8

ASSEMBLY

ABS

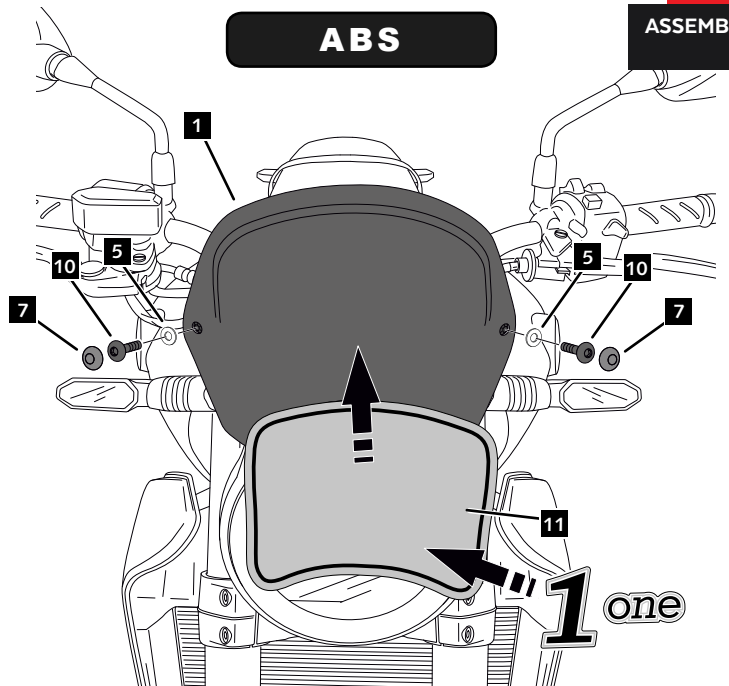

ID11 ONLY SUPPLIED WITH ABS FRONT PLATE