

# HONDA CB1000R '18

REF 9786N

LICENSE SUPORT FOR











1 Person

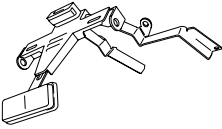

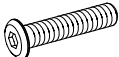
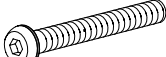
1 hour



INTERMEDIATE

ID.	PART	DESCRIPTION	QTY.	REF.:
1		License support	1	CONJUNTO--9786N
2		Ø13x22 metallic spacer (Black)	2	CASQU449-0-1449
3		Ø18x38 metallic spacer (Black)	2	CASQU450-0-1450
4		M6x40 ISO7380 screw (Black)	2	TORNI-I7380-538
5		M6x55 ISO7380 screw (Black)	2	TORNI-I7380-813
6		M6 DIN9021 washer (Black)	6	ARANDPD9021-037
7		M6 DIN6923 nut (Black)	2	TUERCAEM6G-0213
8		Plastic bridle	5	BRIDAN100X2'5N
9		Back light	1	5577N
10		Reflector	1	4481R

# HONDA CB1000R '18

## MOUNTING INSTRUCTIONS

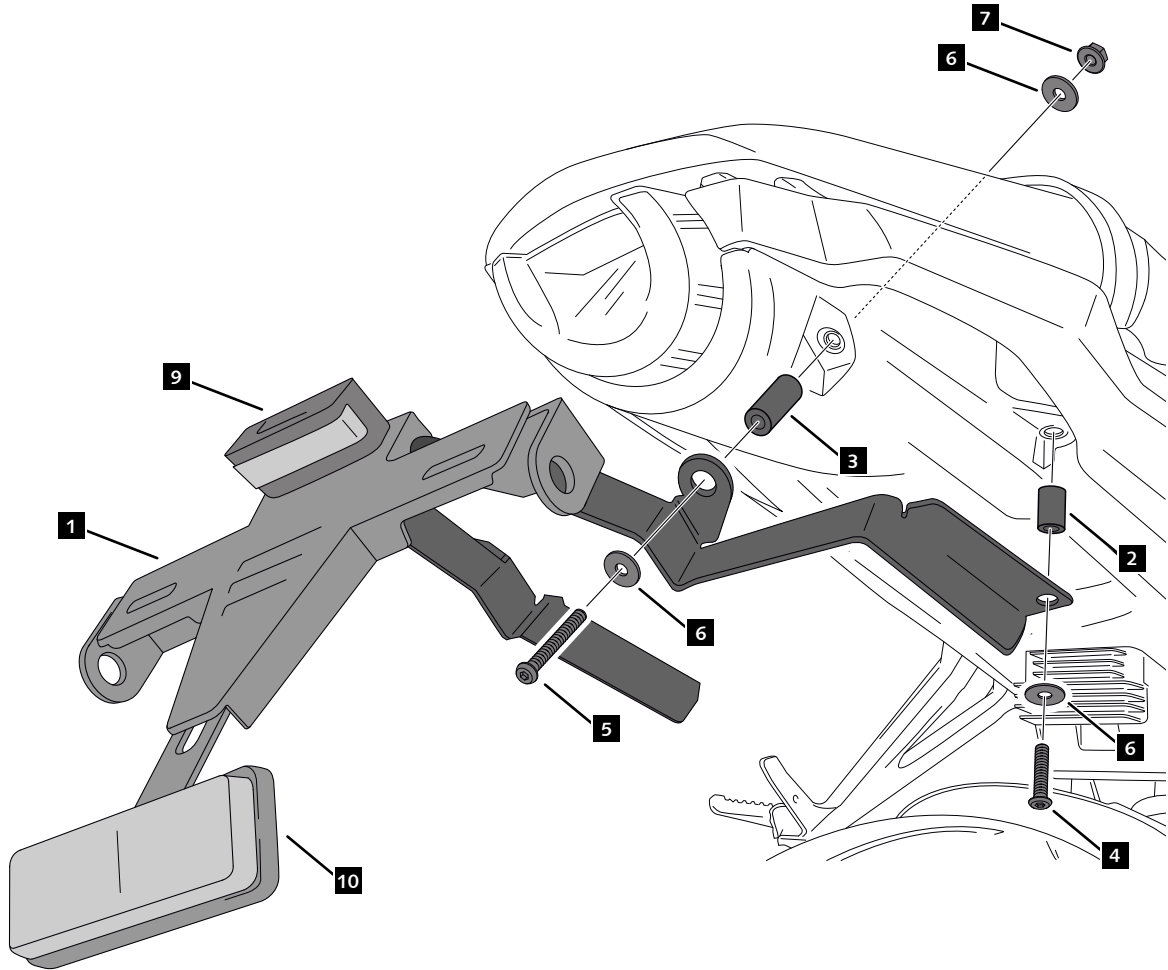

Fixation license support rotation (2 OPTIONS A-B)

