

BMW F750GS / BMW F850GS '18-

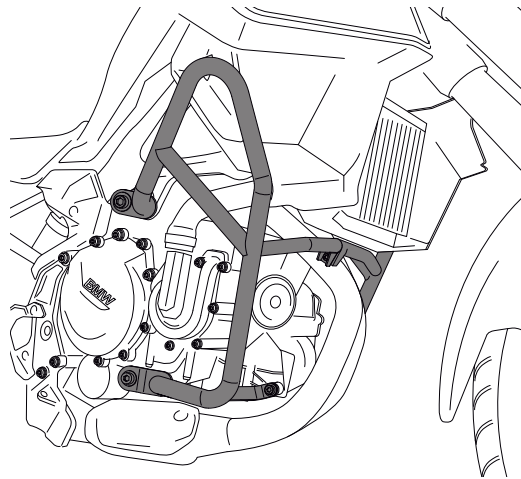









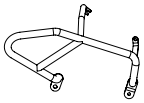
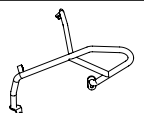
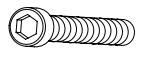
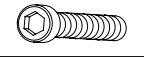

M O U N T I N G I N S T R U C T I O N S

REF 9780N

ENGINE GUARDS



CONSULT OUR WEBSITE THE VIDEO MOUNT AVAILABILITY OF THIS REFERENCE.

ID.	PART	DESCRIPTION	QTY.	REF.:
1		Protector right side	1	DEFENSA-9780N
2		Protector left side	1	DEFENSA-9780N
3		Allen screw M12/175x100 DIN912 (Right)	1	M2TM12175100A9B
4		Allen screw M12/175x90 DIN912 (Left)	1	M2TM12175090A9B
5		Allen screw M10/150x35 DIN912	1	M2TM10150035A9B
6		Allen screw M8x30 DIN912	2	M2TM080125030A8
7		Allen screw M10/150x30 DIN912	1	M2TM10150030A9B
8		Allen screw M6x20 DIN912	1	TORNI-AD912-489
9		Flat washer M12 DIN125/A	2	ARANM12DIN433ZB
10		Flat washer M10 DIN125/A	3	M2AM10DIN125AZB
11		Flat washer M6 DIN125/A	1	M2AM06DIN125AZB
12		Lock nut M10 DIN985	1	TUERCA3985-0132
13		Aluminium spacer Long. 8mm (Black)	1	CASQU453-0-1753
14		Aluminium spacer Long. 48mm (Black)	1	CASQU461-0-1761
15		Flat washer M8 DIN125/A	2	M2AM08DIN125AZB

BMW F750GS / BMW F850GS '18-

MOUNTING INSTRUCTIONS

LEFT SIDE

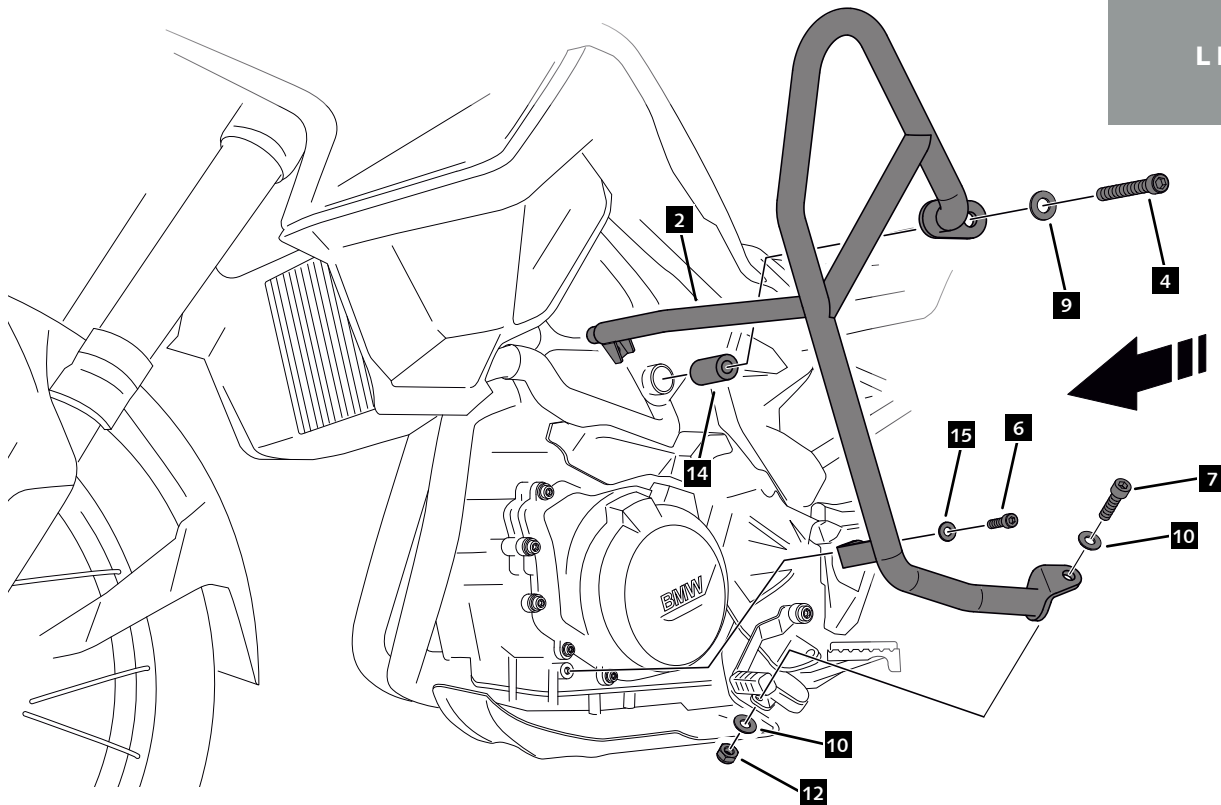

RIGHT SIDE

