

HONDA CB1000R '18- / CB650R '19-









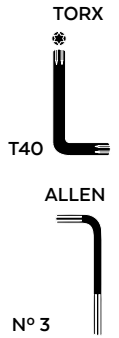

REF 9803

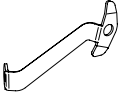
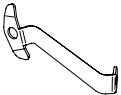
**ALUMINUM
FRONT PLATE**

REF 9768

**ABS
FRONT PLATE**



ID.	PART	DESCRIPTION	QTY.	REF.:
1		ABS front plate	1	10526J/C
		Al front plate		9807P/N
2		Left support	1	SOPOR-2P-2-9768
3		Right support	1	SOPOR-2P-2-9768
4		M5 silentblock	2	SILENBTM5-046/1
5		M5x1 nylon washer	2	ARNV0000000245
6		M5x16 Ø11 ISO 7380 allen screw (INOX)	2	TORNI-IA----423
7		M5 screw cap	2	TAPON-----85
8		Ø8 x2 silicon spacers (Applied)	4	ADHESI-GT-D8---
9		Self-adhesive trim lenth 190mm, 6,2mm x 2,6mm <small>*ONLY FOR ALUMINUM FRONT PLATE (REF:9807)</small>	1	RIBETETP---0900
10		M5x16 Ø11 ISO 7380 allen screw	2	TORNI-I7380-493
11		Stickers set	1	10535

HONDA CB1000R '18- / CB650R '19-

- MOUNTING INSTRUCTIONS

1

DISASSEMBLY

A Original screws

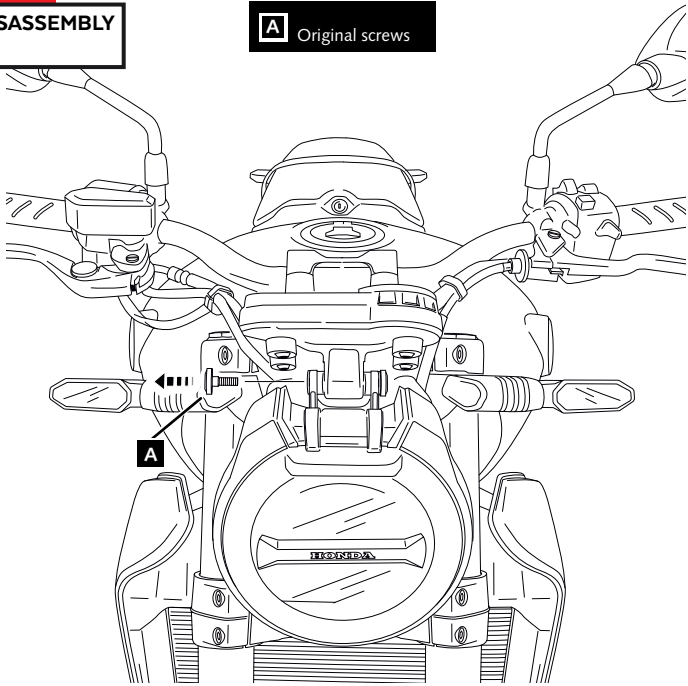

2

ASSEMBLY

A Original screws

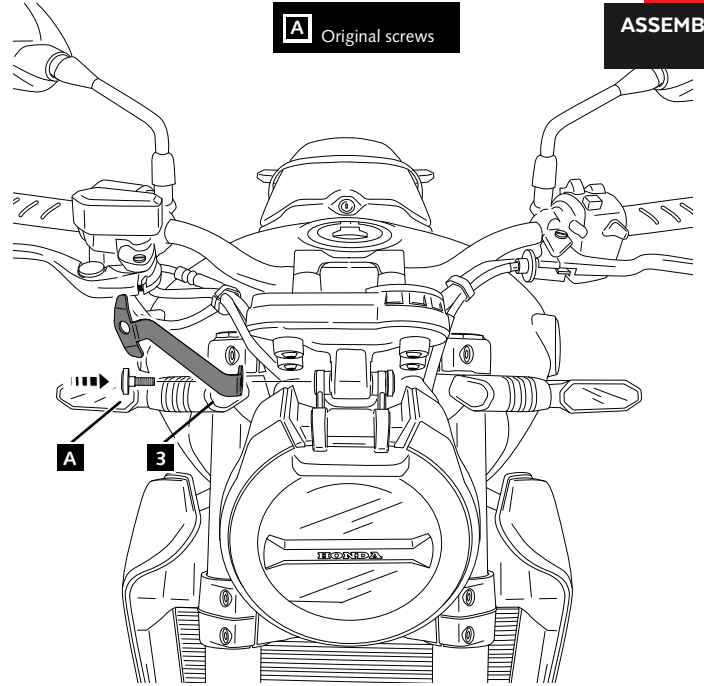

3

DISASSEMBLY

A Original screws

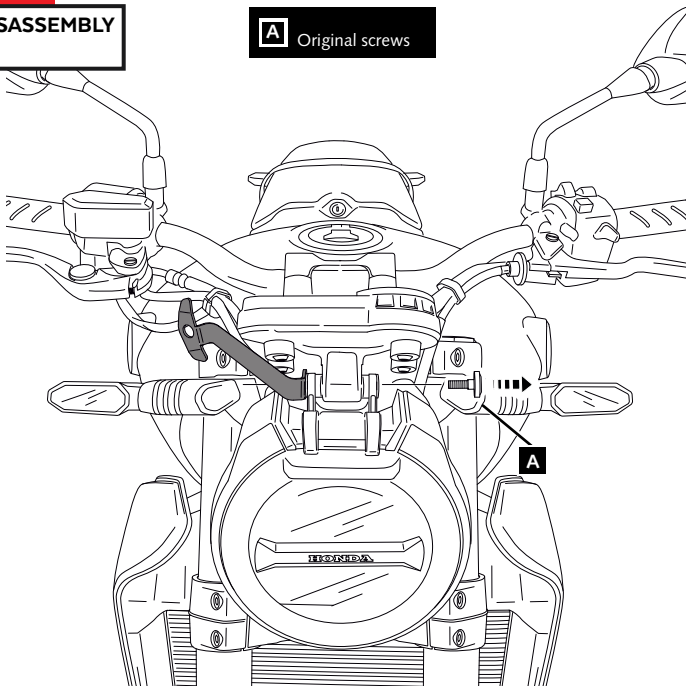

4

ASSEMBLY

A Original screws

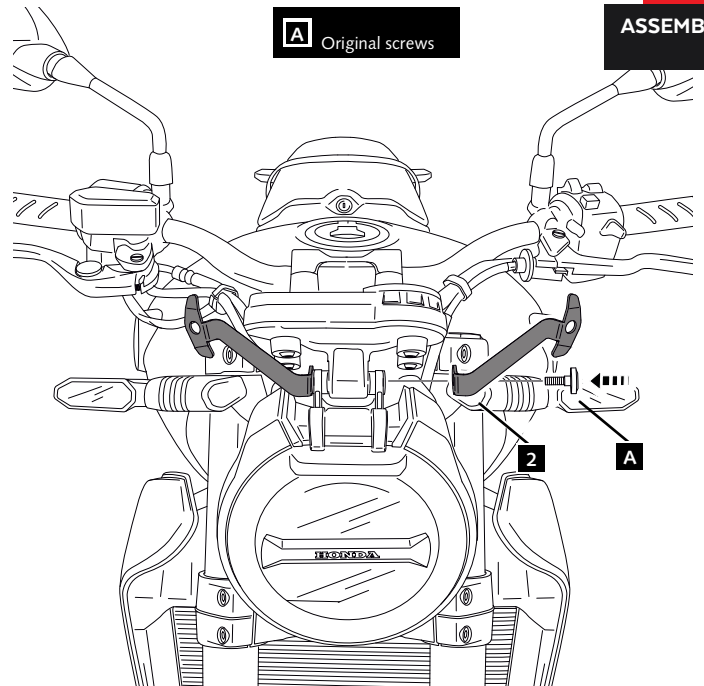

HONDA CB1000R '18- / CB650R '19-

MOUNTING INSTRUCTIONS

5

ASSEMBLY

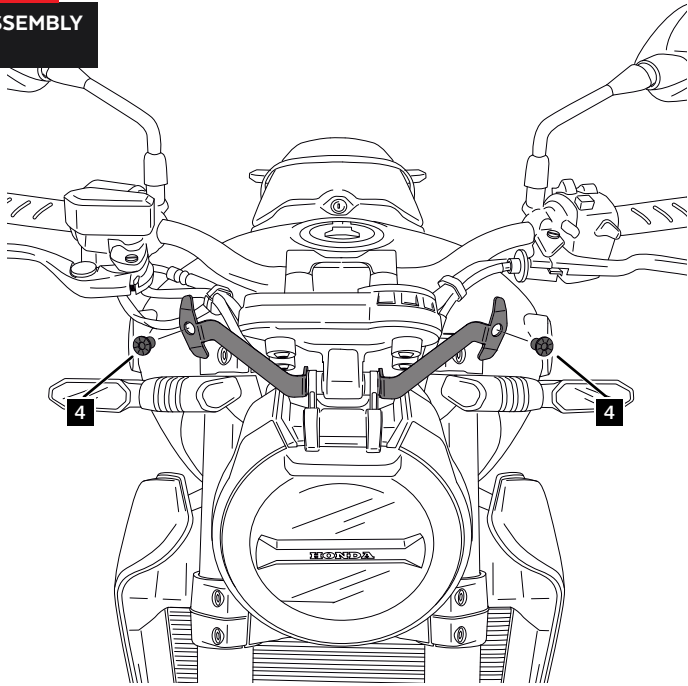

6

ASSEMBLY

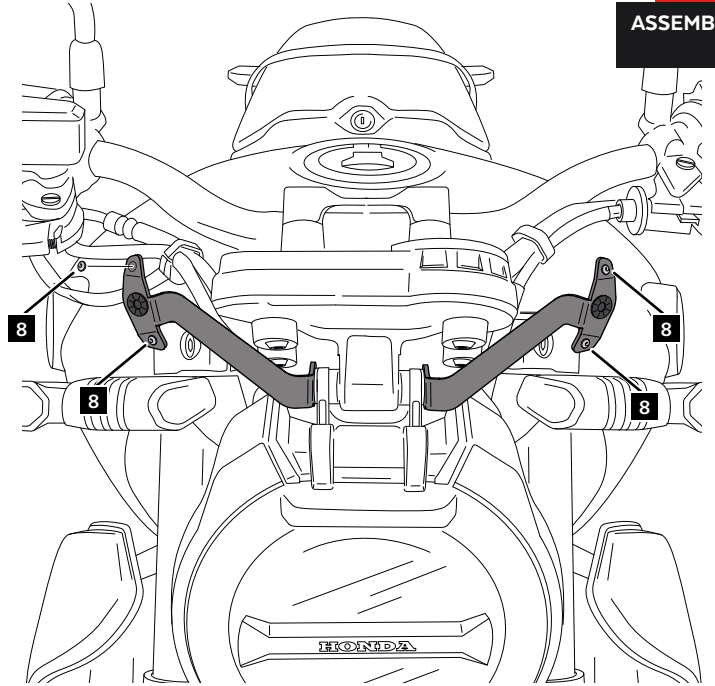

7

ASSEMBLY

ALUMINUM

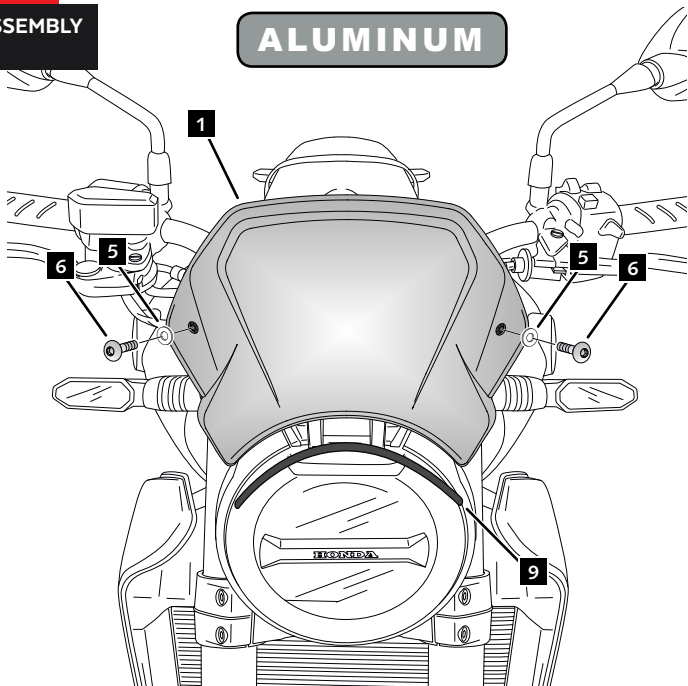

8

ASSEMBLY

ABS

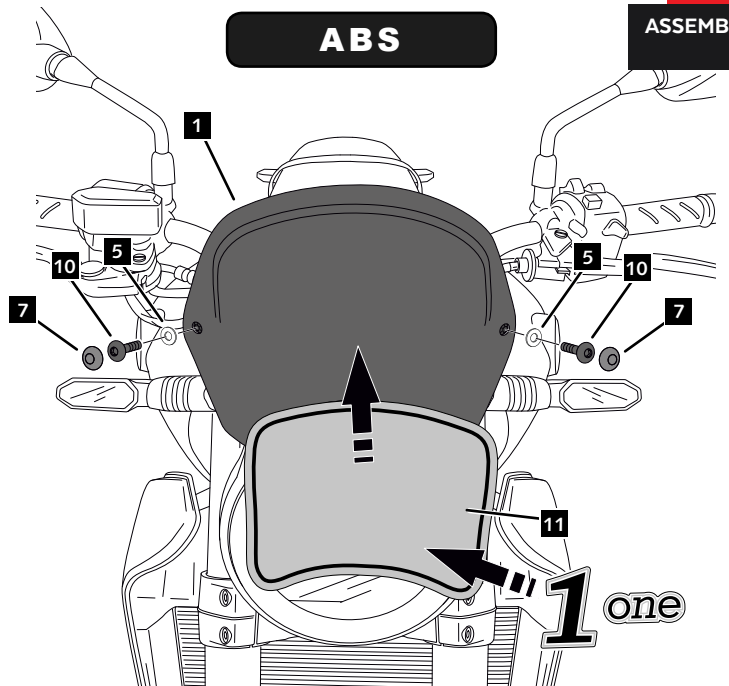

ID11 ONLY SUPPLIED WITH ABS FRONT PLATE