

9725F +105 mm/+4,13 in

9725H +105 mm/+4,13 in

OEM

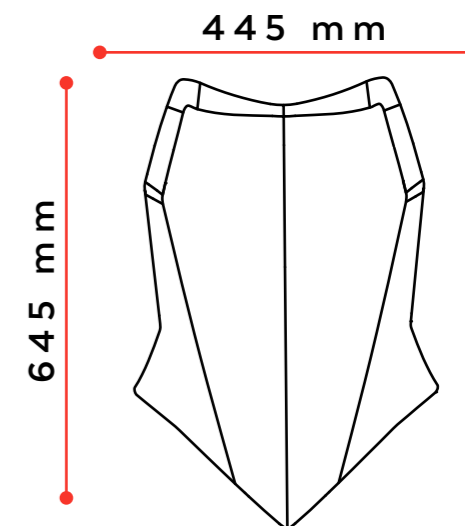

9725F +105 mm/+4,13 in

9725H +105 mm/+4,13 in

OEM

