

ELECTRONIC REGULABLE SYSTEM (E.R.S.)

BMW R1200GS LC '13-'18 / RALLYE '17-'18 / EXCLUSIVE '17-'18 / ADVENTURE '13-'18

REF 9718

UPPER POSITION



PLUG&PLAY



LOWER POSITION

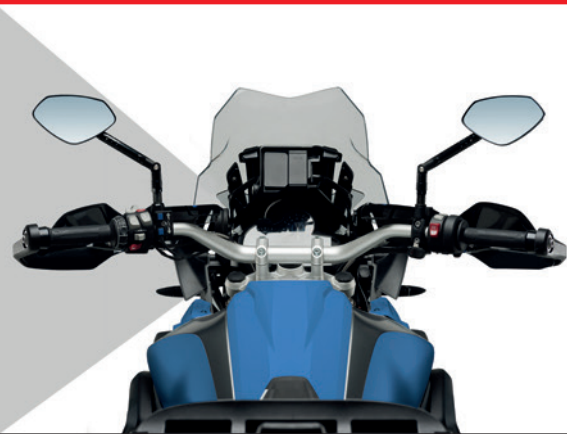











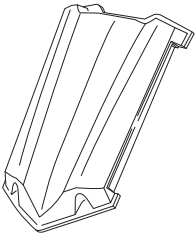
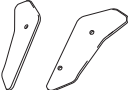

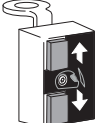
MOUNTING INSTRUCTIONS

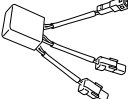

ELECTRONIC REGULABLE SYSTEM (E.R.S.)

BMW R1200GS LC '13-'18 / RALLYE '17-'18 / EXCLUSIVE '17-'18 / ADVENTURE '13-'18

REF 9718

ID	PART	DESCRIPTION	QTY	REF
1		ERS box	1	9718
2		Deflectors	1	9718
3		Screen supports	1	9718
4		Box switch + support	1	9718
5		12V Socket support	1	9718
6		Intensity box limiter	1	9718
7		BMW power cable	1	9718
8		M5x11 Ø11 ISO7380 Allen screw	4	TORNI-AI----520
9		Ø12xØ6x9 Silentblock	4	AROPASACABLES-1
10		Ø12xØ6,8x7,3 bush with flange	4	CASQUI-1A---750
11		M5 ISO 7380 screw cap	4	TAPON-----85
12		M5x10 DIN7991 Allen screw	4	TORNI-D7991-808
13		M6x20 Ø14 ISO7380 Allen screw	3	TORNI-I7380-404

EXPLOTING

REF 9718



1 Person



60 min



MEDIUM

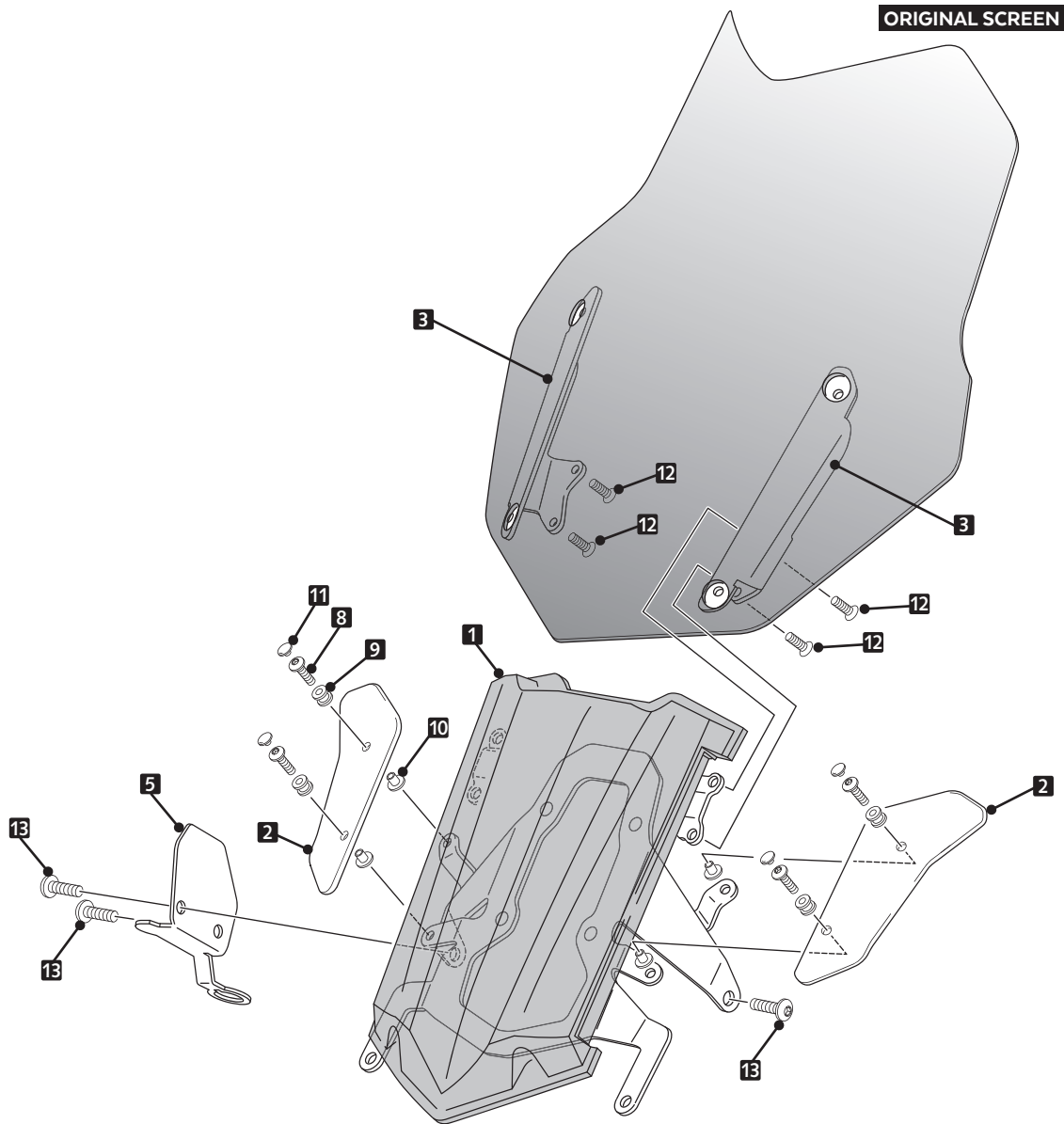

TOOLS

ALLEN
N° 3
N° 4



TORX
N° T25
N° T30
N° T40



FIX
N° 10
N° 14
N° 22



FLAT
SCREWDRIVER



CUTTING
PLIERS



LONG NOSE
PLIERS



WIRING DIAGRAM

REF 9718

