

HONDA CB125R '18- / CB300R '18-









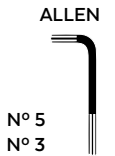

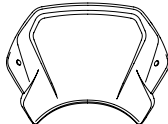

REF 9802

**ALUMINUM
FRONT PLATE**

REF 9663

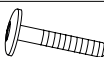
**ABS
FRONT PLATE**

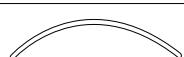

ID.	PART	DESCRIPTION	QTY.	REF.:
1		ABS front plate	1	10526J/C
		ALUMINUM front plate		9807P/N
2		Right metal support	1	SOPOR-2P-3-9663
3		Left metal support	1	SOPOR-2P-3-9663
4		M5 silentblock	2	SILENBTM5-046/1
5		M5x16 Ø 11 ISO7380 allen screw	2	TORNI-I7380-493
6		M5x16 Ø11 ISO 7380 allen screw (INOX)	2	TORNI-IA----423
7		M5x1 nylon washer	2	ARNV0000000245
8		M5 ISO7380 allen screw cap	2	TAPON-----85
9		M5x40 ISO7380 allen screw	2	TORNI-I7380-774
10		Ø8,5xØ14x22 arrowhead	2	CASQUI-----150
11		Ø8x2 mm silicone tear (Supplied already mounted on item ID2 & ID3)	4	ADHESI-GT-D8---
12		Selft-autoadhesive trim lenght 190mm 6,2x2,6mm *ONLY FOR ALUMINUM FRONT PLATE (REF:9807)	4	RIBETETP---0900
13		Stickers set	1	10535

HONDA CB125R '18- / CB300R '18-

MOUNTING INSTRUCTIONS

1

DISASSEMBLY

A Original screws

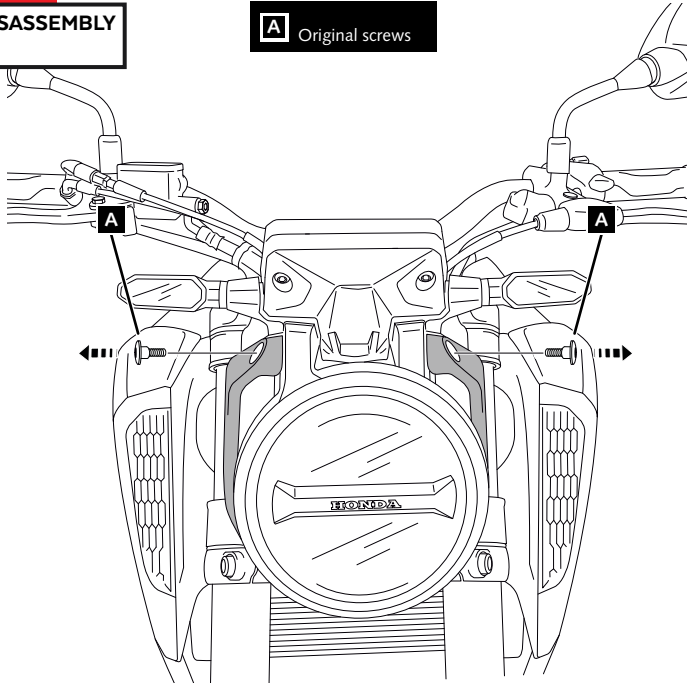

2

ASSEMBLY

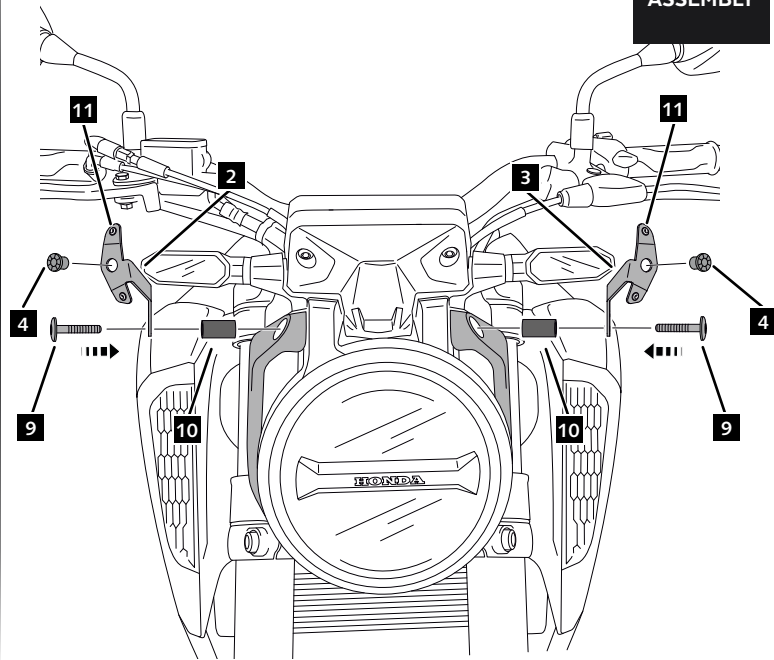

3

ASSEMBLY

ALUMINUM

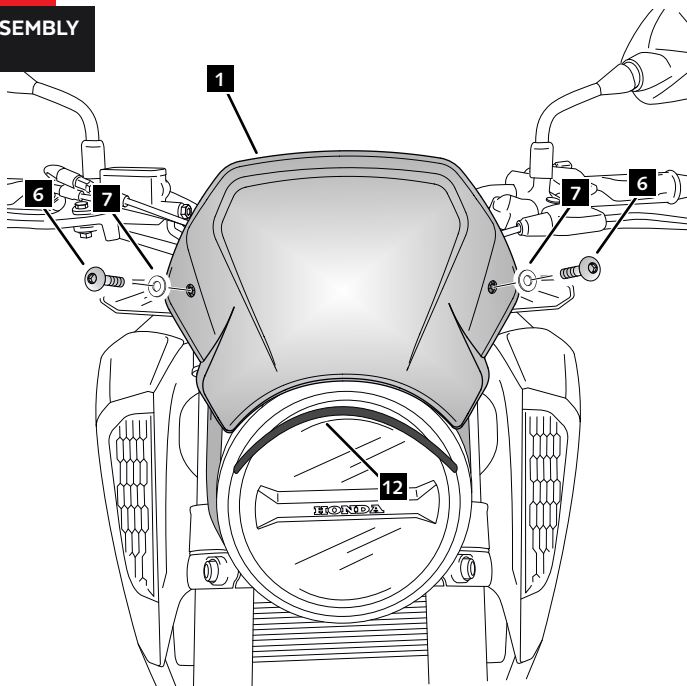

ABS

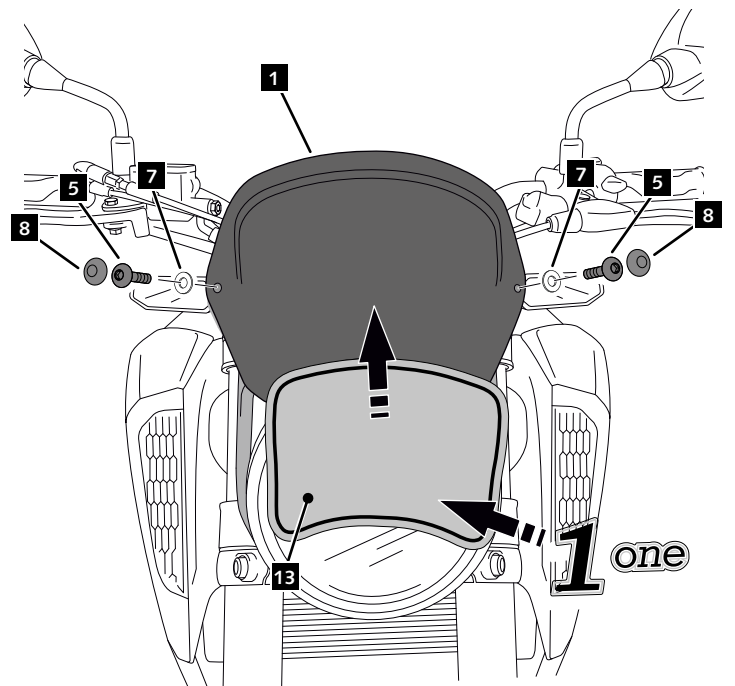

ID13 ONLY SUPPLIED WITH ABS FRONT PLATE