

## SPORT WINDSHIELD FOR YAMAHA MT-09' 17-

Ref.: 9376

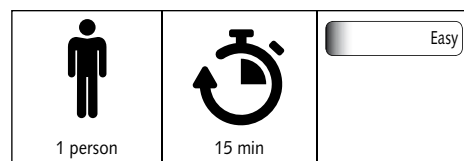

ID.	PIEZA/PART	DESCRIP.	QTY.
1		Sport windshield	1
2		Right metal support (R)	1
3		Left metal support (L)	1
4		M5 silentblock	4
5		M5x1mm Nylon washer	4
6		M5 ISO 7380 screw cap	4
7		M5x15 Ø11 ISO 7380 Allen screw	4
8		Ø6.2x Ø12x3mm Nylon washer	4
9		M6x20 Ø14 ISO 7380 Allen screw	4
10		M6 ISO 7380 screw cap	4

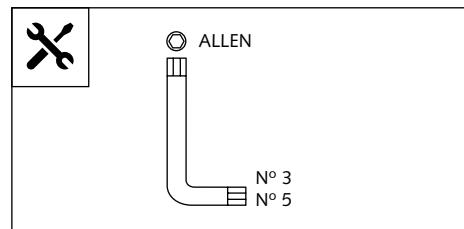
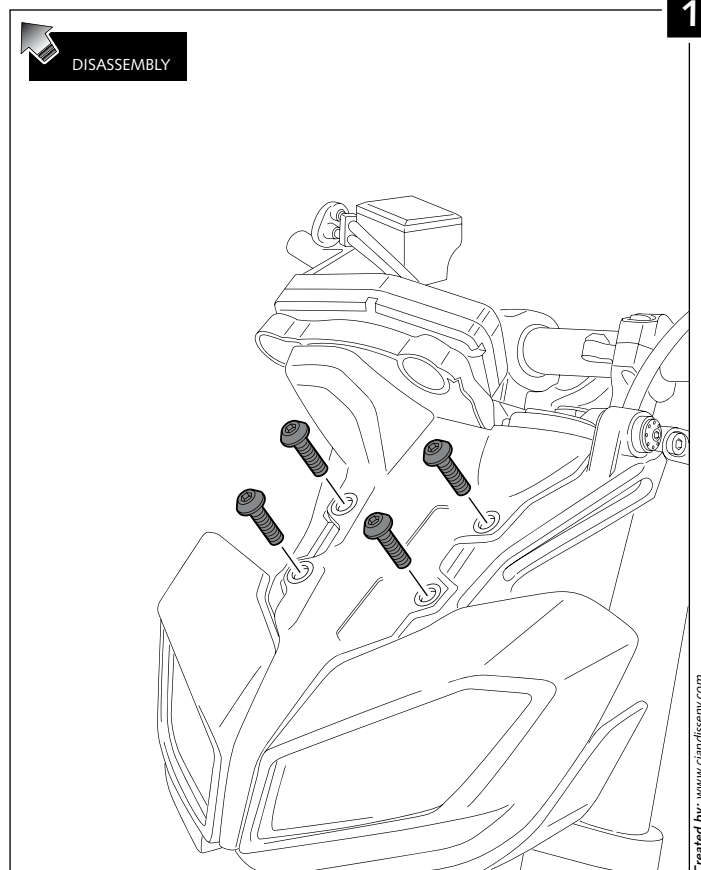

## YAMAHA MT-09' 17-

### MOUNTING INSTRUCTIONS

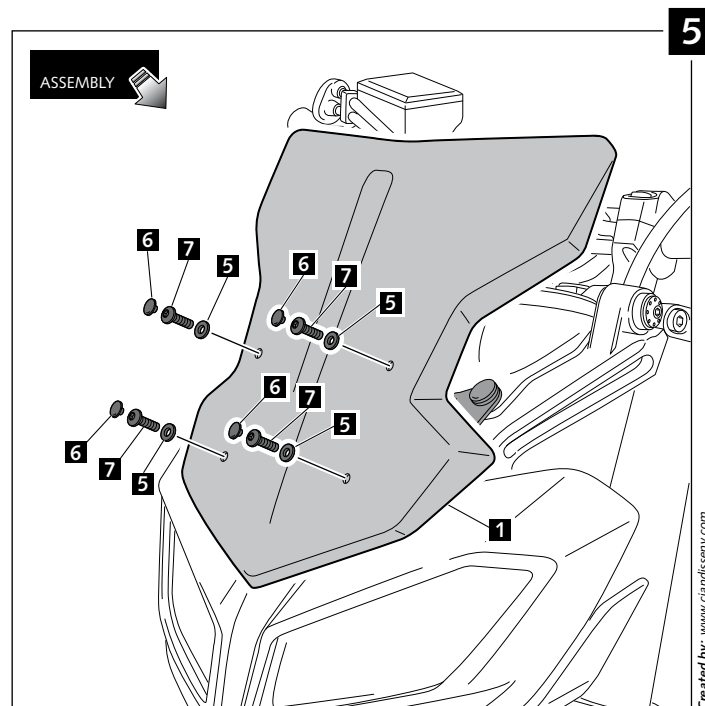
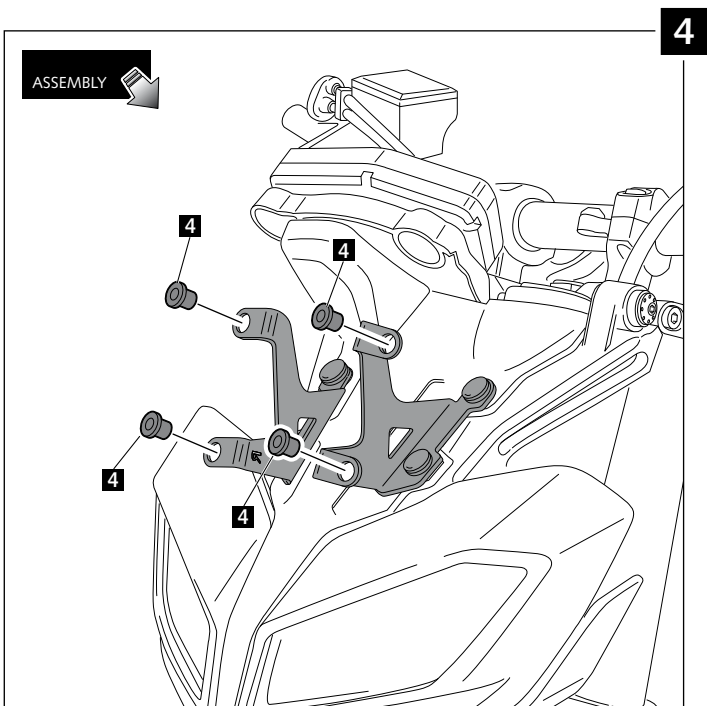
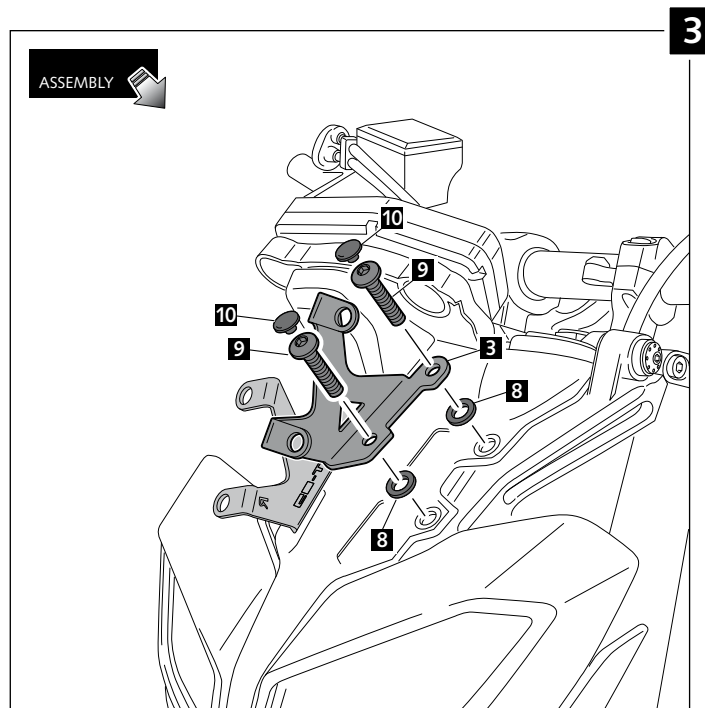
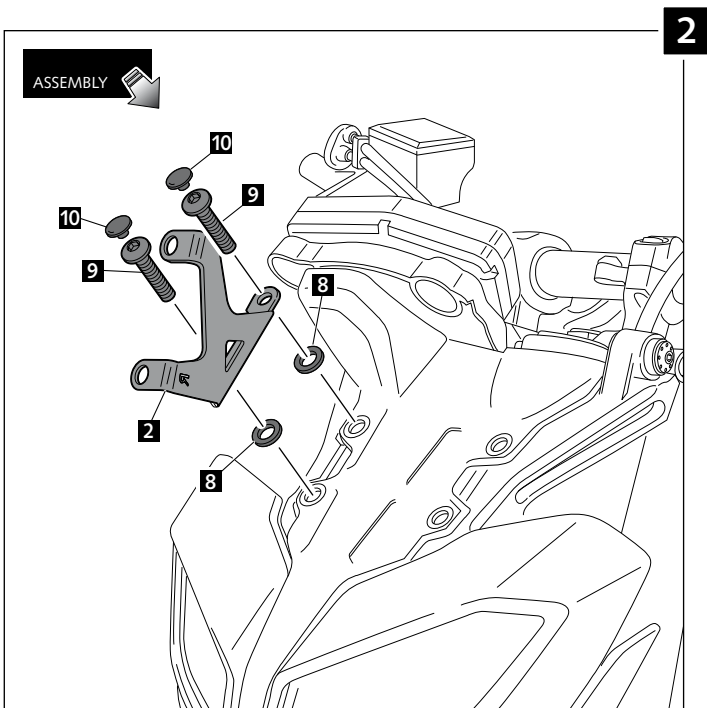

## TIPS FOR A CORRECT WINDSCREEN ASSEMBLY

Due to storage and transport processes of the windscreens, which are subjected to positions and temperature changes out of our control, this may produce small deformations on the material causing some difficulties on the mounting process. It is recommended to:

- 1- Place the screws on one side without tighten all the way.
- 2- Stretch the windscreen to the other side (see Fig. 1). The flexibility of the material allows this stretch with no risk of breaking or cracking.
- 3- Place the screws without tightening all the way.
- 4- Tighten progressively all the screws.

