

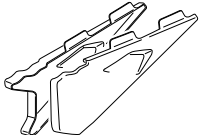





## MOUNTING INSTRUCTIONS

### INFILL PANELS ADAPTABLE TO BMW R1200GS/RALL./EXC. - R1250GS/HP

ID.	PART	DESCRIPTION	QTY.
1		Infill panels	1
2		Right metal support	1
3		Left metal support	1
4		Silemblock Ø inner 9,6 Ø outer 23x9	4
5		M5x16 ISO 7380 Allen screw - Head Ø9mm	2
6		M5 Silemblock	2
7		Self-adhesive black PROFILE PVC 1048 (supplied mounted)	4

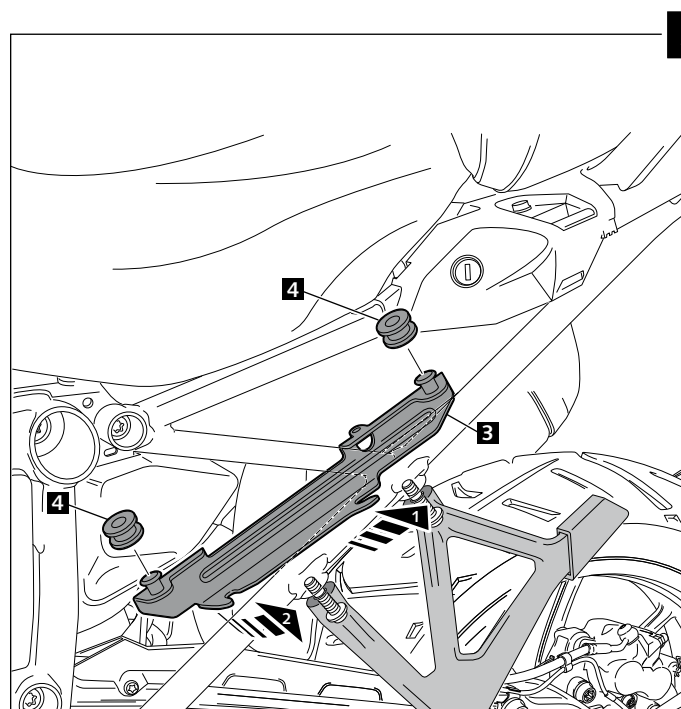
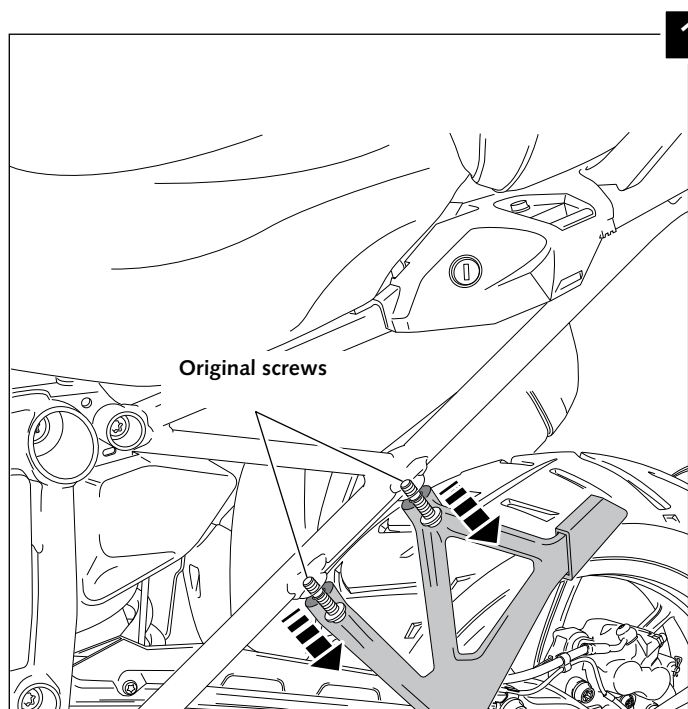

## MOUNTING INSTRUCTIONS

### INFILL PANELS ADAPTABLE TO BMW R1200GS/RALL./EXC. - R1250GS/HP

