

**TRIUMPH BONNEVILLE T100/T120/T200/  
BONNEVILLE BOBBER / STREET TWIN / STREET CUP**









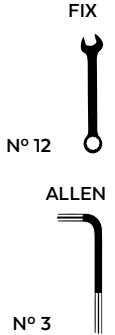

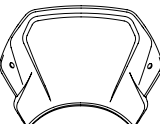
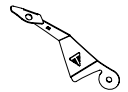
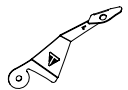
REF 9808

**ALUMINUM  
FRONT PLATE**

REF 9191

**ABS  
FRONT PLATE**



ID.	ART	DESCRIPTION	QTY.	REF.:
1		ABS front plate	1	10526J/C
		ALUMINUM front plate		9807P/N
2		Left support	1	SOPOR-2P-3-9191
3		Right support	1	SOPOR-2P-3-9191
4		M5 silentblock	2	SILENBTM5-046/1
5		Ø8,5 xØ13 x6 spacer	2	CASQUI-----776
6		M8x20 DIN912 allen screw	2	TORNI-D912--164
7		M5x1 nylon washer	2	ARNV0000000245
8		M5x16 Ø11 ISO 7380 allen screw (INOX)	2	TORNI-IA----423
9		M5 screw cap	2	TAPON-----85
10		Ø8 x2 silicon spacers (Supplied mounted with part 1/2)	2	ADHESI-GT-D8---
11		Self-autoadhesive trim lenght 190mm 6,2x2,6mm *ONLY FOR ALUMINUM FRONT PLATE (REF:9807)	4	RIBETETP---0900
12		M5x16 Ø11 ISO 7380 allen screw	1	TORNI-I7380-493
13		Stickers set	1	10535

# TRIUMPH BONNEVILLE T100/T120/T200/ BONNEVILLE BOBBER / STREET TWIN / STREET CUP

## MOUNTING INSTRUCTIONS

**1**

**DISASSEMBLY**

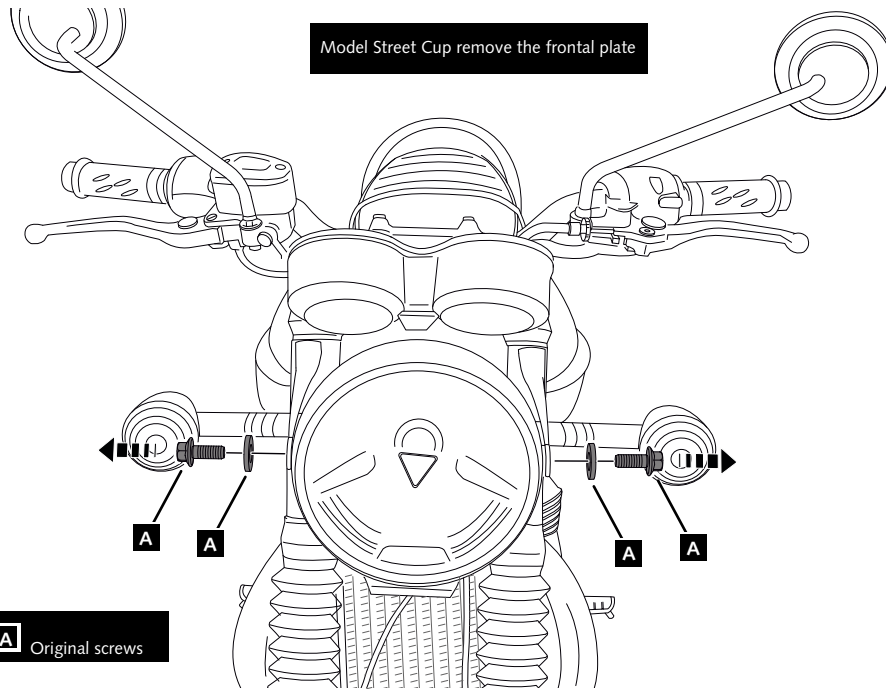

**2**

**ASSEMBLY**

**BONNEVILLE T100 / T120 / T200**

**STREET CUP / STREET TWIN**

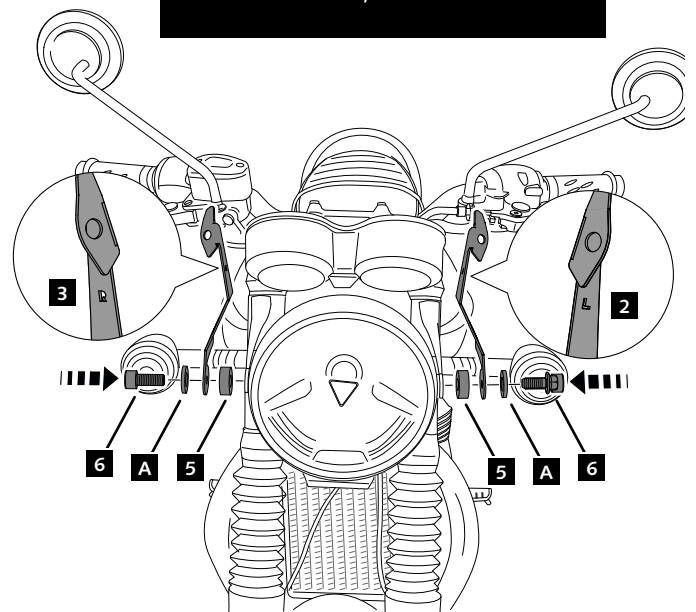
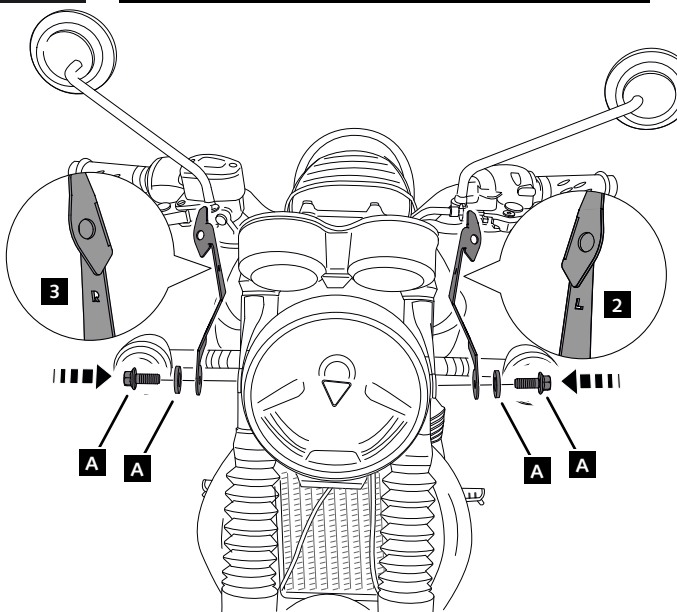

# TRIUMPH BONNEVILLE T100/T120/T200/ BONNEVILLE BOBBER / STREET TWIN / STREET CUP

## MOUNTING INSTRUCTIONS

**3**

ASSEMBLY

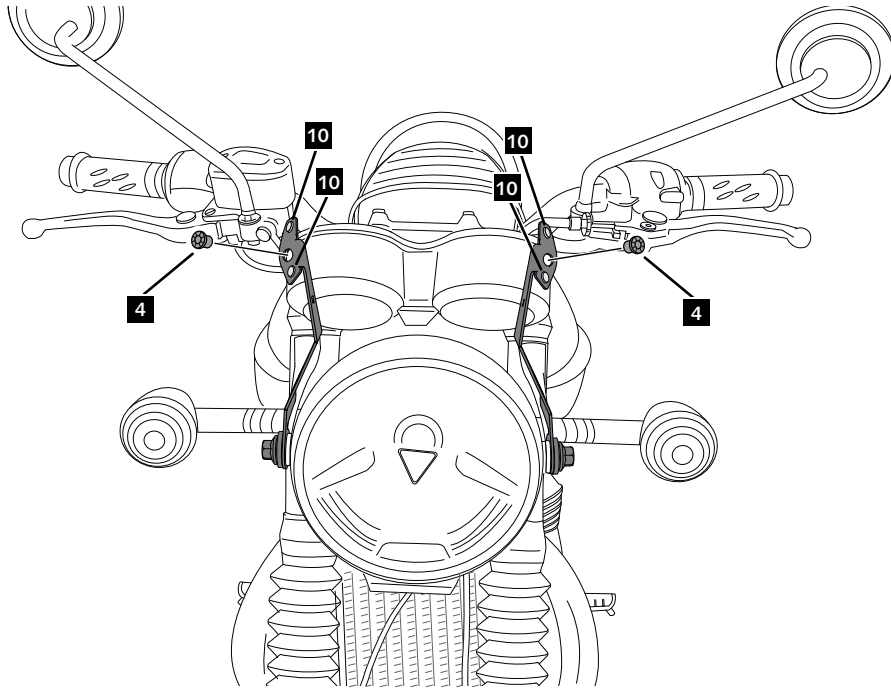

**4**

ASSEMBLY

**ALUMINUM**

**ABS**

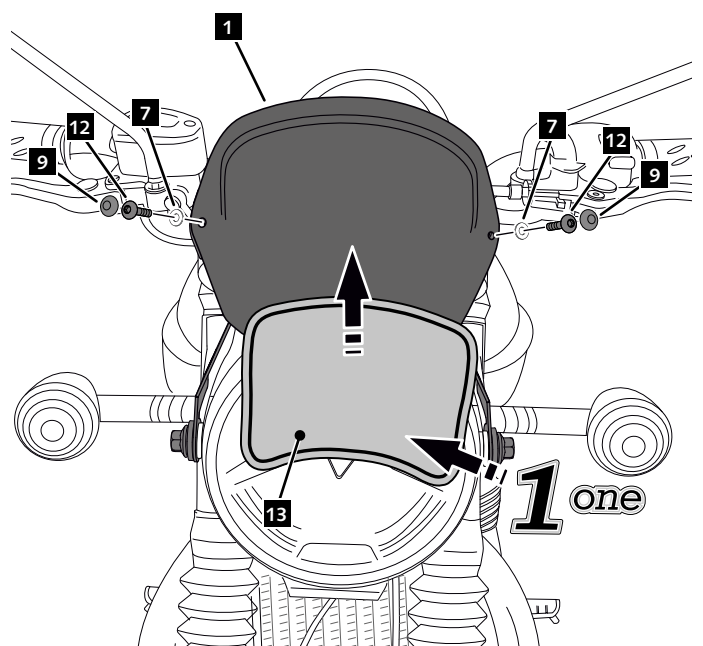
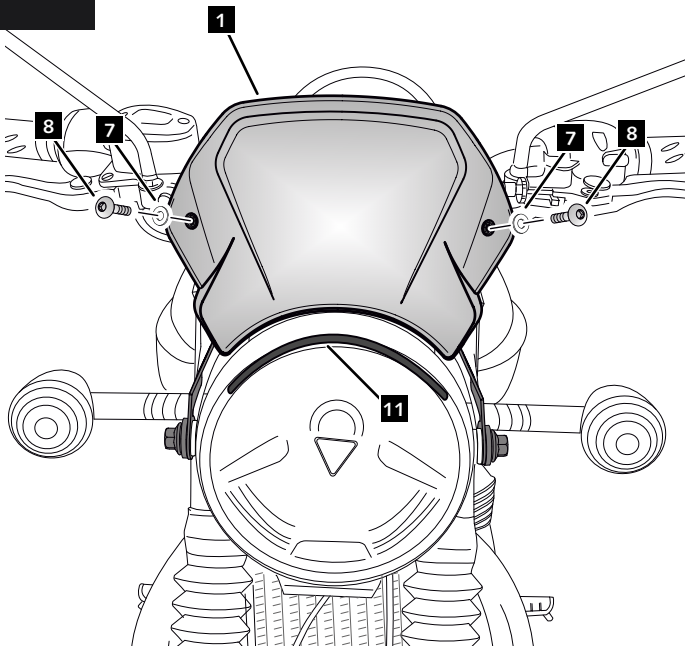

**ID13** ONLY SUPPLIED WITH ABS FRONT PLATE