

HONDA CRF1000L AFRICA TWIN '16-

M O U N T I N G I N S T R U C T I O N S

REF 8948

HANDGUARD EXTENSION



1 Person



20 min



MEDIUM

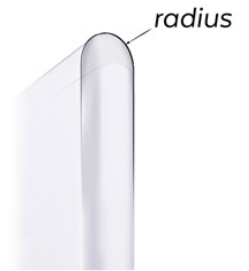









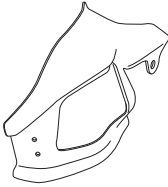

ROUNDED CONTOUR-PROFILE

ALLEN

Nº 2,5
Nº 3
Nº 8



ID	PART	DESCRIPTION	QTY	REF
1		Right handguard extension	1	8948W/H/F/NM3
2		Left handguard extension	1	8948W/H/F/NM3
3		Right upper support	1	SOPOR4P2RS-8948
4		Right side support	1	SOPOR4P2RC-8948
5		Left upper support	1	SOPOR4P2LS-8948
6		Left side support	1	SOPOR4P2LC-8948
7		M4x10 ISO 7380 Allen screw	4	TORNI-I7380-645
8		M4x0,5 nylon washer	4	ARNV00000000311
9		M5x16 Ø11 ISO 7380 Allen screw	2	TORNI-I7380-493
10		M5 silentblock	2	SILENBTM5-046/1
11		M5x1 nylon washer	2	ARNV00000000245

HONDA CRF1000L AFRICA TWIN '16-

- MOUNTING INSTRUCTIONS - M

1

The left side assembly is shown as an example, so the same steps can be performed for the right side assembly.

DISASSEMBLY

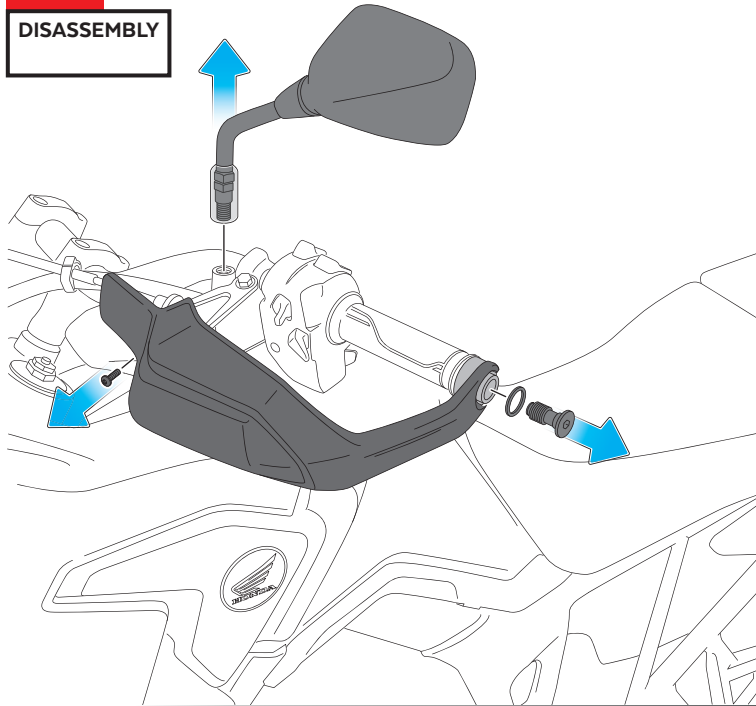

2

ASSEMBLY

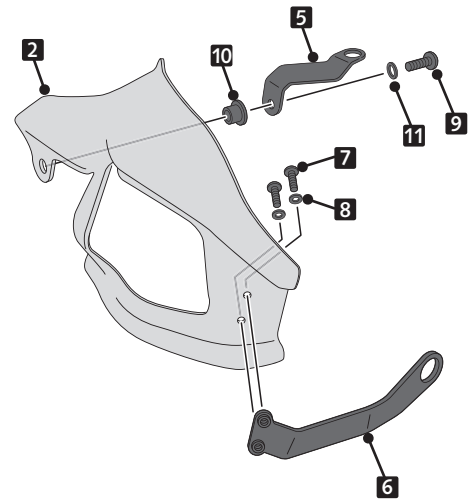

3

DO NOT REMOVE THIS PART

ASSEMBLY

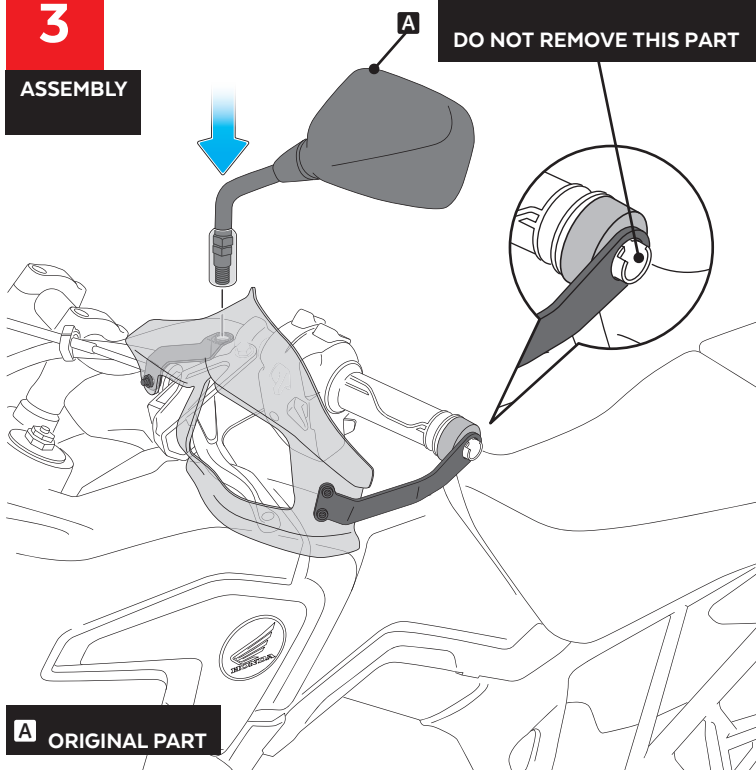

A ORIGINAL PART

4

ASSEMBLY

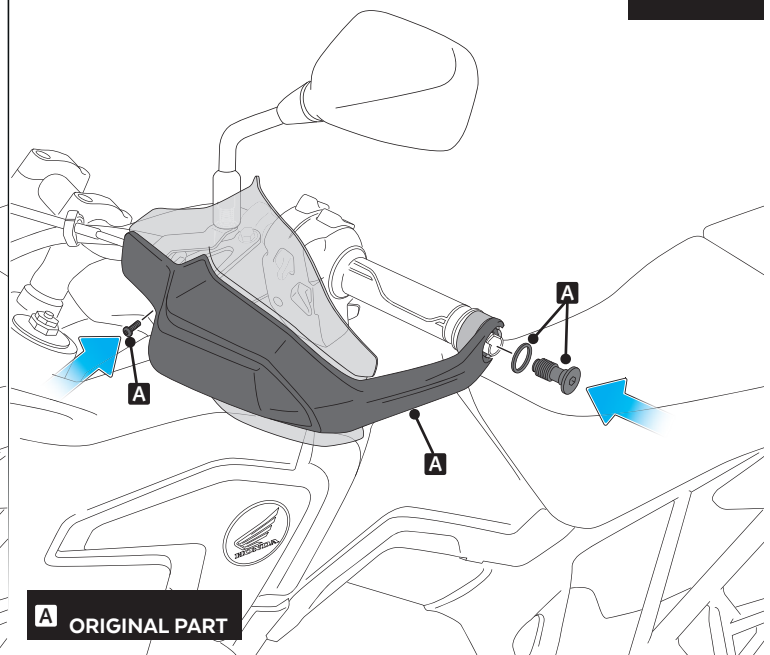

A ORIGINAL PART