

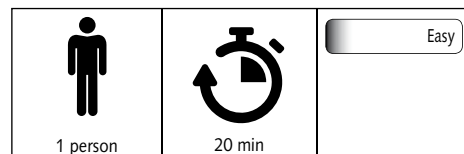

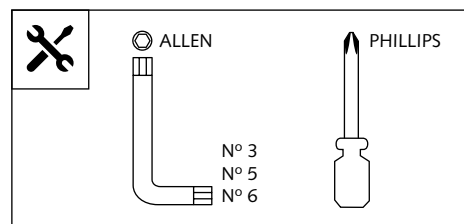





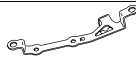
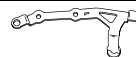

SCREEN FOR YAMAHA MT-10

Ref.: 8918



IS NOT COMPATIBLE WITH THE ORIGINAL YAMAHA HANDGUARD.



ID.	PART	DESCRIPTION	QTY.
1		Touring Screen	1
2		Right metal support	1
3		Left metal support	1
4		M5 Silentblock	4
5		M5X16 Ø11 ISO 7380 Allen screw	4
6		M5x1 nylon washer	4
7		25x10mm hook and loop fastener Dual Lock 3M strip sticker (Supplied mounted)	2
8		M5 ISO 7380 screw cap	2
9		M6 Silentblock	4
10		M6X25 ISO 7380 Allen screw	4

- SCREEN FOR -
YAMAHA MT-10

- MOUNTING INSTRUCTIONS -

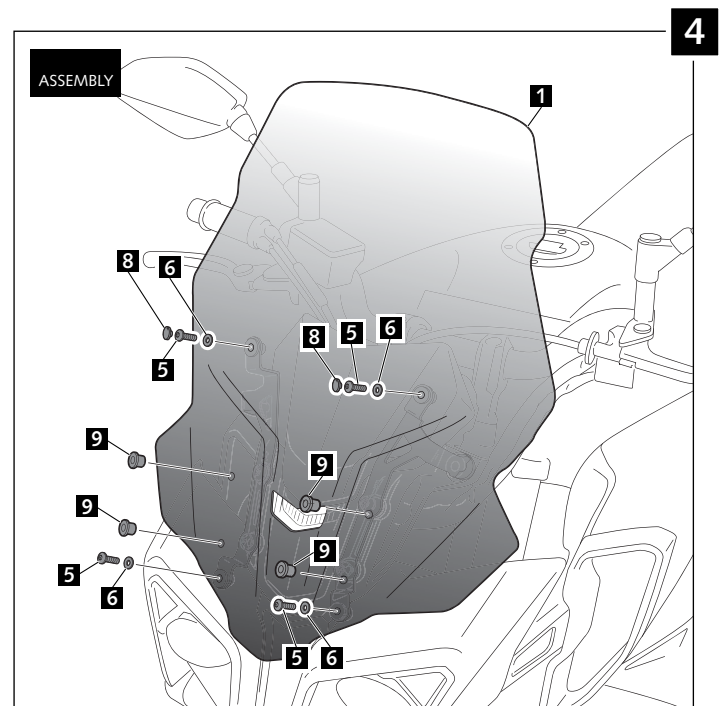
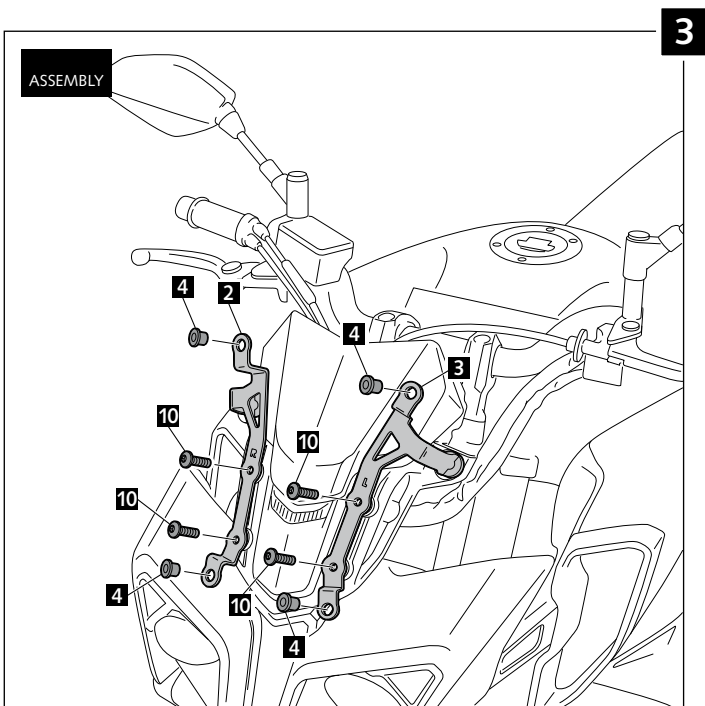
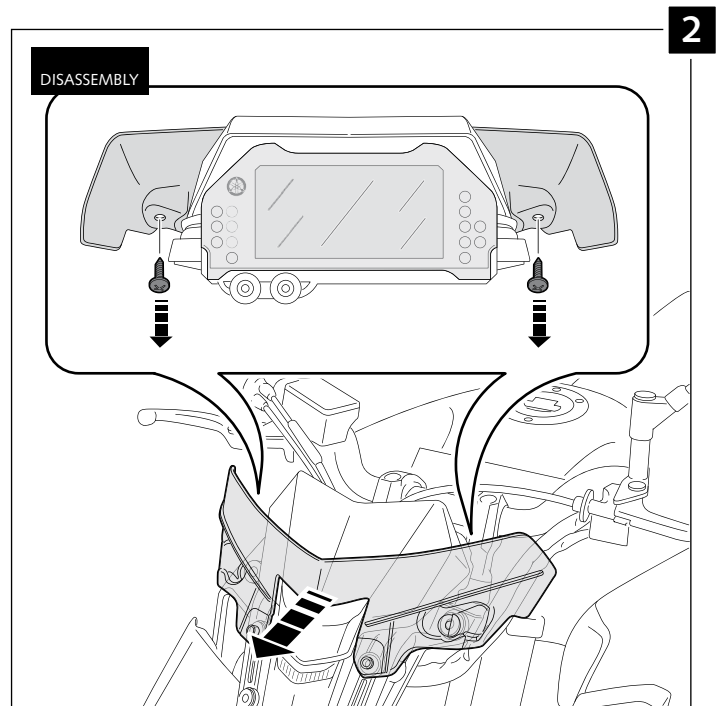
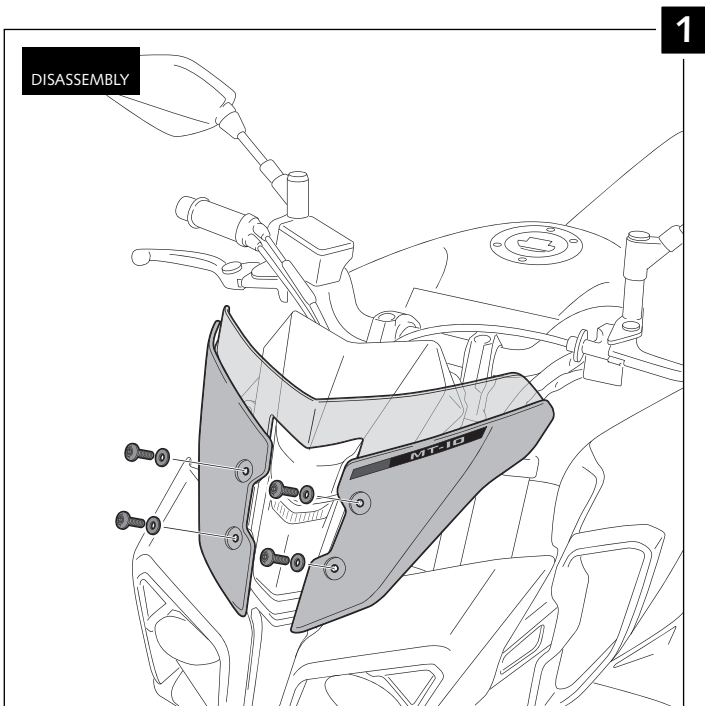

- SCREEN FOR -
YAMAHA MT-10

- MOUNTING INSTRUCTIONS -

