

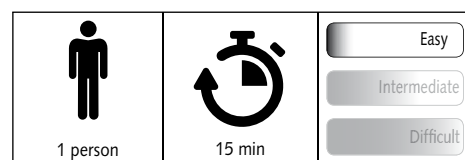

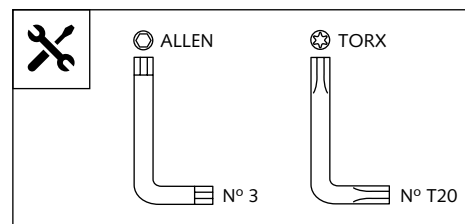

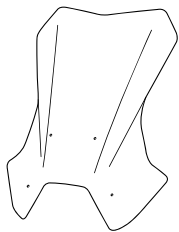



- SCREEN FOR -
KTM SUPERDUKE 1290 GT

Ref.: 8913



ID.	PART	DESCRIPTION	QTY.
1		Touring Screen	1
2		Special screw M5x8 + interior thread M5x17,5 + Hexagon lenght 25mm	2
3		Special screw M5x8 + interior thread M5x8 + Hexagon lenght 10mm	2
4		M5X11 ISO 7380 Allen screw	2
5		M5X16 ISO 7380 Allen screw	2
6		M5x1 nylon washer	4
7		Ø inner 4 x Ø outer 14 x 4 rubber washer	4
8		M5 ISO 7380 screw cap	4

- SCREEN FOR -
KTM SUPERDUKE 1290 GT

MOUNTING INSTRUCTIONS

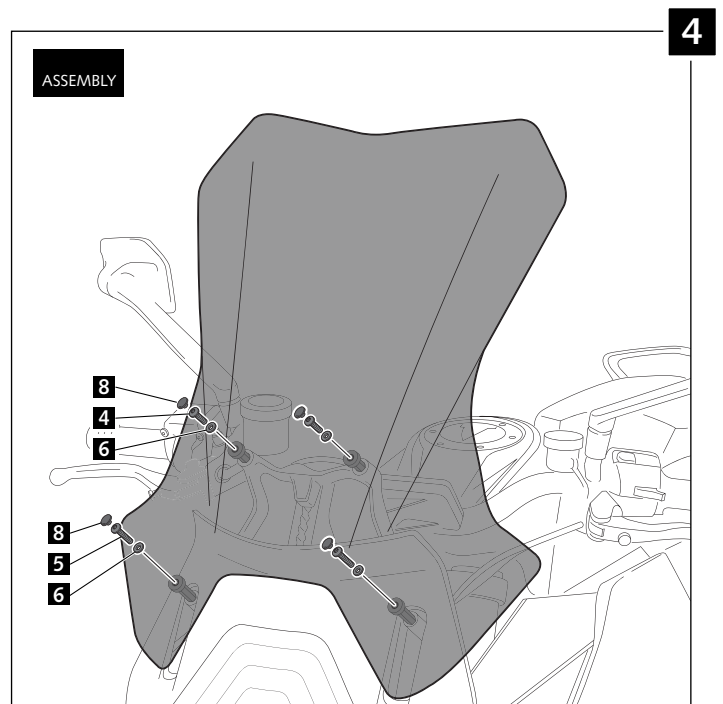
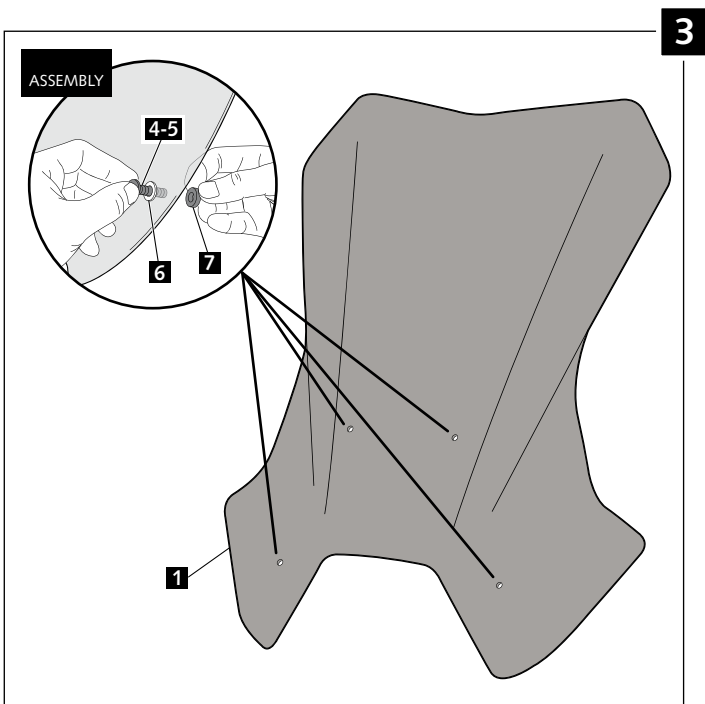
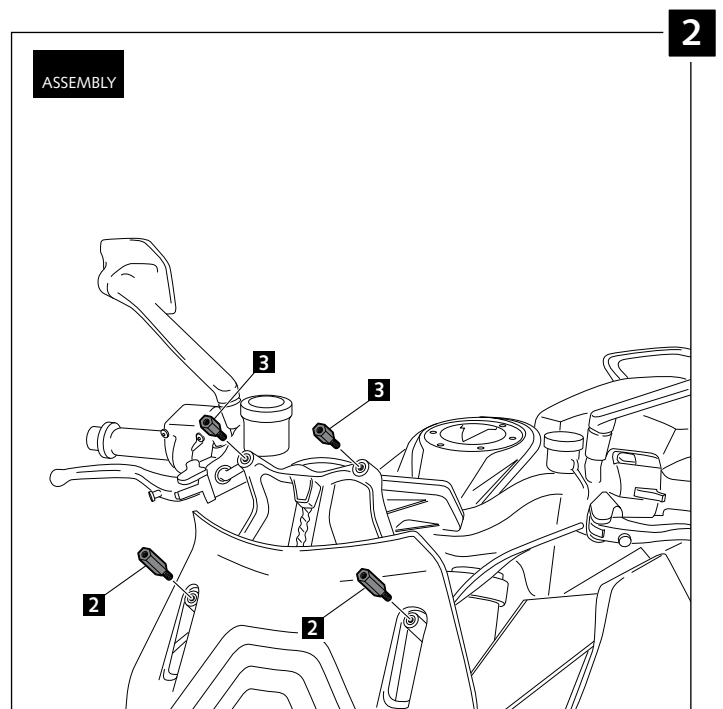
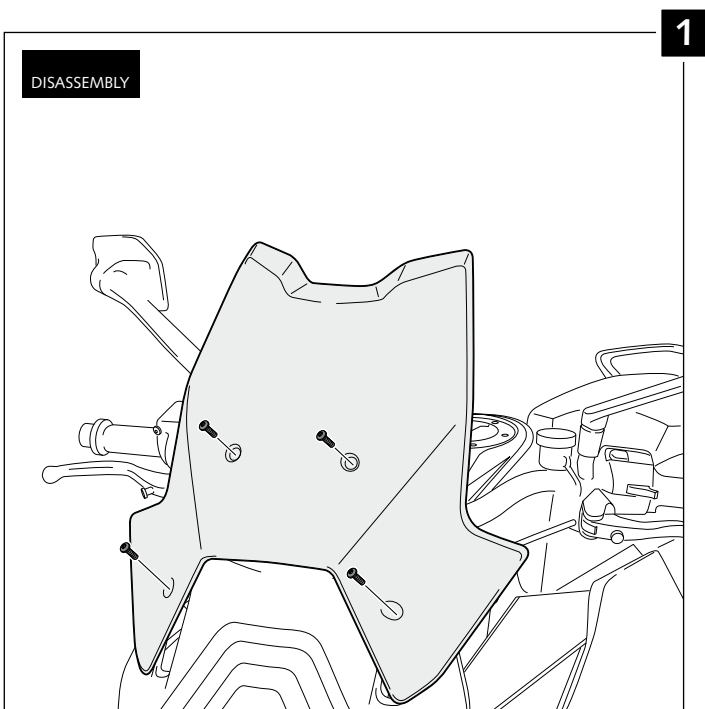

MULTI-ADJUSTABLE VISOR



Ref.: 6007

Ref.: 5852

Ref.: 5853

Smoke

Clear

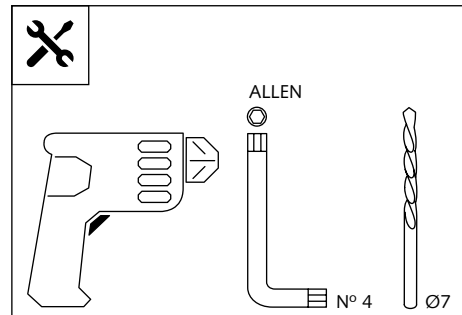

1 person



15 min



Note:

If the visor is supplied along with the windscreen, the windscreen will come factory-drilled so no drilling is necessary.

ID.	PART	DESCRIPTION	QTY.
1		Visor	1
2		Template	1
3		Multi-adjustable mechanism	2
4		Cap	4
5		Plastic thread fastener M6x12	8

MULTI-ADJUSTABLE VISOR

- MOUNTING INSTRUCTIONS -

TYPE A

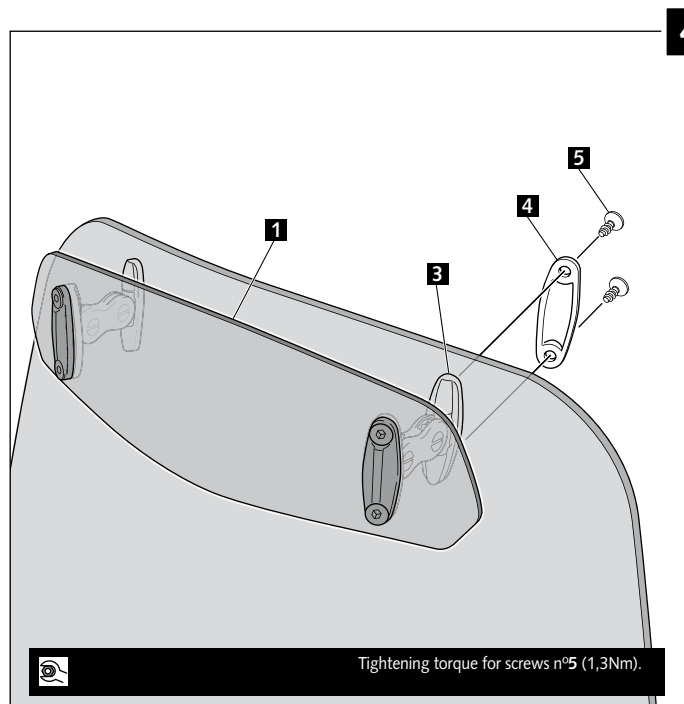
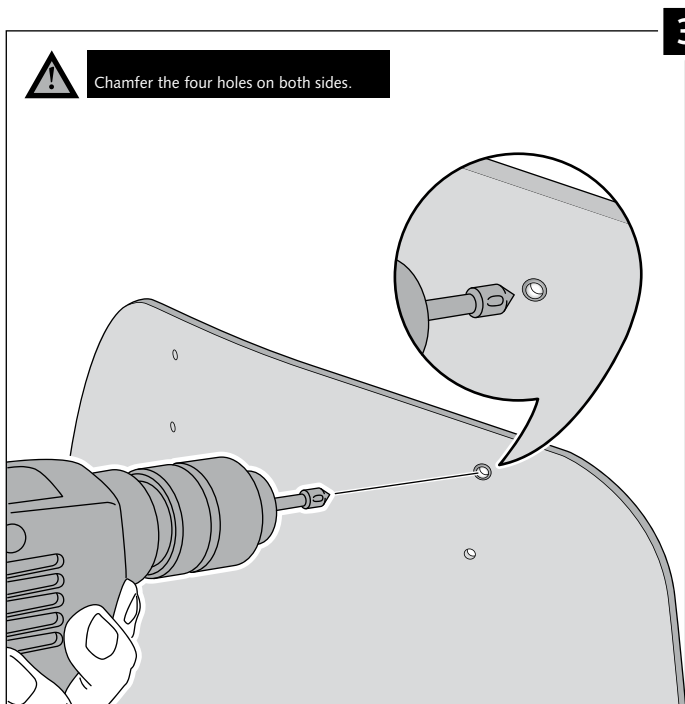
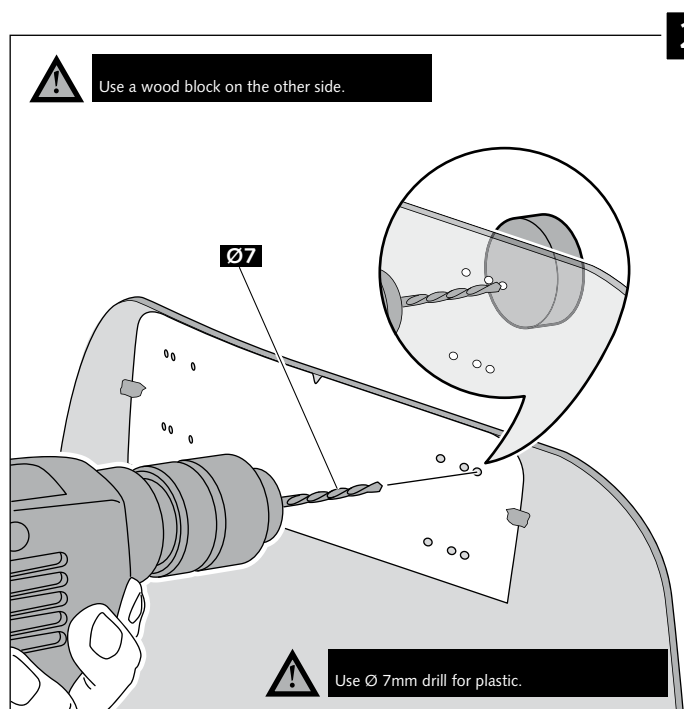
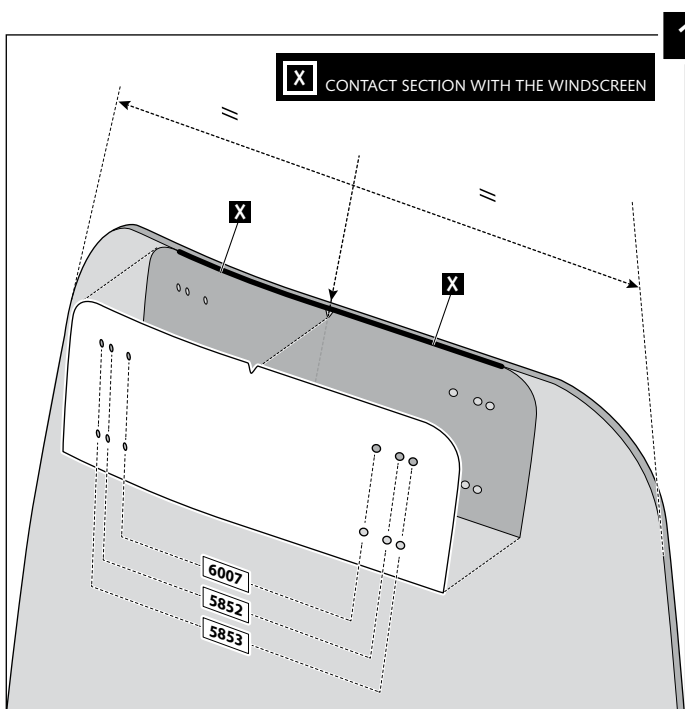

MULTI-ADJUSTABLE VISOR

- MOUNTING INSTRUCTIONS -

TYPE B

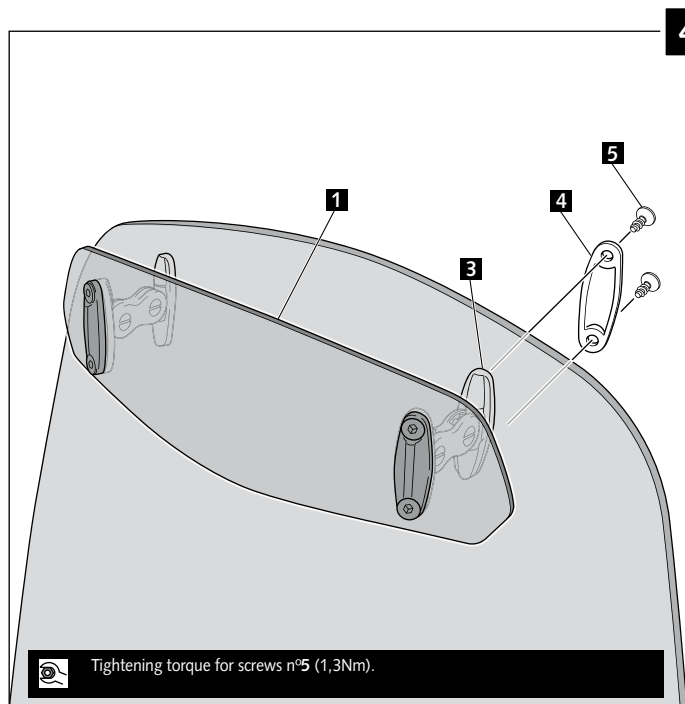
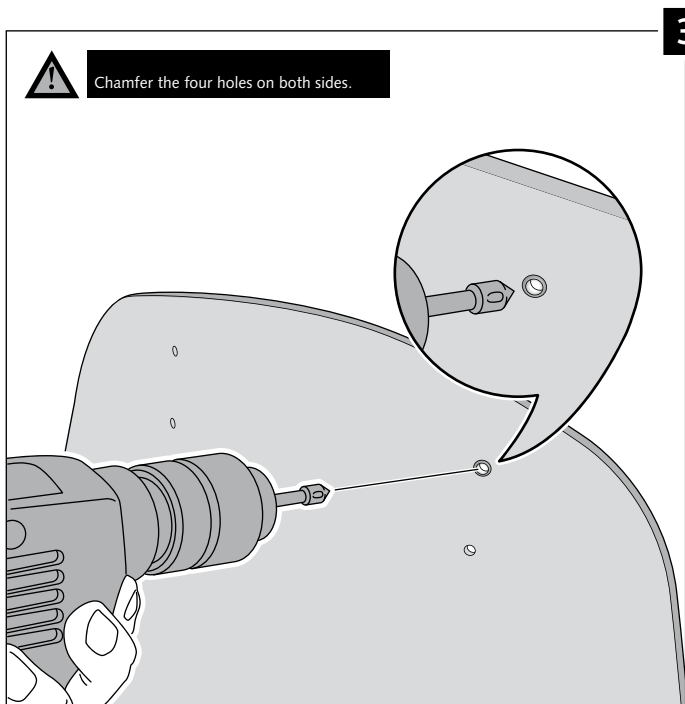
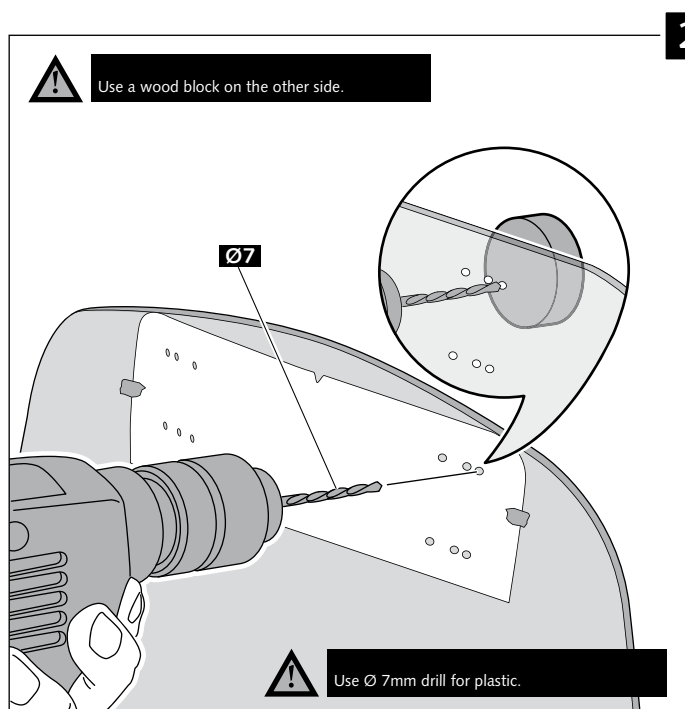
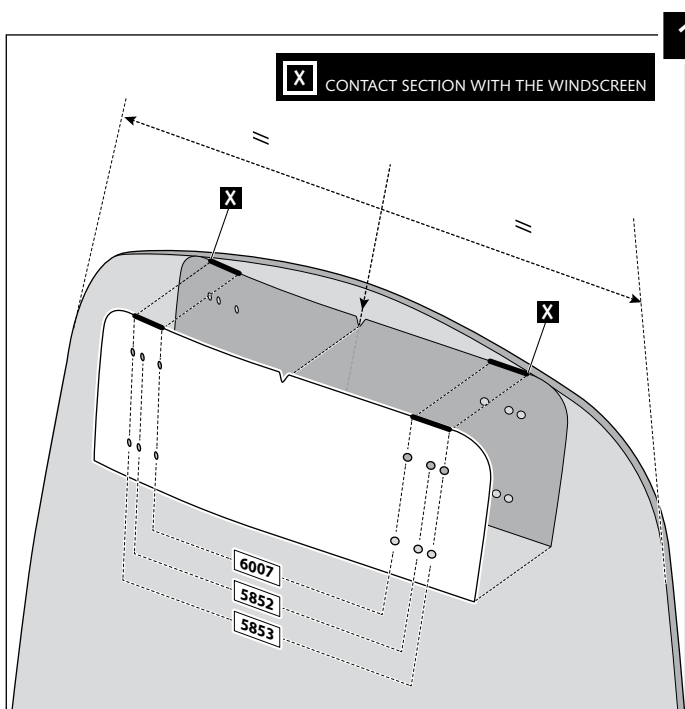

MULTI-ADJUSTABLE VISOR

- MOUNTING INSTRUCTIONS -

TYPE C

