

SCREEN FOR HONDA NC 750 X - '16 -

Ref.: 8909
(Mod. SPORT)



Ref.: 8910
(Mod. TOURING)





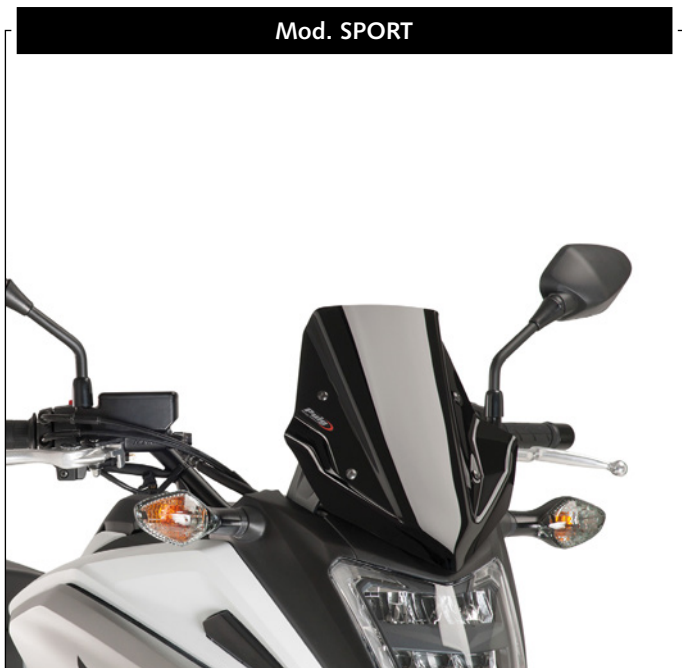

Mod. SPORT





Mod. TOURING

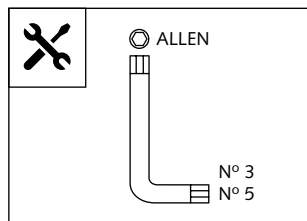

ID.	PIEZA/PART	DESCRIP.	QTY.
1		SPORT screen (Ref. 8909)	1
		TOURING screen (Ref. 8910)	
2		M5 x 30 ISO 7380 Allen screw	4
3		M5x4 rubber washer	4



 1 person	 10 min	<input type="checkbox"/> Easy
		<input type="checkbox"/> Intermediate
		<input type="checkbox"/> Difficult

SCREEN FOR HONDA NC 750 X - '16 -

MOUNTING INSTRUCTIONS

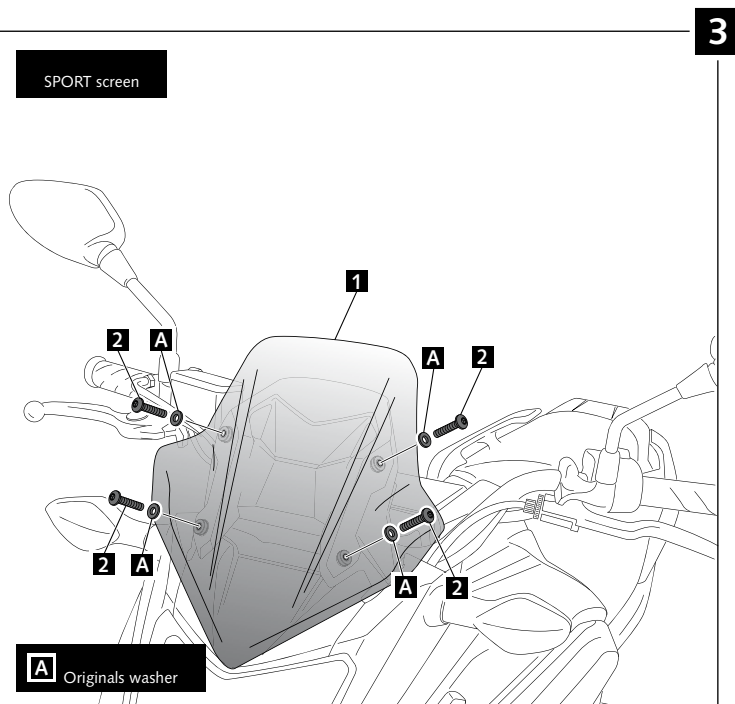
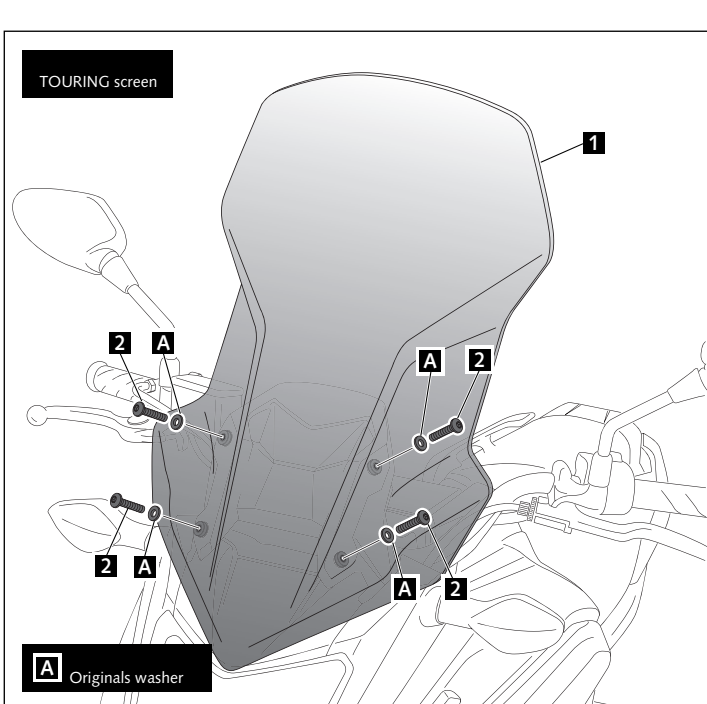
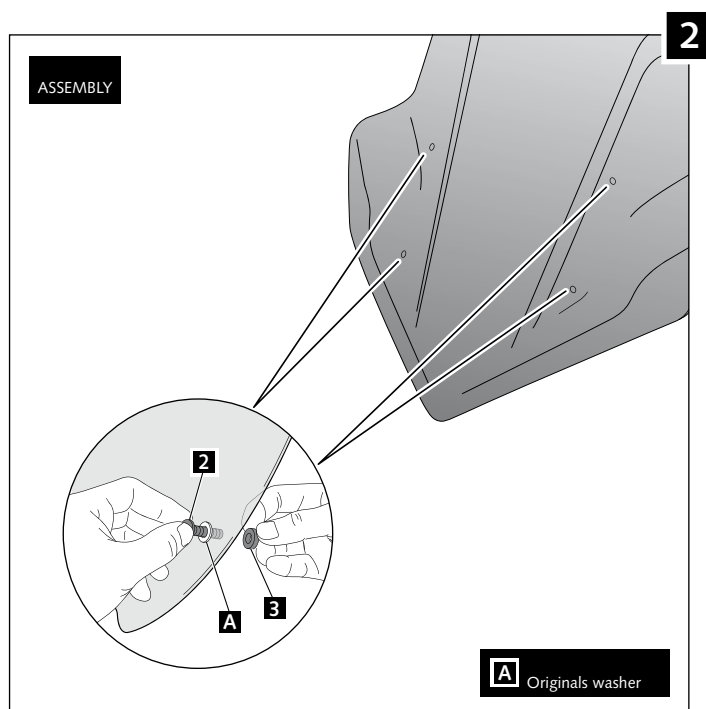
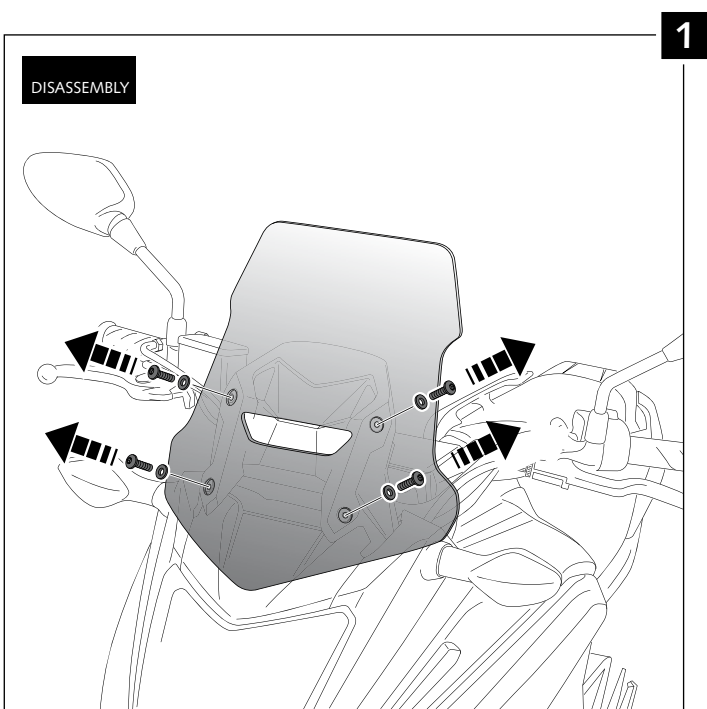

TIPS FOR A CORRECT WINDSCREEN ASSEMBLY

Due to storage and transport processes of the windscreens, which are subjected to positions and temperature changes out of our control, this may produce small deformations on the material causing some difficulties on the mounting process. It is recommended to:

- 1- Place the screws on one side without tighten all the way.
- 2- Stretch the windscreen to the other side (see Fig. 1). The flexibility of the material allows this stretch with no risk of breaking or cracking.
- 3- Place the screws without tightening all the way.
- 4- Tighten progressively all the screws.

