

HANDPROTECTORS FOR YAMAHA MT03

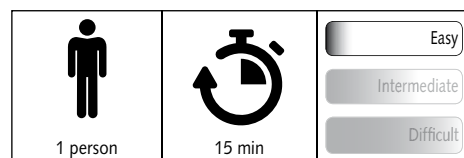

Ref.: 8897

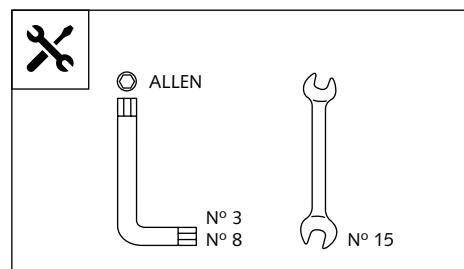

ID.	PART	DESCRIPTION	QTY.
1		Right handguard	1
2		Ø6,5 right handlebar anchoring part (supplied mounted with handguard)	1
3		Left handguard	1
4		Ø6,5 left handlebar anchoring part (supplied mounted with handguard)	1
5		Right metal support	1
6		Left metal support	1
7		Øinner 6,4 Øouter 15 x 7,4mm Bush with flange	2
8		Øinner 6,4 Øouter 9 x 6,6mm Arrowhead	2
9		M6x50 DIN 7991 Allen screw	2
10		M5x16 ISO 7380 Allen screw	2
11		M5x11 ISO 7380 Allen screw (supplied already mounted on items 1-2-3-4)	4
12		M5X0,5 Nylon washer (supplied already mounted on items 1-2-3-4)	6
13		M5 Silentblock	2
14		M5 Special nut (supplied already mounted on items 1-2-3-4)	4
15		Ø4,5xØ11,5x2mm Rubber washer (supplied already mounted on items 1-2-3-4)	4
16		Ø30 x Ø6 plastic washer	2
17		M5 ISO 7380 Allen screw cap	6
18		M6 DIN 7991 Allen screw cap	2
19		Stikers set	1

- HANDPROTECTORS FOR - YAMAHA MT03

- MOUNTING INSTRUCTIONS -

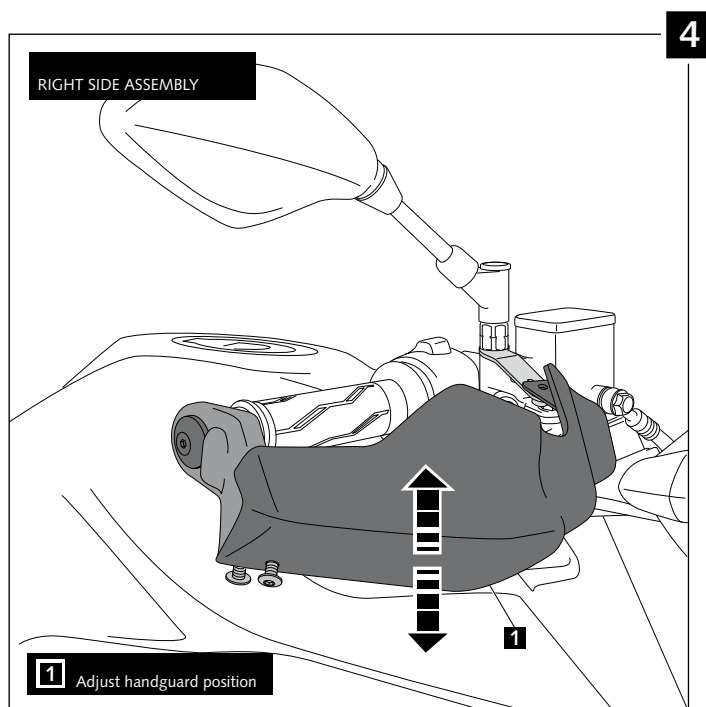
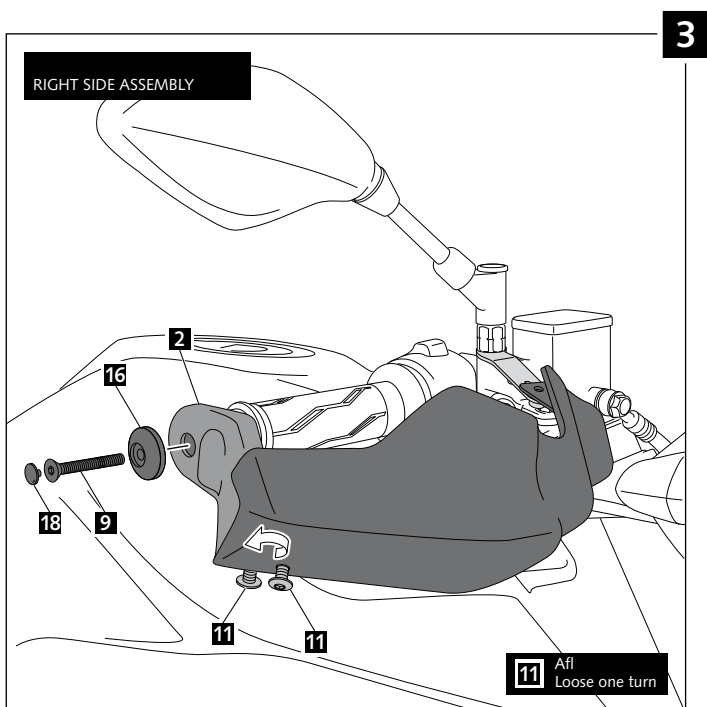
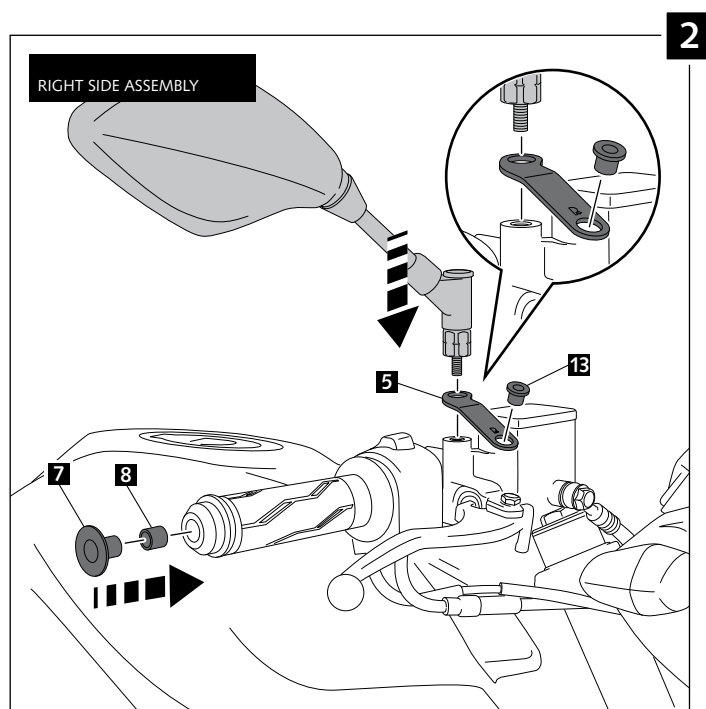
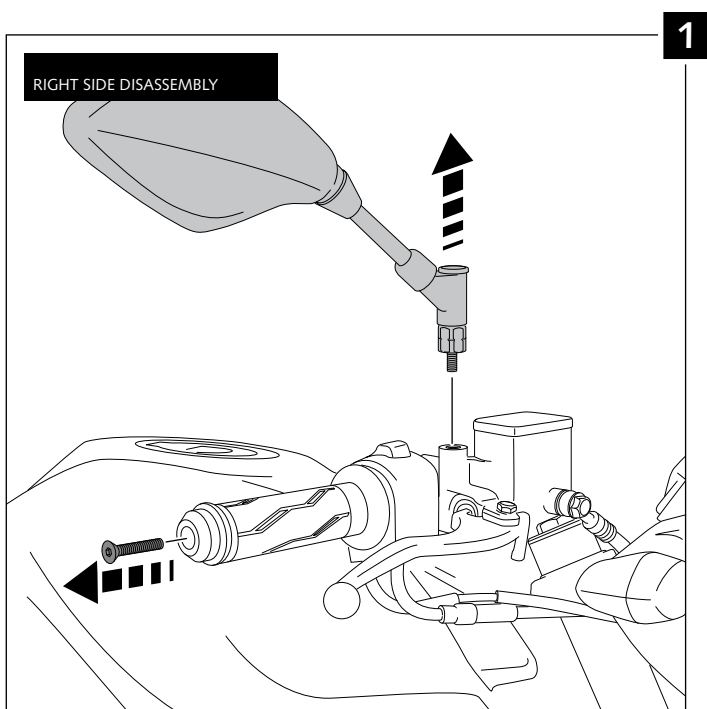

- HANDPROTECTORS FOR - YAMAHA MT03

- MOUNTING INSTRUCTIONS -

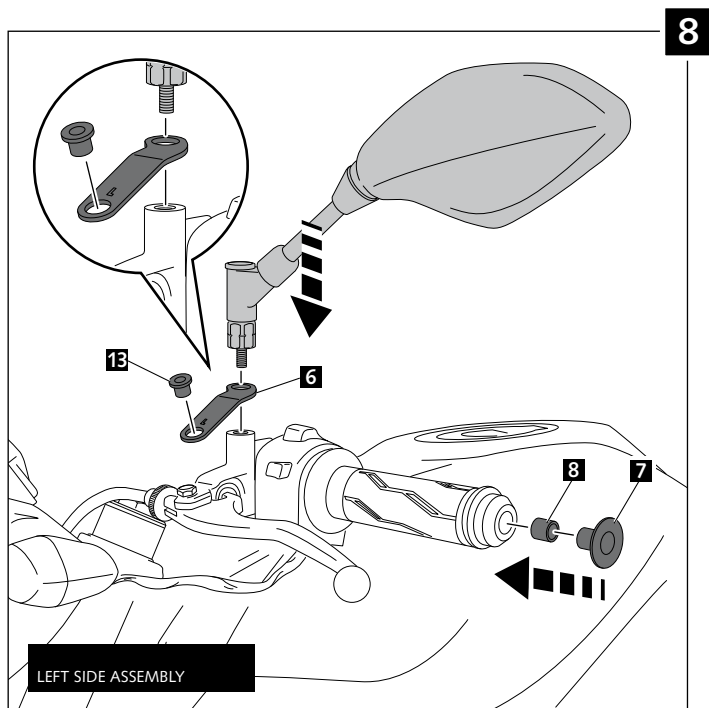
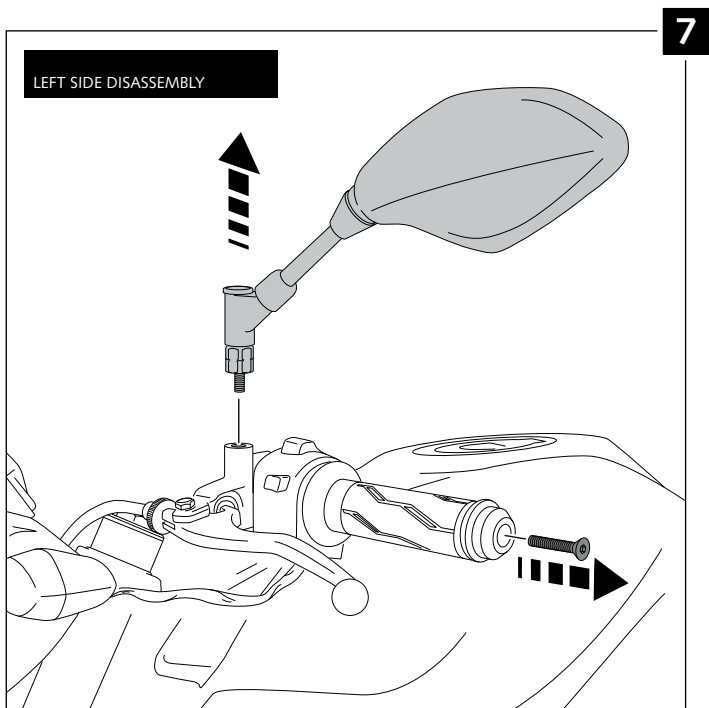
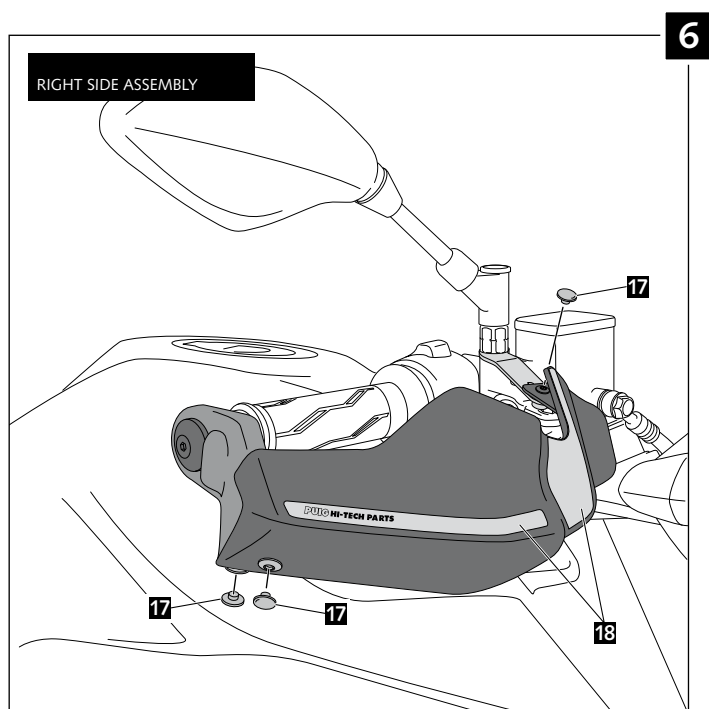
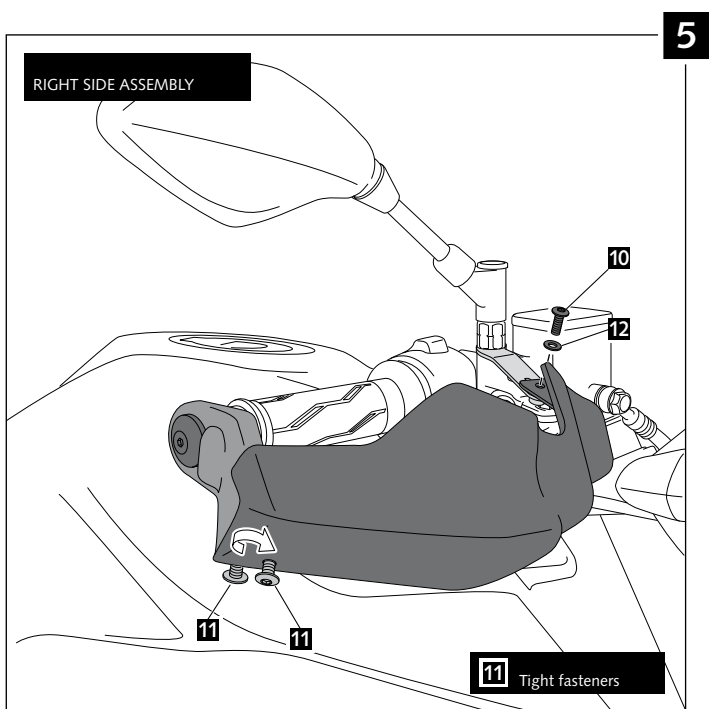

- HANDPROTECTORS FOR - YAMAHA MT03

- MOUNTING INSTRUCTIONS -

