











**MOUNTING INSTRUCTIONS**

**WINDSHIELD FOR  
 BMW F 800 R '15 -**



ID.	PIEZA / PART	DESCRIPTION	QTY.
1		Touring windshield	1
2		Right metal support	1
3		Left metal support	1
4		Ø inner 8,5 x Ø outer 13x15 mm arrowhead	2
5		DIN 912 10,9 M8x50 (black) Allen screw	2
6		M5x25 ISO 7380 (black) Allen screw	3
7		M5x4 rubber washer	3
8		M5 silentblock	2
9		M5x16 ISO 7380 (black) Allen screw	2
10		M5x0,5 nylon washer	5

## MOUNTING INSTRUCTIONS

### WINDSHIELD FOR BMW F 800 R '15 -

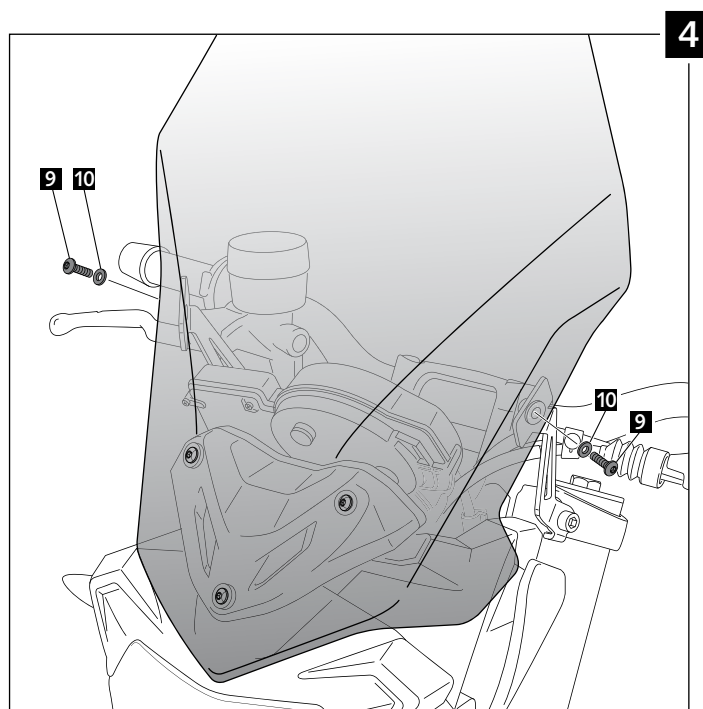
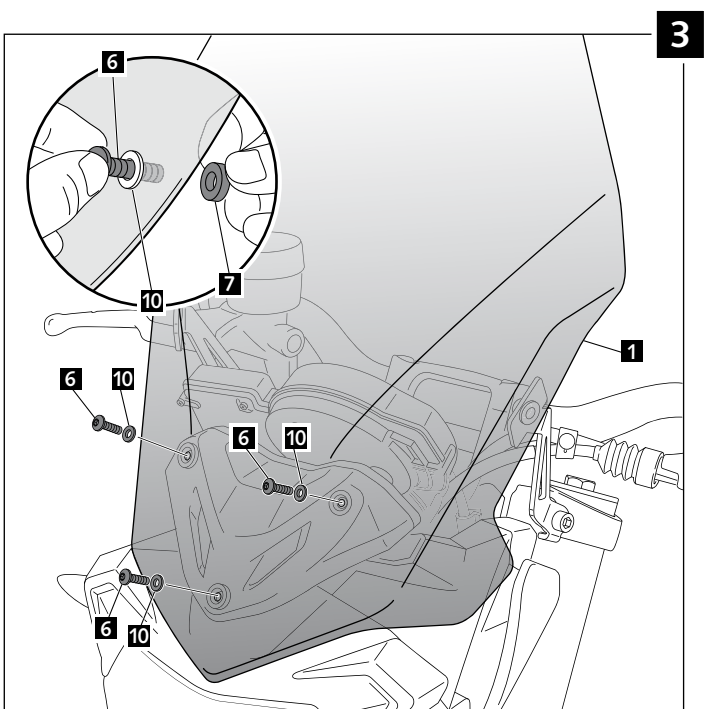
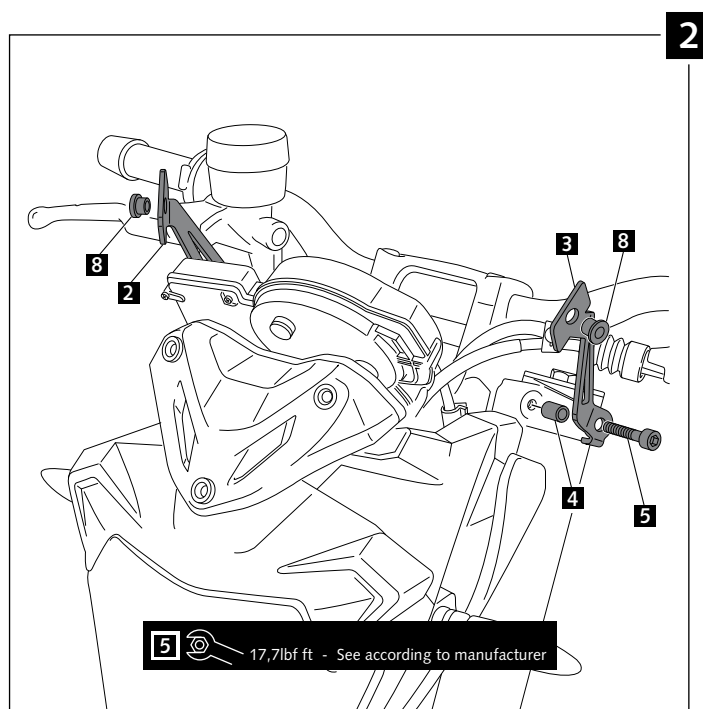
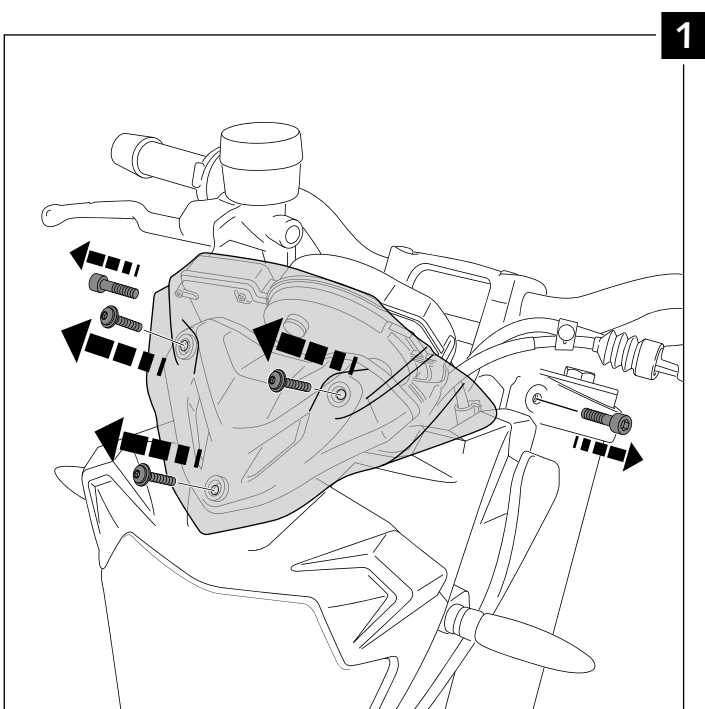

## TIPS FOR A CORRECT WINDSCREEN ASSEMBLY

Due to storage and transport processes of the windscreens, which are subjected to positions and temperature changes out of our control, this may produce small deformations on the material causing some difficulties on the mounting process. It is recommended to:

- 1- Place the screws on one side without tighten all the way.
- 2- Stretch the windscreen to the other side (see Fig. 1). The flexibility of the material allows this stretch with no risk of breaking or cracking.
- 3- Place the screws without tightening all the way.
- 4- Tighten progressively all the screws.

