

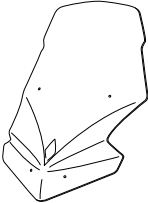





MOUNTING INSTRUCTIONS

TOURING SCREEN FOR
YAMAHA MT09 TRACER



ID.	PART	DESCRIPTION	QTY.
1		Touring screen	1
2		Metal support	1
3		Handguard displacer with M5 thread	4
4		M6x10 ISO 7380 Allen screw	4
5		M5 silentblock	4
6		M5x10 ISO 7380 Allen screw (silver color)	4
7		M5x16 ISO 7380 Allen screw (black color)	8
8		M5x0,5 nylon washer	4
9		Ø12x4mm silicon separator	2

MOUNTING INSTRUCTIONS

TOURING SCREEN FOR YAMAHA MT09 TRACER

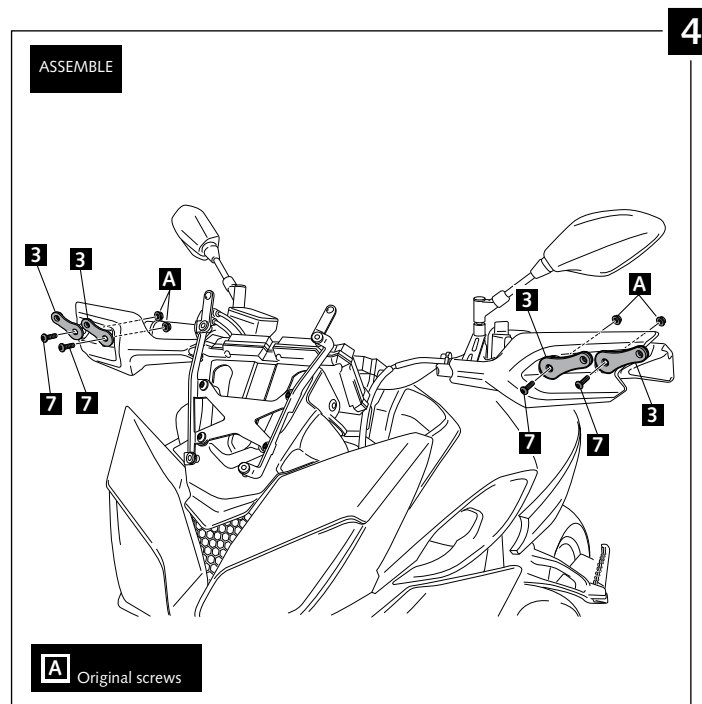
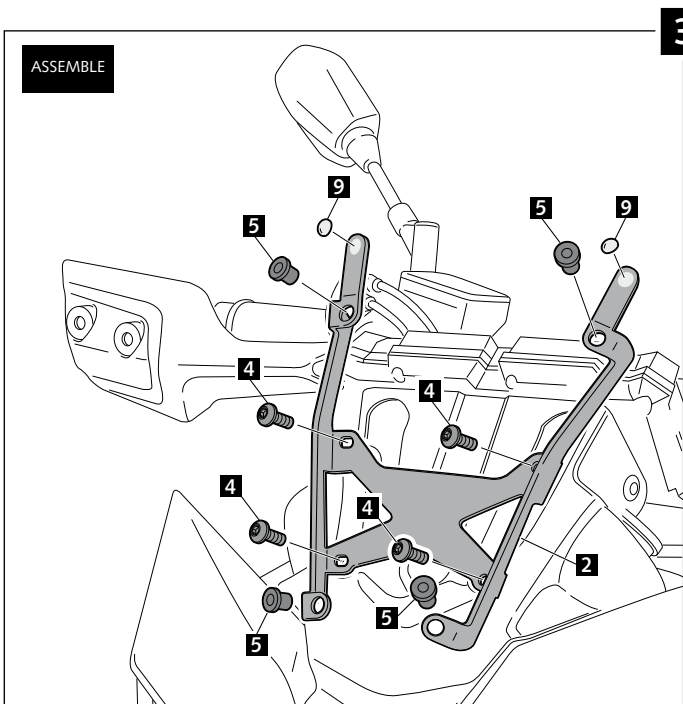
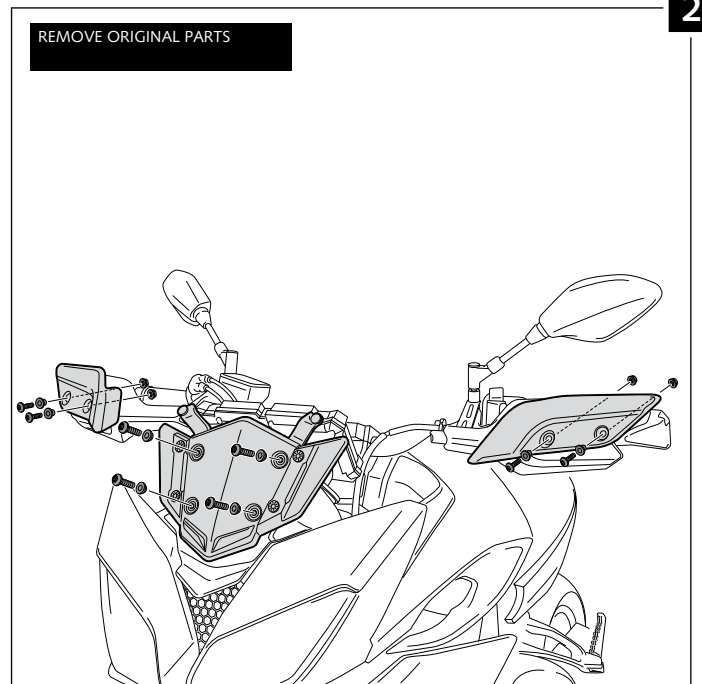
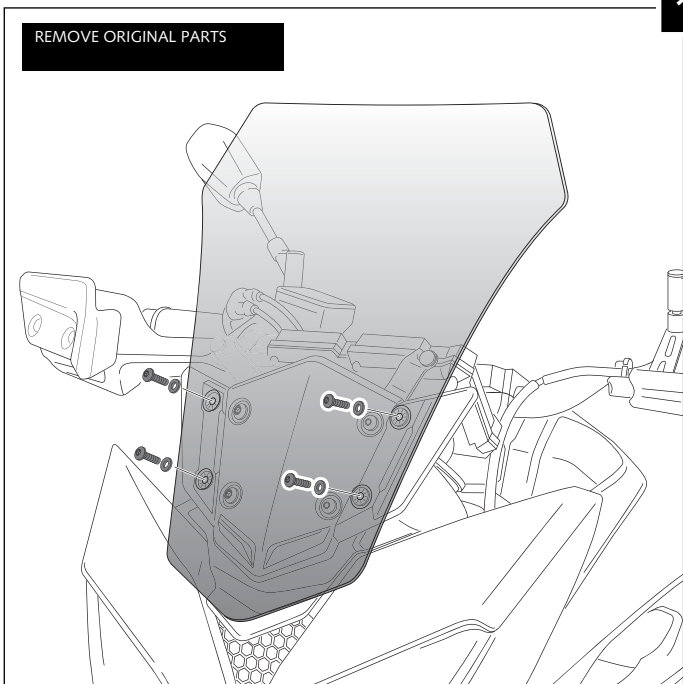

MOUNTING INSTRUCTIONS

TOURING SCREEN FOR YAMAHA MT09 TRACER

5

ASSEMBLE

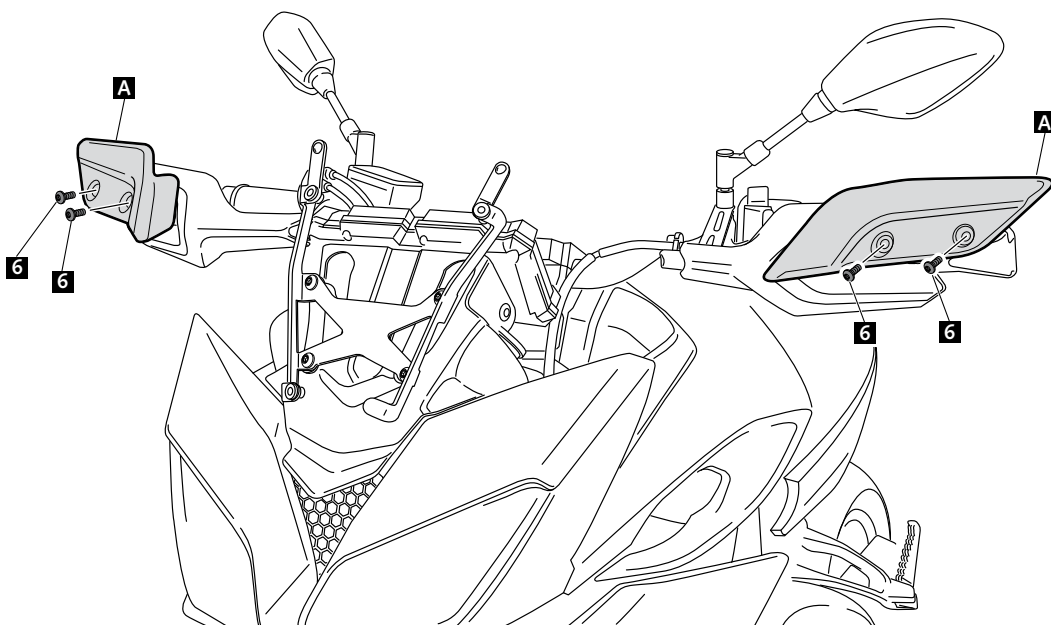

6

ASSEMBLE

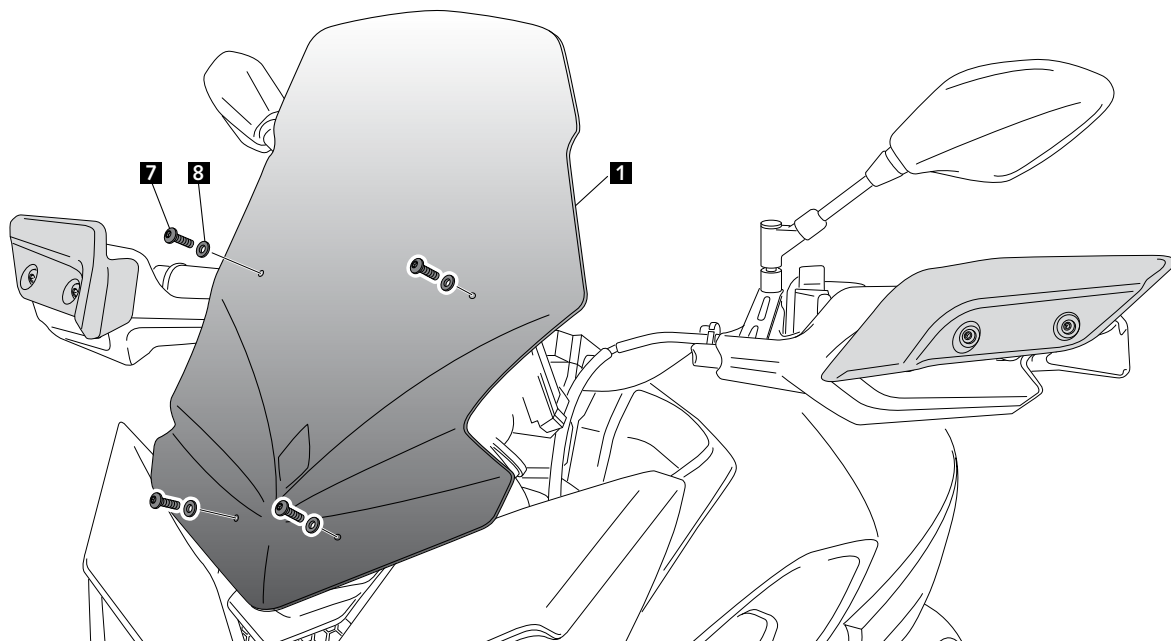

TIPS FOR A CORRECT WINDSCREEN ASSEMBLY

Due to storage and transport processes of the windscreens, which are subjected to positions and temperature changes out of our control, this may produce small deformations on the material causing some difficulties on the mounting process. It is recommended to:

- 1- Place the screws on one side without tighten all the way.
- 2- Stretch the windscreen to the other side (see Fig. 1). The flexibility of the material allows this stretch with no risk of breaking or cracking.
- 3- Place the screws without tightening all the way.
- 4- Tighten progressively all the screws.

