

Ref.: 7640  
(Mod. TOURING)



Ref.: 7639  
(Mod. SPORT)



## MOUNTING INSTRUCTIONS







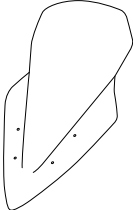
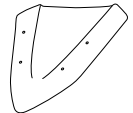

### SCREEN FOR SUZUKI GSX-S1000F '15-'19

Mod. TOURING



Mod. SPORT



ID.	PART	DESCRIPTION	QTY.
1		TOURING screen (ref. 7640)	1
		SPORT screen (ref. 7639)	
2		Special screw M5x20+interior thread M5x15	2
3		Special screw M5x13+interior thread M5x8	2
4		M5x4 rubber washer	4
5		M5 silentblock	4
6		M5x16 ISO 7380 Allen screw (black)	4
7		M5x0,5 nylon washer	4
8		M5 ISO 7380 Screw cap	4

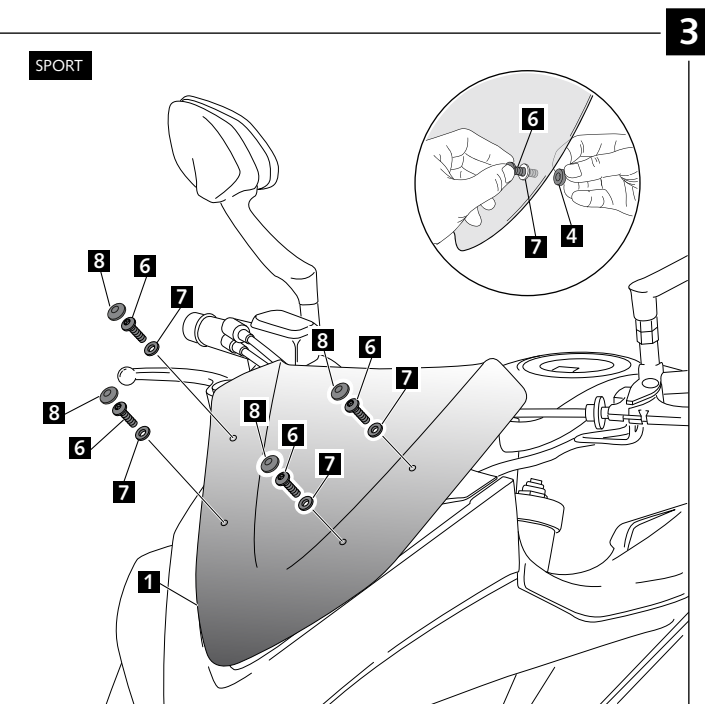
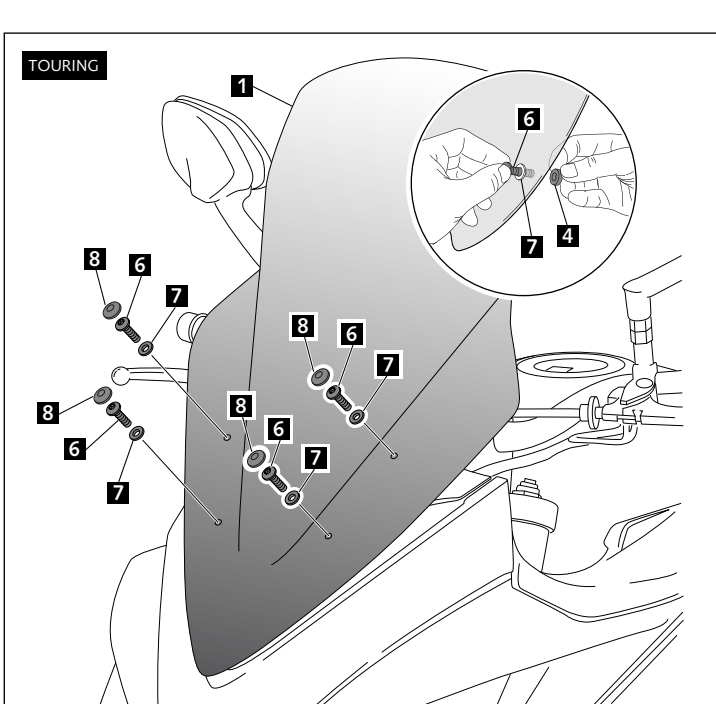
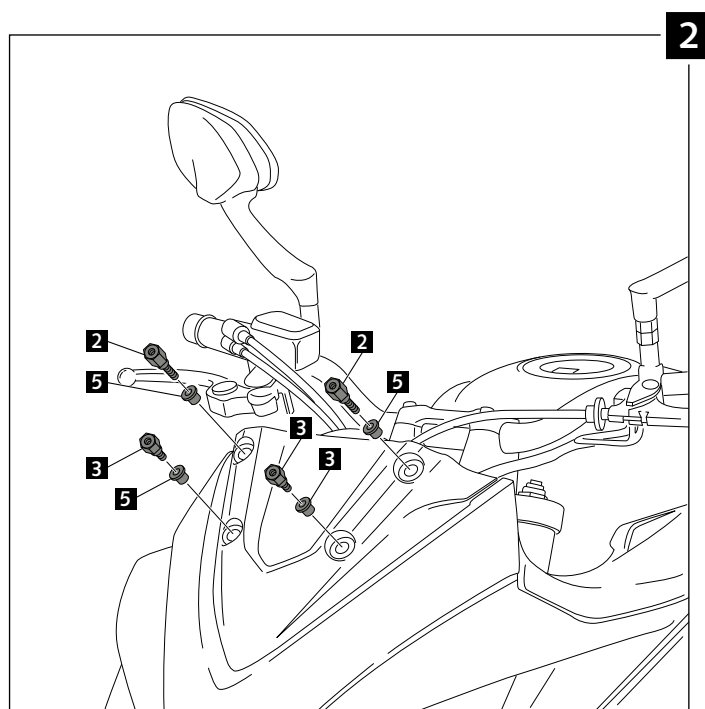
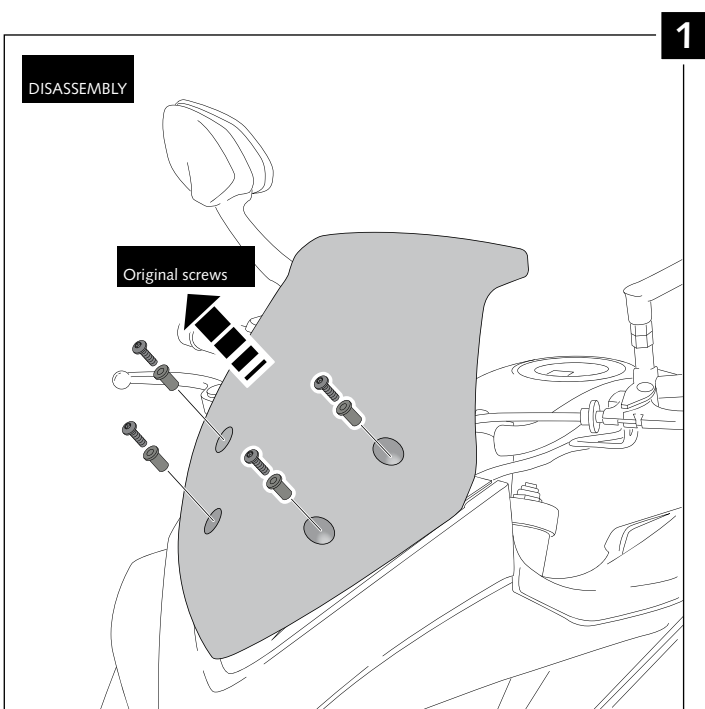

## MULTI-ADJUSTABLE VISOR



Ref.: 6007

Ref.: 5852

Ref.: 5853

Smoke

Clear

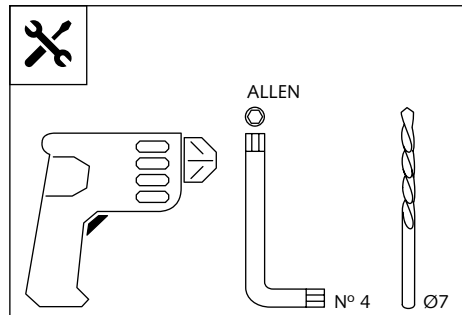

1 person



15 min

Easy

Intermediate

Difficult

Nota/Note:

If the visor is supplied along with the windscreen, the windscreen will come factory-drilled so no drilling is necessary.

ID.	PART	DESCRIPTION	QTY.
1		Visor	1
2		Template	1
3		Multi-adjustable mechanism	2
4		Cap	4
5		Plastic thread fastener M6x12	8

# MULTI-ADJUSTABLE VISOR

## MOUNTING INSTRUCTIONS

### TYPE A

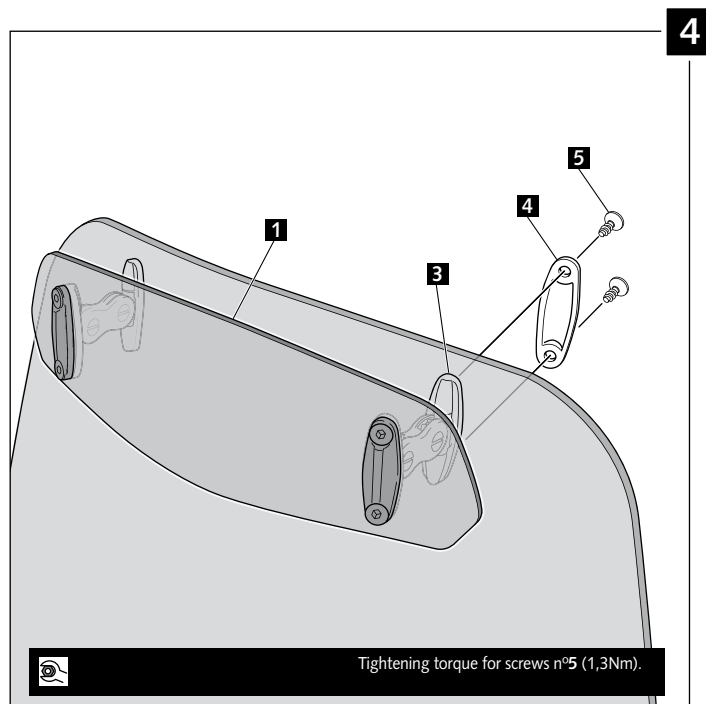
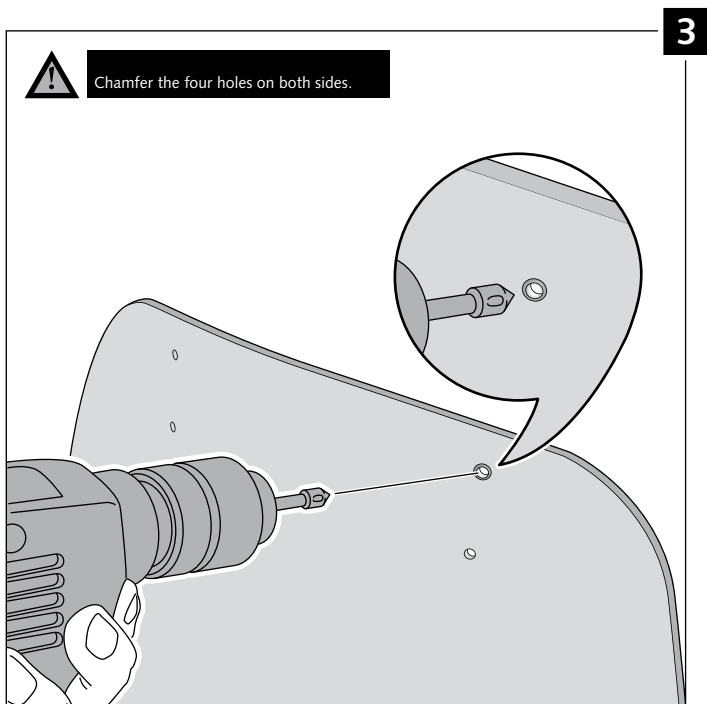
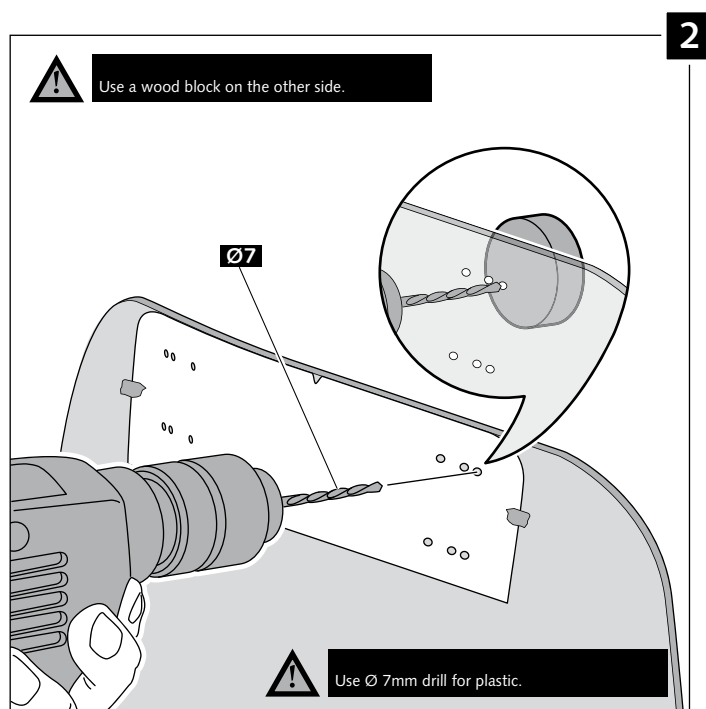
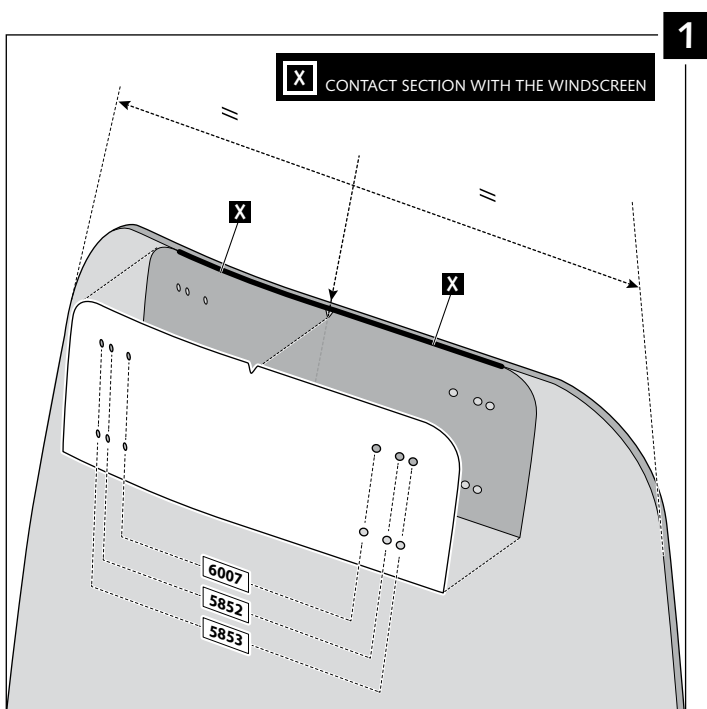

## TYPE B

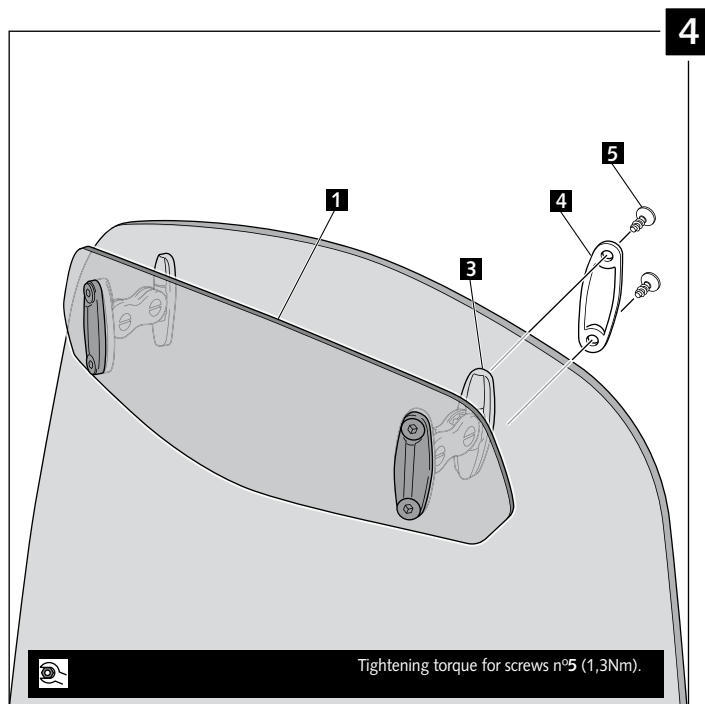
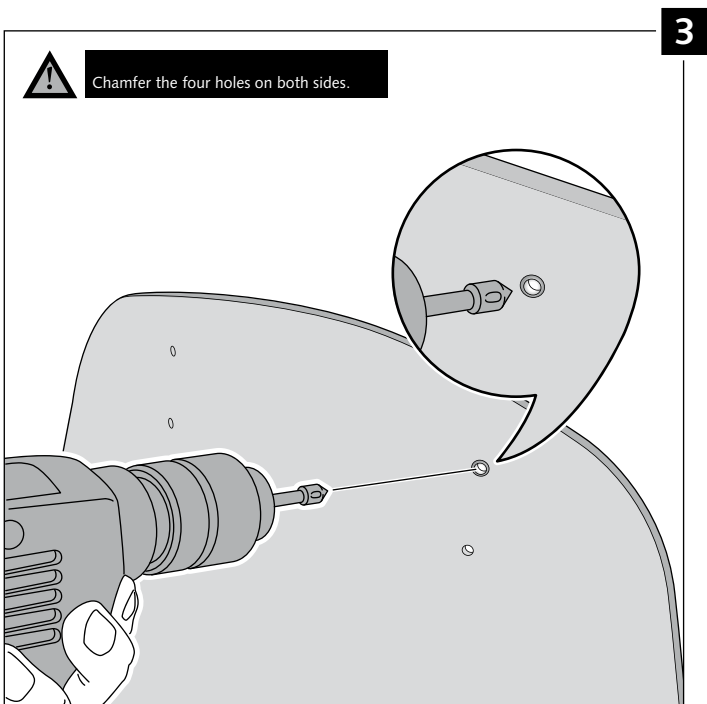
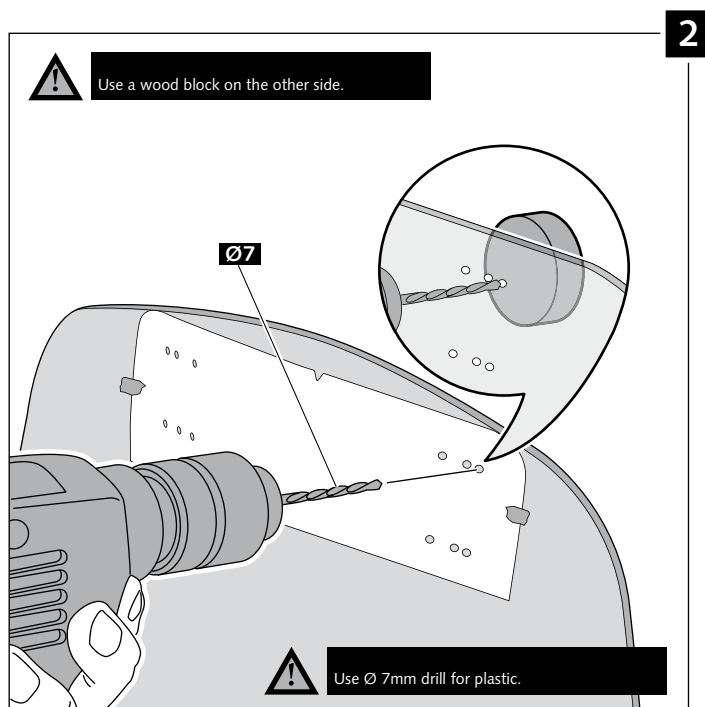
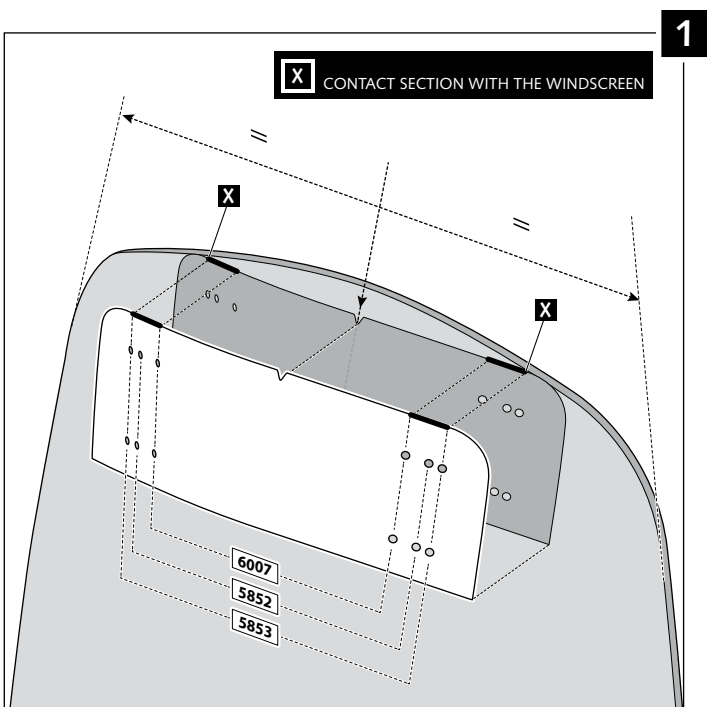

## TYPE C

