

TOURING SCREEN FOR  
**BMW S1000XR '15-**

**Ref.: 7619**

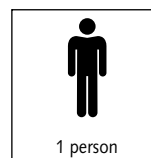

1 person

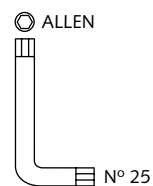
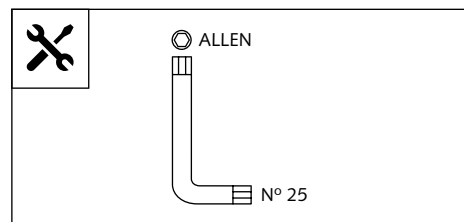

15 min

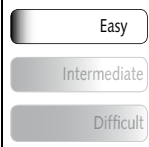

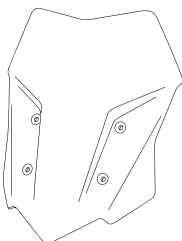
ID	PART	DESCRIPTION	QTY	REF.
1		Touring screen	1	7619H/W/F/NM3

## RING SCREEN FOR BMW S1000XR '15-

### MOUNTING INSTRUCTIONS

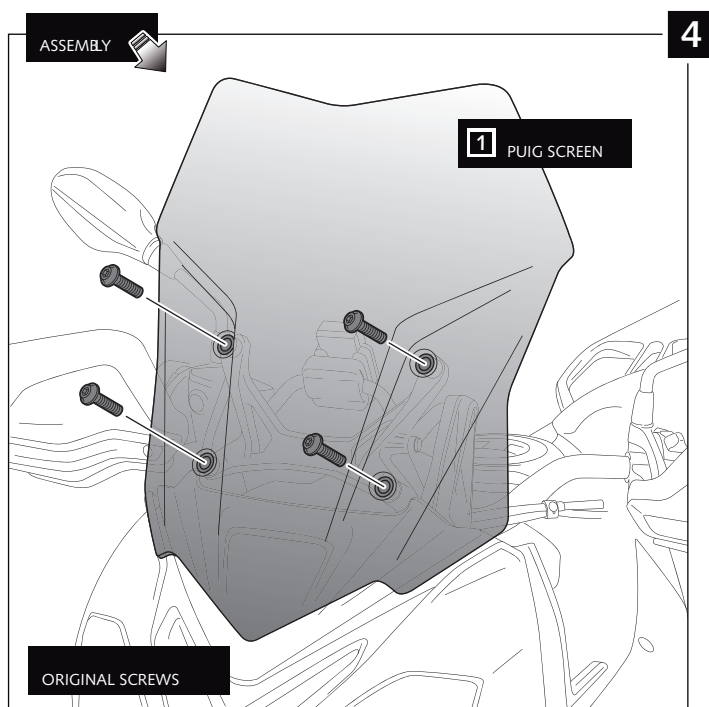
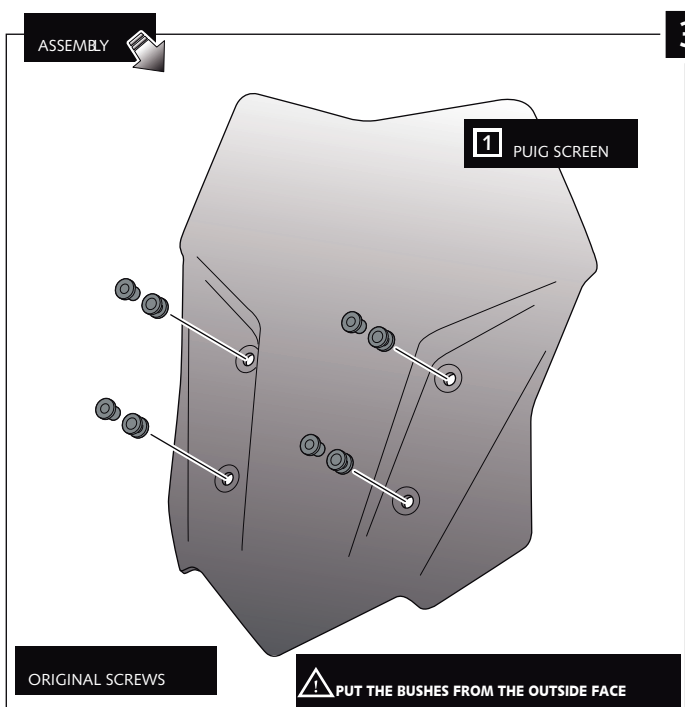
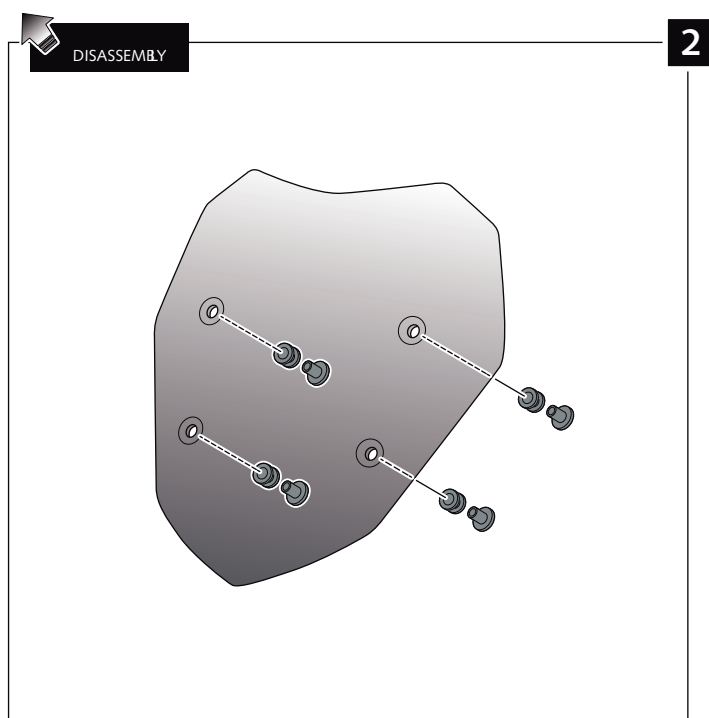
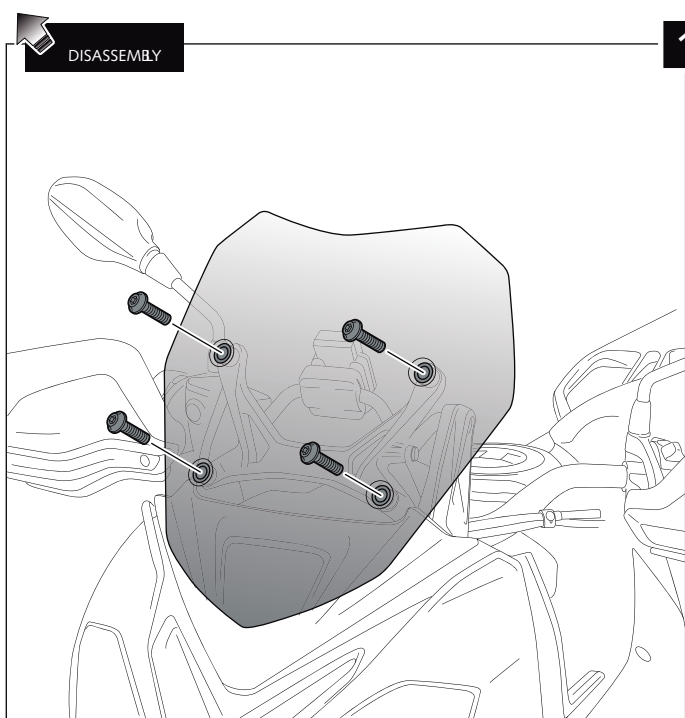

## TIPS FOR A CORRECT WINDSCREEN ASSEMBLY

Due to storage and transport processes of the windscreens, which are subjected to positions and temperature changes out of our control, this may produce small deformations on the material causing some difficulties on the mounting process. It is recommended to:

- 1- Place the screws on one side without tighten all the way.
- 2- Stretch the windscreen to the other side (see Fig. 1). The flexibility of the material allows this stretch with no risk of breaking or cracking.
- 3- Place the screws without tightening all the way.
- 4- Tighten progressively all the screws.

