

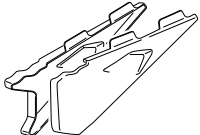





MOUNTING INSTRUCTIONS

INFILL PANELS ADAPTABLE TO BMW R1200GS ADVENTURE LC / R1250GS ADVENTURE

ID.	PART	DESCRIPTION	QTY.
1		Infill panels	1
2		Right metal support	1
3		Left metal support	1
4		Silent block Ø inner 9,6 Ø outer 23x9	4
5		M5x16 ISO 7380 Allen screw - Head Ø9mm	2
6		M5 Silent block	2
7		Self-adhesive black PROFILE PVC 1048 (supplied mounted)	4

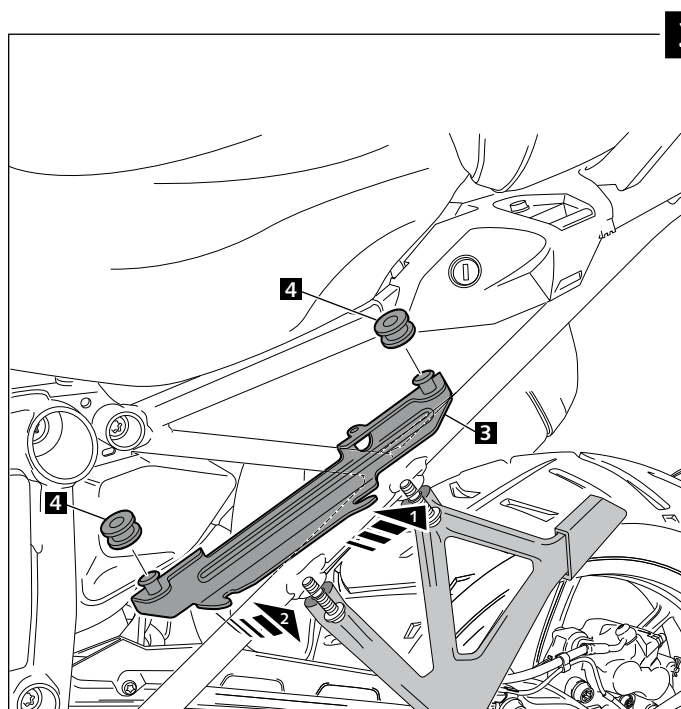
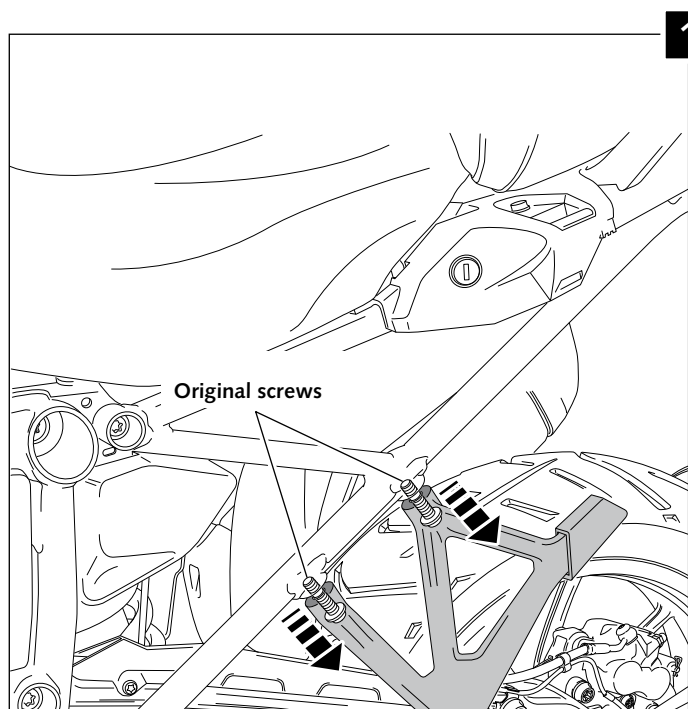

MOUNTING INSTRUCTIONS

INFILL PANELS ADAPTABLE TO
BMW
R1200GS ADVENTURE LC / R1250GS ADVENTURE

