

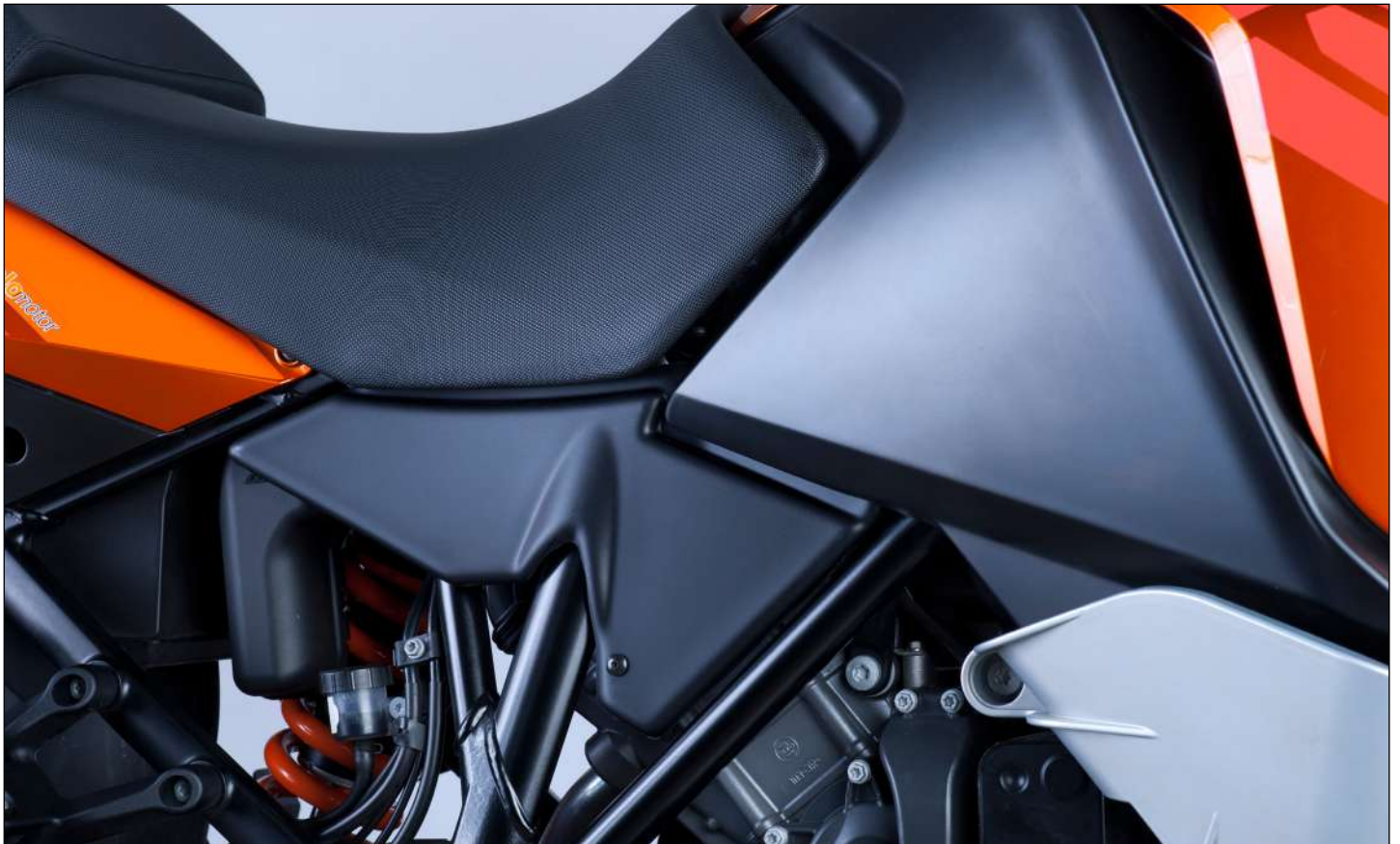

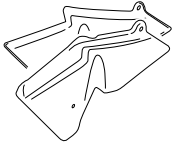





MOUNTING INSTRUCTIONS

Ref.: 7513J

INFILL PANELS FOR
**KTM 1050/1090/1190 ADVENTURE/1290 SUPERADVENTURE/
 1290 SUPERADVENTURE R/S/T**



ID.	PART	DESCRIPTION	QTY.
1		Infill panels	1
2		Upper Right metal Support	1
3		Lower Right metal Support	1
4		Upper Left metal Support	1
5		Lower Left metal Support	1
6		M6x35 ISO 7385 (black) Allen screw	2
7		Silentblock M5	4
8		M5x0,5 nylon washer	4
9		M5x16 ISO 7380 (black) Allen screw	4

MOUNTING INSTRUCTIONS

Ref.: 7513J

INFILL PANELS FOR KTM 1050/1090/1190 ADVENTURE/1290 SUPERADVENTURE/ 1290 SUPERADVENTURE R/S/T

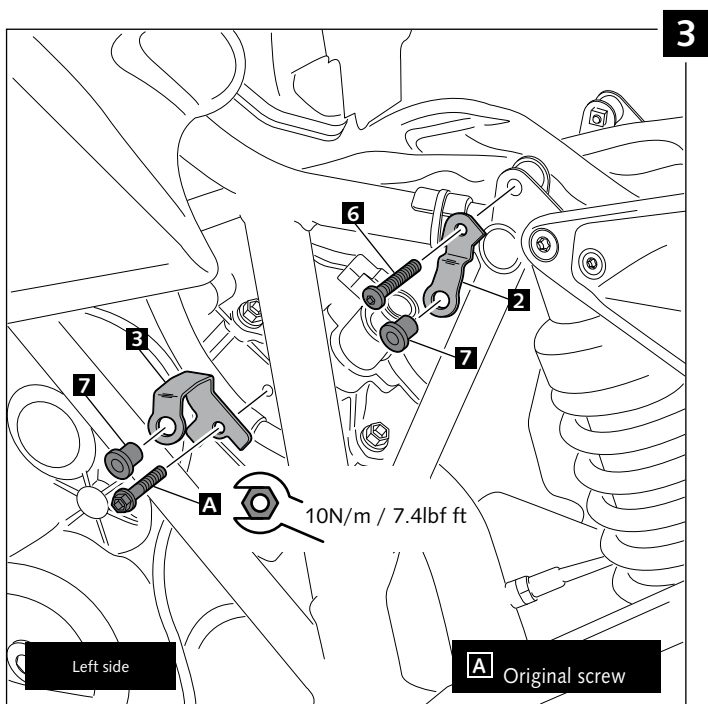
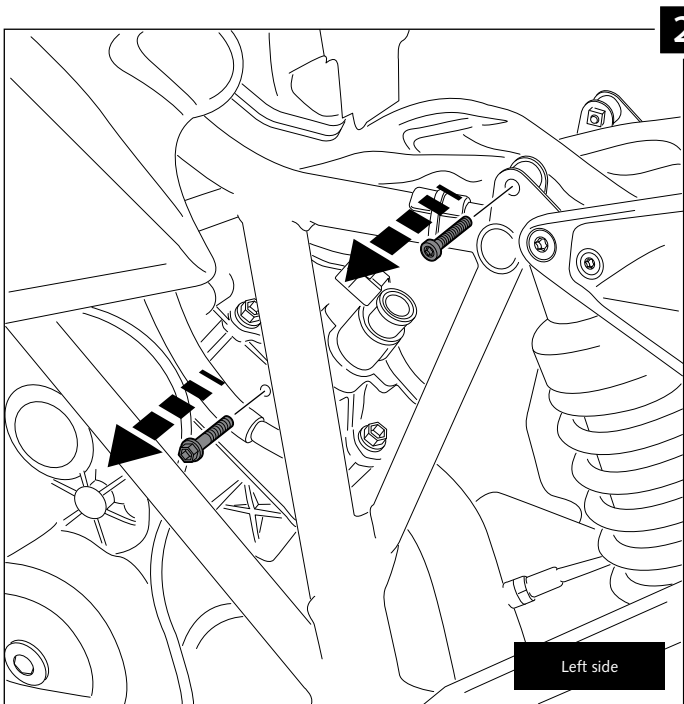
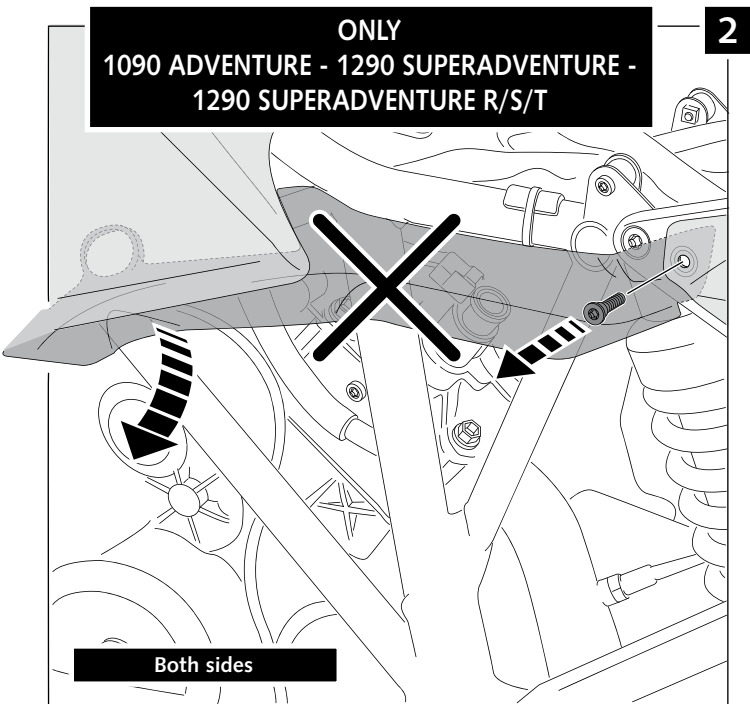
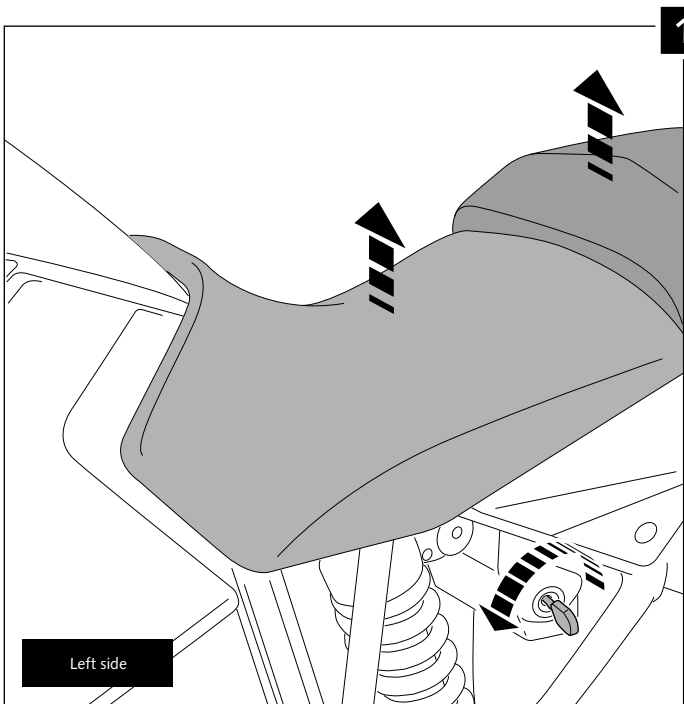

MOUNTING INSTRUCTIONS

Ref.: 7513J

INFILL PANELS FOR KTM 1050/1090/1190 ADVENTURE/1290 SUPERADVENTURE/ 1290 SUPERADVENTURE R/S/T

