

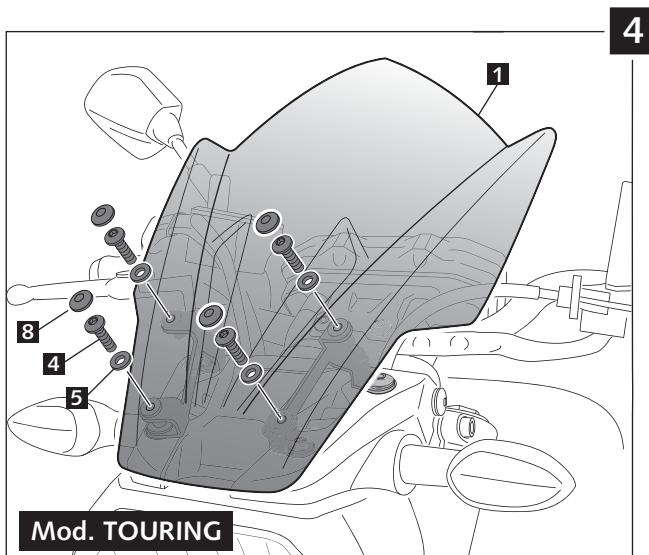

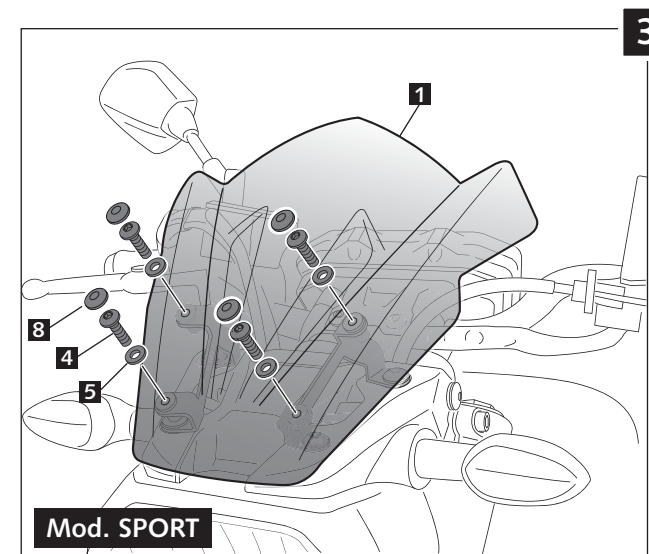

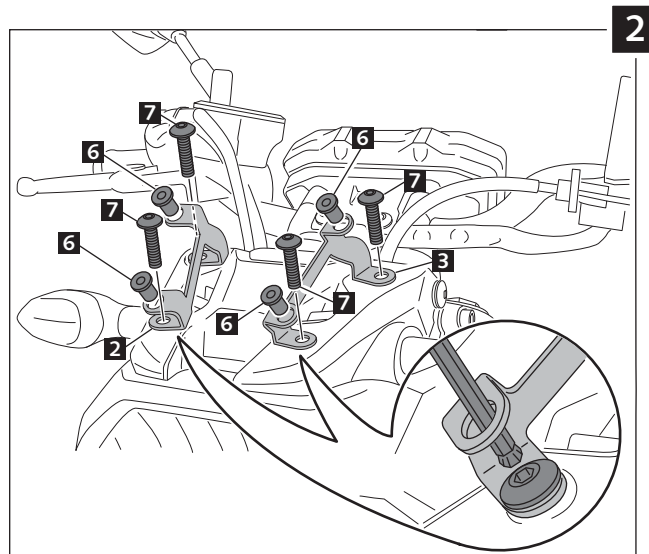

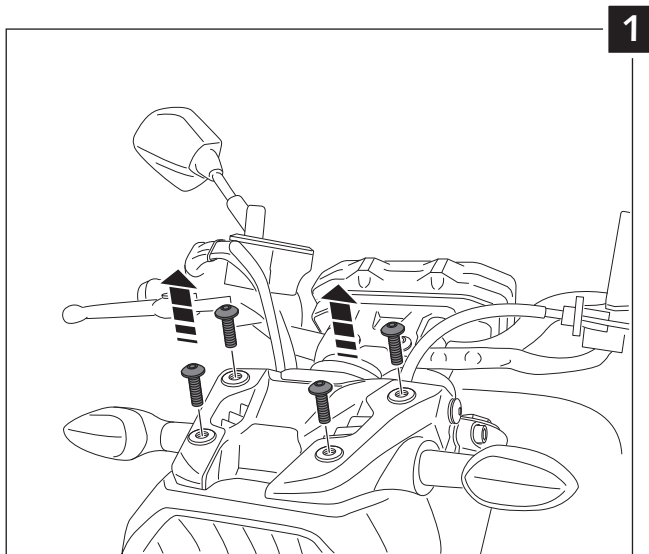

### WINDSHIELD FOR YAMAHA MT07

Mod. SPORT  
Ref.: 7015

Mod. TOURING  
Ref.: 7016



ID.		DESCRIPTION	QTY.
1		SPORT Windshield (ref.7015)	1
		TOURING Windshield (ref.7016)	
2		Right metal support	1
3		Left metal support	1
4		M5x16 ISO 7380 Allen screw	4
5		M5x0,5 Nylon washer	4
6		Silblock M5	4
7		M6x25 ISO 7380 Allen screw	4
8		M5 ISO 7380 Screw cap	4

## TIPS FOR A CORRECT WINDSCREEN ASSEMBLY

Due to storage and transport processes of the windscreens, which are subjected to positions and temperature changes out of our control, this may produce small deformations on the material causing some difficulties on the mounting process. It is recommended to:

- 1- Place the screws on one side without tighten all the way.
- 2- Stretch the windscreen to the other side (see Fig. 1). The flexibility of the material allows this stretch with no risk of breaking or cracking.
- 3- Place the screws without tightening all the way.
- 4- Tighten progressively all the screws.

