

WINDSHIELD MODEL

TREND UNIVERSAL

Ref.: 5022

(black colour)
(smoke colour)
(dark smoke colour)
(blue colour)

ID.	DESCRIPTION	REF.	QTY.
1	Windshield	I0263H	1
2	M5 DIN982 Inox nut	TUERCA-D982-746	4
3	M5x13 phillips screw	TORNIP510---233	4
4	M5x20 DIN912 Inox screw	TORNI-AD912-464	4
5	Semi-clamp ball-joint nut	BRIROT01-1-PR16	2
5	Semi-clamp ball-joint screw	BRIROT02-1-PR16	2
6	Medium-spacer Ø22mm	CAS29-22-0-PR16	4
7	Medium-spacer Ø26mm	CAS29-26-0-PR16	4
8	M8x55 DIN912 Inox screw	TORNI-D912--631	2
9	M8 DIN985 locknut	TUEA-D985.8-M8-	2
10	Rod guide	FIXVARLL-0-PR16	2
11	Front clamp handlebar	BRIDAANT-0-PR16	2
11	Rear clamp handlebar	BRIDAPOS-0-PR16	2
12	Rod Dim. 4x20mm Inox	VARILI4X20--576	2
13	Ball bearing set	CJROTULA-0-P200	2
13	Rod with ball bearing Dim. 9x200mm	VARILF9X200-591	2
14	Support set	CONJU-S3PCC-003	2
15	Rubber outer stop	TOPEE-VPGT--8/4	2
16	Trim	RIBETEAHP--900H	1
17	M8 DIN912 screw cap	TAPA--CHCI1450E	2

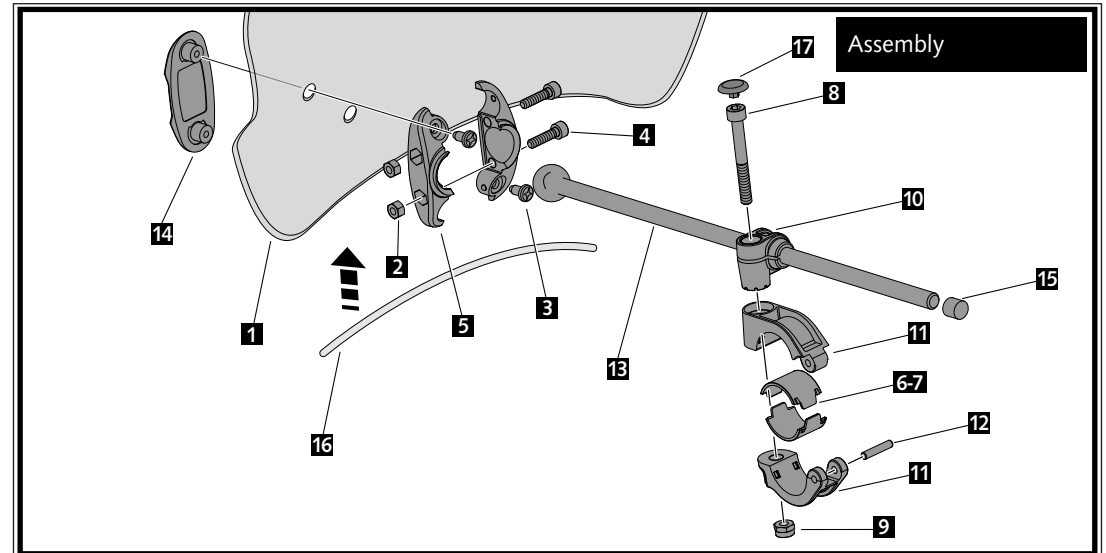

WINDSHIELD MODEL

TREND UNIVERSAL

Ref.: 5022

(black colour)
(smoke colour)
(dark smoke colour)
(blue colour)

It would be convenient to re-tight the windshield screws, specially the ones that are fixed to the motorcycle, whenever you maintain the vehicle.
Thanks for your attention.

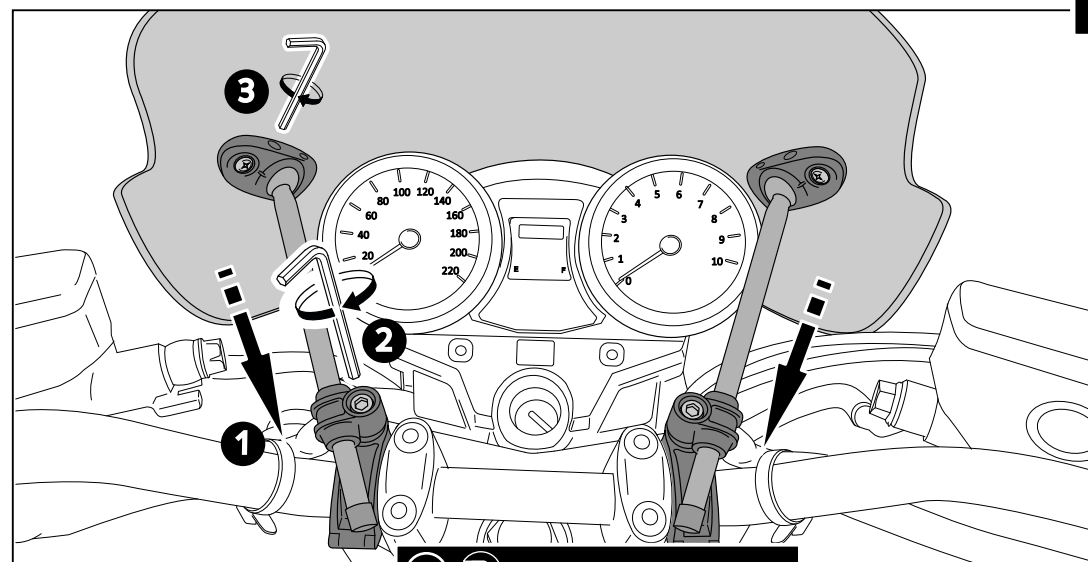
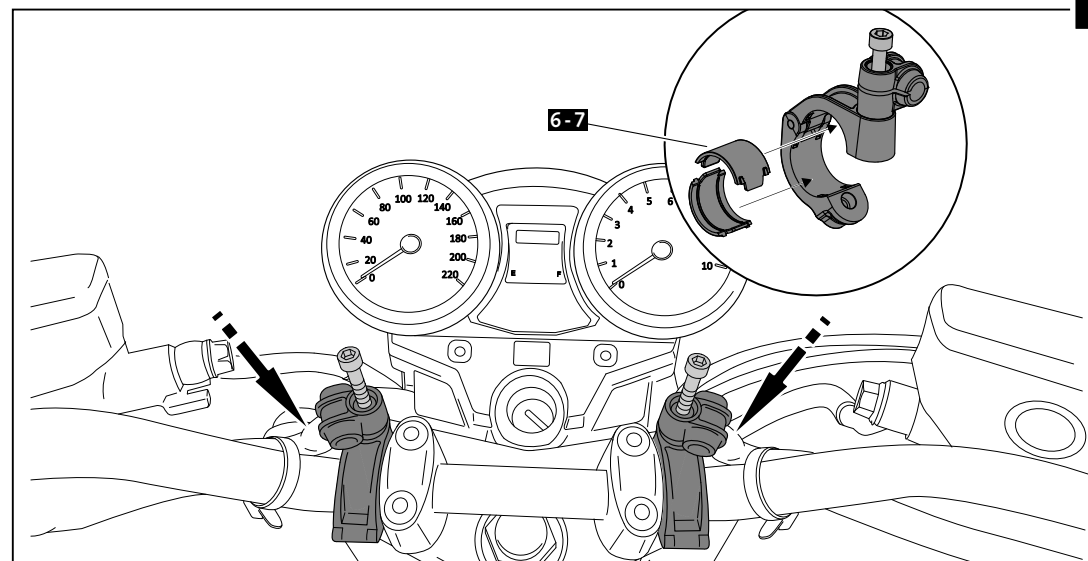

IMPORTANT: On some motorcycle models it may be necessary to cut the rods to avoid them touch the gas tank when turning the handlebar.

2  35.4 lbf/in - Tightening torque

INAZUMA 250 '13-'17

M O U N T I N G I N S T R U C T I O N S

REF 10591

KIT FOR RAFALE / TREND / SHARK



1 Person



15 min



EASY

ALLEN





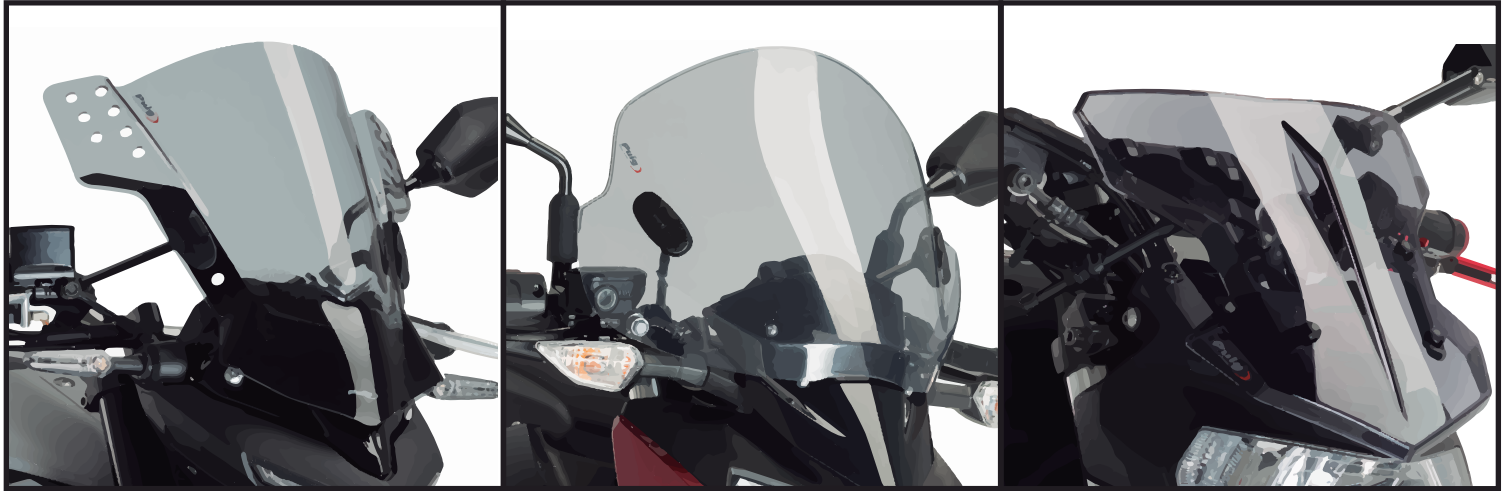

Nº 3
Nº 5

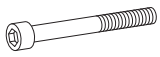

PHILLIPS
SCREWDRIVER



It would be convenient to re-tight the windshield screws, specially the ones that are fixed to the motorcycle, whenever you maintain the vehicle.
Thanks for your attention.

ID	PART	DESCRIPTION	QTY	REF
1		M6x40 DIN912 Allen Screw	2	TORNIAD912-0058
2		Coupling angle	2	FIXSOPOR-0-PR16
3		Angle	2	SOPORT65-1-0958
4		M6 DIN9021 Washer	2	ARANDPD9021-037
5		M6 DIN6923 nut	2	TUERCAEM6G-0213
6		Nut cap	2	CAPERUZTOM6-063

INAZUMA 250 '13-'17

MOUNTING INSTRUCTIONS

1

ASSEMBLY

