

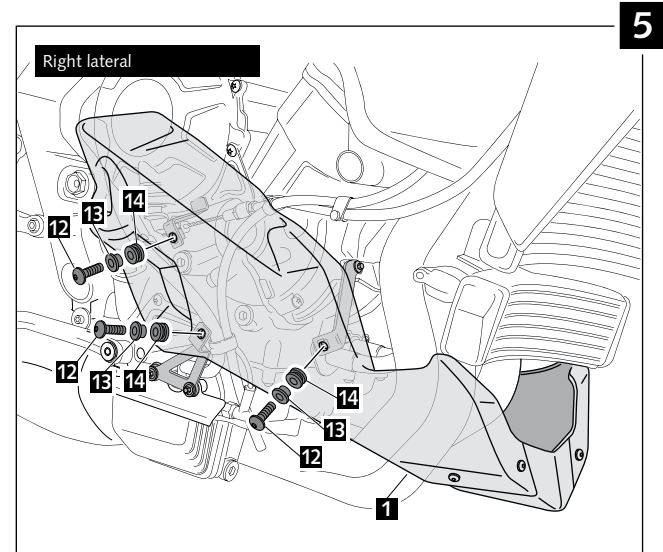

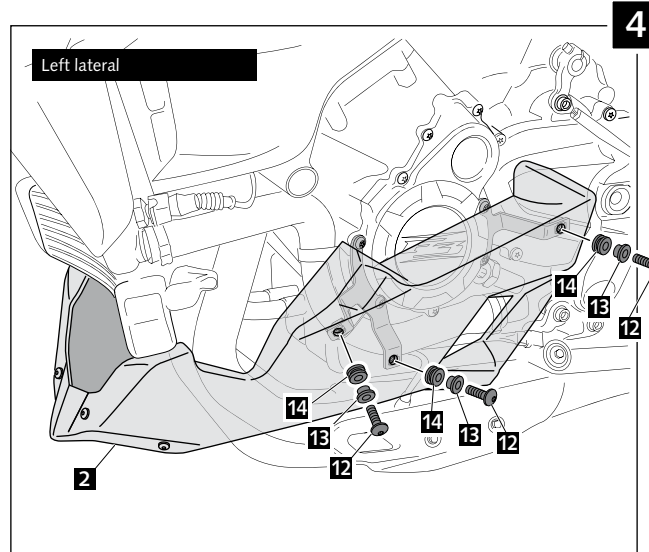

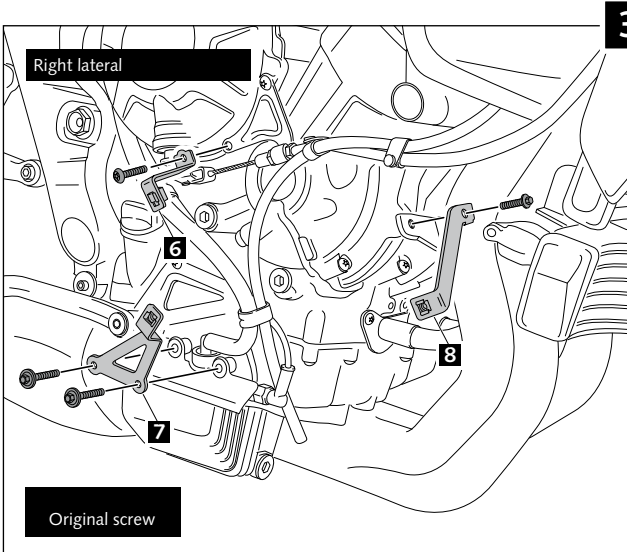

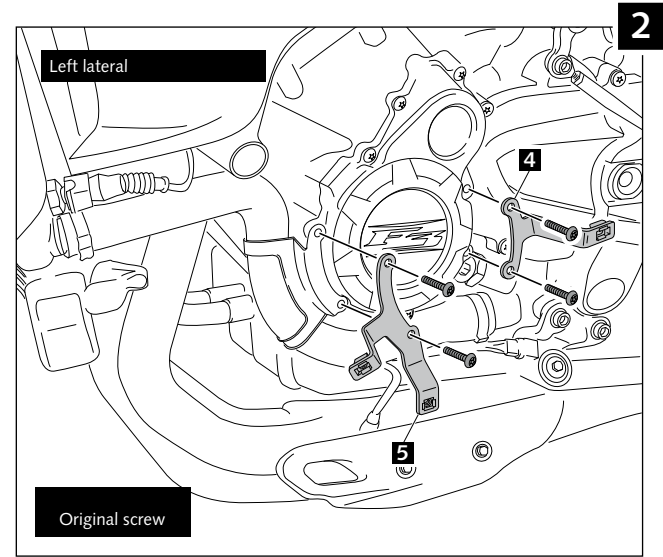

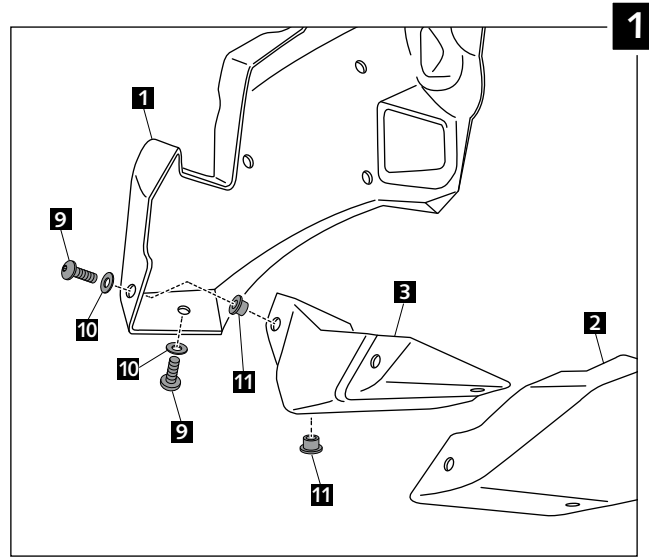
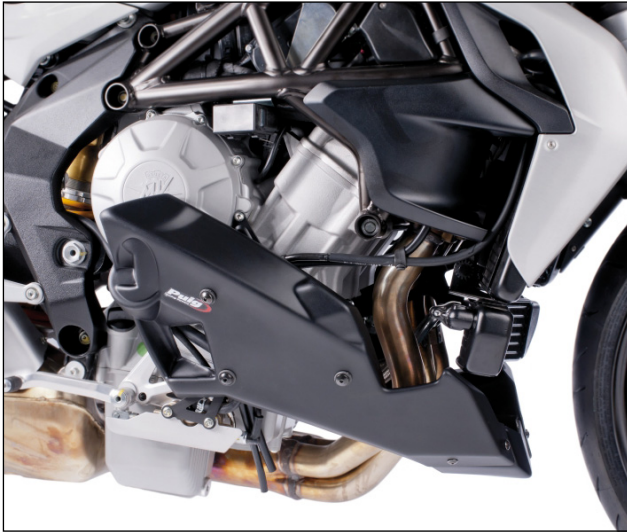





MOUNTING INSTRUCTIONS

ENGINE SPOILER FOR
MV AGUSTA BRUTALE 675/800

Ref.: 6046J
 black colour
 Ref.: 6046C
 carbón look



ENGINE SPOILER FOR
MV AGUSTA BRUTALE 675/800

ID.		DESCRIPTION	QTY.
1		Right engine spoiler	1
2		Left engine spoiler	1
3		Central engine spoiler	1
4		Rear left metal support with M6 caged nut	1
5		Front left metal support with M6 caged nut	1
6		Upper right metal support with M6 caged nut	1
7		Lower right metal support with M6 caged nut	1
8		Front right metal support with M6 caged nut	1
9		M5x16 ISO 7380 Allen screw	4
10		M5x0,5 Nylon washer	4
11		M5 Silemblock	4
12		M6x20 ISO 7380 Allen screw	6
13		Bush with flange	6
14		Silemblock	6