

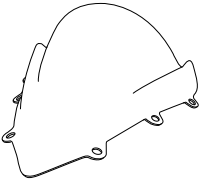

Ref.: 5994

## MOUNTING INSTRUCTIONS

### SCREEN FOR HONDA CBR1000RR '12-'15

ID.	PART	DESCRIPTION	QTY.
1		Screen	1
2		Plate	1
3		Adhesive strip	2

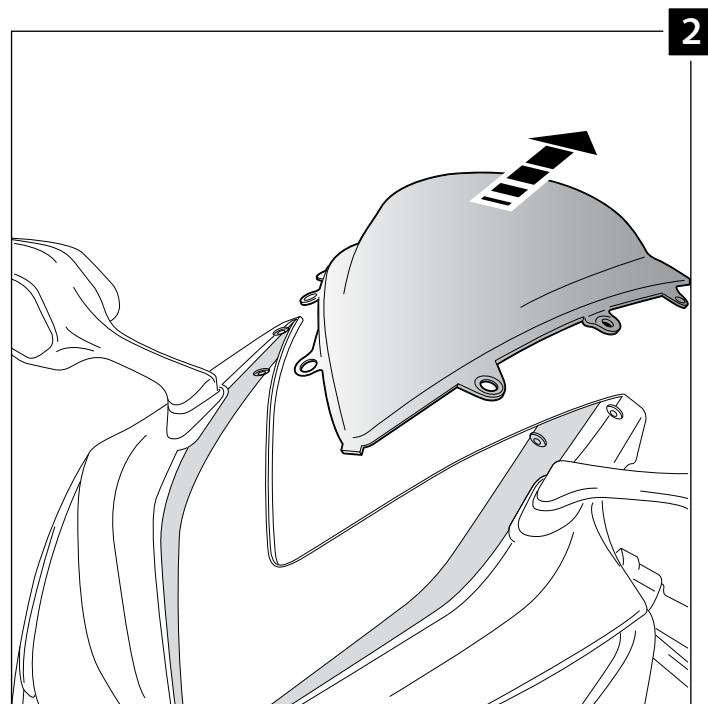
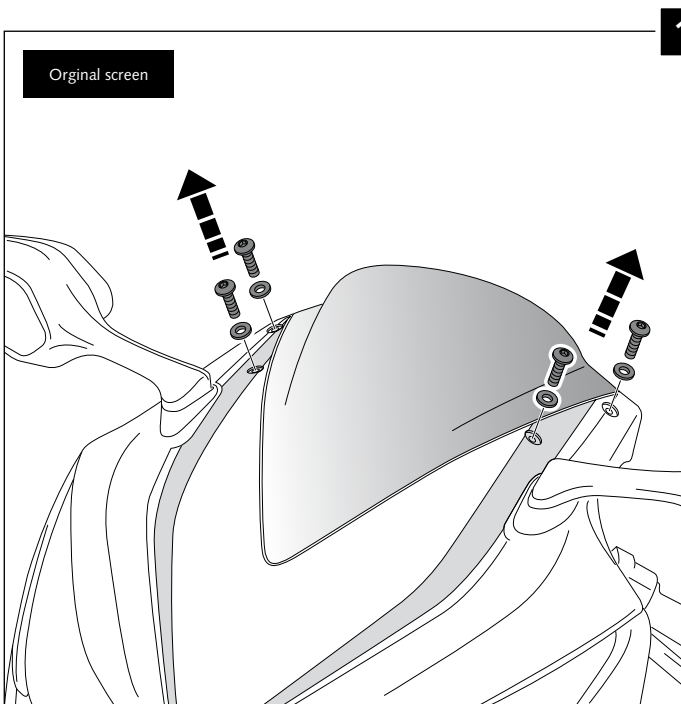

Ref.: 5994

## MOUNTING INSTRUCTIONS

### SCREEN FOR HONDA CBR1000RR '12-'15

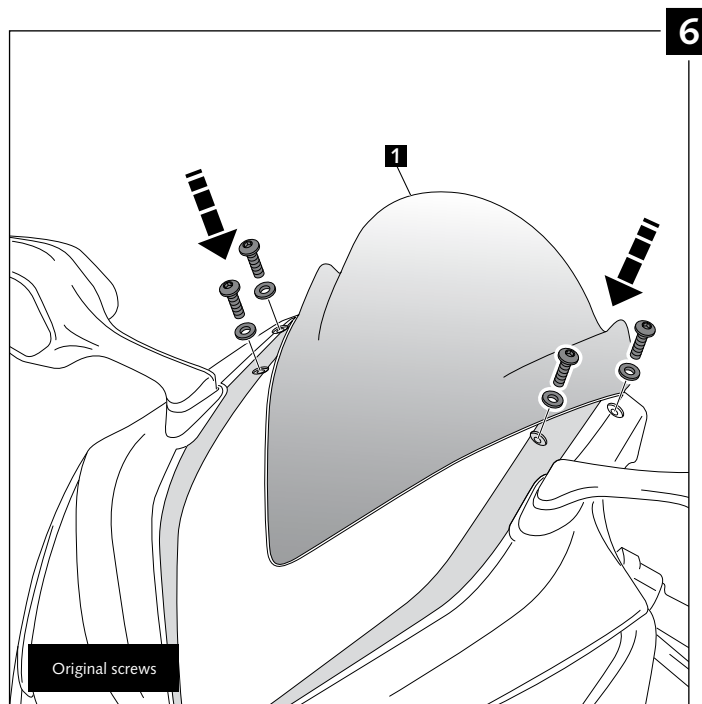
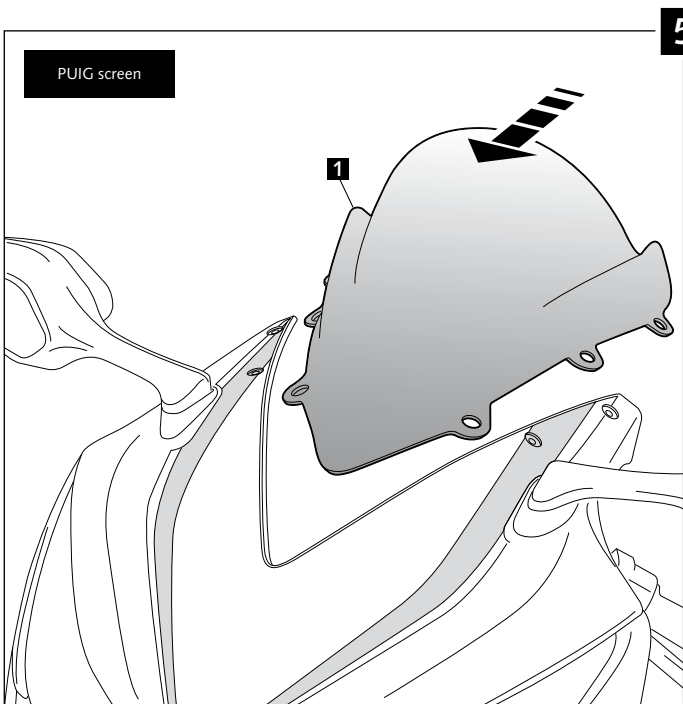
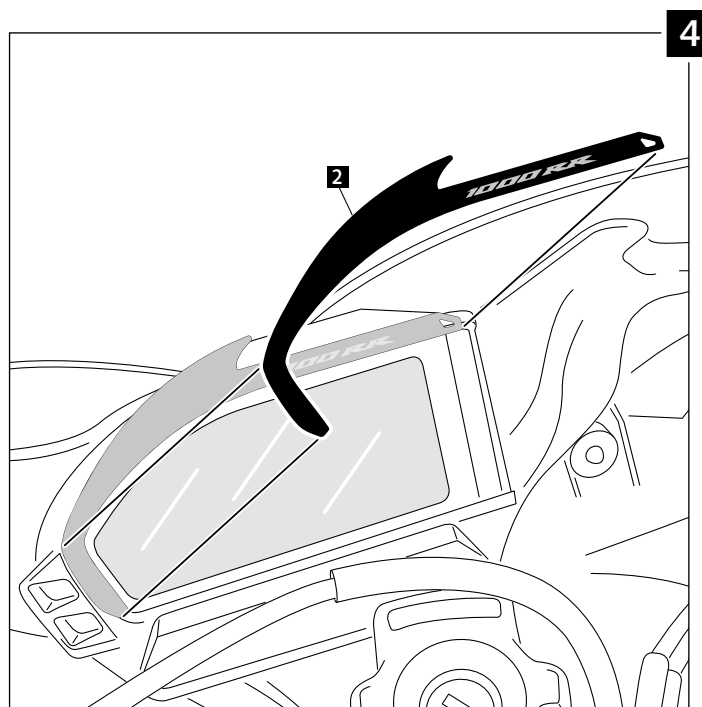
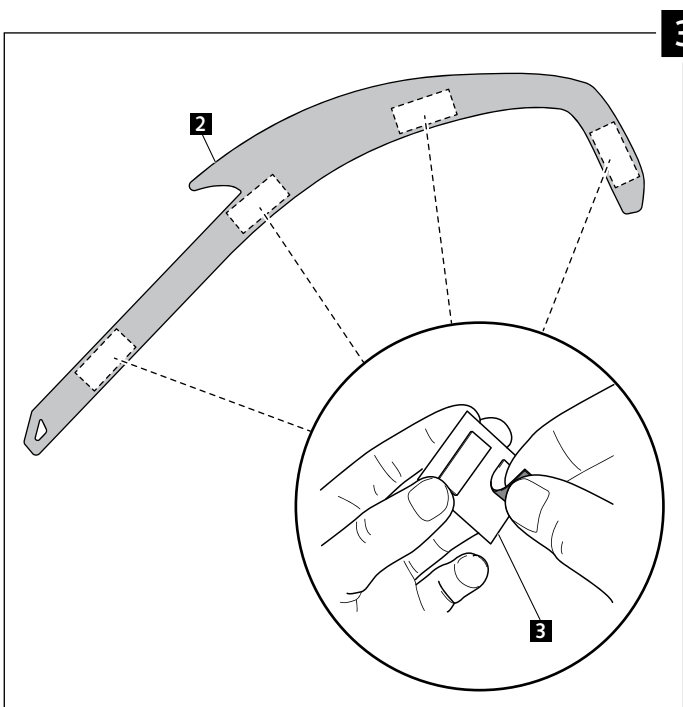

## TIPS FOR A CORRECT WINDSCREEN ASSEMBLY

Due to storage and transport processes of the windscreens, which are subjected to positions and temperature changes out of our control, this may produce small deformations on the material causing some difficulties on the mounting process. It is recommended to:

- 1- Place the screws on one side without tighten all the way.
- 2- Stretch the windscreen to the other side (see Fig. 1). The flexibility of the material allows this stretch with no risk of breaking or cracking.
- 3- Place the screws without tightening all the way.
- 4- Tighten progressively all the screws.

