

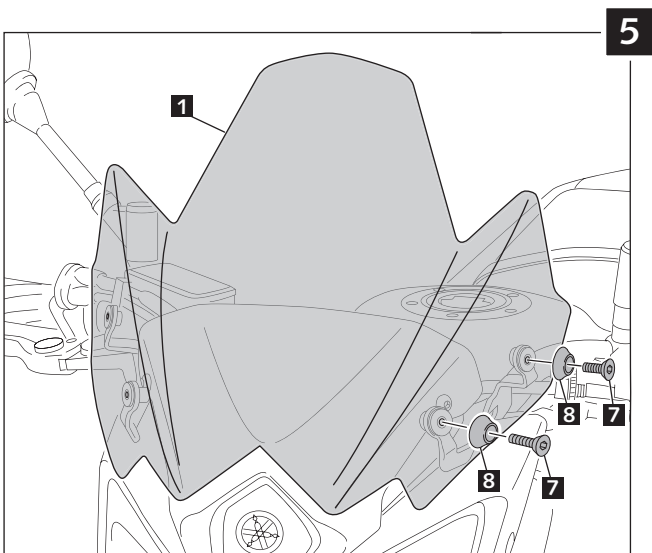

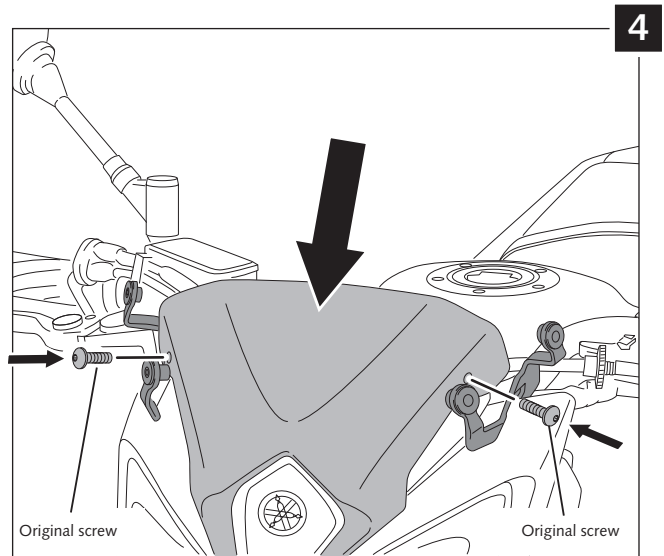

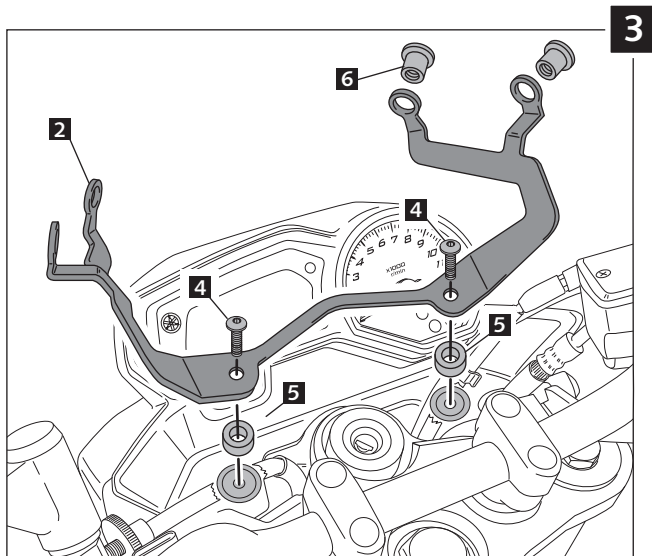

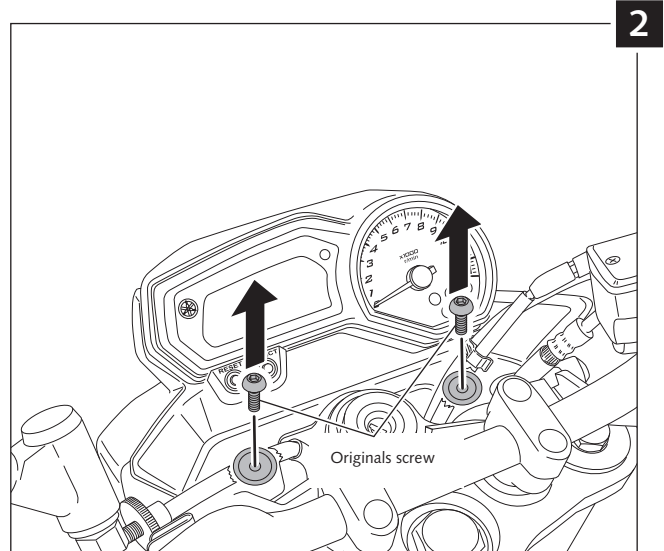
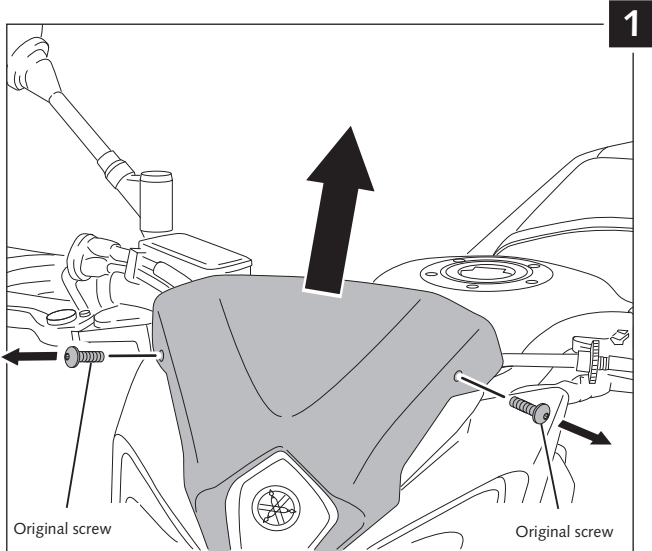

## MOUNTING INSTRUCTIONS

WINDSHIELD ADAPTABLE TO  
YAMAHA FZ8 10'-

Ref.: 5872



ID.	DESCRIPTION	QTY.
1	 Screen	1
2	 Support	1
4	 M6x25 ISO 7380 Allen screw	2
5	 Arrowhead Ø outer 14 x Ø inner 8,5 x 6	2
6	 M6 well nut (supplied already mounted on the piece nº2)	4
7	 M6x20 ISO 7991 allen screw	4
8	 Ø20 plastic washer	4

## TIPS FOR A CORRECT WINDSCREEN ASSEMBLY

Due to storage and transport processes of the windscreens, which are subjected to positions and temperature changes out of our control, this may produce small deformations on the material causing some difficulties on the mounting process. It is recommended to:

- 1- Place the screws on one side without tighten all the way.
- 2- Stretch the windscreen to the other side (see Fig. 1). The flexibility of the material allows this stretch with no risk of breaking or cracking.
- 3- Place the screws without tightening all the way.
- 4- Tighten progressively all the screws.

