

# BRAKE LEVER

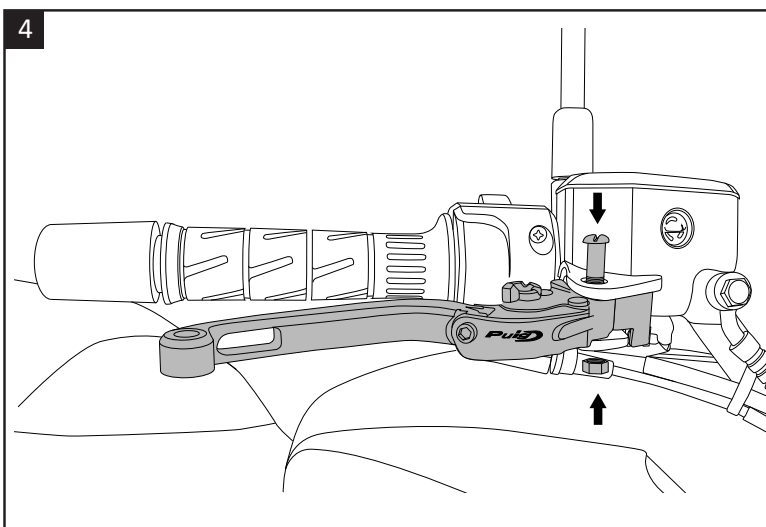
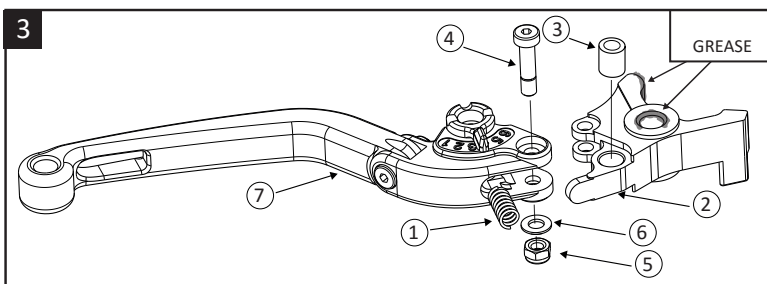
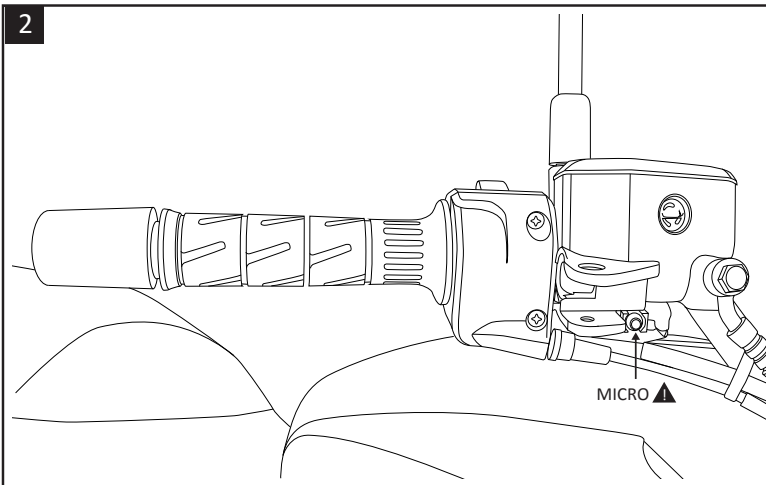
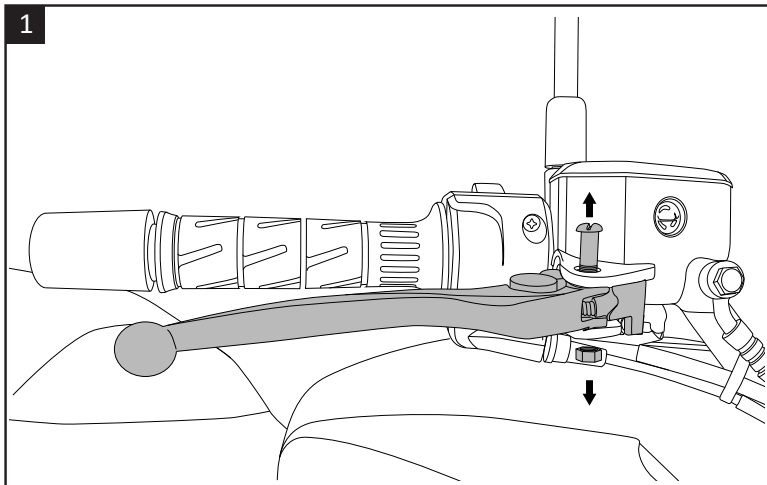

This product should only be installed by a skilled motorcycle mechanic. If you are not qualified to do the job, we strongly recommend having it done by a specialist motorcycle workshop.

**Picture 1:** First unscrew and remove the bearing pin. It may be held by a thread in the lever assembly in addition to the counternut. When you remove the lever, check whether it is fitted with a thin spacer. If so, do not lose it, as it may need to be re-fitted.

**Picture 2:** When installing the brake lever, please make sure that the pressure pin of the microswitch is not trapped, as it may be damaged, and the brake lever may jam.

**Picture 3:** If a bush (3) from the original lever has to be re-used, it needs to be cleaned. Grease the bush and screw (4) lightly, and likewise the cam of the new lever and the contact points with the assembly on the top and bottom surfaces of the lever.

**Picture 4:** Screw the new lever tight without using excessive force or jamming, then check that the brake and brake light switch operate properly and the wheel can rotate freely. To do these checks, you need to raise the front wheel, e.g. with a paddock stand. If the wheel is braked, it may jam. Thank you for your attention.

Nº	PIECE	QTY
1	Spring lever	1
2	Adapter	1
3	Fric ion bush	1
4	Screw M5	1
5	Nut M5	1
6	Washer M5	1
7	Lever	1

# CLUTCH LEVER

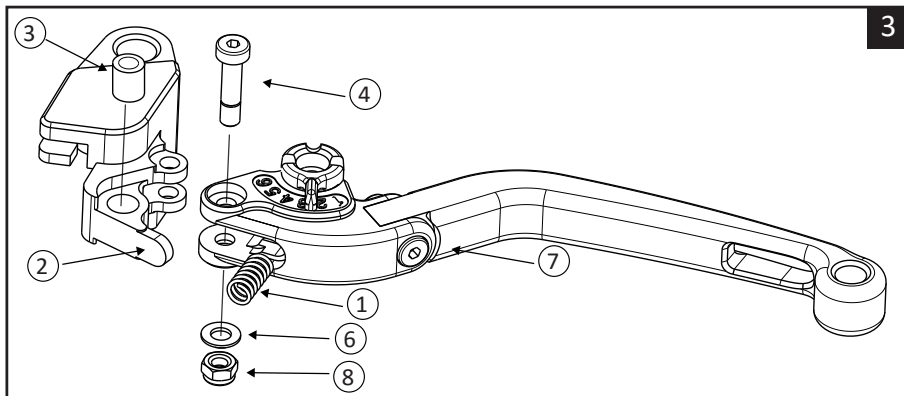

Nº	PIECE	QTY
1	Spring lever	1
2	Adapter	1
3	Fric ion bush	1
4	Screw M5	1
5	Nut M5	1
6	Washer M5	1
7	Lever	1

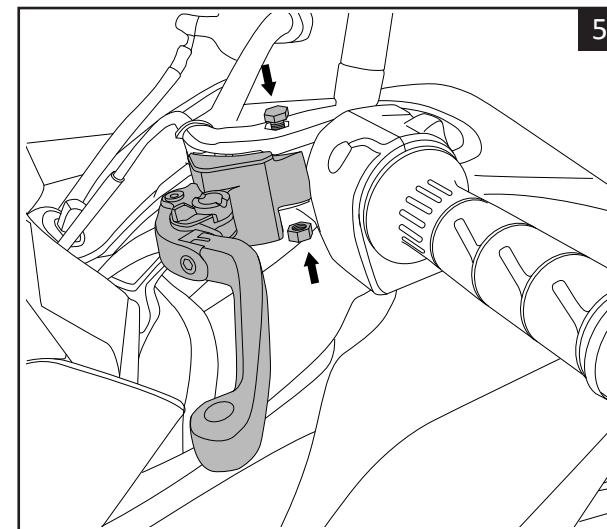
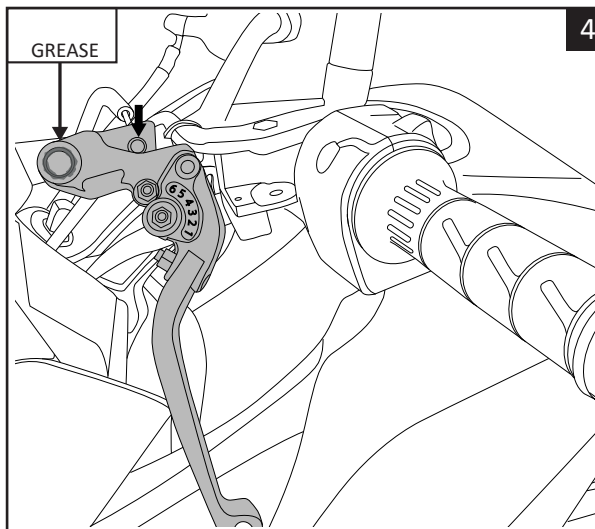
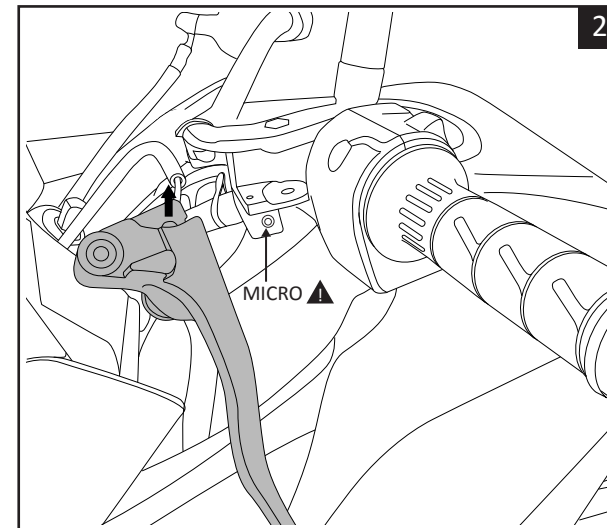
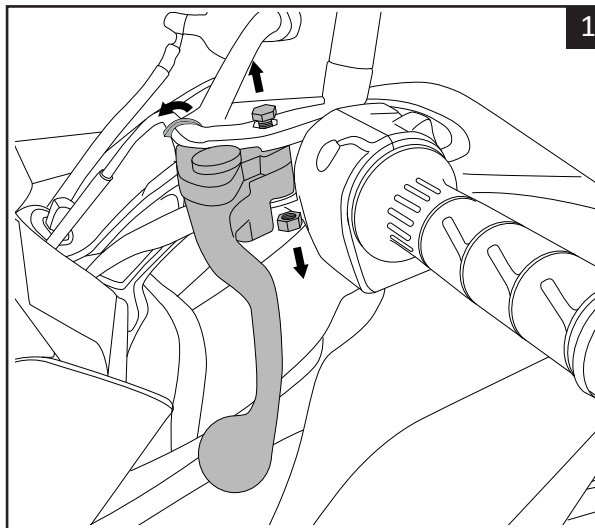

This product should only be installed by a skilled motorcycle mechanic. If you are not qualified to do the job, we strongly recommend having it done by a specialist.

**Picture 1:** First unscrew and remove the bearing pin (4). It may be held by a thread in the lever assembly in addition to the counternut (8). When you remove the lever, check whether it is fitted with a thin spacer. If so, do not lose it, as it may need to be re-fitted.

**Picture 2:** When installing the clutch lever, please make sure that the pressure pin of the microswitch is not trapped, as it may be damaged, and the lever may jam.

**Picture 4:** If a bush (3) from the original lever has to be re-used, it needs to be cleaned. Grease the bush and screw (4) lightly, and likewise the cam of the new lever and the contact points with the assembly on the top and bottom surfaces of the lever.

**Picture 5:** Screw the new lever tight without using excessive force or jamming, then check that the clutch and microswitch operate properly. Thank you for your attention.

