

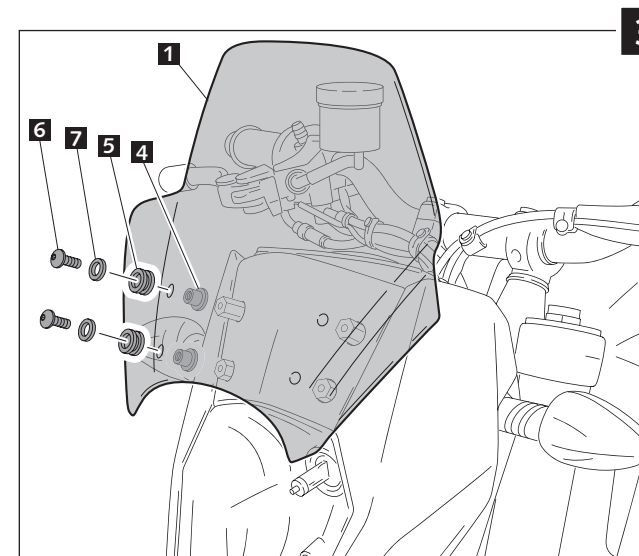

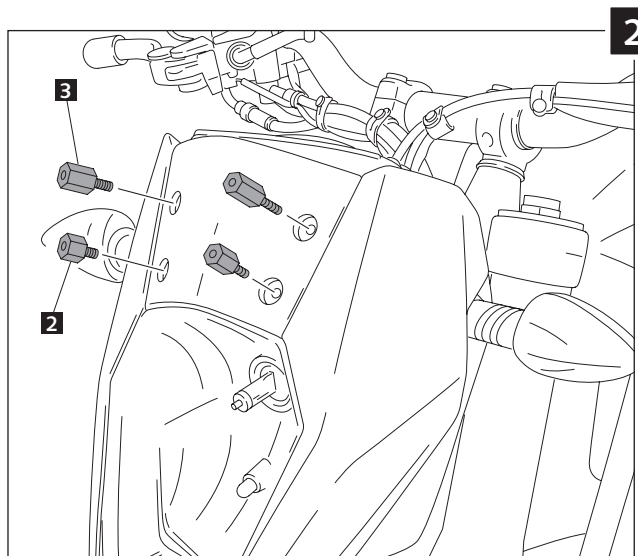

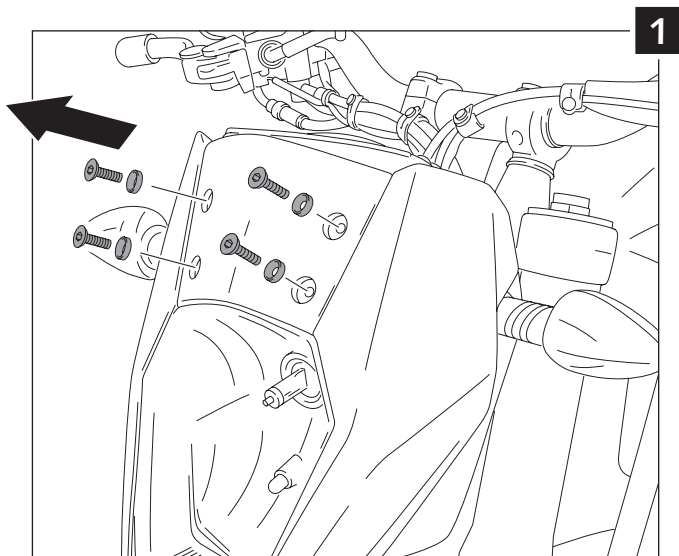



MOUNTING INSTRUCTIONS

WINDSHIELD ADAPTABLE TO
 KTM 990 SUPERMOTO 08'-13'/R 09'-13'

Ref.: 5173



ID.		DESCRIPTION	QTY.
1		Screen	1
2		Special screw M5x13 + interior thread M5x8	2
3		Special screw M5x15 + interior thread M5x10	2
4		Bush with flange (supplied fitted to Part No.1)	1
5		Well nut (supplied fitted to Part No.1)	4
6		M5x16 ISO 7380 allen screw	4
7		Ø inner 5,25xØ outer 15x1,5 metal washer	4