

WINDSHIELD ADAPTABLE A

BMW F800 R '09 - '11

Ref.: 5051

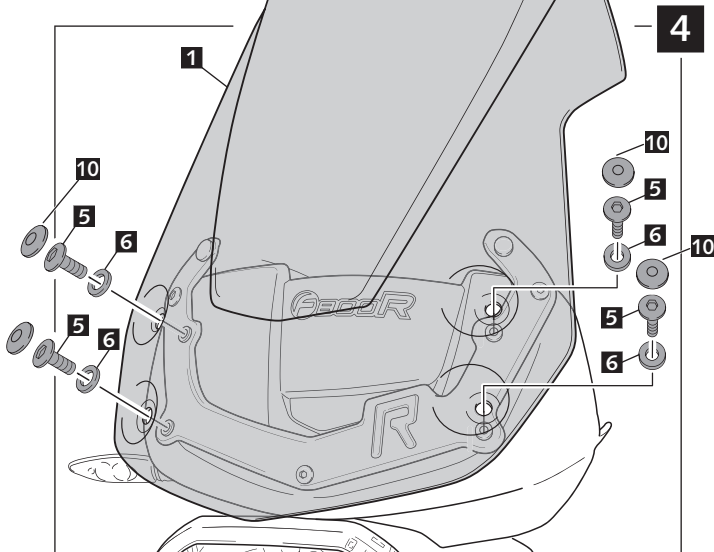

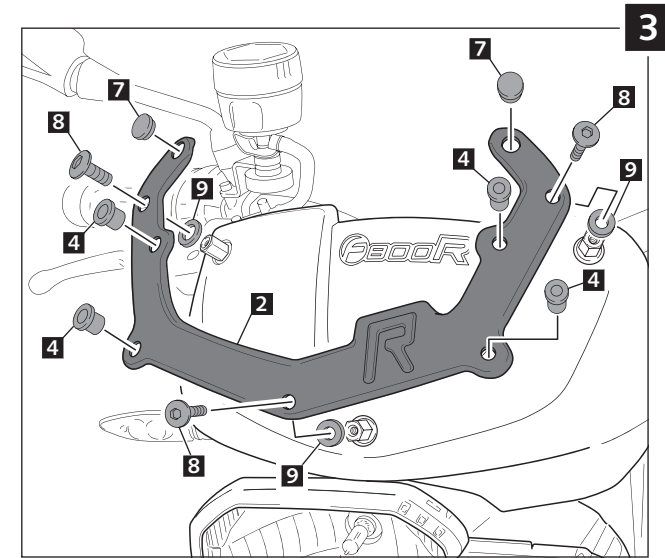
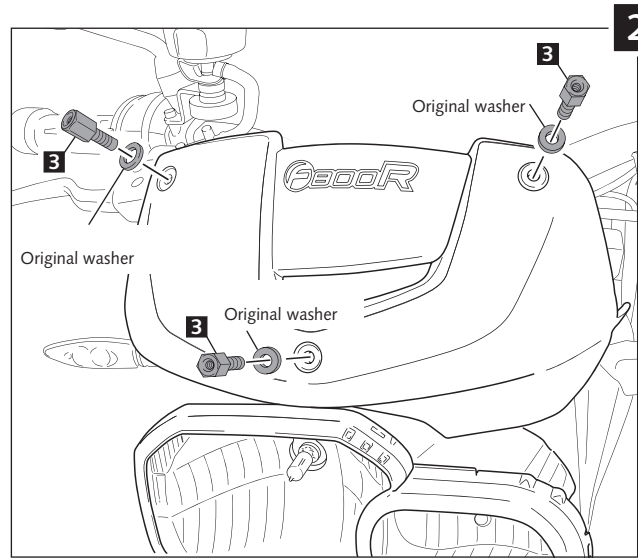
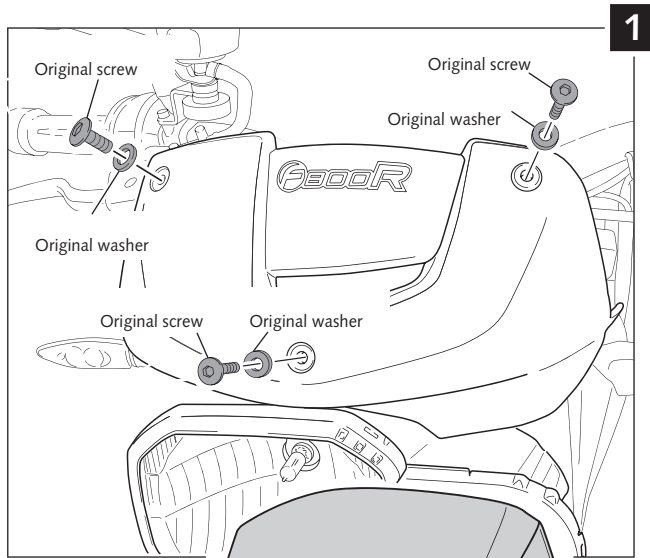

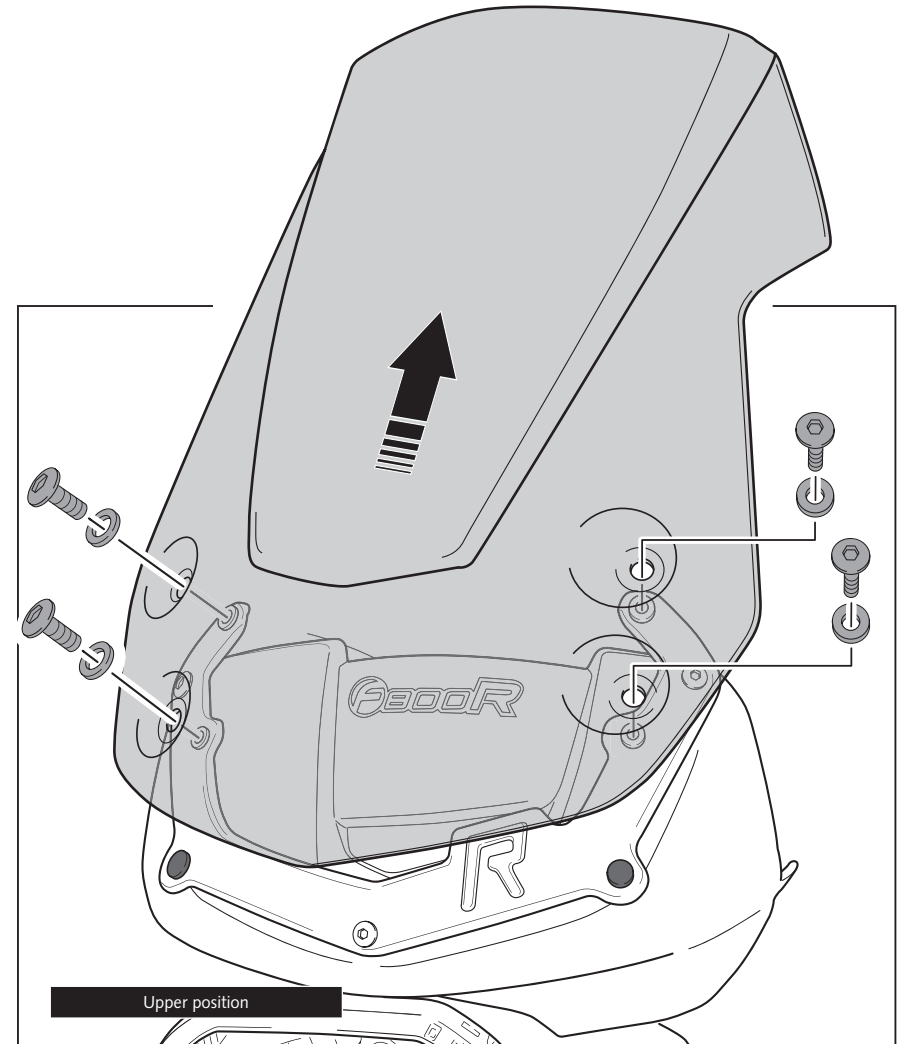
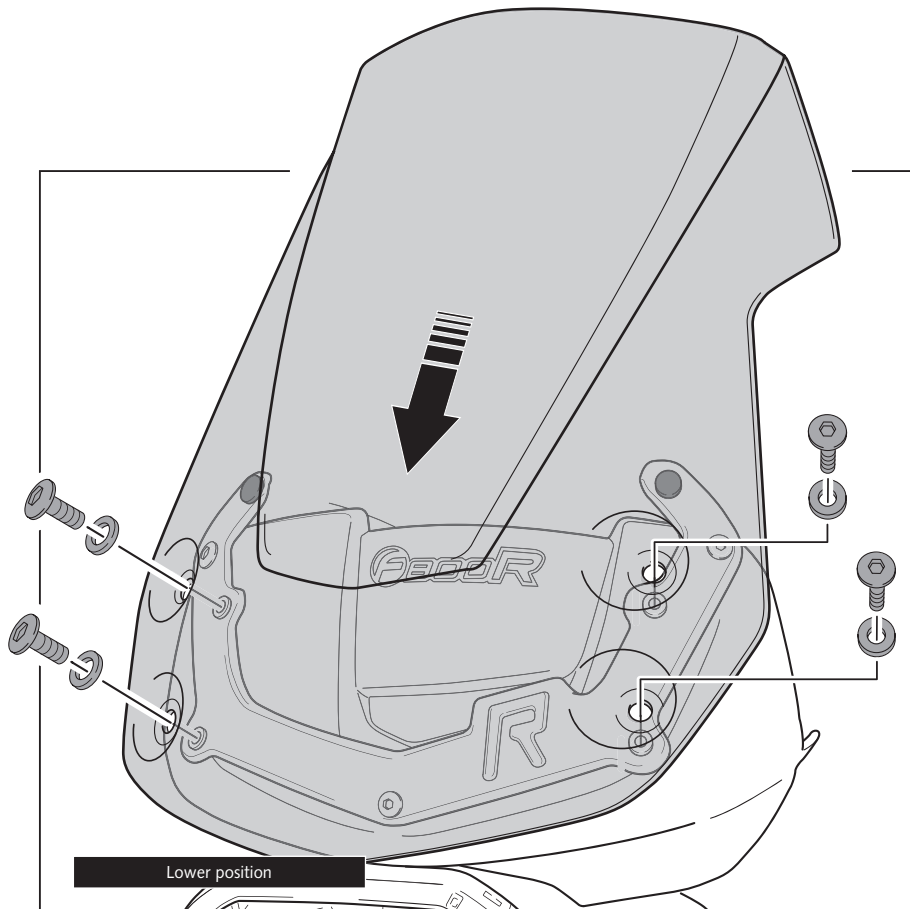





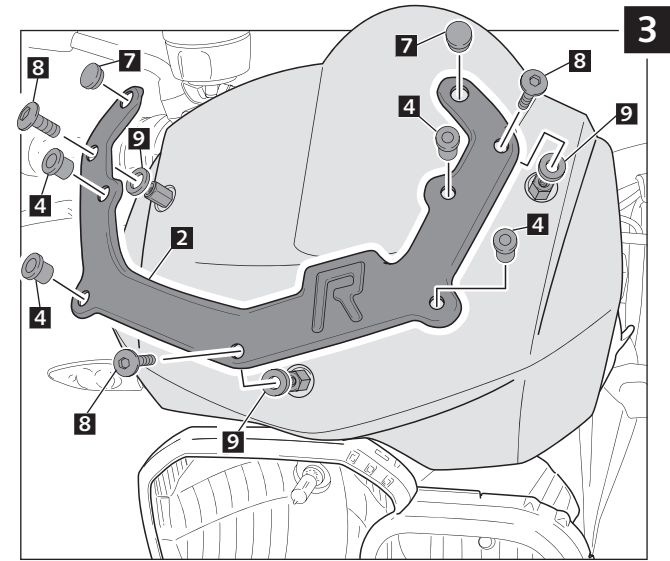
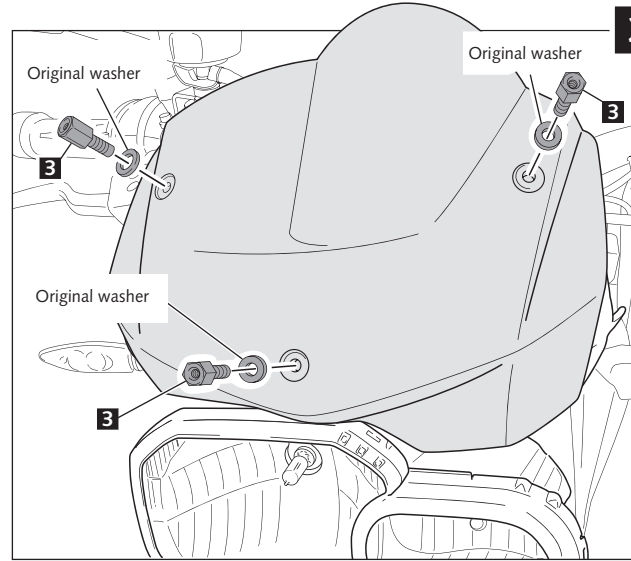
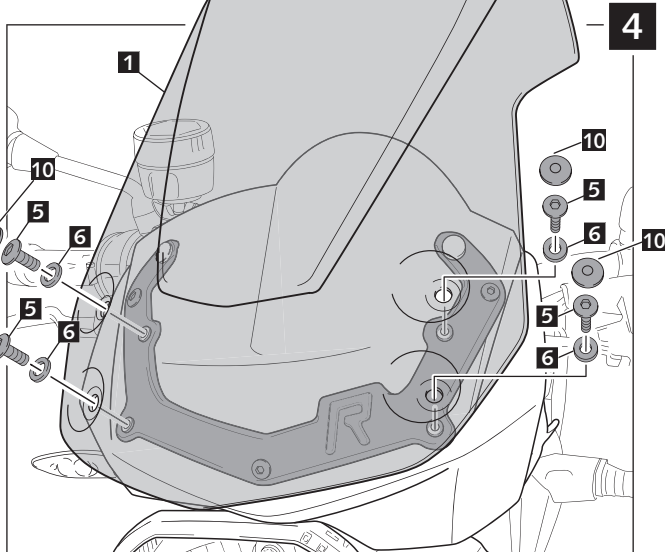
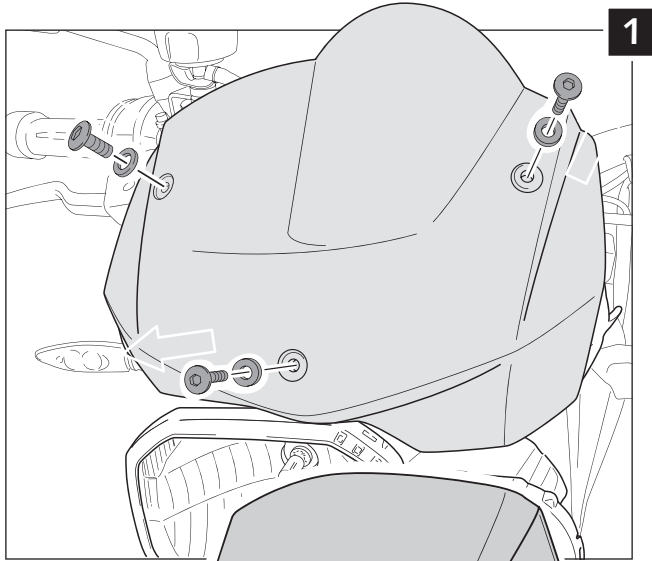

ID.	DESCRIPTION	QTY.
1	Screen	1
2	Metal support	1
3	Special screw M5x17 + interior thread M5x10	3
4	M5 silemblock nut	4
5	M5x16 ISO 7380 allen screw	4
6	Ø5xØ11x1 nylon washer	4
7	Ø10 Plastic plug	2
8	M5x10 ISO 7380 allen screw	3
9	Øouter 13 x Øinner 5x4 washer	3
10	M5 ISO 7380 screw cap	4



WINDSHIELD ADAPTABLE A BMW F800 R 12'-14'

Ref.: 5051



ID.	DESCRIPTION	QTY.
1	 Screen	1
2	 Metal support	1
3	 Special screw M5x17 + interior thread M5x10	3
4	 M5 silenblock nut	4
5	 M5x16 ISO 7380 allen screw	4
6	 Ø5xØ11x1 nylon washer	4
7	 Ø10 Plastic plug	2
8	 M5x10 ISO 7380 allen screw	3
9	 Øouter 13 x Øinner 5x4 washer	3
10	 M5 ISO 7380 screw cap	4

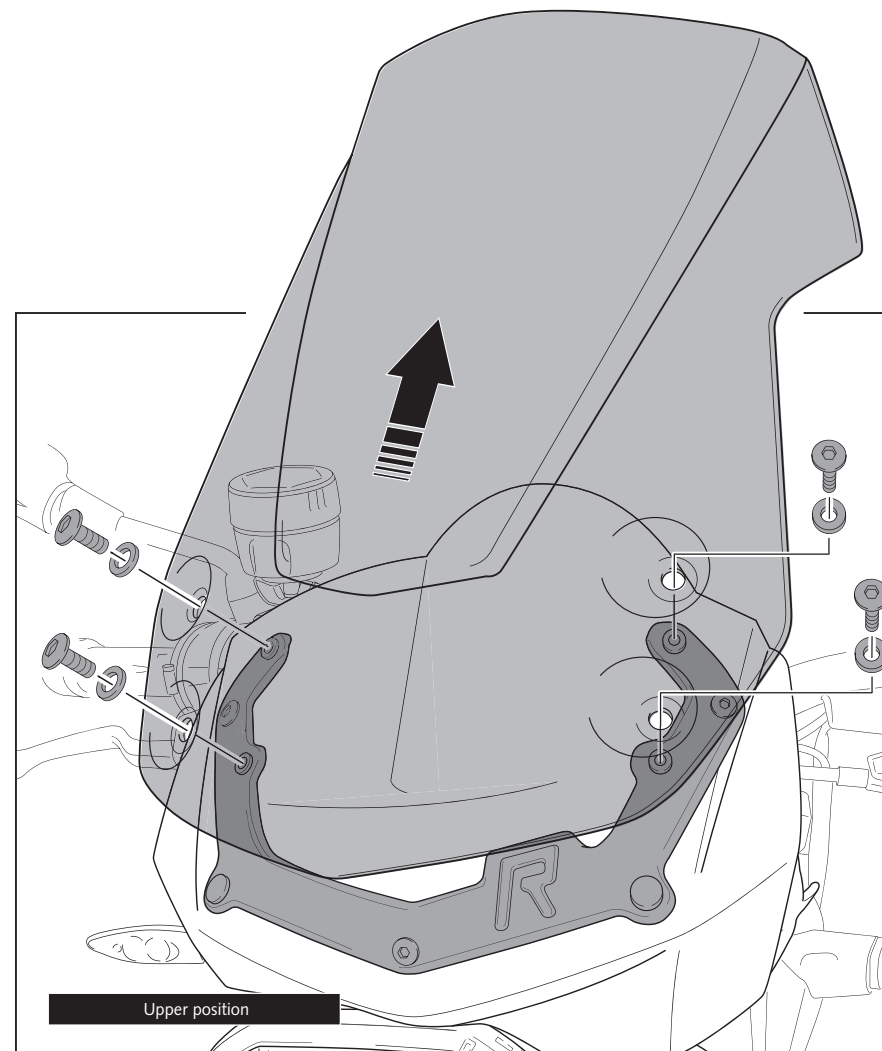
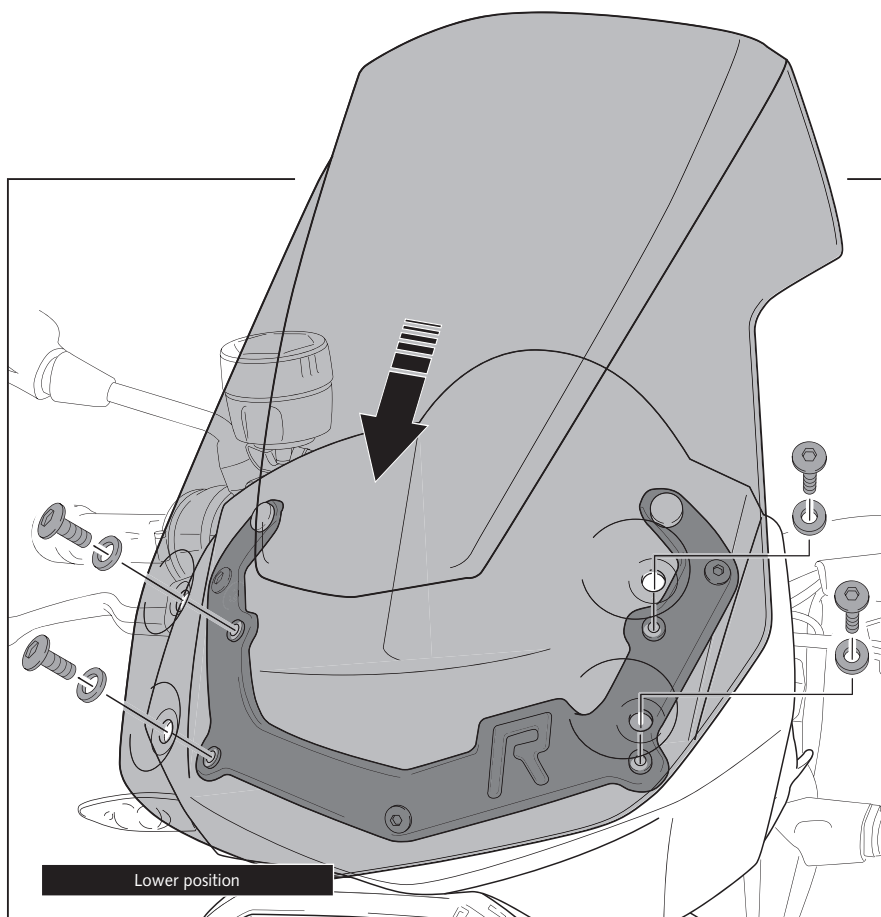

TIPS FOR A CORRECT WINDSCREEN ASSEMBLY

Due to storage and transport processes of the windscreens, which are subjected to positions and temperature changes out of our control, this may produce small deformations on the material causing some difficulties on the mounting process. It is recommended to:

- 1- Place the screws on one side without tighten all the way.
- 2- Stretch the windscreen to the other side (see Fig. 1). The flexibility of the material allows this stretch with no risk of breaking or cracking.
- 3- Place the screws without tightening all the way.
- 4- Tighten progressively all the screws.

